FCC Test Report

Report No.: AGC03889190601FE03

FCC ID : W8D-BT03A
APPLICATION PURPOSE : Original Equipment
PRODUCT DESIGNATION : Bluetooth receiver
BRAND NAME : N/A
MODEL NAME : BT03A
APPLICANT : Shenzhen Onuoda Electronics Technology Co.Ltd
DATE OF ISSUE : June 26, 2019
STANDARD(S) : FCC Part 15.247
REPORT VERSION : V1.0

Attestation of Global Compliance (Shenzhen) Co., Ltd

CAUTION:

This report shall not be reproduced except in full without the written permission of the test laboratory and shall not be quoted out of context.

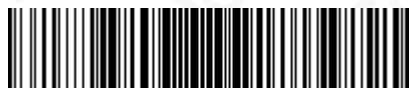

Attestation of Global Compliance(Shenzhen)Co.,Ltd.

Add: 2/F., Building 2, No.1-4, Chaxi Sanwei Technial Industrial Park, Gushu,
Xixiang, Bao'an District, Shenzhen, Guangdong, China

Tel: +86-755 2523 4088

E-mail: agc@agc-cert.com

Service Hotline:400 089 2118

REPORT REVISE RECORD

Report Version	Revise Time	Issued Date	Valid Version	Notes
V1.0	/	June 26, 2019	Valid	Initial Release



Attestation of Global Compliance(Shenzhen)Co.,Ltd.

Add: 2/F., Building 2, No.1-4, Chaxi Sanwei Technial Industrial Park, Gushu,
Xixiang, Bao'an District, Shenzhen, Guangdong, China

Tel: +86-755 2523 4088

E-mail: agc@agc-cert.com

Service Hotline:400 089 2118

TABLE OF CONTENTS

1. VERIFICATION OF CONFORMITY 6

2. GENERAL INFORMATION 7

2.1. PRODUCT DESCRIPTION..... 7

2.2. TABLE OF CARRIER FREQUENCIES 7

2.3. RECEIVER INPUT BANDWIDTH 8

2.4. EXAMPLE OF A HOPPING SEQUENCY IN DATA MODE 8

2.5. EQUALLY AVERAGE USE OF FREQUENCIES AND BEHAVIOUR 8

2.6. RELATED SUBMITTAL(S) / GRANT (S) 9

2.7. TEST METHODOLOGY 9

2.8. SPECIAL ACCESSORIES 9

2.9. EQUIPMENT MODIFICATIONS 9

3. MEASUREMENT UNCERTAINTY 10

4. DESCRIPTION OF TEST MODES..... 11

5. SYSTEM TEST CONFIGURATION 12

5.1. CONFIGURATION OF EUT SYSTEM..... 12

5.2 EQUIPMENT USED IN TESTED SYSTEM..... 12

5.3. SUMMARY OF TEST RESULTS..... 12

6. TEST FACILITY 13

7. PEAK OUTPUT POWER 15

7.1. MEASUREMENT PROCEDURE 15

7.2. TEST SET-UP (BLOCK DIAGRAM OF CONFIGURATION)..... 15

7.3. LIMITS AND MEASUREMENT RESULT 16

8. 20DB BANDWIDTH 20

8.1. MEASUREMENT PROCEDURE 20

8.2. TEST SET-UP (BLOCK DIAGRAM OF CONFIGURATION)..... 20

8.3. LIMITS AND MEASUREMENT RESULTS 20

9. CONDUCTED SPURIOUS EMISSION 25

9.1. MEASUREMENT PROCEDURE 25



Attestation of Global Compliance(Shenzhen)Co.,Ltd.

Add: 2/F., Building 2, No.1-4, Chaxi Sanwei Technial Industrial Park, Gushu,
Xixiang, Bao'an District, Shenzhen, Guangdong, China

Tel: +86-755 2523 4088 E-mail: agc@agc-cert.com Service Hotline:400 089 2118

9.2. TEST SET-UP (BLOCK DIAGRAM OF CONFIGURATION).....	25
9.3. MEASUREMENT EQUIPMENT USED	25
9.4. LIMITS AND MEASUREMENT RESULT	25
10. RADIATED EMISSION.....	33
10.1. MEASUREMENT PROCEDURE	33
10.2. TEST SETUP.....	35
10.3. LIMITS AND MEASUREMENT RESULT.....	36
10.4. TEST RESULT.....	36
11. NUMBER OF HOPPING FREQUENCY.....	47
11.1. MEASUREMENT PROCEDURE	47
11.2. TEST SETUP (BLOCK DIAGRAM OF CONFIGURATION).....	47
11.3. MEASUREMENT EQUIPMENT USED	47
11.4. LIMITS AND MEASUREMENT RESULT	47
12. TIME OF OCCUPANCY (DWELL TIME)	48
12.1. MEASUREMENT PROCEDURE	48
12.2. TEST SETUP (BLOCK DIAGRAM OF CONFIGURATION).....	48
12.3. MEASUREMENT EQUIPMENT USED	48
12.4. LIMITS AND MEASUREMENT RESULT.....	48
13. FREQUENCY SEPARATION.....	52
13.1. MEASUREMENT PROCEDURE	52
13.2. TEST SETUP (BLOCK DIAGRAM OF CONFIGURATION).....	52
13.3. MEASUREMENT EQUIPMENT USED	52
13.4. LIMITS AND MEASUREMENT RESULT.....	52
14. FCC LINE CONDUCTED EMISSION TEST	53
14.1. LIMITS OF LINE CONDUCTED EMISSION TEST.....	53
14.2. BLOCK DIAGRAM OF LINE CONDUCTED EMISSION TEST	53
14.3. PRELIMINARY PROCEDURE OF LINE CONDUCTED EMISSION TEST	54
14.4. FINAL PROCEDURE OF LINE CONDUCTED EMISSION TEST	54
14.5. TEST RESULT OF LINE CONDUCTED EMISSION TEST	55



APPENDIX A: PHOTOGRAPHS OF TEST SETUP 57
APPENDIX B: PHOTOGRAPHS OF EUT 59



Attestation of Global Compliance(Shenzhen)Co.,Ltd.

Add: 2/F., Building 2, No.1-4, Chaxi Sanwei Technial Industrial Park, Gushu,
Xixiang, Bao'an District, Shenzhen, Guangdong, China

Tel: +86-755 2523 4088

E-mail: agc@agc-cert.com

Service Hotline:400 089 2118

1. VERIFICATION OF CONFORMITY

Applicant	Shenzhen Onuoda Electronics Technology Co.Ltd
Address	3F D building Jingfu industry zone Airway(West) Gushu village Xixiang town Bao'an district Shenzhen city Guangdong,China
Manufacturer	Shenzhen Onuoda Electronics Technology Co.Ltd
Address	3F D building Jingfu industry zone Airway(West) Gushu village Xixiang town Bao'an district Shenzhen city Guangdong,China
Factory	Shenzhen Onuoda Electronics Technology Co.Ltd
Address	3F D building Jingfu industry zone Airway(West) Gushu village Xixiang town Bao'an district Shenzhen city Guangdong,China
Product Designation	Bluetooth receiver
Brand Name	N/A
Test Model	BT03A
Date of test	June 12, 2019~June 26, 2019
Deviation	None
Condition of Test Sample	Normal
Test Result	Pass
Report Template	AGCRT-US-BR/RF

We hereby certify that:

The above equipment was tested by Attestation of Global Compliance (Shenzhen) Co., Ltd. The test data, data evaluation, test procedures, and equipment configurations shown in this report were made in accordance with the procedures given in ANSI C63.10 (2013) and the energy emitted by the sample EUT tested as described in this report is in compliance with radiated emission limits of FCC PART 15.247.

Tested By



Calvin Liu(Liu junchen)

June 26, 2019

Reviewed By

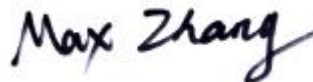

Max Zhang(Zhang Yi)

June 26, 2019

Approved By



Forrest Lei(Lei Yonggang)
Authorized Officer

June 26, 2019



2. GENERAL INFORMATION

2.1. PRODUCT DESCRIPTION

The EUT is designed as “Bluetooth receiver”. It is designed by way of utilizing the GFSK, Pi/4 DQPSK technology to achieve the system operation.

A major technical description of EUT is described as following

Operation Frequency	2.402 GHz to 2.480GHz
RF Output Power	3.482dBm(Max)
Bluetooth Version	V 5.0
Modulation	BR <input checked="" type="checkbox"/> GFSK, EDR <input checked="" type="checkbox"/> π /4-DQPSK, <input type="checkbox"/> 8DPSK BLE <input type="checkbox"/> GFSK 1Mbps <input type="checkbox"/> GFSK 2Mbps
Number of channels	79
Hardware Version	V5
Software Version	V4
Antenna Designation	PCB Antenna(Comply with requirements of the FCC part 15.203)
Antenna Gain	0dBi
Power Supply	DC 3.7V by battery or DC 5V by PC.

2.2. TABLE OF CARRIER FREQUENCIES

Frequency Band	Channel Number	Frequency
2402~2480MHZ	0	2402MHZ
	1	2403MHZ
	:	:
	38	2440 MHZ
	39	2441 MHZ
	40	2442 MHZ
	:	:
	77	2479 MHZ
	78	2480 MHZ



Attestation of Global Compliance(Shenzhen)Co.,Ltd.

Add: 2/F., Building 2, No.1-4, Chaxi Sanwei Technial Industrial Park, Gushu,
Xixiang, Bao'an District, Shenzhen, Guangdong, China

Tel: +86-755 2523 4088

E-mail: agc@agc-cert.com

Service Hotline:400 089 2118

2.3. RECEIVER INPUT BANDWIDTH

The input bandwidth of the receiver is 1.3MHz. In every connection one Bluetooth device is the master and the other one is slave. The master determines the hopping sequence. The slave follows this sequence. Both devices shift between RX and TX time slot according to the clock of the master. Additionally the type of connection (e.g. single or multislotted packet) is set up at the beginning of the connection. The master adapts its hopping frequency and its TX/RX timing according to the packet type of the connection. Also the slave of the connection will use these settings.

Repeating of a packet has no influence on the hopping sequence. The hopping sequence generated by the master of the connection will be followed in any case. That means, a repeated packet will not be sent on the same frequency, it is sent on the next frequency of the hopping sequence.

2.4. EXAMPLE OF A HOPPING SEQUENCE IN DATA MODE

Example of a 79 hopping sequence in data mode:

40,21,44,23,42,53,46,55,48,33,52,35,50,65,54,67
56,37,60,39,58,69,62,71,64,25,68,27,66,57,70,59
72,29,76,31,74,61,78,63,01,41,05,43,03,73,07,75
09,45,13,47,11,77,15,00,64,49,66,53,68,02,70,06
01, 51, 03, 55, 05, 04

2.5. EQUALLY AVERAGE USE OF FREQUENCIES AND BEHAVIOUR

The generation of the hopping sequence in connection mode depends essentially on two input values:

1. LAP/UAP of the master of the connection.
2. Internal master clock

The LAP (lower address part) are the 24 LSB's of the 48 BD_ADDRESS. The BD_ADDRESS is an unambiguous number of every Bluetooth unit. The UAP (upper address part) are the 24 MSB's of the 48BD_ADDRESS

The internal clock of a Bluetooth unit is derived from a free running clock which is never adjusted and is never turned off. For synchronization with other units only offsets are used. It has no relation to the time of the day. Its resolution is at least half the RX/TX slot length of 312.5µs. The clock has a cycle of about one day (23h30). In most cases it is implemented as a 28-bit counter. For the deriving of the hopping sequence the entire LAP (24 bits), 4 LSB's (4 bits) (Input 1) and the 27 MSB's of the clock (Input 2) are used. With these input values different mathematical procedures (permutations, additions, XOR-operations) are performed to generate the sequence. This will be done at the beginning of every new transmission.

Regarding short transmissions the Bluetooth system has the following behavior:

The first connection between the two devices is established, a hopping sequence was generated. For transmitting the wanted data the complete hopping sequence was not used. The connection ended.

The second connection will be established. A new hopping sequence is generated. Due to the fact the Bluetooth clock has a different value, because the period between the two transmissions is longer (and it cannot be shorter) than the minimum resolution of the clock (312.5µs). The hopping sequence will always differ from the first one.



2.6. RELATED SUBMITTAL(S) / GRANT (S)

This submittal(s) (test report) is intended for **FCC ID: W8D-BT03A** filing to comply with the FCC PART 15.247 requirements.

2.7. TEST METHODOLOGY

Both conducted and radiated testing was performed according to the procedures in ANSI C63.10 (2013). Radiated testing was performed at an antenna to EUT distance 3 meters.

2.8. SPECIAL ACCESSORIES

Refer to section 5.2.

2.9. EQUIPMENT MODIFICATIONS

Not available for this EUT intended for grant.



Attestation of Global Compliance(Shenzhen)Co.,Ltd.

Add: 2/F., Building 2, No.1-4, Chaxi Sanwei Technial Industrial Park, Gushu,
Xixiang, Bao'an District, Shenzhen, Guangdong, China

Tel: +86-755 2523 4088

E-mail: agc@agc-cert.com

Service Hotline:400 089 2118

3. MEASUREMENT UNCERTAINTY

The reported uncertainty of measurement $y \pm U$, where expanded uncertainty U is based on a standard uncertainty multiplied by a coverage factor of $k=2$, providing a level of confidence of approximately 95%.

- Uncertainty of Conducted Emission, $U_c = \pm 3.2$ dB
- Uncertainty of Radiated Emission below 1GHz, $U_c = \pm 3.9$ dB
- Uncertainty of Radiated Emission above 1GHz, $U_c = \pm 4.8$ dB
- Uncertainty of total RF power, conducted, $U_c = \pm 0.8$ dB
- Uncertainty of spurious emissions, conducted, $U_c = \pm 2.7$ dB
- Uncertainty of Occupied Channel Bandwidth: $U_c = \pm 2$ %
- Uncertainty of Dwell Time: $U_c = \pm 2$ %
- Uncertainty of Frequency: $U_c = \pm 2$ %



Attestation of Global Compliance(Shenzhen)Co.,Ltd.

Add: 2/F., Building 2, No.1-4, Chaxi Sanwei Technial Industrial Park, Gushu,
Xixiang, Bao'an District, Shenzhen, Guangdong, China

Tel: +86-755 2523 4088

E-mail: agc@agc-cert.com

Service Hotline:400 089 2118

4. DESCRIPTION OF TEST MODES

NO.	TEST MODE DESCRIPTION
1	Low channel GFSK
2	Middle channel GFSK
3	High channel GFSK
4	Low channel $\pi/4$ -DQPSK
5	Middle channel $\pi/4$ -DQPSK
6	High channel $\pi/4$ -DQPSK
7	Hopping mode GFSK
8	Hopping mode $\pi/4$ -DQPSK

Note:

1. Only the result of the worst case was recorded in the report, if no other cases.
2. For Radiated Emission, 3axis were chosen for testing for each applicable mode.
3. For Conducted Test method, a temporary antenna connector is provided by the manufacture.
4. EUT connects the computer through the serial port tool (USB TO TTL), and then enters the test mode through the test software SmartLink FCCAssist_1.5.exe



Attestation of Global Compliance(Shenzhen)Co.,Ltd.

Add: 2/F., Building 2, No.1-4, Chaxi Sanwei Technial Industrial Park, Gushu,
Xixiang, Bao'an District, Shenzhen, Guangdong, China

Tel: +86-755 2523 4088 E-mail: agc@agc-cert.com Service Hotline:400 089 2118

5. SYSTEM TEST CONFIGURATION

5.1. CONFIGURATION OF EUT SYSTEM

Radiated Emission Configure :

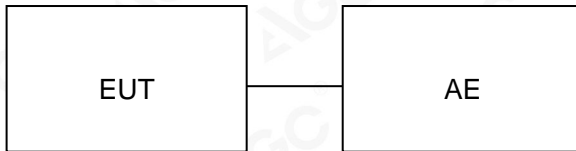

Conducted Emission Configure :

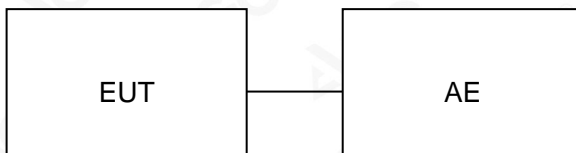

5.2 EQUIPMENT USED IN TESTED SYSTEM

Item	Equipment	Model No.	ID or Specification	Remark
1	Bluetooth receiver	BT03A	W8D-BT03A	EUT
2	Battery	N/A	DC 3.7V 70mAh	AE

5.3. SUMMARY OF TEST RESULTS

FCC RULES	DESCRIPTION OF TEST	RESULT
15.247 (b)(1)	Peak Output Power	Compliant
15.247 (a)(1)	20 dB Bandwidth	Compliant
15.247 (d)	Conducted Spurious Emission	Compliant
15.209	Radiated Emission	Compliant
15.247 (a)(1)(iii)	Number of Hopping Frequency	Compliant
15.247 (a)(1)(iii)	Time of Occupancy	Compliant
15.247 (a)(1)	Frequency Separation	Compliant
15.207	Conducted Emission	Compliant



Attestation of Global Compliance(Shenzhen)Co.,Ltd.

Add: 2/F., Building 2, No.1-4, Chaxi Sanwei Technial Industrial Park, Gushu,
Xixiang, Bao'an District, Shenzhen, Guangdong, China

Tel: +86-755 2523 4088

E-mail: agc@agc-cert.com

Service Hotline:400 089 2118

5.4. SUPPORT EQUIPMENT IN TEST

Device Type	Manufacturer	Model Name	S/N	Data Cable
PC	XiaoMi	161301-01	N/A	N/A
Speaker	HONGCAI	A10	N/A	N/A
USB-TTL	N/A	N/A	N/A	1.5m
Aux Cable	N/A	N/A	N/A	0.3m
USB Cable	N/A	N/A	N/A	0.4m



Attestation of Global Compliance(Shenzhen)Co.,Ltd.

Add: 2/F., Building 2, No.1-4, Chaxi Sanwei Technial Industrial Park, Gushu,
Xixiang, Bao'an District, Shenzhen, Guangdong, China

Tel: +86-755 2523 4088

E-mail: agc@agc-cert.com

Service Hotline:400 089 2118

6. TEST FACILITY

Test Site	Attestation of Global Compliance (Shenzhen) Co., Ltd
Location	1-2/F, Building 19, Junfeng Industrial Park, Chongqing Road, Heping Community, Fuhai Street, Bao'an District, Shenzhen, Guangdong, China
Designation Number	CN1259
FCC Test Firm Registration Number	975832
A2LA Cert. No.	5054.02
Description	Attestation of Global Compliance(Shenzhen) Co., Ltd is accredited by A2LA

TEST EQUIPMENT OF CONDUCTED EMISSION TEST

Equipment	Manufacturer	Model	S/N	Cal. Date	Cal. Due
TEST RECEIVER	R&S	ESPI	101206	Jun. 10, 2019	Jun. 09, 2020
LISN	R&S	ESH2-Z5	100086	Aug. 28, 2018	Aug. 27, 2019

TEST EQUIPMENT OF RADIATED EMISSION TEST

Equipment	Manufacturer	Model	S/N	Cal. Date	Cal. Due
TEST RECEIVER	R&S	ESCI	10096	Jun. 10, 2019	Jun. 09, 2020
EXA Signal Analyzer	Aglient	N9010A	MY53470504	Dec. 20, 2018	Dec. 19, 2019
2.4GHz Fliter	EM Electronics	2400-2500MHz	N/A	Feb. 27, 2019	Feb. 26, 2020
Attenuator	ZHINAN	E-002	N/A	Aug. 28, 2018	Aug. 27, 2019
Horn antenna	SCHWARZBECK	BBHA 9170	#768	Sep. 21, 2017	Sep. 20, 2020
Active loop antenna (9K-30MHz)	ZHINAN	ZN30900C	18051	Jun. 14, 2018	Jun. 13, 2020
Double-Ridged Waveguide Horn	ETS LINDGREN	3117	00034609	May. 26, 2018	May. 25, 2020
Broadband Preamplifier	ETS LINDGREN	3117PA	00225134	Oct. 25, 2018	Oct. 24, 2019
ANTENNA	SCHWARZBECK	VULB9168	D69250	Sep. 28, 2017	Sep. 27, 2019



Attestation of Global Compliance(Shenzhen)Co.,Ltd.

Add: 2/F., Building 2, No.1-4, Chaxi Sanwei Technial Industrial Park, Gushu, Xixiang, Bao'an District, Shenzhen, Guangdong, China

Tel: +86-755 2523 4088 E-mail: agc@agc-cert.com Service Hotline:400 089 2118

7. PEAK OUTPUT POWER

7.1. MEASUREMENT PROCEDURE

For peak power test:

1. Connect EUT RF output port to the Spectrum Analyzer through an RF attenuator
2. Span: Approximately five times the 20 dB bandwidth, centered on a hopping channel.
3. RBW > 20 dB bandwidth of the emission being measured.
4. VBW \geq RBW.
5. Sweep: Auto.
6. Detector function: Peak.
7. Trace: Max hold.

Allow trace to stabilize. Use the marker-to-peak function to set the marker to the peak of the emission. The indicated level is the peak output power, after any corrections for external attenuators and cables.

7.2. TEST SET-UP (BLOCK DIAGRAM OF CONFIGURATION)

PEAK POWER TEST SETUP

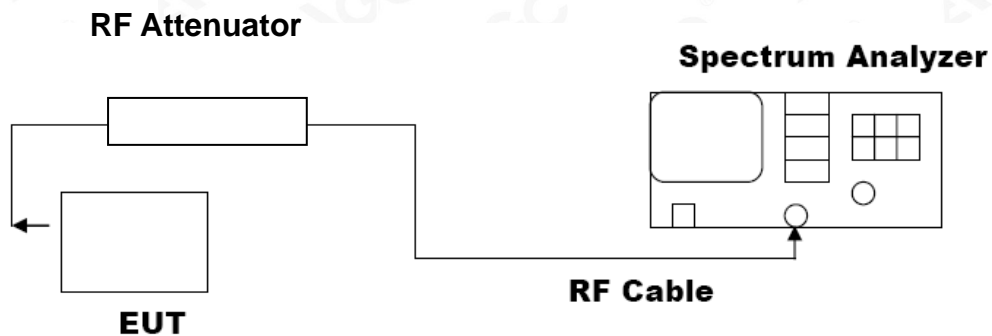

7.3. LIMITS AND MEASUREMENT RESULT

PEAK OUTPUT POWER MEASUREMENT RESULT FOR GFSK MODULATION			
Frequency (GHz)	Peak Power (dBm)	Applicable Limits (dBm)	Pass or Fail
2.402	1.822	30	Pass
2.441	2.196	30	Pass
2.480	2.821	30	Pass

CH0

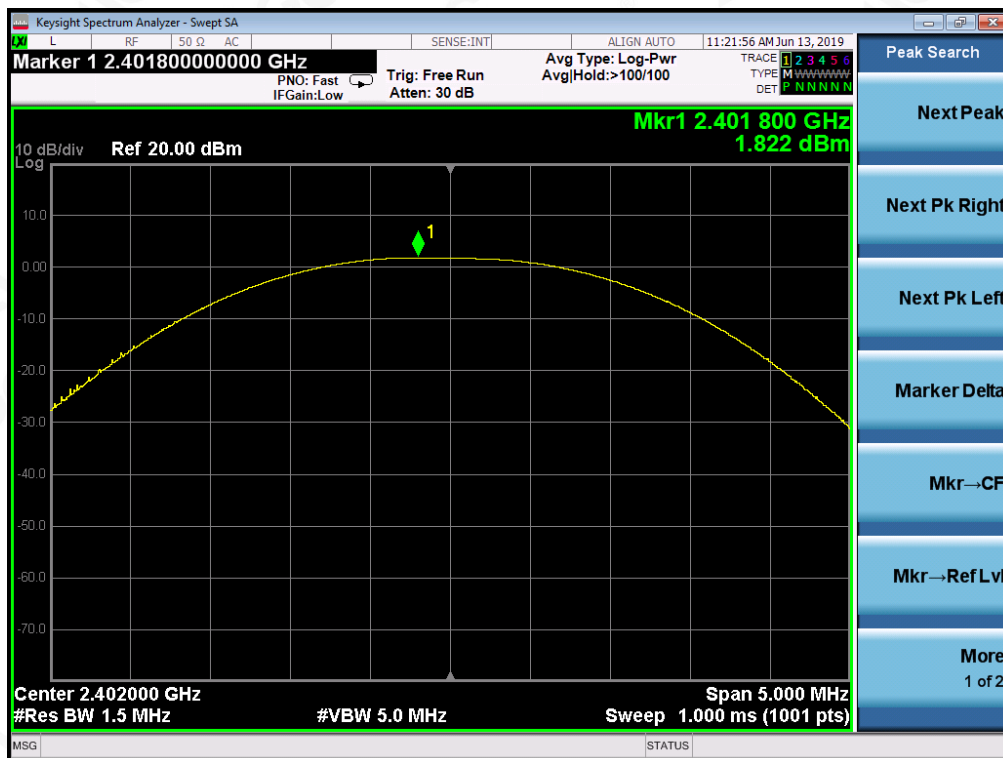

Attestation of Global Compliance(Shenzhen)Co.,Ltd.

Add: 2/F., Building 2, No.1-4, Chaxi Sanwei Technial Industrial Park, Gushu,
Xixiang, Bao'an District, Shenzhen, Guangdong, China
Tel: +86-755 2523 4088 E-mail: agc@agc-cert.com Service Hotline:400 089 2118

CH39

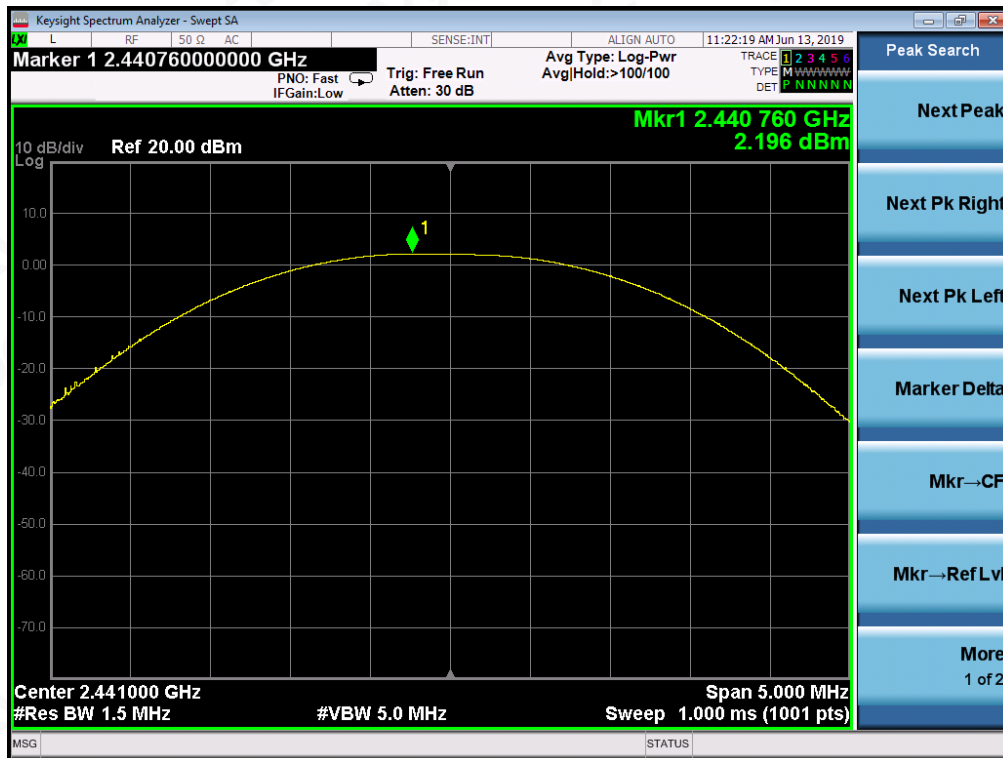

CH78

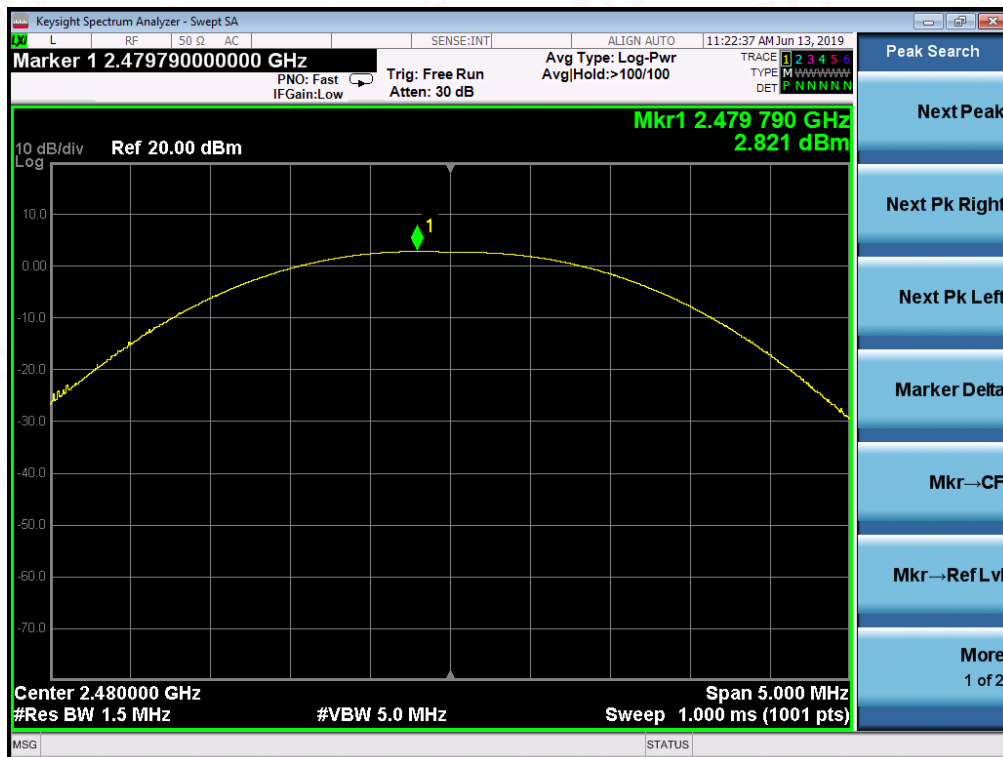

Attestation of Global Compliance(Shenzhen)Co.,Ltd.

Add: 2/F., Building 2, No.1-4, Chaxi Sanwei Technial Industrial Park, Gushu,
Xixiang, Bao'an District, Shenzhen, Guangdong, China

Tel: +86-755 2523 4088

E-mail: agc@agc-cert.com

Service Hotline:400 089 2118

PEAK OUTPUT POWER MEASUREMENT RESULT FOR $\Pi/4$ -DQPSK MODULATION			
Frequency (GHz)	Peak Power (dBm)	Applicable Limits (dBm)	Pass or Fail
2.402	2.466	30	Pass
2.441	2.839	30	Pass
2.480	3.482	30	Pass

CH0

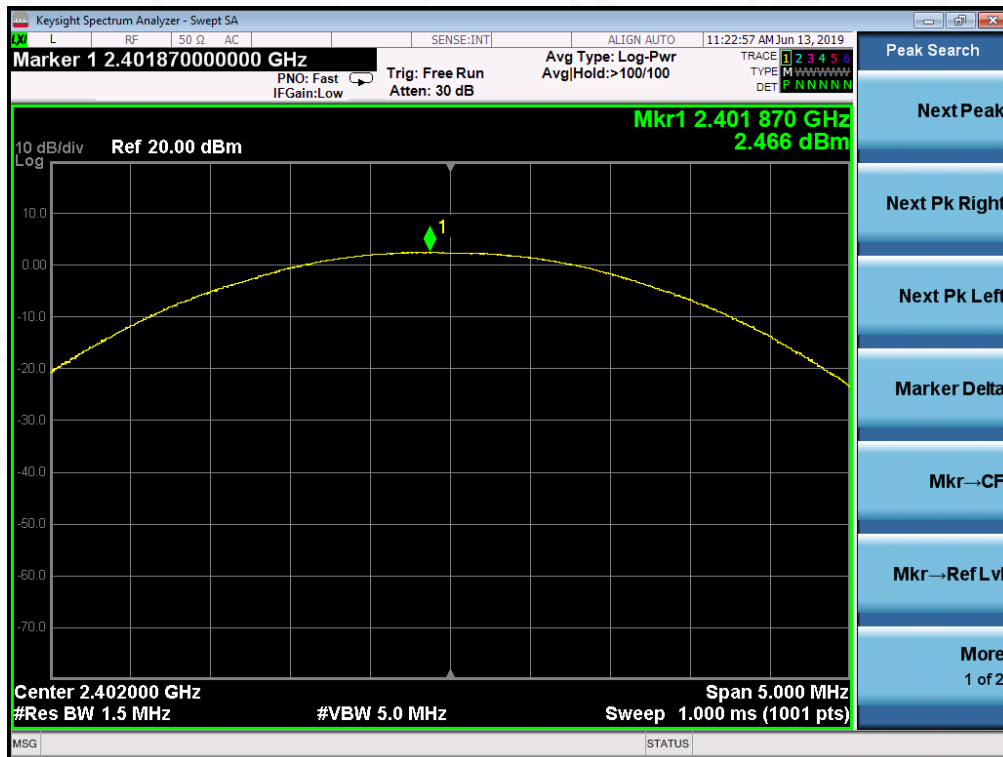

Attestation of Global Compliance(Shenzhen)Co.,Ltd.

Add: 2/F., Building 2, No.1-4, Chaxi Sanwei Technical Industrial Park, Gushu,
Xixiang, Bao'an District, Shenzhen, Guangdong, China

Tel: +86-755 2523 4088

E-mail: agc@agc-cert.com

Service Hotline:400 089 2118

CH39

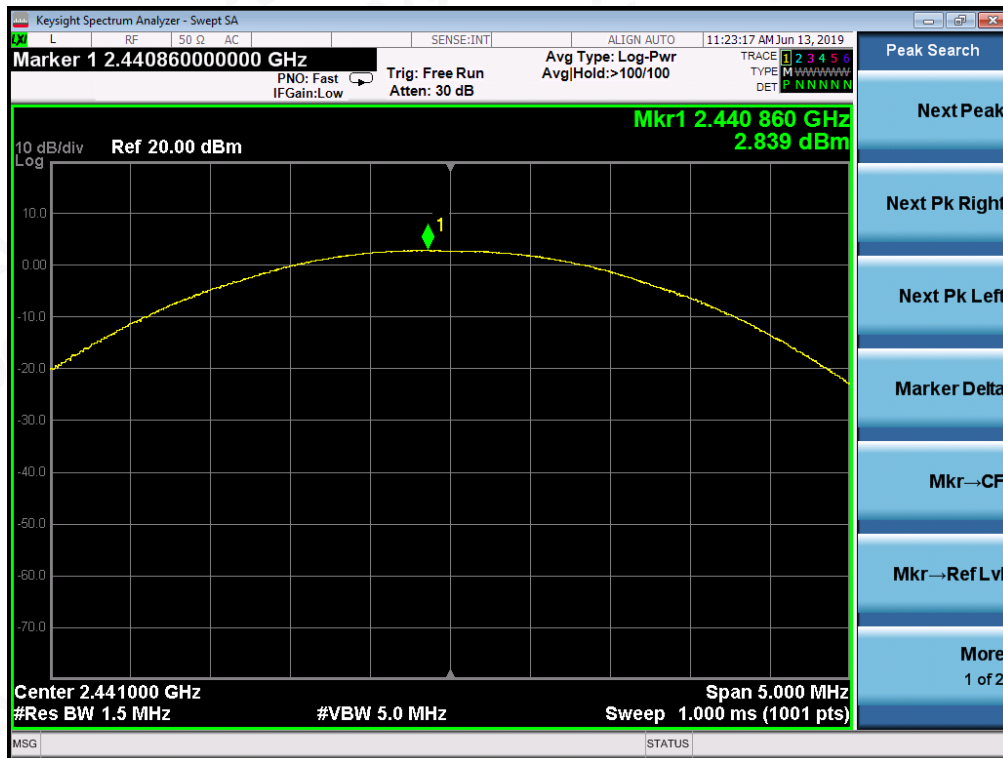

CH78

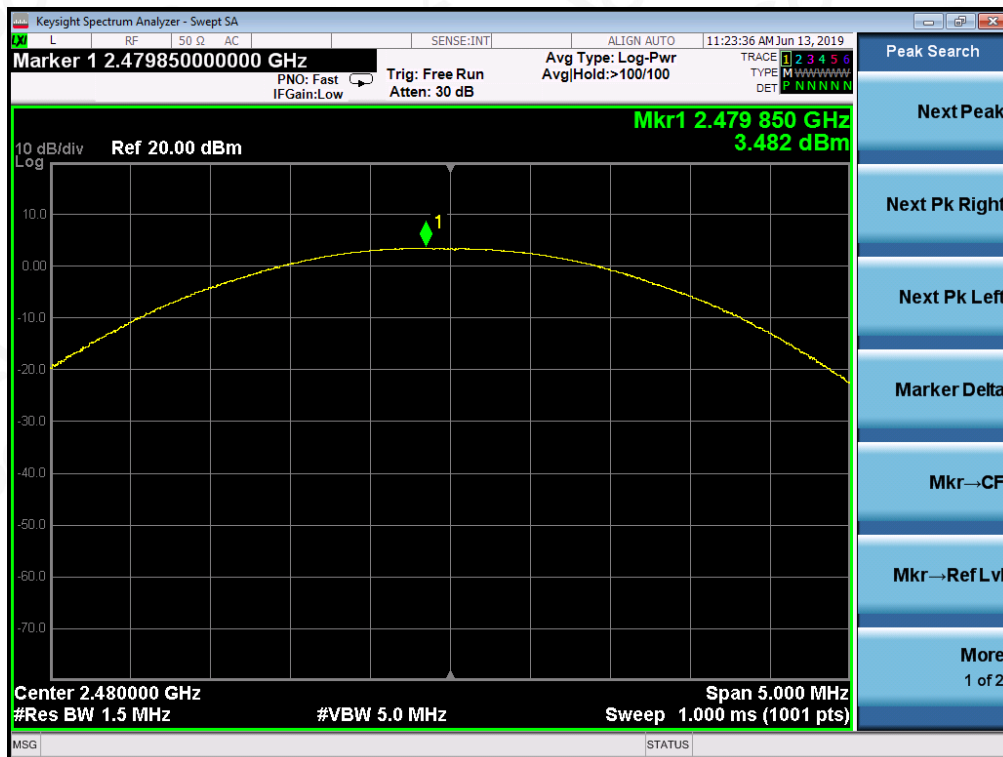

Attestation of Global Compliance(Shenzhen)Co.,Ltd.

Add: 2/F., Building 2, No.1-4, Chaxi Sanwei Technical Industrial Park, Gushu, Xixiang, Bao'an District, Shenzhen, Guangdong, China

Tel: +86-755 2523 4088

E-mail: agc@agc-cert.com

Service Hotline:400 089 2118

8. 20DB BANDWIDTH

8.1. MEASUREMENT PROCEDURE

1. Connect EUT RF output port to the Spectrum Analyzer through an RF attenuator
2. Set the EUT Work on the top, the middle and the bottom operation frequency individually.
3. Set Span = approximately 2 to 5 times the 20 dB bandwidth, centered on a hoping channel
The nominal IF filter bandwidth (3 dB RBW) shall be in the range of 1% to 5% of the OBW and video bandwidth (VBW) shall be approximately three times RBW; Sweep = auto; Detector function = peak
4. Set SPA Trace 1 Max hold, then View.

8.2. TEST SET-UP (BLOCK DIAGRAM OF CONFIGURATION)

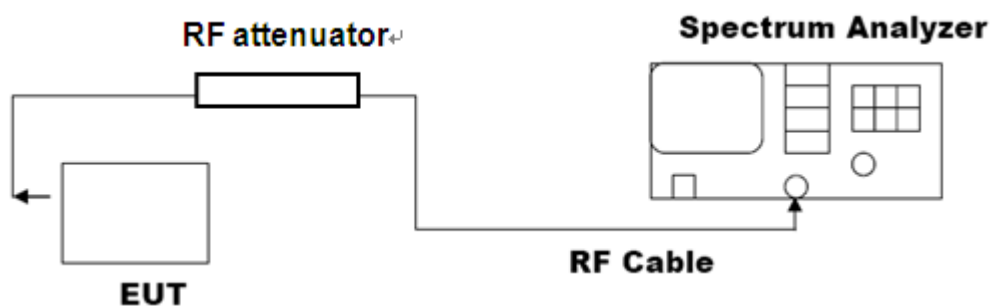

8.3. LIMITS AND MEASUREMENT RESULTS

MEASUREMENT RESULT FOR GFSK MOUDULATION			
Applicable Limits	Measurement Result		
	Test Data (MHz)		Criteria
N/A	Low Channel	0.9478	PASS
	Middle Channel	0.9459	PASS
	High Channel	0.9481	PASS



TEST PLOT OF BANDWIDTH FOR LOW CHANNEL

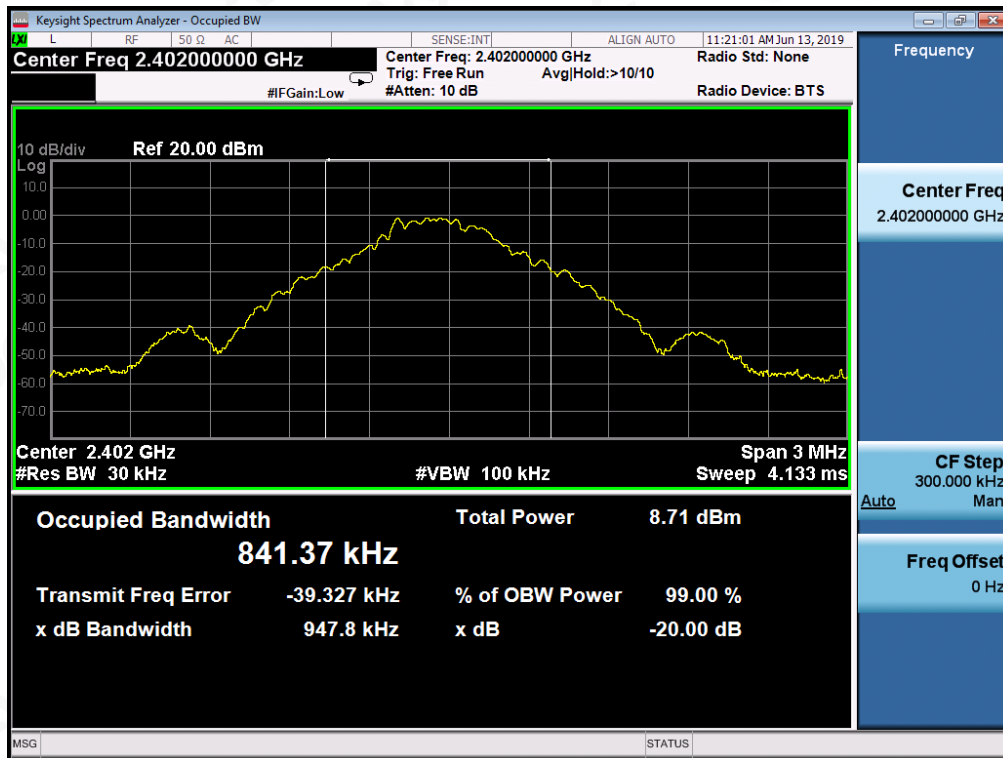

TEST PLOT OF BANDWIDTH FOR MIDDLE CHANNEL

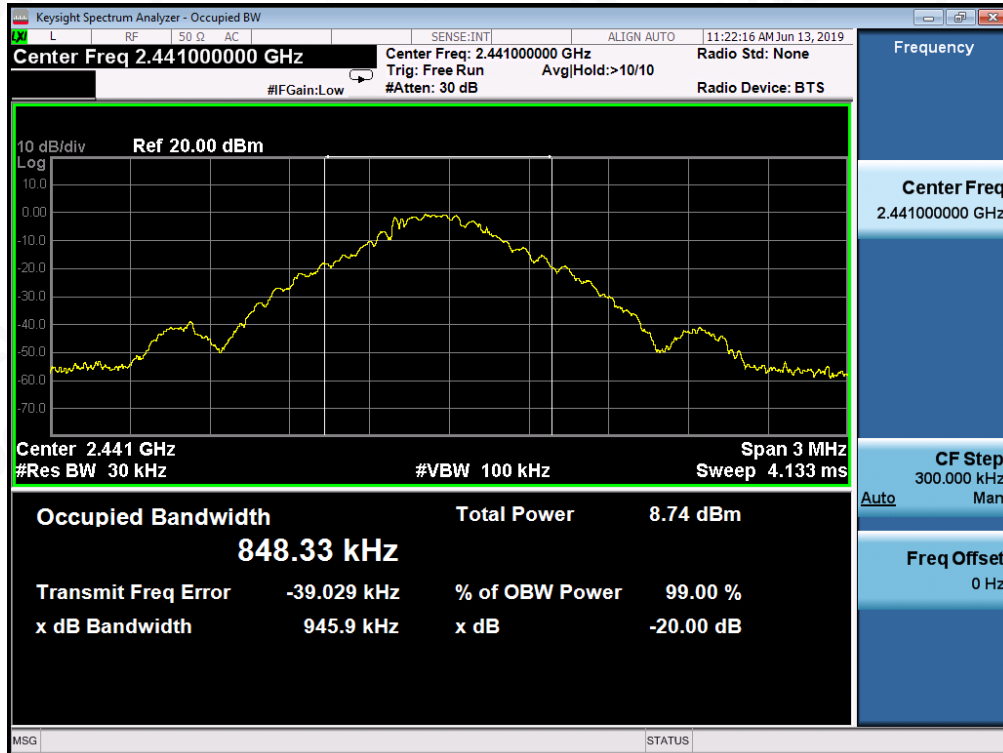

Attestation of Global Compliance(Shenzhen)Co.,Ltd.

Add: 2/F., Building 2, No.1-4, Chaxi Sanwei Technial Industrial Park, Gushu,
Xixiang, Bao'an District, Shenzhen, Guangdong, China
Tel: +86-755 2523 4088 E-mail: agc@agc-cert.com Service Hotline:400 089 2118

TEST PLOT OF BANDWIDTH FOR HIGH CHANNEL



Attestation of Global Compliance(Shenzhen)Co.,Ltd.

Add: 2/F., Building 2, No.1-4, Chaxi Sanwei Technial Industrial Park, Gushu,
Xixiang, Bao'an District, Shenzhen, Guangdong, China

Tel: +86-755 2523 4088

E-mail: agc@agc-cert.com

Service Hotline:400 089 2118

MEASUREMENT RESULT FOR Π /4-DQPSK MODULATION			
Applicable Limits	Measurement Result		
	Test Data (MHz)		Criteria
N/A	Low Channel	1.310	PASS
	Middle Channel	1.307	PASS
	High Channel	1.309	PASS

TEST PLOT OF BANDWIDTH FOR LOW CHANNEL

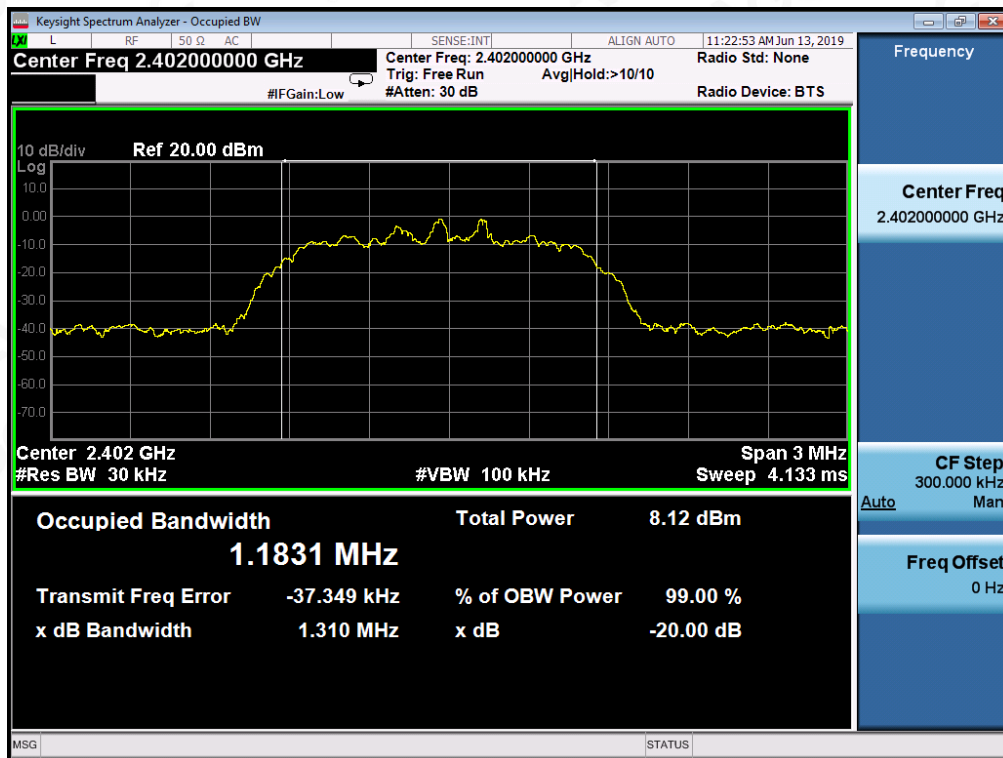

Attestation of Global Compliance(Shenzhen)Co.,Ltd.

Add: 2/F., Building 2, No.1-4, Chaxi Sanwei Technial Industrial Park, Gushu, Xixiang, Bao'an District, Shenzhen, Guangdong, China

Tel: +86-755 2523 4088

E-mail: agc@agc-cert.com

Service Hotline:400 089 2118

TEST PLOT OF BANDWIDTH FOR MIDDLE CHANNEL

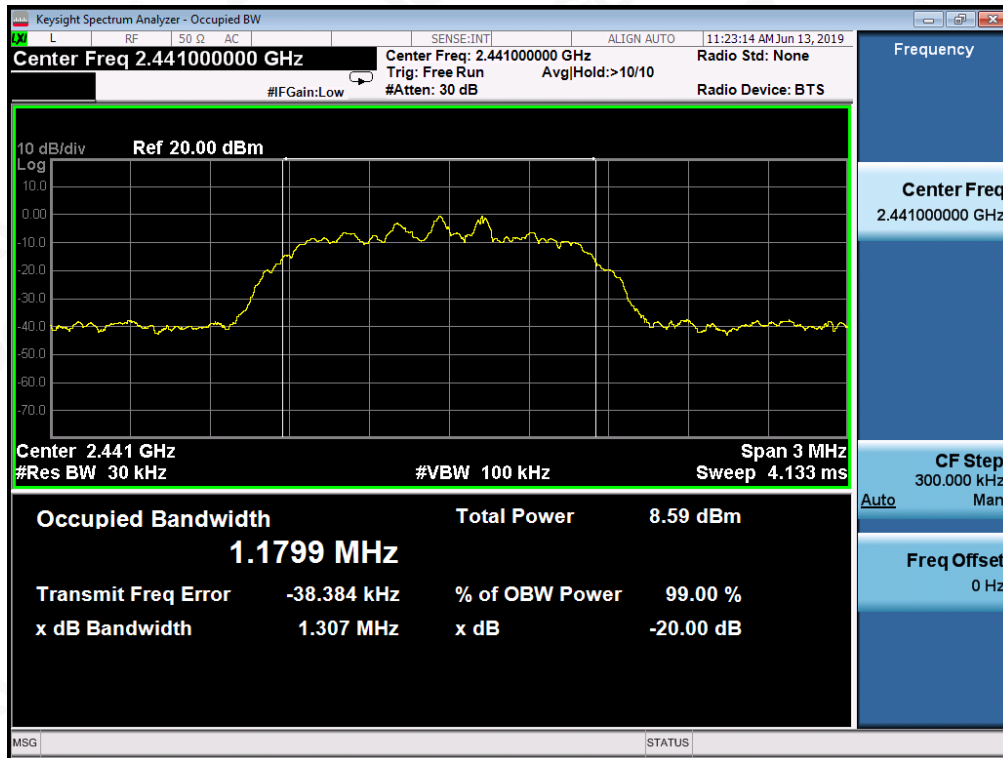

TEST PLOT OF BANDWIDTH FOR HIGH CHANNEL

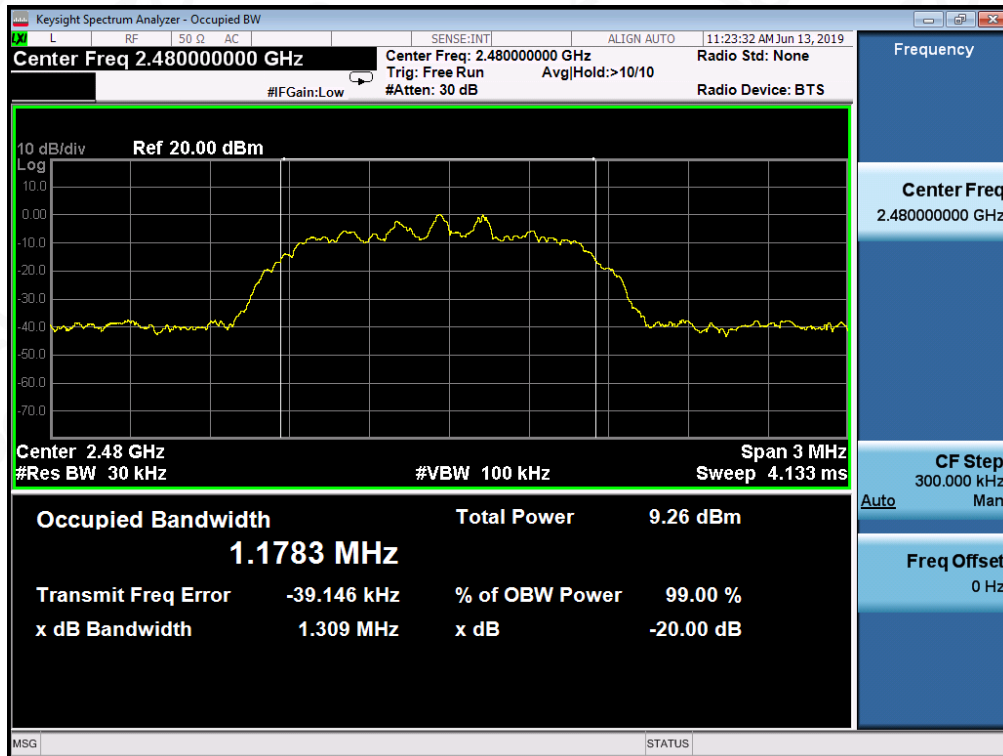

Attestation of Global Compliance(Shenzhen)Co.,Ltd.

Add: 2/F., Building 2, No.1-4, Chaxi Sanwei Technial Industrial Park, Gushu, Xixiang, Bao'an District, Shenzhen, Guangdong, China
Tel: +86-755 2523 4088 E-mail: agc@agc-cert.com Service Hotline:400 089 2118

9. CONDUCTED SPURIOUS EMISSION

9.1. MEASUREMENT PROCEDURE

1. Connect EUT RF output port to the Spectrum Analyzer through an RF attenuator
2. Set the EUT Work on the top, the Middle and the bottom operation frequency individually.
3. Set the Span = wide enough to capture the peak level of the in-band emission and all spurious emissions from the lowest frequency generated in the EUT up through the 10th harmonic.
RBW = 100 kHz; VBW= 300 kHz; Sweep = auto; Detector function = peak.
4. Set SPA Trace 1 Max hold, then View.

9.2. TEST SET-UP (BLOCK DIAGRAM OF CONFIGURATION)

The same as described in section 8.2

9.3. MEASUREMENT EQUIPMENT USED

The same as described in section 6

9.4. LIMITS AND MEASUREMENT RESULT

LIMITS AND MEASUREMENT RESULT		
Applicable Limits	Measurement Result	
	Test Data	Criteria
In any 100 KHz Bandwidth Outside the frequency band in which the spread spectrum intentional radiator is operating, the radio frequency power that is produce by the intentional radiator shall be at least 20 dB below that in 100KHz bandwidth within the band that contains the highest level of the desired power. In addition, radiation emissions which fall in the restricted bands, as defined in §15.205(a), must also comply with the radiated emission limits specified in§15.209(a)	At least -20dBc than the limit Specified on the BOTTOM Channel	PASS
	At least -20dBc than the limit Specified on the TOP Channel	PASS



Attestation of Global Compliance(Shenzhen)Co.,Ltd.

Add: 2/F., Building 2, No.1-4, Chaxi Sanwei Technial Industrial Park, Gushu, Xixiang, Bao'an District, Shenzhen, Guangdong, China

Tel: +86-755 2523 4088 E-mail: agc@agc-cert.com Service Hotline:400 089 2118

TEST RESULT FOR ENTIRE FREQUENCY RANGE
TEST PLOT OF OUT OF BAND EMISSIONS WITH THE WORST CASE
OF GFSK MODULATION IN LOW CHANNEL

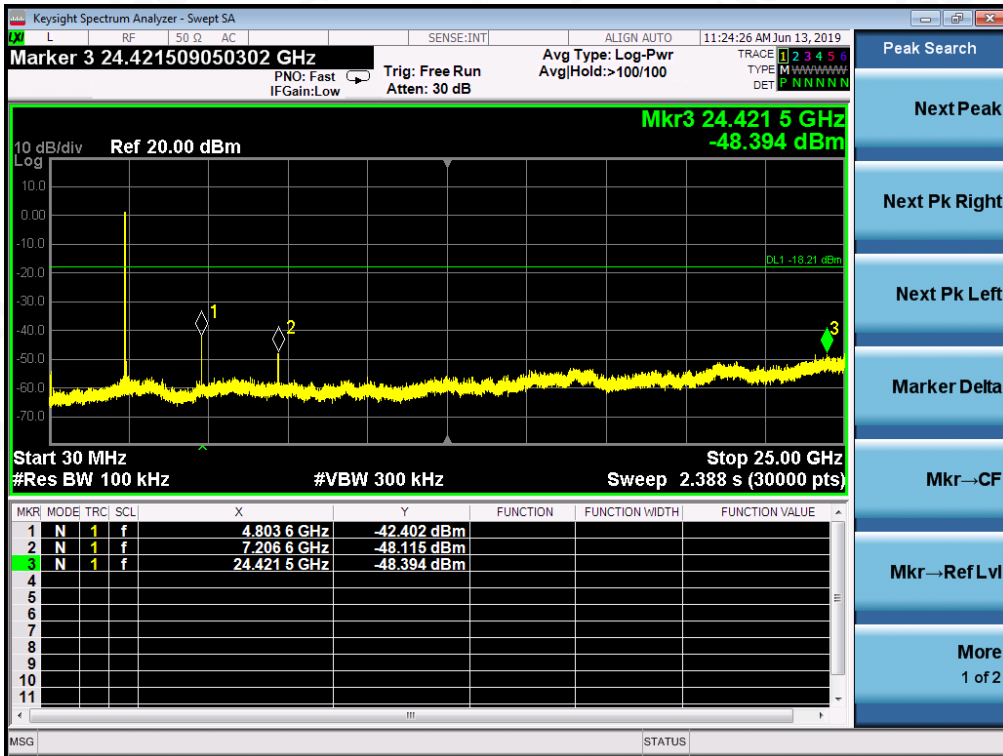
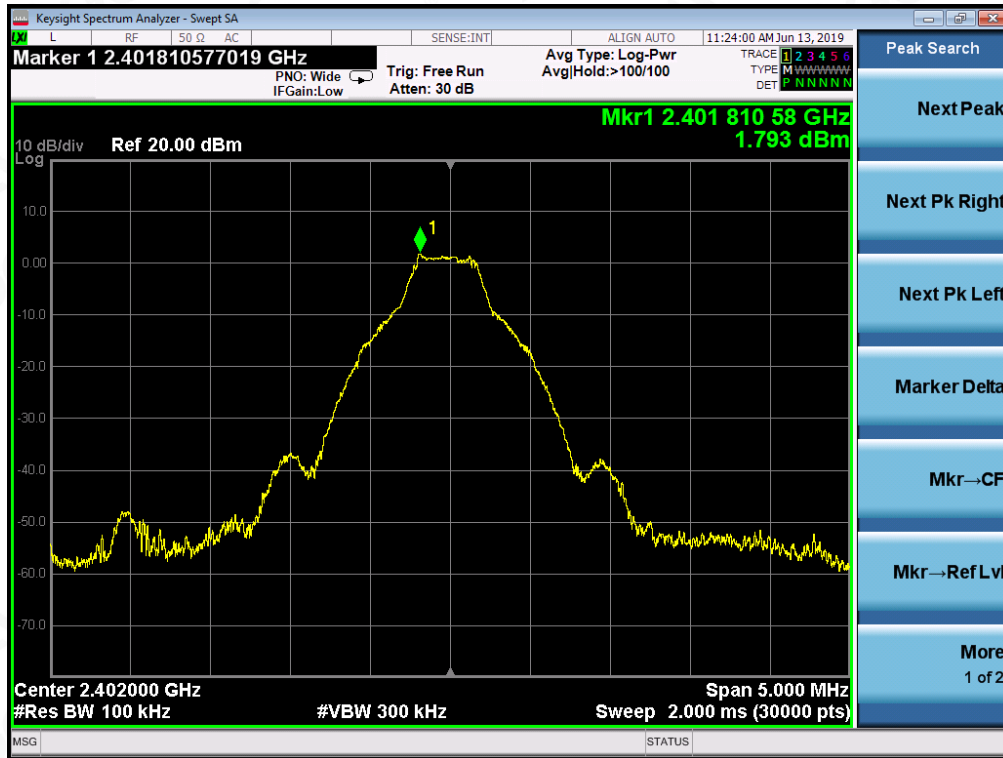

Attestation of Global Compliance(Shenzhen)Co.,Ltd.

Add: 2/F., Building 2, No.1-4, Chaxi Sanwei Technial Industrial Park, Gushu,
Xixiang, Bao'an District, Shenzhen, Guangdong, China

Tel: +86-755 2523 4088

E-mail: agc@agc-cert.com

Service Hotline:400 089 2118

TEST PLOT OF OUT OF BAND EMISSIONS
OF GFSK MODULATION IN MIDDLE CHANNEL

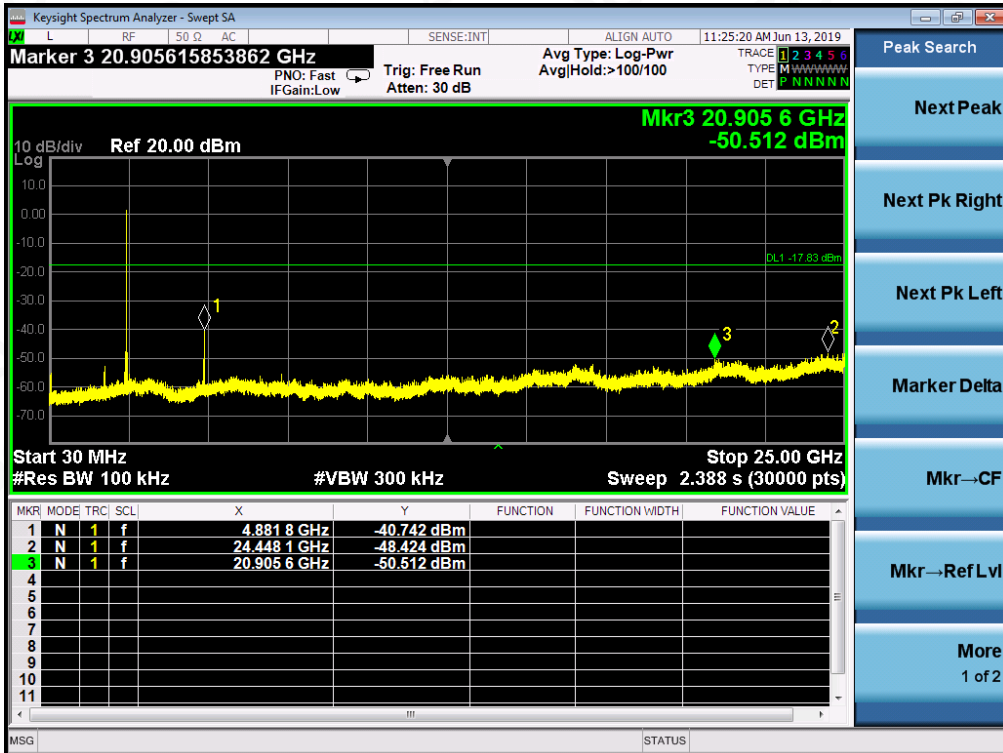
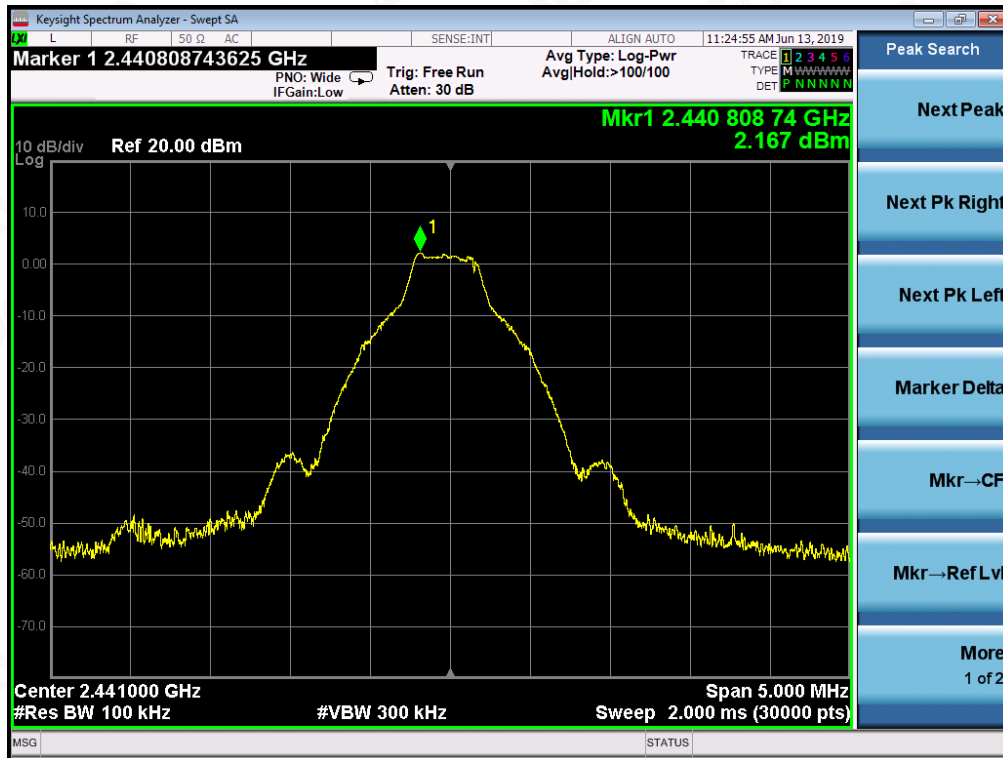

Attestation of Global Compliance(Shenzhen)Co.,Ltd.

Add: 2/F., Building 2, No.1-4, Chaxi Sanwei Technial Industrial Park, Gushu,
Xixiang, Bao'an District, Shenzhen, Guangdong, China

Tel: +86-755 2523 4088

E-mail: agc@agc-cert.com

Service Hotline:400 089 2118

TEST PLOT OF OUT OF BAND EMISSIONS OF GFSK MODULATION IN HIGH CHANNEL

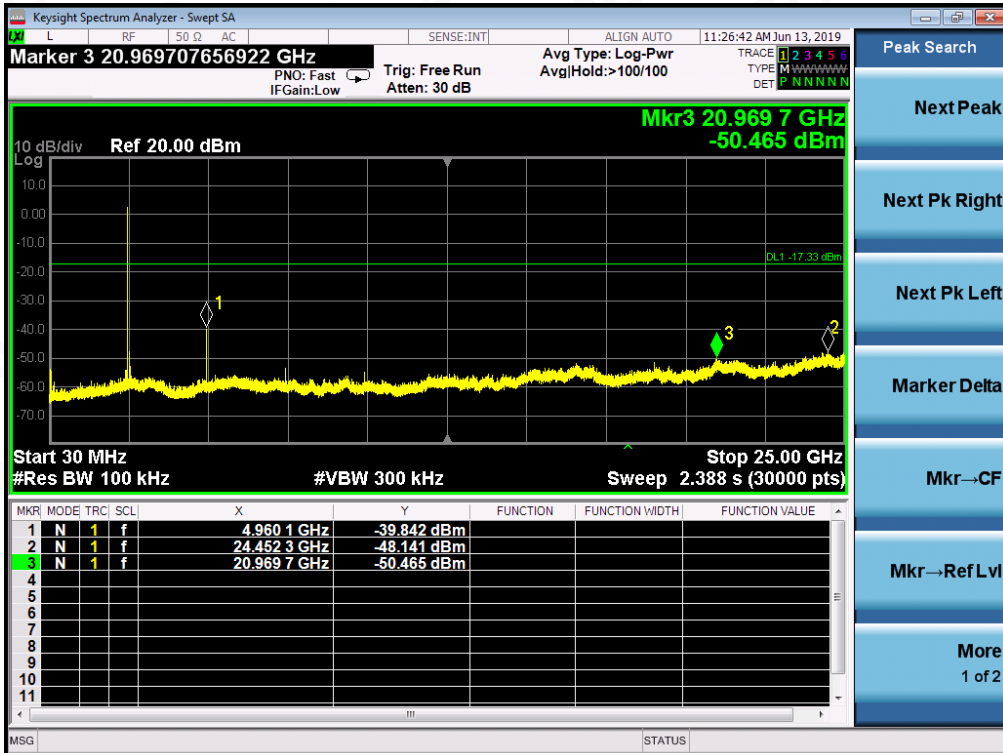

Note: The peak emissions without marker on the above plots are fundamental wave and need not to compare with the limit. The GFSK modulation is the worst case and only those data recorded in the report.



Attestation of Global Compliance(Shenzhen)Co.,Ltd.

Add: 2/F., Building 2, No.1-4, Chaxi Sanwei Technical Industrial Park, Gushu,
Xixiang, Bao'an District, Shenzhen, Guangdong, China

Tel: +86-755 2523 4088

E-mail: agc@agc-cert.com

Service Hotline:400 089 2118

TEST RESULT FOR BAND EDGE
GFSK MODULATION IN LOW CHANNEL
Hopping off

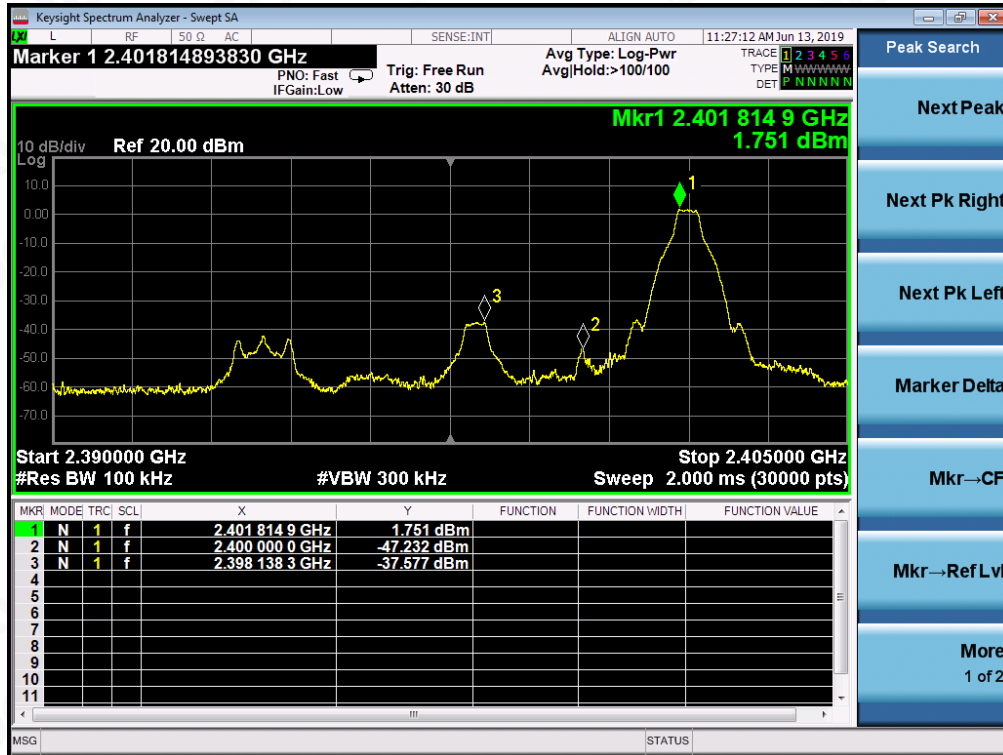

Hopping on

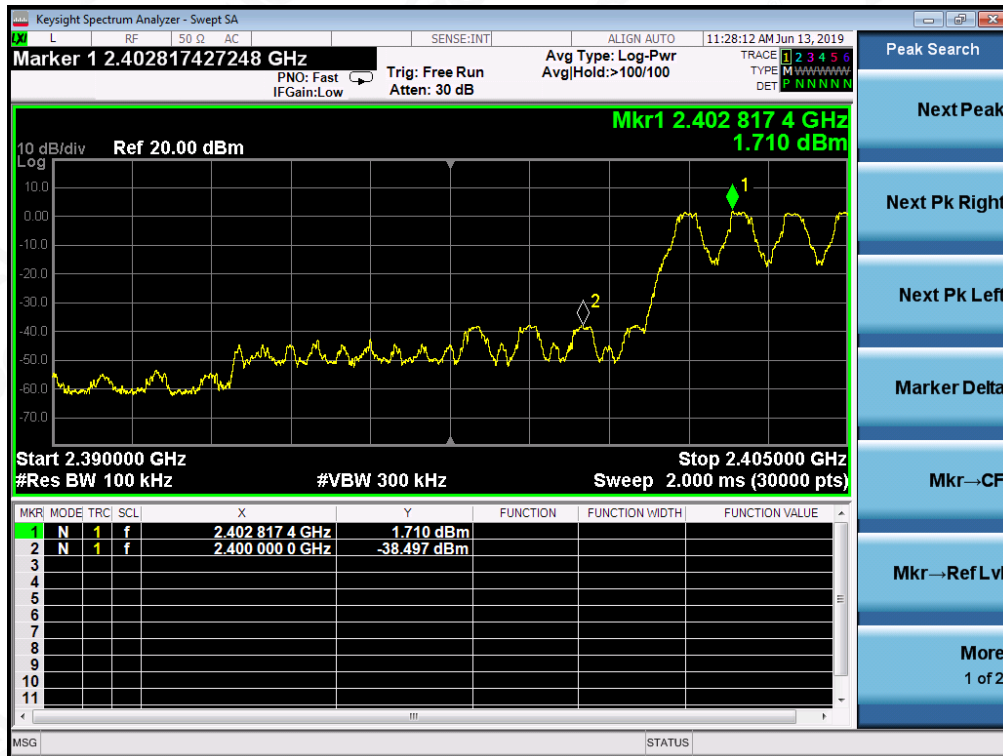

Attestation of Global Compliance(Shenzhen)Co.,Ltd.

Add: 2/F., Building 2, No.1-4, Chaxi Sanwei Technial Industrial Park, Gushu,
Xixiang, Bao'an District, Shenzhen, Guangdong, China
Tel: +86-755 2523 4088 E-mail: agc@agc-cert.com Service Hotline:400 089 2118

GFSK MODULATION IN HIGH CHANNEL Hopping off

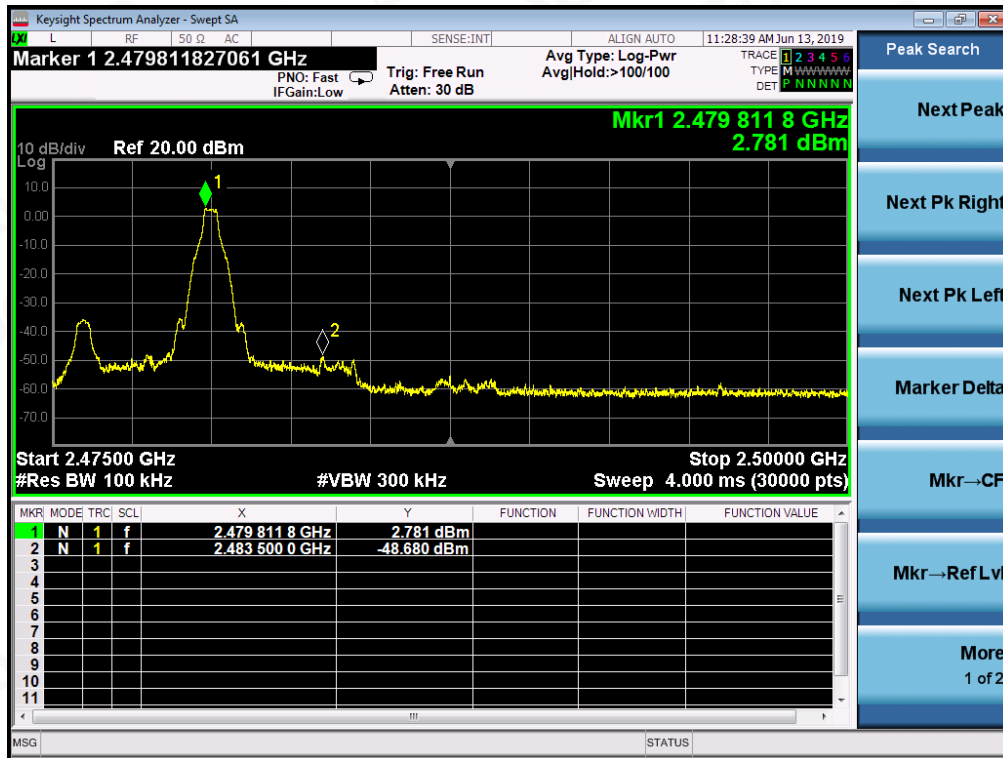

Hopping on

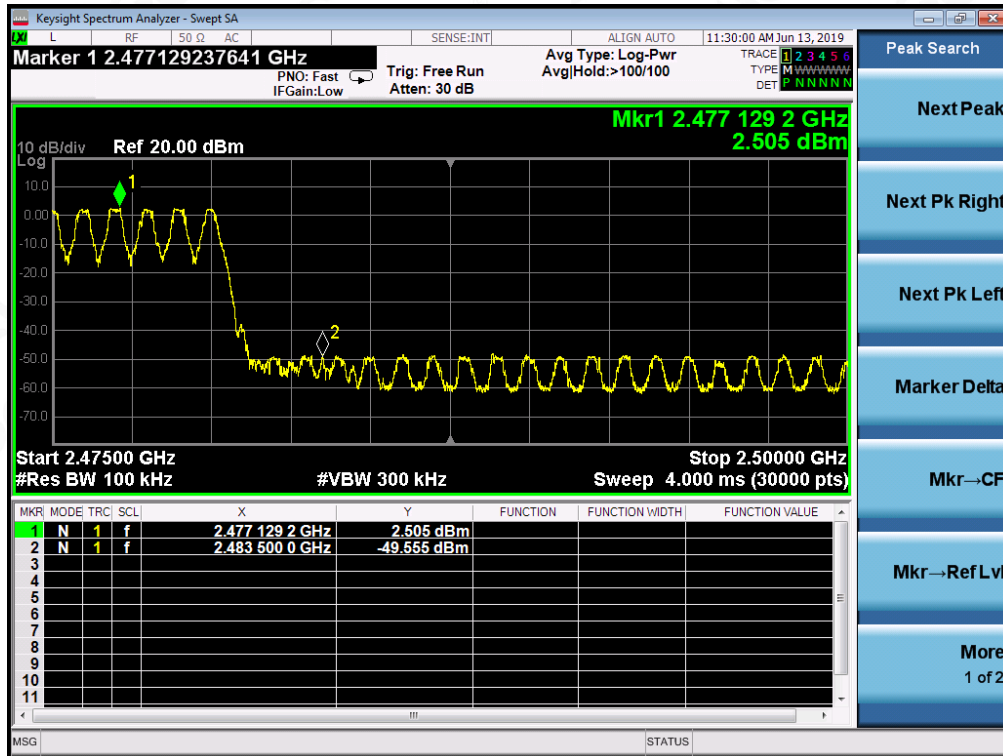

Attestation of Global Compliance(Shenzhen)Co.,Ltd.

Add: 2/F., Building 2, No.1-4, Chaxi Sanwei Technial Industrial Park, Gushu,
Xixiang, Bao'an District, Shenzhen, Guangdong, China
Tel: +86-755 2523 4088 E-mail: agc@agc-cert.com Service Hotline:400 089 2118

π /4-DQPSK MODULATION IN LOW CHANNEL
Hopping off

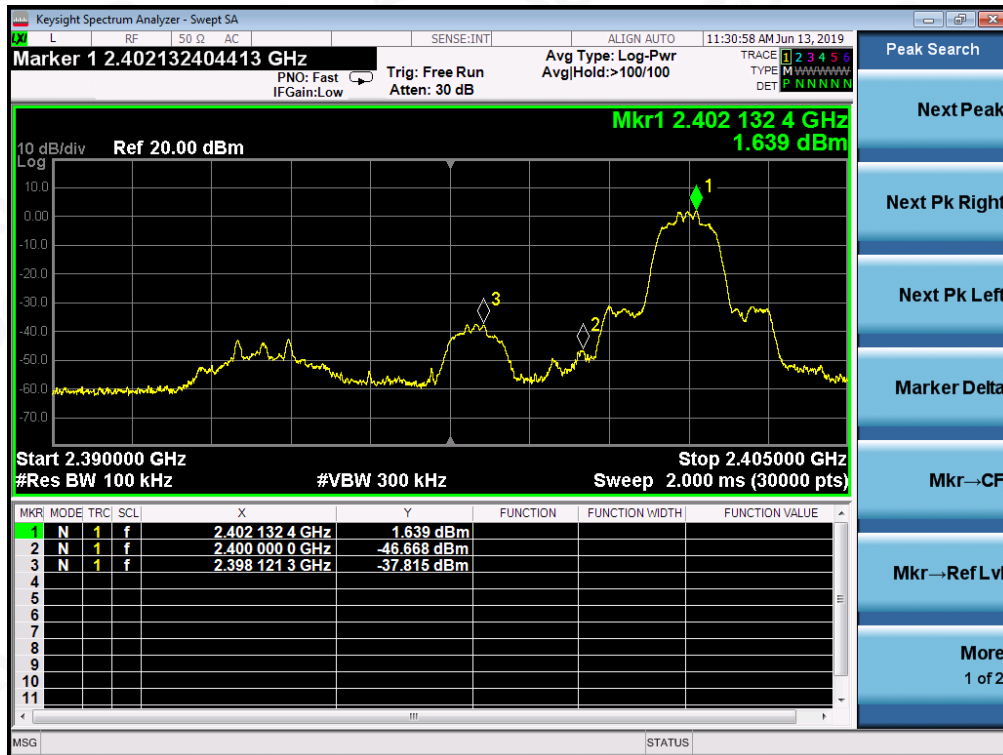

Hopping on



Attestation of Global Compliance(Shenzhen)Co.,Ltd.

Add: 2/F., Building 2, No.1-4, Chaxi Sanwei Technial Industrial Park, Gushu,
Xixiang, Bao'an District, Shenzhen, Guangdong, China
Tel: +86-755 2523 4088 E-mail: agc@agc-cert.com Service Hotline:400 089 2118

π /4-DQPSK MODULATION IN HIGH CHANNEL
Hopping off

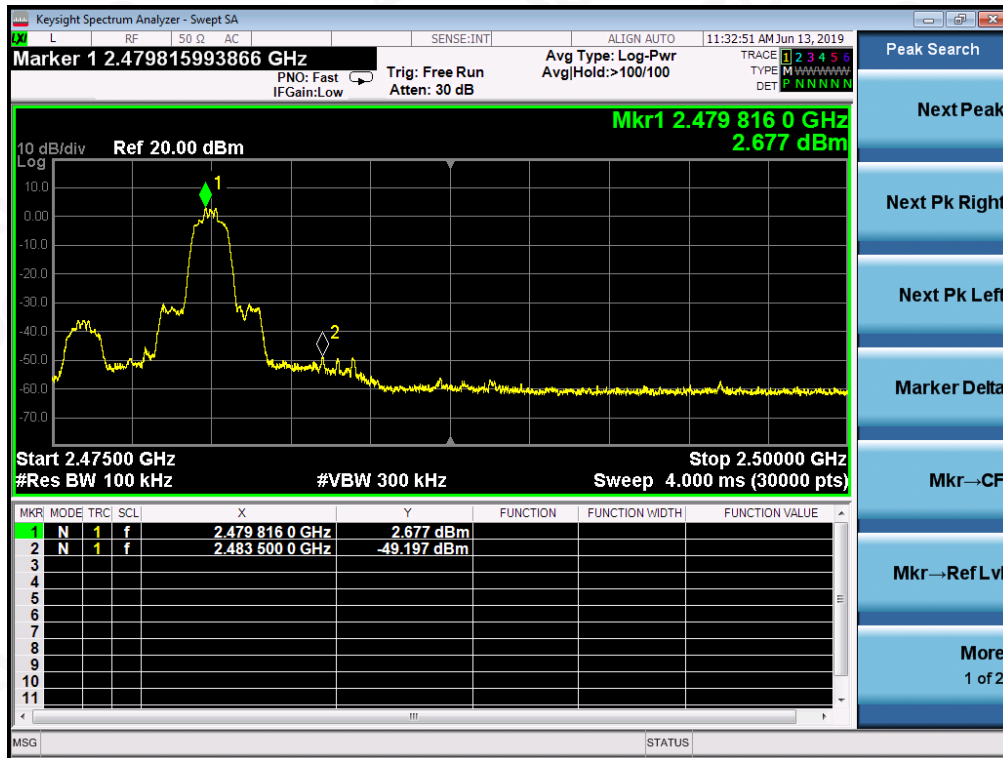

Hopping on

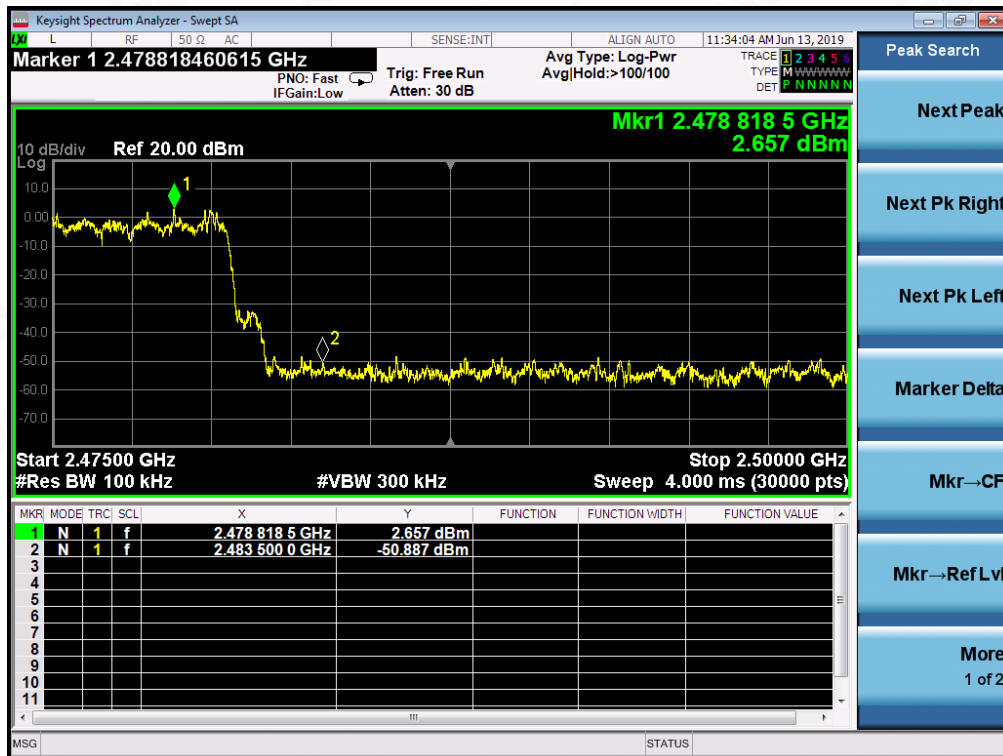

Attestation of Global Compliance(Shenzhen)Co.,Ltd.

Add: 2/F., Building 2, No.1-4, Chaxi Sanwei Technial Industrial Park, Gushu,
Xixiang, Bao'an District, Shenzhen, Guangdong, China
Tel: +86-755 2523 4088 E-mail: agc@agc-cert.com Service Hotline:400 089 2118

10. RADIATED EMISSION

10.1. MEASUREMENT PROCEDURE

1. The EUT was placed on the top of the turntable 0.8 or 1.5 meter above ground. The phase center of the receiving antenna mounted on the top of a height-variable antenna tower was placed 3 meters far away from the turntable.
2. Power on the EUT and all the supporting units. The turntable was rotated by 360 degrees to determine the position of the highest radiation.
3. The height of the broadband receiving antenna was varied between one meter and four meters above ground to find the maximum emissions field strength of both horizontal and vertical polarization.
4. For each suspected emissions, the antenna tower was scan (from 1 M to 4 M) and then the turntable was rotated (from 0 degree to 360 degrees) to find the maximum reading.
5. Set the test-receiver system to Peak or CISPR quasi-peak Detect Function with specified bandwidth under Maximum Hold Mode.
6. For emissions above 1GHz, use 1MHz RBW and 3MHz VBW for peak reading. Place the measurement antenna away from each area of the EUT determined to be a source of emissions at the specified measurement distance, while keeping the measurement antenna aimed at the source of emissions at each frequency of significant emissions, with polarization oriented for maximum response. The measurement antenna may have to be higher or lower than the EUT, depending on the radiation pattern of the emission and staying aimed at the emission source for receiving the maximum signal. The final measurement antenna elevation shall be that which maximizes the emissions. The measurement antenna elevation for maximum emissions shall be restricted to a range of heights of from 1 m to 4 m above the ground or reference ground plane.
7. When the radiated emissions limits are expressed in terms of the average value of the emissions, and pulsed operation is employed, the measurement field strength shall be determined by averaging over one complete pulse train, including blanking intervals, as long as the pulse train does not exceed 0.1 seconds. As an alternative (provided the transmitter operates for longer than 0.1 seconds) or in cases where the pulse train exceeds 0.1 seconds, the measured field strength shall be determined from the average absolute voltage during a 0.1 second interval during which the field strength is at its maximum values.
8. If the emissions level of the EUT in peak mode was 3 dB lower than the average limit specified, then testing will be stopped and peak values of EUT will be reported, otherwise, the emissions which do not have 3 dB margin will be repeated one by one using the quasi-peak method for below 1GHz.
9. For testing above 1GHz, the emissions level of the EUT in peak mode was lower than average limit (that means the emissions level in peak mode also complies with the limit in average mode), then testing will be stopped and peak values of EUT will be reported, otherwise, the emissions will be measured in average mode again and reported.
10. In case the emission is lower than 30MHz, loop antenna has to be used for measurement and the recorded data should be QP measured by receiver. High - Low scan is not required in this case.



The following table is the setting of spectrum analyzer and receiver.

Spectrum Parameter	Setting
Start ~Stop Frequency	9KHz~150KHz/RB 200Hz for QP
Start ~Stop Frequency	150KHz~30MHz/RB 9KHz for QP
Start ~Stop Frequency	30MHz~1000MHz/RB 120KHz for QP
Start ~Stop Frequency	1GHz~26.5GHz 1MHz/3MHz for Peak, 1MHz/3MHz for Average

Receiver Parameter	Setting
Start ~Stop Frequency	9KHz~150KHz/RB 200Hz for QP
Start ~Stop Frequency	150KHz~30MHz/RB 9KHz for QP
Start ~Stop Frequency	30MHz~1000MHz/RB 120KHz for QP



Attestation of Global Compliance(Shenzhen)Co.,Ltd.

Add: 2/F., Building 2, No.1-4, Chaxi Sanwei Technial Industrial Park, Gushu,
Xixiang, Bao'an District, Shenzhen, Guangdong, China

Tel: +86-755 2523 4088

E-mail: agc@agc-cert.com

Service Hotline:400 089 2118

10.2. TEST SETUP

Radiated Emission Test-Setup Frequency Below 30MHz



RADIATED EMISSION TEST SETUP 30MHz-1000MHz

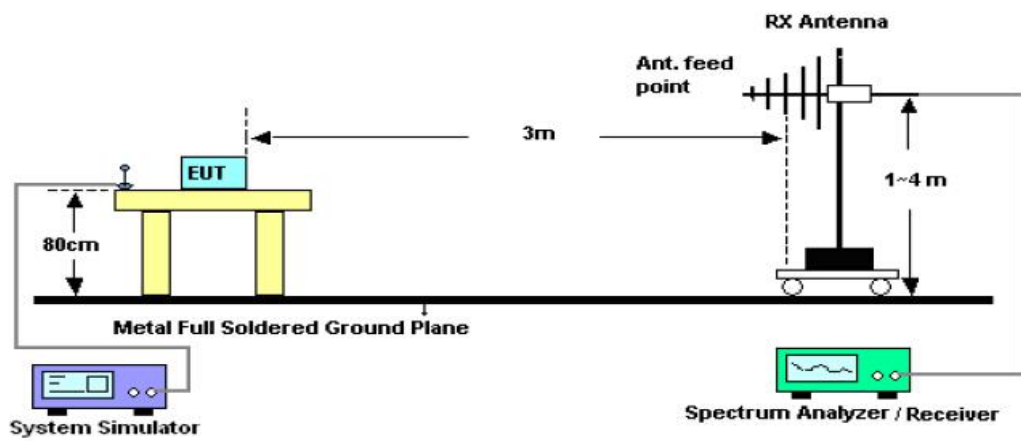

RADIATED EMISSION TEST SETUP ABOVE 1000MHz

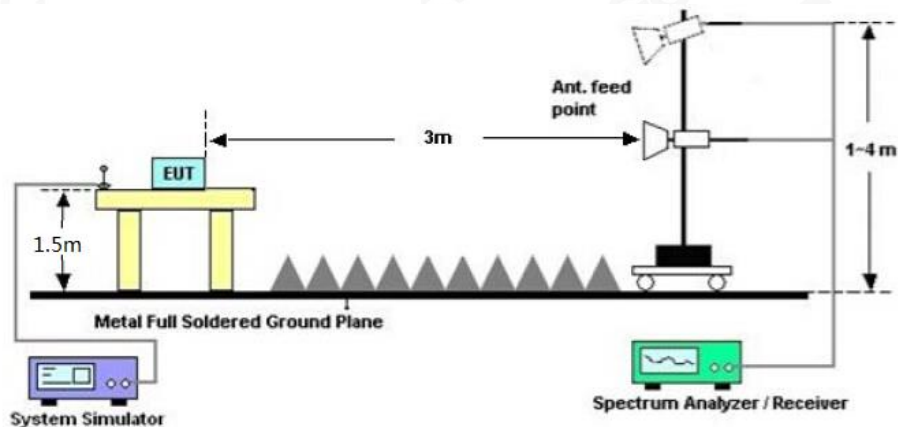

Attestation of Global Compliance(Shenzhen)Co.,Ltd.

Add: 2/F., Building 2, No.1-4, Chaxi Sanwei Technical Industrial Park, Gushu, Xixiang, Bao'an District, Shenzhen, Guangdong, China

Tel: +86-755 2523 4088

E-mail: agc@agc-cert.com

Service Hotline:400 089 2118

10.3. LIMITS AND MEASUREMENT RESULT

15.209 Limit in the below table has to be followed

Frequencies (MHz)	Field Strength (micorvolts/meter)	Measurement Distance (meters)
0.009~0.490	2400/F(KHz)	300
0.490~1.705	24000/F(KHz)	30
1.705~30.0	30	30
30~88	100	3
88~216	150	3
216~960	200	3
Above 960	500	3

Note: All modes were tested For restricted band radiated emission, the test records reported below are the worst result compared to other modes.

10.4. TEST RESULT

RADIATED EMISSION BELOW 30MHZ

No emission found between lowest internal used/generated frequencies to 30MHz.



Attestation of Global Compliance(Shenzhen)Co.,Ltd.

Add: 2/F., Building 2, No.1-4, Chaxi Sanwei Technial Industrial Park, Gushu, Xixiang, Bao'an District, Shenzhen, Guangdong, China

Tel: +86-755 2523 4088

E-mail: agc@agc-cert.com

Service Hotline:400 089 2118

RADIATED EMISSION BELOW 1GHZ

EUT	Bluetooth receiver	Model Name	BT03A
Temperature	25°C	Relative Humidity	55.4%
Pressure	960hPa	Test Voltage	Normal Voltage
Test Mode	Mode 4	Antenna	Horizontal

66.9 dBuV/m

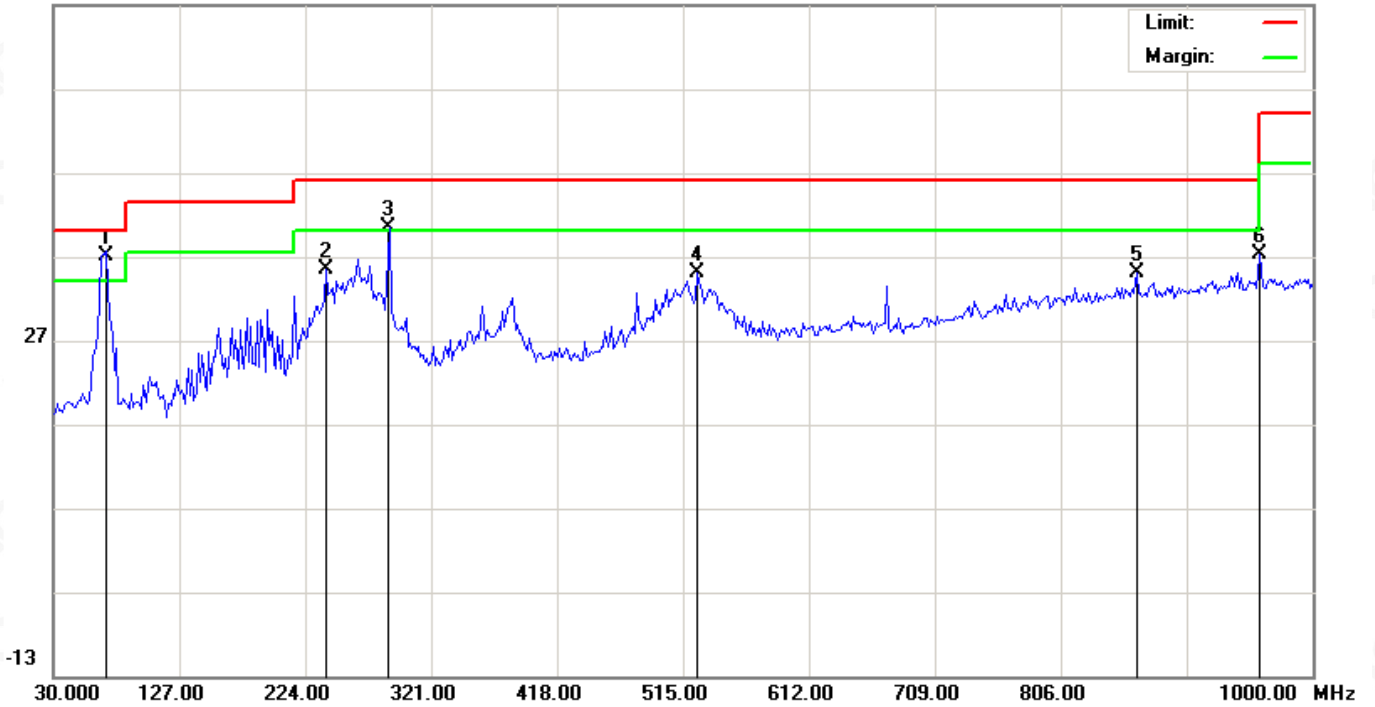

No.	Mk	Freq.	Reading	Factor	Measurement	Limit	Over	Detector	Antenna Height	Table Degree	Comment
		MHz	dBuV	dB/m	dBuV/m	dBuV/m	dB		cm	degree	
1	*	70.4167	19.91	17.02	36.93	40.00	-3.07	QP			
2		240.1667	16.68	18.66	35.34	46.00	-10.66	peak			
3	!	288.6666	20.74	19.74	40.48	46.00	-5.52	peak			
4		526.3167	9.43	25.51	34.94	46.00	-11.06	peak			
5		864.2000	3.84	31.24	35.08	46.00	-10.92	peak			
6		959.5833	5.05	32.21	37.26	46.00	-8.74	peak			

RESULT: PASS



Attestation of Global Compliance(Shenzhen)Co.,Ltd.

Add: 2/F., Building 2, No.1-4, Chaxi Sanwei Technial Industrial Park, Gushu, Xixiang, Bao'an District, Shenzhen, Guangdong, China

Tel: +86-755 2523 4088

E-mail: agc@agc-cert.com

Service Hotline:400 089 2118

EUT	Bluetooth receiver	Model Name	BT03A
Temperature	25°C	Relative Humidity	55.4%
Pressure	960hPa	Test Voltage	Normal Voltage
Test Mode	Mode 4	Antenna	Vertical

66.9 dBuV/m

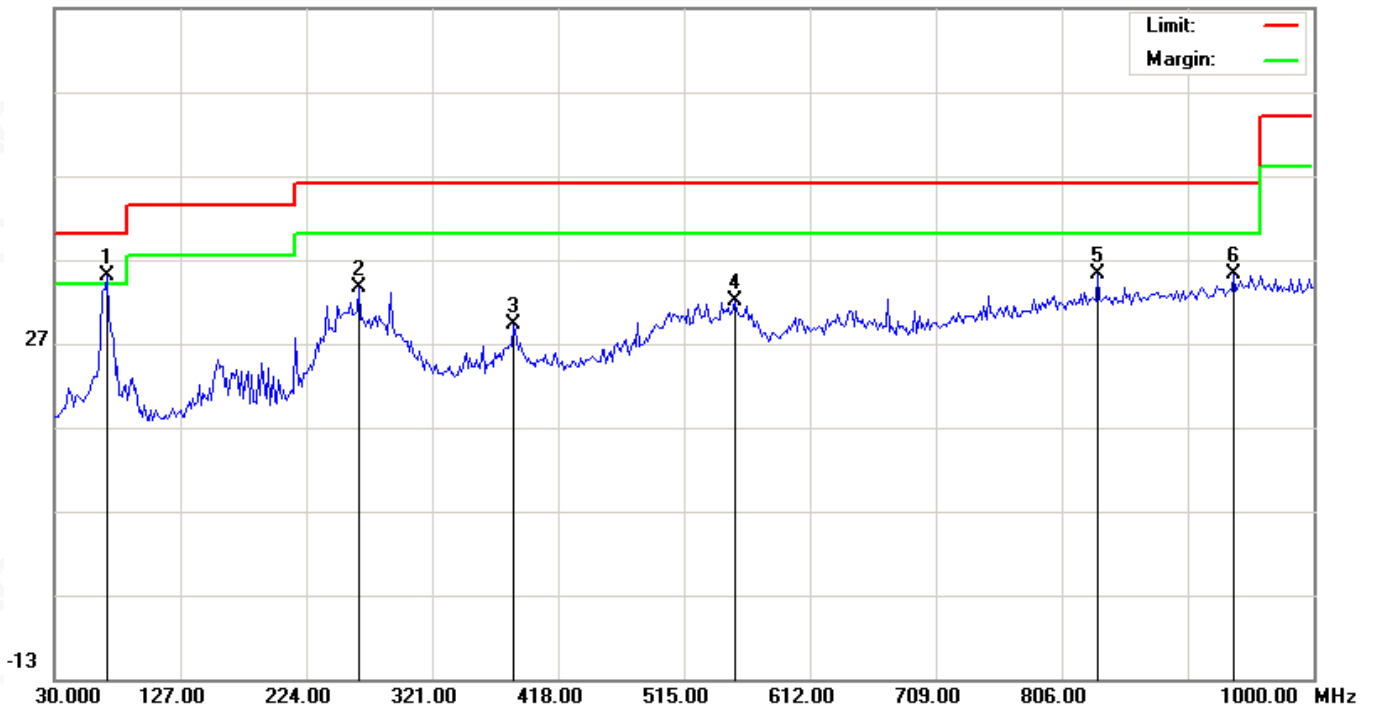

No.	Mk	Freq.	Reading	Factor	Measurement	Limit	Over	Detector	Antenna Height	Table Degree	Comment
		MHz	dBuV	dB/m	dBuV/m	dBuV/m	dB		cm	degree	
1	*	70.4167	18.00	17.02	35.02	40.00	-4.98	peak			
2		264.4166	14.95	18.67	33.62	46.00	-12.38	peak			
3		384.0500	6.74	22.42	29.16	46.00	-16.84	peak			
4		553.8000	5.88	26.04	31.92	46.00	-14.08	peak			
5		833.4833	4.36	30.84	35.20	46.00	-10.80	peak			
6		938.5667	3.10	32.03	35.13	46.00	-10.87	peak			

RESULT: PASS

Note: 1. Factor=Antenna Factor + Cable loss, Margin=Measurement-Limit.

2. All test modes had been pre-tested. The mode 4 is the worst case and recorded in the report.

3. When the test is discharged, the external audio accessories do not affect the test results, and the single EUT fixed-frequency emission result is the worst working condition.



Attestation of Global Compliance(Shenzhen)Co.,Ltd.

Add: 2/F., Building 2, No.1-4, Chaxi Sanwei Technial Industrial Park, Gushu, Xixiang, Bao'an District, Shenzhen, Guangdong, China

Tel: +86-755 2523 4088

E-mail: agc@agc-cert.com

Service Hotline:400 089 2118

RADIATED EMISSION ABOVE 1GHZ

EUT	Bluetooth Transmitter and Receiver	Model Name	BT03A
Temperature	25°C	Relative Humidity	55.4%
Pressure	960hPa	Test Voltage	Normal Voltage
Test Mode	Mode 1	Antenna	Horizontal

Frequency (MHz)	Meter Reading (dBµV)	Factor (dB)	Emission Level (dBµV/m)	Limits (dBµV/m)	Margin (dB)	Value Type
4804.022	50.29	0.08	50.37	74.00	-23.63	peak
4804.022	48.03	0.08	48.11	54.00	-5.89	AVG
7206.033	42.22	2.21	44.43	74.00	-29.57	peak
7206.033	41.01	2.21	43.22	54.00	-10.78	AVG

Remark:
Factor = Antenna Factor + Cable Loss – Pre-amplifier.

EUT	Bluetooth Transmitter and Receiver	Model Name	BT03A
Temperature	25°C	Relative Humidity	55.4%
Pressure	960hPa	Test Voltage	Normal Voltage
Test Mode	Mode 1	Antenna	Vertical

Frequency (MHz)	Meter Reading (dBµV)	Factor (dB)	Emission Level (dBµV/m)	Limits (dBµV/m)	Margin (dB)	Value Type
4804.022	51.95	0.08	52.03	74.00	-21.97	peak
4804.022	48.45	0.08	48.53	54.00	-5.47	AVG
7206.033	45.43	2.21	47.64	74.00	-26.36	peak
7206.033	42.00	2.21	44.21	54.00	-9.79	AVG

Remark:
Factor = Antenna Factor + Cable Loss – Pre-amplifier.



EUT	Bluetooth Transmitter and Receiver	Model Name	BT03A
Temperature	25°C	Relative Humidity	55.4%
Pressure	960hPa	Test Voltage	Normal Voltage
Test Mode	Mode 2	Antenna	Horizontal

Frequency (MHz)	Meter Reading (dBμV)	Factor (dB)	Emission Level (dBμV/m)	Limits (dBμV/m)	Margin (dB)	Value Type
4882.022	51.11	0.14	51.25	74.00	-22.75	peak
4882.022	46.20	0.14	46.34	54.00	-7.66	AVG
7323.033	42.89	2.36	45.25	74.00	-28.75	peak
7323.033	41.06	2.36	43.42	54.00	-10.58	AVG

Remark:

Factor = Antenna Factor + Cable Loss – Pre-amplifier.

EUT	Bluetooth Transmitter and Receiver	Model Name	BT03A
Temperature	25°C	Relative Humidity	55.4%
Pressure	960hPa	Test Voltage	Normal Voltage
Test Mode	Mode 2	Antenna	Vertical

Frequency (MHz)	Meter Reading (dBμV)	Factor (dB)	Emission Level (dBμV/m)	Limits (dBμV/m)	Margin (dB)	Value Type
4882.022	51.41	0.14	51.55	74.00	-22.45	peak
4882.022	49.49	0.14	49.63	54.00	-4.37	AVG
7323.033	46.39	2.36	48.75	74.00	-25.26	peak
7323.033	44.98	2.36	47.34	54.00	-6.66	AVG

Remark:

Factor = Antenna Factor + Cable Loss – Pre-amplifier.



Attestation of Global Compliance(Shenzhen)Co.,Ltd.

Add: 2/F., Building 2, No.1-4, Chaxi Sanwei Technial Industrial Park, Gushu, Xixiang, Bao'an District, Shenzhen, Guangdong, China

Tel: +86-755 2523 4088

E-mail: agc@agc-cert.com

Service Hotline:400 089 2118

EUT	Bluetooth Transmitter and Receiver	Model Name	BT03A
Temperature	25°C	Relative Humidity	55.4%
Pressure	960hPa	Test Voltage	Normal Voltage
Test Mode	Mode 3	Antenna	Horizontal

Frequency (MHz)	Meter Reading (dBμV)	Factor (dB)	Emission Level (dBμV/m)	Limits (dBμV/m)	Margin (dB)	Value Type
4960.022	50.20	0.22	50.42	74.00	-23.58	peak
4960.022	46.14	0.22	46.36	54.00	-7.64	AVG
7440.033	43.60	2.64	46.24	74.00	-27.76	peak
7440.033	28.36	2.64	31.00	54.00	-23.00	AVG

Remark:

Factor = Antenna Factor + Cable Loss – Pre-amplifier.

EUT	Bluetooth Transmitter and Receiver	Model Name	BT03A
Temperature	25°C	Relative Humidity	55.4%
Pressure	960hPa	Test Voltage	Normal Voltage
Test Mode	Mode 3	Antenna	Vertical

Frequency (MHz)	Meter Reading (dBμV)	Factor (dB)	Emission Level (dBμV/m)	Limits (dBμV/m)	Margin (dB)	Value Type
4960.022	51.42	0.22	51.64	74.00	-22.37	peak
4960.022	48.30	0.22	48.52	54.00	-5.48	AVG
7440.033	44.70	2.64	47.34	74.00	-26.66	peak
7440.033	42.51	2.64	45.15	54.00	-8.85	AVG

Remark:

Factor = Antenna Factor + Cable Loss – Pre-amplifier.

RESULT: PASS



Attestation of Global Compliance(Shenzhen)Co.,Ltd.

Add: 2/F., Building 2, No.1-4, Chaxi Sanwei Technial Industrial Park, Gushu, Xixiang, Bao'an District, Shenzhen, Guangdong, China

Tel: +86-755 2523 4088

E-mail: agc@agc-cert.com

Service Hotline:400 089 2118

Note:

1. Other emissions from 1G to 25 GHz are considered as ambient noise. No recording in the test report.
2. Factor = Antenna Factor + Cable loss - Amplifier gain, Over=Measure-Limit.

The "Factor" value can be calculated automatically by software of measurement system.

3. All test modes had been tested. The GFSK modulation is the worst case and recorded in the report.
4. When the test is discharged, the external audio accessories do not affect the test results, and the single EUT fixed-frequency emission result is the worst working condition.



Attestation of Global Compliance(Shenzhen)Co.,Ltd.

Add: 2/F., Building 2, No.1-4, Chaxi Sanwei Technial Industrial Park, Gushu,
Xixiang, Bao'an District, Shenzhen, Guangdong, China

Tel: +86-755 2523 4088

E-mail: agc@agc-cert.com

Service Hotline:400 089 2118