



360° Maximum Protection

Uniden®

R9
Owner's Manual

CUSTOMER CARE

At Uniden®, we care about you!

If you need assistance, please do NOT return this product to your place of purchase

Save your receipt/proof of purchase for warranty.

Quickly find answers to your questions by:

- Reading this User's Manual.
- Visiting our customer support website at www.uniden.com.

Images in this manual may differ slightly from your actual product.

DISCLAIMER: Radar detectors are illegal in some states. Some states prohibit mounting any object on your windshield. Check applicable law in your state and any state in which you use the product to verify that using and mounting a radar detector is legal. Uniden radar detectors are not manufactured and/or sold with the intent to be used for illegal purposes. Drive safely and exercise caution while using this product. Do not change settings of the product while driving. Uniden expects consumer's use of these products to be in compliance with all local, state, and federal law. Uniden expressly disclaims any liability arising out of or related to your use of this product.

CONTENTS

CUSTOMER CARE	2
R9 OVERVIEW	4
WHAT'S IN THE BOXES?	4
PARTS OF THE R9	7
KEYPAD	7
DISPLAY UNIT	10
R9 INSTALLATION OVERVIEW	11
MENU SYSTEM	13
BASIC OPERATIONS	13
MAINTENANCE	15
MAINTAINING THE EQUIPMENT	15
UPDATING THE FIRMWARE/DATABASE	15
UPDATE FIRMWARE	15
TROUBLESHOOTING	16
FCC/IC COMPLIANCE	17
FCC COMPLIANCE	17
IC COMPLIANCE	17
ONE-YEAR LIMITED WARRANTY	18

UNIDEN R9 LONG RANGE RADAR/LASER DETECTOR USER'S MANUAL

R9 OVERVIEW





Uniden's R9 is an advanced installed laser radar detector with actual laser interruption capability. It provides outstanding detection range and usability.







WHAT'S IN THE BOXES?

The R9 packup consists of three boxes.



NOTE: Each box contains packets of screws and other assorted hardware and are not called out specifically in the following tables.







Box 1 contains:

What it is	What it looks like	What it does
Controller		Provides power to the R9 elements. Color coded tabs indicate where each element connects to the Controller.
Keypad		Control the menu as well as adjusts and mutes volume and alarms, user marks, and backlight.
Display		Provides the visual display for alarms, alerts, frequencies, and menu selections. LEDs on the right side indicate the signal direction.
GPS		Tracks vehicle location related to GPS database for red light cameras, speed cameras, etc.

What it is	What it looks like	What it does
Speaker		Provides audio output for alarms and alerts, etc.
Active Alert LED		Incoming signal indicator. (Red = signal coming from front; Blue = signal coming from rear; Green = all clear). Usually mounted in speedometer area or area within line of sight. LED mounting bracket is already installed.
Radio Mute Cable		Mutes the radio when an alarm or alert sounds.
Display Bezel		Provides protection to the Display when installed.
Double-Sided Adhesive Tapes		Adheres equipment and cabling to surfaces.
USB Memory Stick		Contains Owner's Manual. Also used to transfer firmware updates from website to R9.







Box 2 contains:

What it is	What it looks like	What it does
Front Remote Radar		Radar Detector
Adjustable Mounting Clamps (2)		The clamps mount on the side of the Remote Radar and connect the Remote Radar to the vehicle.

What it is	What it looks like	What it does
Mounting Bracket and Screws for Remote Radar		Multiple brackets and screws to mount front Remote Radar according to different vehicle configurations.
Laser Distribution Box		Connects transponders to main interface.
Hex wrench		Use with various screws for installation.
Transponder (2)		Detects specific laser signals.
Double-Sided Adhesive Tapes		Adheres equipment and cabling to surfaces.
Cable Ties		Ties loose cables together.
Bubble Level		Levels the transponder interfaces and remote radars during installation.

Box 3 contains:

What it is	What it looks like	What it does
Rear Remote Radar		Radar Detector

What it is	What it looks like	What it does
Mounting Bracket and Screws for Remote Radar		Multiple brackets and screws to mount rear Remote Radar according to different vehicle configurations.
Transponder Interfaces (2)		Detects specific laser signals.
Double-Sided Adhesive Tapes		Adheres equipment and cabling to surfaces.
Cable Ties		Ties loose cables together.
Extension Cables for Remote and Transponder (3)		Provides extra cable length if needed.
Adjustable Mounting Clamps (2)		The clamps mount on the side of the Remote Radar and connect the Remote Radar to the vehicle.

PARTS OF THE R9

This section describes only the R9 parts that are user-accessible. It does not discuss any parts installed outside of the vehicle cabin.

KEYPAD

The keypad should be installed within the driver's reach but not high on the dashboard. The keys on the keypad control the menu as well as adjusts the volume, alarms, user marks, and backlight.



KEY	PRESS TO...	PRESS AND HOLD TO ...
PWR	Turn R9 on.	Turn R9 off.
VOL +	Turn volume up (9 levels: 0 - 8; Default = 4). There is one beep and a volume up display. In Menus, go to next item.	NA
VOL -	Turn volume down (9 levels: 0 - 8; Default = 4). There is one beep and a volume down display. In Menus, go to previous item.	
MENU	Access the Menu system. In Menus, press to cycle through options for the current menu item.	When in standby mode, changes modes between Highway, City, Auto City and Advanced.
MARK	User Mark. A User Mark is a manually tagged geographic location where an alarm is usually found. The R9 alerts when close to these User Marks. <i>Add - Press MARK</i> when you are at the alarm location. <i>Delete - Press MARK</i> when you are at an alarm location that has been marked. An error message displays/sounds if memory is full or there is a GPS error.	Delete all User Marks (press and hold for 3 seconds).

KEY	PRESS TO...	PRESS AND HOLD TO ...
<p>MUTE/ DIM</p>	<ul style="list-style-type: none"> • Turn MUTE on and off. • MUTE on - Press MUTE/DIM to mute radar, laser, red-light cameras, and overspeed alarms. Return to normal operation 10 seconds after the alert ends or if a different band is detected during Mute mode. <i>Mute On</i> displays for a few seconds. • MUTE off - Press MUTE/DIM to restore audible alarms before the 10 second automatic mute time-out. <p>MUTE MEMORY</p> <p>Save a Mute Location (Mute Memory) - press MUTE/DIM again while <i>Mute On</i> displays to save that GPS location and frequency to memory. <i>Mute Memory</i> displays on the screen.</p> <p style="text-align: center;">NOTE: R9 stores 2000 points divided between Mute Memory and User Mark locations.</p> <p>Delete Mute Memory - Press MUTE/DIM while <i>Mute Memory</i> displays; the R9 displays a delete confirmation message. Press MUTE/DIM again to confirm.</p> <p>MUTE RED LIGHT CAMERA VOICE ALERTS</p> <p>Mute the voice alert for a red light camera alarm. Press MUTE/DIM while the voice alarm for a red light camera sounds. The voice alarm mutes.</p> <p>MUTE ALERTS FOR POI OVERSPEED ALERT AND USER LIMIT SPEED</p> <p>When R9 alerts you to an overspeed or speed limit situation (an alarm sounds and an alert displays), press MUTE/DIM to silence that alarm.</p>	<p>DIM - Changes the display brightness:</p> <ul style="list-style-type: none"> • Auto (Default). Set brightness levels for the OLED display (see page 22). • Bright • Dim • Dimmer • Dark (Dark is off unless there is alert.) • Off (Off regardless of whether or not there is an alert.) <p>DELETE RED-LIGHT CAMERA POINT</p> <p>During a red-light camera alert, press and hold MUTE/DIM to delete the red light camera point. A confirmation message displays.</p> <p>After confirming this deletion, R9 will not give an alert for that camera.</p>

DISPLAY UNIT



The separate display unit installed in the dashboard is the visual display for alarms, alerts, and menu selections. It also displays from which direction the signals are coming.



NOTE: If GPS = ON, the OLED's left display area shows the display selected in the menus. If GPS = Off, the OLED's left display area shows Volt regardless of user settings.

The following table provides examples of the most common displays.

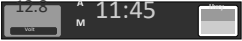
OLED EXAMPLES	MEANING
<p>Scanning for Frequencies</p> <p>Displays to indicate end of a scan cycle.</p>	<p>Information displayed in example:</p> <ul style="list-style-type: none"> • Current speed in mph/km/h. • Highway/City/Auto City/Advanced • Scanning line
<p>Frequency Found</p>	<p>Information displayed:</p> <ul style="list-style-type: none"> • Band Type (X, K, KA, MRCD, Gatso RT3/4) • Frequency number • Band direction • Frequency strength indicators
<p>Speed Camera Alert</p>	<p>Information displayed:</p> <ul style="list-style-type: none"> • Current speed in mph/km/h. • Distance to speed camera • Speed camera icon
<p>Red Light Camera Alert</p>	<p>Information displayed:</p> <ul style="list-style-type: none"> • Current speed in mph/km/h • Distance to red light camera • Red light camera icon

OLED EXAMPLES	MEANING
<p>User Mark Detected</p> 	<p>Information displayed:</p> <ul style="list-style-type: none"> • Current speed in mph/km/h • Distance to user mark • User mark icon
<p>Time Display</p> 	<p>Information displayed:</p> <ul style="list-style-type: none"> • Voltage • Time and AM/PM • Highway/City/Advanced
<p>Red Light Camera - Quiet Ride</p> 	<p>Information displayed:</p> <ul style="list-style-type: none"> • Current speed in mph/km/h • Distance to red light camera • Red light camera icon
<p>Dark Mode</p> 	<p>Set mode to Dark if the unit's OLED is not anticipated to change a lot to prevent image burn-in (<i>Auto Dim</i> setting).</p> <p>In Dark mode, the OLED is dark with a single white dot in the lower corner that moves from bottom left to center to bottom right. The movement of the dot confirms that the unit is still powered up.</p>

R9 INSTALLATION OVERVIEW

This installation overview is a general look at the R9 elements and how they work together. Where these elements are physically installed can vary from vehicle to vehicle. Your professional installer will know best where to install each one according to your vehicle's physical layout.

This illustration shows the R9 basic element placement.

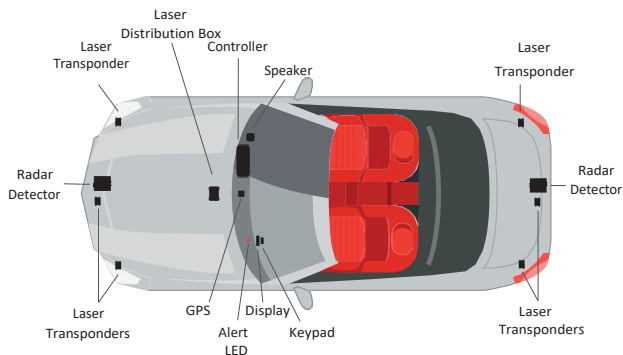

The Controller is the brain of the R9 system. It provides power to and communications between the elements that attach to it.

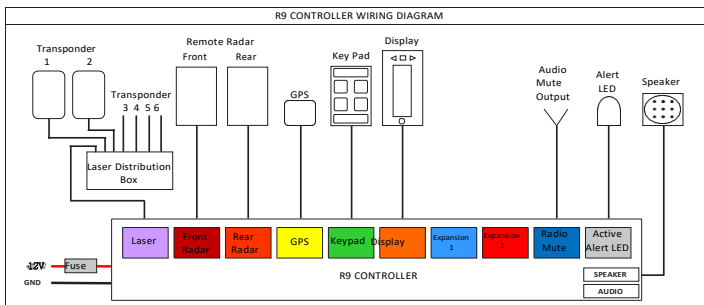

R9 Controller Specification

- Rating : DC 12 V, 2A [power requirements : DC 11 – 16 V]
- Operating Temperature Range : -10 ° to +70 °
- Storage Temperature Range : -30 ° to +95 °
- Dimensions HxWxL : 24 mm x 62.5 mm x 156 mm
- Weight : 145 g
- Frequency : 2 402 ~ 2 480 MHz [Bluetooth]

MENU SYSTEM

Menus let you set up the system to your own specifications. You can turn different bands on and off set specific items such as red-light camera alarms or auto mute.

Press **MENU** on the keypad to access the Menu system. The screen displays the selection's current status.

Use the following keys to navigate the menus:

- **MENU**: Change a menu item setting (press and hold to exit the Menu system).
- **VOL +** : Go to the next Menu item.
- **VOL -** : Go to the previous Menu item.

NOTE: Several menu items only display if GPS is set to ON.

BASIC OPERATIONS

HOW DO I ...?	TRY THIS...
Turn on the R9	Be sure the unit is connected to power and then press PWR . The unit turns on and runs through an initial self-check if Self Test is turned on. It displays the different bands and their settings. The R9 turns on automatically when you start the vehicle.
Adjust the volume	Press VOL + to increase volume. The unit beeps and displays a number increase. Press VOL - to decrease volume. The unit beeps and displays a number decrease.

Mute alarm audio during the alert	Press MUTE/DIM during an audio alarm to mute it.
Change the screen's brightness	Press and hold MUTE/DIM . The unit displays the current brightness level. Press MUTE/DIM again. The R9 announces the brightness level (Bright, Dim, Dimmer, Dark, or Off) as it changes to that level.
Turn bands on and off	Press MENU then VOL + to cycle through the menu options until the band you want to turn off displays. Press MENU again to change that band's status.

HOW DO I ...?	TRY THIS...
Change Highway to City or Auto city mode or set attenuation levels in Advanced mode and back	Press MENU . The first menu selection is Highway (default). Press MENU to cycle through <i>Highway</i> , <i>City</i> , <i>Auto City</i> and <i>Advanced</i> . After you select <i>Highway</i> or <i>City</i> , press and hold MENU to exit. If you select <i>Advanced</i> , press VOL + to select either the K or Ka band to adjust. Press MENU to adjust sensitivity levels in 10% increments. Press VOL + again to adjust the other mode. if you select Auto City, press VOL + to select Auto City Speed.
Set a user mark	Press MARK to create a user mark when you are at a location where there is normally some type of radar. The R9 announces "User mark logged." The R9 will announce when you approach user marks. NOTE: R9 stores 2000 points divided between Mute Memory and User Mark locations.
Delete a user mark	Press MARK again at that location to delete the user mark. NOTE: R9 stores 2000 points divided between Mute Memory and User Mark locations.
Delete ALL user marks	Press and hold MARK to delete all user marks. The R9 does NOT ask for confirmation before deleting single user marks.
Allocate dynamic memory points between Mute Memory and User Marks	Press MENU and then VOL + to scroll to the <i>Memory Quota</i> menu. Press MENU to select it and press VOL - and VOL + to change the allocation in 50 point increments. See page 27 for details.
Update the firmware and database	<ol style="list-style-type: none"> 1. Save the Update file to the USB drive. 2. Turn R9 off. Insert USB drive into the Controller. Turn R9 back on. 3. R9 will automatically update. Refer to www.unidensupport.com for details.

MAINTENANCE

MAINTAINING THE EQUIPMENT

The R9 requires very little physical maintenance. Wipe the keypad and display with a soft cloth to keep dust from accumulating.

UPDATING THE FIRMWARE/DATABASE

Uniden recommends that you update your R9 firmware and database periodically. Go to www.unidensupport.com/radar-detectors/, find your model, and check if you have the latest firmware. For the R9, load the new update onto the included USB stick. Insert the USB stick into the Controller and restart the system.

UPDATE FIRMWARE

Uniden recommends that you update your R9 firmware and database periodically. Go to www.unidensupport.com/radar-detectors/, find your model, and check if you have the latest firmware. For the R9, load the new update onto the included USB stick. Insert the USB stick into the Controller and restart the system.

1. Check your current R9 firmware version (*Menu/SW Version*).
2. Check online for updated firmware (<https://support.uniden.com/radar-detectors/>)
3. If your R9 needs to be updated to the latest firmware, follow the online instructions and copy the new firmware onto a USB drive.
4. Turn off the vehicle/R9. Insert memory stick into the Controller. Turn vehicle/R9 back on. Scanner will update automatically.

TROUBLESHOOTING

If...	TRY THIS...
The unit won't turn on	Check the connections. Be sure they are all secure.
No display or audio.	If no display, check the connections. Be sure they are all secure. If no audio, check if Voice is turned off.
The unit alarms when the vehicle hits bumps.	Check the connections. Be sure they are all secure.
The unit alarms briefly in the same location but no radar source was in view.	There may be a motion sensor or house alarm in use within range.
The R9 did not alert when a police car was in view.	The officer may not have radar/laser units turned on. Check that the band is turned on. Press MENU and cycle through the options to get to the bands. If the band is turned off, the OLED will show OFF. Turn the band on.
R9 audible alerts become softer after the first few alerts	R9 is in Auto Mute mode. See page 21.
The PowerOn sequence starts when you are driving.	A loose connection can cause the unit to restart. Check the connections and re-secure if needed.
The display is blank.	The display is in Dark mode. Press and hold MUTE/DIM button to adjust the screen brightness.

FCC/IC COMPLIANCE

Contains FCC ID : W75-BTM0

FCC COMPLIANCE

This device complies with Part 15 of the FCC rules. Operation is subjected to the following two conditions: (1) this device may not cause harmful interference, and (2) this device must accept any interference received, including interference that may cause undesired operation.

Changes or modifications not expressly approved by the party responsible for compliance could void your authority to operate the equipment.

Avis de conformité à la FCC : Ce dispositif a été testé et s'avère conforme à l'article 15 des règlements de la Commission fédérale des communications (FCC). Ce dispositif est soumis aux conditions suivantes: 1) Ce dispositif ne doit pas causer d'interférences nuisibles et; 2) Il doit pouvoir supporter les parasites qu'il reçoit, incluant les parasites pouvant nuire à son fonctionnement.

Tout changement ou modification non approuvé expressément par la partie responsable pourrait annuler le droit à l'utilisateur de faire fonctionner cet équipement.

FCC Interference Statement

This equipment has been tested and found to comply with the limits for a Class A digital device, pursuant to part 15 of the FCC Rules. These limits are designed to provide reasonable protection against harmful interference when the equipment is operated in a commercial environment. This equipment generates, uses, and can radiate radio frequency energy and, if not installed and used in accordance with the instruction manual, may cause harmful interference to radio communications. Operation of this equipment in a residential area is likely to cause harmful interference in which case the user will be required to correct the interference at his own expense.

FCC Radiation Exposure Statement

This equipment complies with FCC radiation exposure limits set forth for an uncontrolled environment. This equipment should be installed and operated with minimum distance 20 cm between the radiator and your body. This transmitter must not be co-located or operating in conjunction with any other antenna or transmitter.

IC COMPLIANCE

This device complies with Industry Canada license-exempt RSS standard(s). Operation is subject to the following two conditions: (1) this device may not cause interference, and (2) this device must accept any interference, including interference that may cause undesired operation of the device.

Changes or modifications not expressly approved by the party responsible for compliance could void your authority to operate the equipment.

Cet appareil est conforme aux normes RSS exemptes de licences d'Industrie Canada. Son fonctionnement est soumis aux deux conditions suivantes : (1) cet appareil ne doit pas causer d'interférences nuisibles et (2), il doit pouvoir accepter les interférences, incluant celles pouvant nuire à son fonctionnement normal.

Tout changement ou modification non approuvé expressément par la partie responsable pourrait annuler le droit à l'utilisateur de faire fonctionner cet équipement.

ONE-YEAR LIMITED WARRANTY

Keep your receipt! Proof of purchase is required for warranty service.

WARRANTOR: UNIDEN AMERICA CORP. (“UNIDEN”).

ELEMENTS OF WARRANTY: Uniden warrants, for one year, to the original retail owner, this Uniden Product to be free from defects in materials and craftsmanship with only the limitations or exclusions set out below.

WARRANTY DURATION: This warranty to the original user shall terminate and be of no further effect 12 months after the date of original retail sale. The warranty is invalid if the Product is (A) damaged or not maintained as reasonable or necessary, (B) modified, altered, or used as part of any conversion kits, subassemblies, or any configurations not sold by Uniden, (C) improperly installed, (D) serviced or repaired by someone other than an authorized Uniden service center for a defect or malfunction covered by this warranty, (E) used in any conjunction with equipment or parts or as part of any system not manufactured by Uniden, or (F) installed or programmed by anyone other than as detailed by the Operating Guide for this product.

STATEMENT OF REMEDY: In the event that the product does not conform to this warranty at any time while this warranty is in effect, warrantor will repair the defect and return it to you without charge for parts, service, or any other cost (except shipping and handling) incurred by warrantor or its representatives in connection with the performance of this warranty. **THE LIMITED WARRANTY SET FORTH ABOVE IS THE SOLE AND ENTIRE WARRANTY PERTAINING TO THE PRODUCT AND IS IN LIEU OF AND EXCLUDES ALL OTHER WARRANTIES OF ANY NATURE WHATSOEVER, WHETHER EXPRESS, IMPLIED OR ARISING BY OPERATION OF LAW, INCLUDING, BUT NOT LIMITED TO ANY IMPLIED WARRANTIES OF MERCHANTABILITY OR FITNESS FOR A PARTICULAR PURPOSE. THIS WARRANTY DOES NOT COVER OR PROVIDE FOR THE REIMBURSEMENT OR PAYMENT OF INCIDENTAL OR CONSEQUENTIAL DAMAGES.** Some states do not allow this exclusion or limitation of incidental or consequential damages so the above limitation or exclusion may not apply to you.

LEGAL REMEDIES: This warranty gives you specific legal rights, and you may also have other rights which vary from state to state. This warranty is void outside the United States of America.

PROCEDURE FOR OBTAINING PERFORMANCE OF WARRANTY: If, after following the instructions in this Operating Guide, you are certain that the Product is defective, pack the Product carefully (preferably in its original packaging). Include evidence of original purchase and a note describing the defect that has caused you to return it. The Product should be shipped freight prepaid, by traceable means, or delivered, to warrantor at:

Uniden America Corporation
C/O Saddle Creek
743 Henrietta Creek Rd., Suite 100
Roanoke, TX 76262