



243 Jubug-Ri, Yangji-Myeon, Yongin-Si, Gyeonggi-Do, Korea 449-822
 Tel: +82-31-323-6008 Fax: +82-31-323-6010
<http://www.ltalab.com>

Dates of Tests: December 01 ~ 06, 2016
 Test Report S/N: LR500111612D
 Test Site : LTA CO., LTD.

CERTIFICATION OF COMPLIANCE

FCC ID.	W6YHP100
APPLICANT	PASSTECH CO., LTD

Equipment Class	:	Digital Transmission System (DTS)
Manufacturing Description	:	Hotel Door locks
Manufacturer	:	PASSTECH CO., LTD
Model name	:	HP100
Test Device Serial No.:	:	Identical prototype
Rule Part(s)	:	FCC Part 15.247 Subpart C ; ANSI C-63.4-2014
Frequency Range	:	2405 ~ 2475 MHz (Zigbee) 2420 MHz (BLE Single channel)
Max. Output Power	:	Max -7.18 dBm – Conducted (Zigbee) Max -0.29 dBm – Conducted (BLE Single channel)
Data of issue	:	December 7, 2016

This test report is issued under the authority of:

Yong-Cheol, Wang / Manager

The test was supervised by:

Young-jin Lee, Test Engineer

This test result only responds to the tested sample. It is not allowed to copy this report even partly without the allowance of the test laboratory. The report must not be used by the client to claim product certification, approval, or endorsement by NVLAP, NIST, or any agency of the Federal Government.



NVLAP LAB Code.: 200723-0

TABLE OF CONTENTS

1. GENERAL INFORMATION	-----	3
2. INFORMATION ABOUT TEST ITEM	-----	4
3. TEST REPORT	-----	5
3.1 SUMMARY OF TESTS	-----	5
3.2 TECHNICAL CHARACTERISTICS TEST	-----	6
3.2.1 6 dB BANDWIDTH	-----	6
3.2.2 PEAK OUTPUT POWER	-----	9
3.2.3 POWER SPECTRAL DENSITY	-----	12
3.2.4 BAND EDGE	-----	15
3.2.5 CONDUCTED SPURIOUS EMISSIONS	-----	19
3.2.6 RADIATED SPURIOUS EMISSIONS	-----	22
3.2.7 AC Conducted Emissions	-----	31
APPENDIX		
APPENDIX TEST EQUIPMENT USED FOR TESTS	-----	32

1. General information

1-1 Test Performed

Company name : LTA Co., Ltd.
 Address : 243, Jubug-ri, Yangji-Myeon, Youngin-Si, Kyunggi-Do, Korea. 449-822
 Web site : <http://www.ltalab.com>
 E-mail : chahn@ltalab.com
 Telephone : +82-31-323-6008
 Facsimile : +82-31-323-6010

Quality control in the testing laboratory is implemented as per ISO/IEC 17025 which is the “General requirements for the competents of calibration and testing laboratory”.

1-2 Accredited agencies

LTA Co., Ltd. is approved to perform EMC testing by the following agencies:

Agency	Country	Accreditation No.	Validity	Reference
NVLAP	U.S.A	200723-0	2017-09-30	ECT accredited Lab.
RRA	KOREA	KR0049	-	EMC accredited Lab.
FCC	U.S.A	610755	2017-04-21	FCC filing
FCC	U.S.A	649054	2017-04-13	FCC CAB
VCCI	JAPAN	R2133(10 m), C2307	2017-06-21	VCCI registration
VCCI	JAPAN	T-2009	2016-12-23	VCCI registration
VCCI	JAPAN	G-563	2018-12-13	VCCI registration
IC	CANADA	5799A-1	UPDATING	IC filing
KOLAS	KOREA	NO.551	2017-01-08	KOLAS accredited Lab.

2. Information about test item

2-1 Client & Manufacturer

Company name : PASSTECH CO., LTD
 Address : No. B-402, Geumgang Pentierium IT Tower, 215, Galmachi-ro, Jungwon-gu, Seongnam-si, Gyeonggi-do, 13217 Rep. of KOREA
 Tel / Fax : TEL No : +82-31-743-7277 / FAX No : +82-31-743-7276

2-2 Equipment Under Test (EUT)

Trade name : Hotel Door locks
 Model name : HP100
 Serial number : Identical prototype
 Date of receipt : March 4, 2016
 EUT condition : Pre-production, not damaged
 Antenna type : Chip Antenna (Max Gain : 3.5 dBi)_Zigbee
 Chip Antenna (Max Gain : 3.5 dBi)_BLE Single channel
 Frequency Range : 2405 ~ 2475 MHz _Zigbee
 2420 MHz _BLE Single channel
 RF output power : Max -7.18 dBm – Conducted _Zigbee
 Max -0.29 dBm – Conducted _BLE Single channel
 Number of channels : 15 _Zigbee
 1 _BLE Single channel
 Type of Modulation : O-QPSK _Zigbee
 GFSK _BLE Single channel
 Power Source : 6.0 Vdc

2-3 Tested frequency

	LOW	MID	HIGH
Frequency (MHz)	2405	2440	2475
Frequency (MHz)	-	2420	-

2-4 Ancillary Equipment

Equipment	Model No.	Serial No.	Manufacturer
-	-	-	-

3. Test Report

3.1 Summary of tests

FCC Part Section(s)	Parameter	Limit	Test Condition	Status (note 1)
15.247(a)	6 dB Bandwidth	> 500 kHz	Conducted	C
15.247(b)	Transmitter Peak Output Power	< 1 Watt		C
15.247(d)	Transmitter Power Spectral Density	< 8 dBm @ 3 kHz		C
15.247(d)	Band Edge	> 20 dBc		C
15.209	Field Strength of Harmonics	Emission	Radiated	C
15.207	AC Conducted Emissions	Emissions	Conducted	N/A
15.203	Antenna requirement	-	-	C

Note 1: C=Complies NC=Not Complies NT=Not Tested NA=Not Applicable

Note 2: The data in this test report are traceable to the national or international standards.

The above equipment was tested by LTA Co., Ltd. The test data, data evaluation, test procedures, and equipment configurations shown in this report were made in accordance with the procedures given in ANSI C63.10-2013 and the energy emitted by the sample EUT tested as described in this report is in compliance with the requirements of FCC Rules Part 2 and Part 15.247 The test results of this report relate only to the tested sample identified in this report.

→ Antenna Requirement

The PASSTECH CO., LTD FCC ID: W6YPT300 unit complies with the requirement of §15.203.

The antenna type is Chip Antenna.

3.2 Technical Characteristics Test

3.2.1 6 dB Bandwidth

Procedure:

The bandwidth at 6 dB below the highest in-band spectral density was measured with a spectrum analyzer connected to the antenna terminal, while EUT is operating in transmission mode at the appropriate frequencies.

After the trace being stable, Use the marker-to-peak function to set the marker to the peak of the emission. Use the marker-delta function to measure 6 dB down one side of the emission. Reset the marker-delta function, and move the marker to the other side of the emission, until it is (as close as possible to) even with the reference marker level. The marker-delta reading at this point is the 6 dB bandwidth of the emission.

The spectrum analyzer is set to:

Center frequency = the highest, middle and the lowest channels

RBW = 100 kHz

Span = 5 MHz

VBW = 100 kHz (VBW ≥ RBW)

Sweep = auto

Trace = max hold

Detector function = peak

Measurement Data : Complies

Frequency (MHz)	Test Results	
	Measured Bandwidth (MHz)	Result
2405_Zigbee	1.61	Complies
2440_Zigbee	1.61	Complies
2475_Zigbee	1.60	Complies
2420_BLE Single channel	0.94	Complies

- See next pages for actual measured spectrum plots.

Minimum Standard:

6 dB Bandwidth > 500 kHz

Measurement Setup

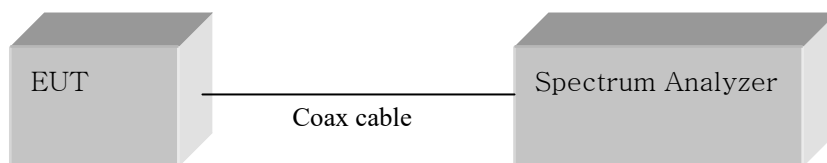
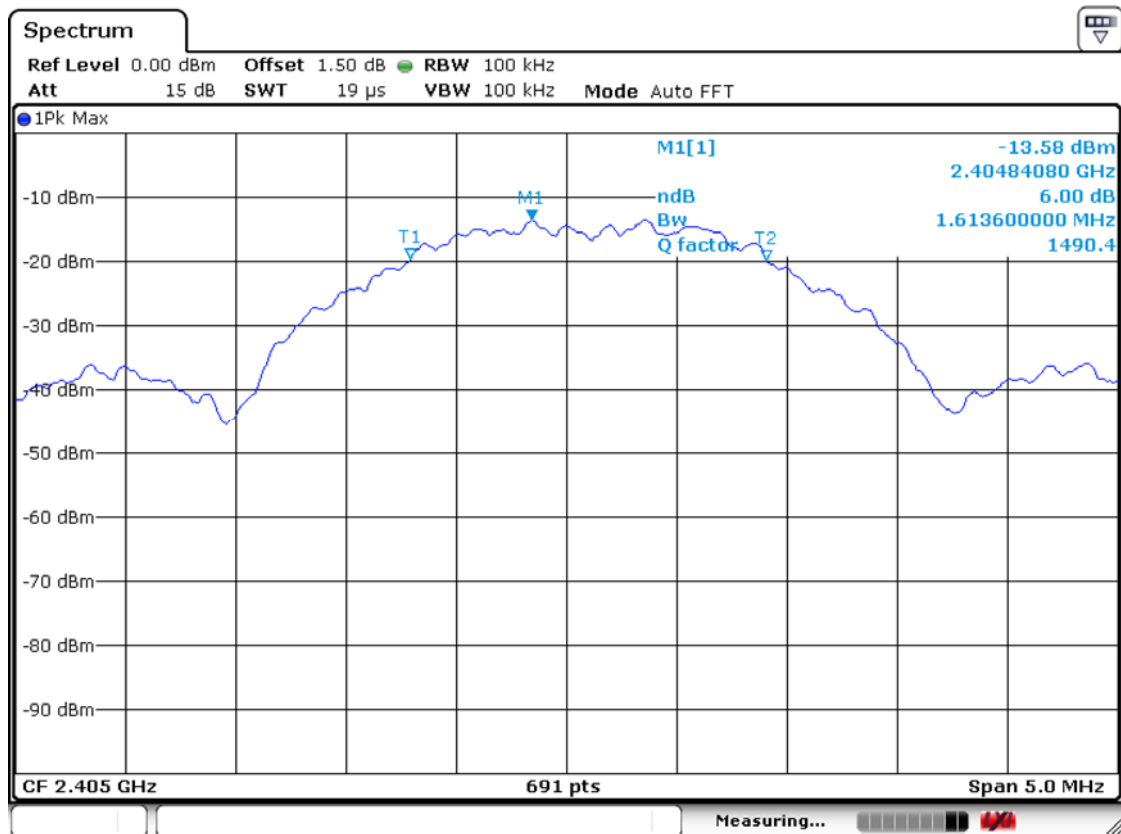
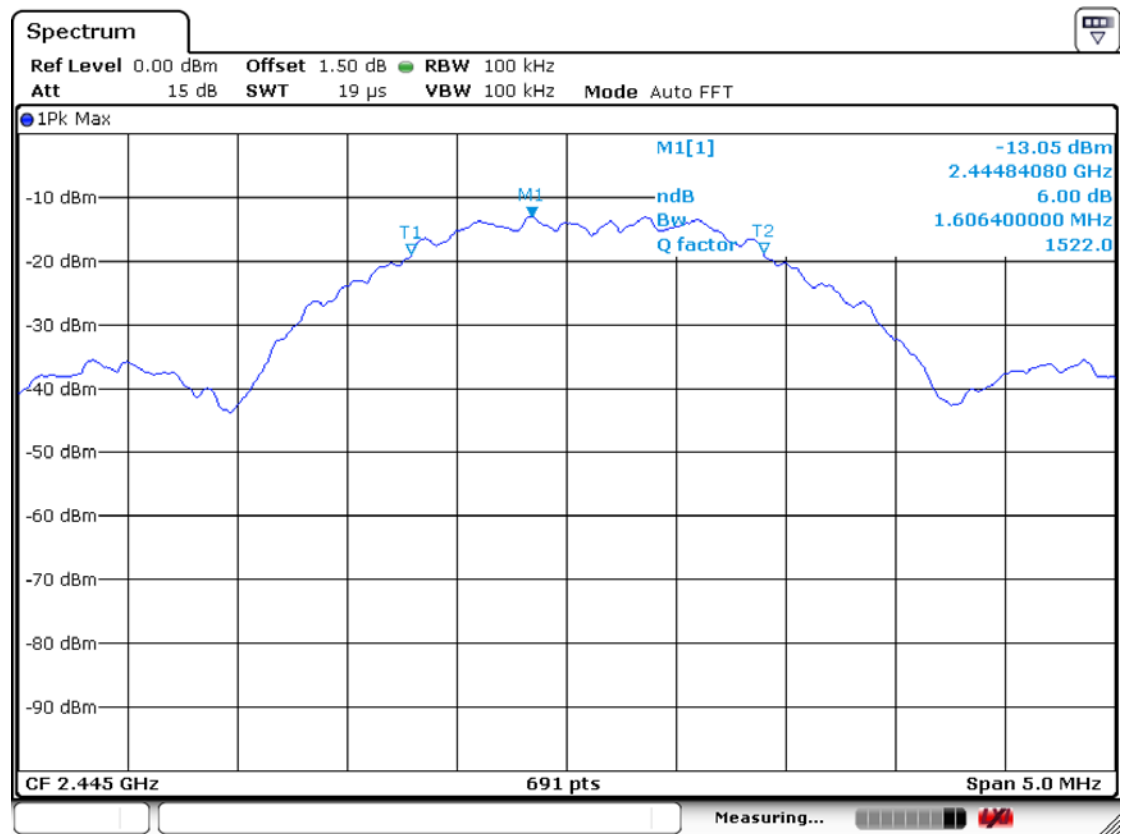

Figure 1: Measurement setup for the carrier frequency separation

Low Channel_Zigbee



Middle Channel_Zigbee



High Channel_Zigbee

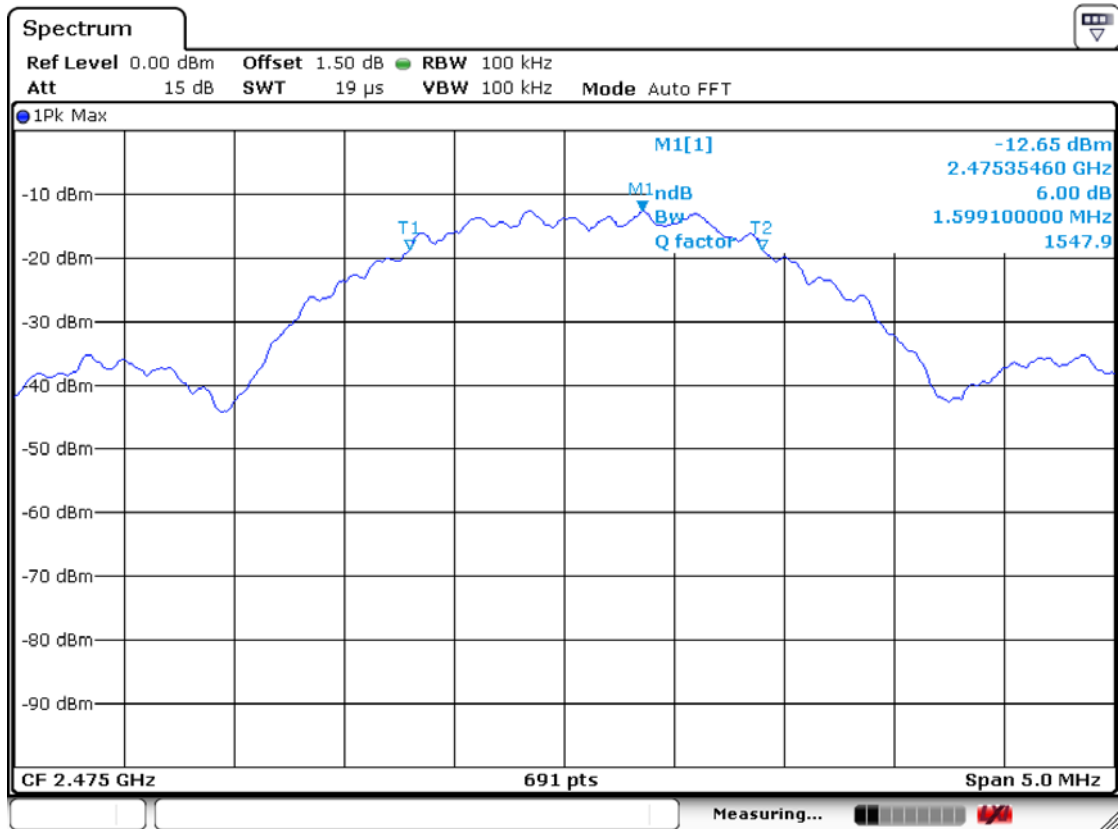

BLE Single channel

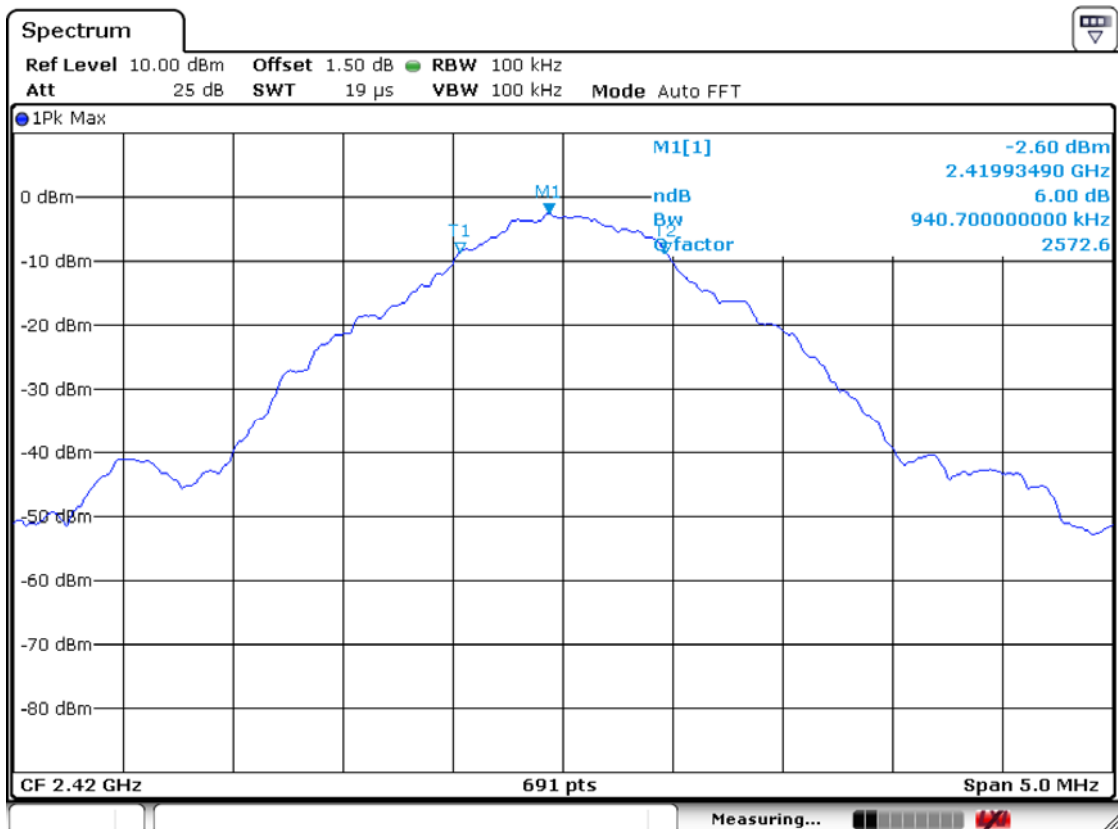

3.2.2 Peak Output Power Measurement

Procedure:

The maximum peak output power was measured with the spectrum analyzer connected to the antenna output of the EUT. The spectrum analyzer's internal channel power integration function is used to integrate the power over a bandwidth greater than or equal to the 99 % bandwidth. The EUT was operating in transmit mode at the appropriate center frequency.

The spectrum analyzer is set to:

Center frequency = the highest, middle and the lowest channels

RBW = 1 MHz

Span = auto

VBW = 1 MHz (VBW \geq RBW)

Sweep = auto

Detector function = peak

Measurement Data : **Complies**

Frequency (MHz)	Test Results		
	dBm	mW	Result
2405_Zigbee	-7.99	0.16	Complies
2440_Zigbee	-7.61	0.17	Complies
2475_Zigbee	-7.18	0.19	Complies
2420_BLE Single channel	-0.29	0.94	Complies

- See next pages for actual measured spectrum plots.

Minimum Standard:

Peak output power	< 1 W
-------------------	-------

Measurement Setup

Same as the Chapter 3.2.1 (Figure 1)

Low Channel

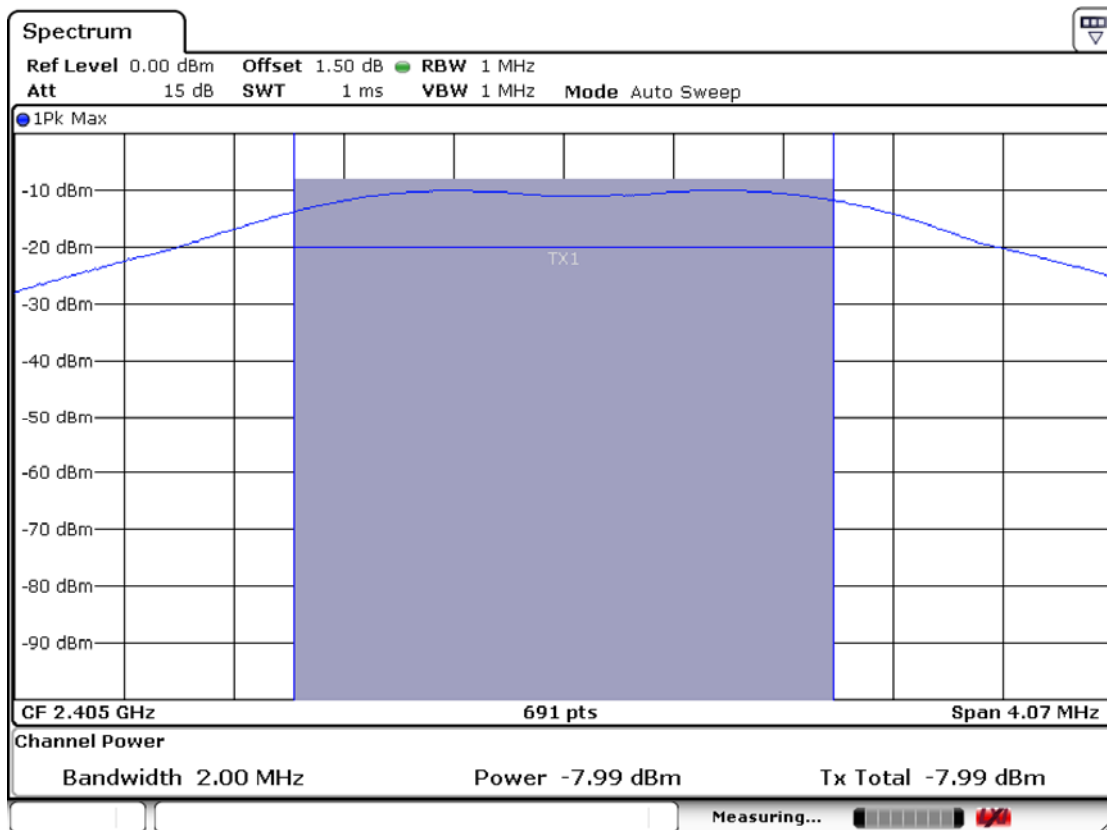

Middle Channel

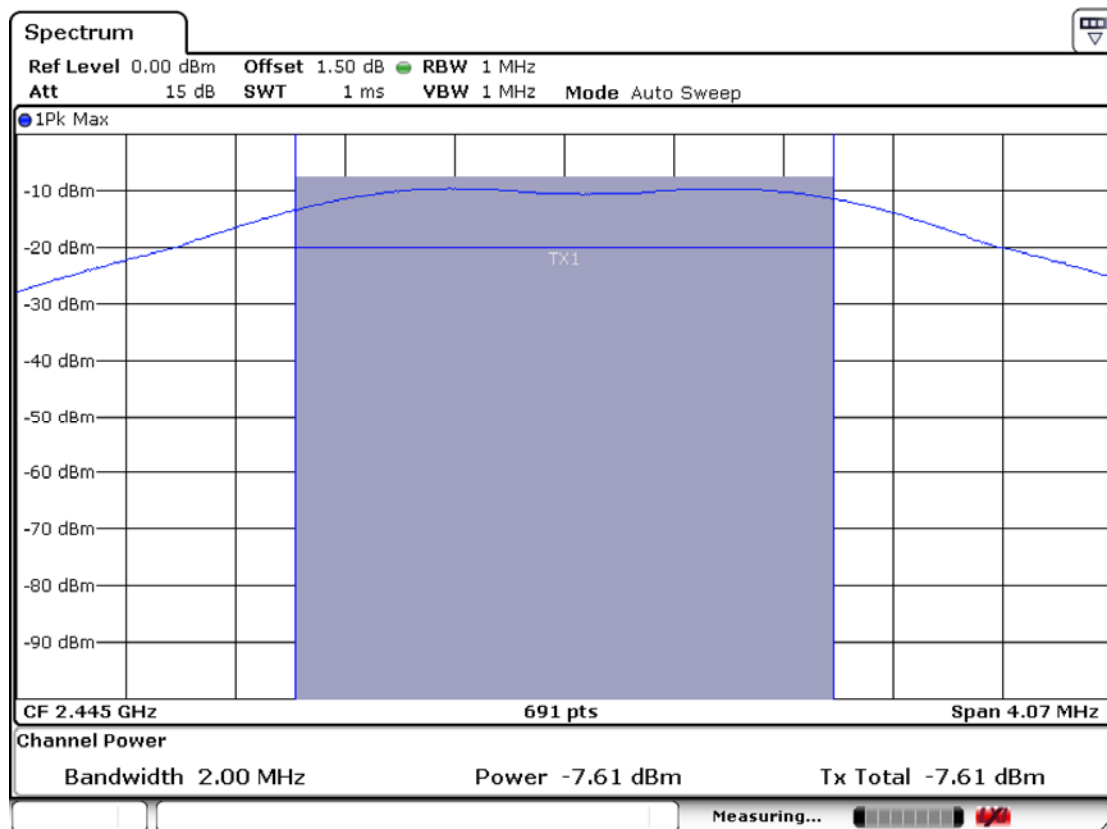

High Channel

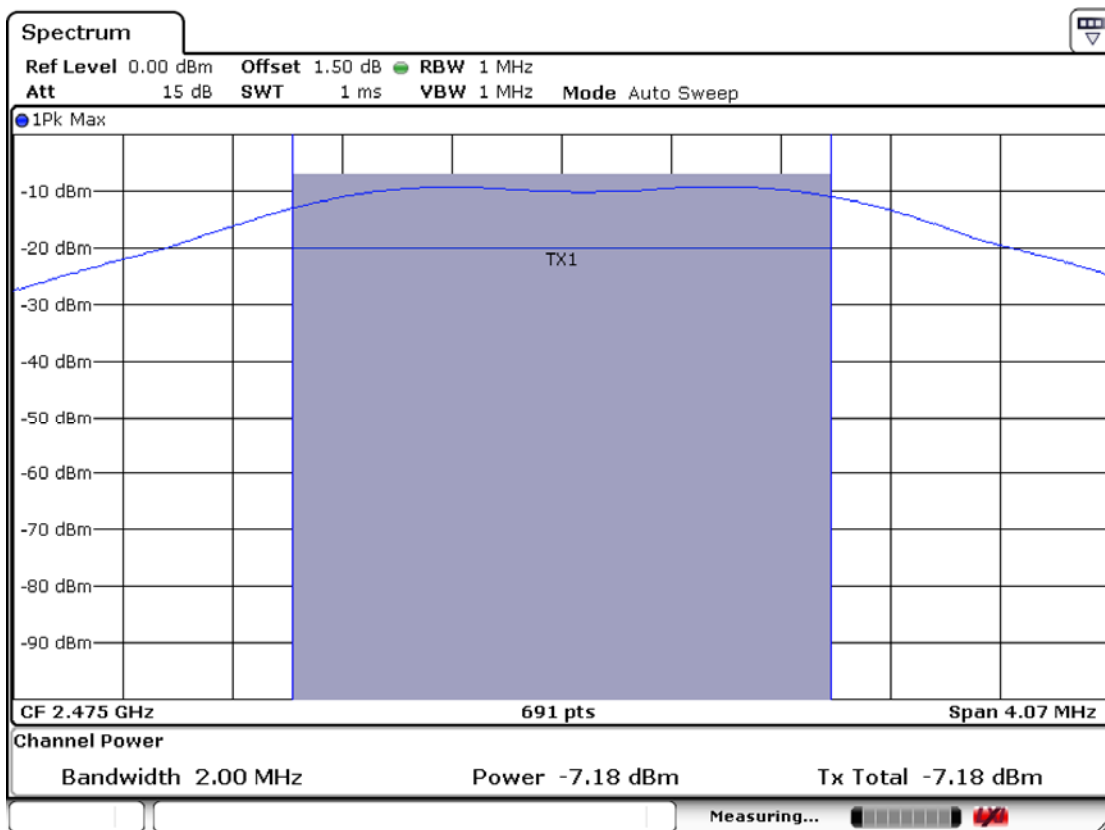

BLE Single channel

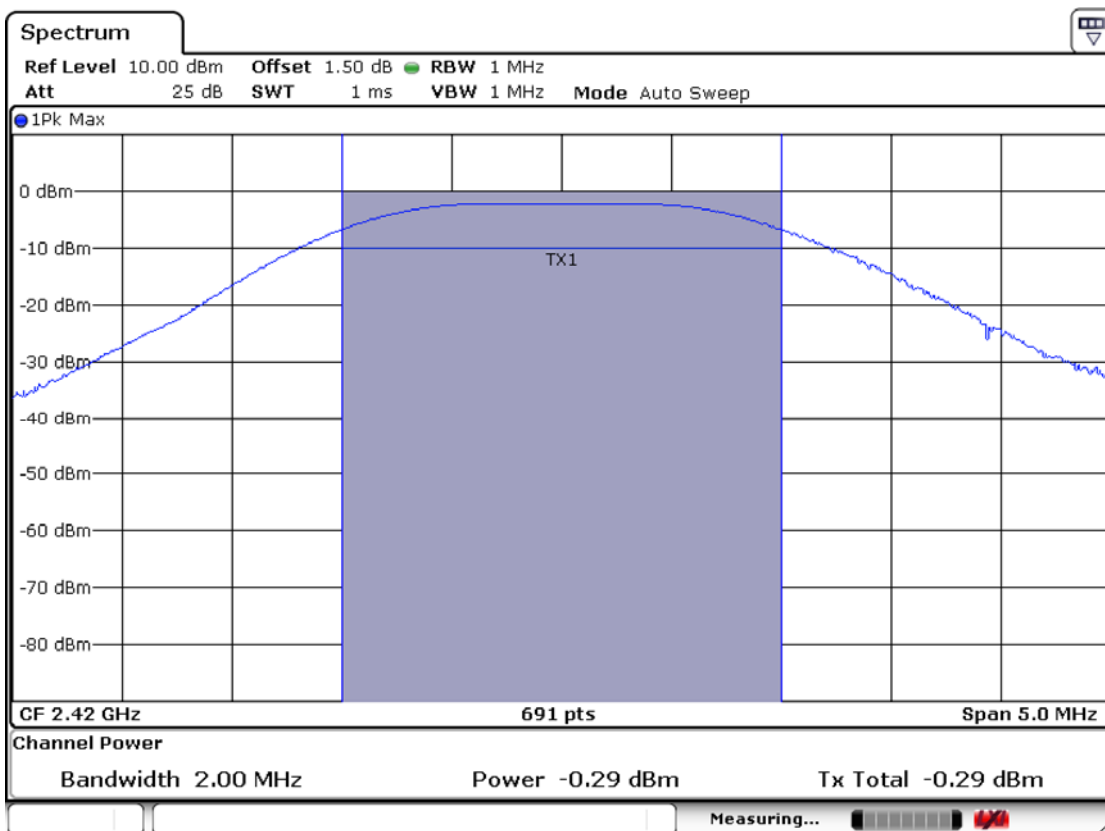

3.2.3 Power Spectral Density

Procedure:

The peak power density is measured with a spectrum analyzer connected to the antenna terminal while the EUT is operating in transmission mode at the appropriate frequencies.

The spectrum analyzer is set to:

RBW = 3 kHz

Span = 300 kHz

VBW = 3 kHz

Sweep = auto

Detector function = peak

Trace = max hold

Measurement Data : **Complies**

Frequency (MHz)	Test Results	
	dBm	Result
2405_Zigbee	-25.09	Complies
2440_Zigbee	-24.79	Complies
2475_Zigbee	-24.76	Complies
2420_BLE Single channel	-14.43	Complies

- See next pages for actual measured spectrum plots.

Minimum Standard:

Power Spectral Density	< 8 dBm @ 3 kHz BW
------------------------	--------------------

Measurement Setup

Same as the Chapter 3.2.1 (Figure 1)

Power Density Measurement Low Channel

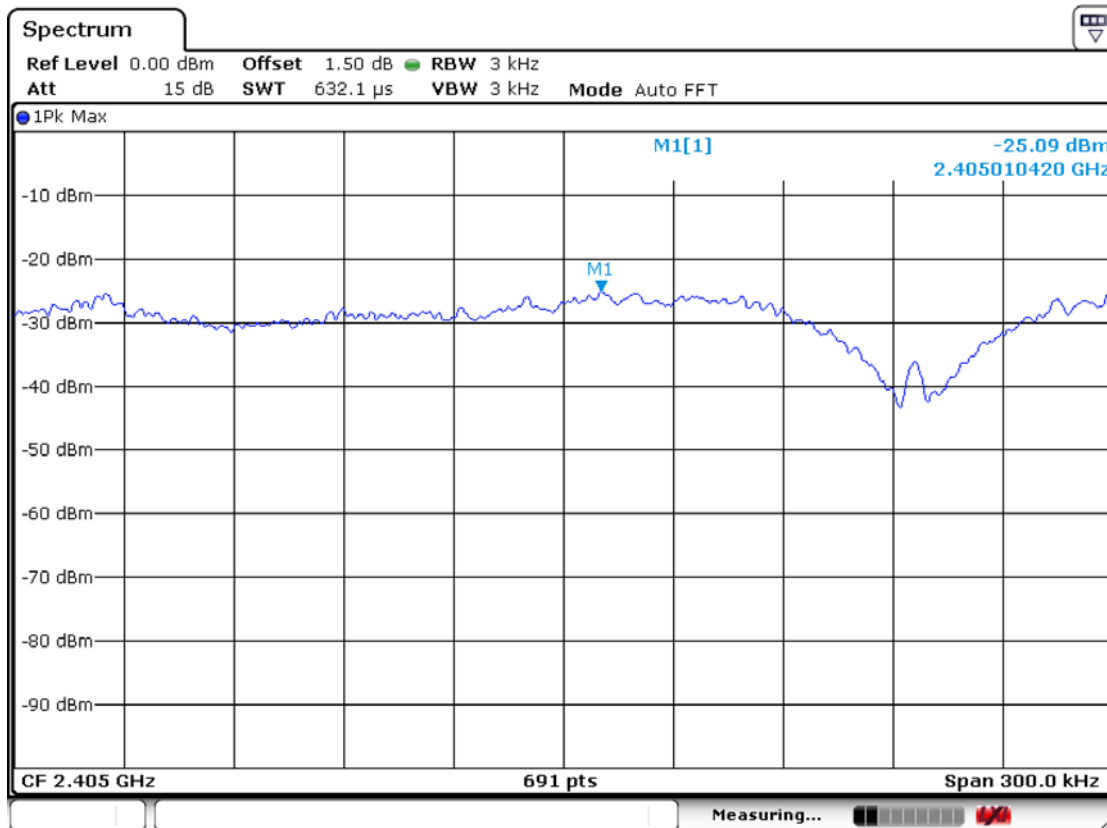

Middle Channel

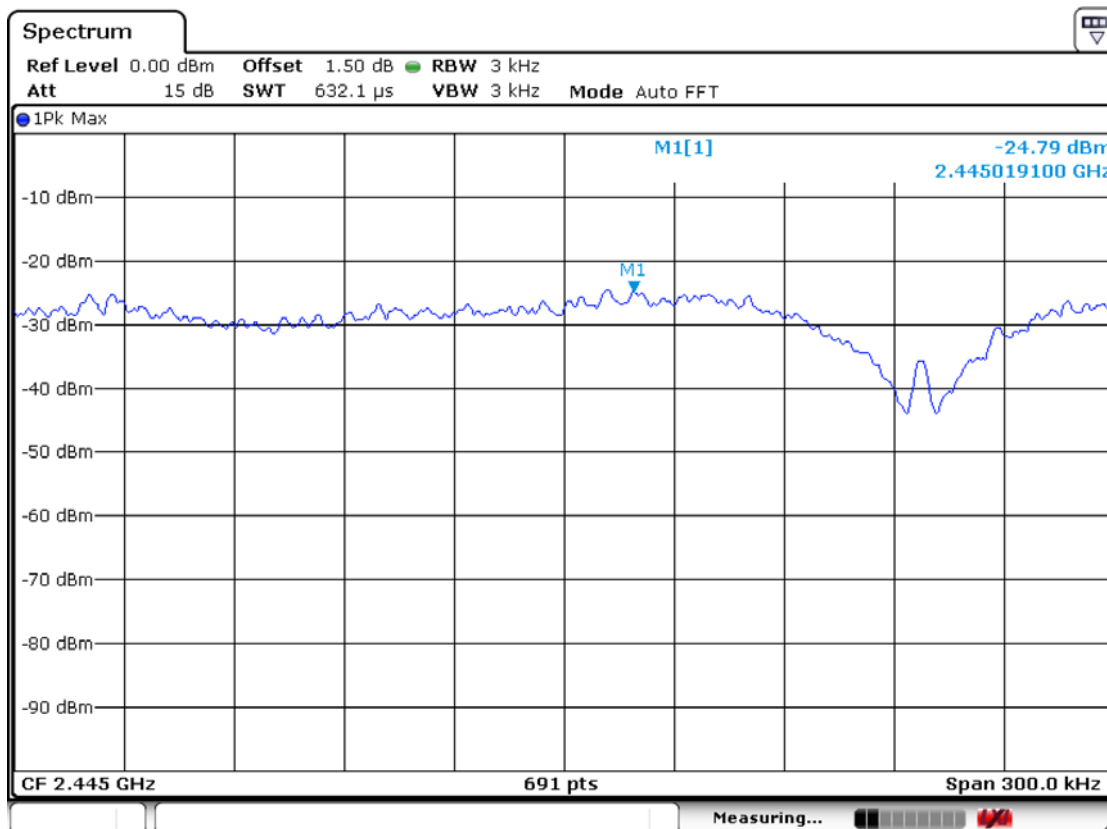

High Channel

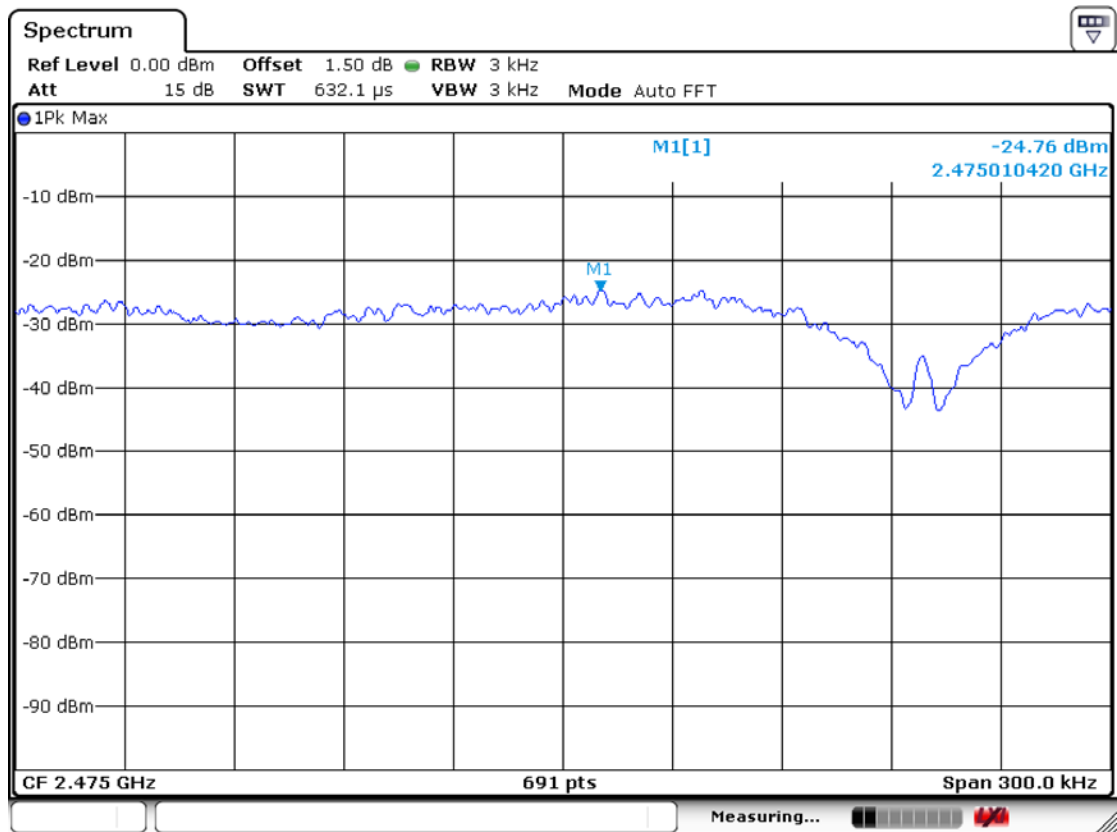

BLE Single channel

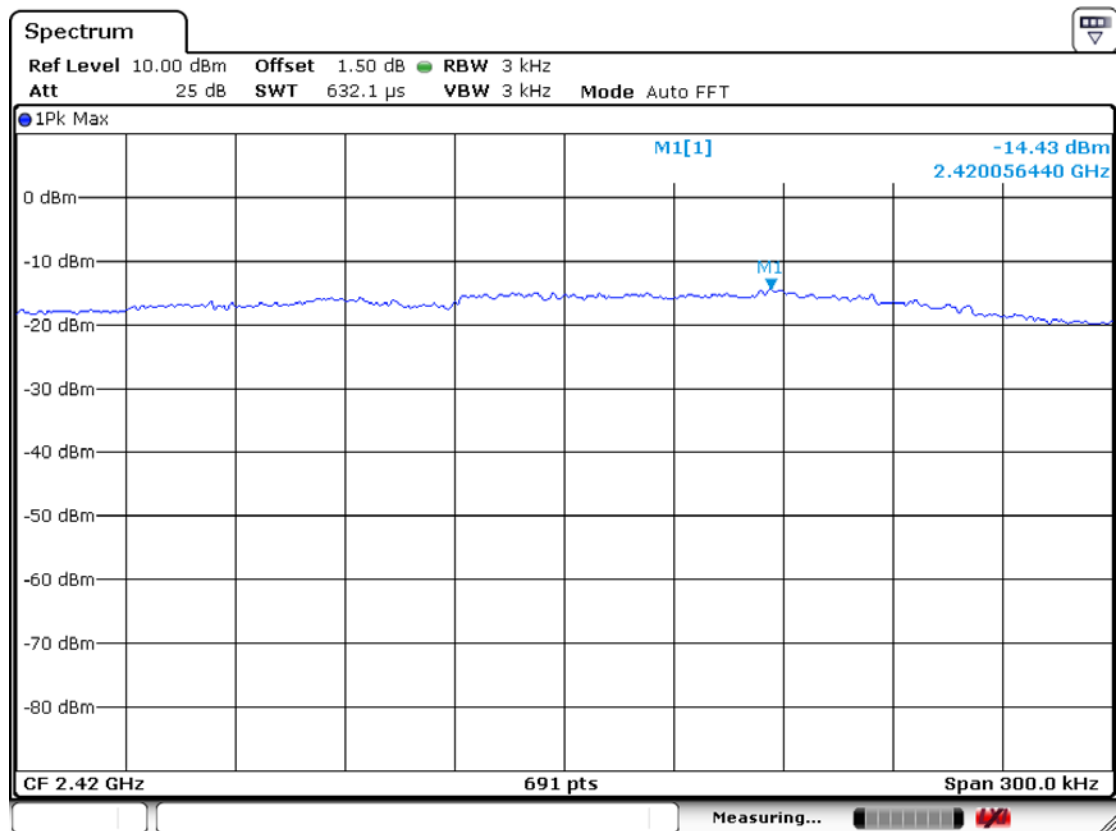

3.2.4 Band Edge

Procedure:

The bandwidth at 20 dB down from the highest inband spectral density is measured with a spectrum analyzer connected to the antenna terminal, while EUT is operating in transmission mode at the appropriate frequencies.

After the trace being stable, Use the marker-to-peak function to measure 20 dB down both sides of the intentional emission.

The spectrum analyzer is set to:

Center frequency = the highest, middle and the lowest channels

RBW = 100 kHz

VBW = 100 kHz

Span = 40 MHz, 100 MHz

Detector function = peak

Trace = max hold

Sweep = auto

Radiated emissions which fall in the restricted bands, as defined in 15.205(a), must also comply with the radiated emission limits specified in 15.209(a)

The spectrum analyzer is set to:

Center frequency = the highest, the lowest channels

PEAK:

RBW = VBW = 1 MHz, Sweep=Auto

Average:

RBW = 1 MHz, VBW=10 Hz, Sweep=Auto

Measurement Distance:

3 m

Polarization:

Horizontal / Vertical

Measurement Data: Complies

- All conducted emission in any 100 kHz bandwidth outside of the spread spectrum band was at least 20 dB lower than the highest inband spectral density. Therefore the applying equipment meets the requirement.
- See next pages for actual measured spectrum plots.

Minimum Standard:	> 20 dBc
--------------------------	----------

Band edge Zigbee Lower edge

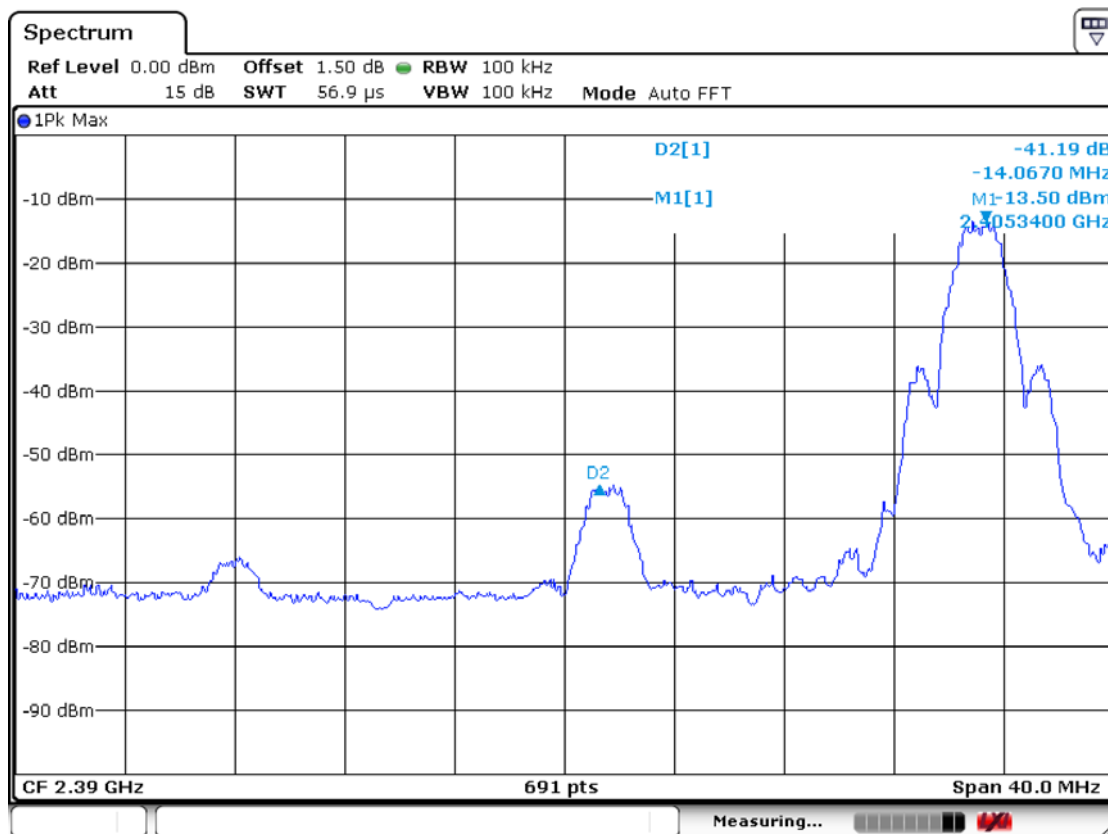

Upper edge

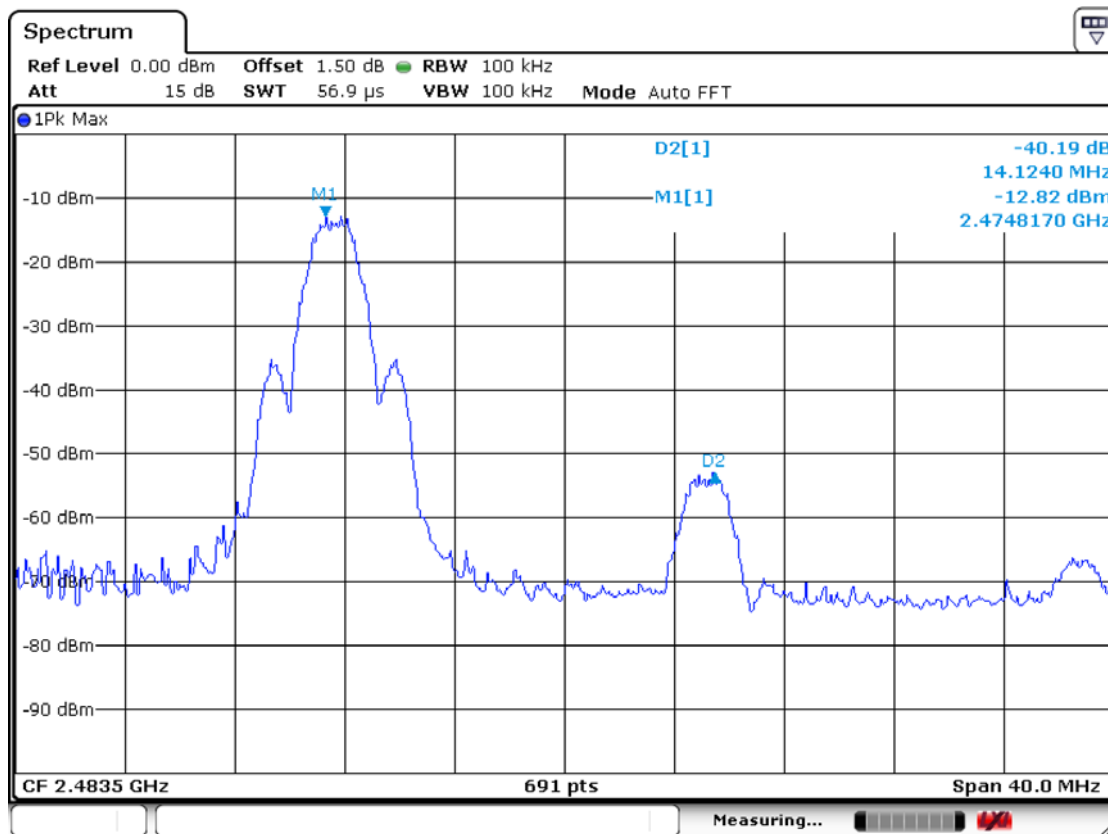

Band edge BLE Single channel

Lower edge

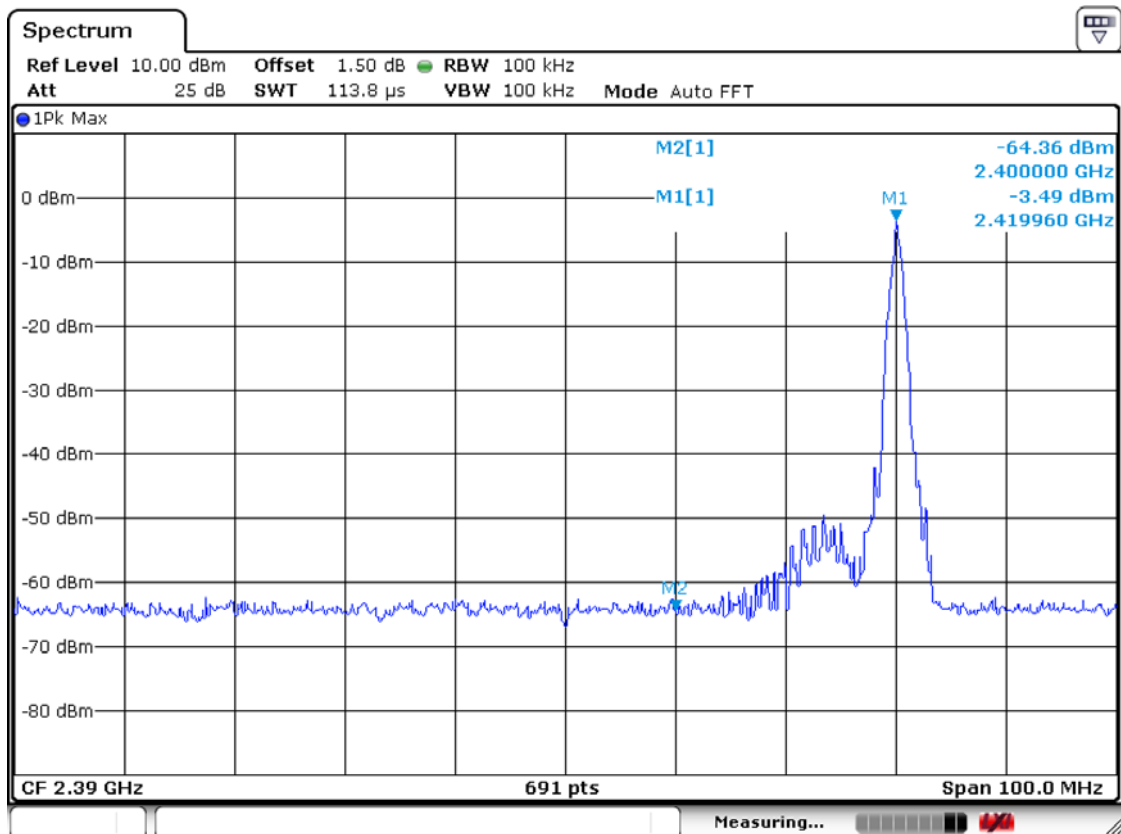

Upper edge

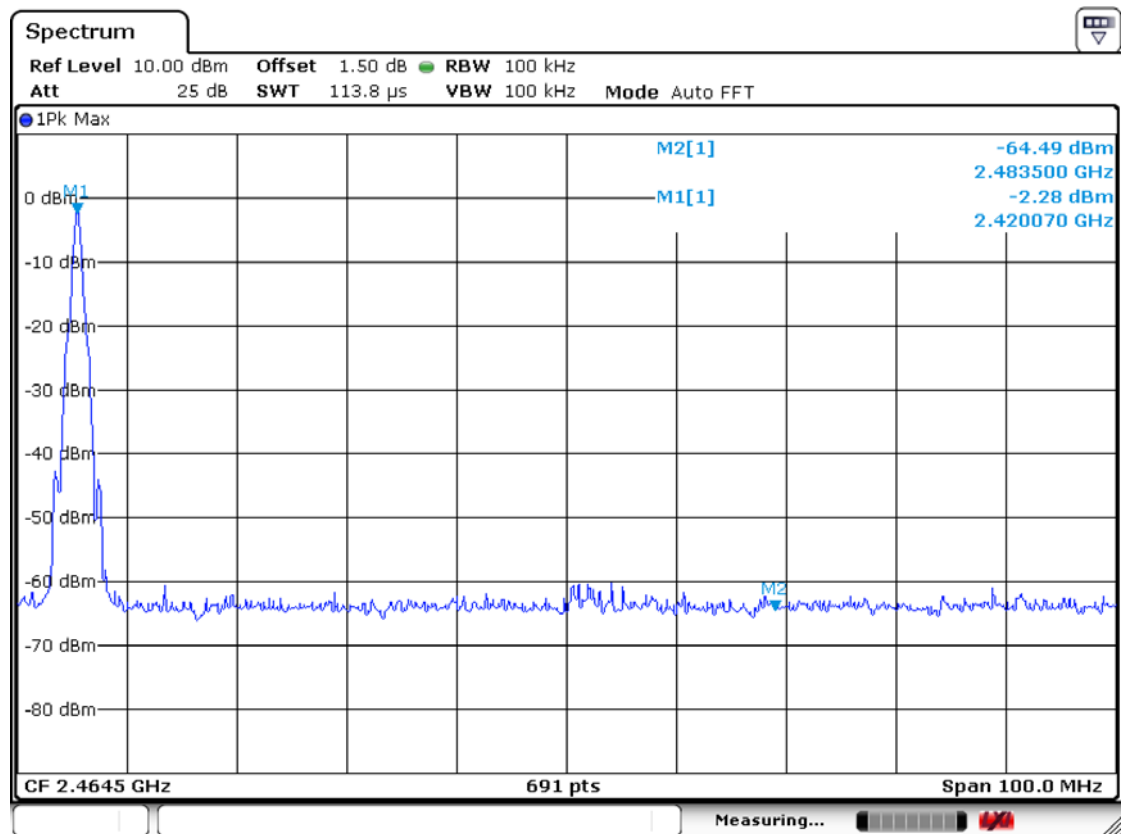

Radiated Band-edges in the restricted band 2310-2390 MHz measurement_Zigbee

Frequency [MHz]	Reading [dBuV/ m]		Pol.	Correction Factor		Limits [dBuV/ m]		Result [dBuV/ m]		Margin [dB]	
	AV / Peak			Antenna	Amp. Gain + Cable Loss	AV / Peak		AV / Peak		AV / Peak	
2389.3	40.1	52.8	V	27.9	22.9	54.0	74.0	45.1	57.8	8.9	16.2

Radiated Band-edges in the restricted band 2483.5-2500 MHz measurement_Zigbee

Frequency [MHz]	Reading [dBuV/ m]		Pol.	Correction Factor		Limits [dBuV/ m]		Result [dBuV/ m]		Margin [dB]	
	AV / Peak			Antenna	Amp. Gain + Cable Loss	AV / Peak		AV / Peak		AV / Peak	
2483.5	38.6	48.3	V	27.9	22.9	54.0	74.0	43.6	53.3	10.4	20.7

Note : This EUT was tested in 3 orthogonal positions and the worst-case data was presented

Radiated Band-edges in the restricted band 2310-2390 MHz measurement_BLE Single channel

Frequency [MHz]	Reading [dBuV/ m]		Pol.	Correction Factor		Limits [dBuV/ m]		Result [dBuV/ m]		Margin [dB]	
	AV / Peak			Antenna	Amp. Gain + Cable Loss	AV / Peak		AV / Peak		AV / Peak	
2390.0	30.2	39.4	V	27.9	22.9	54.0	74.0	35.2	44.4	18.8	29.6

Radiated Band-edges in the restricted band 2483.5-2500 MHz measurement_BLE Single channel

Frequency [MHz]	Reading [dBuV/ m]		Pol.	Correction Factor		Limits [dBuV/ m]		Result [dBuV/ m]		Margin [dB]	
	AV / Peak			Antenna	Amp. Gain + Cable Loss	AV / Peak		AV / Peak		AV / Peak	
2483.5	34.6	40.1	V	27.9	22.9	54.0	74.0	39.6	45.1	14.4	28.9

Note : This EUT was tested in 3 orthogonal positions and the worst-case data was presented

3.2.5 Conducted Spurious Emissions

Procedure:

The test follows KDB558074. The conducted spurious emissions were measured with a spectrum analyzer connected to the antenna terminal, while EUT had its hopping function disabled at the highest, middle and the lowest available channels..

After the trace being stable, set the marker on the peak of any spurious emission recorded.

The spectrum analyzer is set to:

Span = wide enough to capture the peak level of the in-band emission and all spurious emissions

RBW = 100 kHz

Sweep = auto

VBW = 100 kHz

Detector function = peak

Trace = max hold

Measurement Data: Complies

- All conducted emission in any 100 kHz bandwidth outside of the spread spectrum band was at least 20 dB lower than the highest inband spectral density. Therefore the applying equipment meets the requirement.
- See next pages for actual measured spectrum plots.

Minimum Standard:	> 20 dBc
--------------------------	----------

Measurement Setup

Same as the Chapter 3.2.1 (Figure 1)

Unwanted Emission – Low Channel Zigbee
Frequency Range = 30 MHz ~ 26.5 GHz

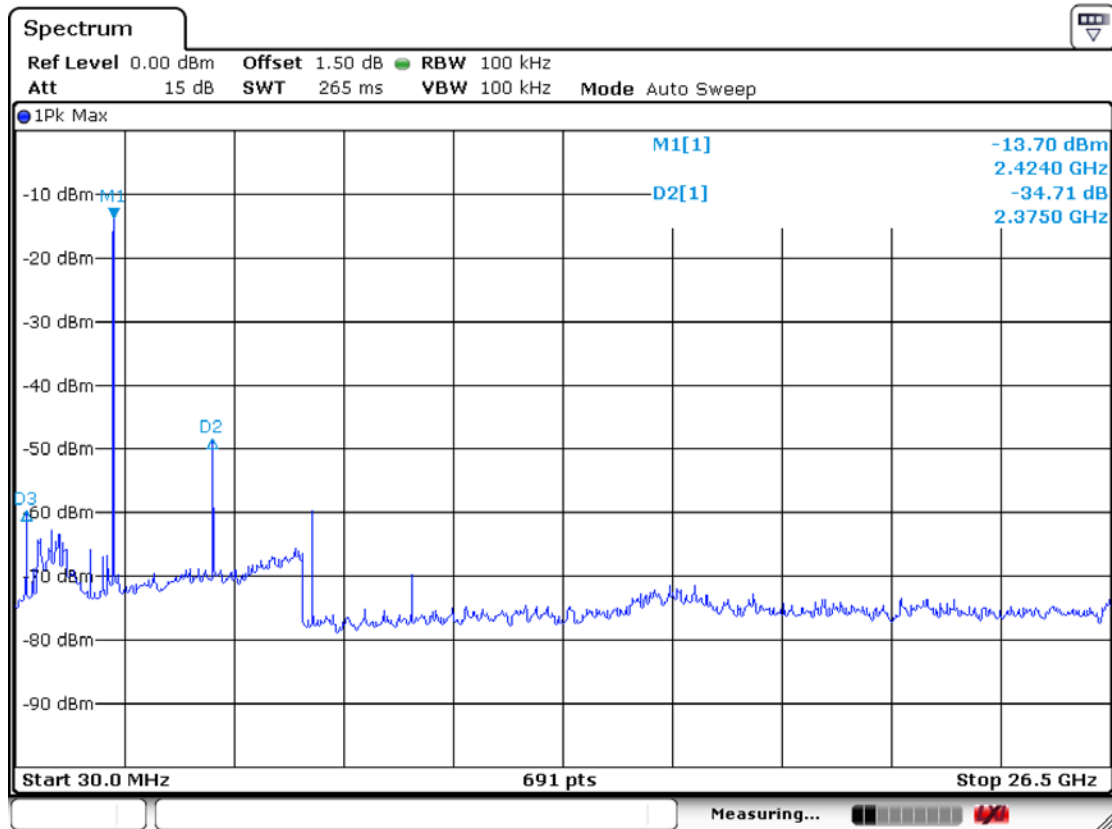

Unwanted Emission – Middle Channel
Frequency Range = 30 MHz ~ 26.5 GHz

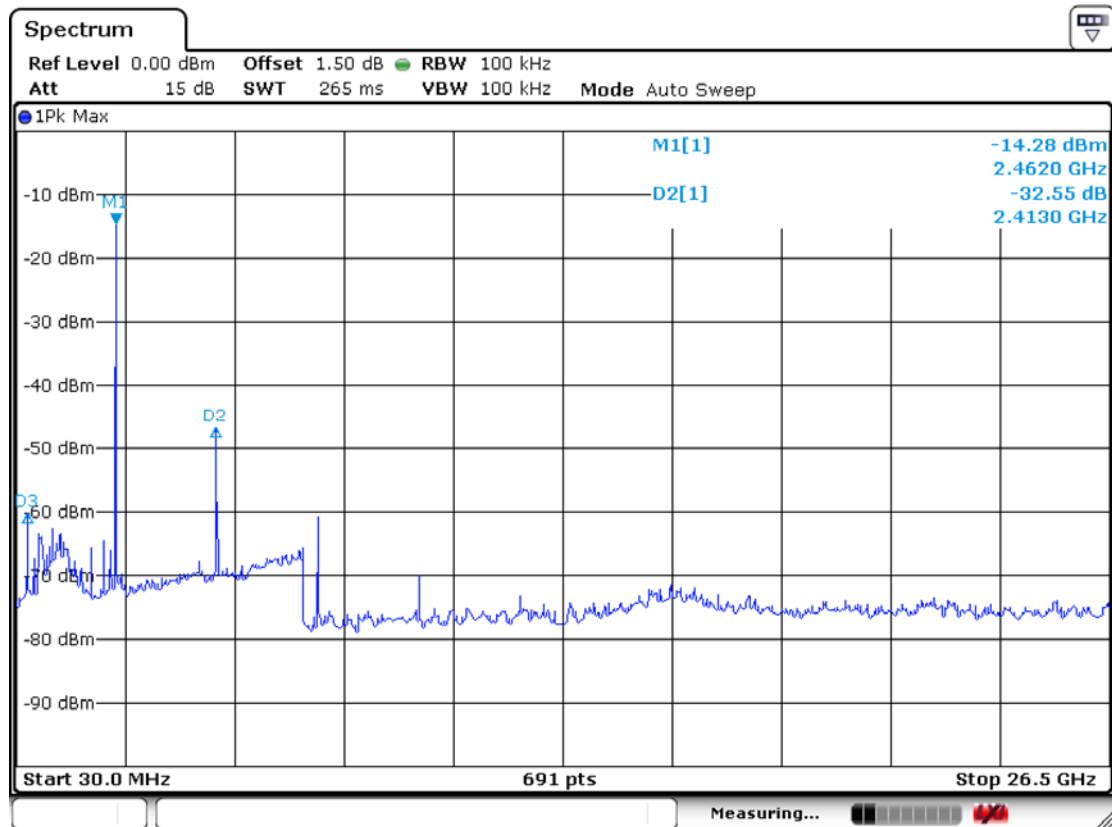

Unwanted Emission – High Channel
Frequency Range = 30 MHz ~ 26.5 GHz

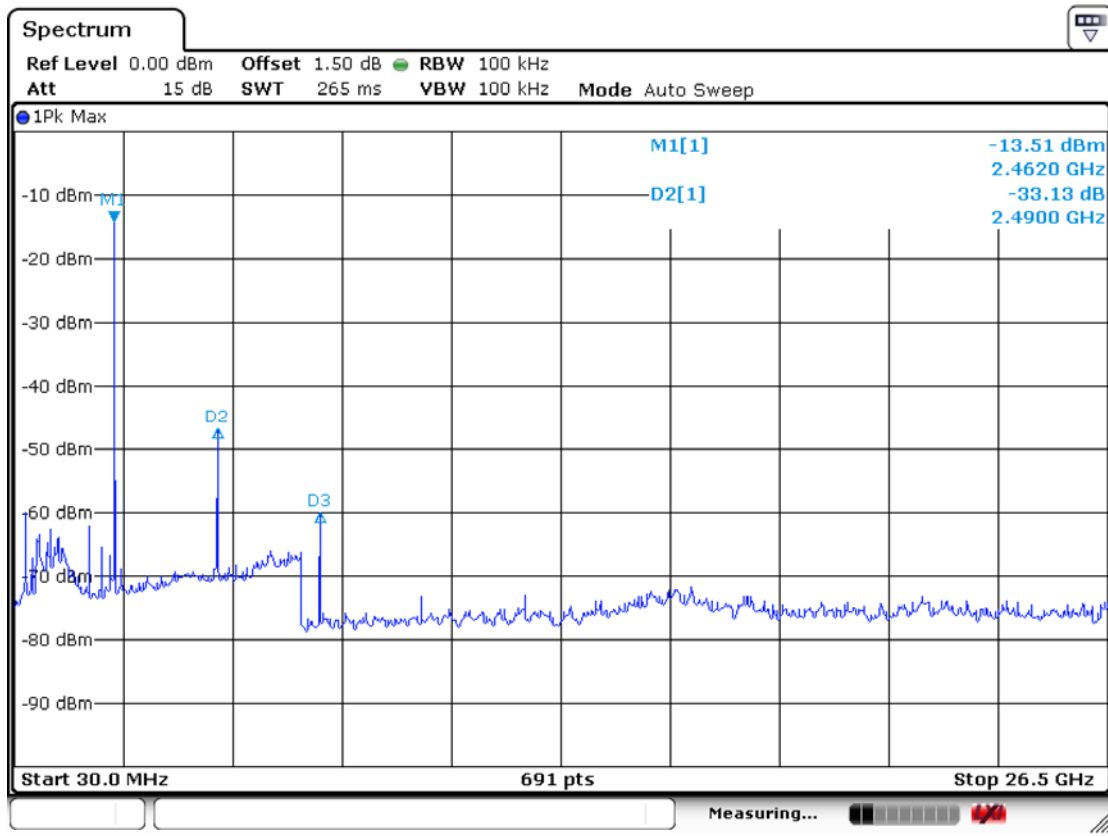

Unwanted Emission – BLE Single channel
Frequency Range = 30 MHz ~ 26.5 GHz

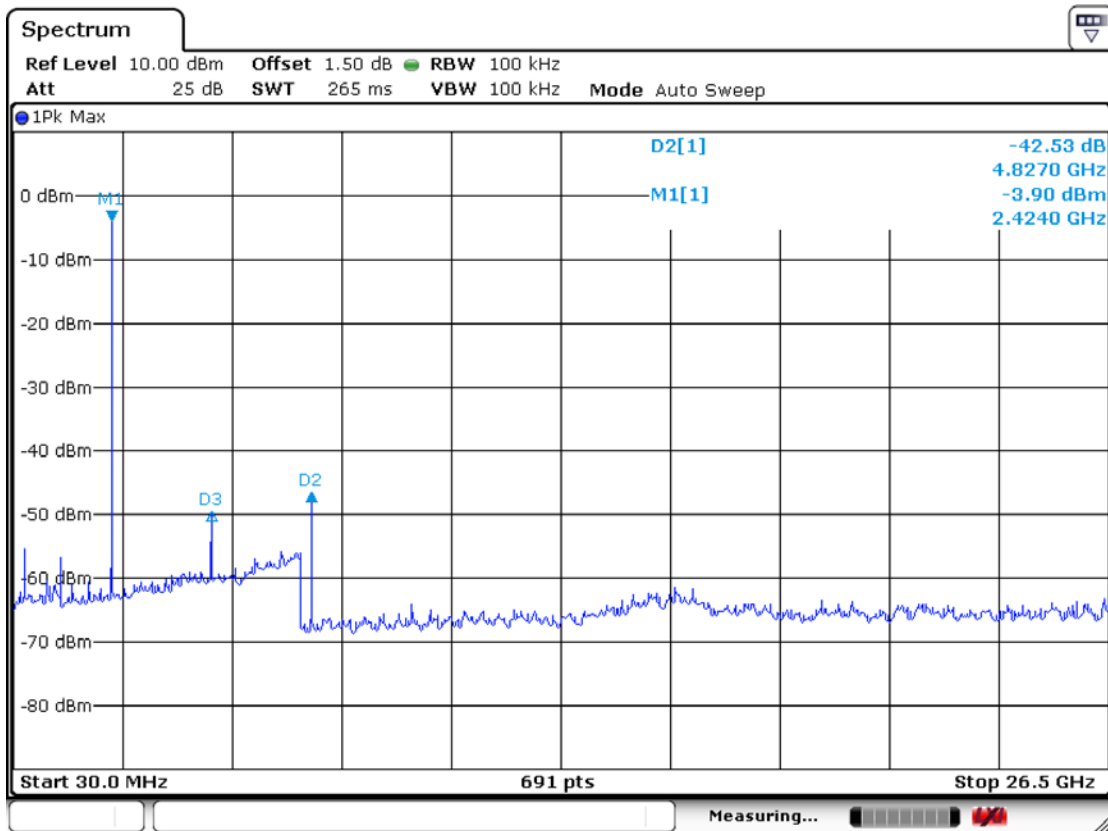

3.2.6 Radiated Spurious Emissions

Procedure:

Radiated emissions from 30 MHz to 25 GHz were measured according to the methods defines in ANSI C63.10-2013.

The EUT is a placed on as turn table. For emissions testing at or below 1 GHz, the table height shall be 0.8 m above the reference ground plane. For emission measurements above 1 GHz, the table height shall be 1.5 m. The turn table shall rotate 360 degrees to determine the position of maximum emission level. EUT is set 3m away from the receiving antenna which varied from 1m to 4m to find out the highest emission. And also, each emission was to be maximized by changing the polarization of receiving antenna both horizontal and vertical. In order to find out the max. emission, the relative positions of this hand-held transmitter (EUT) was rotated through three orthogonal axes and measurement procedures for electric field radiated emissions above 1 GHz the EUT measurement is to be made “while keeping the antenna in the ‘cone of radiation’ from that area and pointed at the area both in azimuth and elevation, with polarization oriented for maximum response.” is still within the 3dB illumination BW of the measurement antenna.

The spectrum analyzer is set to:

Center frequency = the worst channel

Frequency Range = 9 kHz ~ 10th harmonic.

RBW = 100 kHz (30 MHz ~ 1 GHz)

= 1 MHz (1 GHz ~ 10th harmonic)

Span = 100 MHz

Trace = max hold

VBW ≥ RBW

Detector function = peak

Sweep = auto

below 30 MHz

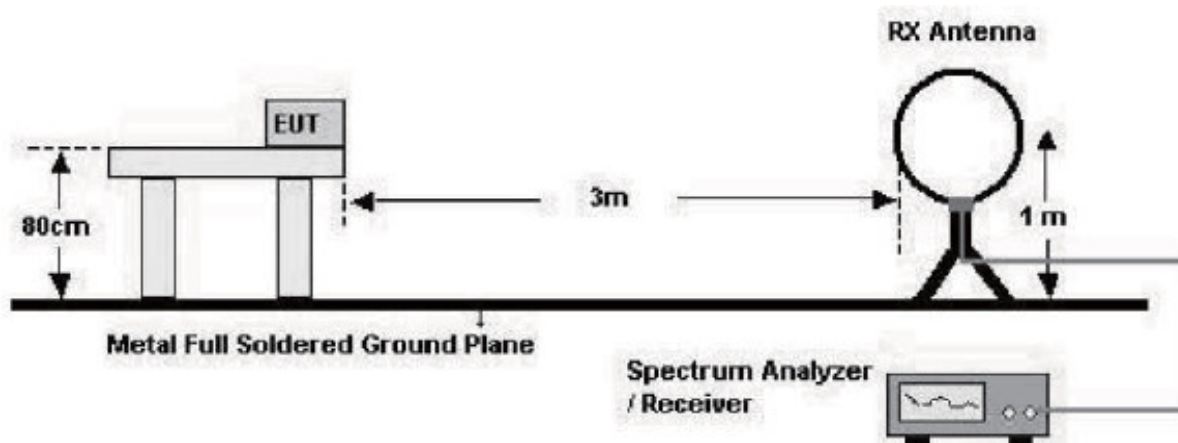

below 1 GHz (30 MHz to 1 GHz)

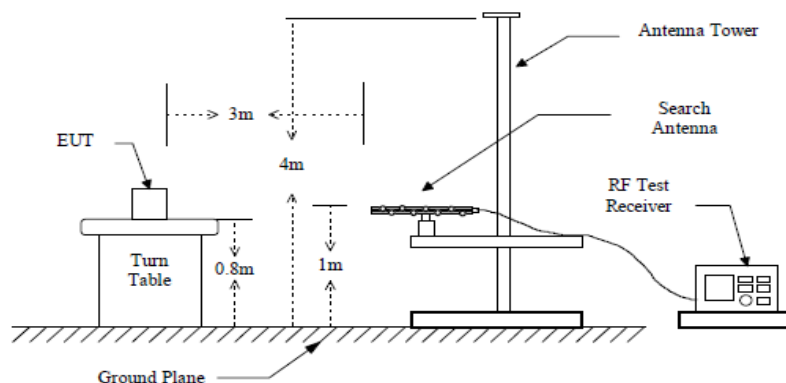

above 1 GHz

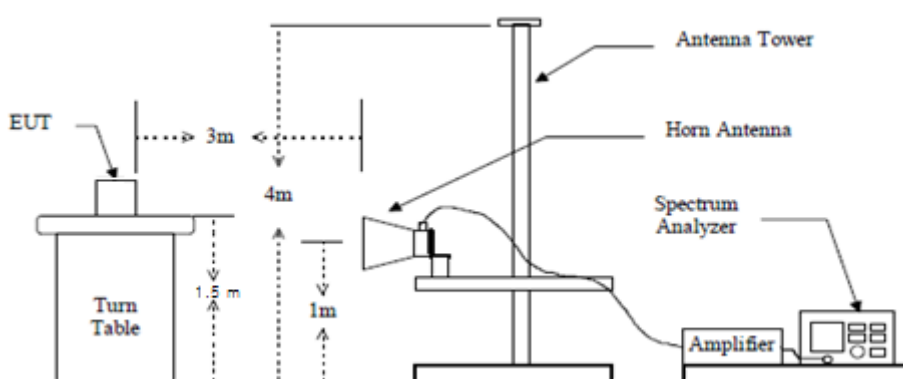

Measurement Data: **Complies**

- See next pages for actual measured data.
- No other emissions were detected at a level greater than 20 dB below limit include from 9 kHz to 30MHz.

Minimum Standard: FCC Part 15.209(a)

Frequency (MHz)	Limit (uV/m) @ 3 m
0.009 ~ 0.490	2400/F(kHz) (@ 300 m)
0.490 ~ 1.705	24000/F(kHz) (@ 30 m)
1.705 ~ 30	30(@ 30 m)
30 ~ 88	100 **
88 ~ 216	150 **
216 ~ 960	200 **
Above 960	500

** Except as provided in 15.209(g), fundamental emissions from intentional radiators operating under this Section shall not be located in the frequency bands 54-72 MHz, 76-88 MHz, 174-216 MHz or 470-806 MHz. However, operation within these frequency bands is permitted under other sections of this Part, e.g. 15.231 and 15.241.

Measurement Data : (Above 1 GHz)_Zigbee

Frequency [MHz]	Reading [dBuV/ m]		Pol.	Correction Factor		Limits [dBuV/ m]		Result [dBuV/ m]		Margin [dB]	
	AV / Peak			Antenna	Amp.Gain+ Cable	AV/ Peak		AV/ Peak		AV / Peak	
4819.2	39.1	53.9	V	32.9	22.9	54.0	74.0	49.1	63.9	4.9	10.1
4781.6	37.8	52.8	V	32.9	22.9	54.0	74.0	47.8	62.8	6.2	11.2
4894.0	35.9	50.3	V	32.9	22.9	54.0	74.0	45.9	60.3	8.1	13.7

- No other emissions were detected at a level greater than 20 dB below limit.

Measurement Data : (9 kHz – 30 MHz)_Zigbee

Frequency [MHz]	Reading [dBuV/ m]		Pol.	Correction Factor		Limits [dBuV/ m]		Result [dBuV/ m]		Margin [dB]	
	AV / Peak			Antenna	Amp.Gain+ Cable	AV/ Peak		AV/ Peak		AV / Peak	
-	-	-	-	-	-	-	-	-	-	-	-
No emissions were detected at a level greater than 20 dB below limit.											
-	-	-	-	-	-	-	-	-	-	-	-
-	-	-	-	-	-	-	-	-	-	-	-

*No emissions were detected at a level greater than 20 dB below limit.

Measurement Data : (Above 1 GHz)_BLE Single channel

Frequency [MHz]	Reading [dBuV/ m]		Pol.	Correction Factor		Limits [dBuV/ m]		Result [dBuV/ m]		Margin [dB]	
	AV / Peak			Antenna	Amp.Gain+ Cable	AV/ Peak		AV/ Peak		AV / Peak	
4886.2	36.7	53.6	V	32.9	22.9	54.0	74.0	46.7	63.6	7.3	10.4
-	-	-	-	-	-	-	-	-	-	-	-
-	-	-	-	-	-	-	-	-	-	-	-

- No other emissions were detected at a level greater than 20 dB below limit.

Measurement Data : (9 kHz – 30 MHz)_BLE Single channel

Frequency [MHz]	Reading [dBuV/ m]		Pol.	Correction Factor		Limits [dBuV/ m]		Result [dBuV/ m]		Margin [dB]	
	AV / Peak			Antenna	Amp.Gain+ Cable	AV/ Peak		AV/ Peak		AV / Peak	
-	-	-	-	-	-	-	-	-	-	-	-
No emissions were detected at a level greater than 20 dB below limit.											
-	-	-	-	-	-	-	-	-	-	-	-
-	-	-	-	-	-	-	-	-	-	-	-

*N

Radiated Emissions (Below 1 GHz) – Zigbee(LOW) mode



4, Songjuro236Beon-gil, Yangji-myeon,
Cheoin-gu, Youngin-si, Gyeonggi-do,
449-822 Korea
Tel :+82-31-3236008,9
Fax:+82-31-3236010

EUT/Model No. : HP100 TEST MODE: Zigbee(LOW) mode
Temp Humi : 10 / 44 Tested by: SIN S U

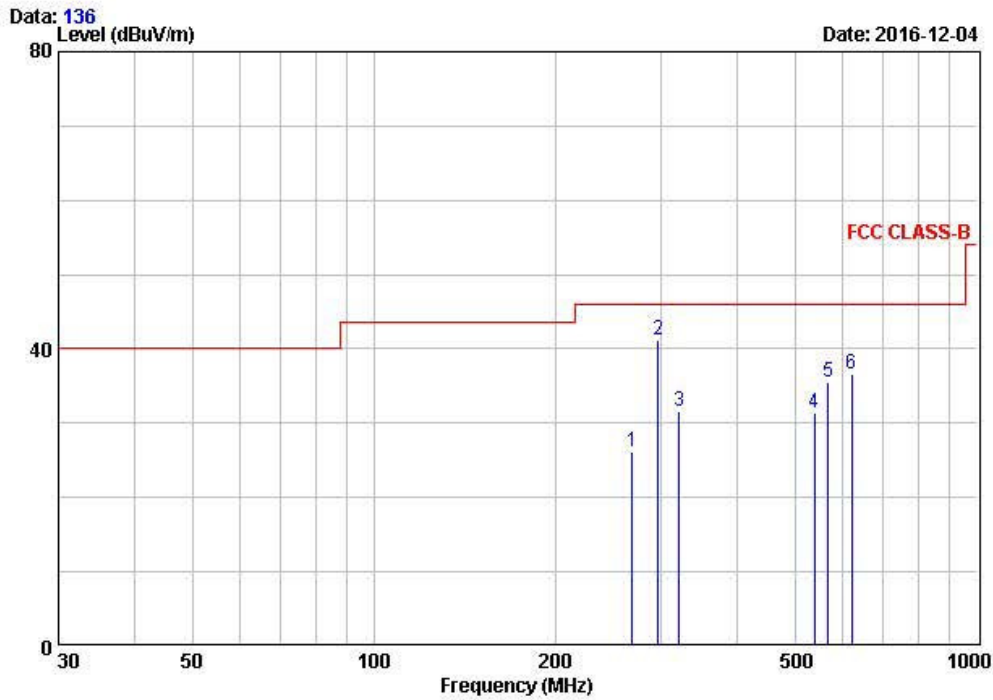

Freq	Reading	C.F	Result	Limit	Margin	Height	Angle	Polarity
MHz	dBuV	dB	dBuV/m	QP	dB	cm	deg	deg
1 268.40	40.80	-14.58	26.22	46.00	19.78	100	100	VERTICAL
2 295.80	54.80	-13.59	41.21	46.00	4.79	400	178	HORIZONTAL
3 320.90	44.60	-12.99	31.61	46.00	14.39	100	211	VERTICAL
4 537.80	39.20	-7.81	31.39	46.00	14.61	160	144	VERTICAL
5 566.20	42.70	-7.07	35.63	46.00	10.37	100	317	VERTICAL
6 620.90	42.20	-5.51	36.69	46.00	9.31	100	218	VERTICAL

Remarks: C.F (Correction Factor) = Antenna factor + Cable loss - Preamp gain

Radiated Emissions (Below 1 GHz) – Zigbee(MID) mode



4, Songjuro236Beon-gil, Yangji-myeon,
Cheoin-gu, Youngin-si, Gyeonggi-do,
449-822 Korea
Tel :+82-31-3236008,9
Fax:+82-31-3236010

EUT/Model No.: HP100 TEST MODE: Zigbee(MID) mode
Temp Humi : 10 / 44 Tested by: SIN S U

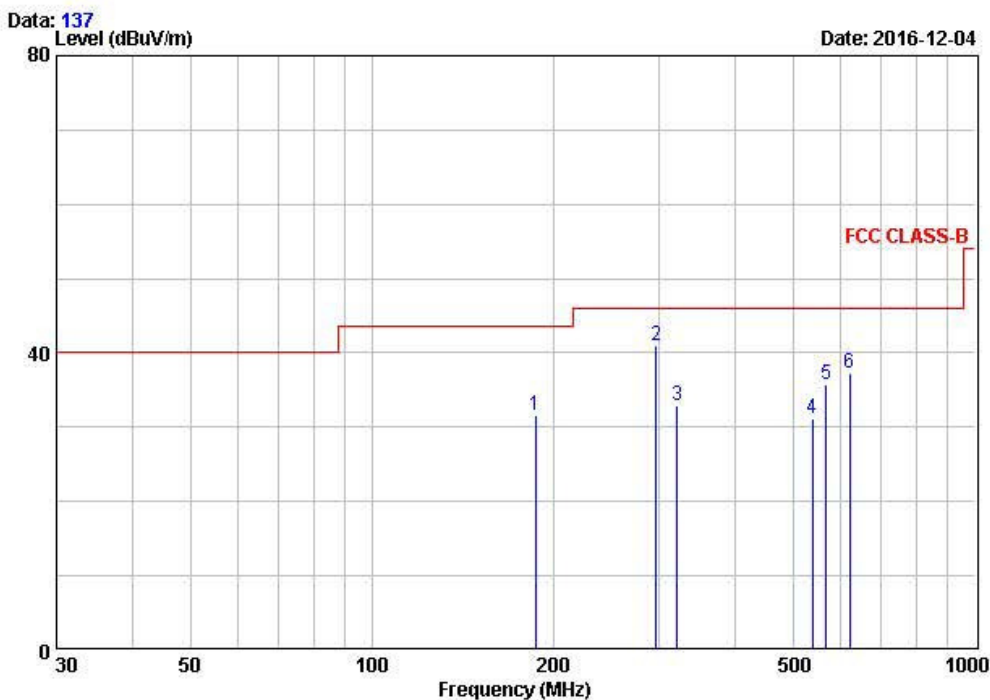

Freq	Reading	C.F	Result	Limit	Margin	Height	Angle	Polarity
MHz	dBuV	dB	dBuV/m	dBuV/m	dB	cm	deg	
1	186.70	-16.87	31.63	43.50	11.87	100	146	VERTICAL
2	295.80	-13.59	40.91	46.00	5.09	398	180	HORIZONTAL
3	321.00	-12.99	32.81	46.00	13.19	100	208	VERTICAL
4	538.50	-7.79	31.21	46.00	14.79	156	125	VERTICAL
5	567.50	-7.04	35.77	46.00	10.24	100	320	VERTICAL
6	621.00	-5.51	37.29	46.00	8.71	100	250	VERTICAL

Remarks: C.F (Correction Factor) = Antenna factor + Cable loss - Preamp gain

Radiated Emissions (Below 1 GHz) – Zigbee(HIGH) mode



4, Songjiro236Beon-gil, Yangji-myeon,
Cheoin-gu, Youngin-si, Gyeonggi-do,
449-822 Korea
Tel :+82-31-3236008,9
Fax:+82-31-3236010

EUT/Model No.: HP100 TEST MODE: Zigbee(HIGH) mode
Temp Humi : 10 / 44 Tested by: SIN S U

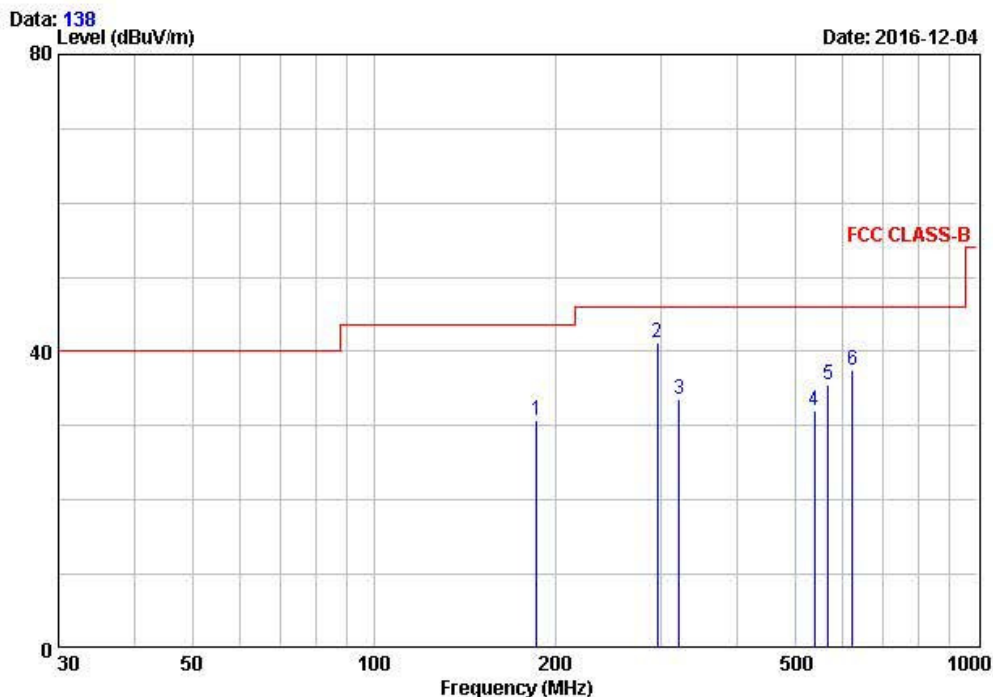

Peak	Freq MHz	Reading dBuV	C.F dB	Result dBuV/m	Limit QP dBuV/m	Margin dB	Height cm	Angle deg	Polarity
1	186.50	47.60	-16.85	30.75	43.50	12.75	100	110	VERTICAL
2	295.70	54.80	-13.60	41.20	46.00	4.80	400	176	HORIZONTAL
3	321.20	46.50	-12.98	33.52	46.00	12.48	100	235	VERTICAL
4	537.90	39.80	-7.81	31.99	46.00	14.01	100	89	VERTICAL
5	567.10	42.50	-7.05	35.45	46.00	10.55	100	332	VERTICAL
6	621.20	43.00	-5.50	37.50	46.00	8.50	100	241	VERTICAL

Remarks: C.F (Correction Factor) = Antenna factor + Cable loss - Preamp gain

Radiated Emissions (Above 1 GHz) – 2.4 GHz Zigbee(LOW) mode



EMI I Chamber of LTA CO.,LTD.
 4, Songjuro236Beon-gil, Yangji-myeon,
 Yongin-si, Gyeonggi-do, Korea Autho.by NVLAP
 Tel :+82-31-3236008,9 www.ltalab.com
 Fax:+82-31-3236010

EUT/Model No.: HP100 Test Mode: Zigbee (LOW) mode
 Tested by : SIN S U Temp/Humi: 19 / 42

Data: 114 File: D:\LTA_e3\e3_backup\1GHz 이상\2016\CH1_ABOVE 1GHz_1604-1.EMI (118)
 Level (dBuV/m) Date: 2016-12-02 Time: 11:06:56

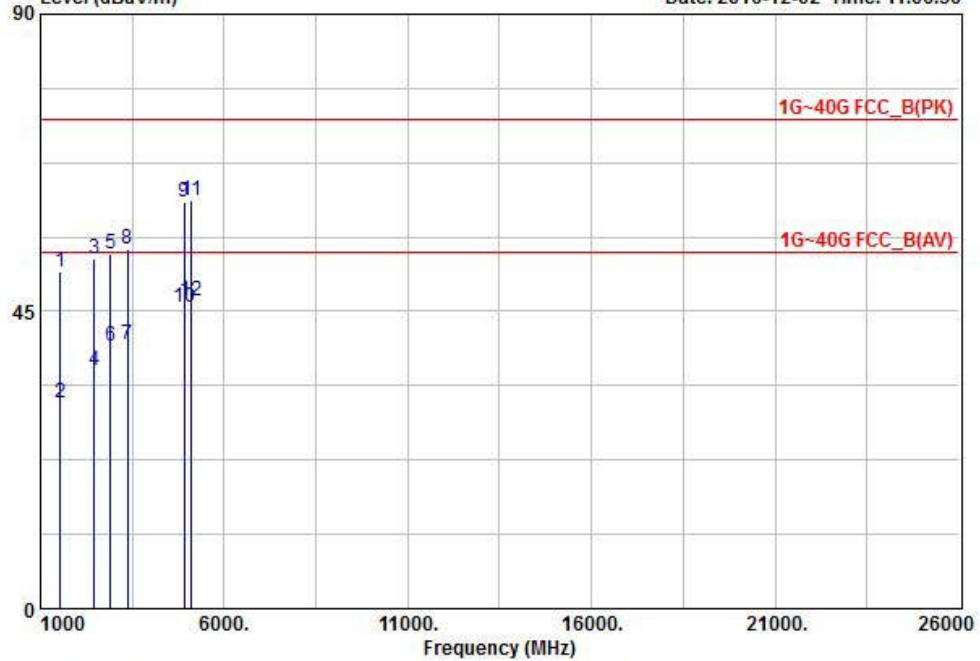

Freq	Reading	C.F	Result	Limit	Margin	Polarity	
MHz	dBuV	dB	PK dBuV/m	dBuV/m	dB		
1	1542.50	54.20	-3.19	51.01	74.00	22.99	HORIZONTAL
2	1542.50	34.40	-3.19	31.21	54.00	22.79	HORIZONTAL
3	2459.90	47.00	6.06	53.06	74.00	20.94	HORIZONTAL
4	2459.90	30.10	6.06	36.16	54.00	17.84	HORIZONTAL
5	2904.70	44.90	8.82	53.72	74.00	20.28	HORIZONTAL
6	2904.70	31.00	8.82	39.82	54.00	14.18	HORIZONTAL
7	3378.40	29.00	11.06	40.06	54.00	13.94	HORIZONTAL
8	3378.40	43.50	11.06	54.56	74.00	19.44	HORIZONTAL
9	4915.10	45.20	16.35	61.55	74.00	12.45	HORIZONTAL
10	4915.10	29.20	16.35	45.55	54.00	8.45	HORIZONTAL
11	5118.20	44.80	17.11	61.91	74.00	12.09	HORIZONTAL
12	5118.20	29.50	17.11	46.61	54.00	7.39	HORIZONTAL

Remarks: C.F (Correction Factor) = Antenna factor + Cable loss - Preamp gain
 Blue : Vertical Black : Horizontal

Radiated Emissions (Above 1 GHz) – 2.4 GHz Zigbee(MID) mode



EMI Chamber of LTA CO.,LTD.
 4, Songjuro236Beon-gil, Yangji-myeon,
 Yongin-si, Gyeonggi-do, Korea Autho.by NVLAP
 Tel :+82-31-3236008,9 www.ltalab.com
 Fax:+82-31-3236010

EUT/Model No. : HP100 Test Mode: Zigbee (MID) mode
 Tested by : SIN S U Temp/Humi: 19 / 42

Data: 115 File: D:\LTA_e3\3_backup\1GHz 이상\2016\CH1_ABOVE 1GHz_1604-1.EMI (118) Date: 2016-12-02 Time: 11:12:42
 Level (dBuV/m)

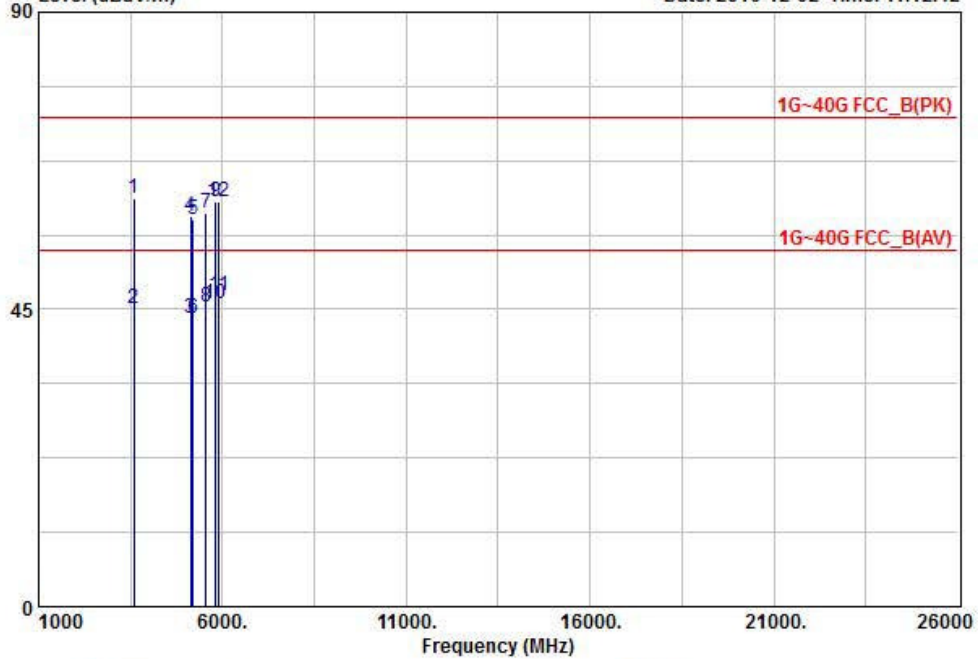

Freq	Reading	C.F	Result	Limit	Margin	Polarity	
MHz	dBuV	dB	PK dBuV/m	dBuV/m	dB		
1	3584.00	49.80	11.94	61.74	74.00	12.26	HORIZONTAL
2	3584.00	33.10	11.94	45.04	54.00	8.96	HORIZONTAL
3	5140.70	26.40	17.20	43.60	54.00	10.40	HORIZONTAL
4	5140.70	42.00	17.20	59.20	74.00	14.80	HORIZONTAL
5	5198.00	41.10	17.45	58.55	74.00	15.45	HORIZONTAL
6	5198.00	26.20	17.45	43.65	54.00	10.35	HORIZONTAL
7	5542.90	40.70	18.94	59.64	74.00	14.36	HORIZONTAL
8	5542.90	26.50	18.94	45.44	54.00	8.56	HORIZONTAL
9	5817.50	41.00	20.35	61.35	74.00	12.65	HORIZONTAL
10	5817.50	25.40	20.35	45.75	54.00	8.25	HORIZONTAL
11	5900.00	26.40	20.77	47.17	54.00	6.83	VERTICAL
12	5900.00	40.50	20.77	61.27	74.00	12.73	VERTICAL

Remarks: C.F (Correction Factor) = Antenna factor + Cable loss - Preamp gain
 Blue : Vertical Black : Horizontal

Radiated Emissions (Above 1 GHz) – 2.4 GHz Zigbee(HIGH) mode



EMI Chamber of LTA CO.,LTD.
 4, Songjuro236Beon-gil, Yangji-myeon,
 Yongin-si, Gyeonggi-do, Korea Autho.by NVLAP
 Tel :+82-31-3236008,9 www.ltalab.com
 Fax:+82-31-3236010

EUT/Model No. : HP100 Test Mode: Zigbee (HIGH) mode
 Tested by : SIN S U Temp/Humi: 19 / 42

Data: 116 File: D:\LTA_e3\3_backup\1GHz 이상\2016\CH1_ABOVE 1GHz_1604-1.EMI (118)
 Level (dBuV/m) Date: 2016-12-02 Time: 11:15:07

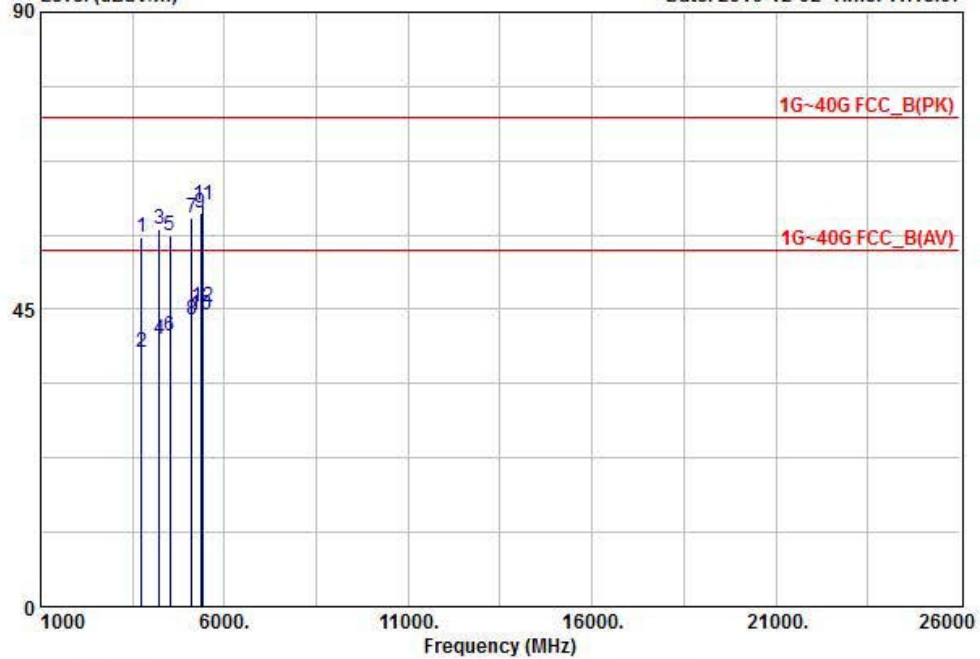

Freq	Reading	C.F	Result	Limit	Margin	Polarity	
MHz	dBuV	dB	PK dBuV/m	dBuV/m	dB		
1	3752.90	43.20	12.70	55.90	74.00	18.10	HORIZONTAL
2	3752.90	25.70	12.70	38.40	54.00	15.60	HORIZONTAL
3	4235.80	42.80	14.41	57.21	74.00	16.79	HORIZONTAL
4	4235.80	26.00	14.41	40.41	54.00	13.59	HORIZONTAL
5	4512.50	41.00	15.12	56.12	74.00	17.88	HORIZONTAL
6	4512.50	25.80	15.12	40.92	54.00	13.08	HORIZONTAL
7	5108.70	41.80	17.07	58.87	74.00	15.13	HORIZONTAL
8	5108.70	26.40	17.07	43.47	54.00	10.53	HORIZONTAL
9	5344.00	41.50	18.06	59.56	74.00	14.44	HORIZONTAL
10	5344.00	26.20	18.06	44.26	54.00	9.74	HORIZONTAL
11	5429.40	42.50	18.42	60.92	74.00	13.08	HORIZONTAL
12	5429.40	27.00	18.42	45.42	54.00	8.58	HORIZONTAL

Remarks: C.F (Correction Factor) = Antenna factor + Cable loss - Preamp gain
 Blue : Vertical Black : Horizontal

3.2.7 AC Conducted Emissions

Procedure:

The conducted emissions are measured in the shielded room with a spectrum analyzer in peak hold. While the measurement, EUT had its hopping function disabled at the middle channels in line with Section 15.31(m). Emissions closest to the limit are measured in the quasi-peak mode (QP) with the tuned receiver using a bandwidth of 9 kHz. The emissions are maximized further by cable manipulation and Exerciser operation. The highest emissions relative to the limit are listed.

Minimum Standard: FCC Part 15.207(a) / EN 55022

Class B

Frequency Range	quasi-peak	Average
0.15 ~ 0.5	66 to 56 *	56 to 46 *
0.5 ~ 5	56	46
5 ~ 30	60	50

* Decreases with the logarithm of the frequency

APPENDIX

TEST EQUIPMENT USED FOR TESTS

	Description	Model No.	Serial No.	Manufacturer	Interval	Last Cal. Date
1	Signal Analyzer (9 kHz ~ 30 GHz)	FSV30	100757	R&S	1 year	2016-10-11
2	Signal Generator (~ 3.2 GHz)	8648C	3623A02597	HP	1 year	2016-03-21
3	SYNTHESIZED CW GENERATOR	83711B	US34490456	HP	1 year	2016-03-21
4	Attenuator (3 dB)	8491A	37822	HP	1 year	2016-09-12
5	Attenuator (10 dB)	8491A	63196	HP	1 year	2016-09-12
6	Test Receiver (~ 30 MHz)	ESHS10	828404/009	R&S	1 year	2016-03-21
7	EMI Test Receiver (~ 7 GHz)	ESCI7	100722	R&S	1 year	2016-09-12
8	RF Amplifier (~ 1.3 GHz)	8447D	2944A07974	HP	1 year	2016-09-12
9	RF Amplifier (1 ~ 26.5 GHz)	8449B	3008A02126	HP	1 year	2016-03-21
10	Horn Antenna (1 ~ 18 GHz)	3115	00114105	ETS	1 year	2016-04-21
11	DRG Horn (Small)(18GHz ~40GHz)	3116B	81109	ETS-Lindgren	1 year	2016-05-03
12	DRG Horn (Small) (18GHz ~40GHz)	3116B	133350	ETS-Lindgren	1 year	2016-05-03
13	TRILOG Antenna	VULB 9160	9160-3237	SCHWARZBECK	2 year	2015-04-21
14	Temp. Humidity Data Logger	SK-L200TH II A	00801	SATO	1 year	2016-03-22
15	Splitter	1580	SL769	WEINSCHEL	1 year	2016-03-22
16	Power Divider	11636A	06243	HP	1 year	2016-09-12
17	DC Power Supply	6674A	3637A01657	Agilent	-	-
18	Frequency Counter	5342A	2826A12411	HP	1 year	2016-03-21
19	Power Meter	EPM-441A	GB32481702	HP	1 year	2016-03-22
20	Power Sensor	8481A	3318A94972	HP	1 year	2016-01-05
21	Audio Analyzer	8903B	3729A18901	HP	1 year	2016-09-12
22	Modulation Analyzer	8901B	3749A05878	HP	1 year	2016-09-12
23	TEMP & HUMIDITY Chamber	YJ-500	LTAS06041	JinYoung Tech	1 year	2016-09-12
24	Stop Watch	HS-3	812Q08R	CASIO	2 year	2016-03-22
25	LISN	KNW-407	8-1430-1	Kyoritsu	1 year	2016-09-12
26	Two-Lime V-Network	ESH3-Z5	893045/017	R&S	1 year	2016-03-21
27	UNIVERSAL RADIO COMMUNICATION TESTER	CMU200	106243	R&S	1 year	2016-03-21
28	Highpass Filter	WHKX1.5/15G-10SS	74	Wainwright Instruments	1 year	2016-03-21
29	Highpass Filter	WHKX3.0/18G-10SS	118	Wainwright Instruments	1 year	2016-03-21
30	Active Loop Antenna	FMZB1519	1519-031	SCHWARZBECK	2 year	2016-01-12
31	OSP120 BASE UNIT	OSP120	101230	R&S	1 year	2016-03-22
32	Signal Generator(100 kHz ~ 40 GHz)	SMB100A	177621	R&S	1 year	2016-03-22
33	Signal Analyzer (10 Hz ~ 40 GHz)	FSV40	101367	R&S	1 year	2016-03-22