

ALLIANCE-TR DAS

High power Remote Optic Unit

Installation and Operation Manual

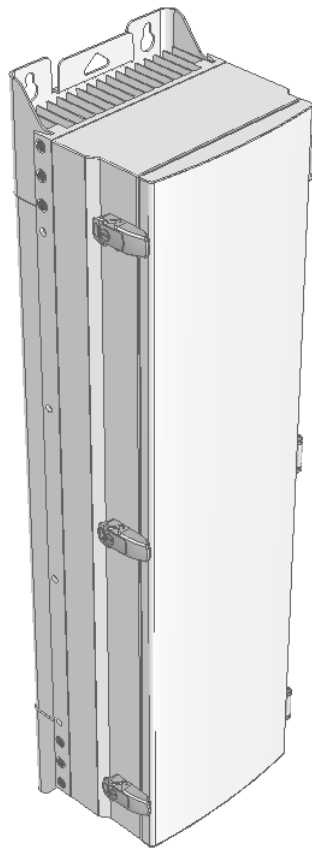

REVISION HISTORY

Version	Issue Date	Section	Initials	Details of Revision Changes
V 1.0	Dec. 29 2013		Original	
V 1.1	March 04 2014		2 ND Edition	
V 1.2	March 11 2014		3 RD Edition	
V 1.3	April 09 2014		4 TH Edition	
V 1.4	May 28 2014		5 TH Edition	
V1.5	May 16 2016		6 TH Edition	Add 1800_B
V1.6	May 26 2016		7 th Edition	Add Certification Spec.
V1.7	May 31, 2017		8 th Edition	Add AWS13
V1.8	Dec 31, 2017		9 th Edition	Add 1900P_40W, AWS13_40W
V1.9	June 8, 2018		10 th Edition	Add L800, L800_B
V2.0	July 24, 2018		11th Edition	Add L2300T
V2.1	May 02, 2019		12th Edition	Add L2600T_40W, L2600F_40W
V2.2	Jan 01, 2020		13th Edition	Add L2300_100TDD, L2500_100TDD
V2.3	Jan 12, 2021		14th Edition	Add APD modules :L800, 850C, L800_B, 1800_B, 1900P_B, U2100_B, L2600F_B_40W

Copyright

All rights are reserved ©2015 SOLiD. Confidential and proprietary. Information contained in this document is company private to SOLiD and should not be modified, used, copied, reproduced or disclosed in whole or in part without the written consent of SOLiD.

Trademark Information

No right, license, or interest to SOLiD trademarks is granted here. By using this document, you agree not to assert any right, license, or interest with respect to such trademark. Other product names mentioned in this manual are used for identification purposes only and may be trademarks or registered trademarks of their respective companies.

Disclaimer of Liability



The contents of this document, including graphics and screenshots, are current as of the date of publication. SOLiD reserves the right to change the contents without prior notice. In no event shall SOLiD be liable for any damages resulting from loss of data, loss of use or loss of profits. SOLiD further disclaims any and all liability for indirect, incidental, special, consequential or other similar damages. This disclaimer of liability applies to all products, publications and services during and after the warranty period.

Getting Support and Providing Feedback

To authorize technical support or to establish a return authorization for defective units, make sure you have the SOLiD serial numbers available. Serial numbers are located on the back of the unit, as well as on the box in which it was delivered. Contact SOLiD for additional support information:

For Central & Latin America Region: CALA.support@solid.co.kr

For Asia Pacific Region excluding Korea: APAC.support@solid.co.kr

For Europe, Middle East & Africa: EMEA.support@solid.co.kr

Contents

1.	<i>Safety & Certification Notice</i>	7
2.	<i>System Overview</i>	10
3.	<i>System Configuration and Functions</i>	13
■	HROU (High power Remote Optic Unit)	14
3.1.1	HROU Specifications	15
3.1.2	HROU Block Diagram	15
3.1.2.1	HMRU Block Diagram	15
3.1.2.2	HARU Block Diagram	16
3.1.3	HROU Components	17
3.1.4	List of HROU Components	18
3.1.5	HROU Bottom Panel	27
4.	<i>System Installation</i>	28
4.1.	HROU Installation	29
4.1.1	Tools	29
4.1.2	Install HROU Enclosure	30
4.1.3	Connecting HMRU with HARU	33
4.1.4	HROU Power Cabling	36
4.1.5	Connect Ground (GND) Terminal	37
4.1.6	Installing HRDU	39
5.	<i>HROU Operation</i>	42
5.1.	HROU	43
6.	<i>Specifications</i>	46
■	General Specifications	47
■	Electrical Specifications	48
■	Optical Specifications	49
■	Regulatory Conformity	49
■	Marking Plate	51

List of Illustrations

Figure 2.1 – HROU System Topology	11
Figure 4.1 – High power Remote Optic Unit (HROU).....	14
Figure 4.2 – HMRU Block Diagram.....	15
Figure 4.3 – HARU Block Diagram.....	16
Figure 4.4 – HROU Inside View	17
Figure 4.5 – High power Remote Drive Unit (HRDU)	19
Figure 4.6 – Remote Power Supply Unit.....	25
Figure 4.7 – R-Optic Module.....	26
Figure 4.8 – Remote Central Processing Unit	26
Figure 4.10 – HROU Bottom Panel	27
Figure 5.1 – High power Remote Optic Unit (HROU).....	30
Figure 5.2 –HROU Dimensions (Wall Mounting (mm)).....	31
Figure 5.3 – HROU Wall Mount Procedure.....	32
Figure 5.4 – Connecting HMRU with HARU	35
Figure 5.5 – Ground Terminal.....	37
Figure 5.6 – Ground Terminal.....	37
Figure 5.7 – Ground Terminal Installation	38
Figure 5.9 – HRDU Configuration.....	39
Figure 5.10 – Guide Rail	40
Figure 5.11 – HRDU Installed.....	41
Figure 5.12 – Installing Blank Card	41
Figure 6.1 – Level Diagram	43
Figure 6.2 – Detailed Information on HRDU	44



Figure 6.3 – HRDU Setting Window45

Version 1.7 –December 2017 ©2017 SOLiD. All Rights Reserved. Confidential & Proprietary.

www.solid.com

Safety & Certification Notice

Only qualified personnel should handle and install the DAS equipment. Any person involved in installation or service of the DAS should understand and follow these safety guideline:

1. Obey all general and regional installation and safety regulations relating to work on high voltage installations, as well as regulations covering correct use of tools and personal protective equipment.
2. The power supply unit in repeaters contains dangerous voltage level, which can cause electric shock. Switch the main power off prior to any work in such a repeater. Follow any local regulations when servicing repeaters. Never install or use electrical equipment in a wet location or during a lightning storm.
3. When working with units outdoors, make sure to securely fasten the door or cover in an open position to prevent the door from slamming shut in windy condition.
4. Use this unit only for the purpose specified by the manufacturer. Do not carry out any modifications or fit any spare parts which are not sold or recommended by the manufacturer. This could cause fires, electric shock or other injuries.
5. Do not operate this unit on or close to flammable materials, as the unit may reach high temperatures due to power dissipation.
6. Do not use any solvents, chemicals, or cleaning solutions containing alcohol, ammonia or abrasives on the DAS equipment. Alcohol may be used to clean fiber optic cabling ends and connectors.
7. Do not look into the ends of any optical fiber or directly into the optical transceiver of any digital unit. Use an optical spectrum analyzer to verify active fibers. Place a protective cap over any radiating transceiver or optical fiber connector to avoid the potential of radiation exposure.
8. Allow sufficient fiber length to permit routing without severe bend.
9. For pluggable equipment, make sure to install the socket outlet near the equipment so that it is easily accessible.
10. SOLiD recommends powering the system through wiring installed in a normal building. If powered directly from the main power distribution system, SOLiD recommends using additional protection, such as overvoltage protection device.
11. Ground terminals located on the rear of a 1.0mm² (16AWG) or more wires using permanently connected to earth.
12. Ensure only authorized service personnel can gain access to the system and understand all precautions related to handling or installing the equipment. SOLiD recommends using a lock and key or other means of security to control access to the system.

-
13. Some units may become hot during operation. Be careful not to touch the heat-sink of these units due to high temperature.

- Certification

- FCC: This equipment complies with the applicable sections of Title 47 CFR Parts 15, **22**, 24 and 90.
- UL/CUL: This equipment complies with UL and CUL 1950-1 Standard for safety for information technology equipment, including electrical business equipment.
- FDA/CDRH: This equipment uses a Class 1 LASER according to FDA/CDRH Rules. This product conforms to all applicable standards of 21 CFR Chapter 1, Subchapter J, and Part 1040.
- **Home/Personal use are prohibited..**
- **Use of unauthorized antennas, cables, and/or coupling devices not conforming with ERP/EIRP and/or indoor-only restrictions is prohibited.**

Notice: SOLiD recommends incorporating a readily accessible disconnect device external to the equipment.

Notice: SOLiD recommends powering the system through wiring installed in a normal building. If powered directly from the main power distribution system, it is recommended to use additional protection, such as overvoltage protection device.

- A. This equipment is categorized as "Pollution Degree 2".

- Licensing is required to be used in EU member states.
- **Signal booster warning label message should include**

WARNING. This is **NOT** a **CONSUMER** device. It is designed for installation by **FCC LICENSEES** and **QUALIFIED INSTALLERS**. You **MUST** have an **FCC LICENSE** or express consent of an FCC Licensee to operate this device. Unauthorized use may result in significant forfeiture penalties, including penalties in excess of \$100,000 for each continuing violation.

Notice: Ensure only authorized service personnel can gain access to the system and understand all precautions related to handling or installing the equipment. SOLiD recommends using a lock and key or other means of security to control access to the system.

Notice: Some units may become hot during operation. Be careful not to touch the Heat-sink part due to high temperature.

- A. A readily accessible disconnect device shall be incorporated external to the equipment.

Warning: This is a class A product. In a domestic environment, this product may cause radio interference in which cause the user to take adequate measures.

Caution:



Do Not Open Except at Approved Field Force Protective Work Station

System Overview

2.1 Purpose

Alliance TR (Total Hybrid Optical Repeater) DAS or Alliance-TR is a coverage system for outdoor services delivering high quality voice and data services at any site seamlessly. As a distributed antenna system, it provides analog and digital phone systems that are served in multiple bands. By greatly improving in-building radio environments and poor RSSI and Ec/Io, the system allows service providers and enterprise locations to deliver high-quality mobile voice and data services at any site whether a public institution or private facility, including:

- Shopping malls
- Hotels
- University campus areas
- Airports
- Subways
- Multi-use stadiums and convention centers

Alliance-TR supports both analog (AMPS) and digital (TDMA, CDMA and WCDMA) cellular systems in multiple bands through a single strand of fiber for the following communication standards and public interface protocols:

- Frequencies: 700MHz, 800MHz, **850MHz**, 900MHz, 1800MHz, 1900MHz, 2100MHz, 2300MHz, 2500MHz, 2600MHz
- Voice protocols: AMPS, TDMA, CDMA, GSM, iDEN
- Data protocols: LTE, EDGE, GPRS, WCDMA, CDMA2000, Paging

ALLIANCE-TR is a modular design that makes it easy to install. To provide desired frequency in the outdoor, simply insert a corresponding frequency module into each unit. As it delivers multiple signals with one optical cable, the system, in unibody type, does not require additional facilities whenever new frequency is added.

The system is featured with the following:

- Flexibility and Scalability
 - Support optical fiber ports up to 32
 - Clustering multiple-buildings (campus) as one coverage
- Modular design
 - Modular frequency upgrade
 - Hot swappable module for each band

- Add additional operators without the need for additional architecture
- Multi-band and Multi-operator
 - Signals from multiple operators transmitted simultaneously
 - Support for multiple operators in a band
- Low OPEX / CAPEX
 - Compact design
 - Upgradable design
 - Easy installation and maintenance

2.2 System Overview

Alliance-TR supports two types of High power Remote Unit (HROU):

- HMRU (High power Main Unit)
- HARU (High power Add on Unit)

The HMRU can support one HARU. The HMRU transmits and receives optical signals from and to the ODU. The optical link budget is maximum 10dBo from ODU to HROU, from ODU to OEU and from OEU to HROU when using the 1-port optic module (OM_1). And the link budget is 5dBo when using the 4-port optic module (OM_4). System topology is as below.

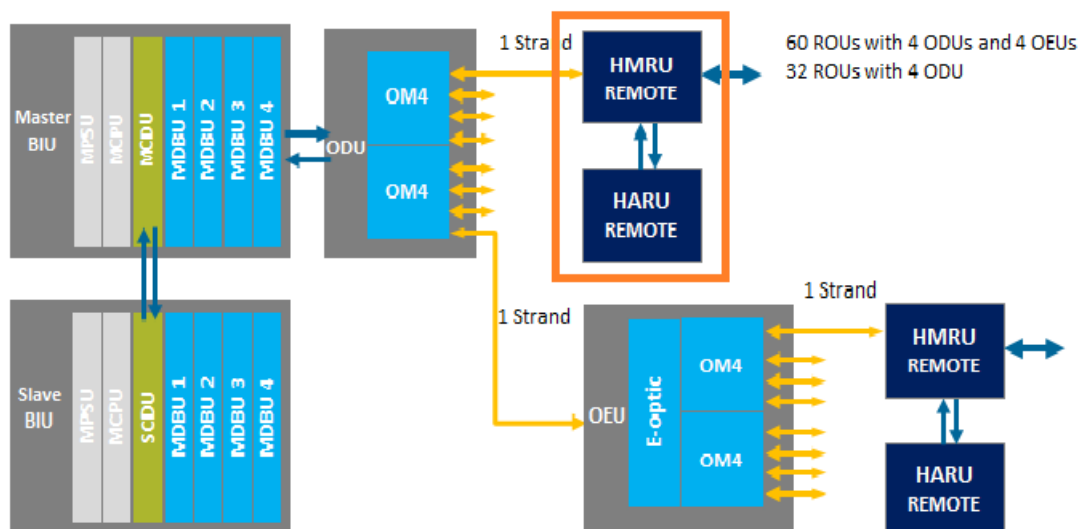

Figure 2.1 – HROU System Topology

Alliance-TR has the composite output power, 20W, for each band. The HRDU supports up to four HRDU modules. Each HRDU solt is designed to accept a specific HRDU.

Alliance-TR can transmit and receive signals from multiple operators with multiple technologies, and it can transmit the signals from the BTS to remote unit though the same fiber.



It is available in both single and multi-band configurations supporting various bands such as 700MHz, 800MHz, **850MHz**, 900MHz, 1800MHz, 1900MHz, 2100MHz, 2300MHz, 2500MHz and 2600MHz. It has been specifically tested under various air interfaces such as iDEN, GSM, CDMA2000, EV-DO, WCDMA, and LTE.



System Configuration and Functions

3.1 HROU (High power Remote Optic Unit)

1.1.1 HROU (High power Remote Optic Unit)

The HROU supports two types of remote units: High power Main Remote Unit (HMRU) and High power Add-on Remote Unit (HARU). The biggest difference between HMRU and HARU is whether R-Optic module exists or not in the enclosure. HMRU receives TX optical signals from the ODU. In the R-Optic module, these optical signals are converted to RF signals, divided into specific signal types, and then sent to the band-specific HRDU. Here the signals are amplified and radiated to a combiner or directly to an antenna port. For uplink signals, the HRDU filters RF signals received from the combiner in a cavity duplexer, amplifies them and sends them to the R-Optic module. The R-Optic converts the RF signals back to optical signals and sends them to the ODU.

When receiving RX signals through the antenna port, the HRDU filters out-of-band signals. After converted, the signals are sent to the BIU through the ODU. HMRU can be equipped with up to four HRDUs (High power Remote Drive Unit) and each HRDU supports single band only. HARU receives TX RF signals from HMRU and then the signals will be amplified by the high power amplifier in the HRDU, that is consisted with UDCU, PAU and Cavity duplexer, and then send them to the CU (Combiner Unit).

When the HARU receives RX signals through the antenna port, HRDU filters out-of-band signals and sends them to HMRU through RF cables.

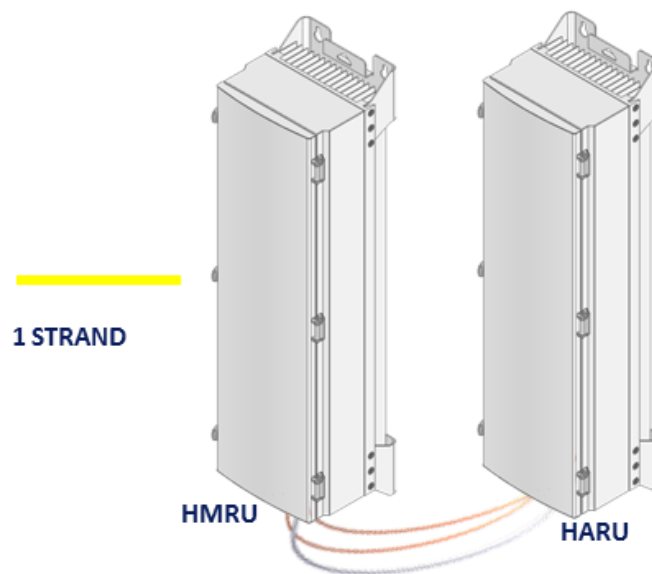

Figure 4.1 – High power Remote Optic Unit (HROU)

1.1.2 HROU Specifications

Item	Specifications		Remark
	HMRU	HARU	
Size (mm)	320 x 1165 x 260		Including Bracket
Weight	39Kg	37kg	Common Part Only
Power Consumption	50W	40W	

1.1.3 HROU Block Diagram

1.1.3.1 HMRU Block Diagram

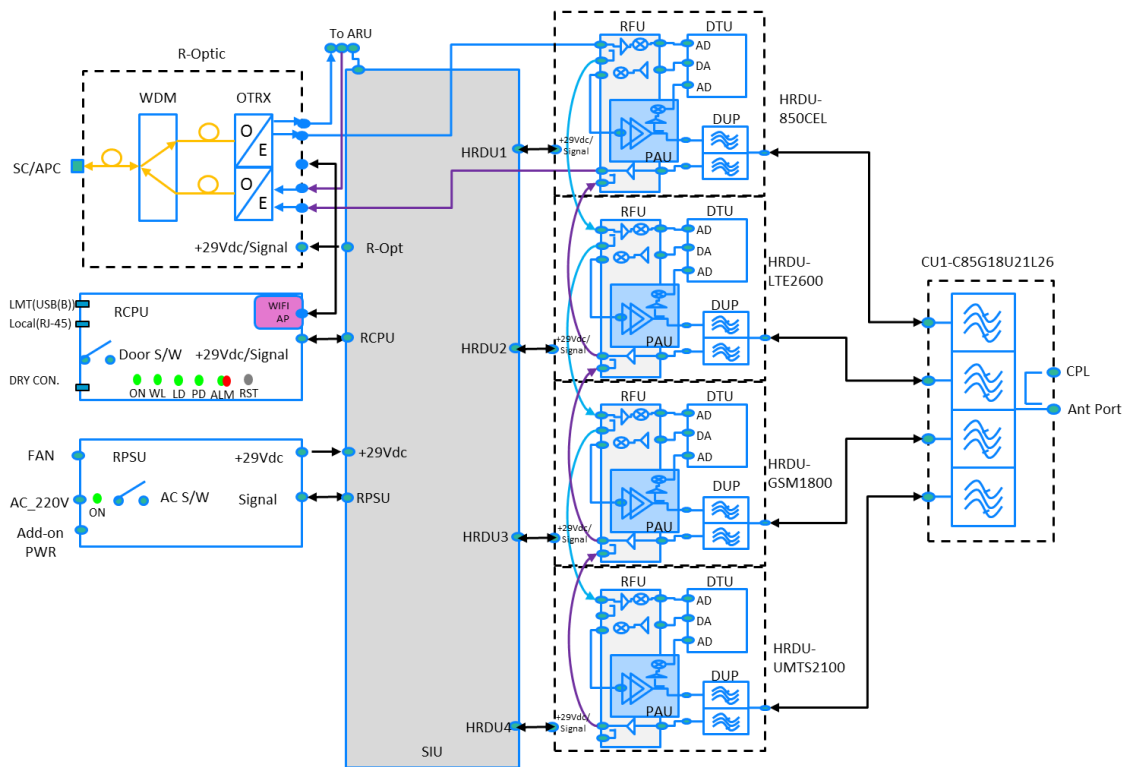

Figure 4.2 – HMRU Block Diagram

1.1.3.2 HARU Block Diagram

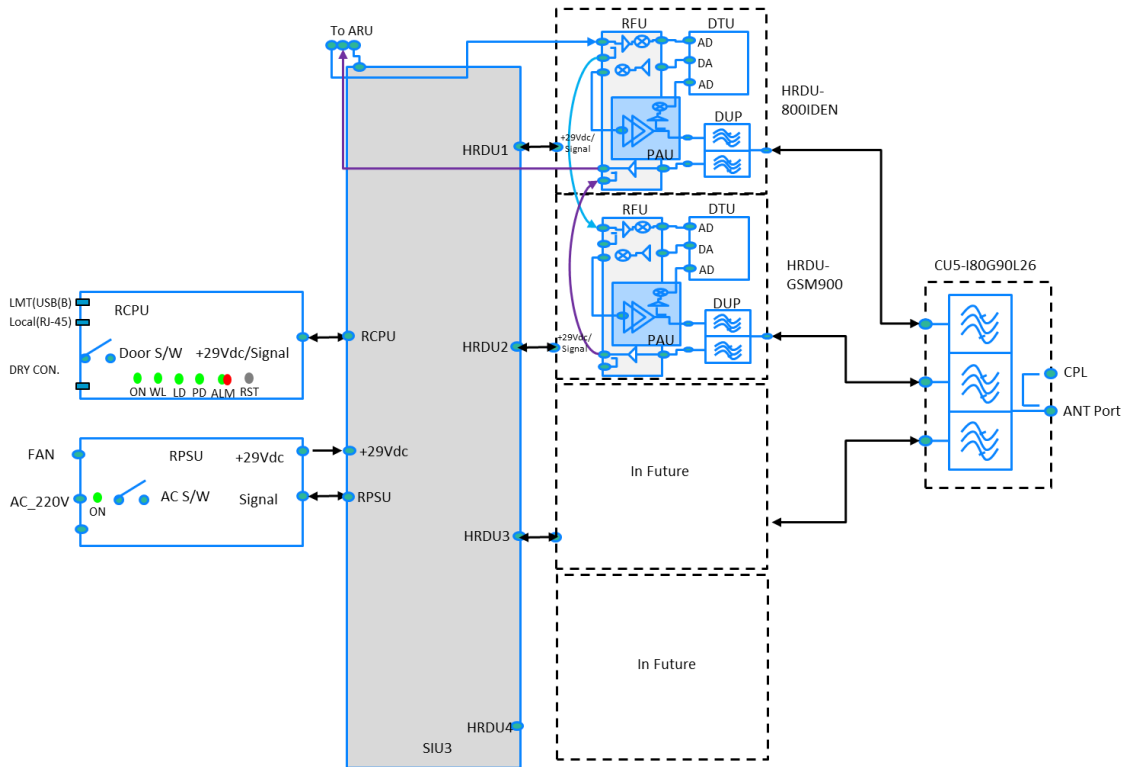

Figure 4.3 – HARU Block Diagram

1.1.4 HROU Components

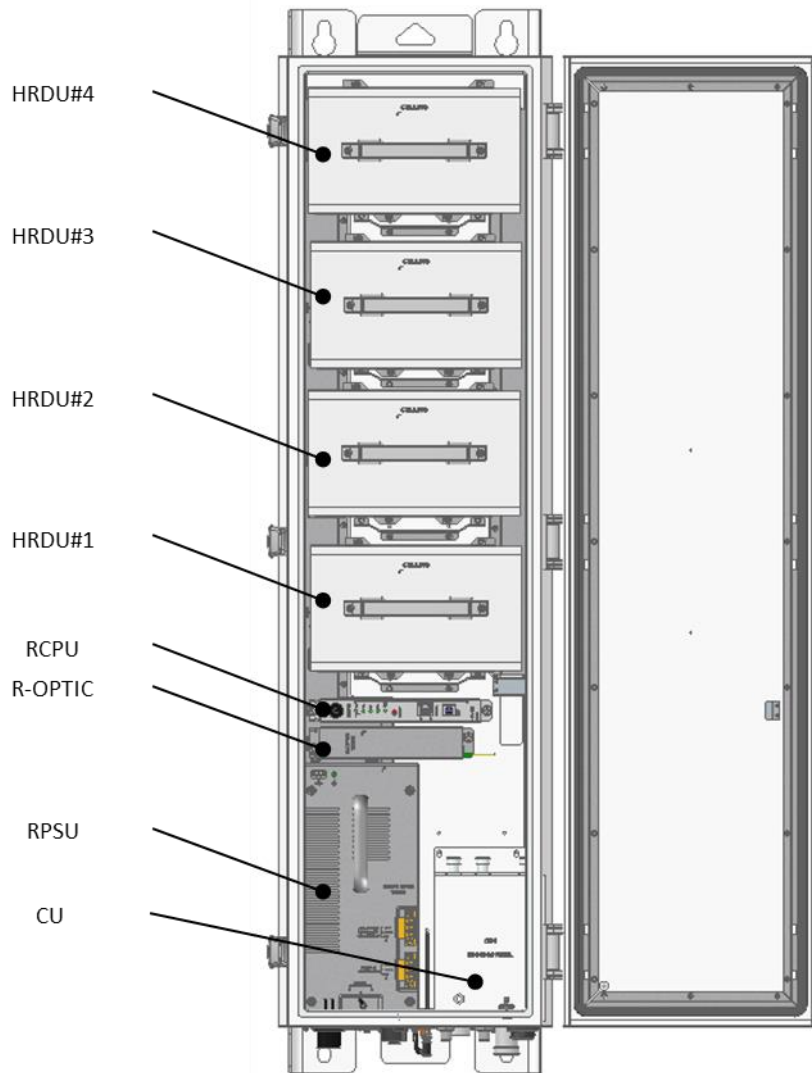

Figure 4.4 – HROU Inside View

1.1.5 List of HROU Components

No.	Unit	Description	Note
1	R-Optic	Remote Optic Converts downlink optical signals to RF Convert uplink RF signals to optical Compensates for optical loss Communicates with BIU/OEU though the FSK modem	Optional Only HMRU
2	RCPU	Remote Central Processor Unit Controls signal of each unit Monitors BIU/ODU/OEU status through Wi-Fi modem communication Support LED indicators to display alarms	Common
3	RPSU	Remote Power Supply Unit Input power: 90~230V, Output power: 29V single voltage	Common
4	HRDU	High Remote Drive Unit Consist of UDCU, PAU and Cavity filter Filter and amplify TX signals in high power amplifier Filter and amplify RX signals in low noise amplifier Remove out-of-signals through cavity duplexer	Optional Max. 4
5	Enclosure	Satisfy IP66 standard Wall/Rack mountable	Common

1) High Remote Drive Unit (HRDU)

When receiving TX signals from each band through R-Optic module, the HRDU filters signals and amplifies them with the high power amplifier. The unit also filters RX signals received from the cavity filter, and amplifies them to send the signals to the R-Optic module. The unit also offers the attenuator to adjust gain. The HRDU is consist of UDCU, DTU, PAU and cavity duplexer as shown below and all modules are merged with one package.

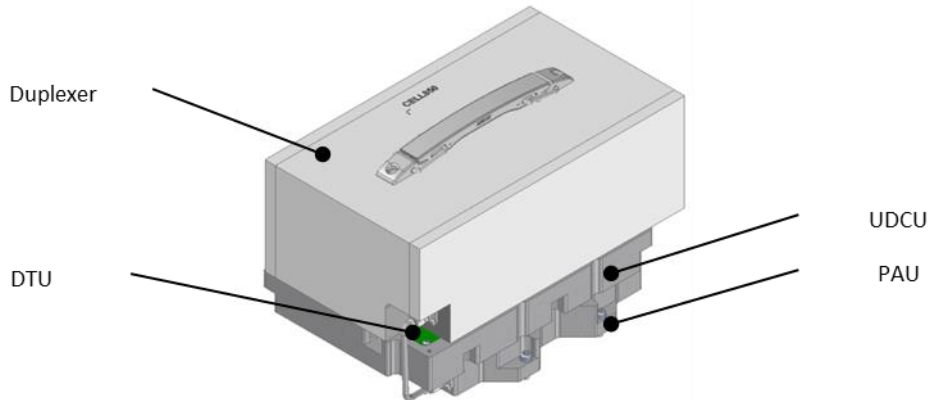

Figure 4.5 – High power Remote Drive Unit (HRDU)

The HRDU supports a single band, and currently available band configurations and SOLiD part numbers are as below.

No	SOLiD Part Number	Description	Frequency (MHz)	
			Downlink (TX)	Uplink (RX)
1	THOR-HRDU-800IDEN	Single band	851-866MHz	806-821MHz
2	THOR-HRDU-850CEL	Single band	869-894MHz	824-849MHz
3	THOR-HRDU-GSM900	Single band	935~960 MHz	880~915 MHz
4	THOR-HRDU_A_GSM1800	Single band	1805~1880 MHz	1710-1785 MHz
5	THOR-HRDU-1800_B	Single band	1805~1880 MHz	1710-1785 MHz
6	THOR-HRDU_A_U2100	Single band	2110~2170 MHz	1920~1980 MHz
7	THOR-HRDU-U2100_B	Single band	2110~2170 MHz	1920~1980 MHz
8	THOR-HRDU-LTE2600	Single band	2620~2690 MHz	2500~2570 MHz
9	THOR-HRDU-LTE2600_B	Single band	2620~2690 MHz	2500~2570 MHz
10	THOR-HRDU-1900P	Single band	1930~1995 MHz	1850~1915 MHz
11	THOR-HRDU-AWS13	Single band	2110~2180 MHz	1710~1780 MHz
13	THOR-HRDU-AWS13_B	Single band	2110~2180 MHz	1710~1780 MHz
14	THOR-HRDU-L800	Single band	791~821 MHz	832~862 MHz

15	THOR-HRDU-L800_B	Single band	791~821 MHz	832~862 MHz
16	THOR-HRDU-L700A	Single band	758~803 MHz	703~748 MHz
17	THOR-HRDU-L2300T	Single band	2300~2400 MHz	2300~2400 MHz
18	THOR-HRDU-L2300T_B	Single band	2300~2400 MHz	2300~2400 MHz
19	THOR-HRDU-1900P_40W	Single band	1930~1995 MHz	1850~1915 MHz
20	THOR-HRDU-AWS13_40W	Single band	2110~2180 MHz	1710~1780 MHz
21	THOR-HRDU-L2600T-40W	Single band	2575~2615 MHz	2575~2615 MHz
22	THOR-HRDU-L2600F-40W	Single band	2620~2690 MHz	2500~2570 MHz
23	THOR-HRDU_A_L2300_100TDD	Single band	2300~2400 MHz	2300~2400 MHz
24	THOR-HRDU_A_L2500_100TDD	Single band	2496~2690 MHz	2496~2690 MHz
25	THOR-HRDU_A_L800	Single band	791~821 MHz	832~862 MHz
26	THOR-HRDU_A_850C	Single band	869-894MHz	824-849MHz
27	THOR-HRDU_A_L800_B	Single band	791~821 MHz	832~862 MHz
28	THOR-HRDU_A_1800_B	Single band	1805~1880 MHz	1710-1785 MHz
29	THOR-HRDU_A_1900P_B	Single band	1930~1995 MHz	1850~1915 MHz
30	THOR-HRDU_A_U2100_B	Single band	2110~2170 MHz	1920~1980 MHz
31	THOR-HRDU_A_L2600F_B_40W	Single band	2620~2690 MHz	2500~2570 MHz

The table below shows dimensions, weight and power consumption of HRDU.

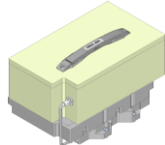
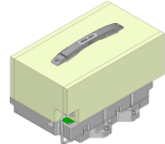
No	SOLID Part Number	Dimensions [mm]	Weight [kg]	Power Consumption [W]	Outlook
1	THOR-HRDU-800IDEN	233 x 155 x 143	4.9	150	
2	THOR-HRDU-850CEL	233 x 155 x 148	5.3	150	
3	THOR-HRDU-GSM900	233 x 155 x 148	5.6	150	

4	THOR-HRDU_A_GSM1800	233 x 160 x 111	4.4	160	
5	THOR-HRDU-1800_B	233 x 155 x 111	4.4	160	
6	THOR-HRDU_A_U2100	233 x 155 x 98	3.5	125	
7	THOR-HRDU-U2100_B	233 x 155 x 98	3.5	145	
8	THOR-HRDU-LTE2600	233 x 155 x 120	4.5	125	
9	THOR-HRDU-LTE2600_B	233 x 155 x 128	4.7	125	
10	THOR-HRDU-1900P	233 x 155 x 131	4.5	150	
11	THOR-HRDU-AWS13	233 x 155 x 98	3.5	125	

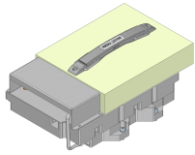
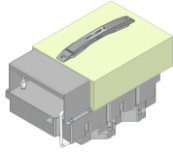
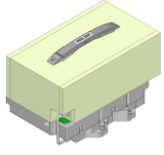
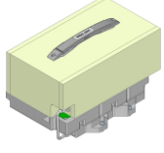
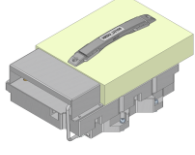
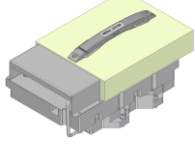
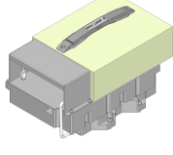
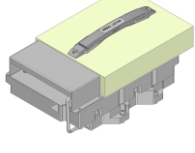
12	THOR-HRDU-AWS13_B	233 x 155 x 98	3.5	140	
13	THOR-HRDU-L800	233 x 155 x 139	4.8	135	
14	THOR-HRDU-L800_B	233 x 155 x 148	5.4	140	
15	THOR-HRDU-L700A	233 x 155 x 148	5.2	140	
16	THOR-HRDU-L2300T	233 X 155 X 95	4.3	140	
17	THOR-HRDU-L2300T_B	233 X 155 X 95	4.3	140	
18	THOR-HRDU-1900P_40W	233 x 155 x 131	4.5	180	
19	THOR-HRDU-AWS13_40W	233 x 155 x 98	3.7	190	

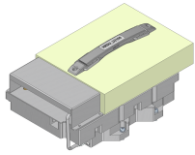
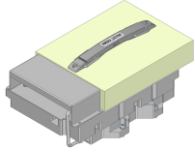
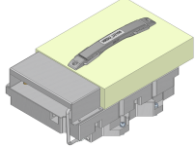
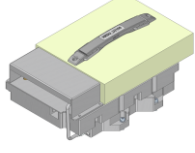
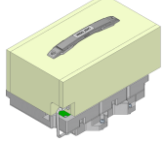
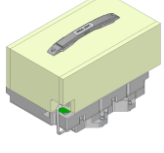
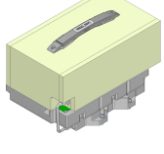
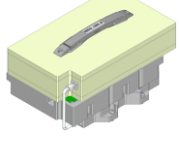
20	THOR-HRDU-L2600T_40W	233x 155 x 98	4.5	190	
21	THOR-HRDU-L2600F_40W	233x 155 x 148	4.5	230	
22	THOR-HRDU_A_L2300_100TDD	233x 155 x 98	4.3	135	
23	THOR-HRDU_A_L2500_100TDD	233x 155 x 98	4.3	135	
24	THOR-HRDU_A_L800	233 x 155 x 148	4.3	135	
25	THOR-HRDU_A_850C	233 x 155 x 148	4.5	135	
26	THOR-HRDU_A_L800_B	233 x 155 x 148	3.7	140	
27	THOR-HRDU_A_1800_B	233 x 155 x 111	4.0	140	

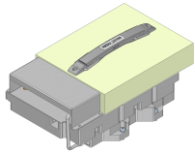
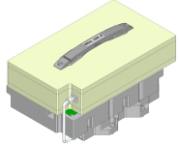
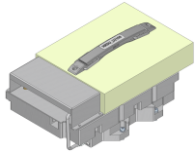
28	THOR-HRDU_A_1900P_B	233 x 155 x 111	4	140	
29	THOR-HRDU_A_U2100_B	233 x 155 x 111	4.3	140	
30	THOR- HRDU_A_L2600F_B_40W	233x 155 x 148	4.5	210	

2) Remote Power Supply Unit (RPSU)

The RPSU is available with AC or DC power options. AC input power should be 110/220VAC. For DC input power should be -48VDC. The output power for AC and DC is +29V.

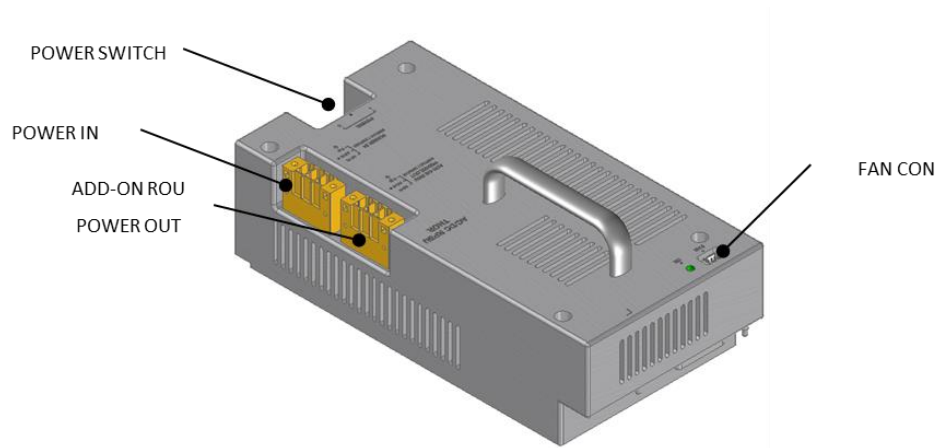

Figure 4.6 – Remote Power Supply Unit

Functions:

- Providing a circuit breaker to turn AC power ON/OFF
- Providing DC power to each HRDU
- Providing DC power and signal to FAN tray
- LED indicators to display PSU alarm status



Caution

DOUBLE POLE/NEUTRAL FUSING

3) Remote Optic Moduel (R-Optic)

Remote Optic Module (R-Optic) converts optical signals into RF signals and RF back to optical. It also has an internal attenuator (ATT) to compensate optical cable losses. The R-Optic has the two paths, one for HMRU and other one for HARU.

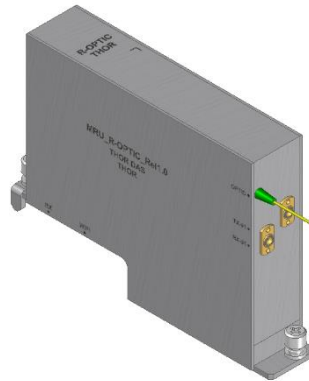

Figure 4.7 – R-Optic Module

4) Remote Central Processor Unit (RCPU)

The Remote Central Processor Unit (RCPU) can monitor and control each module of HROU. This unit receives and analyzes data from the R-Optic module and communicates status to the BIU. LED indicators on the front panel show system status, letting you check any abnormality. Communication LED Indicators also located on the front panel to show communication status with the BIU. A RESET button on the front panel is available to restart the CPU. LED indicators on the front panel provides status for: Power (Green = normal; Red = no power), Downlink (TX) signaling and Uplink (RX) signaling (Green = normal operation; Red = link failure or power levels above/below reference levels), and Active Alarm conditions (Green = no active alarms; Red = active alarm exists).

It provides three interface ports to communicate with the HARU. It also provides dry contact port, which is a single output port and a single input port.

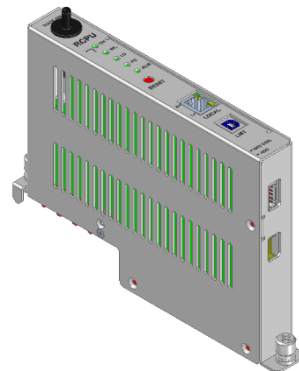

Figure 4.8 – Remote Central Processing Unit

HROU Bottom Panel

1) Functions

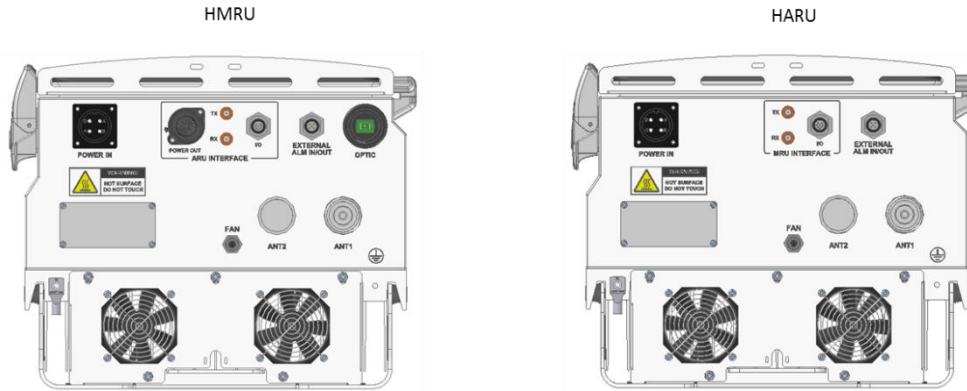

Figure 4.10 – HROU Bottom Panel

No	Port	HMRU	HARU	Remark
1	Optical Port	1EA	X	SC/APC, Waterproof
2	HARU Interface	1EA, (1)CON, (2)SMA-Female	1EA, (1)CON, (2)SMA-Female	
3	ANT1	1EA	1EA	DIN-type female
4	ANT2	1EA	1EA	DIN-type female
6	AC Power IN	1EA	1EA	MS-Con, Waterproof
7	AC Power OUT	1EA	-	MS-Con, Waterproof
8	EXT-FAN	1EA	1EA	Waterproof Connector

System Installation



4.1 HROU Installation

This chapter describes how to install each unit and optical cabling, power cabling, and RF interface. In this section, the power consumption of each unit, much simpler power cabling budget, the quantity of components of modules, and expansion method can be found.

4.1. HROU Installation

1.1.6 Tools

Tools needed for installation can be found in the table below

No	Tools	Q'ty	Specifications	Remark
1		1	+ , 3Ø Length is more than 20mm.	Use it for tightening HRDU
2		1	33mm	Use it for tightening antenna port
3		1	19mm	Use it for CU N-type port

1.1.7 Install HROU Enclosure

The HROU is designed to withstand water and dirt. This unit uses a unibody enclosure and satisfies water-proof and quake-proof standards equivalent to NEMA 4 (IP66). The same method is used for installing both HMRU and HARU. The HROU enclosure can be mounted on a wall, ceiling or pole, and the mounting brackets are included in the package.

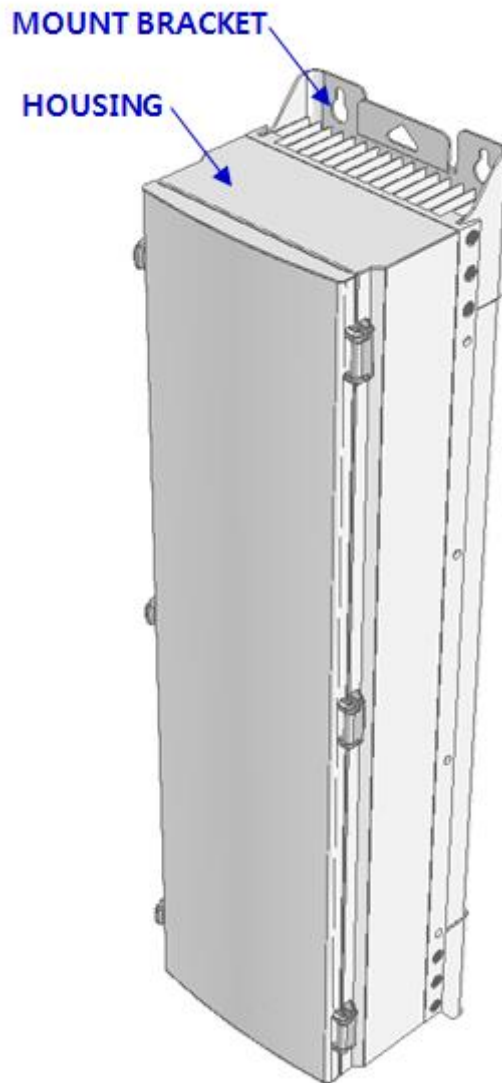

Figure 5.1 – High power Remote Optic Unit (HROU)

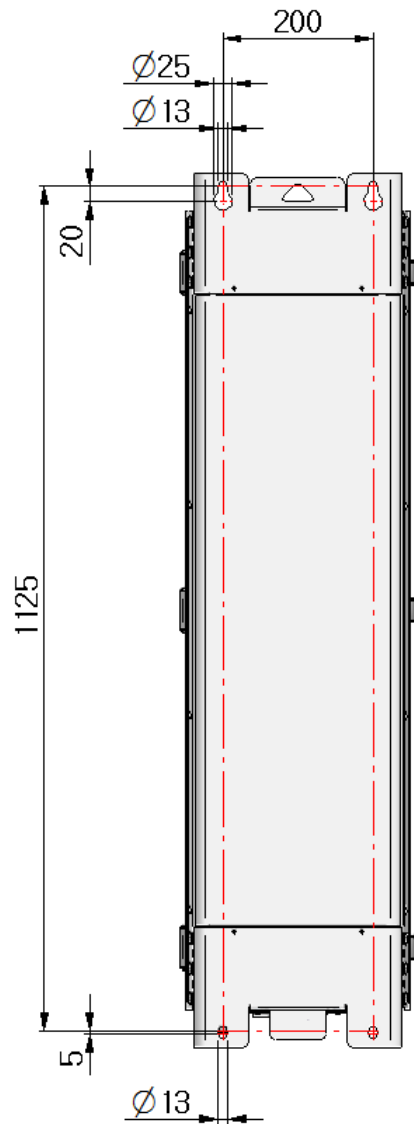

Figure 5.2 –HROU Dimensions (Wall Mounting (mm))

Wall Mount the HROU

The HROU ships with the installation bracket. It does not need to remove the bracket to install the enclosure.

1. Install two of M12 mounting bolts roughly half way into the wall to align with the top mounting bracket. Guide the top bracket over the bolts and secure tightly.
2. Install the remaining two M12 mounting bolts at the bottom of the enclosure and secure tightly.

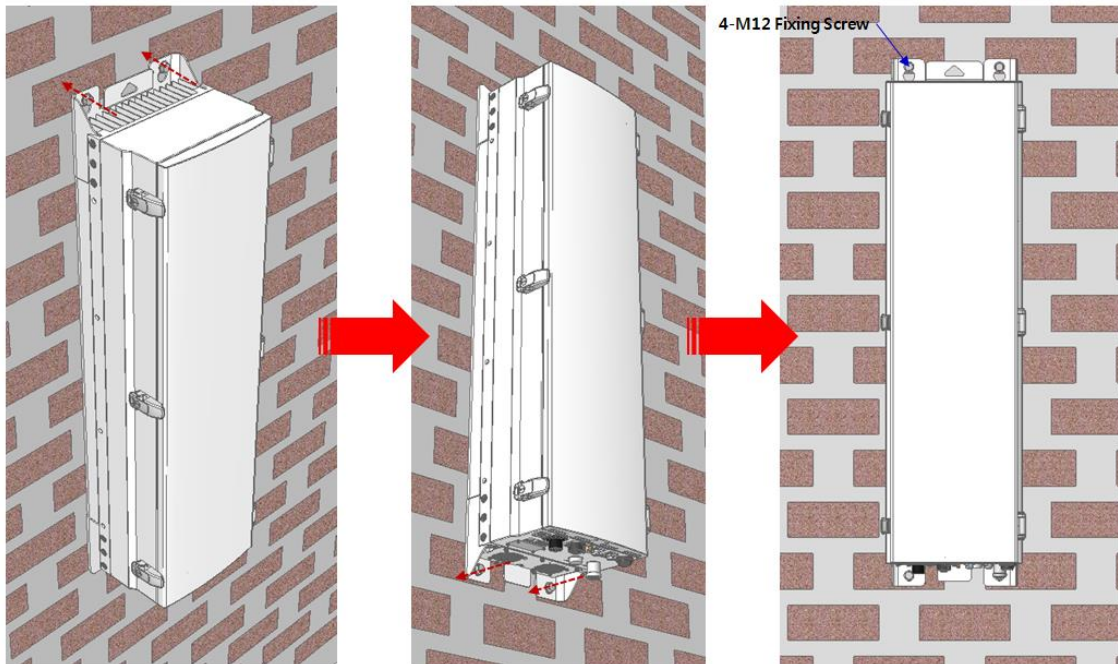

Figure 5.3 – HROU Wall Mount Procedure

HROU components



HROU has the following components:

No.	Unit	Description	Remark
Common Part	Enclosure	Wall mounting bracket included	1EA
	RCPU	-	1EA
	R_OPTIC	With SC/ACP adaptor (only HMRU)	1EA, optional
	RPSU	AC 110/220V	1EA
	FAN UNIT	2 FANs are included	1EA
	Power Cable1	- MS connector with 4 holes (AC)	1EA, HMRU
	Power Cable2	- MS connector for connecting with HARU with the Circular type	1EA, HARU
HMRU	HRDU	THRO-HRDU-900 THOR-HRDU-1800 (or THOR-HRDU-1800_B) THOR-HRDU-U2100 (or THOR-HRDU-U2100_B) THOR-HRDU-LTE2600 (or THOR-HRDU-LTE2600_B)	THOR-ICU- LB1LB2P19A 13HB, THOR-ICU- LBG90G18U 21HB

1.1.8 Connecting HMRU with HARU

The HMRU can be connected with a single HARU for band expansion. To connect the HMRU to HARU, the three items, shown below are required.

Accessory	Description	Qty	Specification	Remark
1	TX RF Cable	1	SBA(M) ST_1.5M	

3	I/O Cable	1	IEC 61076-2-101(8pin_F) ST_1.5m	
4	Power Cable	1	MIL-5015 (18-10_F) ST to Circular (eco mate 3+PE_M) ST_1.5m	

The following figure shows the connection between HMRU and HARU. The cables for connecting HARU and HMRU are provided, and the recommended cable length is 1.5m each.

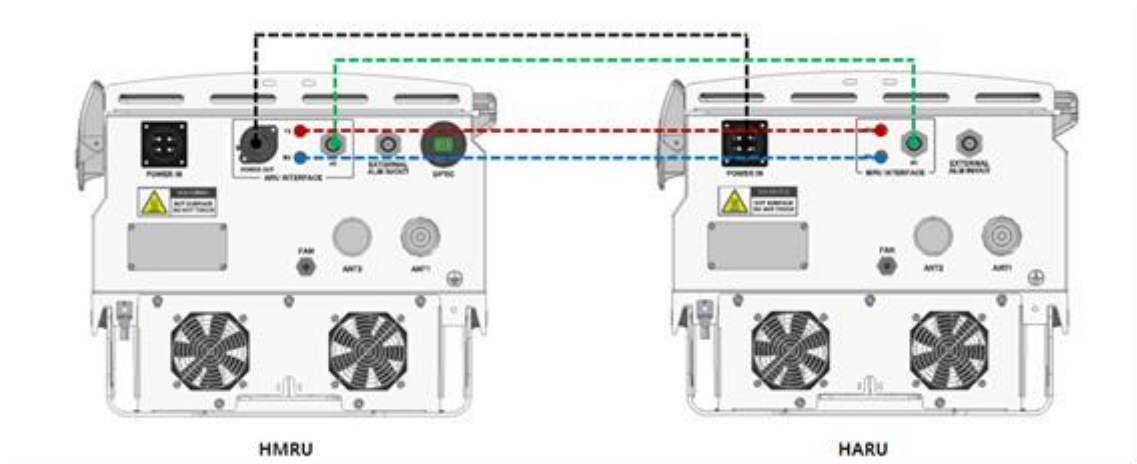
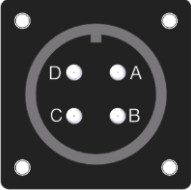

Figure 5.4 – Connecting HMRU with HARU

1.1.9 HROU Power Cabling

The HROU is available with AC110V or AC220V for input power. The power connector should be fitted with appropriate slots, and can only be installed one way. For your information, the table shows the voltage pin-out of the power port.

Power Port	MS Connector numbering	Name	Description
<p>AC POWER</p>  <p>A : AC_H B : AC_N C : N.C D : F.G \perp</p>	A	AC_H	AC Hot
	B	AC_N	AC Neutral
	C	N.C	Not Connected
	D	F.G	Frame Ground

Check the connections again to ensure they are properly installed like the instructions in the table above, and make sure to turn on the power. The AC power cable provided for HROU is as shown below.

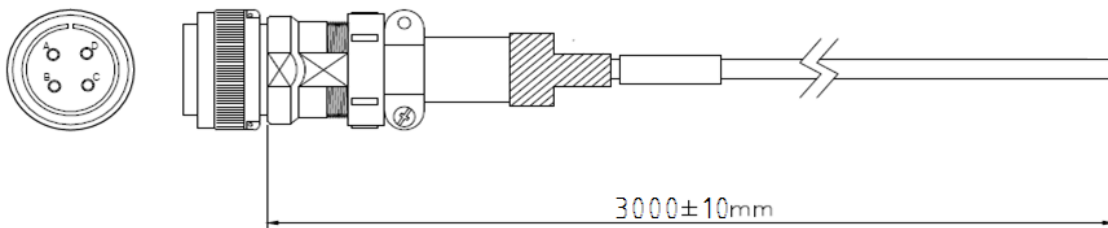

1.1.10 Connect Ground (GND) Terminal

The HROU has one ground terminal port located at the bottom of the unit fixed with an M6 screw. A compression terminal ships with the unit and comes already attached. SOLiD recommends using AWG #6 copper grounding wire.

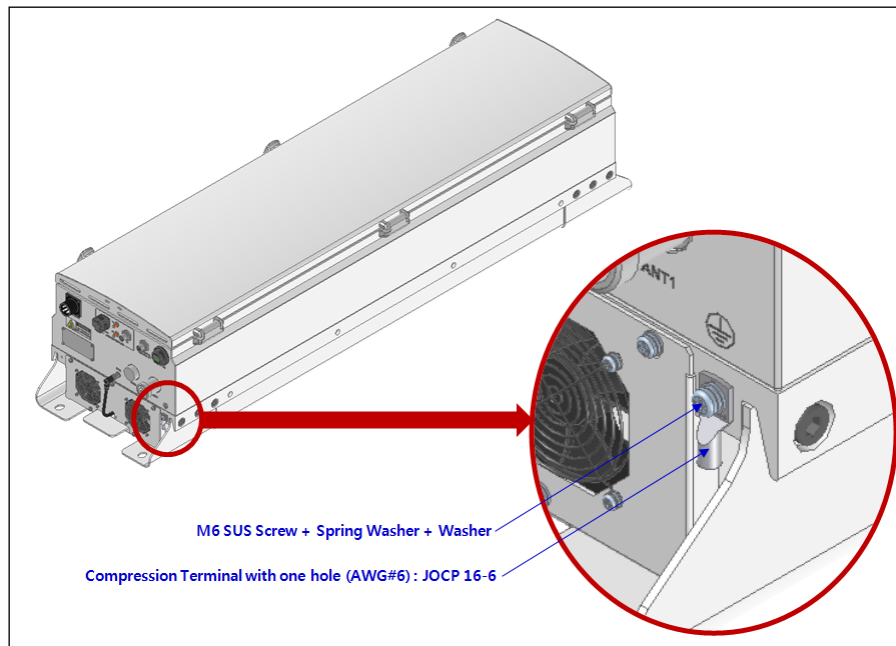
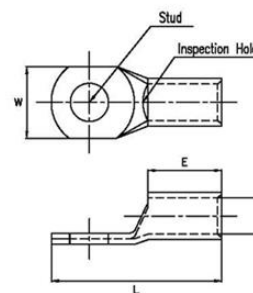

Figure 5.5 – Ground Terminal

The specification of compression terminal is as follows:

TUBULAR CABLE LUGS, ONE-HOLE, ROUND COMPRESSED TYPE-CP

- Material : Electrolytic Copper (TPC)
- Surface : Tin Plated
- With Inspection Hole to visually assure full Conductor insertion.
- Color Coded to Show Proper Die Number and Color 10 and 70
- To IEC 60228 Class 2 and Class 5
- UL Listed 486A-486B up to 35KV



Part Number	Wire Range				Stud Size	Dimension (mm)				Code Cable Die Color & No.	Q'ty/ bag
	CODE		FLEX			W	E	L	d		
	AWG	mm ²	AWG	mm ²							
JOCP 16-5	6	16	6	16	M5	12	13	29	5.4	Blue 24	300
JOCP 16-6					M6						
JOCP 16-8					M8						
JOCP 16-10					M10						

Figure 5.6 – Ground Terminal

The required part number is JOCT 16-6 supporting AWG #6. When installing ground terminal, refer to the figure below.

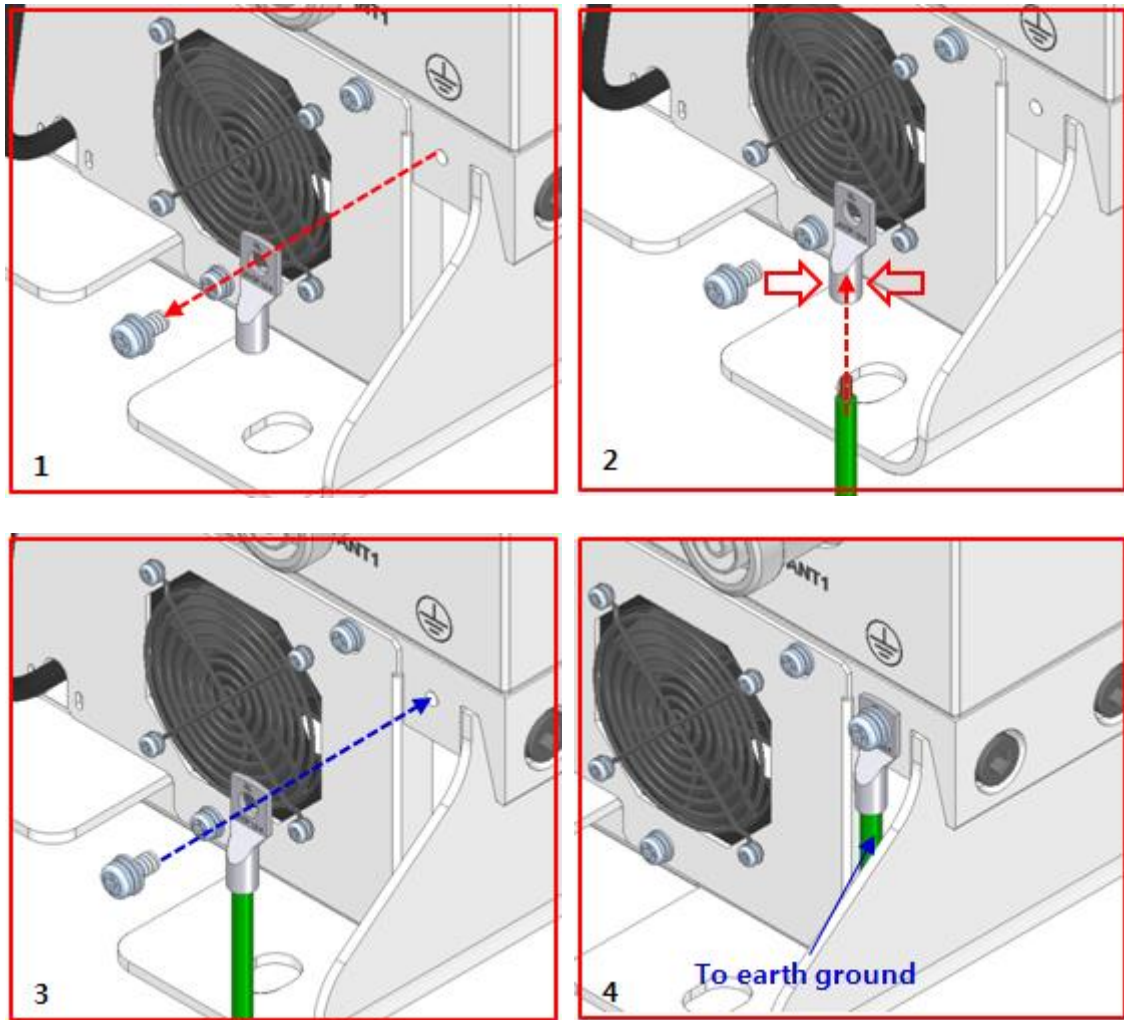

Figure 5.7 – Ground Terminal Installation

The procedures are;

1. Loosen two M6 screws and then remove the compression terminal from the enclosure.
2. Insert AWG #6 grounding wire into the terminal and then crimp the terminal around it.
3. Re-connect the terminal to the enclosure.
4. Cut the ground wire to the proper length and connect to the communication GND of the building.

1.1.11 Installing HRDU

The HROU supports up to four HRDU modules. The HRDUs can be installed in any slot.

optical

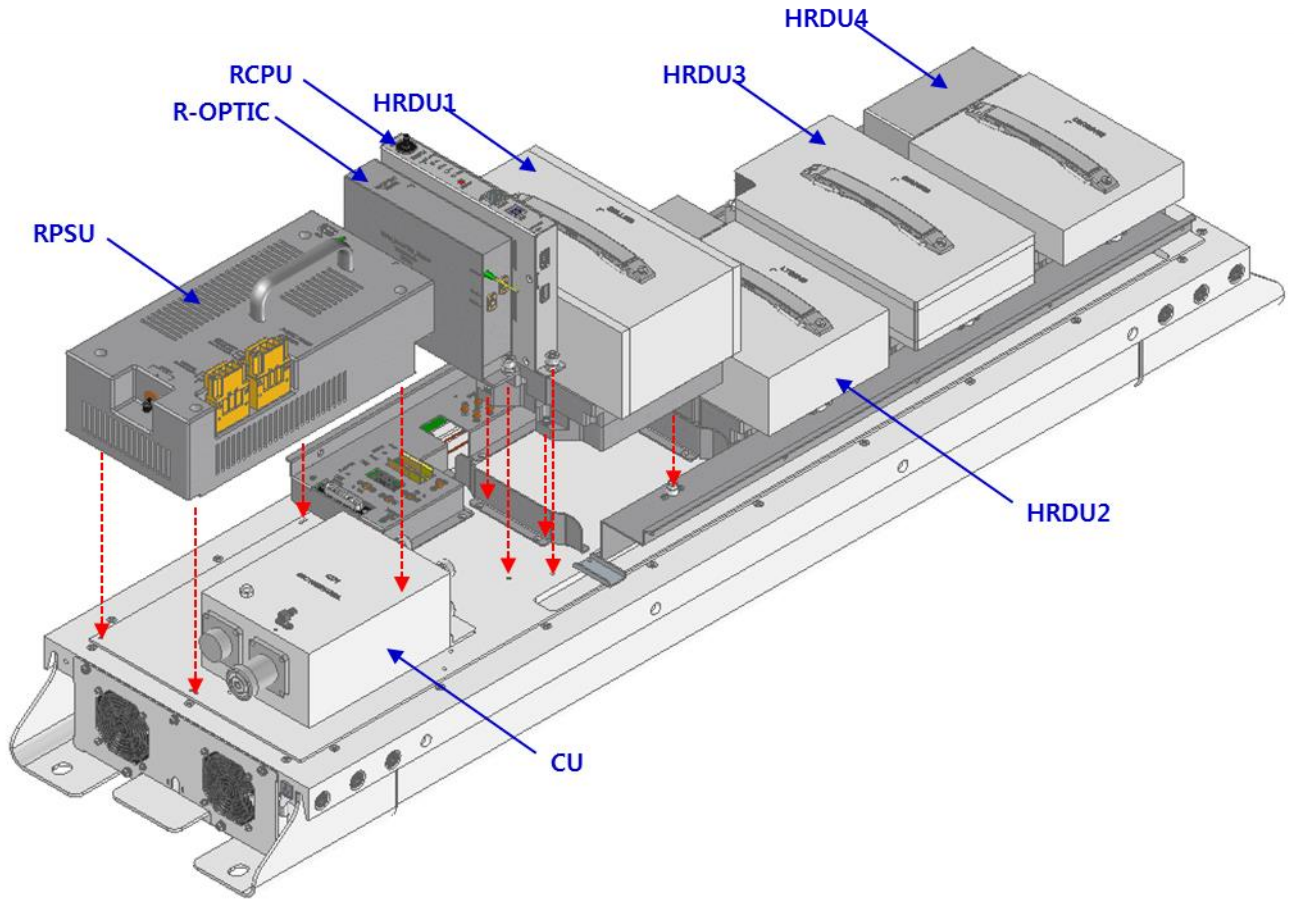

Figure 5.9 – HRDU Configuration

Guide brackets on the bottom of each HRDU slot simplify installation. The screws for securing HRDU on the heat-sink are already included with the unit and, thus simplifying the installation.

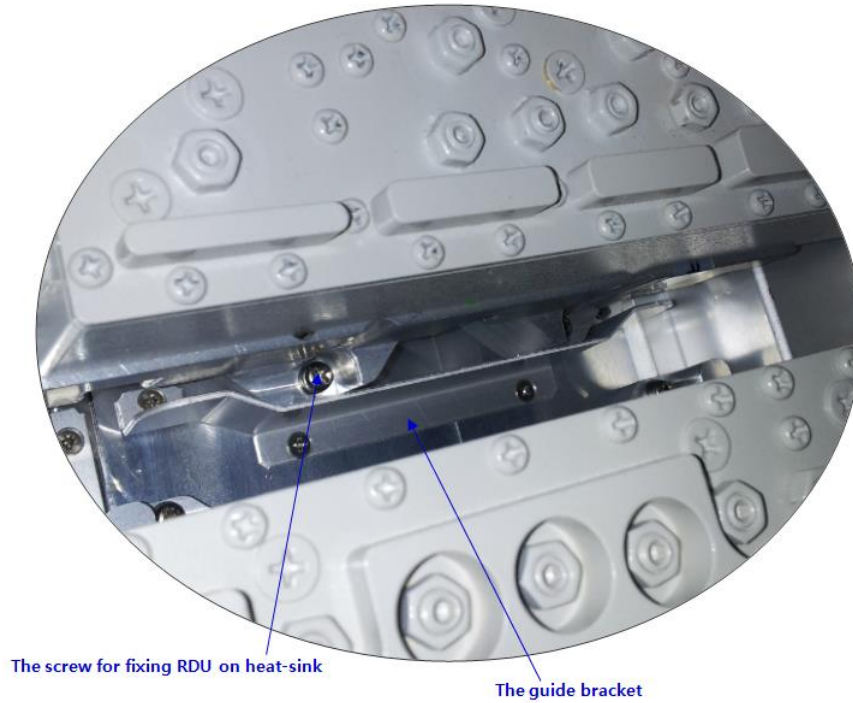

Figure 5.10 – Guide Rail

Insert the HRDU into the corresponding slot in the direction of the heat sink, and tighten 4 screws to secure the unit using M3 screw driver.



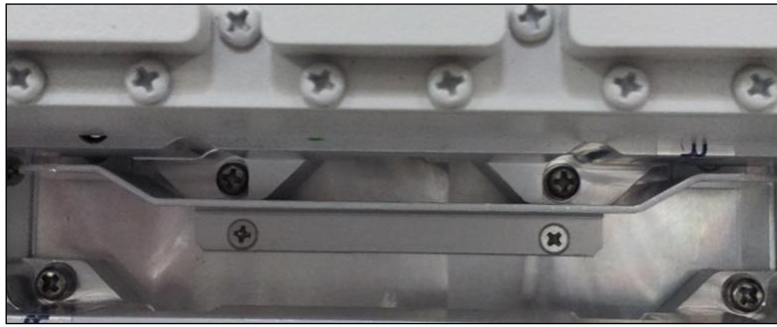

Figure 5.11 – HRDU Installed

Install blank cards in any unused slots as shown below. It can be inserted or be removed easily by tightening or loosening the captive screw in unused slots.



Figure 5.12 – Installing Blank Card



HROU Operation

5.1. HROU

The figure below shows the level of the system link of Alliance-TR DAS (BIU-ODU-HROU). This section describes HROU-related devices. When receiving downlink signals from each band through the R-Optic module, the HROU filters the signals and amplifies them with the high power amplifier.

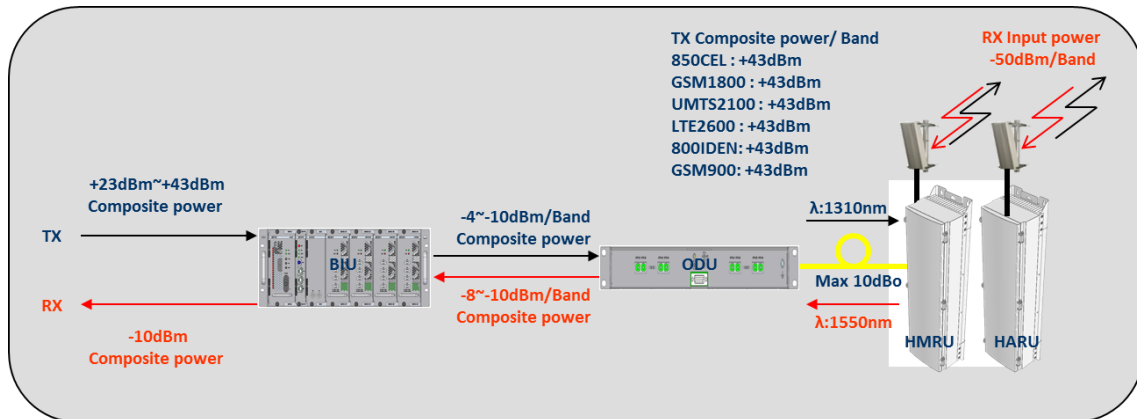

Figure 6.1 – Level Diagram

1) LED Indicator

Turn on power to the HROU and then check the LED indicators at the front of each HROU. The table below shows normal and abnormal cases depending on the status of each module.

Unit	LED	Description	
RCPU	ON	Green: Power is supplied.	
	LD	Green	Green: Laser Diode is normal.
		Red	Red: Laser Diode is abnormal.
	PD	Green	Green: Photo Diode is normal.
		Red	Red: Photo Diode is abnormal; check optical cables.
	WL	Green flicker	Green flicker: transmitting/receiving data with BIU
ALM	Green	Green: HROU system is normal.	
	Red	Red: HROU system is abnormal; check the alarm.	
RPSU	AC Status	Green	Green: Power is supplied.
		Red	Red: Power is not supplied.

2) HRDU Setting

The HROU accepts up to four HRDUs and it was explained in the chapter 4 as well. Through GUI, a user can control and monitoring status of HRDU modules. When you click a HRDU as shown below, the band information will be displayed.

STATUS		
	BAND ID	PATH
RDU #4	U2100	-
RDU #3	1800	-
RDU #2	AWS13	-
RDU #1	900	-
Current Status		■
ACTIVE ALARMS		0

Figure 6.2 – Detailed Information on HRDU

If a band ID is displayed, follow the steps below.

- 1) Turn TX AMP on.
- 2) Check if the level of TX OUT POWER is appropriate.
- 3) Check the alarms. If an alarm occurs, contact SOLiD for more information.

HRDU

STATUS		ALARMS		PARAMETERS			
	TYPE	900		<input checked="" type="checkbox"/> RDU DISCONNECT	<input checked="" type="checkbox"/> AMP ALARM	RDU Version	9.9
	Current Status	<input checked="" type="checkbox"/>		<input checked="" type="checkbox"/> TX OUT HIGH	<input checked="" type="checkbox"/> AMP OVER PWR.	TEMPERATURE	40 °C
	ACTIVE ALARMS	0		<input checked="" type="checkbox"/> TX OUT LOW	<input checked="" type="checkbox"/> AMP HIGH TEMP	Serial Number	R15100002
	RDU RESET	<input type="button" value="Reset"/>		<input checked="" type="checkbox"/> TX OUT SHUTDOWN	<input checked="" type="checkbox"/> RX IN SHUTDOWN		
				<input checked="" type="checkbox"/> HIGH RETURN LOSS	<input checked="" type="checkbox"/> PLL UNLOCK		

TX PATH		RX PATH		INSTALLATION PARAMETER							
TX OUT POWER	---	dBm[15~47]		RX IN POWER	---	dBm[-70~-30]		Return Loss	---	dB[0~30]	
TX OUT ATT	2	dB[0~25]		RX IN ATT	2	dB[0~20]		High Return Loss Threshold	6	dB[0~30]	
TX AMP ON/OFF	<input type="button" value="OFF"/>			RX AMP ON/OFF	<input checked="" type="button" value="ON"/>						
TX OUT HIGH Threshold	34	dBm[15~47]									
TX OUT LOW Threshold	20	dBm[15~47]									
TX OUT ALC	<input checked="" type="button" value="ON"/>	33	dBm[15~43]		RX IN ALC	<input checked="" type="button" value="ON"/>	-50	dBm[-70~-30]			
TX OUT SD	<input checked="" type="button" value="ON"/>	35	dBm[15~45]		RX IN SD	<input checked="" type="button" value="ON"/>	-35	dBm[-70~-30]			
TX OUT Target	<input type="button" value="OFF"/>	33	dBm[15~43]		RX CW Generator	<input type="button" value="OFF"/>					
Result	Success										

DTU

DTU Status											
APP Version	0.7.21	LEO Version	7.0.04	FPGA Done	<input checked="" type="checkbox"/>	Batch Done	<input checked="" type="checkbox"/>	DAC Done	<input checked="" type="checkbox"/>		
Batch Version	7.1.10	DPD Cal. FAIL	<input checked="" type="checkbox"/>	FPGA PLL Unlock	<input checked="" type="checkbox"/>	Power noff	<input checked="" type="checkbox"/>	Power Good	<input checked="" type="checkbox"/>		

Figure 6.3 – HRDU Setting Window

Use various upper and lower limits. The following table shows recommended limit settings:

Item	Recommended Limit	Remark
TX OUT HIGH ALM	Max. Composite Power +1dB	Alarm
TX OUTPUT LOW ALM	20dBm	Alarm
TX OUTPUT ALC	Max. Composite Power	Auto Level Control
RX ALC	-45dBm	

TX OUTPUT HIGH ALM: If the current value is higher than a setting value, alarm will be issued.

TX OUTPUT LOW ALM: If the current value is lower than a setting value, alarm will be issued.

TX OUTPUT HIGH ALM/LOW ALM tend to work only as warning. When you activate (“ON”) RX ALC, inputs will be restricted depending on a setting value.



Specifications

6.1. General Specifications

General Data		
Nominal Impedance		50 ohm
VSWR		1.5:1 at all input & out ports
Mounting Type		Wall Mounting
Type of Input & Output Ports		DIN Female DIN Female (7/16)
Front Panel LED Indicator	ON	Power ON: Green, Power OFF: Gray
	ALM	Power ON: Green, Alarm: Red
	LD	Normal: Green, Alarm: Red
	PD	Normal: Green, Alarm: Red
	WL	Green LED flickering: Communication Status
Noise Figure		6dB
Ripple		±2dB
Maximum Power Consumption		630W at full load
HMRU Dimensions (W x H x D)		320 x 1165 x 260 mm
Weight		57 kg
Power Supply Range		110/220V ± 10% AC(90V ~ 230V)
Optical Data		
Wavelength TX/RX		1310/1550nm
Maximum Optical Loss		10dBo
Fiber Optic Connector		SC/APC

Environmental Data	
Environmental Condition & IP Rating	Satisfy IP66 standards
Operating Temperature (°C)	-25° ~ +55°C (* -25° ~ +50°C when two 20W HRDUs and two 40W HRDUs are installed)
Operating Humidity	5~ 90% non-condensing

6.2. Electrical Specifications

Part Name	Service Band	Downlink (Tx)			Uplink (Rx)	
		Freq. (MHz)	Bandwidth (MHz)	Output Power (dBm)	Freq. (MHz)	Bandwidth (MHz)
TR_HRDU_900	GSM 900	925~960	35	40 (GSM 900)	880~915	35
	UMTS 900			43 (UMTS 900)		
	LTE 900			43 (LTE 900)		
TR_HRDU_A_U2100	UMTS 2100 LTE2100	2110~2170	60	43	1920~1980	60
TR_HRDU_U2100_B	UMTS 2100 LTE 2100	2110~2170	60	43	1920~1980	60
TR_HRDU_A_1800	GSM 1800	1805~1880	75	40(GSM)	1710-1785	75
	LTE 1800			43(LTE)		
TR_HRDU_1800_B	LTE 1800	1805~1880	75	43	1710-1785	75
TR_HRDU_L2600F	LTE 2600	2620~2690	70	43	2500~2570	70
TR_HRDU_L2600F_B	LTE 2600	2620~2690	70	43	2500~2570	70
TR_HRDU_L800	LTE 800	791~821	30	43	832~862	30
TR_HRDU_L800_B	LTE 800	791~821	30	43	832~862	30
TR_HRDU_L2300T	LTE2300	2300~2400	100	43	2300~2400	100
TR_HRDU_L2600T_40W	LTE TDD 2600	2575-2615	40	45	2575-2615	40

TR_HRDU_L2600F_40W	LTE FDD 2600	2620-2690	70	45	2500-2570	70
TR_HRDU_A_L2300_100TDD	LTE TDD 2300	2300-2400	100	43	2300-2400	100
TR_HRDU_A_L2500_100TDD	LTE TDD 2500	2496-2690	194	43	2496-2690	194
TR_HRDU_A_L800	LTE 800	791~821	30	43	832~862	30
TR_HRDU_A_850C	850 CEL	869~894	25	43	824~849	25
TR_HRDU_A_L800_B	LTE 800	791~821	30	43	832~862	30
TR_HRDU_A_1800_B	LTE 1800	1805~1880	75	43	1710-1785	75
TR_HRDU_A_1900P_B	LTE 1900PCS	1930-1995	65	43	1850-1915	65
TR_HRDU_A_U2100_B	UMTS 2100 LTE 2100	2110~2170	60	43	1920~1980	60
TR_HRDU_A_L2600F_B_40W	LTE FDD 2600	2620-2690	70	45	2500-2570	70

※Output Power Tolerance: ± 1.5 dB

6.3. Optical Specifications

Unit Name		HR_R-OPTIC	Remark
Connector	RF	SMBL/PDM FEMALE / 50ohm	Analog
	Optic	SC / APC (STEP FERRULE)	
	Power/Signal	D-SUB 3ROW 15P MALE	
Laser Diode		1550nm(Coaxial Type)	
Photo Diode		1310nm	
Optical Loss		1dBo~ 5dBo@ OM_4 1dBo~10dBo @ OM_1	

6.4. Regulatory Conformity

Enclosure	
Product Type	THOR-DAS
Model Name	THOR-HROU-EN-AC
Modules	

Product Type	THOR-HRDU
Model Name	TR_HRDU_1800_B TR_HRDU_U2100_B TR_HRDU_L2600T_40W
HEALTH & SAFETY	
Safety	EN 60950-1:2006/A2:2013
Health	EN 50385:2017
EMC	
EMC	EN 301 489-1 V2.2.0 EN 301 489-50 V.2.2.0
SPECTRUM	
TR_HRDU_1800_B	EN 301 908-1 V11.1.1 EN 301 908-15 V11.1.2
TR_HRDU_U2100_B	EN 301 908-1 V11.1.1 EN 301 908-15 V11.1.2
TR_HRDU_900	EN 301 908-1 V11.1.1 EN 301 908-15 V11.1.2 EN 303 609 V12.5.1
TR_HRDU_A_U2100	EN 301 908-1 V11.1.1 EN 301 908-15 V11.1.2
TR_HRDU_A_1800	EN 301 908-1 V11.1.1 EN 301 908-15 V11.1.2 EN 303 609 V12.5.1
TR_HRDU_L2600F	EN 301 908-1 V11.1.1 EN 301 908-15 V11.1.2
TR_HRDU_L2600F_B	EN 301 908-1 V11.1.1 EN 301 908-15 V11.1.2
TR_HRDU_L800	EN 301 908-1 V11.1.1 EN 301 908-15 V11.1.2
TR_HRDU_L800_B	EN 301 908-1 V11.1.1 EN 301 908-15 V11.1.2
TR_HRDU_L2600T_40	EN 301 908-1 V11.1.1 EN 301 908-14 V11.1.2 EN 301 908-15 V11.1.2

TR_HRDU_L2600F_40	EN 301 908-1 V11.1.1 EN 301 908-15 V11.1.2
TR_HRDU_A_L2300_100TDD	EN 301 908-1 V11.1.1 EN 301 908-14 V11.1.2 EN 301 908-15 V11.1.2
TR_HRDU_A_L2500_100TDD	EN 301 908-1 V11.1.1 EN 301 908-14 V11.1.2 EN 301 908-15 V11.1.2
TR_HRDU_A_L800	EN 301 908-1 V11.1.1 EN 301 908-14 V11.1.2 EN 301 908-15 V11.1.2
TR_HRDU_A_850C	EN 301 908-1 V11.1.1 EN 301 908-14 V11.1.2 EN 301 908-15 V11.1.2
TR_HRDU_A_L800_B	EN 301 908-1 V11.1.1 EN 301 908-14 V11.1.2 EN 301 908-15 V11.1.2
TR_HRDU_A_1800_B	EN 301 908-1 V11.1.1 EN 301 908-14 V11.1.2 EN 301 908-15 V11.1.2
TR_HRDU_A_1900P_B	EN 301 908-1 V11.1.1 EN 301 908-14 V11.1.2 EN 301 908-15 V11.1.2
TR_HRDU_A_U2100_B	EN 301 908-1 V11.1.1 EN 301 908-14 V11.1.2 EN 301 908-15 V11.1.2
TR_HRDU_A_L2600F_B_40W	EN 301 908-1 V11.1.1 EN 301 908-14 V11.1.2 EN 301 908-15 V11.1.2

6.5. Marking Plate (TBD)

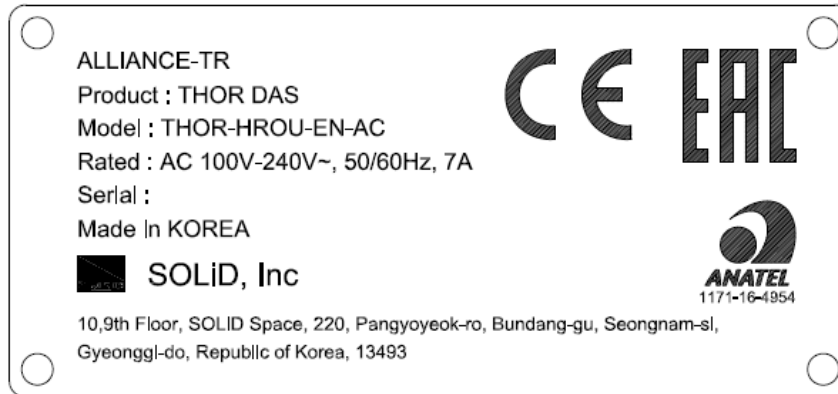

Glossary of Terms

Abbreviation	Full Name
AGC	Automatic Gain Control
ALC	Automatic Level Control
AOR	Add-On Remote
ARU	Add-On Remote Unit
ATT	Attenuation
BIU	Base Station Interface Unit
DAS	Distributed Antenna System
DMS	DAS Management System for Alliance-TR
ECPU	Expansion Central Processor Unit
EPSU	Expansion Power Supply Unit
WDM	Wavelength Division Multiplexer
HROU	High power Remote Optic Unit
HRDU	High power Remote Drive Unit

HARU	High power Add-On Remote Unit
LD	Laser Diode
LROU	Low power Remote Optic Unit
MCDU	Main Combiner Divider Unit
MCPU	Main Central Processing Unit
MDBU	Main Drive BTS Unit
MPSU	Main Power Supply Unit
MROU	Medium power Remote Optic Unit
MRU	Main Remote Unit
ODU	Optical Distribution Unit
OEU	Optical Expansion Unit
PD	Photo Diode
PSU	Power Supply Unit
R-Optic	Remote Optic Module
ROU	Remote Optical Unit
RDU	Remote Drive Unit
RPSU	Remote Power Supply Unit
E-Optic	Expansion Optical Unit

FCC Statements

FCC Part 15.105

This equipment has been tested and found to comply with the limits for a Class A digital device, pursuant to part 15 of the FCC Rules. These limits are designed to provide reasonable protection against harmful interference when the equipment is operated in a commercial environment. This equipment generates, uses, and can radiate radio frequency energy and, if not installed and used in accordance with the instruction manual, may cause harmful interference to radio communications. Operation of this equipment in a residential area is likely to cause harmful interference in which case the user will be required to correct the interference at his own expense

FCC Part 15.21 statement

Any changes or modifications not expressly approved by the party responsible for compliance could void the user's authority to operate this equipment.

RF RADIATION EXPOSURE

This equipment will only comply with the RF exposure limits for an uncontrolled environment when the installation, including co-location are addressed (at licensing). This transmitter will be co-located with other transmitters. The single unit (TR_HRDU_A_1900P_B or TR_HRDU_A_850C) RF Exposure compliance using a 17dBi antenna requires a minimum separation distance between persons and the antenna of 5.5 meters.



EU Declaration of Conformity



Contact to Authorised Representative

SOLiD Technologies, Inc.

13 Approach Road, London, SW20 8BA