

On your side

HCT

TEST REPORT

FCC Test for N20-HRDU_A_1900P

Certification

APPLICANT

SOLiD, Inc.

REPORT NO.

HCT-RF-2005-FC011

DATE OF ISSUE

May 15, 2020

HCT Co., Ltd.

74, Seoicheon-ro 578beon-gil, Majang-myeon, Icheon-si, Gyeonggi-do, 17383 KOREA

Tel. +82 31 634 6300 F ax. +82 31 645 6401



HCT CO., LTD.

74, Seoicheon-ro 578beon-gil, Majang-myeon, Icheon-si, Gyeonggi-do, 17383 KOREA
Tel. +82 31 634 6300 F ax. +82 31 645 6401

**TEST
REPORT**
FCC Test for
N20-HRDU_A_1900P

REPORT NO.
HCT-RF-2005-FC011
DATE OF ISSUE
15 May 2020
Additional Model
-

Applicant	SOLiD, Inc. 10, 9th Floor, SOLiD Space, Pangyoyeok-ro 220, Bundang-gu, Seongnam-si, Gyeonggi-do, 463-400, South Korea
EUT Type	DAS
Model Name	N20-HRDU_A_1900P
FCC ID	W6UNHA1900P
Output Power	43 dBm
Date of Test	May 11, 2020 ~ May 15, 2020
FCC Rule Parts	CFR 47 Part 2, Part 24

This test results were applied only to the test methods required by the standard.

Tested by
Kyung Soo Kang

(signature)

Technical Manager
Jong Seok Lee

(signature)

(signature)
HCT CO., LTD.
Soo Chan Lee
SooChan Lee / CEO

REVISION HISTORY

The revision history for this test report is shown in table.

Revision No.	Date of Issue	Description
0	May 15, 2020	Initial Release

The result shown in this test report refer only to the sample(s) tested unless otherwise stated.

The measurements shown in this report were made in accordance with the procedures indicated, and the emissions from this equipment were found to be within the limits applicable. I assume full responsibility for the accuracy and completeness of these measurements, and for the qualifications of all persons taking them. It is further stated that upon the basis of the measurements made, the equipment tested is capable of operation in accordance with the requirements of the FCC Rules under normal use and maintenance.

CONTENTS

1. GENERAL INFORMATION	5
1.1. APPLICANT INFORMATION	5
1.2. PRODUCT INFORMATION	5
1.3. TEST INFORMATION	5
2. FACILITIES AND ACCREDITATIONS	6
2.1. FACILITIES	6
2.2. EQUIPMENT	6
3. TEST SPECIFICATIONS	7
3.1. STANDARDS	7
3.2. ADDITIONAL DESCRIPTIONS ABOUT TEST	8
3.3. MEASUREMENT UNCERTAINTY	10
3.4. STANDARDS ENVIRONMENTAL TEST CONDITIONS	10
3.5. TEST DIAGRAMS	11
4. TEST EQUIPMENTS	12
5. TEST RESULT	13
5.1. AGC THRESHOLD	13
5.2. OUT-OF-BAND REJECTION	15
5.3. INPUT-VERSUS-OUTPUT SIGNAL COMPARISON	17
5.4. INPUT/OUTPUT POWER AND AMPLIFIER/BOOSTER GAIN	31
5.5. OUT-OF-BAND/OUT-OF-BLOCK EMISSIONS AND SPURIOUS EMISSIONS	39
5.6. RADIATED SPURIOUS EMISSIONS	122
6. Annex A_EUT AND TEST SETUP PHOTO	125

1. GENERAL INFORMATION

1.1. APPLICANT INFORMATION

Company Name	SOLiD, Inc.
Company Address	10, 9th Floor, SOLiD Space, Pangyoyeok-ro 220, Bundang-gu, Seongnam-si, Gyeonggi-do, 463-400, South Korea

1.2. PRODUCT INFORMATION

EUT Type	DAS						
EUT Serial Number	20040001						
Power Supply	100-240VAC, 50/60Hz, DC -48V						
Frequency Range	<table border="1"><thead><tr><th>Band Name</th><th>Uplink (MHz)</th><th>Downlink (MHz)</th></tr></thead><tbody><tr><td>Broadband PCS</td><td>1 850 ~ 1 915</td><td>1 930 ~ 1 995</td></tr></tbody></table>	Band Name	Uplink (MHz)	Downlink (MHz)	Broadband PCS	1 850 ~ 1 915	1 930 ~ 1 995
Band Name	Uplink (MHz)	Downlink (MHz)					
Broadband PCS	1 850 ~ 1 915	1 930 ~ 1 995					
Tx Output Power	43 dBm						
Antenna Peak Gain	17 dBi						

1.3. TEST INFORMATION

FCC Rule Parts	CFR 47 Part 2, Part 24
Measurement Standards	KDB 935210 D05 v01r04, ANSI C63.26-2015
Test Location	HCT CO., LTD. 74, Seoicheon-ro 578beon-gil, Majang-myeon, Icheon-si, Gyeonggi-do, 17383, Rep. of KOREA

2. FACILITIES AND ACCREDITATIONS

2.1. FACILITIES

The SAC(Semi-Anechoic Chamber) and conducted measurement facility used to collect the radiated data are located at the 74, Seoicheon-ro 578beon-gil, Majang-myeon, Icheon-si, Gyeonggi-do, 17383, Rep. of KOREA.

The site is constructed in conformance with the requirements of ANSI C63.4 (Version: 2014) and CISPR Publication 22.

Detailed description of test facility was submitted to the Commission and accepted dated April 02, 2018 (Registration Number: KR0032).

2.2. EQUIPMENT

Radiated emissions are measured with one or more of the following types of linearly polarized antennas: tuned dipole, bi-conical, log periodic, bi-log, and/or ridged waveguide, horn. Spectrum analyzers with pre-selectors and quasi-peak detectors are used to perform radiated measurements.

Calibrated wideband preamplifiers, coaxial cables, and coaxial attenuators are also used for making measurements.

All receiving equipment conforms to CISPR Publication 16-1, "Radio Interference Measuring Apparatus and Measurement Methods."

3. TEST SPECIFICATIONS

3.1. STANDARDS

The following tests were conducted on a sample of the equipment for the purpose of demonstrating compliance with FCC Part 2, Part 24.

Description	Reference	Results
AGC threshold	KDB 935210 D05 v01r04 3.2	Compliant
Out-of-band rejection	KDB 935210 D05 v01r04 3.3	Compliant
Input-versus-output signal comparison	§ 2.1049	Compliant
Input/output power and amplifier/booster gain	§ 2.1046, § 24.232	Compliant
Out-of-band/out-of-block emissions and spurious emissions	§ 2.1051, § 24.238	Compliant
Spurious emissions radiated	§ 2.1053	Compliant

3.2. ADDITIONAL DESCRIPTIONS ABOUT TEST

Except for the following cases, EUT was tested under normal operating conditions.

: Out-of-band rejection test requires maximum gain condition without AGC

The test was generally based on the method of KDB 935210 D05 v01r04 and only followed ANSI C63.26-2015 if there was no test method in KDB standard.

EUT was tested with following modulated signals provide by applicant.

Band Name	Tested signals
PCS	GSM
	CDMA
	WCDMA
	LTE 5 MHz
	LTE 10 MHz

The frequency stability measurement has been omitted in accordance with section 3.7 of KDB 935210 D05 v01r04.

: It can be confirmed through input-versus-output signal comparison test that EUT does not alter the input signal.

The tests results included actual loss value for attenuator and cable combination as shown in the table below.

: Input Path

Correction factor table			
Frequency (MHz)	Factor (dB)	Frequency (MHz)	Factor (dB)
1100	0.697	1700	0.911
1200	0.878	1800	0.794
1300	0.974	1850	0.857
1400	0.917	1900	0.966
1500	1.061	1950	1.066
1600	1.044	2000	0.985

: Output Path

Correction factor table			
Frequency (MHz)	Factor (dB)	Frequency (MHz)	Factor (dB)
2	30.497	4500	32.517
10	29.846	5000	32.662
20	29.922	5500	33.296
30	29.772	6000	33.361
40	29.808	6500	34.388
50	29.780	7000	33.551
100	29.858	7500	33.924
200	30.053	8000	33.681
300	30.409	8500	33.775
400	30.536	9000	34.452
500	30.682	9500	33.954
600	30.773	10000	36.689
700	30.855	11000	35.860
800	30.878	12000	35.705
900	30.890	13000	35.262
1000	30.920	14000	36.805
1200	31.244	15000	36.468
1400	31.309	16000	36.976
1600	31.515	17000	36.639
1800	31.368	18000	37.680
1900	31.419	19000	37.981
2000	31.603	20000	39.044
2500	31.931	22000	40.885
3000	32.272	24000	40.203
3500	32.387	26000	41.040
4000	32.685	26500	45.515

3.3. MEASUREMENT UNCERTAINTY

Description	Reference	Results
AGC threshold	-	± 0.87 dB
Out-of-band rejection	-	± 0.58 MHz
Input-versus-output signal comparison	OBW > 5 MHz	± 0.58 MHz
Input/output power and amplifier/booster gain	-	± 0.87 dB
Out-of-band/out-of-block emissions and spurious emissions	-	± 1.08 dB
Spurious emissions radiated	$f \leq 1$ GHz	± 4.80 dB
	$f > 1$ GHz	± 6.07 dB

* Coverage factor $k = 2$, Confidence levels of 95 %

3.4. STANDARDS ENVIRONMENTAL TEST CONDITIONS

Temperature	+15 °C to +35 °C
Relative humidity	30 % to 60 %
Air pressure	860 mbar to 1 060 mbar

3.5. TEST DIAGRAMS

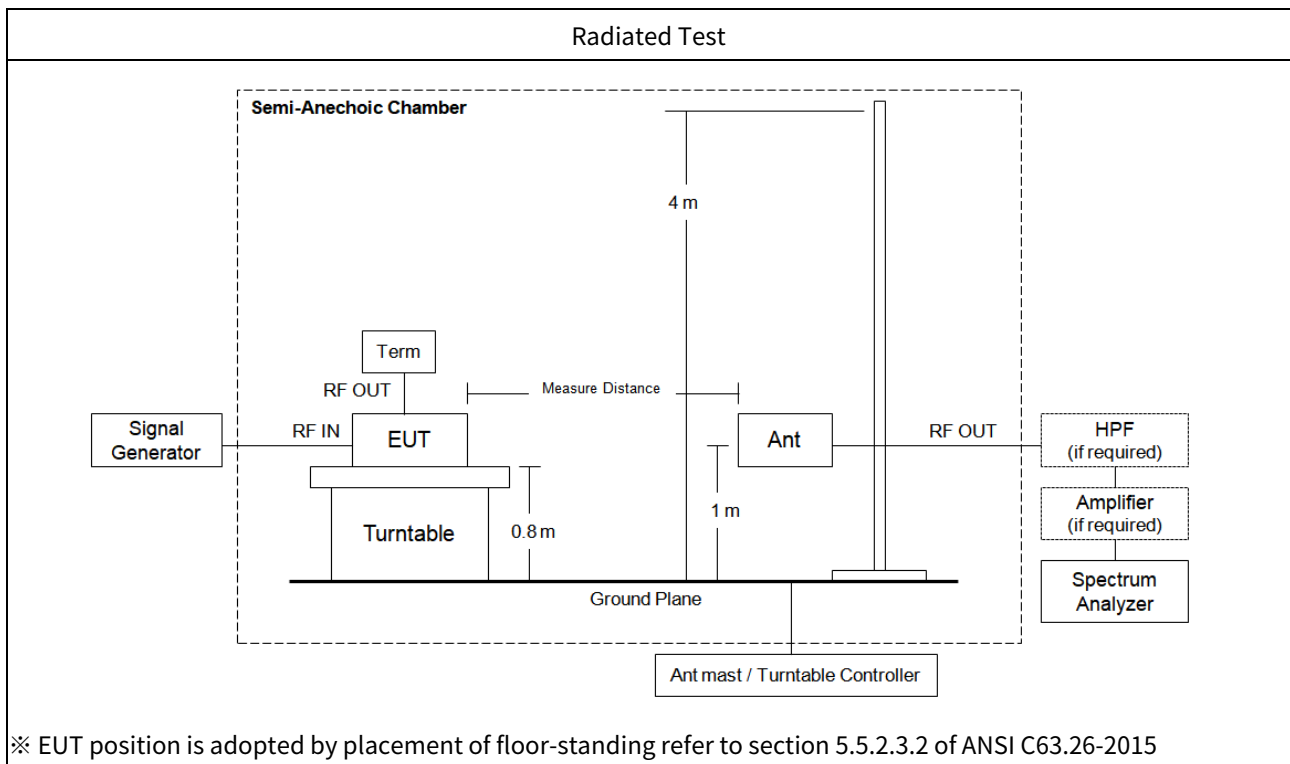
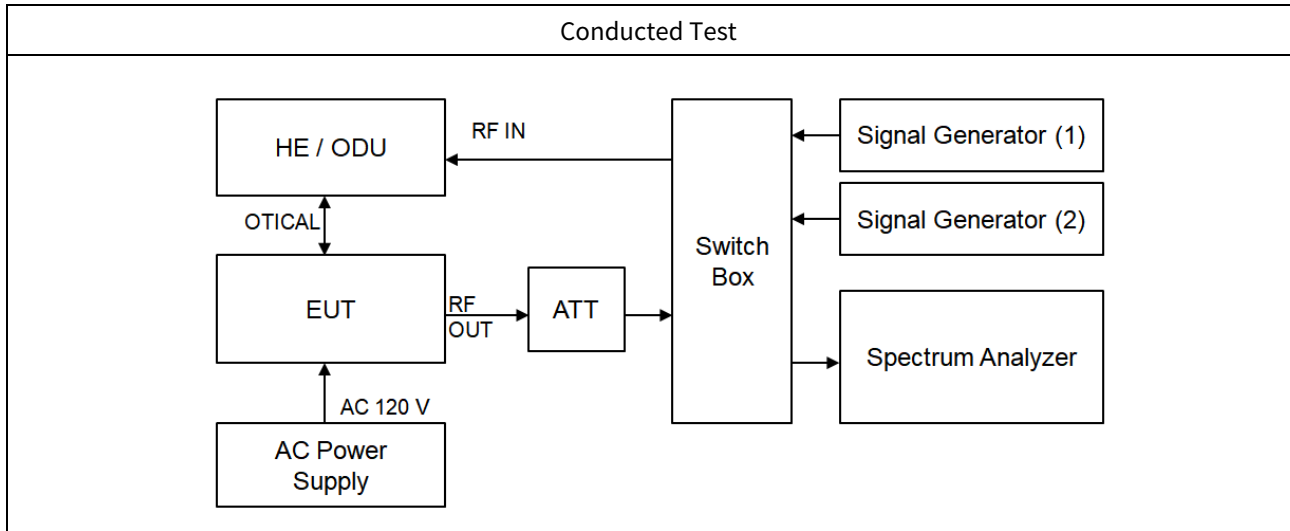

4. TEST EQUIPMENTS

Manufacturer	Model / Equipment	Calibration Date	Calibration Interval	Serial No.
Agilent	N9020A / MXA Signal Analyzer	04/27/2020	Annual	MY51110063
Agilent	N5182A / MXG Vector Signal Generator	12/23/2019	Annual	MY46240523
Agilent	N5182A / MXG Vector Signal Generator	01/17/2020	Annual	MY47070406
Agilent	8493C-030 / 30 dB Attenuator	07/08/2019	Annual	77640
KEITHLEY	S46 / Switch	N/A	N/A	1088024
Deayoung ENT	DFSS60 / AC Power Supply	04/07/2020	Annual	1003030-1
Innco system	CO3000 / Controller(Antenna mast)	N/A	N/A	CO3000-4p
Innco system	MA4640/800-XP-EP / Antenna Position Tower	N/A	N/A	N/A
Emco	2090 / Controller	N/A	N/A	060520
Audix	- / Turn Table	N/A	N/A	N/A
Rohde&Schwarz	- / Loop Antenna	01/18/2019	Biennial	1513-175
Schwarzbeck	VULB 9160 / Hybrid Antenna	08/09/2019	Biennial	3368
Schwarzbeck	BBHA 9120D / Horn Antenna	11/18/2019	Biennial	9120D-1191
Schwarzbeck	BBHA9170 / Horn Antenna(15 GHz ~ 40 GHz)	11/29/2019	Biennial	BBHA9170541
Rohde & Schwarz	FSP(9 kHz ~ 30 GHz) / Spectrum Analyzer	09/11/2019	Annual	836650/016
Rohde & Schwarz	FSV40-N / Spectrum Analyzer	09/26/2019	Annual	101068-SZ
CERNEK	CBLU1183540B-01/Broadband Bench Top LNA	12/24/2019	Annual	N/A
WEINSCHL	56-10 / Attenuator(10 dB)			
CERNEK	CBL06185030 / Broadband Low Noise Amplifier	12/24/2019	Annual	N/A
Api tech.	18B-03 / Attenuator (3 dB)			
Wainwright Instruments	WHKX10-2700-3000-18000-40SS / High Pass Filter	12/24/2019	Annual	N/A
T&M SYSTEM	COAXIAL ATTENUATOR / Thru	12/24/2019	Annual	N/A
CERNEK	CBL18265035 / Power Amplifier	12/26/2019	Annual	22966
CERNEK	CBL26405040 / Power Amplifier	03/23/2020	Annual	25956

Note:

1. Equipment listed above that calibrated during the testing period was set for test after the calibration.
2. Equipment listed above that has a calibration due date during the testing period, the testing is completed before equipment expiration date.

5. TEST RESULT

5.1. AGC THRESHOLD

Test Requirement:

KDB 935210 D05 v01r04

Testing at and above the AGC threshold is required.

Test Procedures:

Measurements were in accordance with the test methods section 3.2 of KDB 935210 D05 v01r04.

In the case of fiber-optic distribution systems, the RF input port of the equipment under test (EUT) refers to the RF input of the supporting equipment RF to optical convertor; see also descriptions and diagrams for typical DAS booster systems in KDB Publication 935210 D02.

Devices intended to be directly connected to an RF source (donor port) only need to be evaluated for any over-the-air transmit paths.

- a) Connect a signal generator to the input of the EUT.
- b) Connect a spectrum analyzer or power meter to the output of the EUT using appropriate attenuation as necessary.
- c) The signal generator should initially be configured to produce either of the required test signals.
- d) Set the signal generator frequency to the center frequency of the EUT operating band.
- e) While monitoring the output power of the EUT, measured using the methods of ANSI C63.26-2015 subclause 5.2.4.4.1, increase the input level until a 1 dB increase in the input signal power no longer causes a 1 dB increase in the output signal power.
- f) Record this level as the AGC threshold level.
- g) Repeat the procedure with the remaining test signal.

Output power measurement in subclause 5.2.4.4.1 of ANSI C63.26

- a) Set span to $2 \times$ to $3 \times$ the OBW.
- b) Set RBW = 1% to 5% of the OBW.
- c) Set VBW $\geq 3 \times$ RBW.
- d) Set number of measurement points in sweep $\geq 2 \times$ span / RBW.
- e) Sweep time: auto-couple
- f) Detector = power averaging (rms).
- g) If the EUT can be configured to transmit continuously, then set the trigger to free run.
- h) Omit

- i) Trace average at least 100 traces in power averaging (rms) mode if sweep is set to auto-couple. To accurately determine the average power over multiple symbols, it can be necessary to increase the number of traces to be averaged above 100 or, if using a manually configured sweep time, increase the sweep time.
- j) Compute the power by integrating the spectrum across the OBW of the signal using the instrument's band or channel power measurement function, with the band/channel limits set equal to the OBW band edges. If the instrument does not have a band or channel power function, then sum the spectrum levels (in linear power units) at intervals equal to the RBW extending across the entire OBW of the spectrum.

Test Results:

Test Band	Link	Signal	Center Frequency (MHz)	AGC Threshold Level (dBm)	Output Level (dBm)
PCS	Downlink	GSM	1 962.50	-15	42.78
		CDMA	1 962.50	-15	42.98
		WCDMA	1 962.50	-15	42.95
		LTE 5 MHz	1 962.50	-15	43.15
		LTE 10 MHz	1 962.50	-15	43.29

5.2. OUT-OF-BAND REJECTION

Test Requirement:

KDB 935210 D05 v01r04

Out-of-band rejection required.

Test Procedures:

Measurements were in accordance with the test methods section 3.3 of KDB 935210 D05 v01r04.

A signal booster shall reject amplification of other signals outside of its passband. Adjust the internal gain control of the EUT (if so equipped) to the maximum gain for which equipment certification is sought.

- a) Connect a signal generator to the input of the EUT.
- b) Configure a swept CW signal with the following parameters:
 - 1) Frequency range = ± 250 % of the passband, for each applicable CMRS band.
 - 2) Level = a sufficient level to affirm that the out-of-band rejection is > 20 dB above the noise floor and will not engage the AGC during the entire sweep.
 - 3) Dwell time = approximately 10 ms.
 - 4) Number of points = $\text{SPAN}/(\text{RBW}/2)$.
- c) Connect a spectrum analyzer to the output of the EUT using appropriate attenuation.
- d) Set the span of the spectrum analyzer to the same as the frequency range of the signal generator.
- e) Set the resolution bandwidth (RBW) of the spectrum analyzer to be 1 % to 5 % of the EUT passband, and the video bandwidth (VBW) shall be set to $\geq 3 \times \text{RBW}$.
- f) Set the detector to Peak Max-Hold and wait for the spectrum analyzer's spectral display to fill.
- g) Place a marker to the peak of the frequency response and record this frequency as f_0 .
- h) Place two markers, one at the lowest and the other at the highest frequency of the envelope of the spectral display, such that each marker is at or slightly below the -20 dB down amplitude, to determine the 20 dB bandwidth.
- i) Capture the frequency response of the EUT.
- j) Repeat for all frequency bands applicable for use by the EUT.

Test Results:

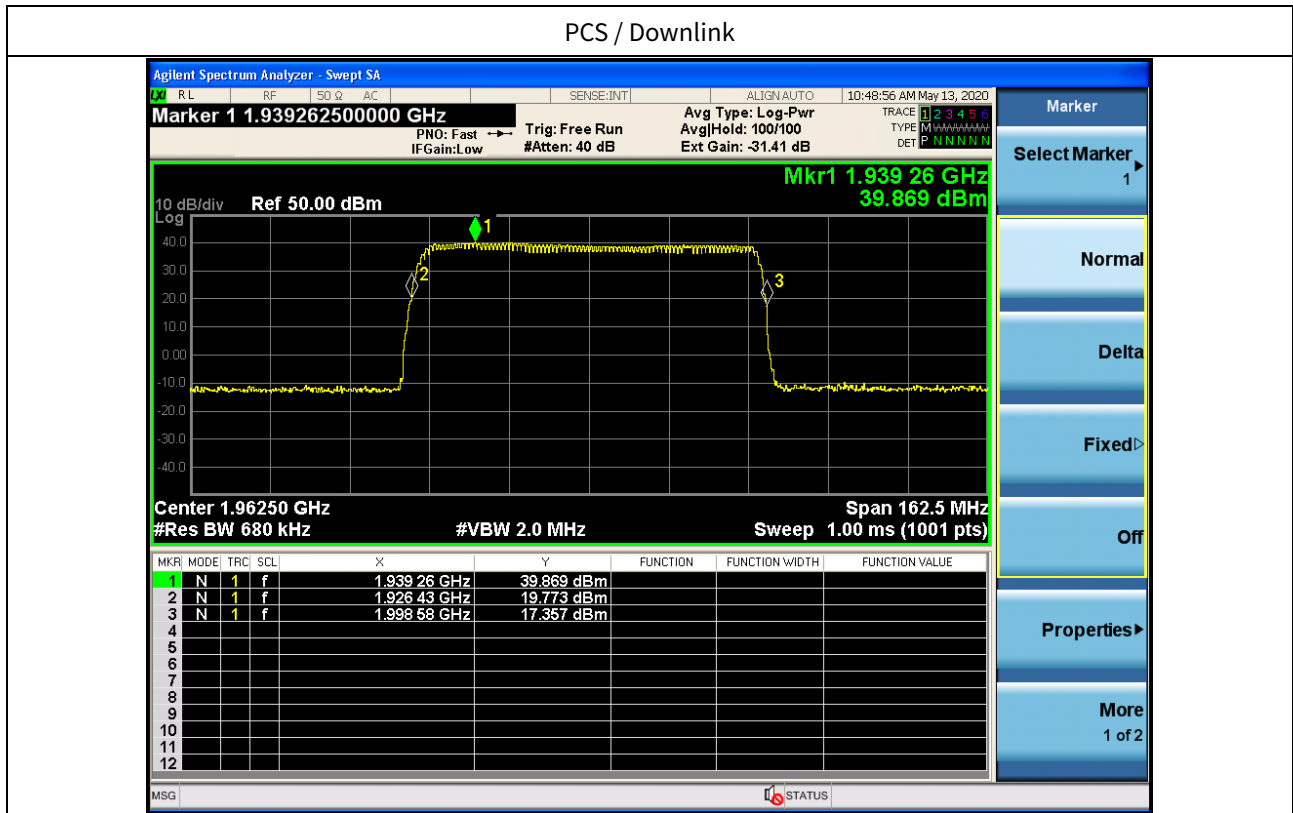

5.3. INPUT-VERSUS-OUTPUT SIGNAL COMPARISON

Test Requirement:

§ 2.1049 Measurements required: Occupied bandwidth.

The occupied bandwidth, that is the frequency bandwidth such that, below its lower and above its upper frequency limits, the mean powers radiated are each equal to 0.5 percent of the total mean power radiated by a given emission shall be measured under the specified conditions of § 2.1049 (a) through (i) as applicable.

Test Procedures:

Measurements were in accordance with the test methods section 3.4 of KDB 935210 D05 v01r04.

A 26 dB bandwidth measurement shall be performed on the input signal and the output signal; alternatively, the 99% OBW can be measured and used. See KDB Publication 971168 [R8] for more information on measuring OBW.

- a) Connect a signal generator to the input of the EUT.
- b) Configure the signal generator to transmit the AWGN signal.
- c) Configure the signal amplitude to be just below the AGC threshold level (see 3.2), but not more than 0.5 dB below.
- d) Connect a spectrum analyzer to the output of the EUT using appropriate attenuation.
- e) Set the spectrum analyzer center frequency to the center frequency of the operational band under test. The span range of the spectrum analyzer shall be between 2 times to 5 times the emission bandwidth (EBW) or alternatively, the OBW.
- f) The nominal RBW shall be in the range of 1 % to 5 % of the anticipated OBW, and the VBW shall be $\geq 3 \times$ RBW.
- g) Set the reference level of the instrument as required to preclude the signal from exceeding the maximum spectrum analyzer input mixer level for linear operation. In general, the peak of the spectral envelope must be more than $[10 \log (\text{OBW} / \text{RBW})]$ below the reference level. Steps f) and g) may require iteration to enable adjustments within the specified tolerances.
- h) The noise floor of the spectrum analyzer at the selected RBW shall be at least 36 dB below the reference level.
- i) Set spectrum analyzer detection function to positive peak.
- j) Set the trace mode to max hold.
- k) Determine the reference value: Allow the trace to stabilize. Set the spectrum analyzer marker to the highest amplitude level of the displayed trace (this is the reference value) and record the associated frequency as f_0 .
- l) Place two markers, one at the lowest and the other at the highest frequency of the envelope of the spectral display, such that each marker is at or slightly below the -26 dB down amplitude. The 26 dB EBW (alternatively OBW) is the positive frequency difference between the two markers. If the spectral envelope crosses the -26 dB down amplitude at multiple points, the lowest or highest frequency shall be selected as the frequencies that are the furthest removed from the center frequency at which the spectral envelope crosses the -26 dB down

amplitude point.

- m) Repeat steps e) to l) with the input signal connected directly to the spectrum analyzer (i.e., input signal measurement).
- n) Compare the spectral plot of the input signal (determined from step m) to the output signal (determined from step l) to affirm that they are similar (in passband and rolloff characteristic features and relative spectral locations), and include plot(s) and descriptions in test report.
- o) Repeat the procedure [steps e) to n)] with the input signal amplitude set to 3 dB above the AGC threshold.
- p) Repeat steps e) to o) with the signal generator set to the narrowband signal.
- q) Repeat steps e) to p) for all frequency bands authorized for use by the EUT.

Test Results:
Tabular data of Output Occupied Bandwidth

Test Band	Link	Signal	Center Frequency (MHz)	99 % OBW (MHz)	26 dB OBW (MHz)
PCS	Downlink	GSM	1 962.50	0.2445	0.309
		CDMA	1 962.50	1.2658	1.397
		WCDMA	1 962.50	4.1978	4.708
		LTE 5 MHz	1 962.50	4.5268	4.974
		LTE 10 MHz	1 962.50	8.9986	9.929

Tabular data of Input Occupied Bandwidth

Test Band	Link	Signal	Center Frequency (MHz)	99 % OBW (MHz)	26 dB OBW (MHz)
PCS	Downlink	GSM	1 962.50	0.2439	0.306
		CDMA	1 962.50	1.2657	1.397
		WCDMA	1 962.50	4.2153	4.736
		LTE 5 MHz	1 962.50	4.5118	5.010
		LTE 10 MHz	1 962.50	9.0138	10.017

Tabular data of 3 dB above the AGC threshold Output Occupied Bandwidth

Test Band	Link	Signal	Center Frequency (MHz)	99 % OBW (MHz)	26 dB OBW (MHz)
PCS	Downlink	GSM	1 962.50	0.2444	0.313
		CDMA	1 962.50	1.2602	1.397
		WCDMA	1 962.50	4.1864	4.711
		LTE 5 MHz	1 962.50	4.5212	5.045
		LTE 10 MHz	1 962.50	9.0056	9.923

Measured Occupied Bandwidth Comparison

Test Band	Link	Signal	Variant of Input and output Occupied Bandwidth (%)	Variant of Input and 3 dB above the AGC threshold output Occupied Bandwidth (%)
PCS	Downlink	GSM	0.980	2.288
		CDMA	0.000	0.000
		WCDMA	-0.591	-0.528
		LTE 5 MHz	-0.719	0.699
		LTE 10 MHz	-0.879	-0.938

** Change in input-output OBW is less than $\pm 5\%$.*

Plot data of Occupied Bandwidth

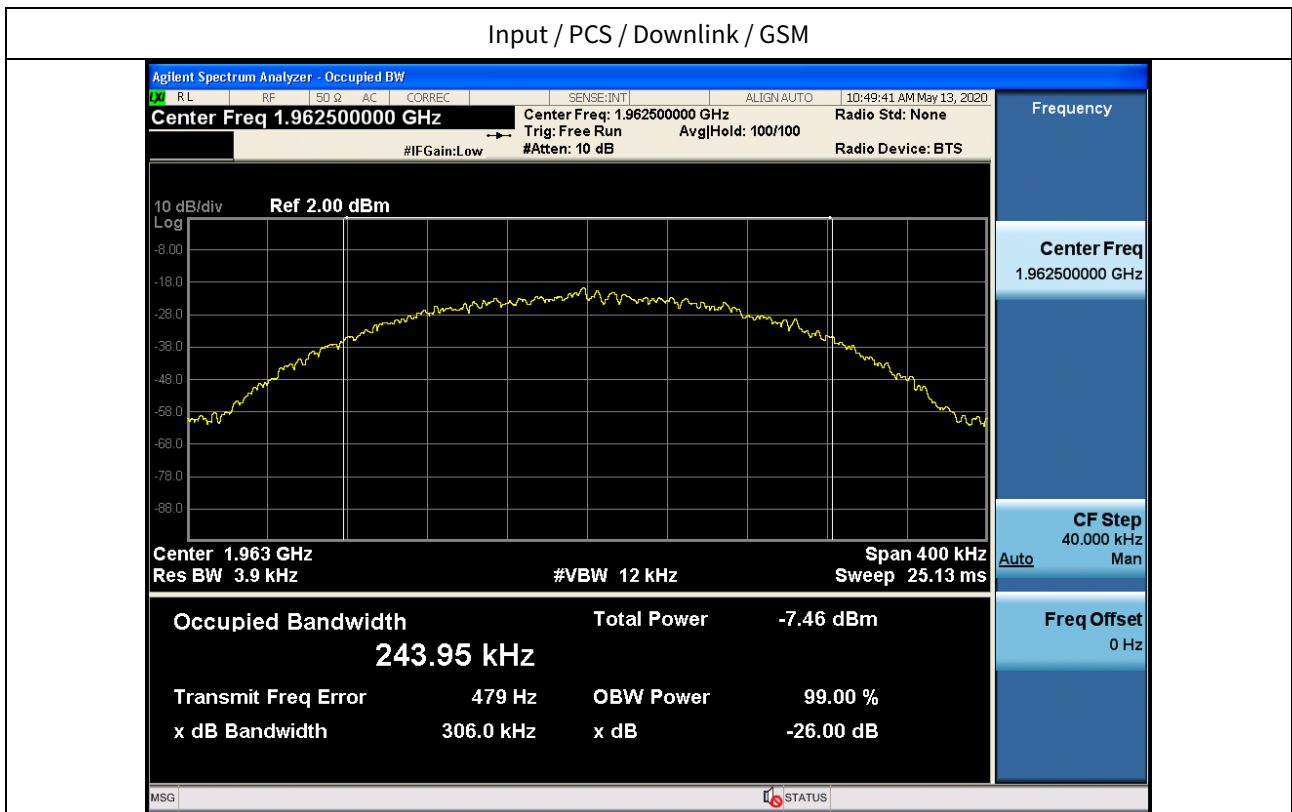
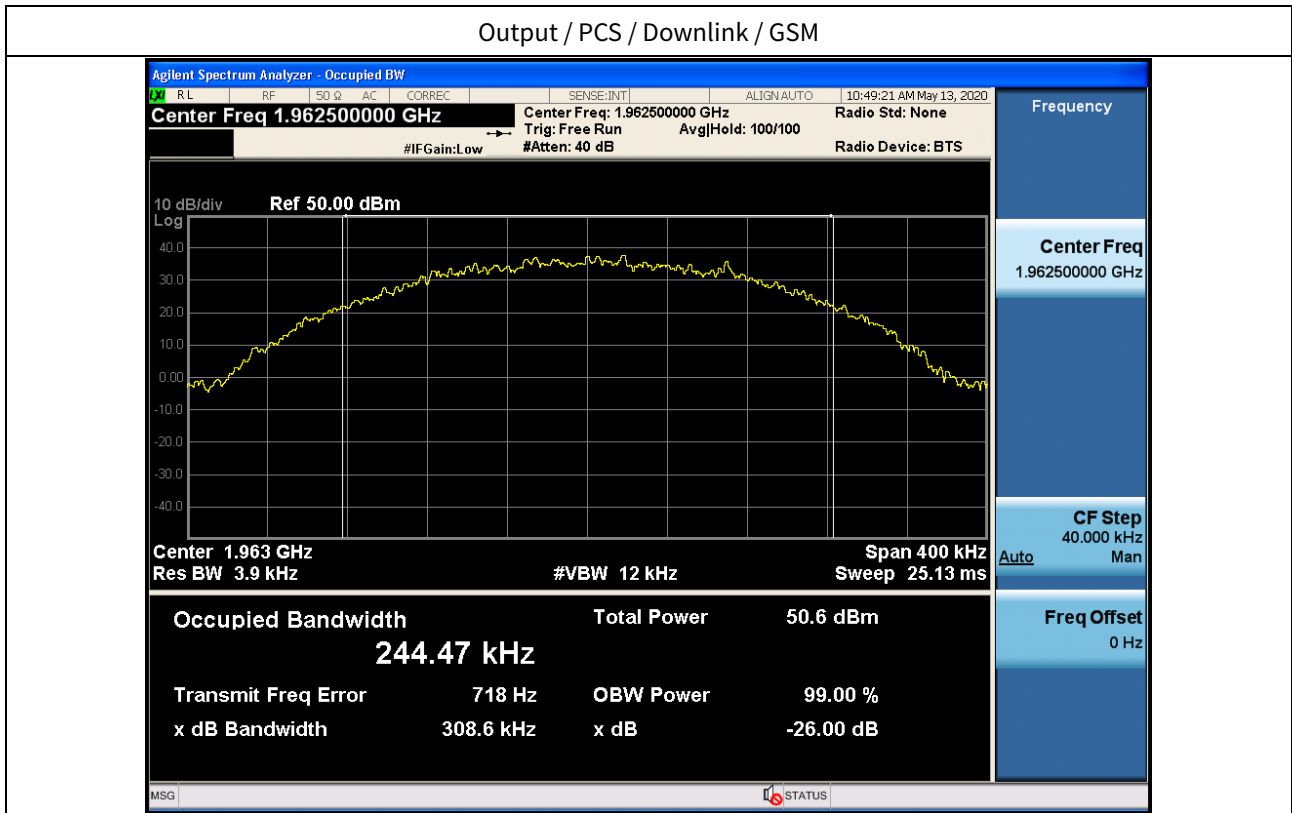

3 dB above the AGC threshold output / PCS / Downlink / GSM

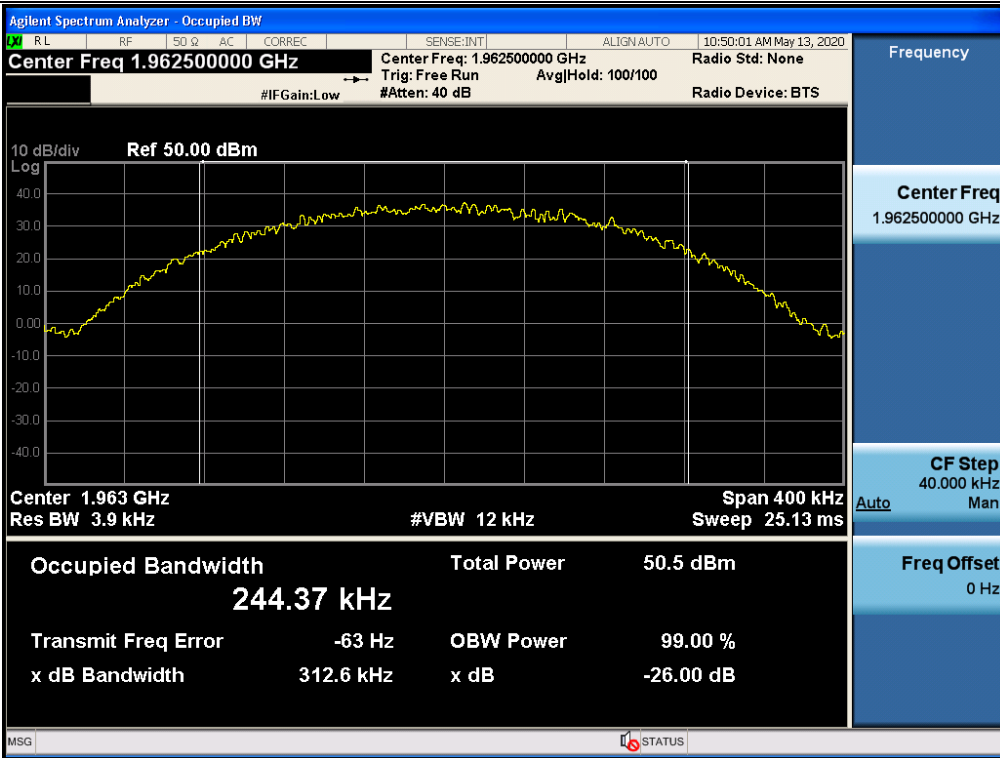

Output / PCS / Downlink / CDMA

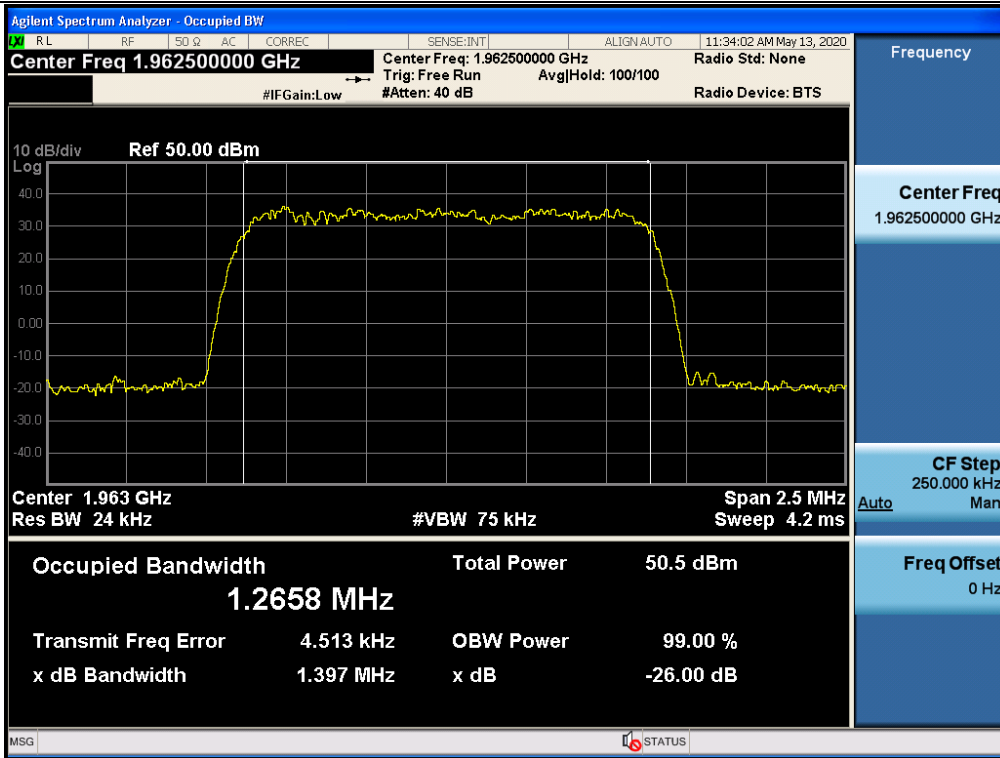

Input / PCS / Downlink / CDMA

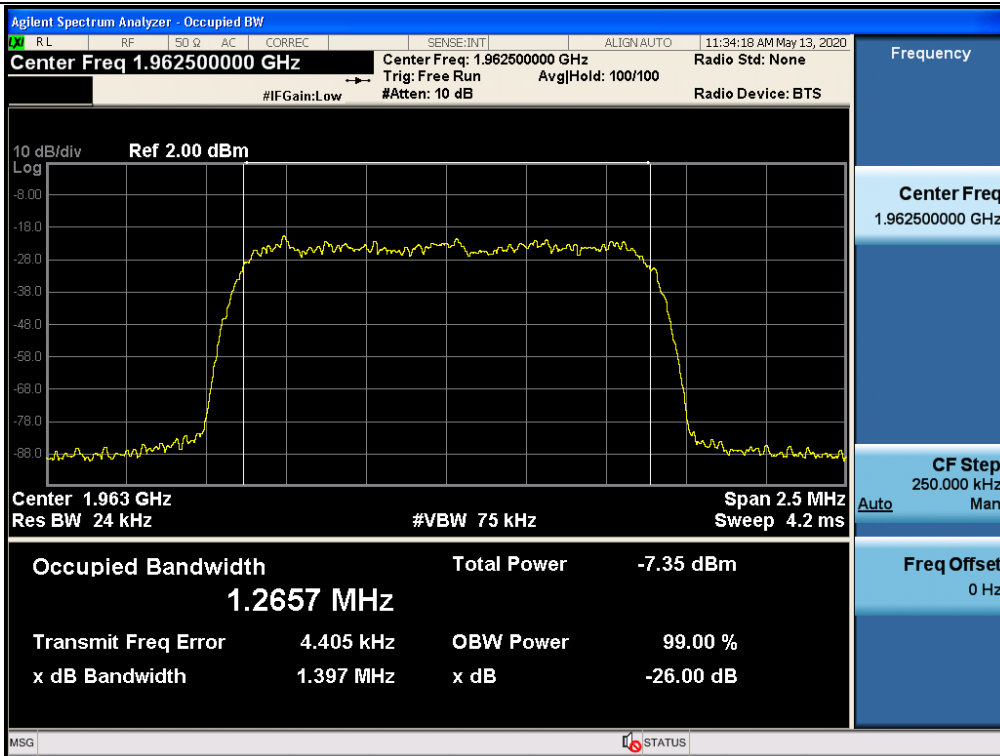

3 dB above the AGC threshold output / PCS / Downlink / CDMA

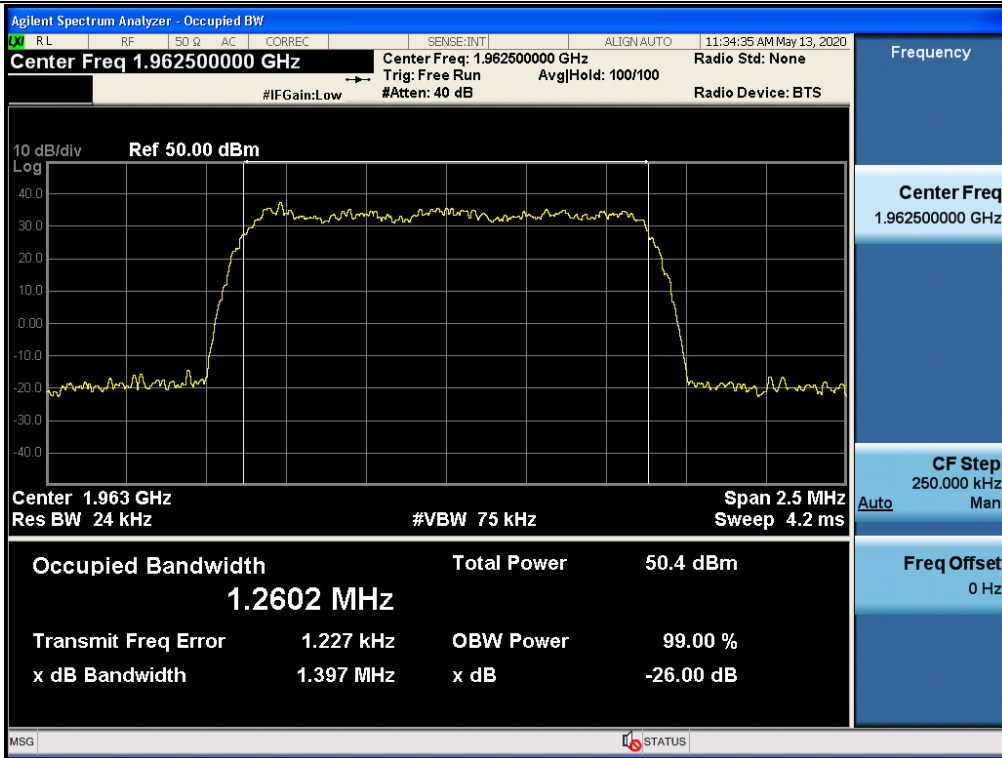

Output / PCS / Downlink / WCDMA

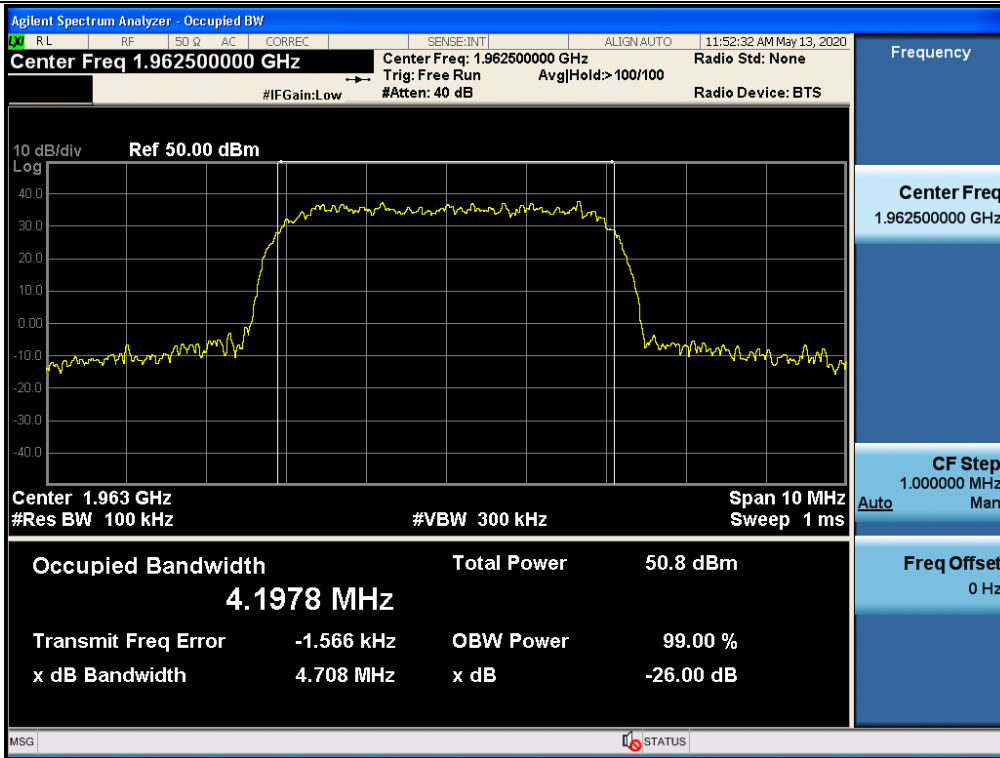

Input / PCS / Downlink / WCDMA

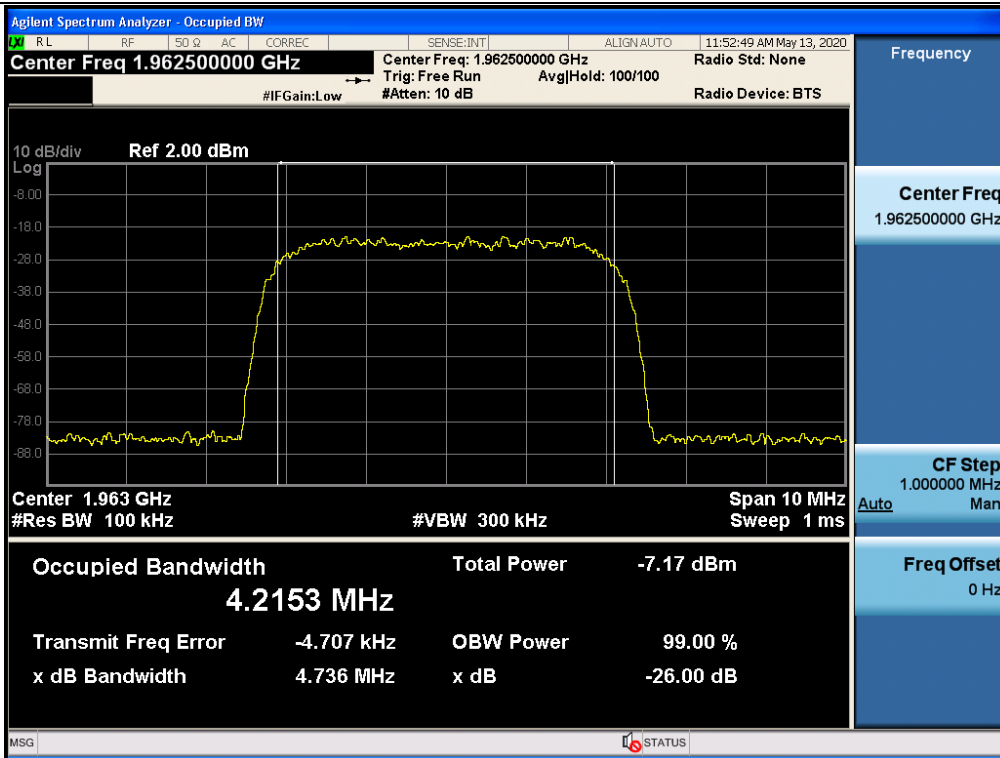

3 dB above the AGC threshold output / PCS / Downlink / WCDMA

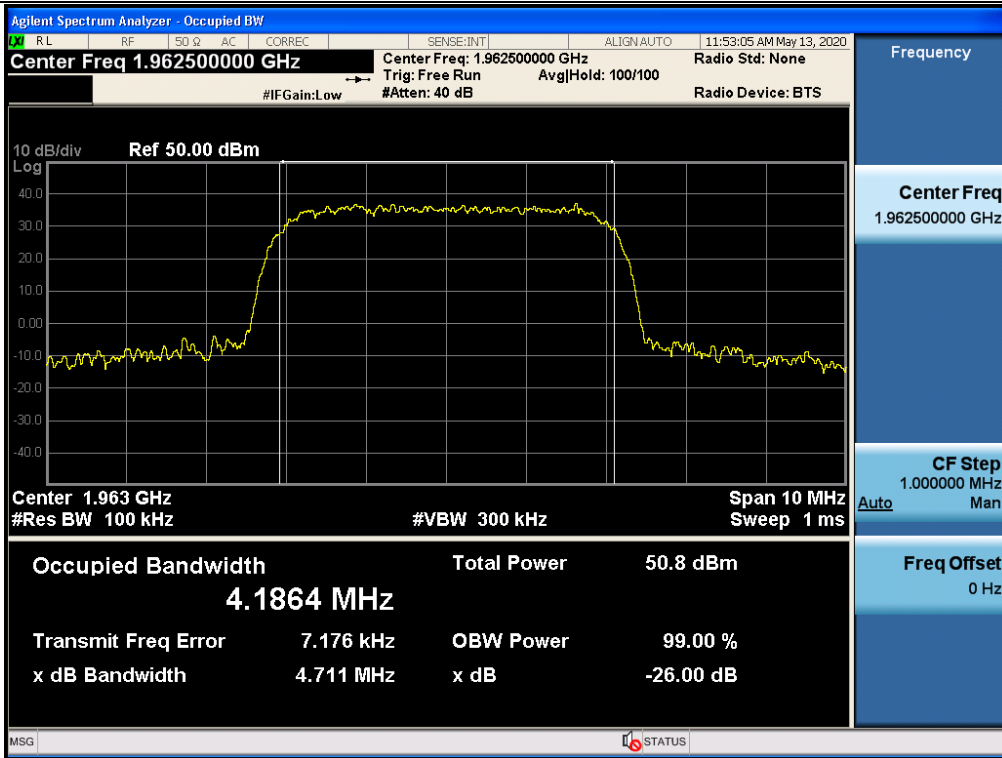

Output / PCS / Downlink / LTE 5 MHz

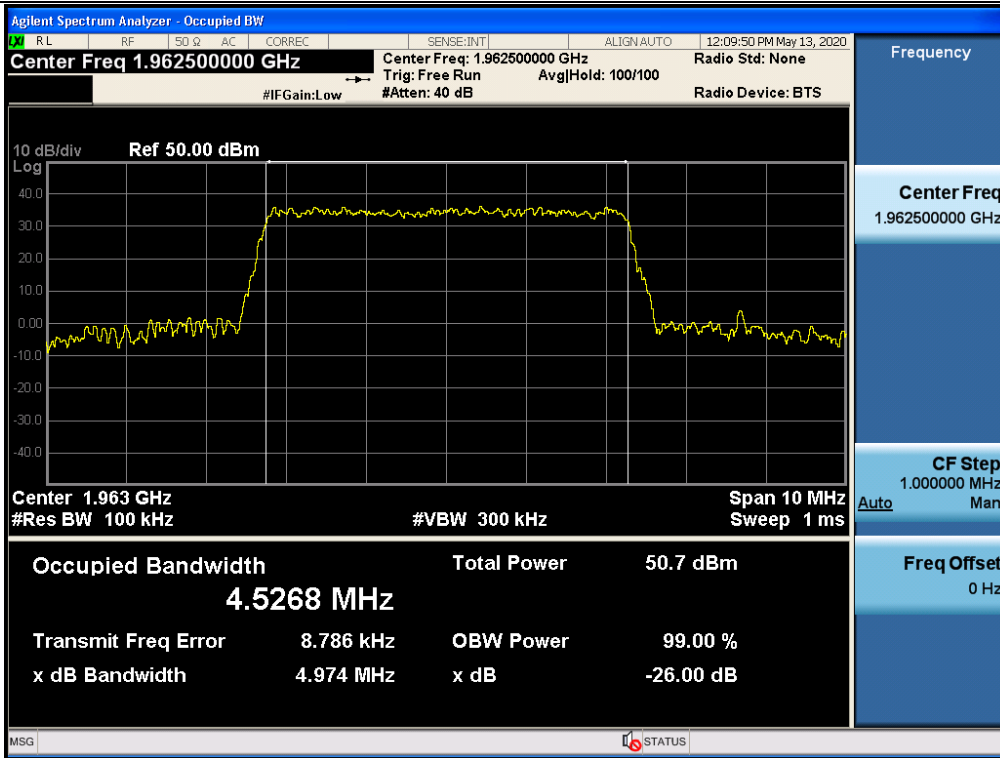

Input / PCS / Downlink / LTE 5 MHz

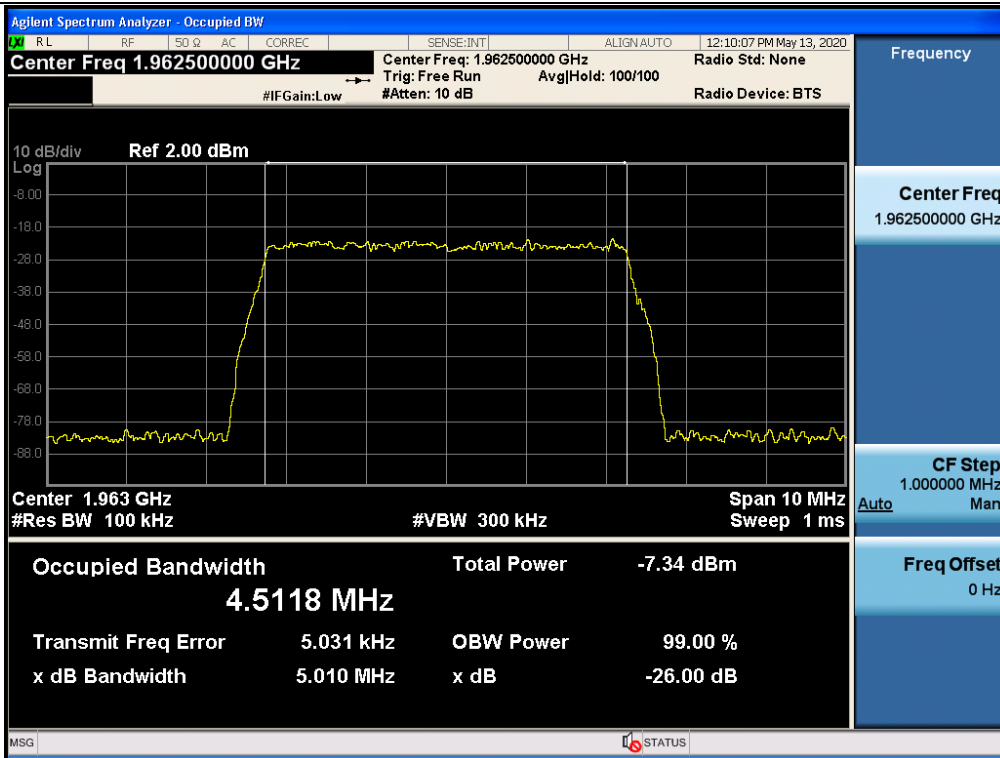

3 dB above the AGC threshold output / PCS / Downlink / LTE 5 MHz

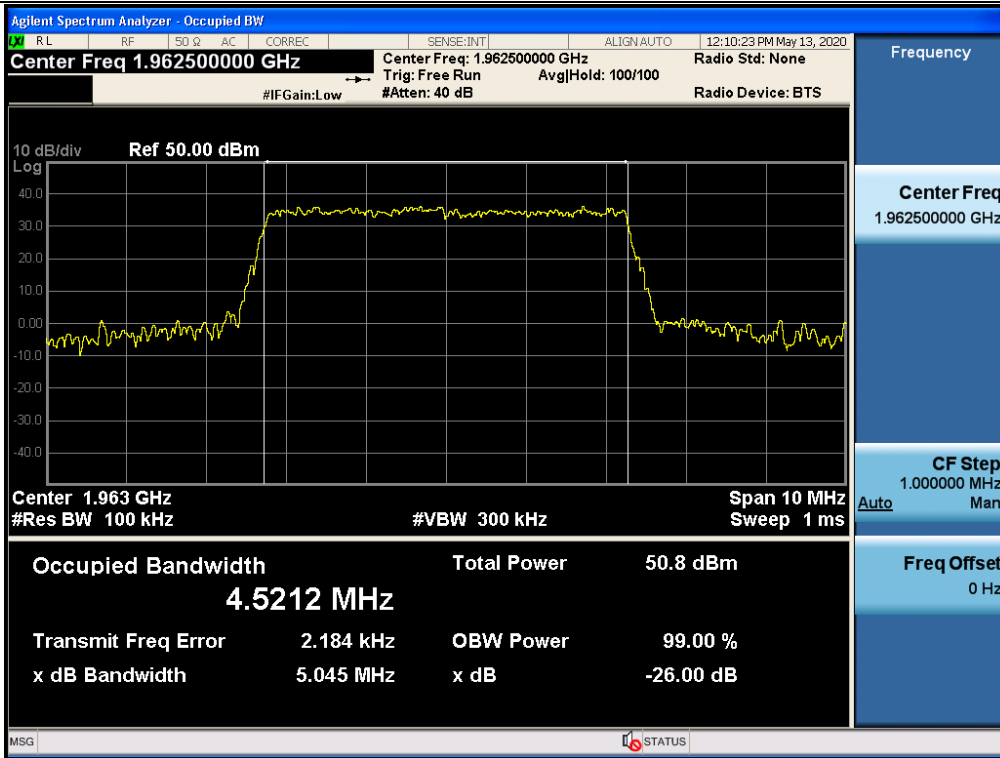

Output / PCS / Downlink / LTE 10 MHz

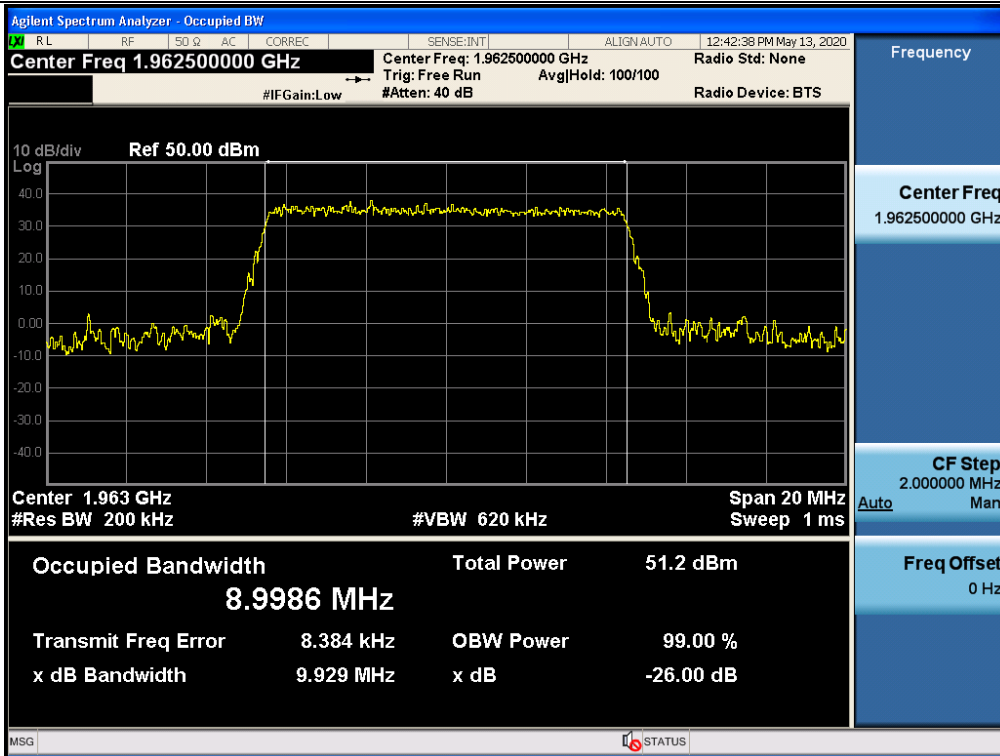

Input / PCS / Downlink / LTE 10 MHz

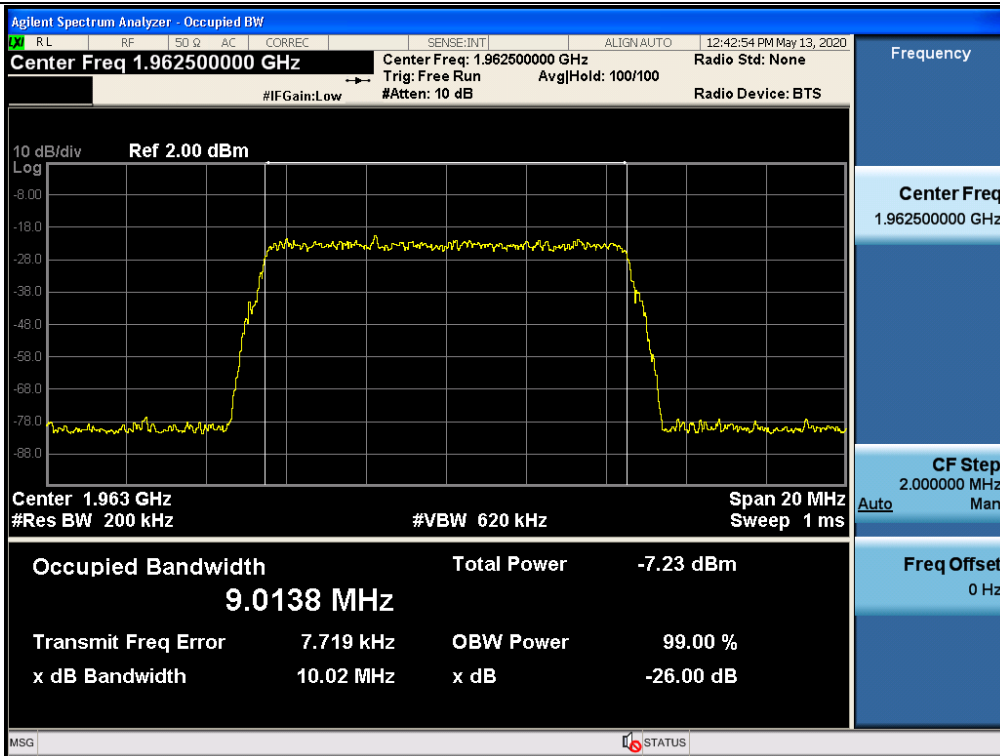

3 dB above the AGC threshold output / PCS / Downlink / LTE 10 MHz

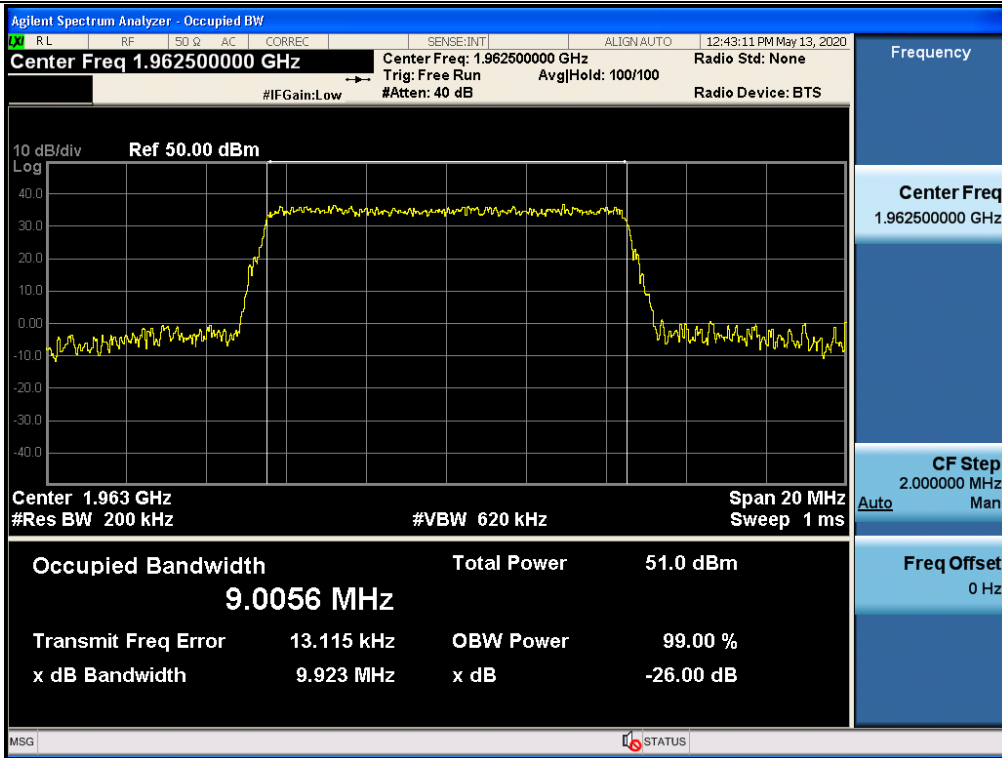

5.4. INPUT/OUTPUT POWER AND AMPLIFIER/BOOSTER GAIN

Test Requirement:

§ 2.1046 Measurements required: RF power output.

(a) For transmitters other than single sideband, independent sideband and controlled carrier radiotelephone, power output shall be measured at the RF output terminals when the transmitter is adjusted in accordance with the tune-up procedure to give the values of current and voltage on the circuit elements specified in § 2.1033(c)(8). The electrical characteristics of the radio frequency load attached to the output terminals when this test is made shall be stated.

(b) For single sideband, independent sideband, and single channel, controlled carrier radiotelephone transmitters the procedure specified in paragraph (a) of this section shall be employed and, in addition, the transmitter shall be modulated during the test as specified and applicable in § 2.1046 (b) (1-5). In all tests, the input level of the modulating signal shall be such as to develop rated peak envelope power or carrier power, as appropriate, for the transmitter.

(c) For measurements conducted pursuant to paragraphs (a) and (b) of this section, all calculations and methods used by the applicant for determining carrier power or peak envelope power, as appropriate, on the basis of measured power in the radio frequency load attached to the transmitter output terminals shall be shown. Under the test conditions specified, no components of the emission spectrum shall exceed the limits specified in the applicable rule parts as necessary for meeting occupied bandwidth or emission limitations.

§ 24.232 Power and antenna height limits.

- (a)(1) Base stations with an emission bandwidth of 1 MHz or less are limited to 1640 watts equivalent isotropically radiated power (EIRP) with an antenna height up to 300 meters HAAT, except as described in paragraph (b) below.
- (2) Base stations with an emission bandwidth greater than 1 MHz are limited to 1640 watts/MHz equivalent isotropically radiated power (EIRP) with an antenna height up to 300 meters HAAT, except as described in paragraph (b) below.
- (3) Base station antenna heights may exceed 300 meters HAAT with a corresponding reduction in power; see Tables 1 and 2 of this section.
- (4) The service area boundary limit and microwave protection criteria specified in § 24.236 and 24.237 apply.

Table 1—Reduced Power for Base Station Antenna Heights Over 300 Meters, With Emission Bandwidth of 1 MHz or Less

HAAT in meters	Maximum EIRP watts
≤300	1640
≤500	1070
≤1000	490
≤1500	270
≤2000	160

Table 2—Reduced Power for Base Station Antenna Heights Over 300 Meters, With Emission Bandwidth Greater Than 1 MHz

HAAT in meters	Maximum EIRP watts/MHz
≤300	1640
≤500	1070
≤1000	490
≤1500	270
≤2000	160

- (b)(1) Base stations that are located in counties with population densities of 100 persons or fewer per square mile, based upon the most recently available population statistics from the Bureau of the Census, with an emission bandwidth of 1 MHz or less are limited to 3280 watts equivalent isotropically radiated power (EIRP) with an antenna height up to 300 meters HAAT.
- (2) Base stations that are located in counties with population densities of 100 persons or fewer per square mile, based upon the most recently available population statistics from the Bureau of the Census, with an emission bandwidth greater than 1 MHz are limited to 3280 watts/MHz equivalent isotropically radiated power (EIRP) with an antenna height up to 300 meters HAAT.
- (3) Base station antenna heights may exceed 300 meters HAAT with a corresponding reduction in power; *see* Tables 3 and 4 of this section.
- (4) The service area boundary limit and microwave protection criteria specified in § § 24.236 and 24.237 apply.
- (5) Operation under this paragraph (b) at power limits greater than permitted under paragraph (a) of this section must be coordinated in advance with all broadband PCS licensees authorized to operate on adjacent frequency blocks within 120 kilometers (75 miles) of the base station and is limited to base stations located more than 120 kilometers (75 miles) from the Canadian border and more than 75 kilometers (45 miles) from the Mexican border.

Table 3—Reduced Power for Base Station Antenna Heights Over 300 Meters, With Emission Bandwidth of 1 MHz or Less

HAAT in meters	Maximum EIRP watts
≤300	3280
≤500	2140
≤1000	980
≤1500	540
≤2000	320

Table 4—Reduced Power for Base Station Antenna Heights Over 300 Meters, With Emission Bandwidth Greater Than 1 MHz

HAAT in meters	Maximum EIRP watts/MHz
≤300	3280
≤500	2140
≤1000	980
≤1500	540
≤2000	320

(c) Mobile and portable stations are limited to 2 watts EIRP and the equipment must employ a means for limiting power to the minimum necessary for successful communications.

(d) Power measurements for transmissions by stations authorized under this section may be made either in accordance with a Commission-approved average power technique or in compliance with paragraph (e) of this section. In both instances, equipment employed must be authorized in accordance with the provisions of § 24.51. In measuring transmissions in this band using an average power technique, the peak-to-average ratio (PAR) of the transmission may not exceed 13 dB.

(e) Peak transmit power must be measured over any interval of continuous transmission using instrumentation calibrated in terms of an rms-equivalent voltage. The measurement results shall be properly adjusted for any instrument limitations, such as detector response times, limited resolution bandwidth capability when compared to the emission bandwidth, sensitivity, *etc.*, so as to obtain a true peak measurement for the emission in question over the full bandwidth of the channel.

Test Procedures:

Measurements were in accordance with the test methods section 3.5 of KDB 935210 D05 v01r04.

Adjust the internal gain control of the EUT to the maximum gain for which the equipment certification is being sought. Any EUT attenuation settings shall be set to their minimum value.

Input power levels (uplink and downlink) should be set to maximum input ratings while confirming that the device is not capable of operating in saturation (non-linear mode) at the rated input levels, including during the performance of the input/output power measurements.

3.5.2 Measuring the EUT mean input and output power

- a) Connect a signal generator to the input of the EUT.
- b) Configure to generate the test signal.
- c) The frequency of the signal generator shall be set to the frequency f_0 as determined from out-of-band rejection test.
- d) Connect a spectrum analyzer or power meter to the output of the EUT using appropriate attenuation as

necessary.

- e) Set the signal generator output power to a level that produces an EUT output level that is just below the AGC threshold, but not more than 0.5 dB below.
- f) Measure and record the output power of the EUT; use ANSI C63.26-2015 subclause 5.2.4.4.1, for power measurement.
- g) Remove the EUT from the measurement setup. Using the same signal generator settings, repeat the power measurement at the signal generator port, which was used as the input signal to the EUT, and record as the input power. EUT gain may be calculated as described in 3.5.5.
- h) Repeat steps f) and g) with input signal amplitude set to 3 dB above the AGC threshold level.
- i) Repeat steps e) to h) with the narrowband test signal.
- j) Repeat steps e) to i) for all frequency bands authorized for use by the EUT.

3.5.5 Calculating amplifier, repeater, or industrial booster gain

After the input and output power levels have been measured as described in the preceding subclauses, the gain of the EUT can be determined from:

$$\text{Gain (dB)} = \text{output power (dBm)} - \text{input power (dBm)}.$$

Report the gain for each authorized operating frequency band, and each test signal stimulus.

Note. If f_0 that determined from out-of-band test is smaller or greater than difference of test signal's center frequency and operation band block, test is performed at the lowest or the highest frequency that test signals can be passed.

Tabular data of Input / Output Power and Gain

Test Band	Link	Signal	f ₀ Frequency (MHz)	Input Power (dBm)	Output Power (dBm)	Gain (dB)
PCS	Downlink	GSM	1 939.26	-15.34	43.07	58.41
		CDMA	1 939.26	-15.16	42.94	58.10
		WCDMA	1 939.26	-14.97	42.47	57.44
		LTE 5 MHz	1 939.26	-15.02	43.14	58.16
		LTE 10 MHz	1 939.26	-15.03	42.99	58.02

Tabular data of Input / 3 dB above AGC threshold Output Power and Gain

Test Band	Link	Signal	f ₀ Frequency (MHz)	Input Power (dBm)	+3 dB Output Power (dBm)	Gain (dB)
PCS	Downlink	GSM	1 939.26	-12.34	43.09	55.43
		CDMA	1 939.26	-12.16	43.17	55.33
		WCDMA	1 939.26	-11.97	42.94	54.91
		LTE 5 MHz	1 939.26	-12.02	43.09	55.11
		LTE 10 MHz	1 939.26	-12.03	42.91	54.94

Tabular data of PAPR

Test Band	Link	Signal	f ₀ Frequency (MHz)	0.1 % PAPR (dB)
PCS	Downlink	GSM	1 939.26	1.09
		CDMA	1 939.26	7.74
		WCDMA	1 939.26	4.44
		LTE 5 MHz	1 939.26	8.20
		LTE 10 MHz	1 939.26	8.32

Plot data of PAPR

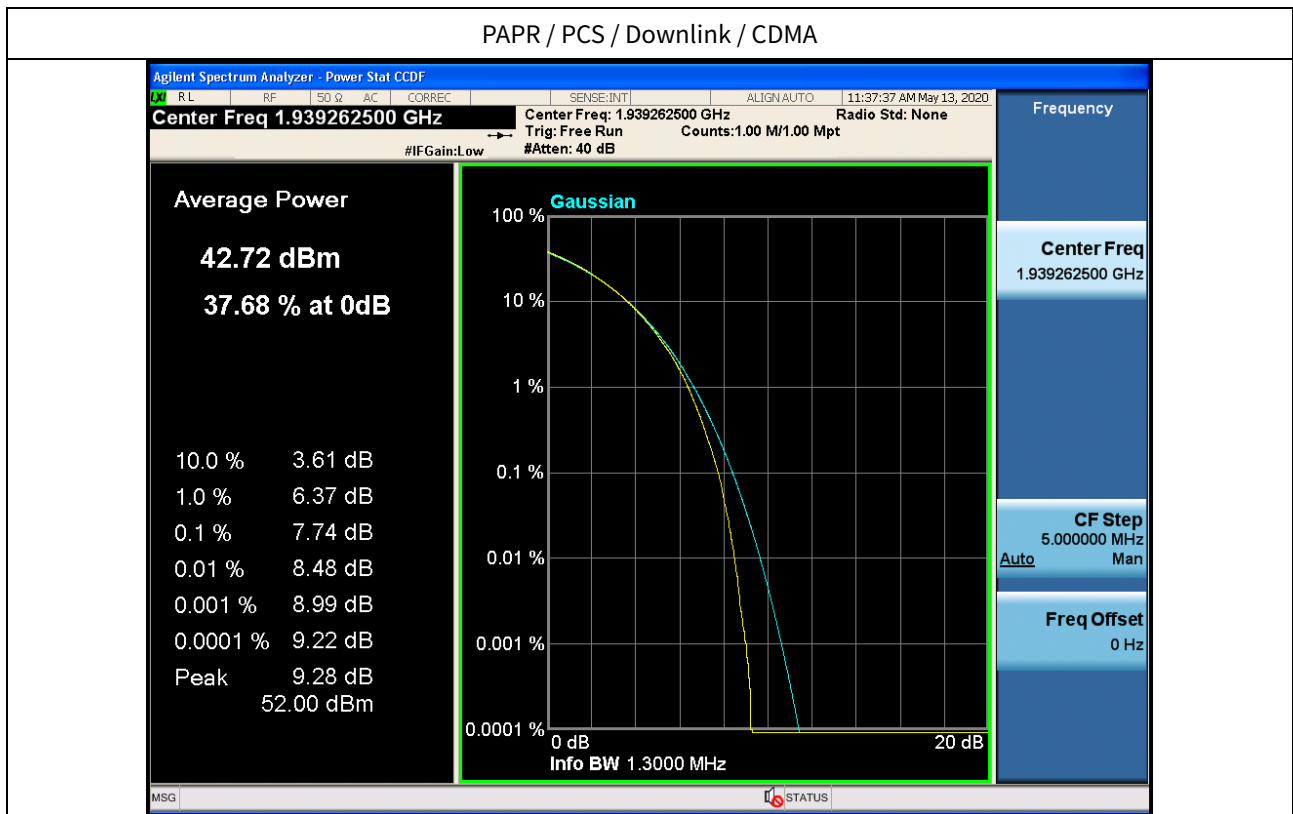
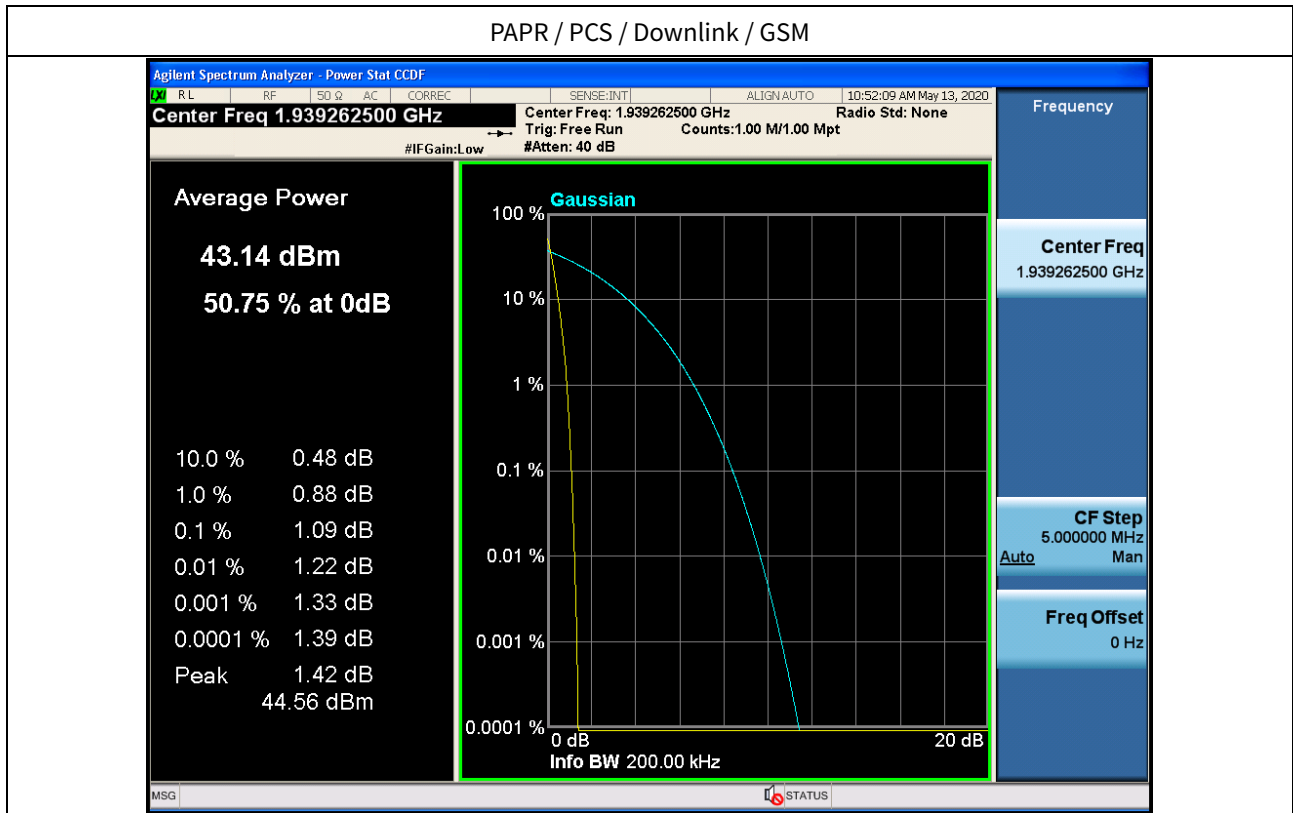

PAPR / PCS / Downlink / WCDMA

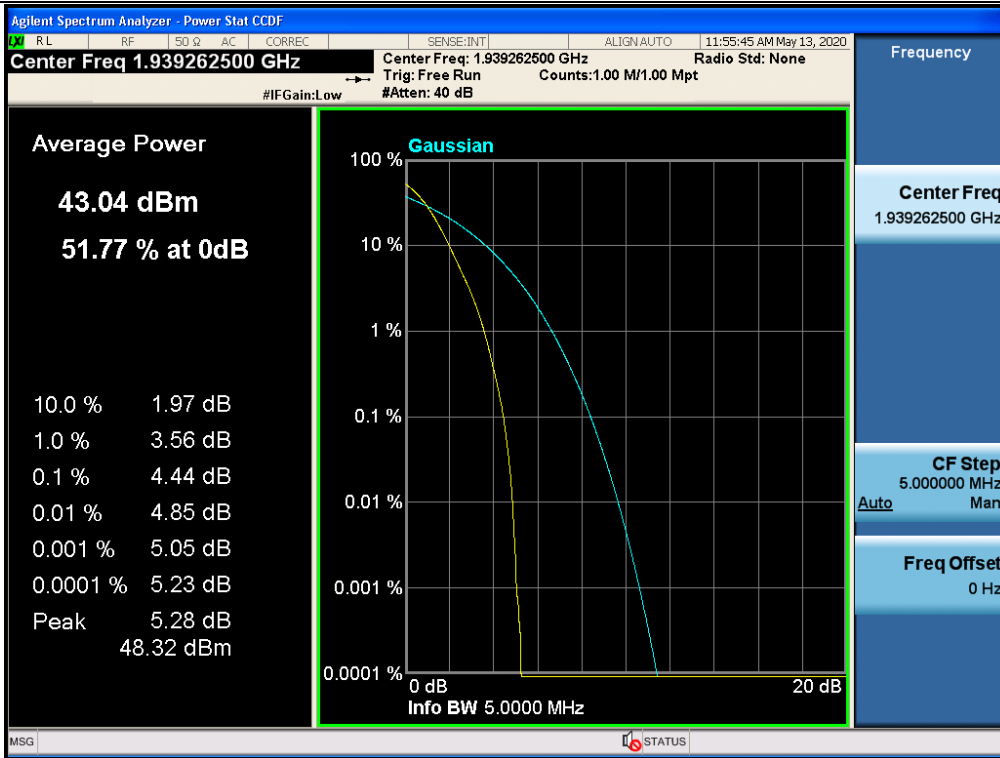

PAPR / PCS / Downlink / LTE 5 MHz

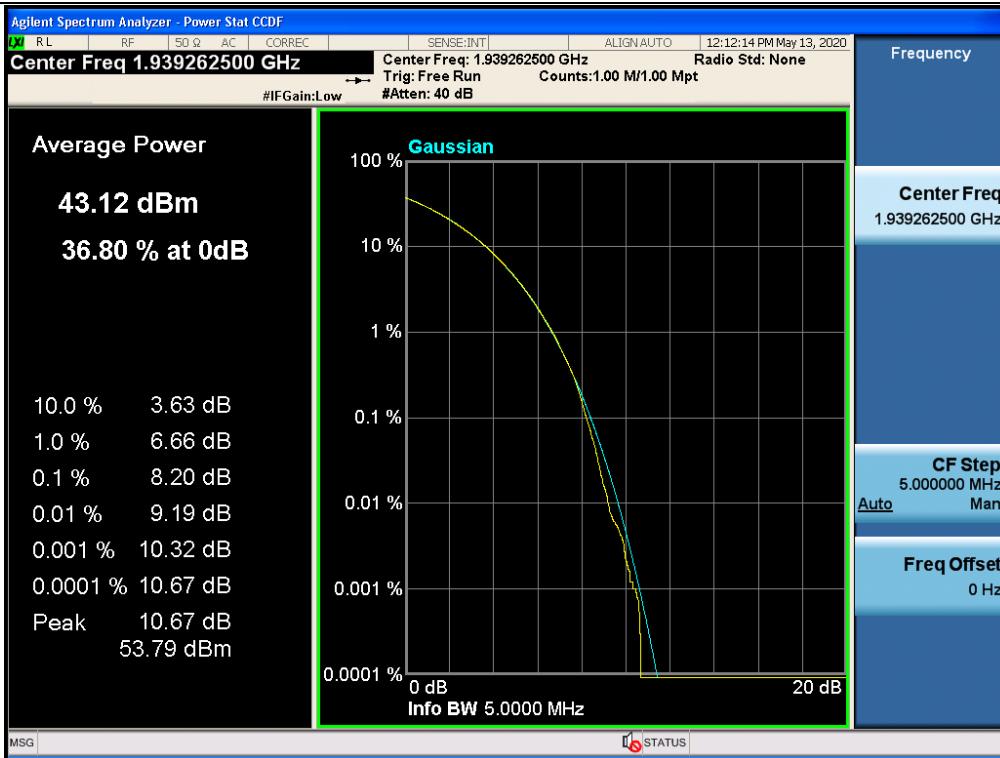

PAPR / PCS / Downlink / LTE 10 MHz

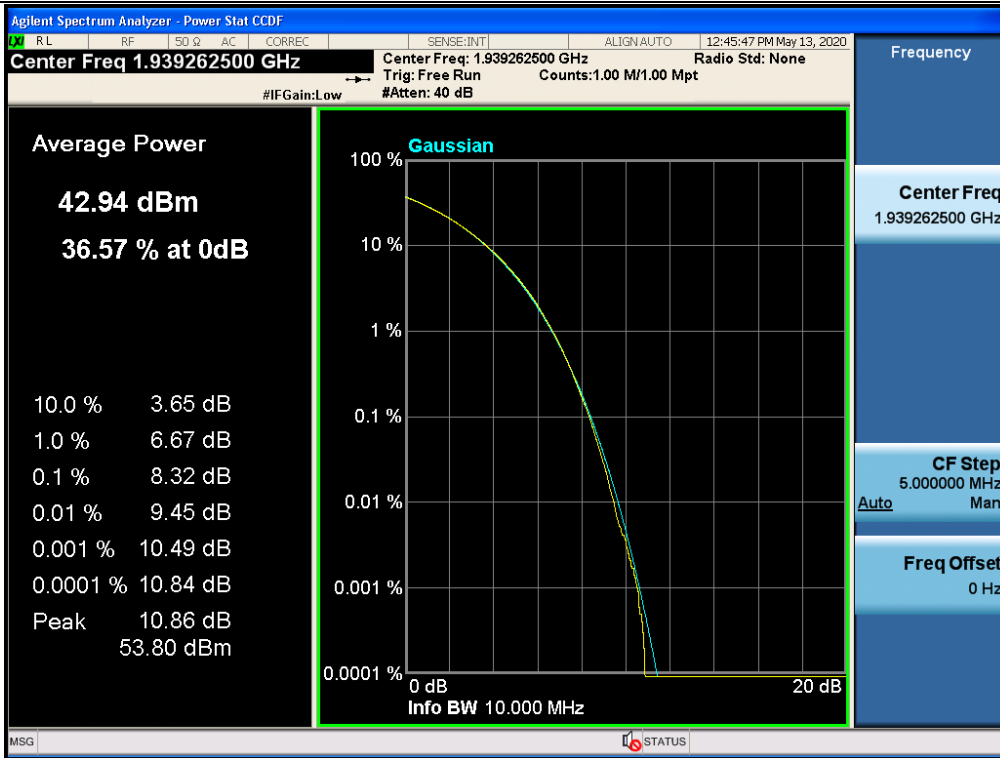

5.5. OUT-OF-BAND/OUT-OF-BLOCK EMISSIONS AND SPURIOUS EMISSIONS

Test Requirement(s):

§ 2.1051 Measurements required: Spurious emissions at antenna terminals:

The radio frequency voltage or powers generated within the equipment and appearing on a spurious frequency shall be checked at the equipment output terminals when properly loaded with a suitable artificial antenna. Curves or equivalent data shall show the magnitude of each harmonic and other spurious emission that can be detected when the equipment is operated under the conditions specified in § 2.1049 as appropriate. The magnitude of spurious emissions which are attenuated more than 20 dB below the permissible value need not be specified.

§ 24.238 Emission limitations for Broadband PCS equipment.

The rules in this section govern the spectral characteristics of emissions in the Broadband Personal Communications Service.

(a) *Out of band emissions.* The power of any emission outside of the authorized operating frequency ranges must be attenuated below the transmitting power (P) by a factor of at least $43 + 10 \log(P)$ dB.

(b) *Measurement procedure.* Compliance with these rules is based on the use of measurement instrumentation employing a resolution bandwidth of 1 MHz or greater. However, in the 1 MHz bands immediately outside and adjacent to the frequency block a resolution bandwidth of at least one percent of the emission bandwidth of the fundamental emission of the transmitter may be employed. A narrower resolution bandwidth is permitted in all cases to improve measurement accuracy provided the measured power is integrated over the full required measurement bandwidth (*i.e.* 1 MHz or 1 percent of emission bandwidth, as specified). The emission bandwidth is defined as the width of the signal between two points, one below the carrier center frequency and one above the carrier center frequency, outside of which all emissions are attenuated at least 26 dB below the transmitter power.

(c) *Alternative out of band emission limit.* Licensees in this service may establish an alternative out of band emission limit to be used at specified band edge(s) in specified geographical areas, in lieu of that set forth in this section, pursuant to a private contractual arrangement of all affected licensees and applicants. In this event, each party to such contract shall maintain a copy of the contract in their station files and disclose it to prospective assignees or transferees and, upon request, to the FCC.

(d) *Interference caused by out of band emissions.* If any emission from a transmitter operating in this service results in interference to users of another radio service, the FCC may require a greater attenuation of that emission than specified in this section.

Test Procedures:

Measurements were in accordance with the test methods section 3.6 of KDB 935210 D05 v01r04.

Spurious emissions shall be measured using a single test signal sequentially tuned to the low, middle, and high channels or frequencies within each authorized frequency band of operation.

Out-of-band/out-of-block emissions (including intermodulation products) shall be measured under each of the following two stimulus conditions:

a) two adjacent test signals sequentially tuned to the lower and upper frequency band/block edges;

b) a single test signal, sequentially tuned to the lowest and highest frequencies or channels within the frequency band/block under examination.

NOTE—Single-channel boosters that cannot accommodate two simultaneous signals within the passband may be excluded from the test stipulated in step a).

3.6.2 Out-of-band/out-of-block emissions conducted measurements

- a) Connect a signal generator to the input of the EUT.
If the signal generator is not capable of generating two modulated carriers simultaneously, then two discrete signal generators can be connected with an appropriate combining network to support this two-signal test.
- b) Set the signal generator to produce two AWGN signals as previously described.
- c) Set the center frequencies such that the AWGN signals occupy adjacent channels, as defined by industry standards such as 3GPP or 3GPP2, at the upper edge of the frequency band or block under test.
- d) Set the composite power levels such that the input signal is just below the AGC threshold, but not more than 0.5 dB below. The composite power can be measured using the procedures provided in KDB Publication 971168, but it will be necessary to expand the power integration bandwidth so as to include both of the transmit channels.
- e) Connect a spectrum analyzer to the output of the EUT using appropriate attenuation as necessary.
- f) Set the RBW = reference bandwidth in the applicable rule section for the supported frequency band.
- g) Set the VBW = $3 \times$ RBW.
- h) Set the detector to power averaging (rms) detector.
- i) Set the Sweep time = auto-couple.
- j) Set the spectrum analyzer start frequency to the upper block edge frequency, and the stop frequency to the upper block edge frequency plus 300 kHz or 3 MHz, for frequencies below and above 1 GHz, respectively.
- k) Trace average at least 100 traces in power averaging (rms) mode.
- l) Use the marker function to find the maximum power level.
- m) Capture the spectrum analyzer trace of the power level for inclusion in the test report.
- n) Repeat steps k) to m) with the composite input power level set to 3 dB above the AGC threshold.
- o) Reset the frequencies of the input signals to the lower edge of the frequency block or band under test.
- p) Reset the spectrum analyzer start frequency to the lower block edge frequency minus 300 kHz or 3 MHz, for frequencies below and above 1 GHz, respectively, and the stop frequency to the lower band or block edge frequency.
- q) Repeat steps k) to n).
- r) Repeat steps a) to q) with the signal generator configured for a single test signal tuned as close as possible to the block edges.
- s) Repeat steps a) to r) with the narrowband test signal.
- t) Repeat steps a) to s) for all authorized frequency bands or blocks used by the EUT.

3.6.3 Spurious emissions conducted measurements

- a) Connect a signal generator to the input of the EUT.
- b) Set the signal generator to produce the broadband test signal as previously described.
- c) Set the center frequency of the test signal to the lowest available channel within the frequency band or block.
- d) Set the EUT input power to a level that is just below the AGC threshold, but not more than 0.5 dB below.

- e) Connect a spectrum analyzer to the output of the EUT using appropriate attenuation as necessary.
- f) Set the RBW = reference bandwidth in the applicable rule section for the supported frequency band of operation.
- g) Set the VBW $\geq 3 \times$ RBW.
- h) Set the Sweep time = auto-couple.
- i) Set the spectrum analyzer start frequency to the lowest RF signal generated in the equipment, without going below 9 kHz, and the stop frequency to the lower band/block edge frequency minus 1 MHz.
The number of measurement points in each sweep must be $\geq (2 \times \text{span}/\text{RBW})$, which may require that the measurement range defined by the start and stop frequencies be subdivided, depending on the available number of measurement points provided by the spectrum analyzer.
- j) Select the power averaging (rms) detector function.
- k) Trace average at least 10 traces in power averaging (rms) mode.
- l) Use the peak marker function to identify the highest amplitude level over each measured frequency range. Record the frequency and amplitude and capture a plot for inclusion in the test report.
- m) Reset the spectrum analyzer start frequency to the upper band/block edge frequency plus 1 MHz, and the spectrum analyzer stop frequency to 10 times the highest frequency of the fundamental emission. The number of measurement points in each sweep must be $\geq (2 \times \text{span}/\text{RBW})$, which may require that the measurement range defined by the start and stop frequencies be subdivided, depending on the available number of measurement points provided by the spectrum analyzer.
- n) Trace average at least 10 traces in power averaging (rms) mode.
- o) Use the peak marker function to identify the highest amplitude level over each of the measured frequency ranges. Record the frequency and amplitude and capture a plot for inclusion in the test report; also provide tabular data, if required.
- p) Repeat steps i) to o) with the input test signals firstly tuned to a middle band/block frequency/channel, and then tuned to a high band/block frequency/channel.
- q) Repeat steps b) to p) with the narrowband test signal.
- r) Repeat steps b) to q) for all authorized frequency bands/blocks used by the EUT.

Notes:

1. In 9 kHz-150 kHz and 150 kHz-30 MHz bands, RBW was reduced to 1 kHz and 10 kHz and correction factor was applied according to section 5.7.2 of ANSI C63.26-2015

Band	9 ~ 150 kHz Correction	150 kHz ~ 30 MHz Correction
Above 1 GHz (Ref.RBW: 1 MHz)	30 dB	20 dB

2. We have done CDMA and 1xEVDO modulation test in technology. Test results are only attached worst cases.

Test Results: Plot data of Out-of-band/out-of-block emissions

Out-of-band (two adjacent test signals) / PCS / Downlink / GSM / Upper

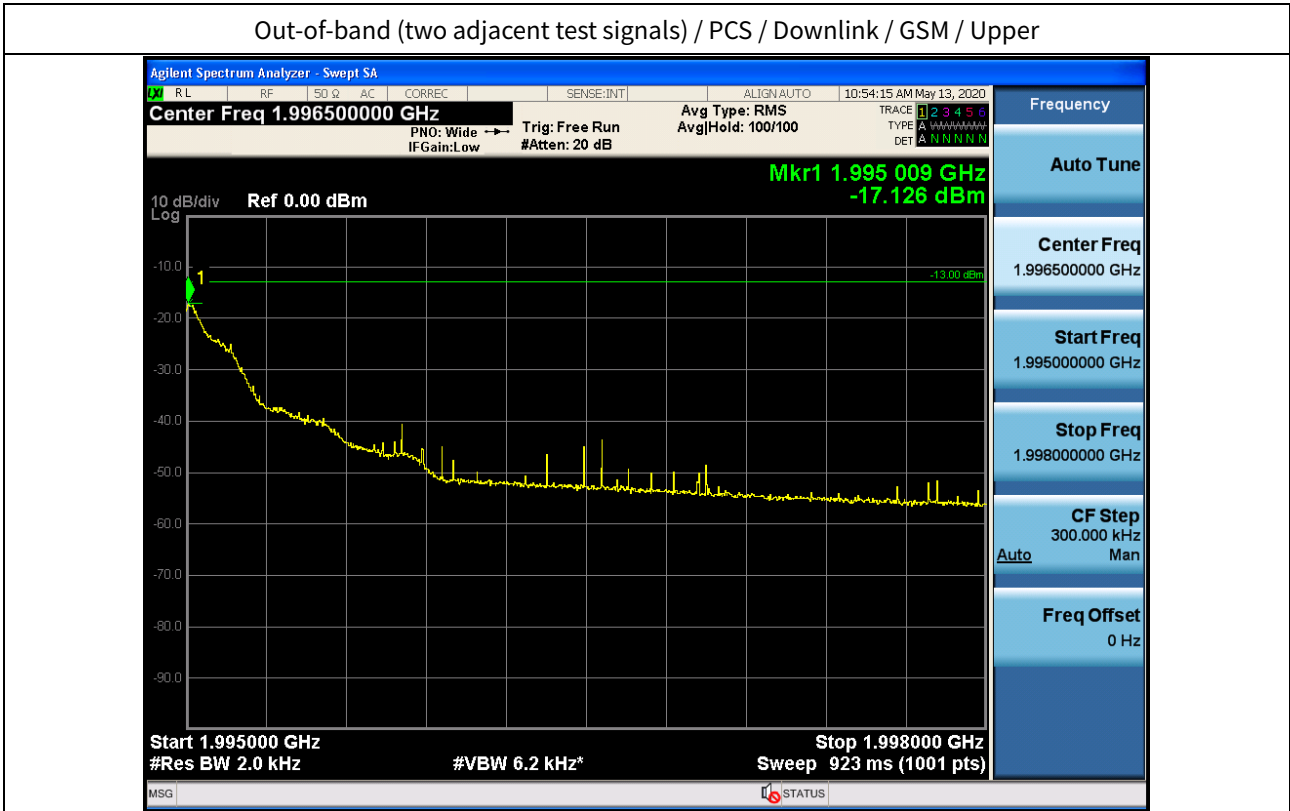

Out-of-band (two adjacent test signals) / PCS / Downlink / GSM / Lower

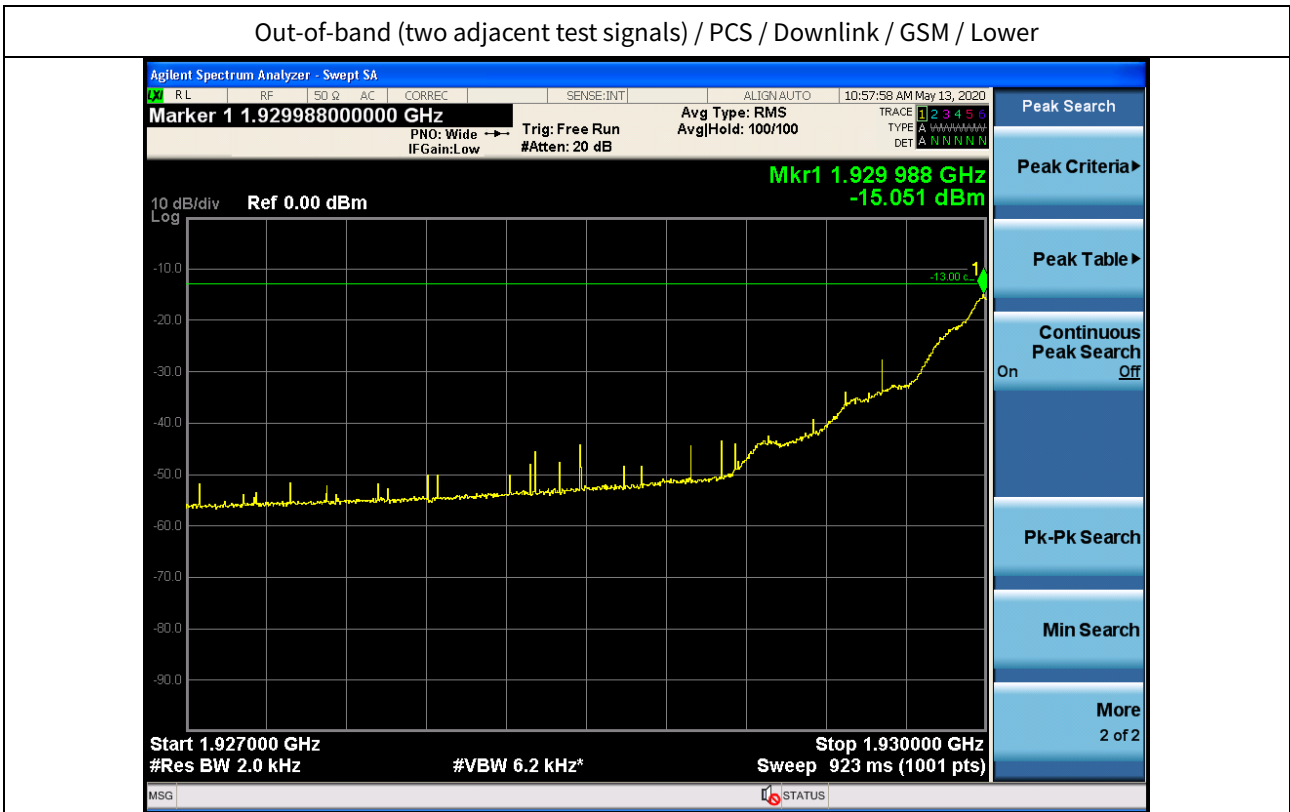

+3 dB above Out-of-band (two adjacent test signals) / PCS / Downlink / GSM / Upper



+3 dB above Out-of-band (two adjacent test signals) / PCS / Downlink / GSM / Lower



Out-of-band (two adjacent test signals) / PCS / Downlink / CDMA / Upper

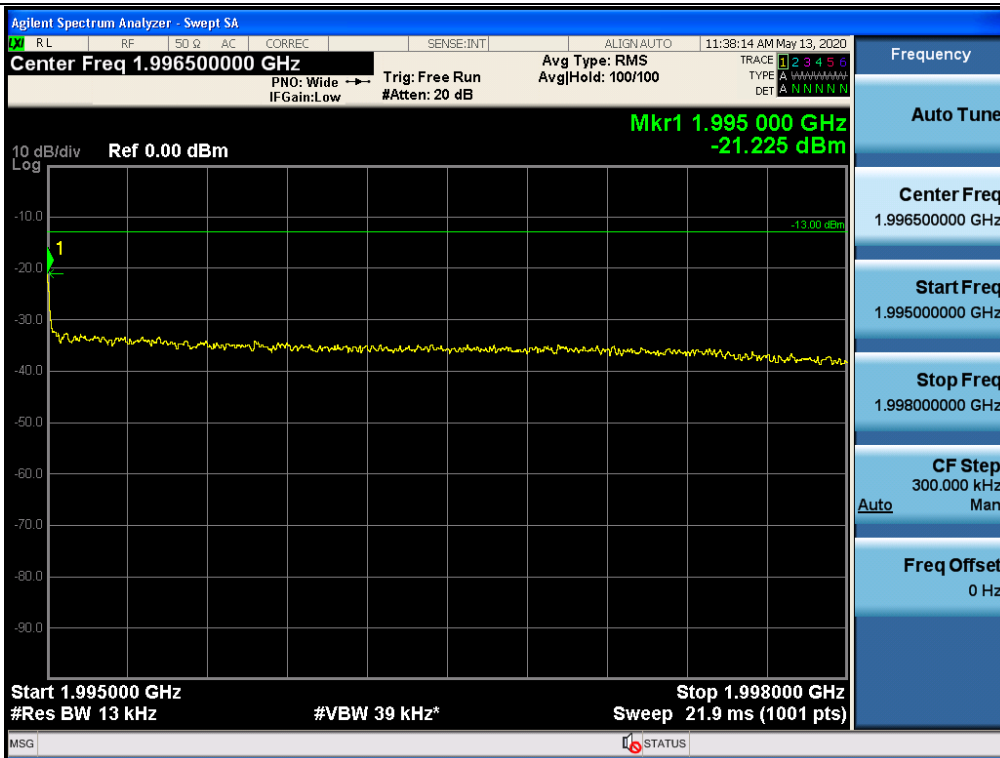

Out-of-band (two adjacent test signals) / PCS / Downlink / CDMA / Lower

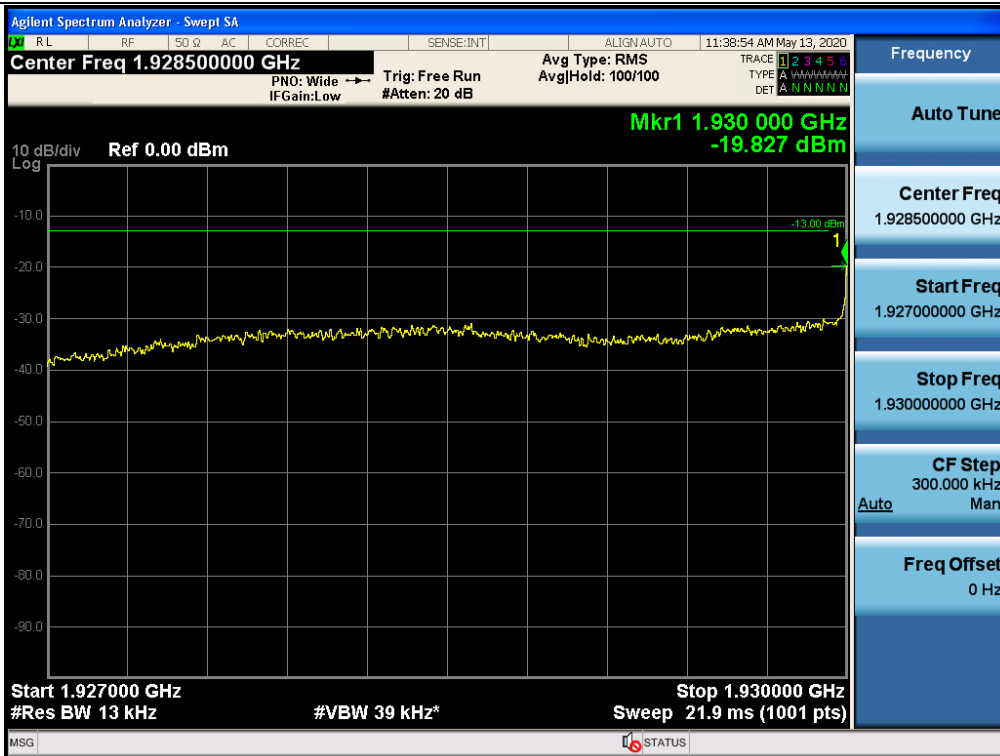

+3 dB above Out-of-band (two adjacent test signals) / PCS / Downlink / CDMA / Upper

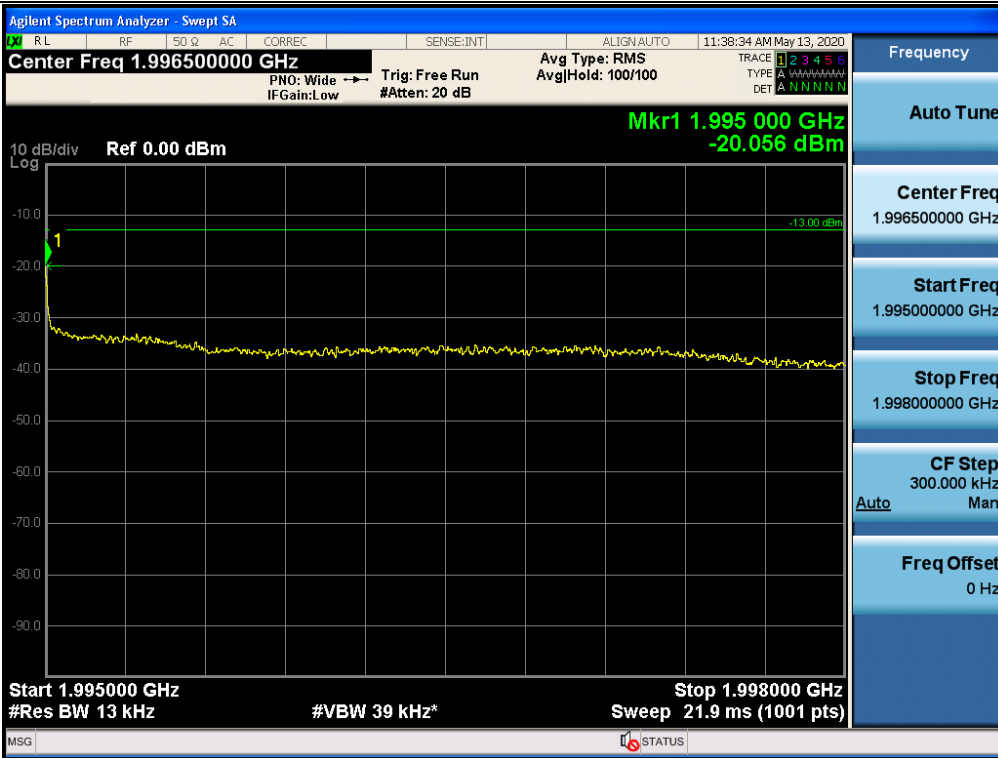

+3 dB above Out-of-band (two adjacent test signals) / PCS / Downlink / CDMA / Lower

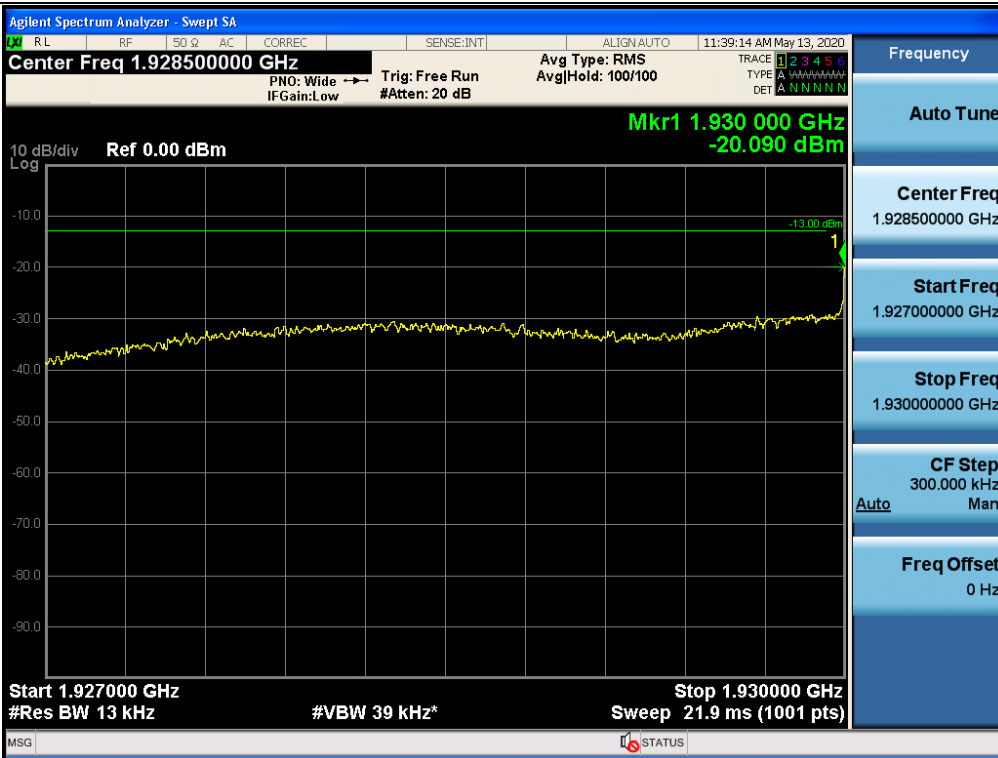

Out-of-band (two adjacent test signals) / PCS / Downlink / WCDMA / Upper

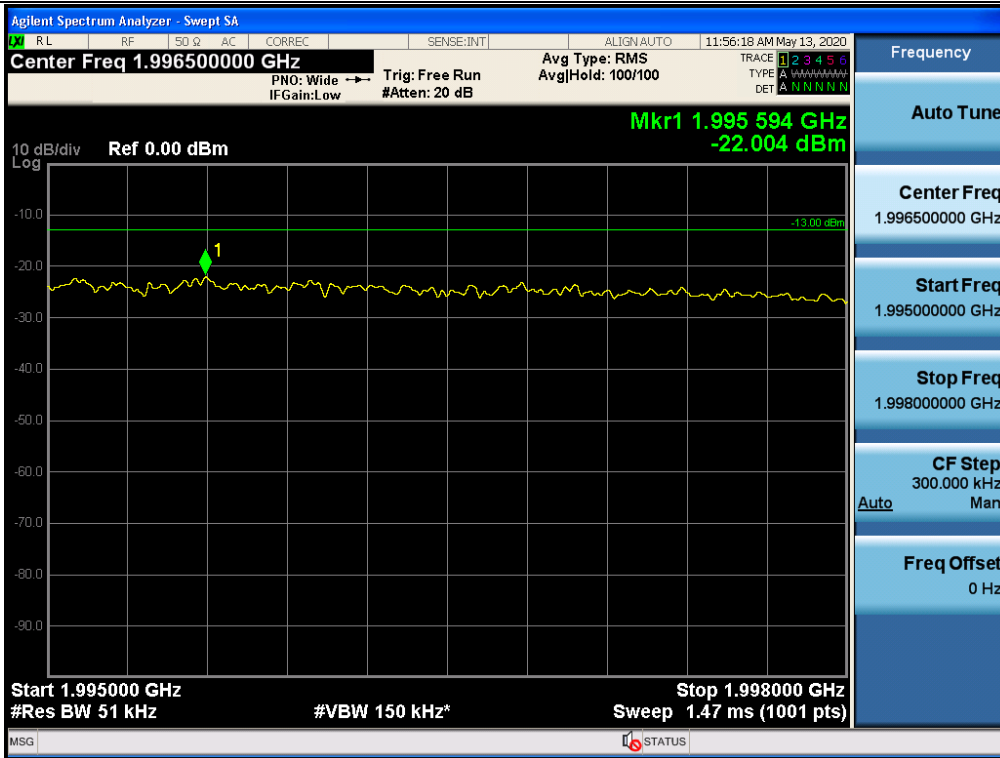

Out-of-band (two adjacent test signals) / PCS / Downlink / WCDMA / Lower

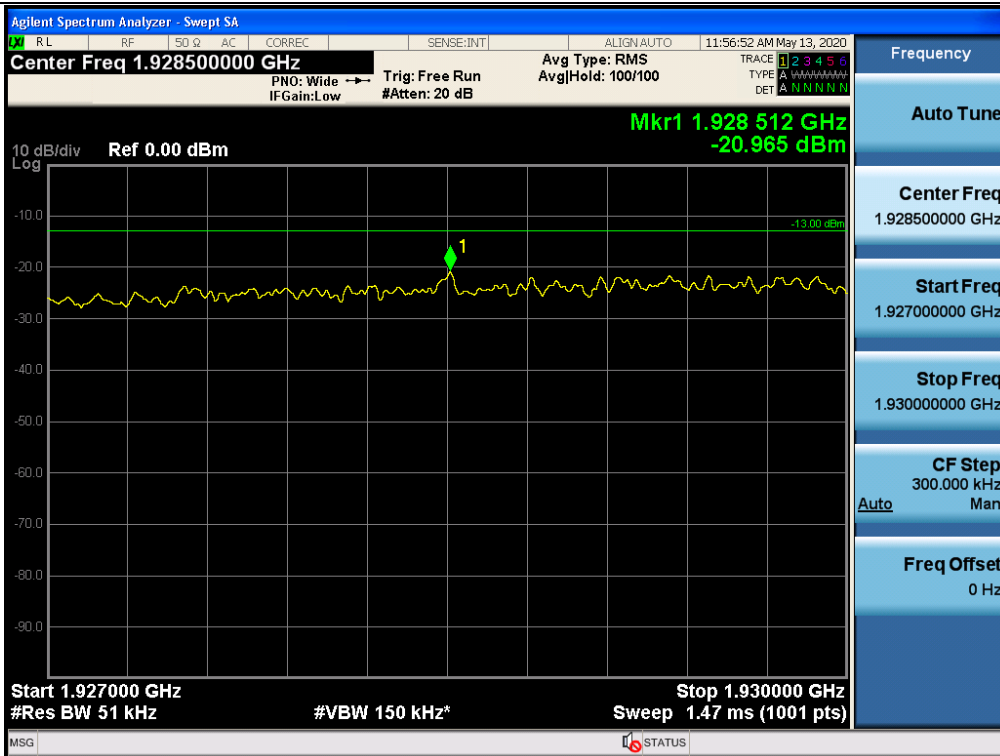

+3 dB above Out-of-band (two adjacent test signals) / PCS / Downlink / WCDMA / Upper

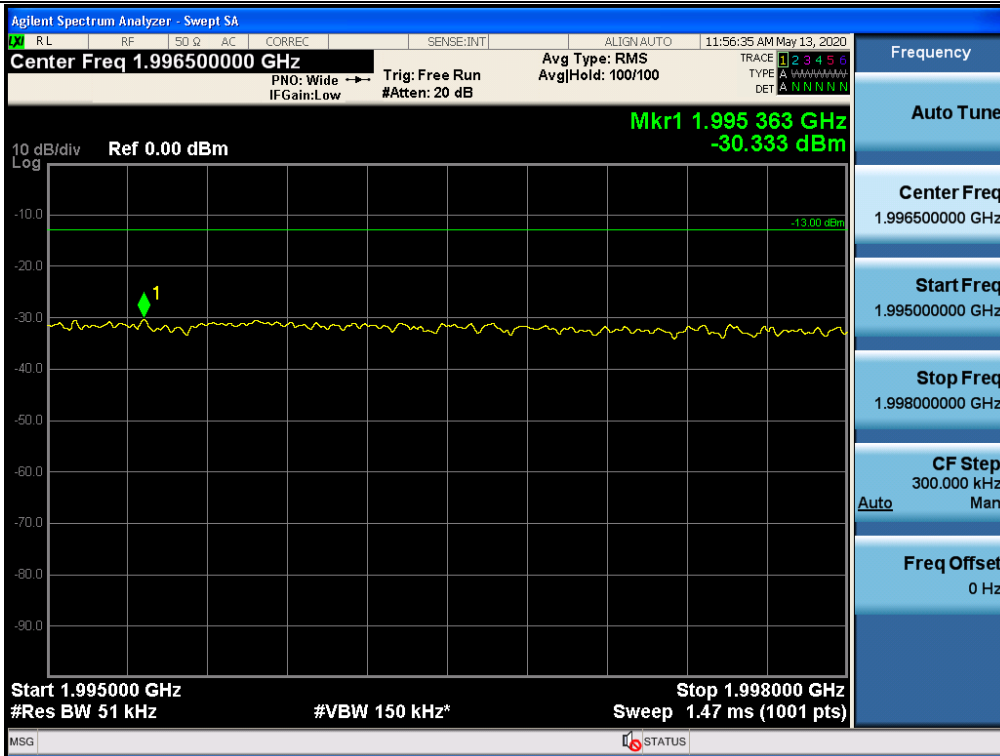

+3 dB above Out-of-band (two adjacent test signals) / PCS / Downlink / WCDMA / Lower

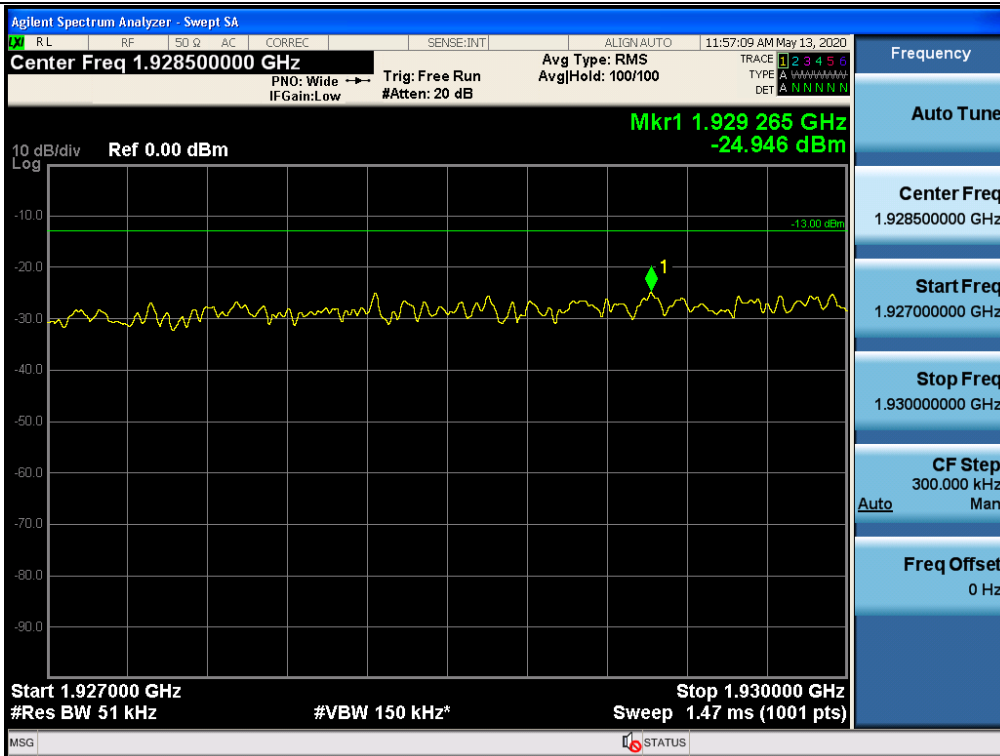

Out-of-band (two adjacent test signals) / PCS / Downlink / LTE 5 MHz / Upper

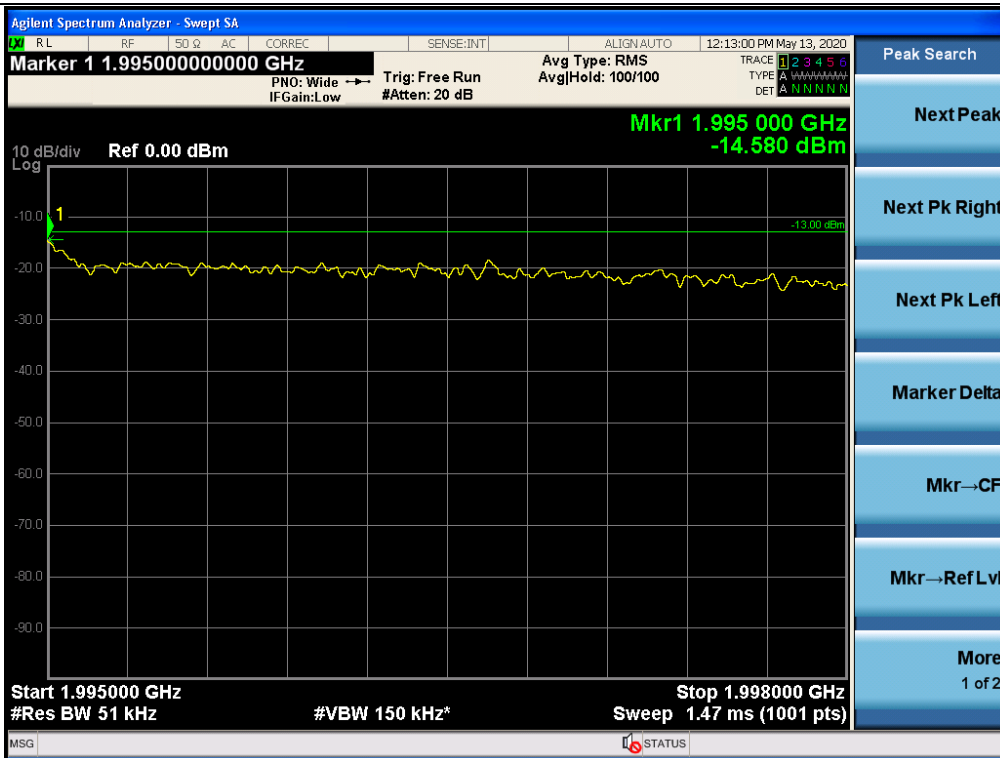

Out-of-band (two adjacent test signals) / PCS / Downlink / LTE 5 MHz / Lower

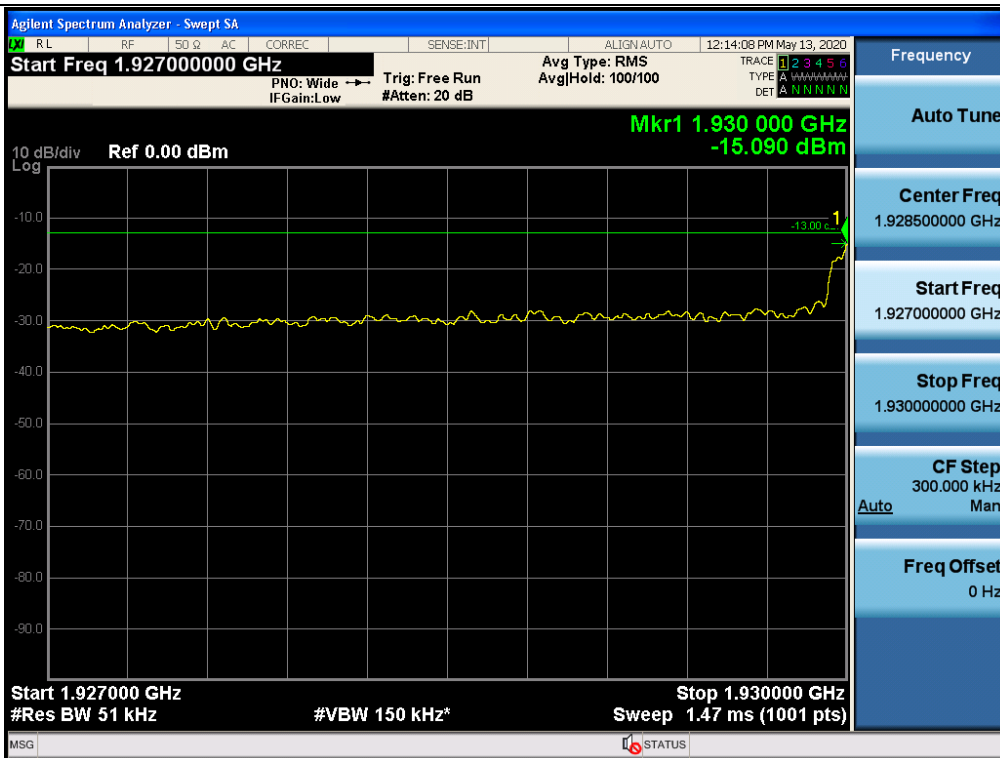

+3 dB above Out-of-band (two adjacent test signals) / PCS / Downlink / LTE 5 MHz / Upper

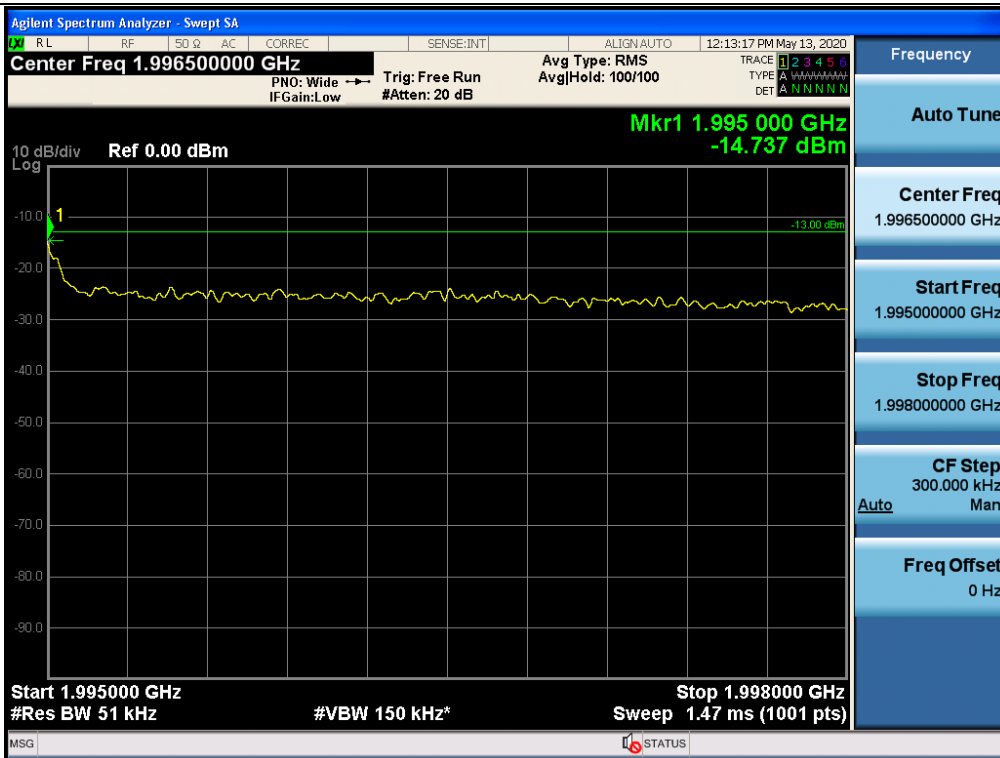

+3 dB above Out-of-band (two adjacent test signals) / PCS / Downlink / LTE 5 MHz / Lower

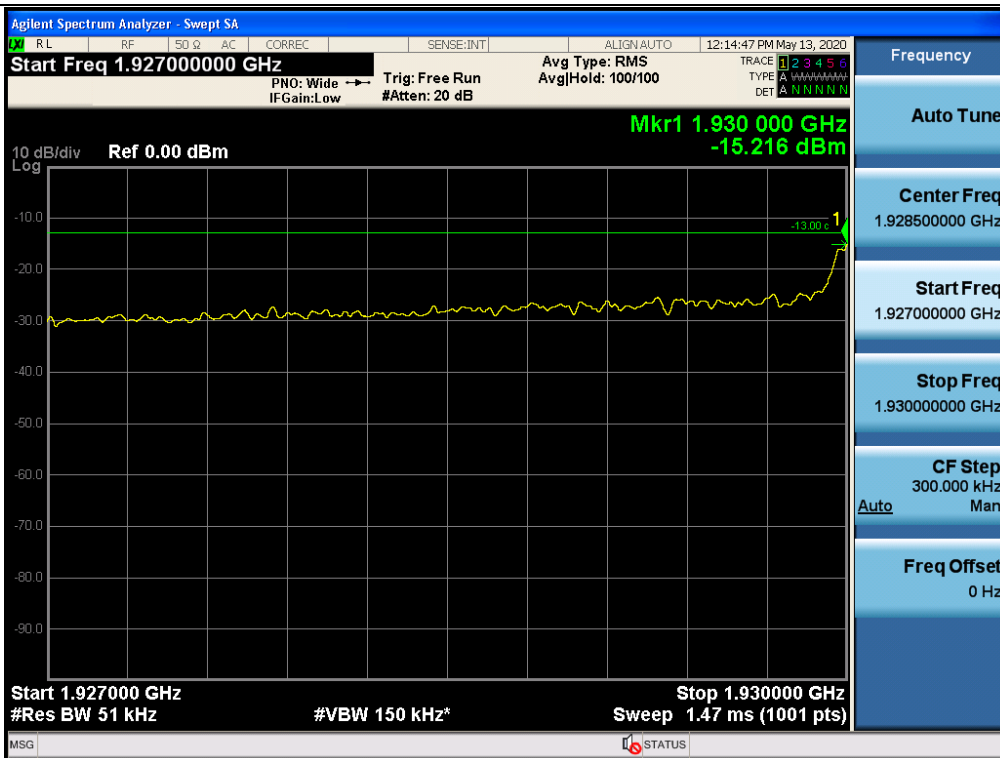

Out-of-band (two adjacent test signals) / PCS / Downlink / LTE 10 MHz / Upper

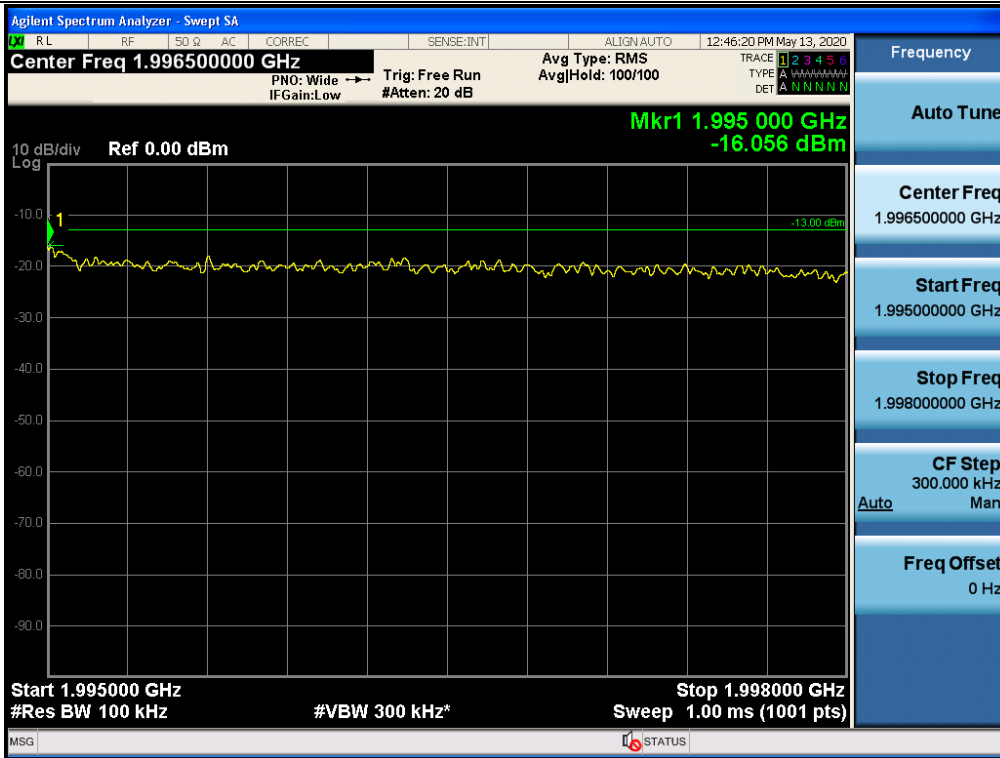

Out-of-band (two adjacent test signals) / PCS / Downlink / LTE 10 MHz / Lower

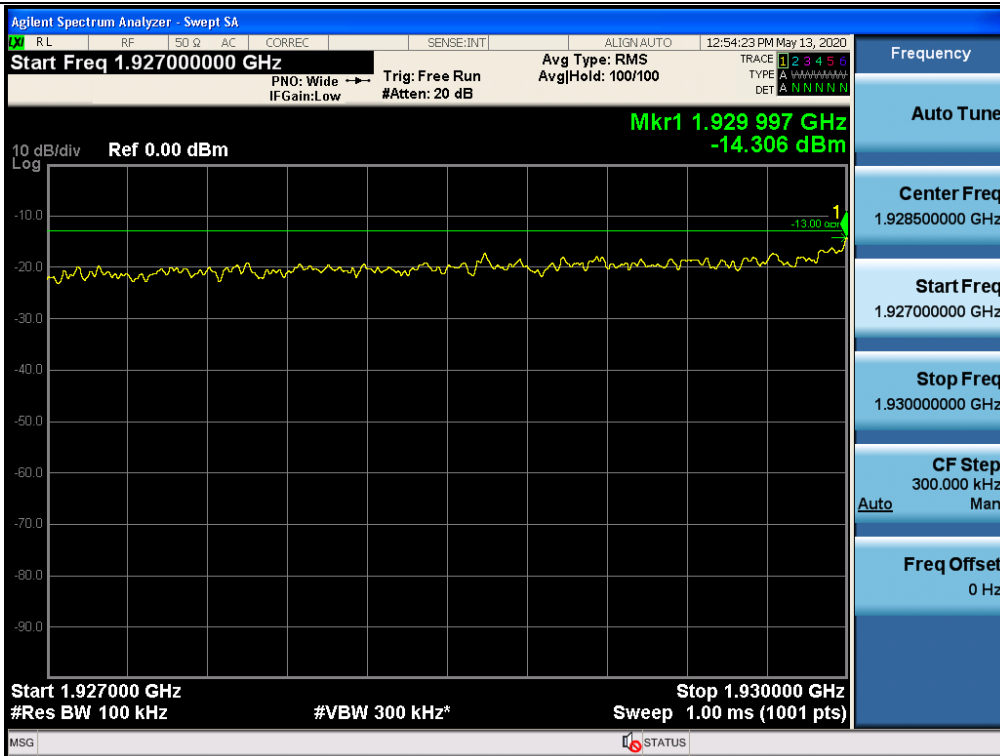

+3 dB above Out-of-band (two adjacent test signals) / PCS / Downlink / LTE 10 MHz / Upper

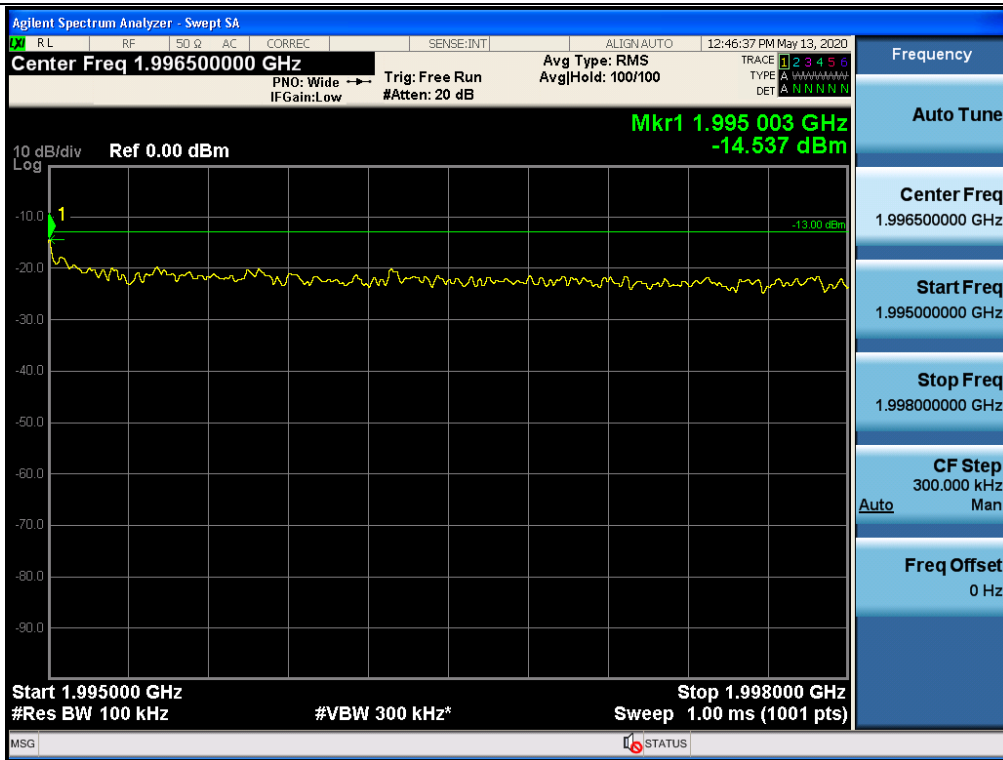

+3 dB above Out-of-band (two adjacent test signals) / PCS / Downlink / LTE 10 MHz / Lower

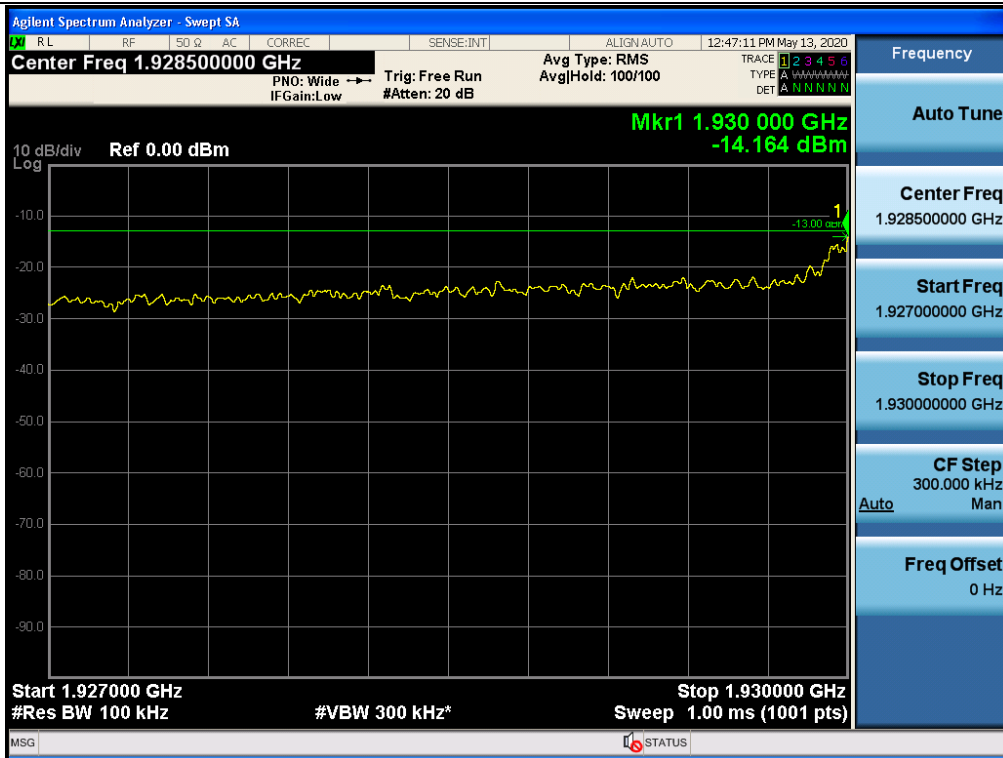

Out-of-band (single test signals) / PCS / Downlink / GSM / Upper

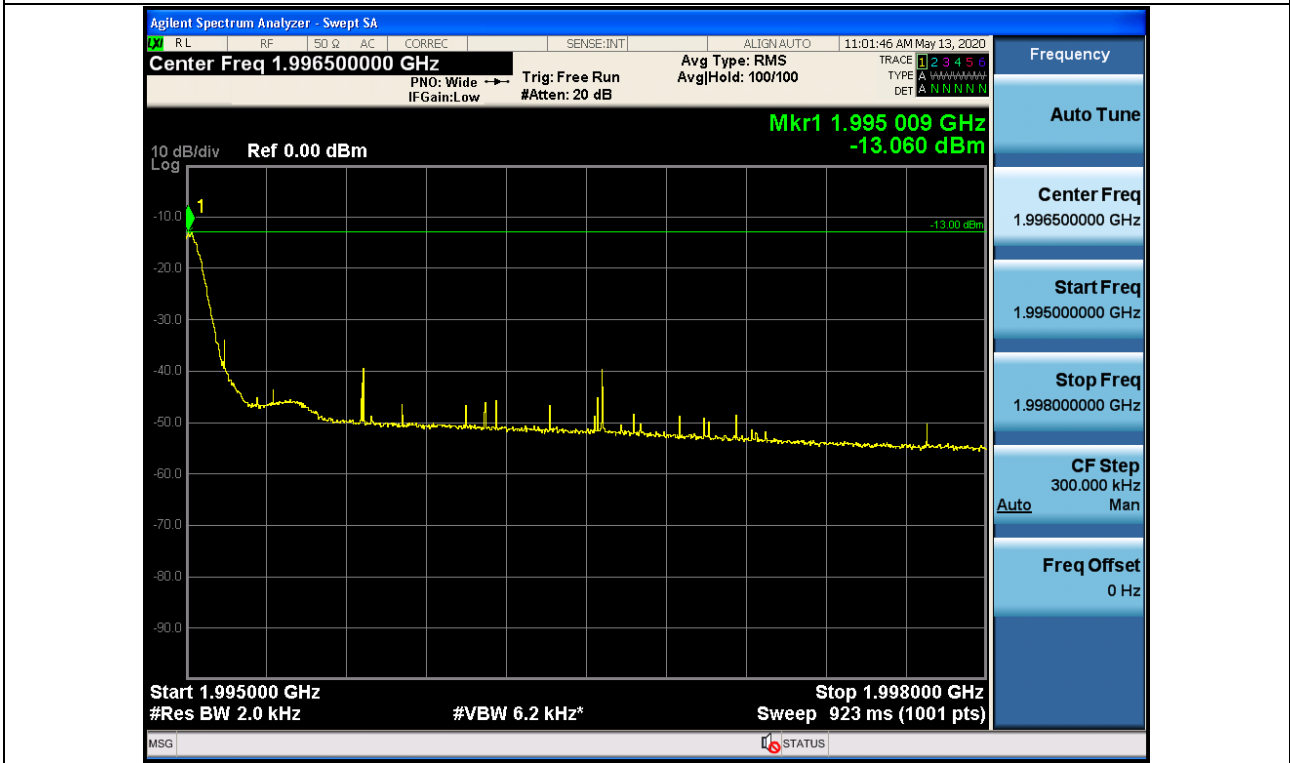

Out-of-band (single test signals) / PCS / Downlink / GSM / Lower

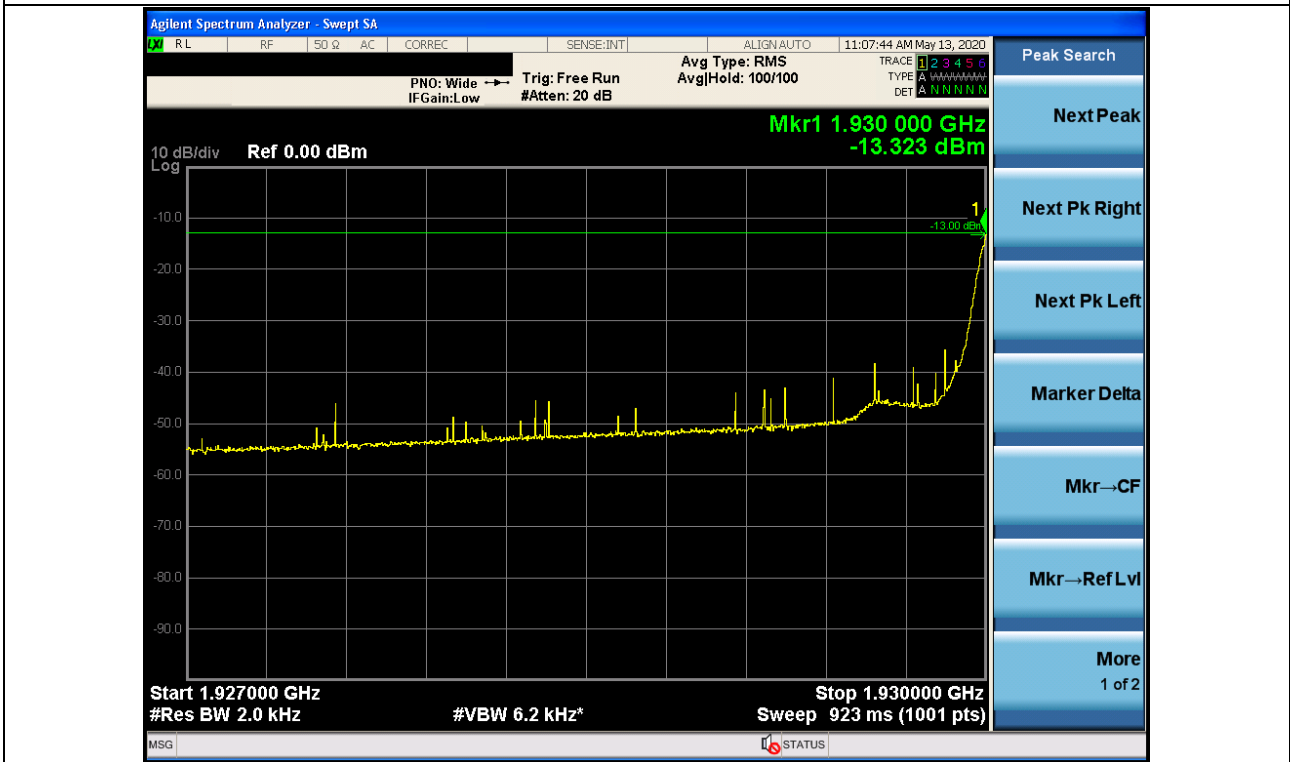

+3 dB above Out-of-band (single test signals) / PCS / Downlink / GSM / Upper

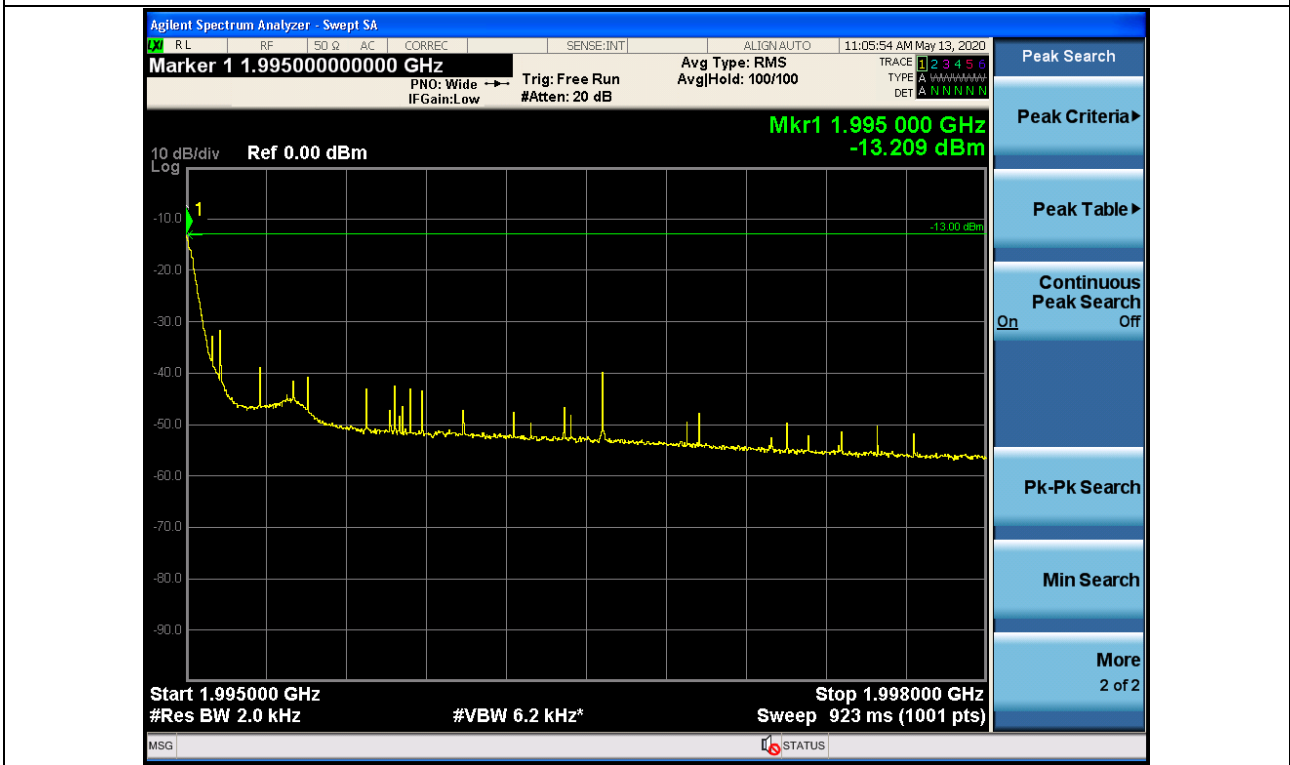

+3 dB above Out-of-band (single test signals) / PCS / Downlink / GSM / Lower

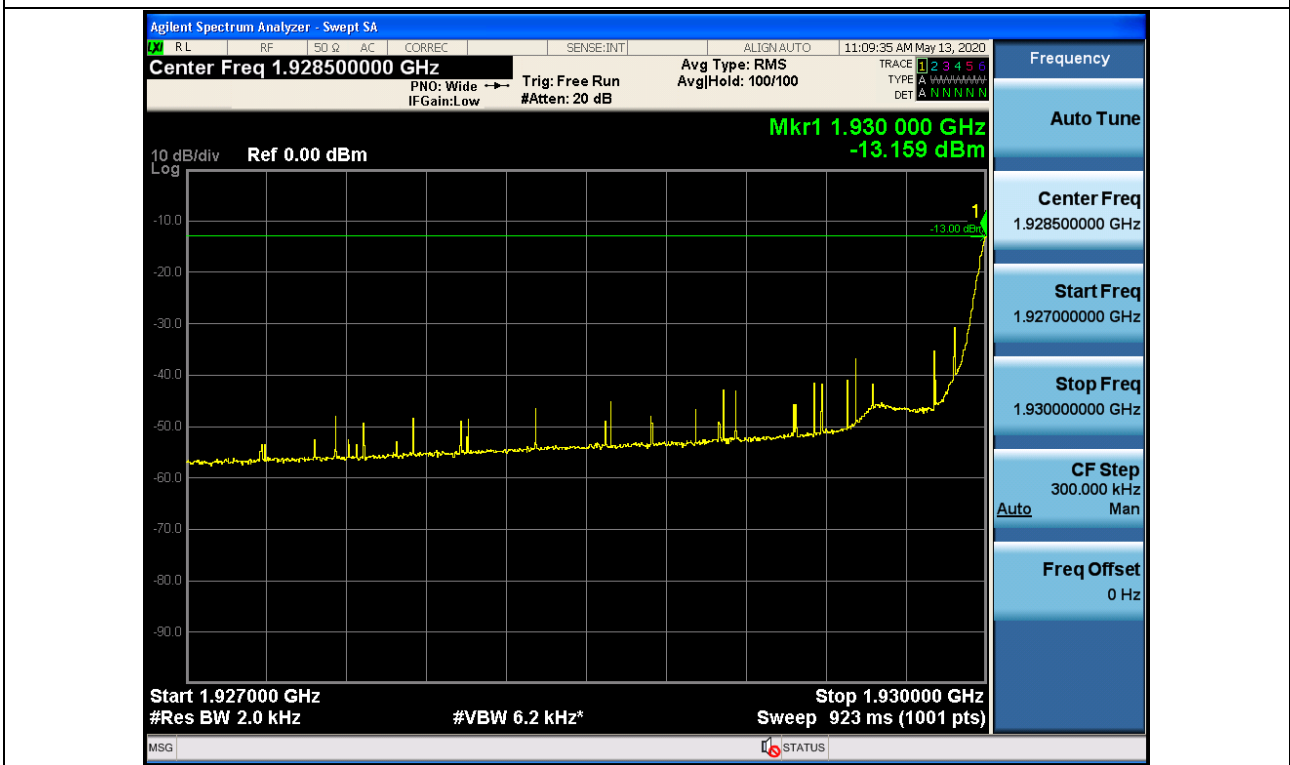

Out-of-band (single test signals) / PCS / Downlink / CDMA / Upper

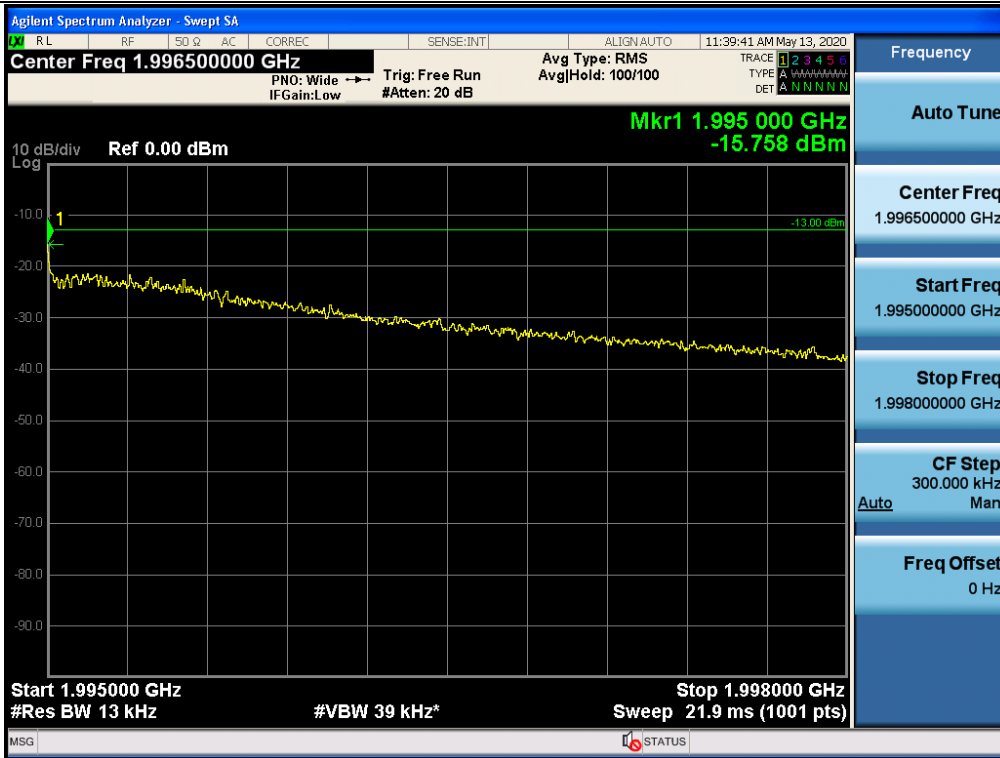

Out-of-band (single test signals) / PCS / Downlink / CDMA / Lower

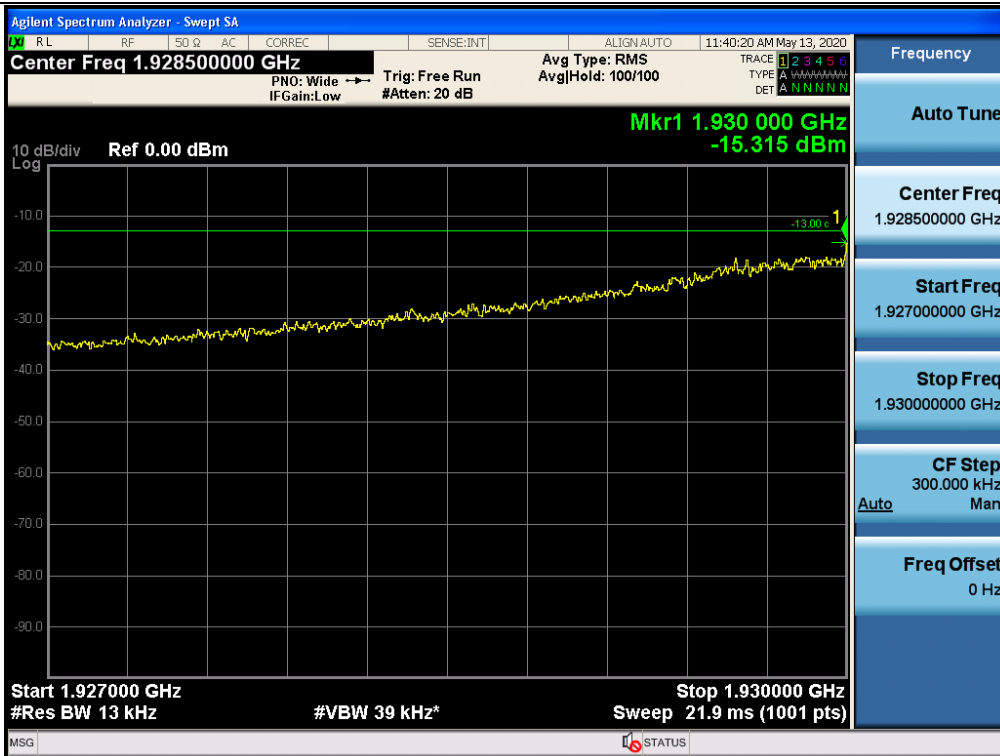

+3 dB above Out-of-band (single test signals) / PCS / Downlink / CDMA / Upper



+3 dB above Out-of-band (single test signals) / PCS / Downlink / CDMA / Lower

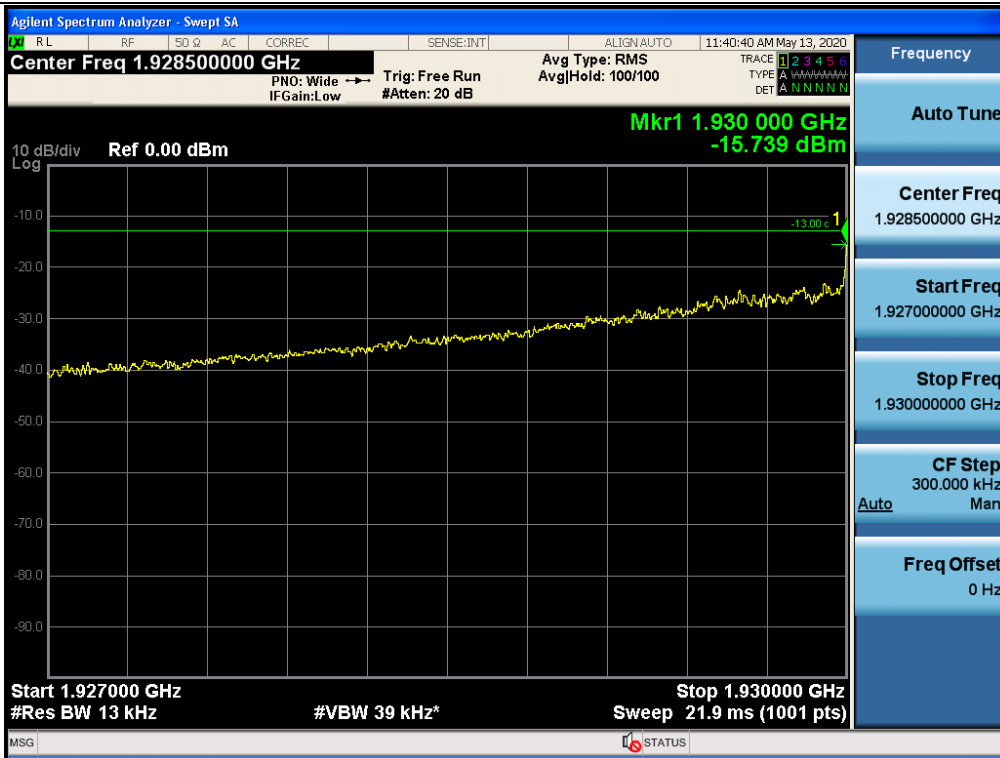

Out-of-band (single test signals) / PCS / Downlink / WCDMA / Upper

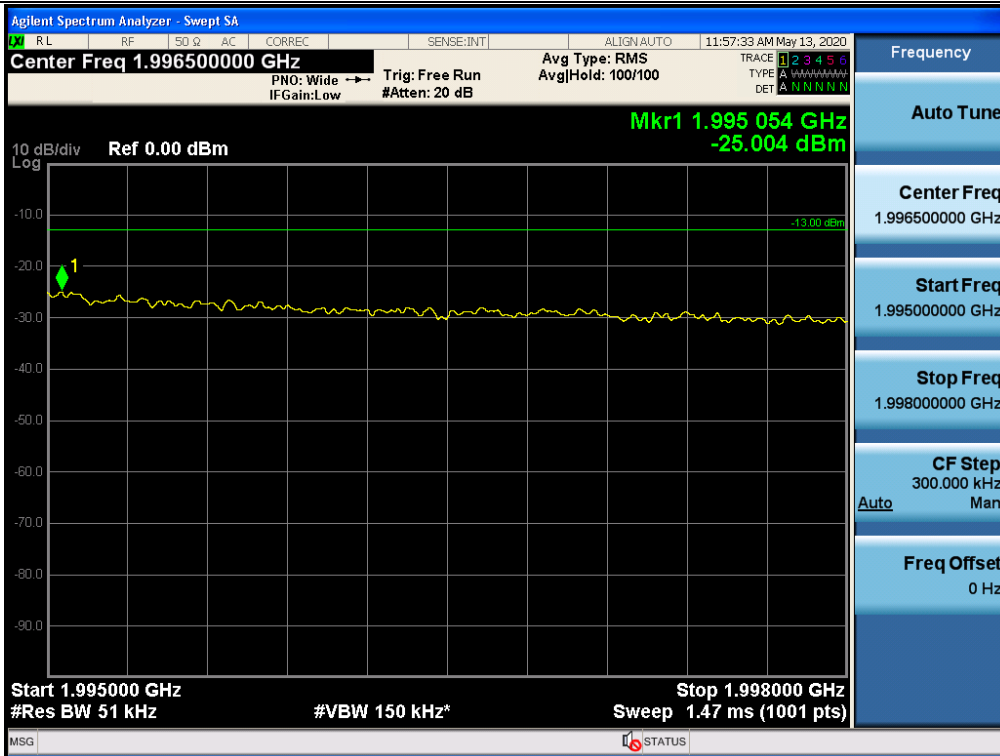

Out-of-band (single test signals) / PCS / Downlink / WCDMA / Lower

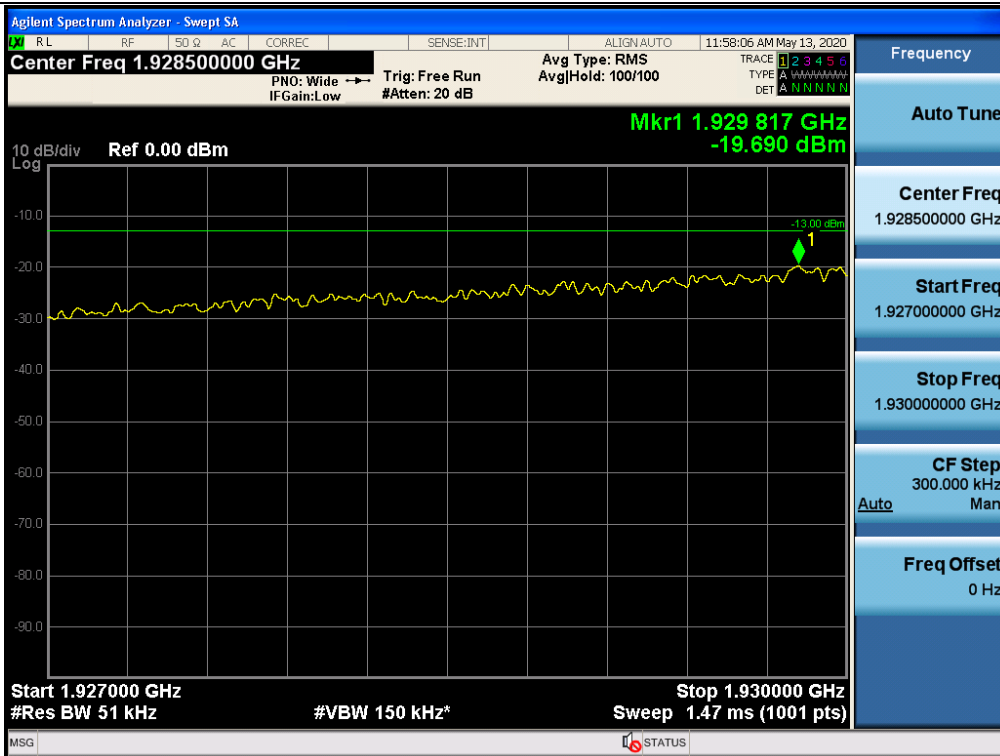

+3 dB above Out-of-band (single test signals) / PCS / Downlink / WCDMA / Upper

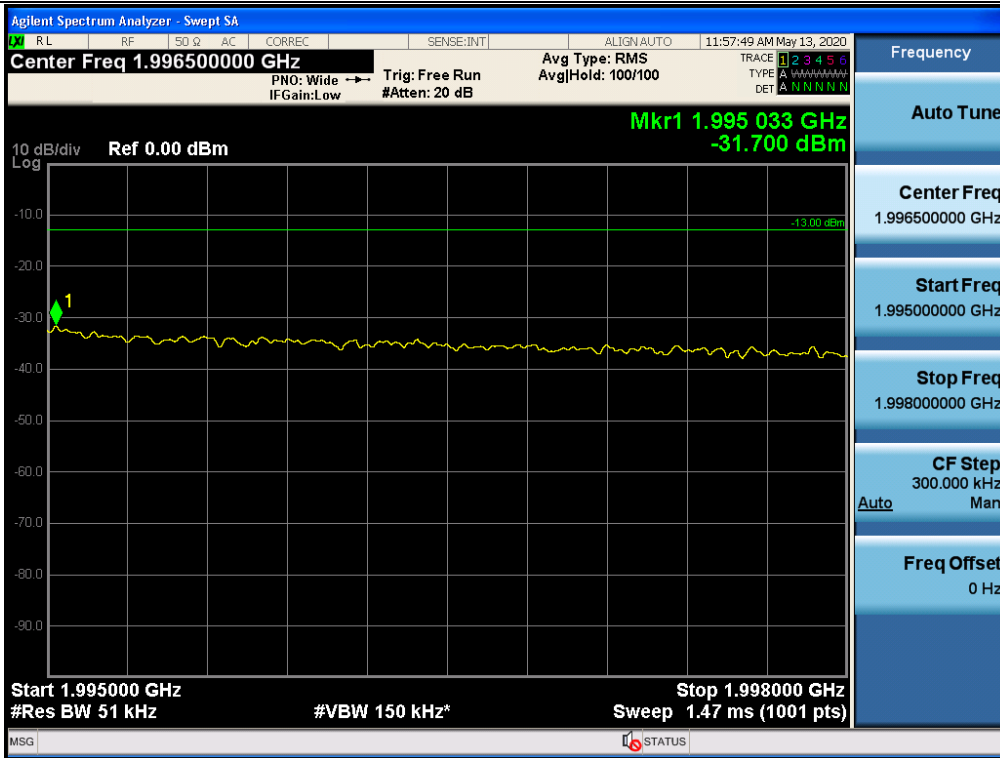

+3 dB above Out-of-band (single test signals) / PCS / Downlink / WCDMA / Lower

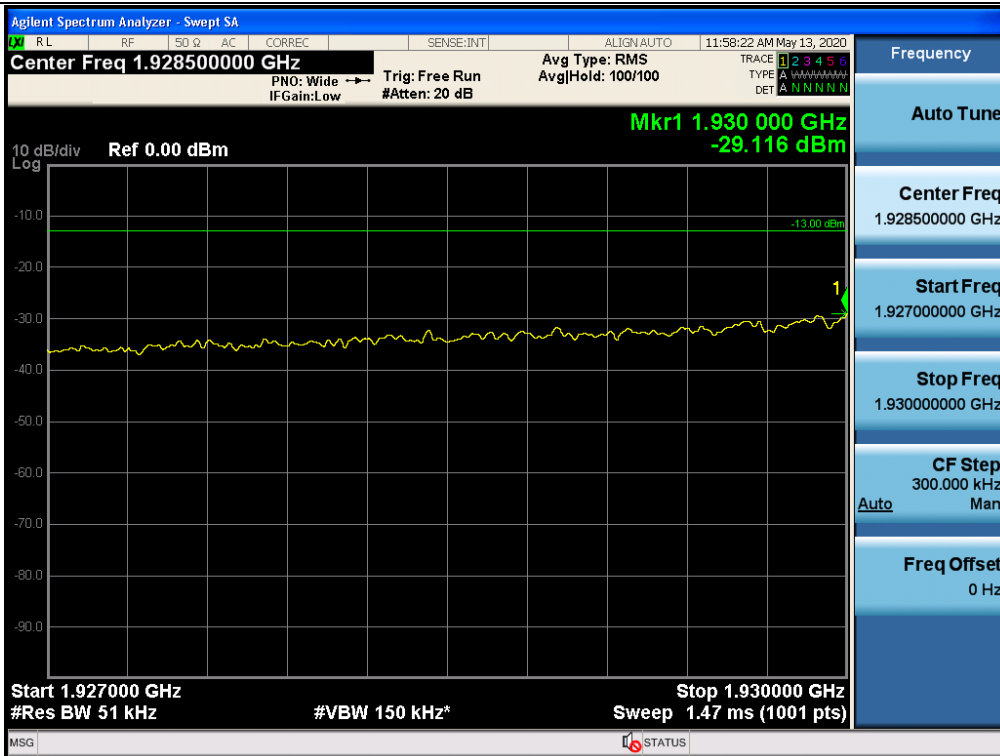

Out-of-band (single test signals) / PCS / Downlink / LTE 5 MHz / Upper

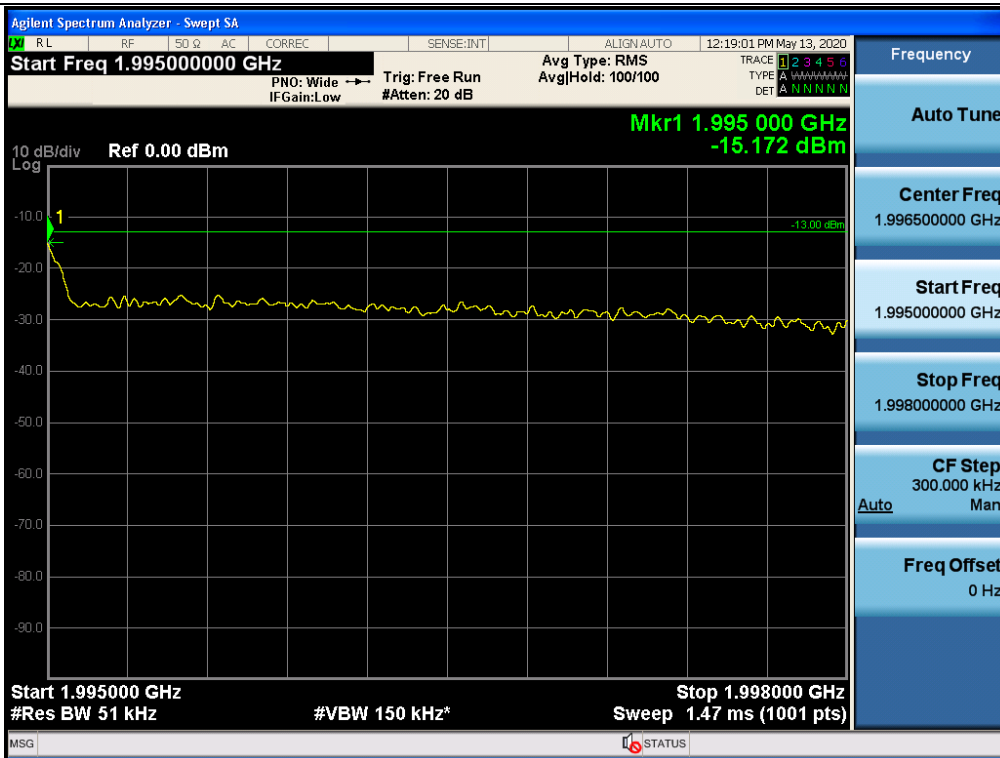

Out-of-band (single test signals) / PCS / Downlink / LTE 5 MHz / Lower

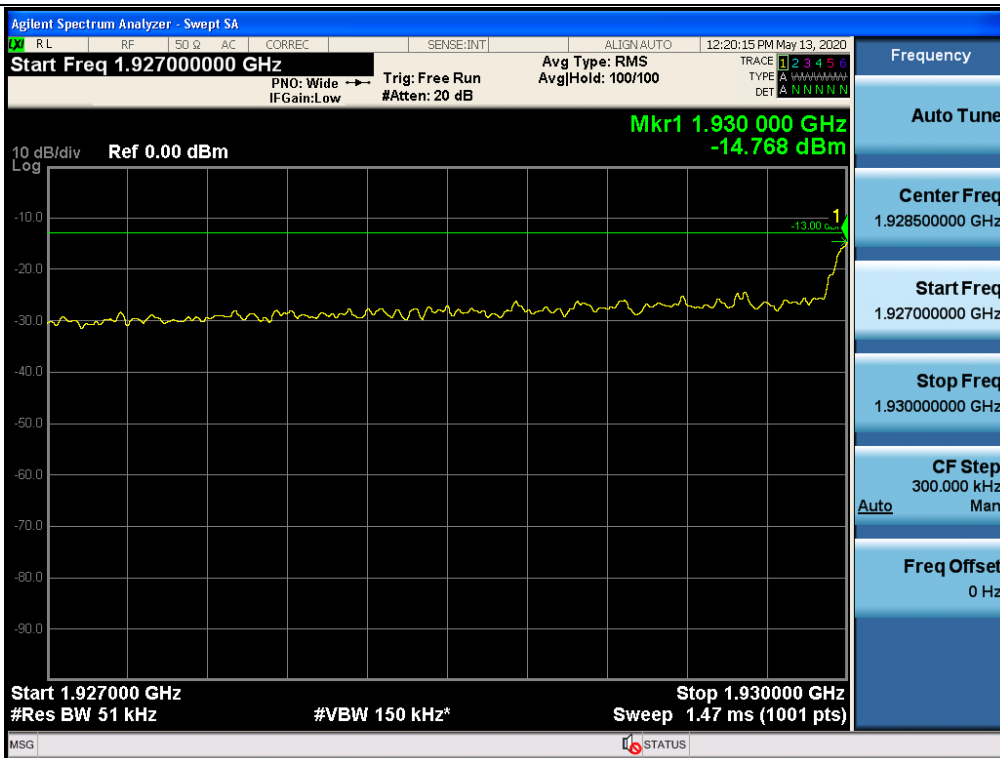

+3 dB above Out-of-band (single test signals) / PCS / Downlink / LTE 5 MHz / Upper

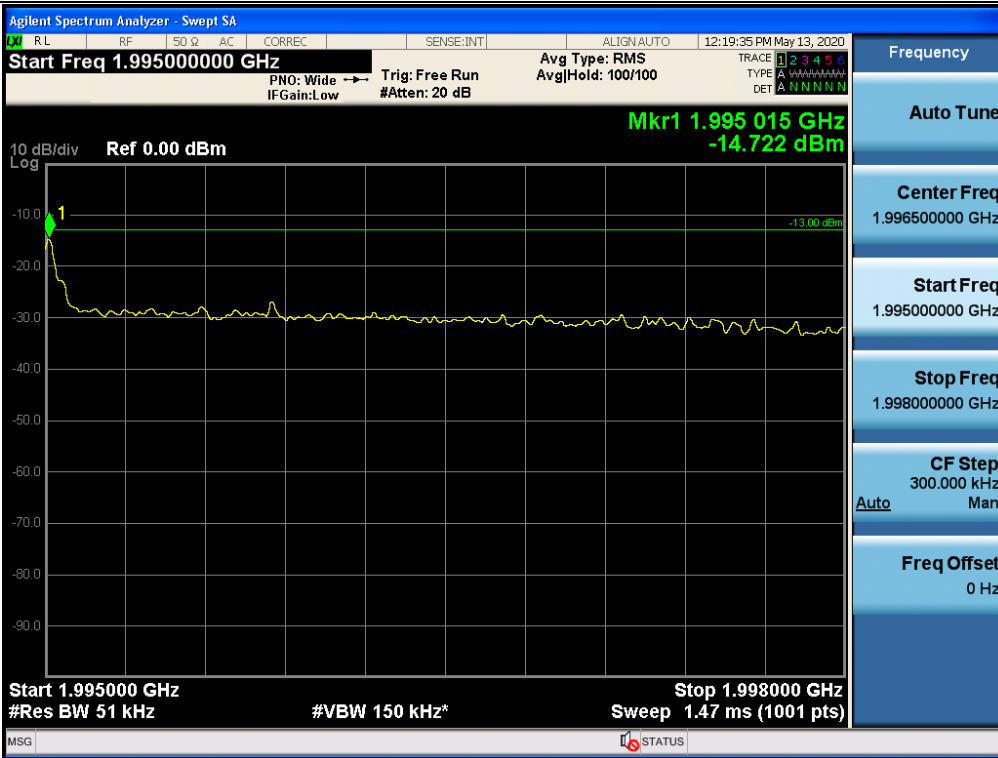

+3 dB above Out-of-band (single test signals) / PCS / Downlink / LTE 5 MHz / Lower

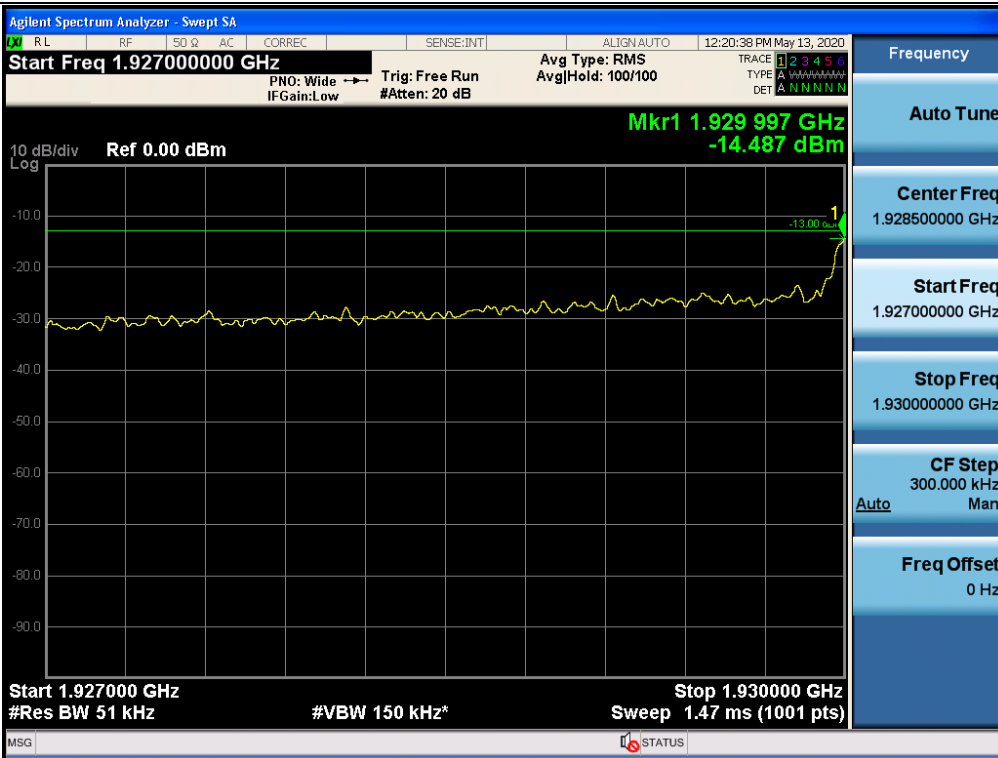

Out-of-band (single test signals) / PCS / Downlink / LTE 10 MHz / Upper

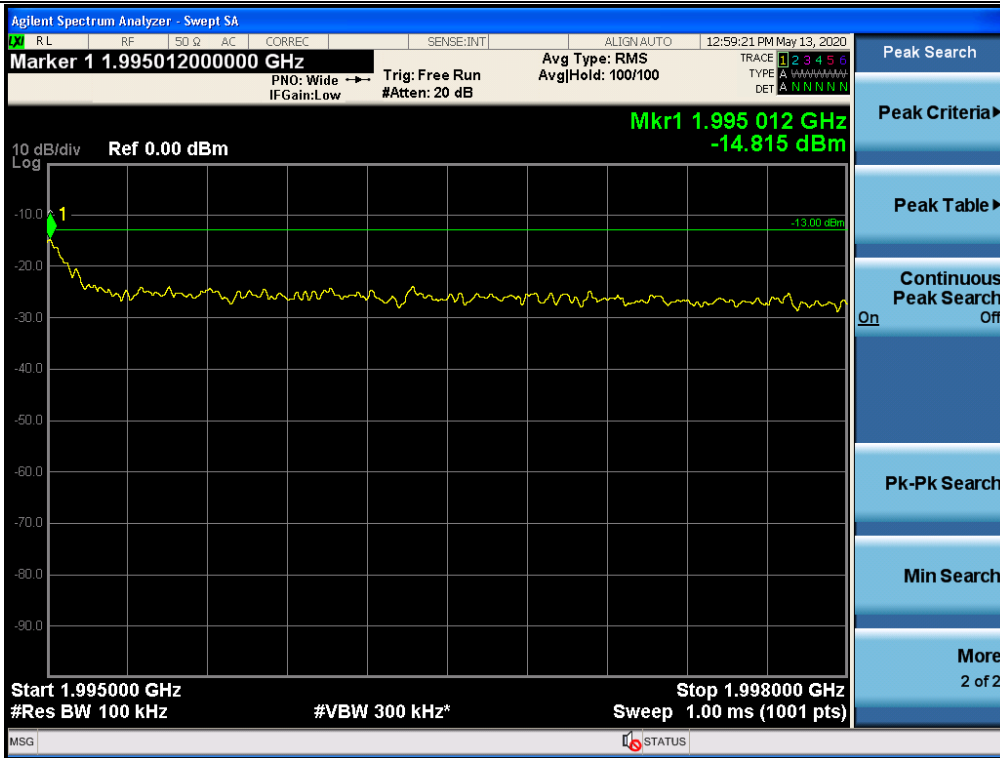

Out-of-band (single test signals) / PCS / Downlink / LTE 10 MHz / Lower

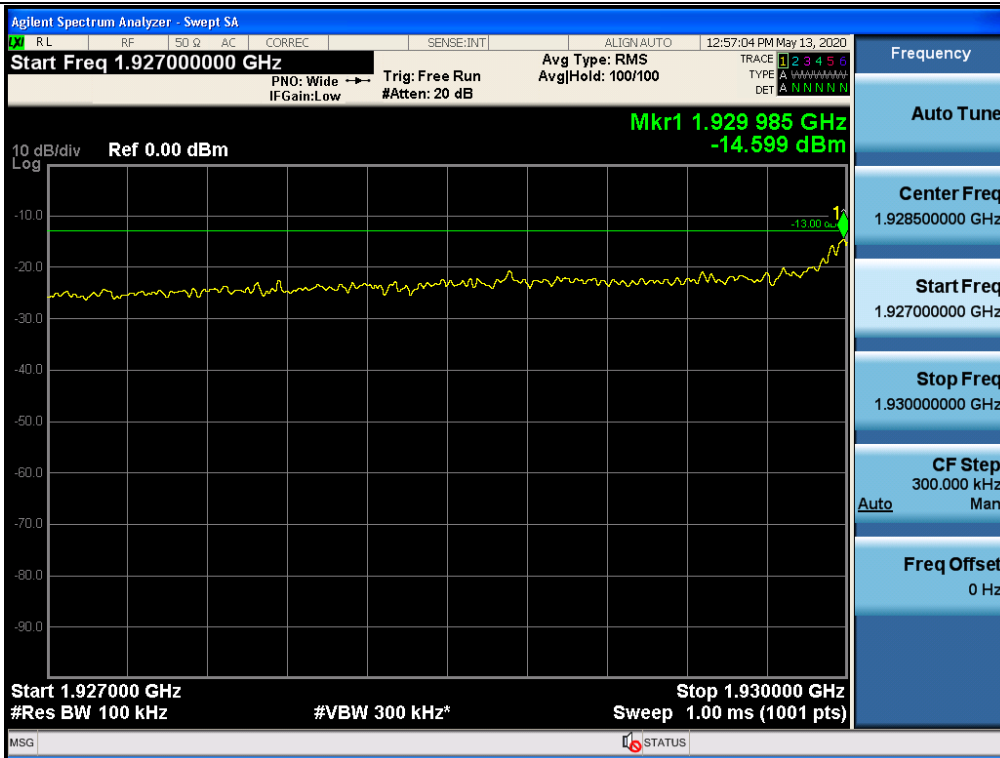

+3 dB above Out-of-band (single test signals) / PCS / Downlink / LTE 10 MHz / Upper

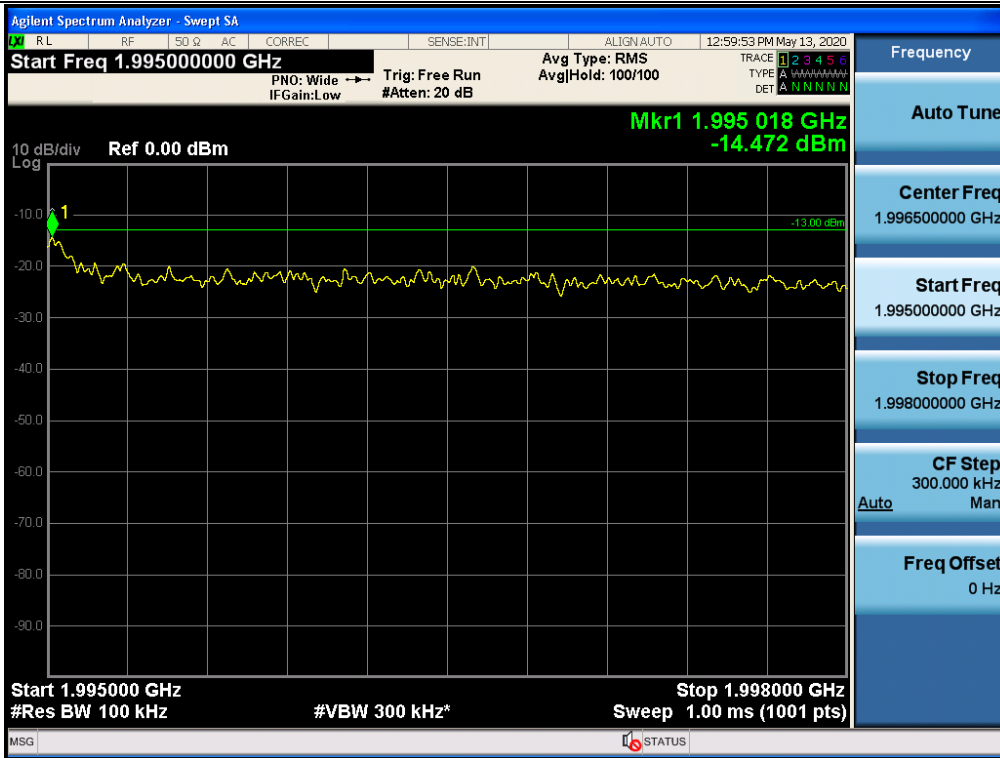

+3 dB above Out-of-band (single test signals) / PCS / Downlink / LTE 10 MHz / Lower

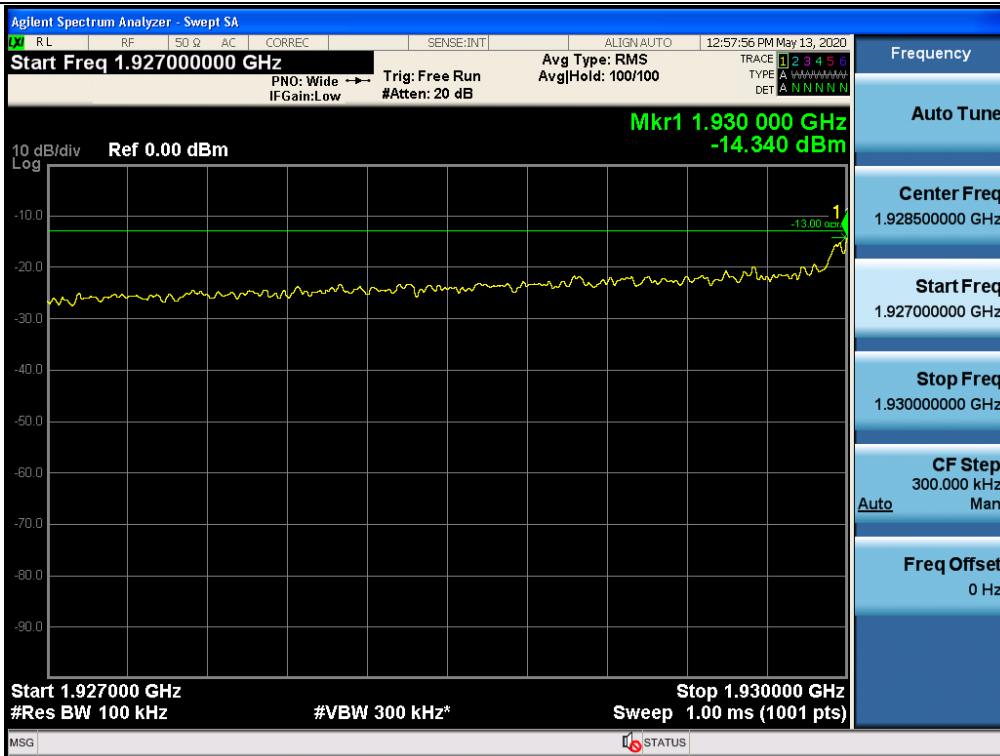

Plot data of Spurious Emissions

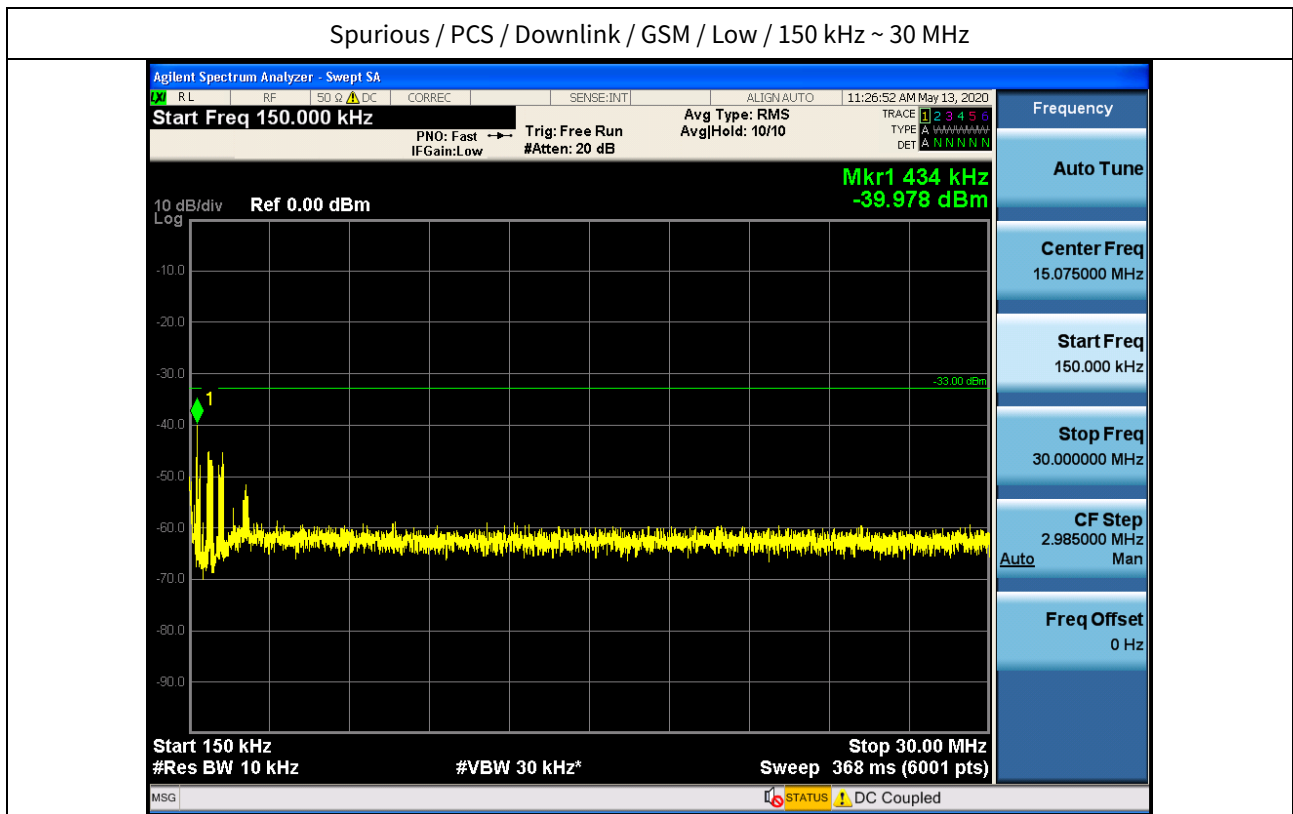
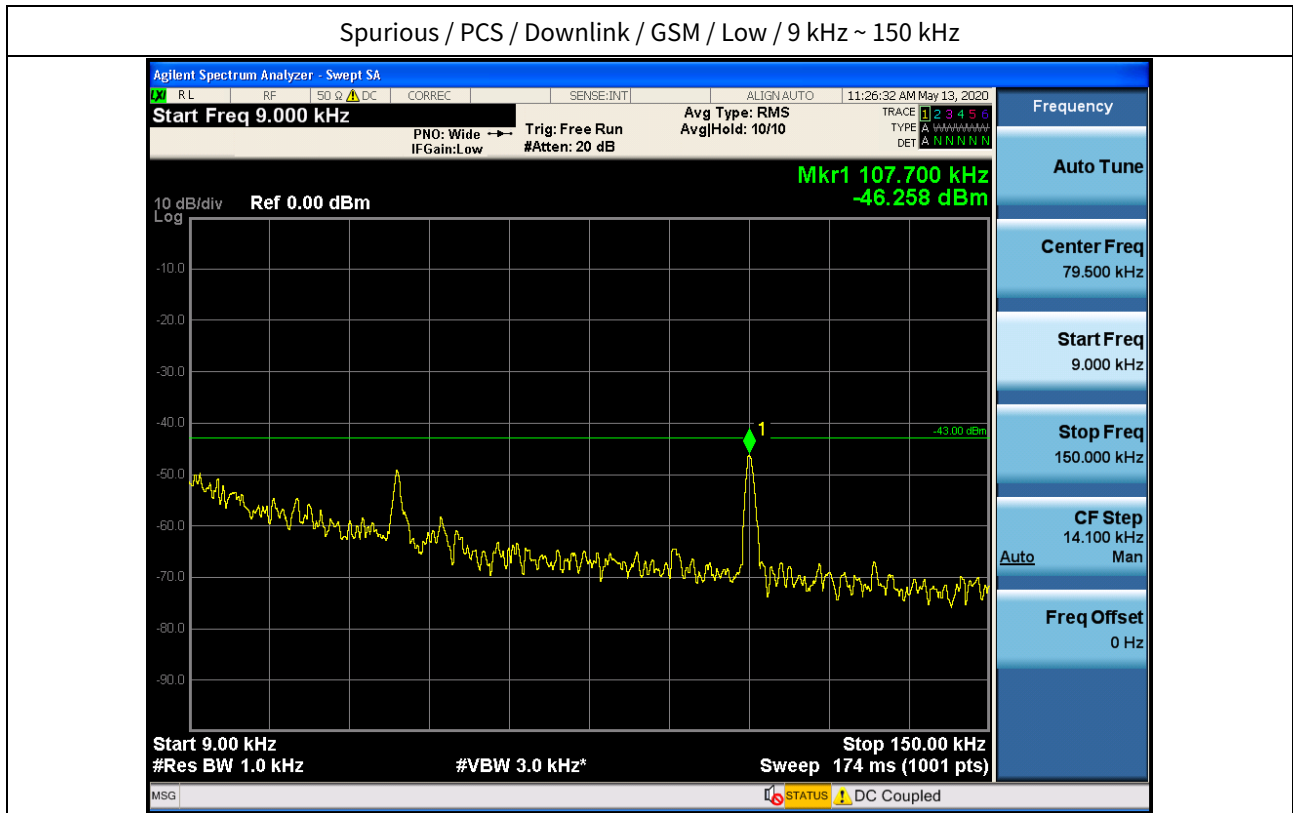

Spurious / PCS / Downlink / GSM / Low / 30 MHz ~ Low Edge-10

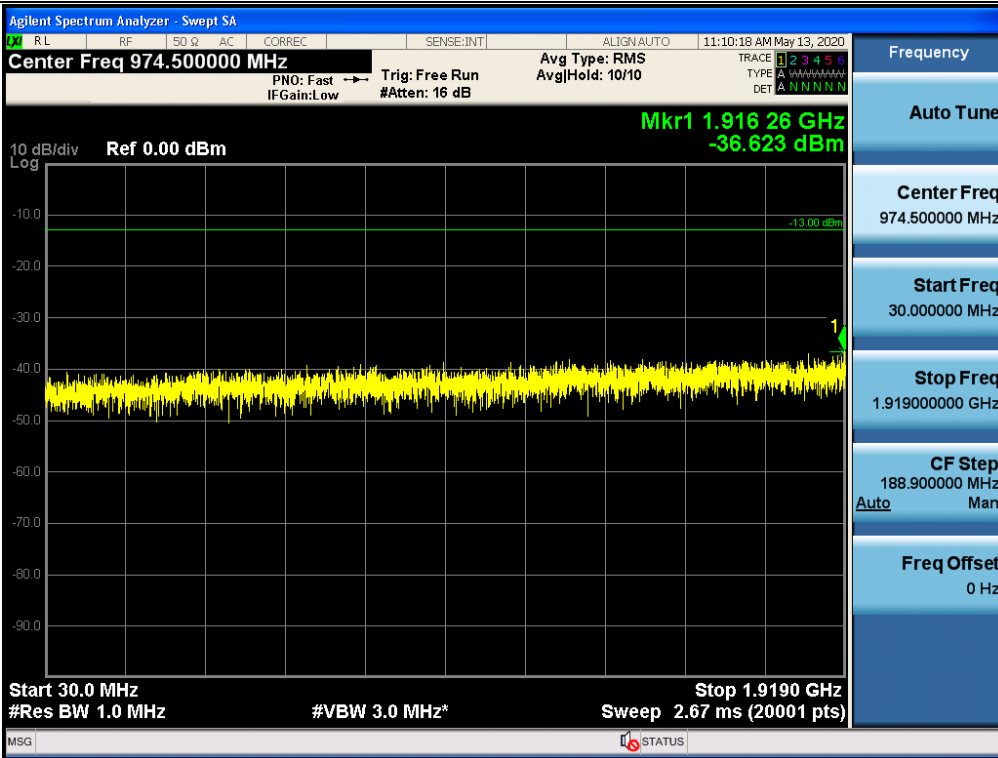

Spurious / PCS / Downlink / GSM / Low / Low Edge-10 ~ Low Edge

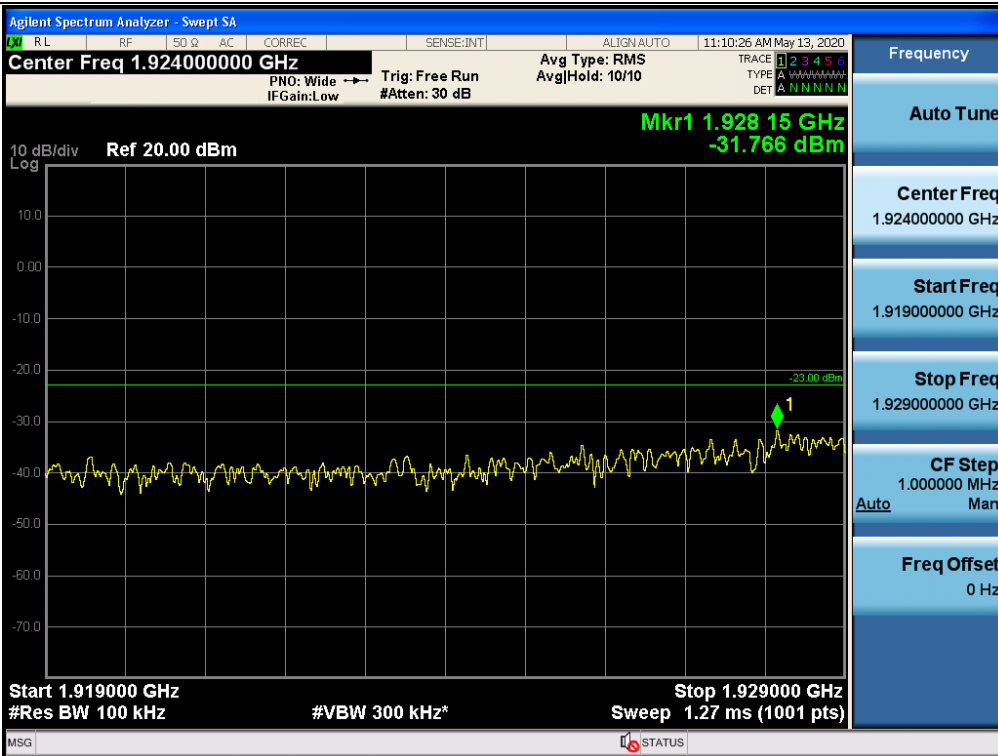

Spurious / PCS / Downlink / GSM / Low / High Edge ~ High Edge+10

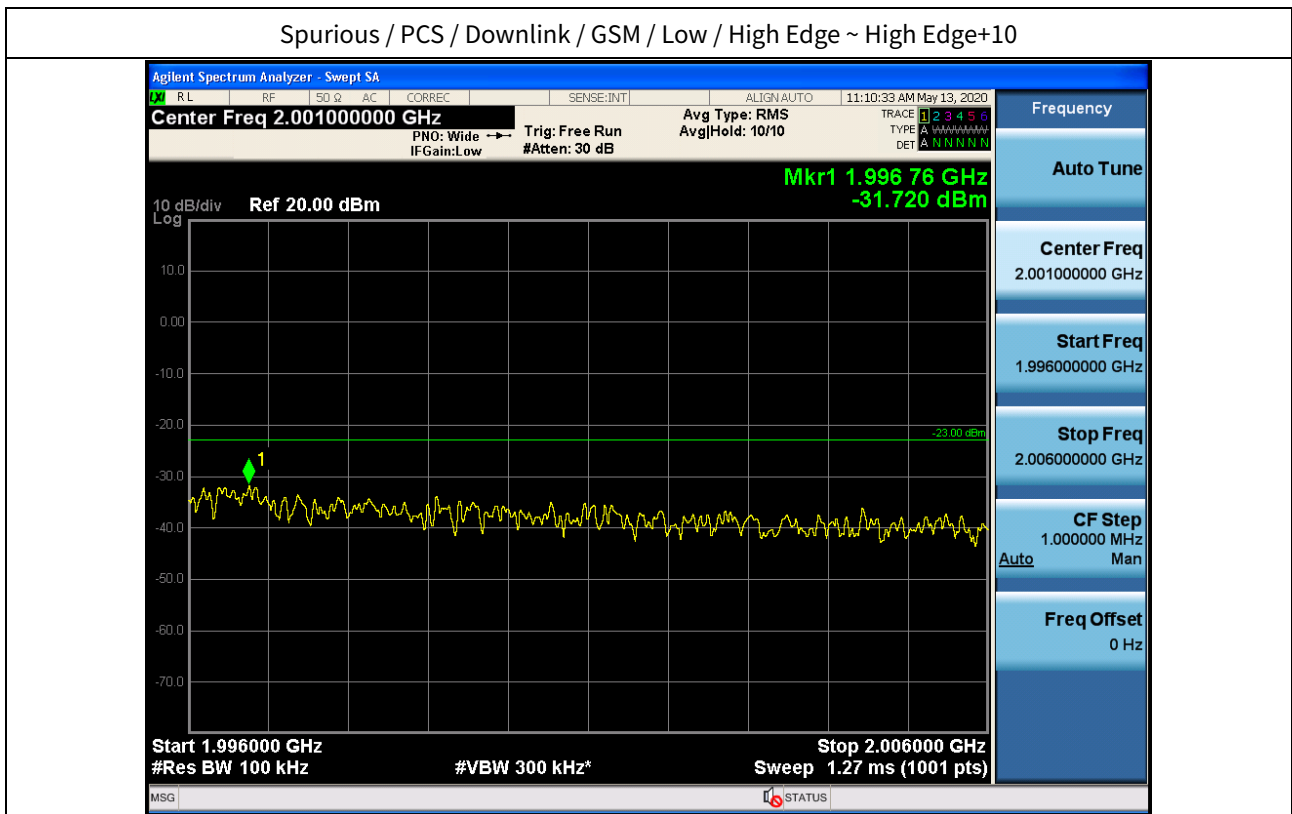

Spurious / PCS / Downlink / GSM / Low / High Edge+10 ~ 10 GHz

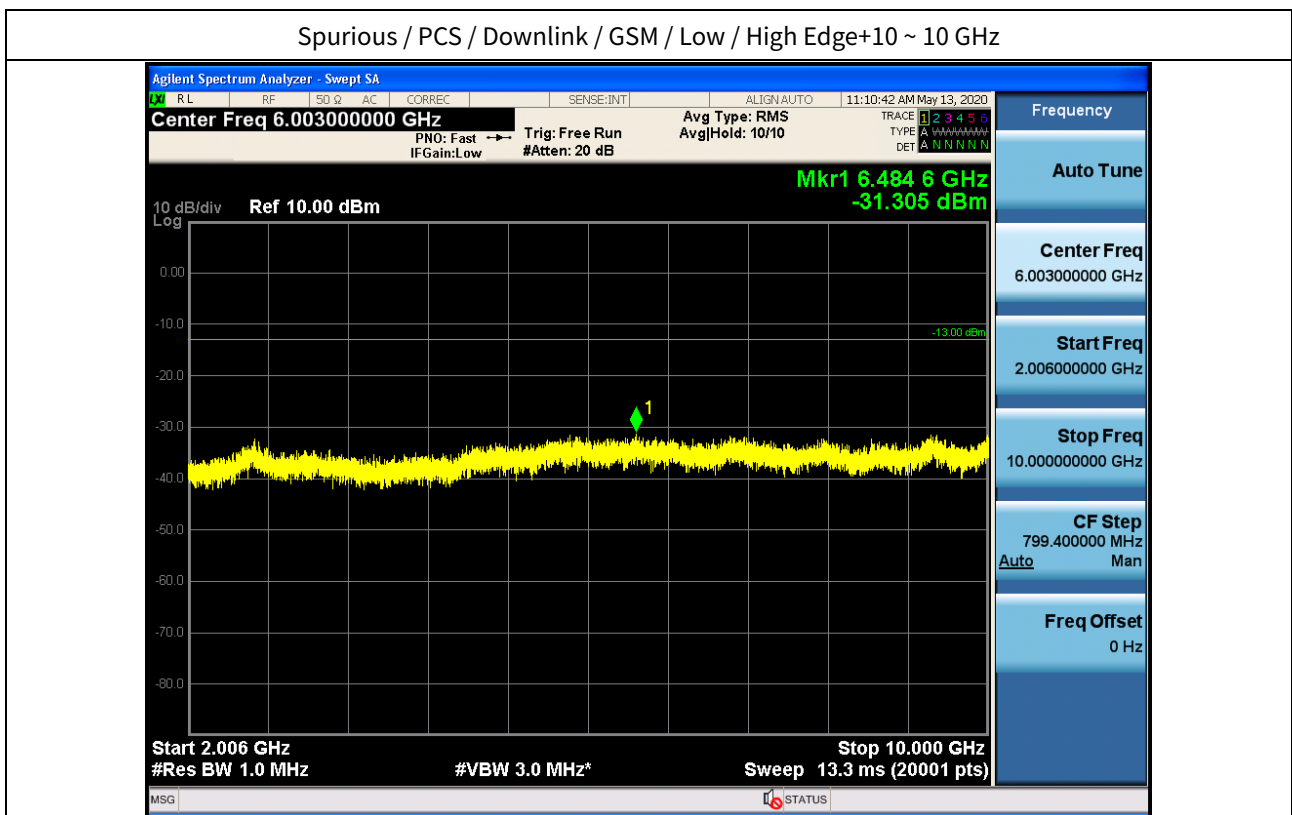

Spurious / PCS / Downlink / GSM / Low / 10 GHz ~ 26.5 GHz

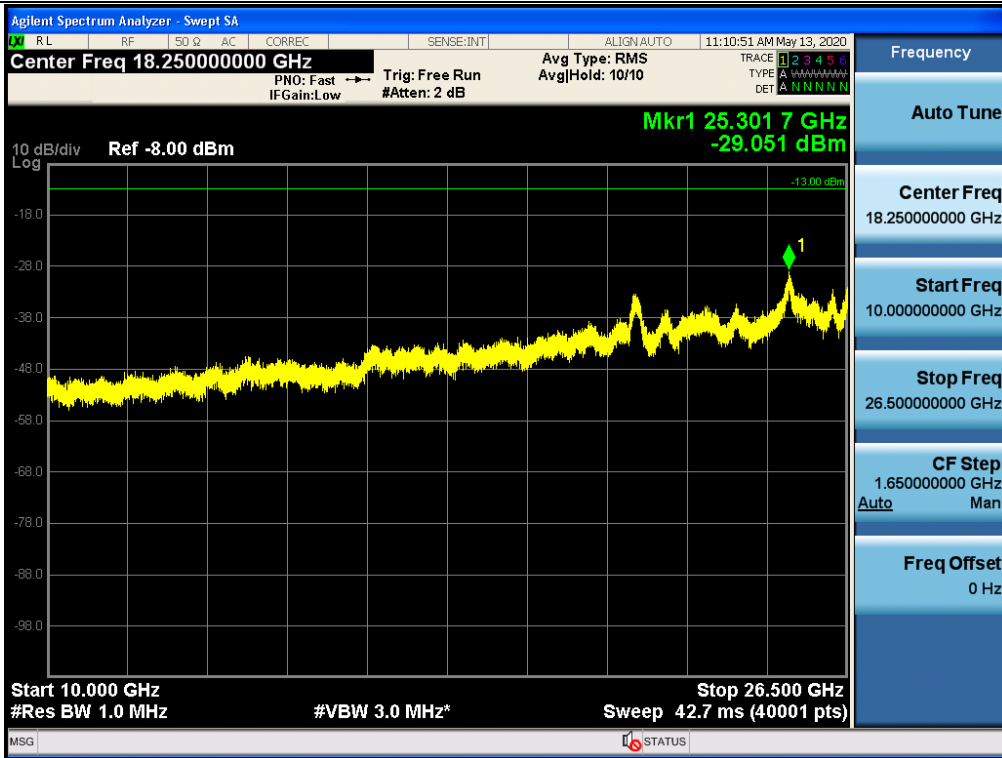

Spurious / PCS / Downlink / GSM / Middle / 9 kHz ~ 150 kHz

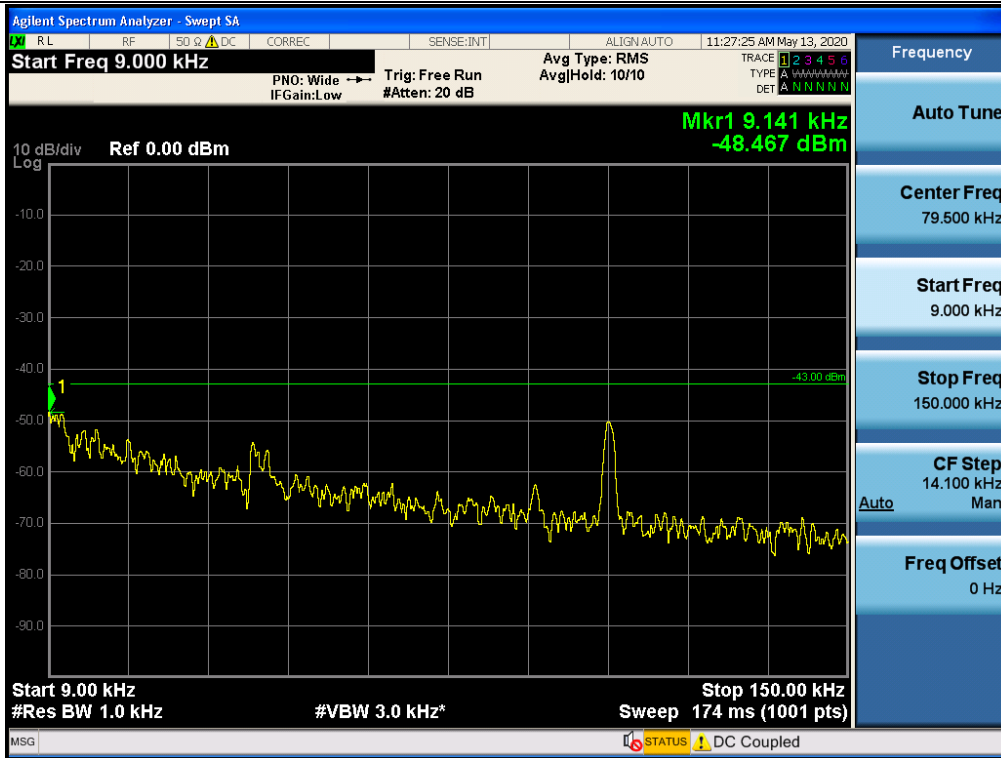

Spurious / PCS / Downlink / GSM / Middle / 150 kHz ~ 30 MHz

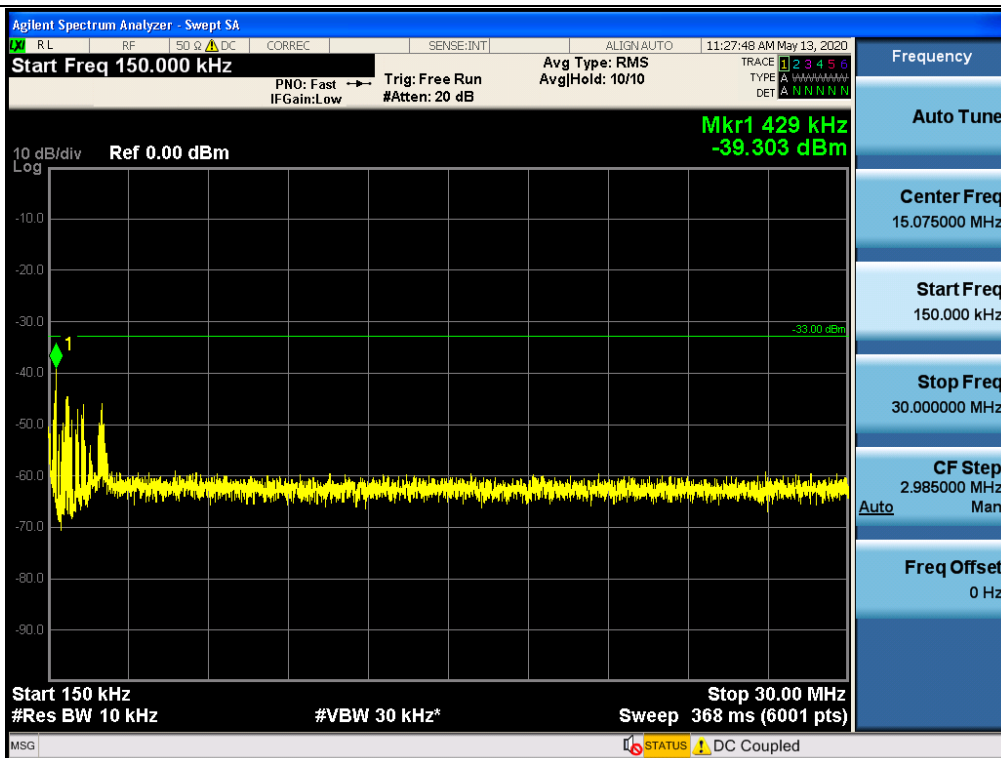

Spurious / PCS / Downlink / GSM / Middle / 30 MHz ~ Low Edge-10

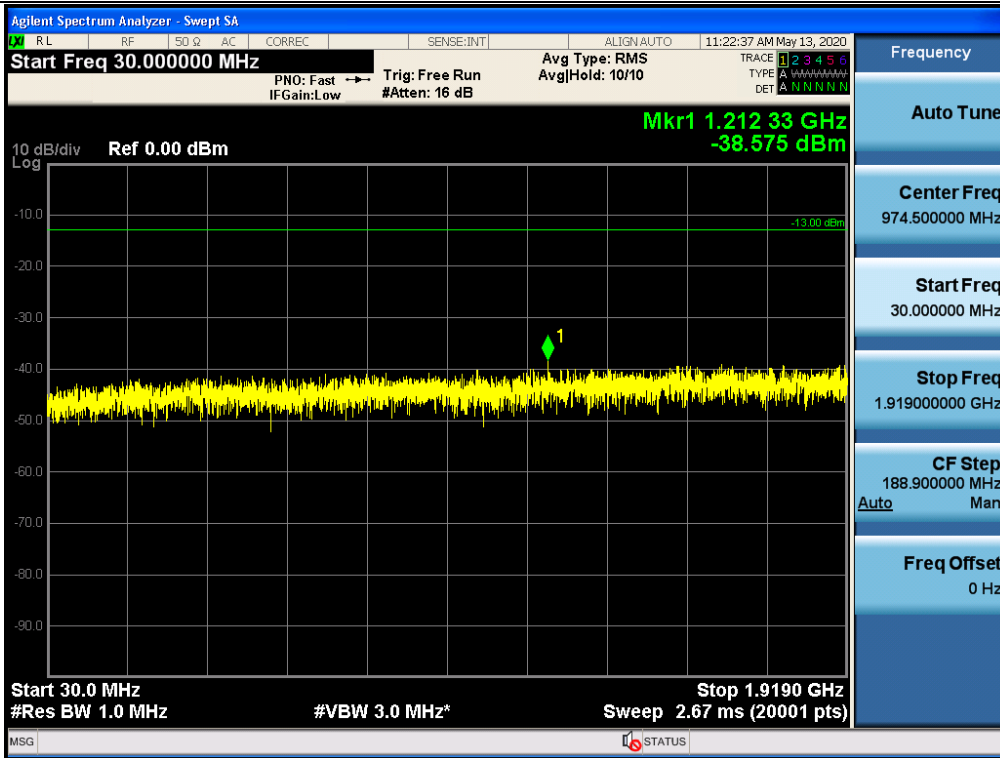

Spurious / PCS / Downlink / GSM / Middle / Low Edge-10 ~ Low Edge

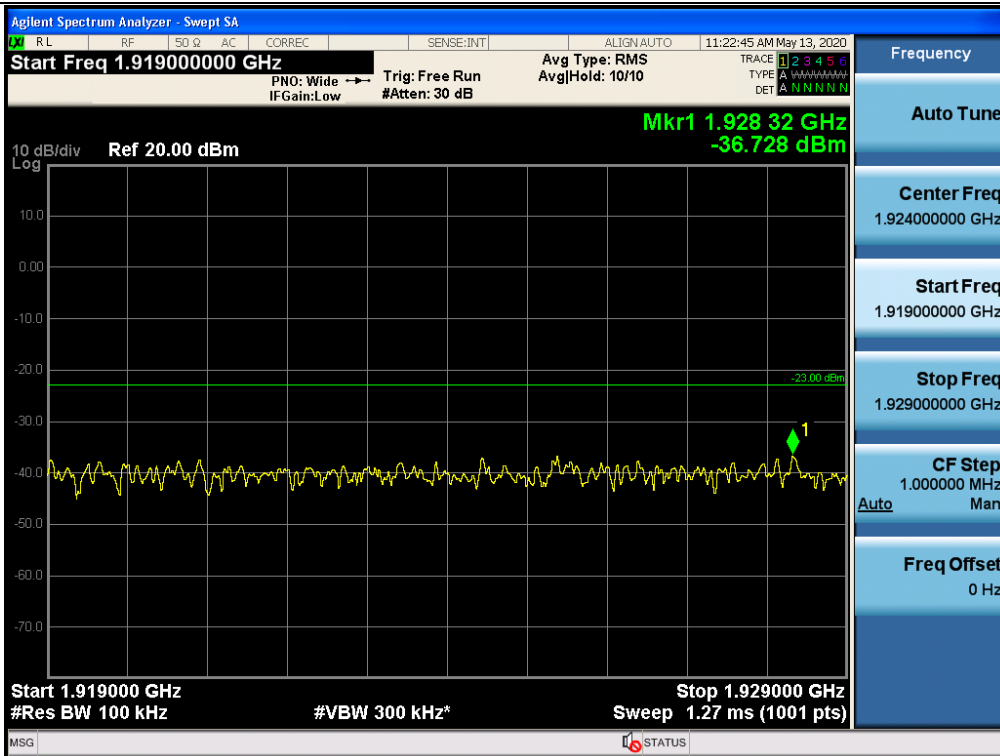

Spurious / PCS / Downlink / GSM / Middle / High Edge ~ High Edge+10

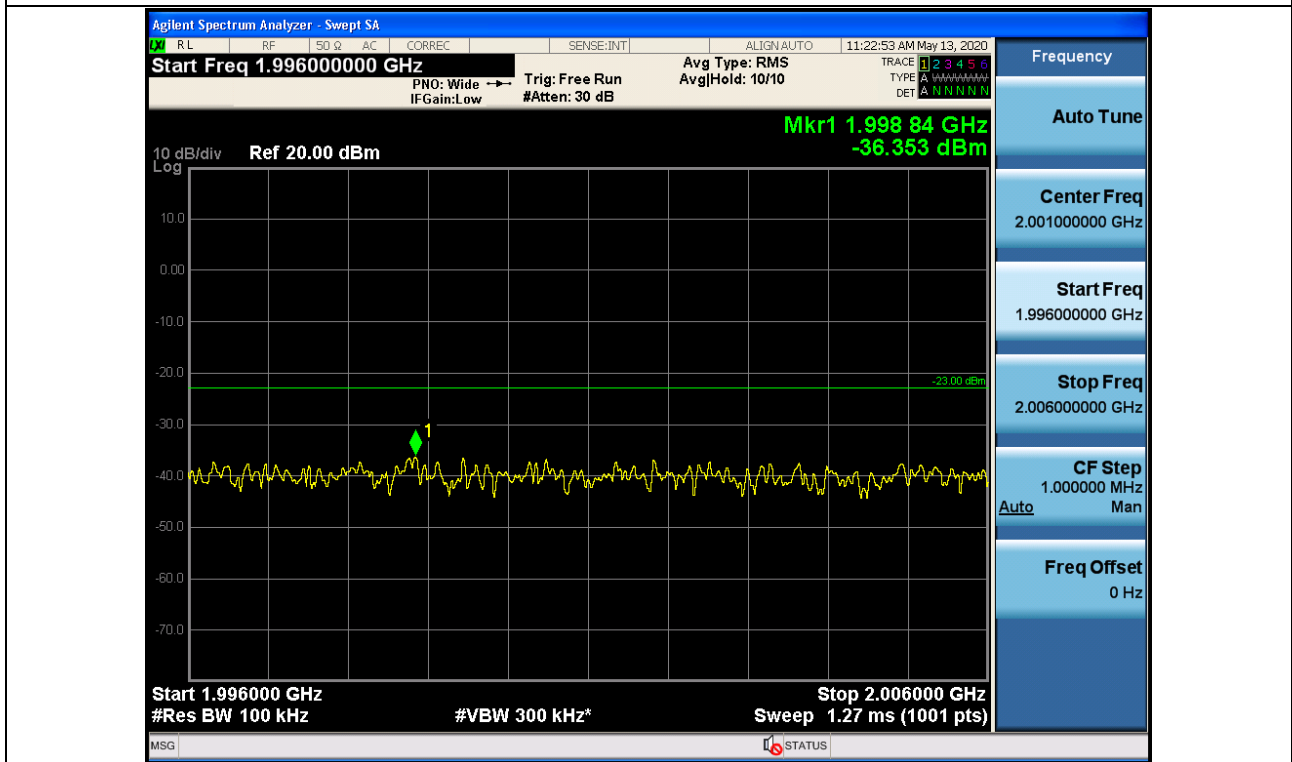

Spurious / PCS / Downlink / GSM / Middle / High Edge+10 ~ 10 GHz

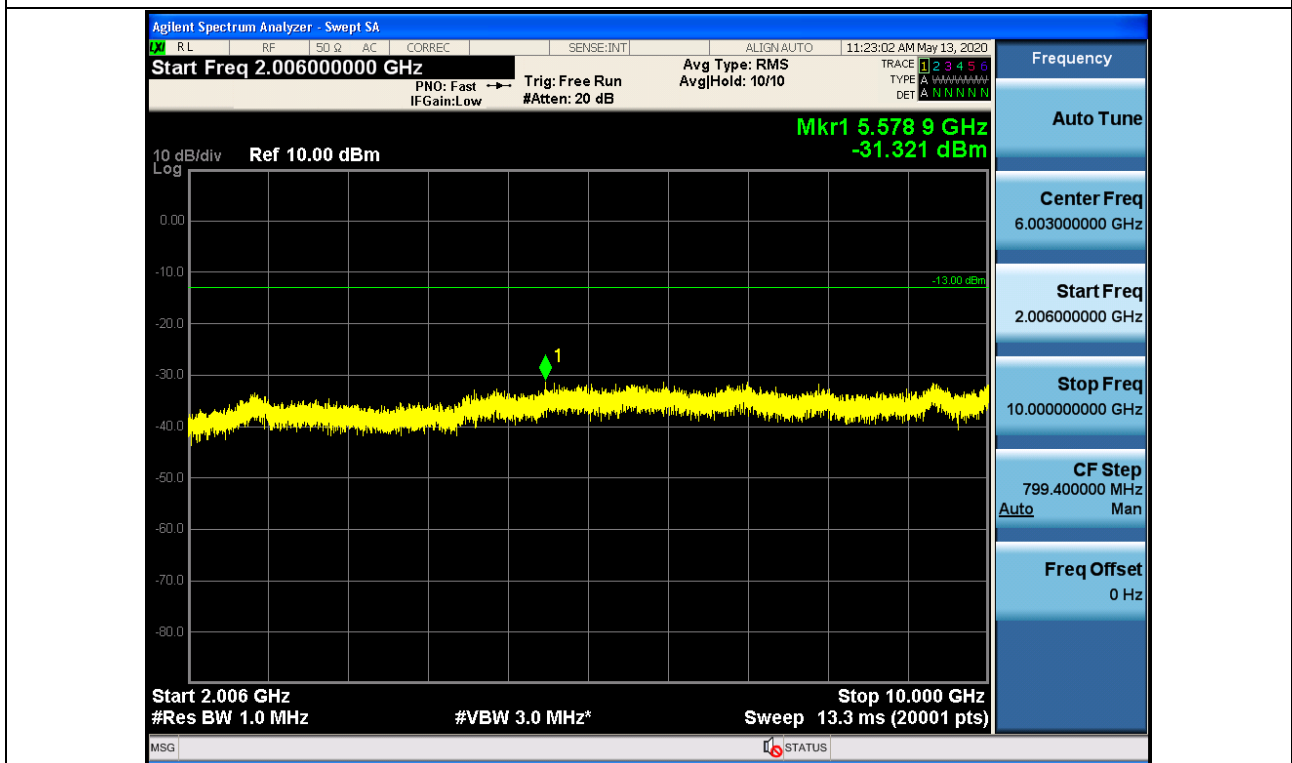

Spurious / PCS / Downlink / GSM / Middle / 10 GHz ~ 26.5 GHz

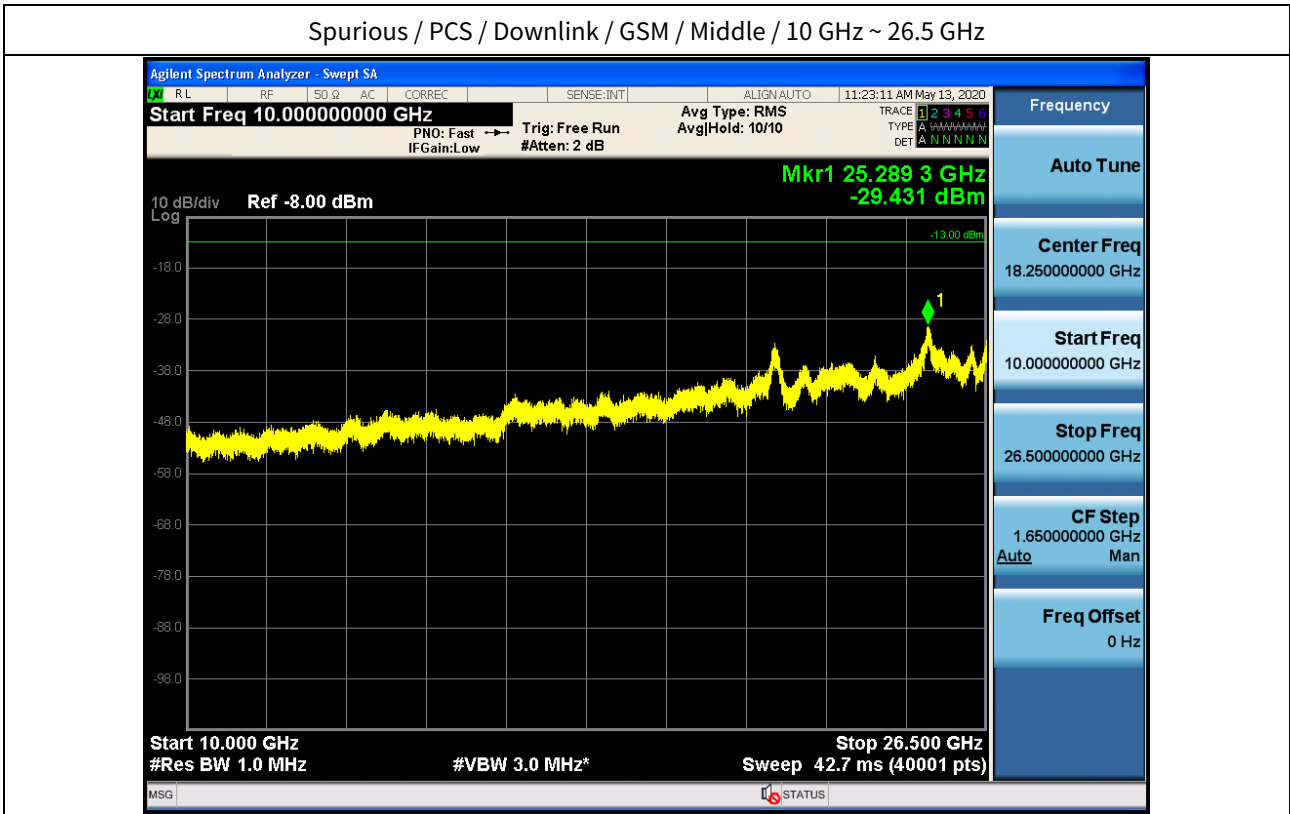

Spurious / PCS / Downlink / GSM / High / 9 kHz ~ 150 kHz

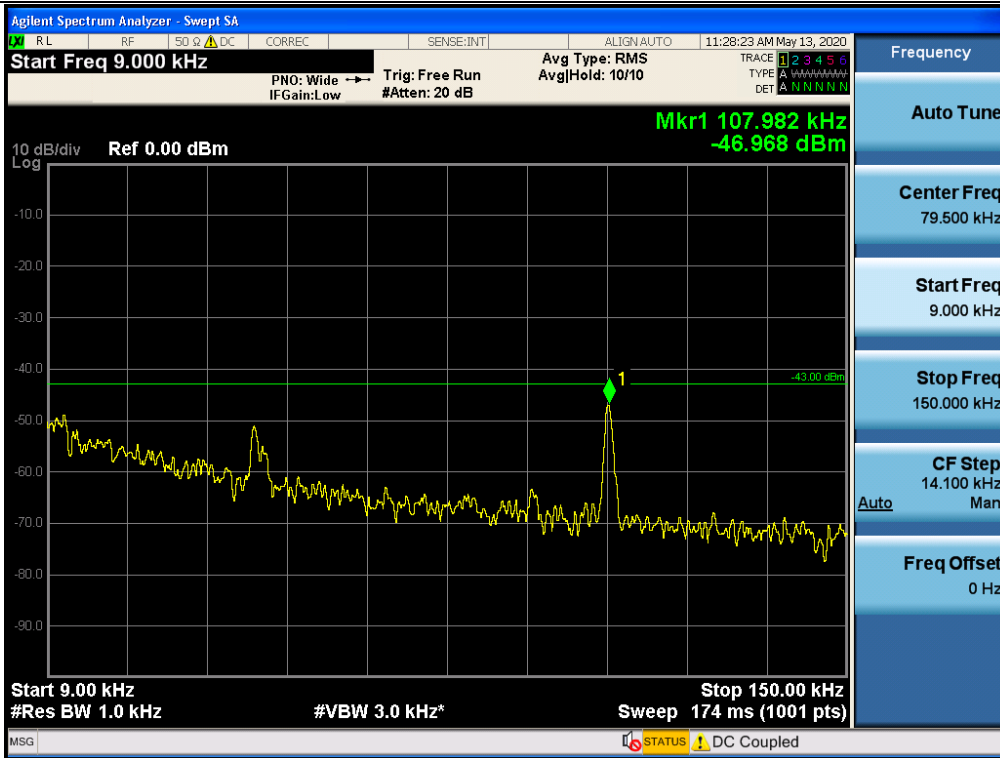

Spurious / PCS / Downlink / GSM / High / 150 kHz ~ 30 MHz

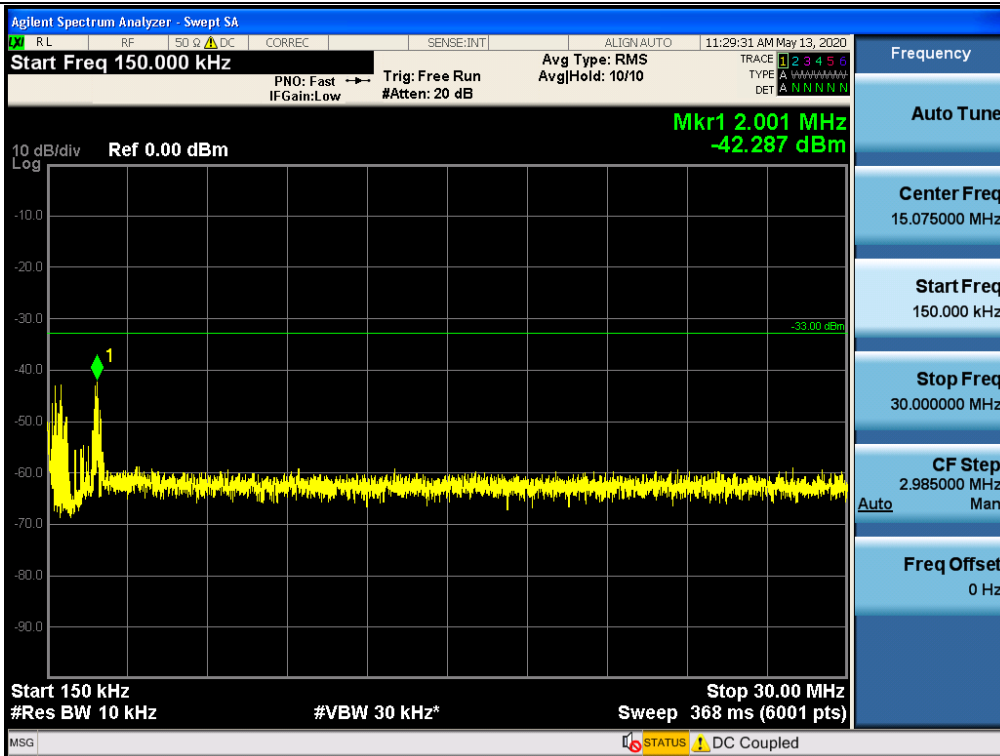

Spurious / PCS / Downlink / GSM / High / 30 MHz ~ Low Edge-10

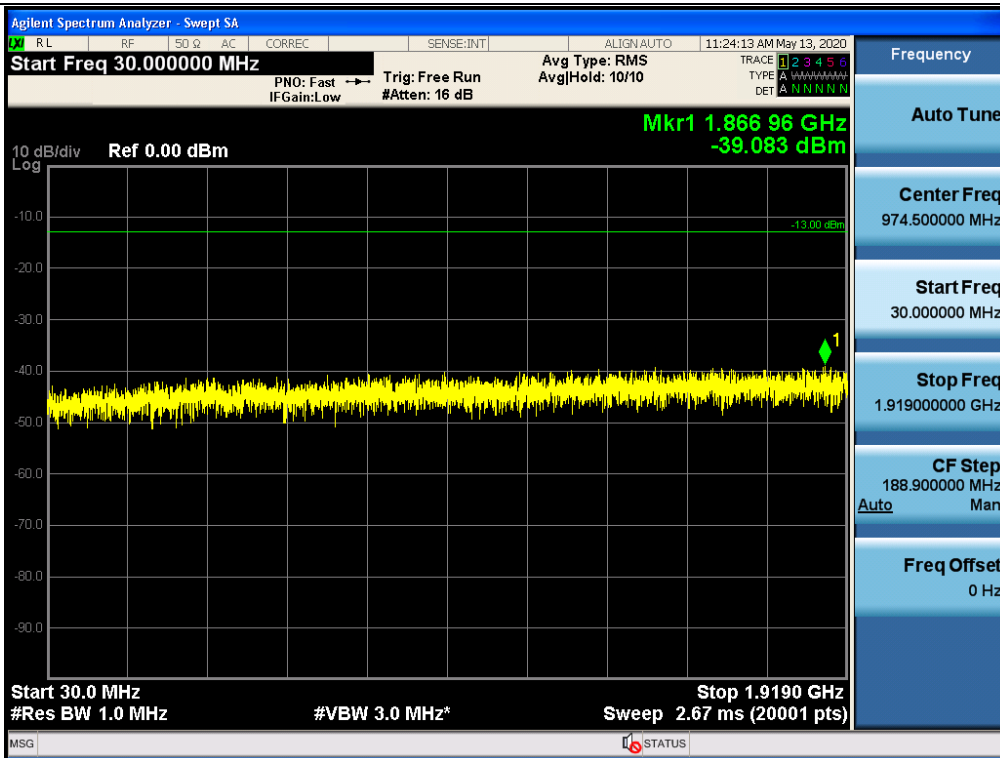

Spurious / PCS / Downlink / GSM / High / Low Edge-10 ~ Low Edge

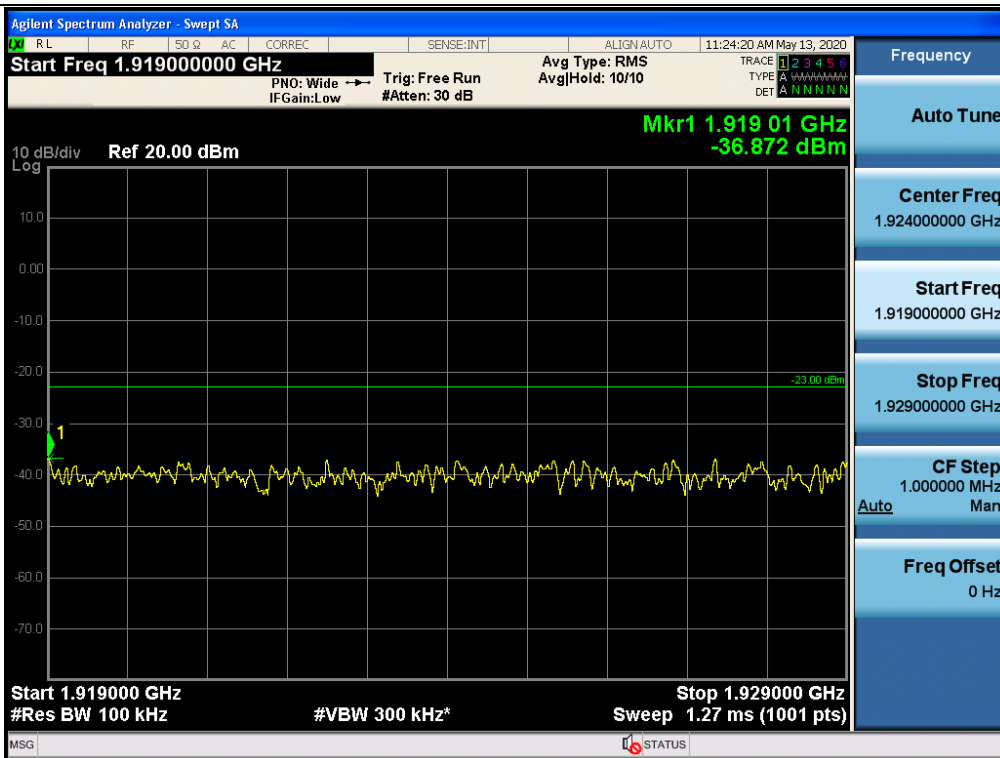

Spurious / PCS / Downlink / GSM / High / High Edge ~ High Edge+10

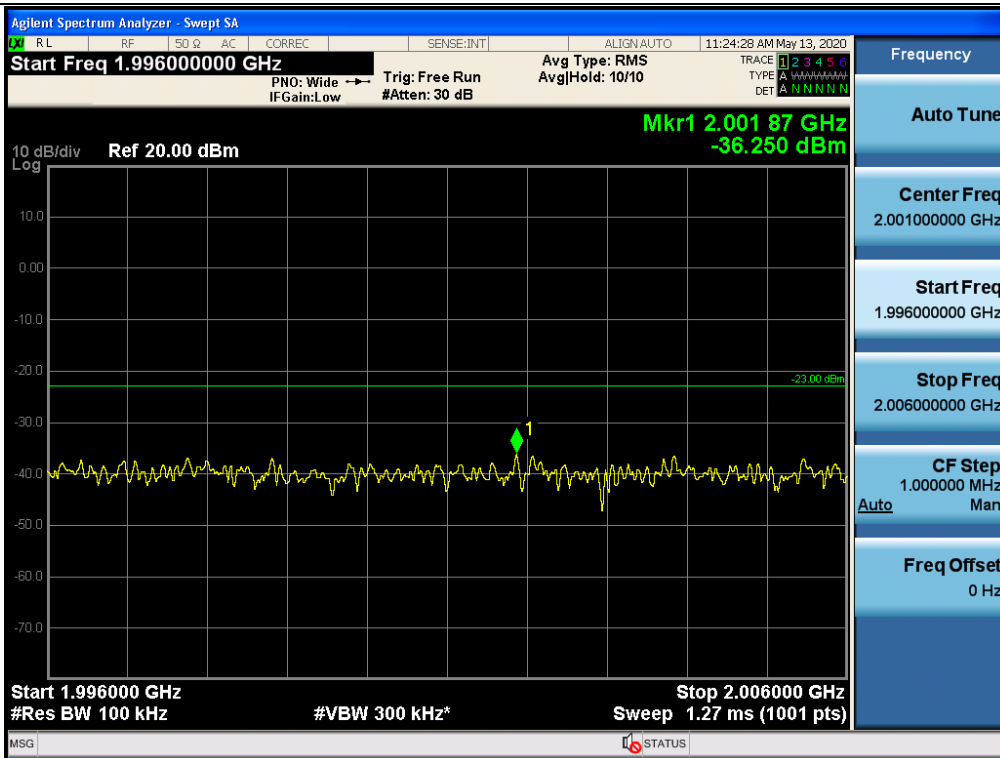

Spurious / PCS / Downlink / GSM / High / High Edge+10 ~ 10 GHz

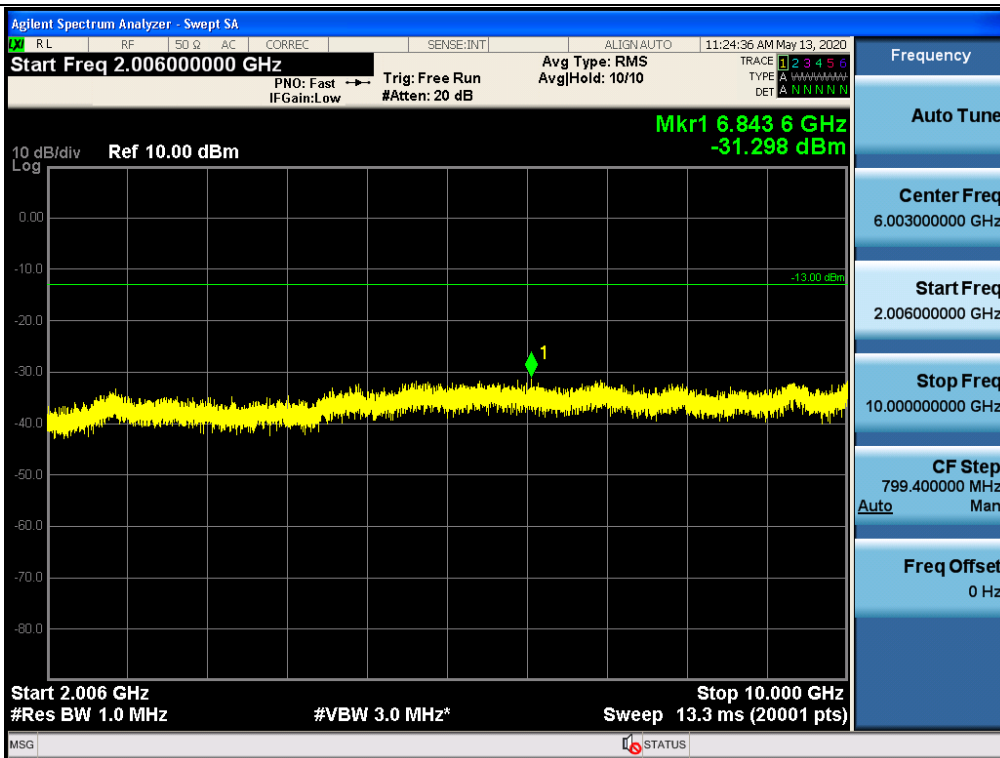

Spurious / PCS / Downlink / GSM / High / 10 GHz ~ 26.5 GHz

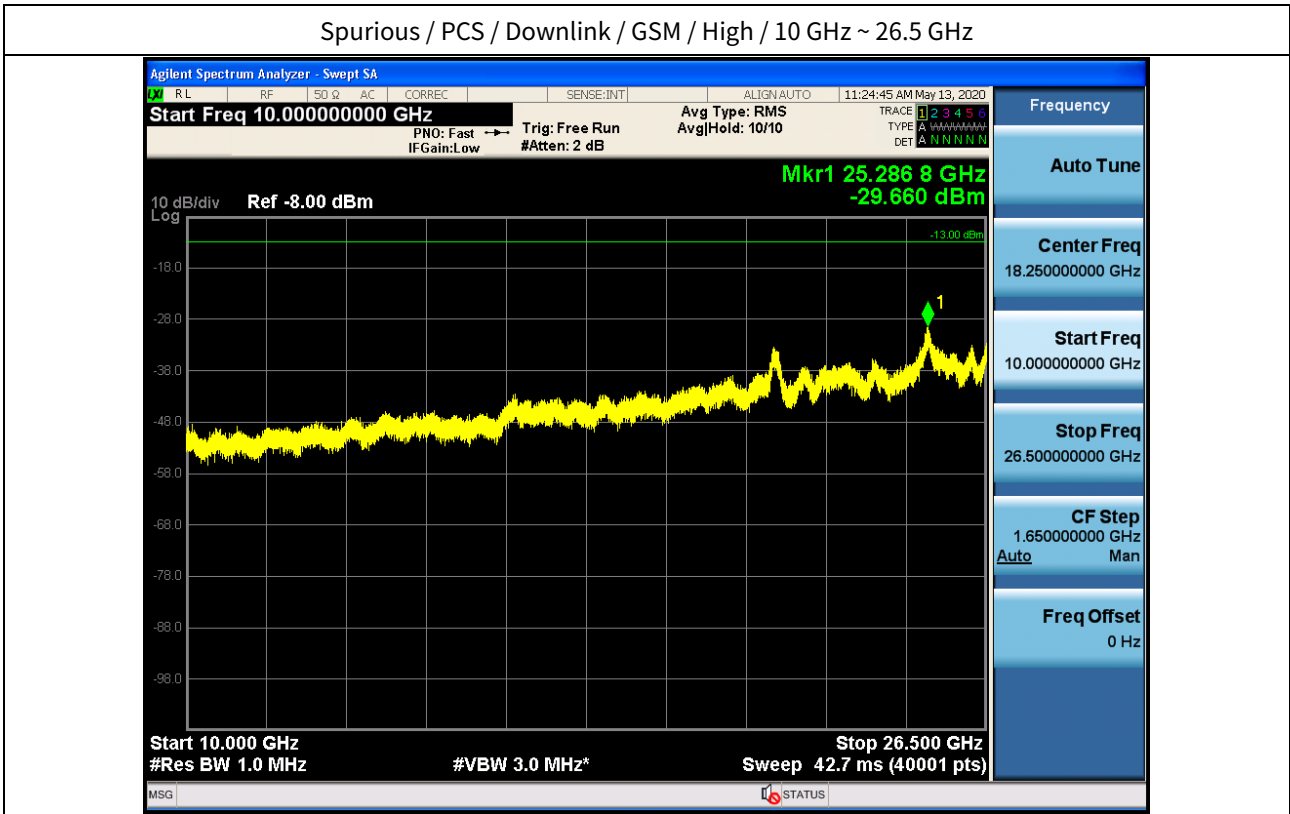

Spurious / PCS / Downlink / CDMA / Low / 9 kHz ~ 150 kHz

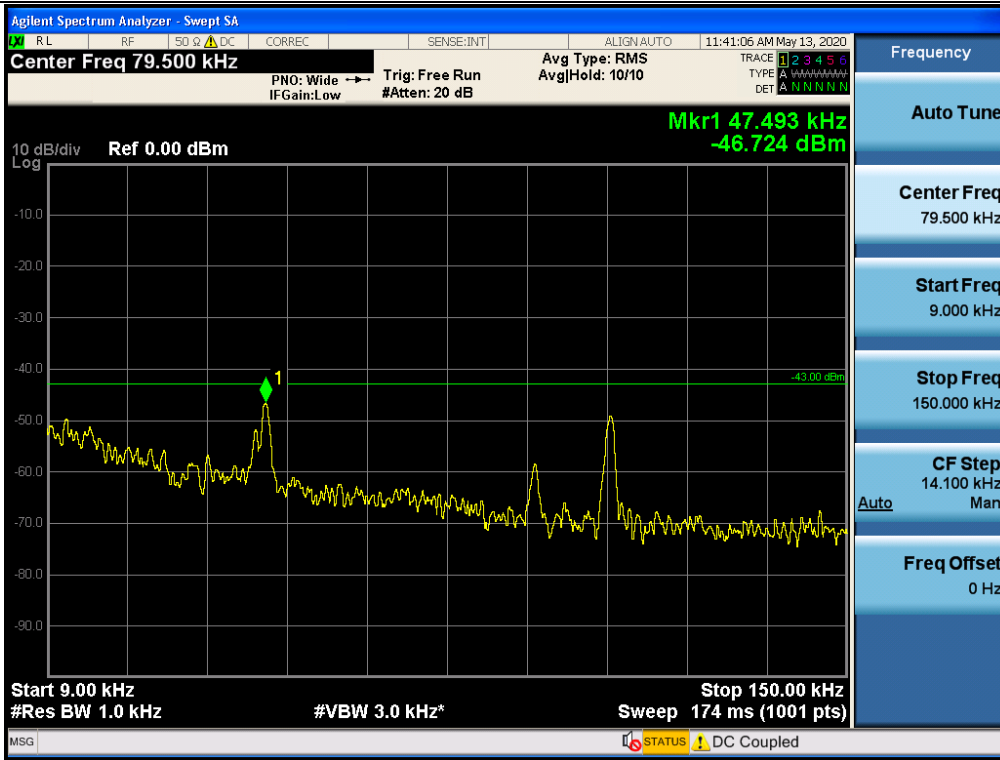

Spurious / PCS / Downlink / CDMA / Low / 150 kHz ~ 30 MHz

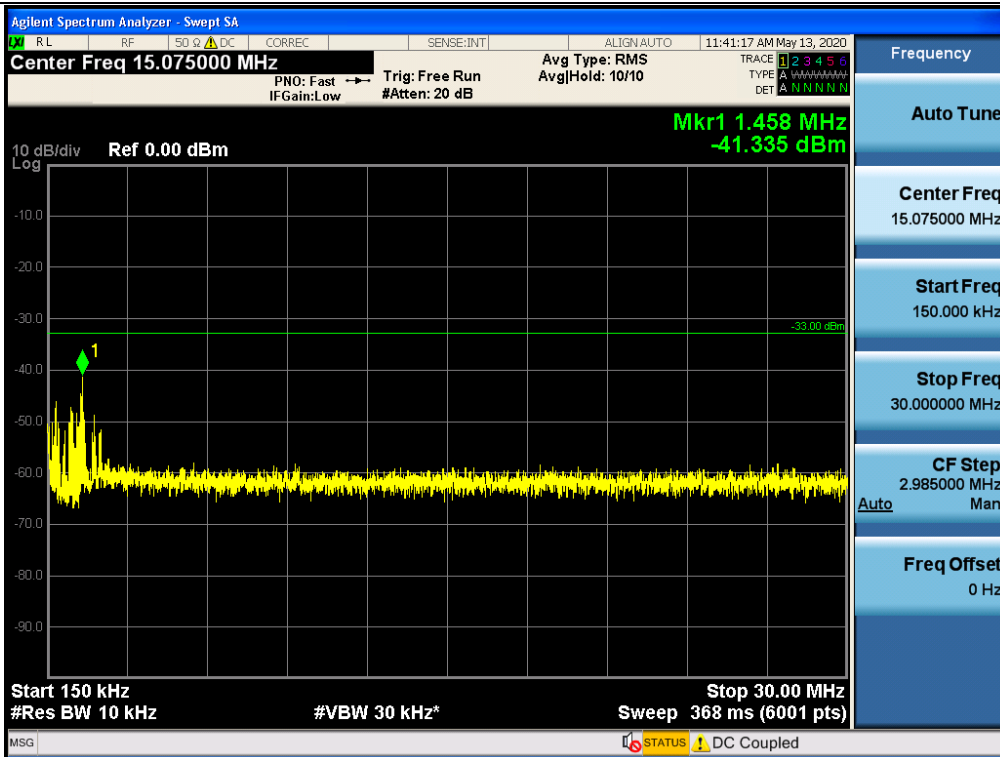

Spurious / PCS / Downlink / CDMA / Low / 30 MHz ~ Low Edge-10

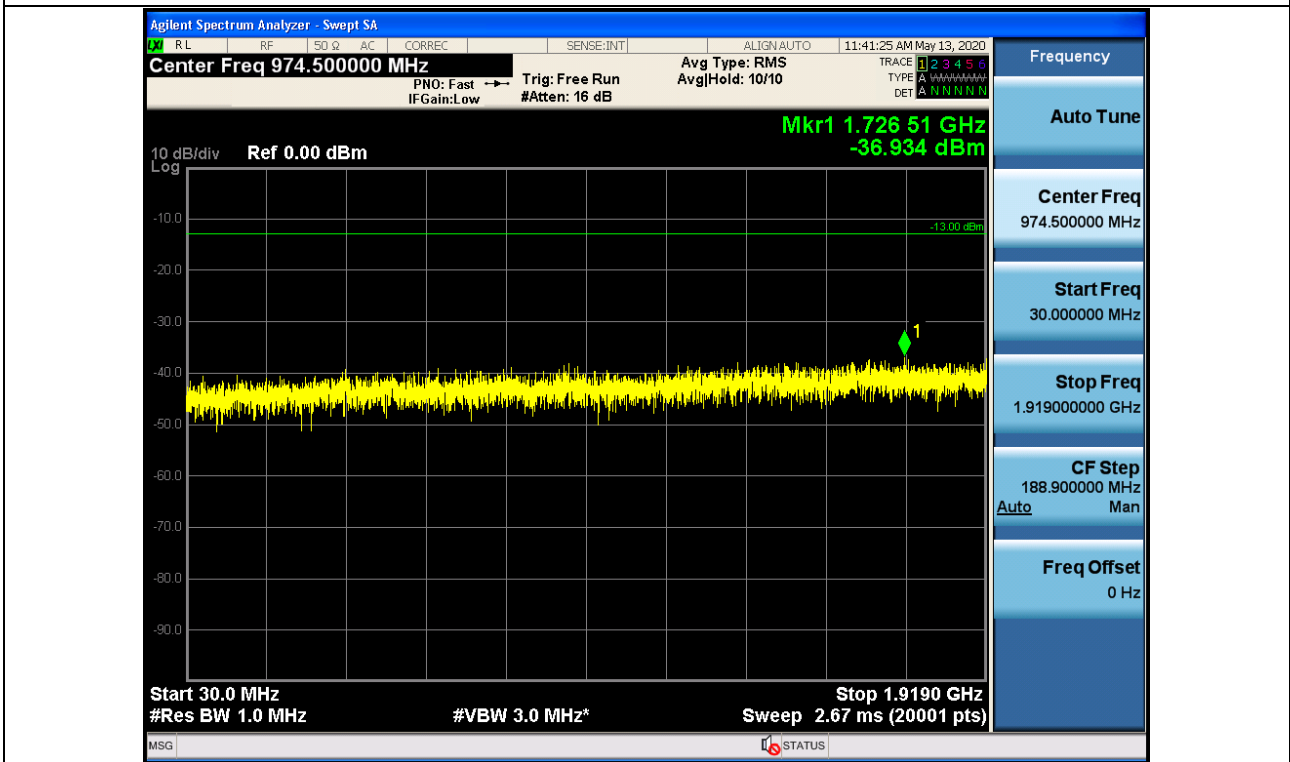

Spurious / PCS / Downlink / CDMA / Low / Low Edge-10 ~ Low Edge

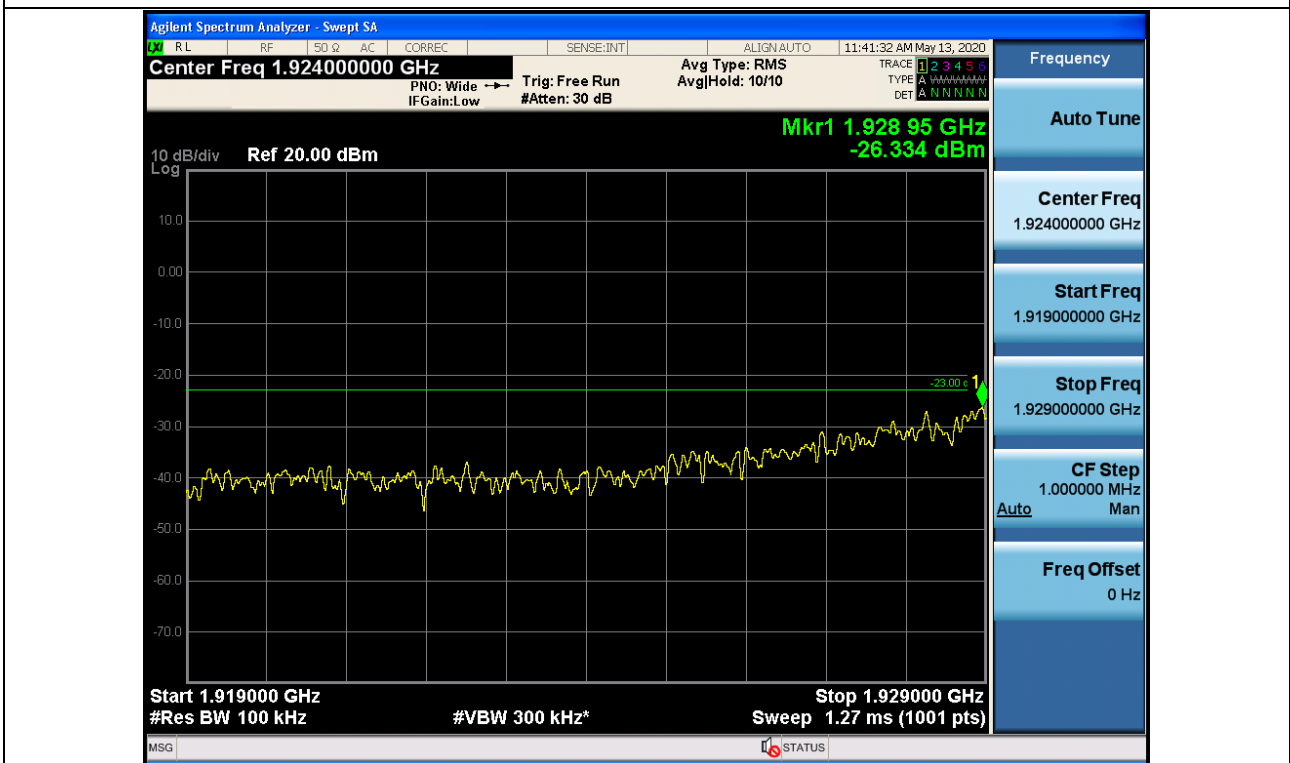

Spurious / PCS / Downlink / CDMA / Low / High Edge ~ High Edge+10

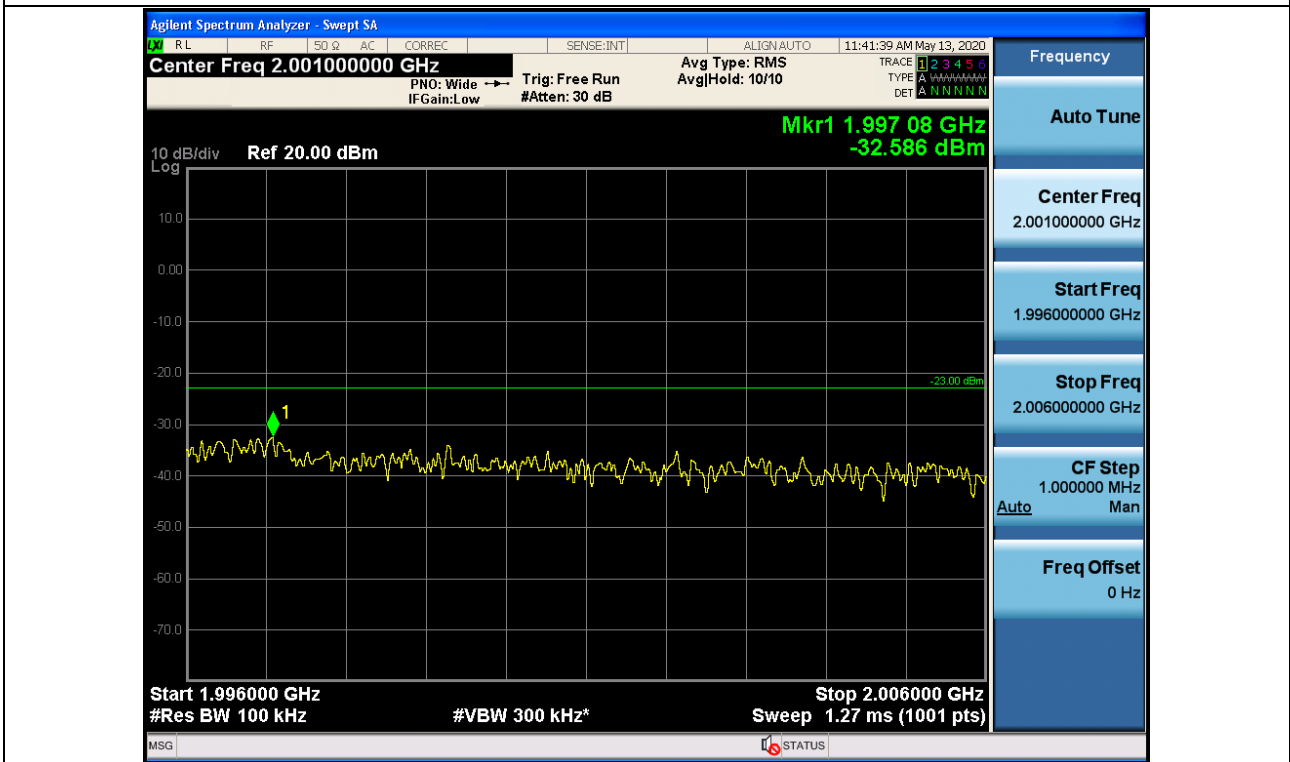

Spurious / PCS / Downlink / CDMA / Low / High Edge+10 ~ 10 GHz

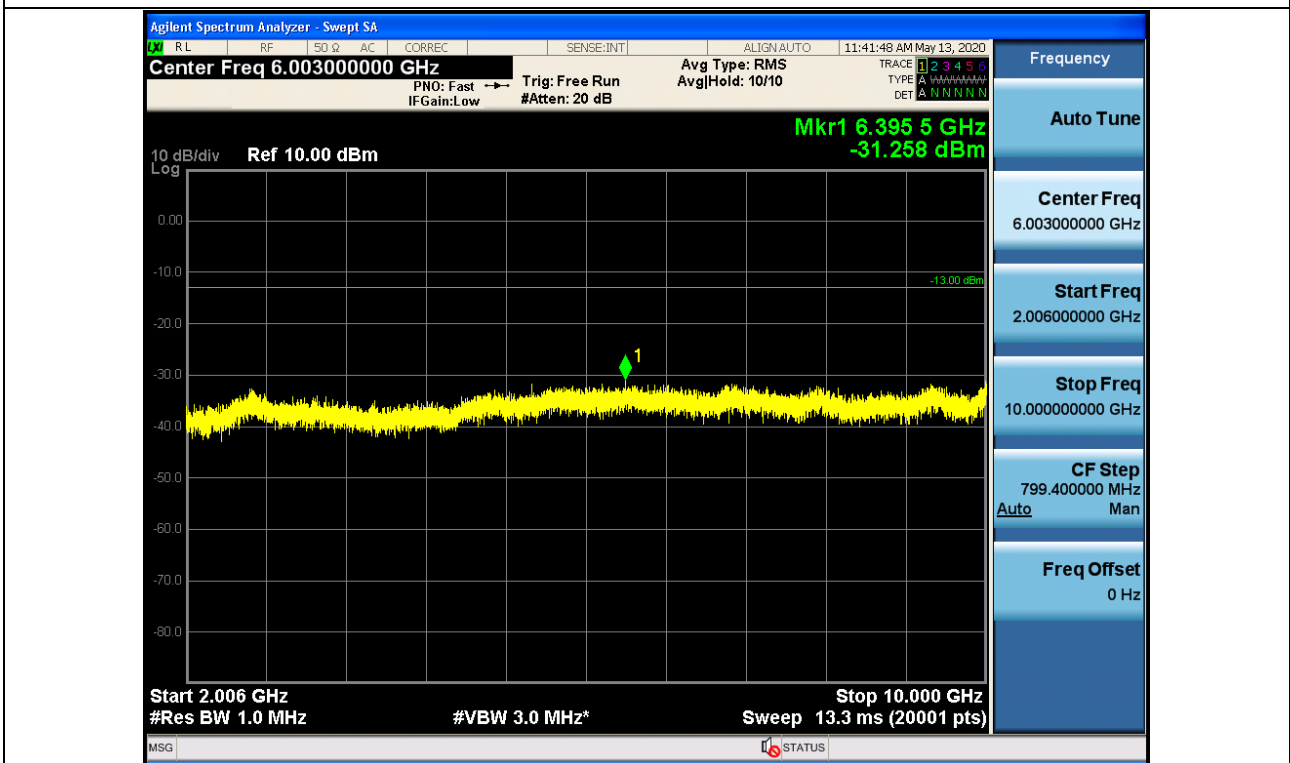

Spurious / PCS / Downlink / CDMA / Low / 10 GHz ~ 26.5 GHz

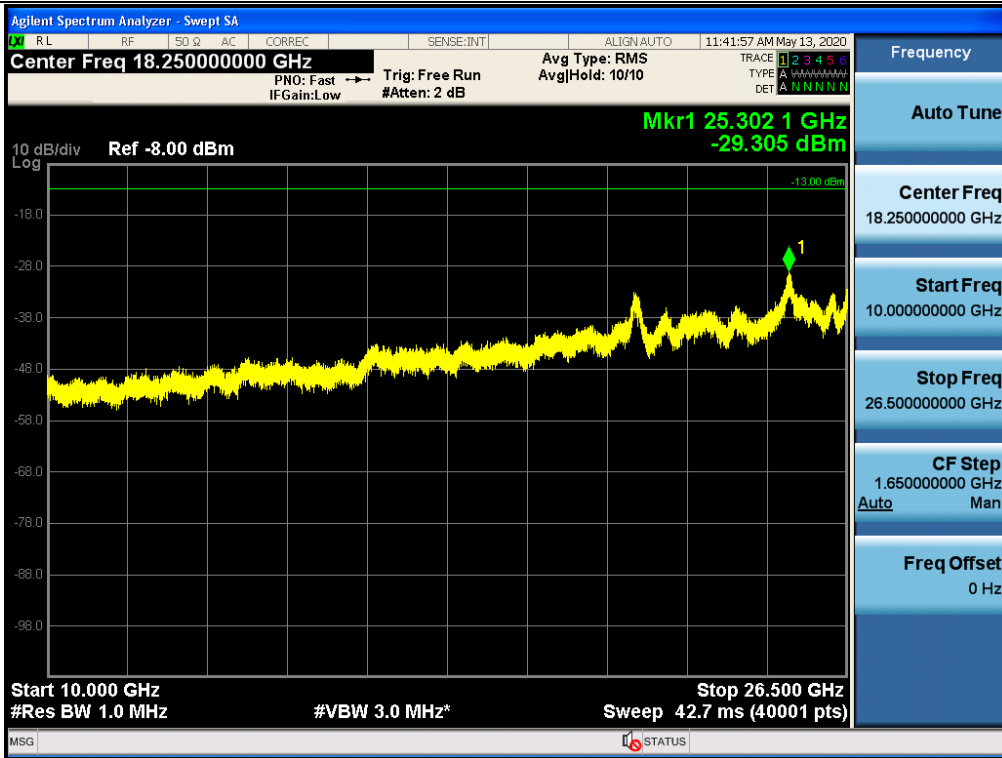

Spurious / PCS / Downlink / CDMA / Middle / 9 kHz ~ 150 kHz

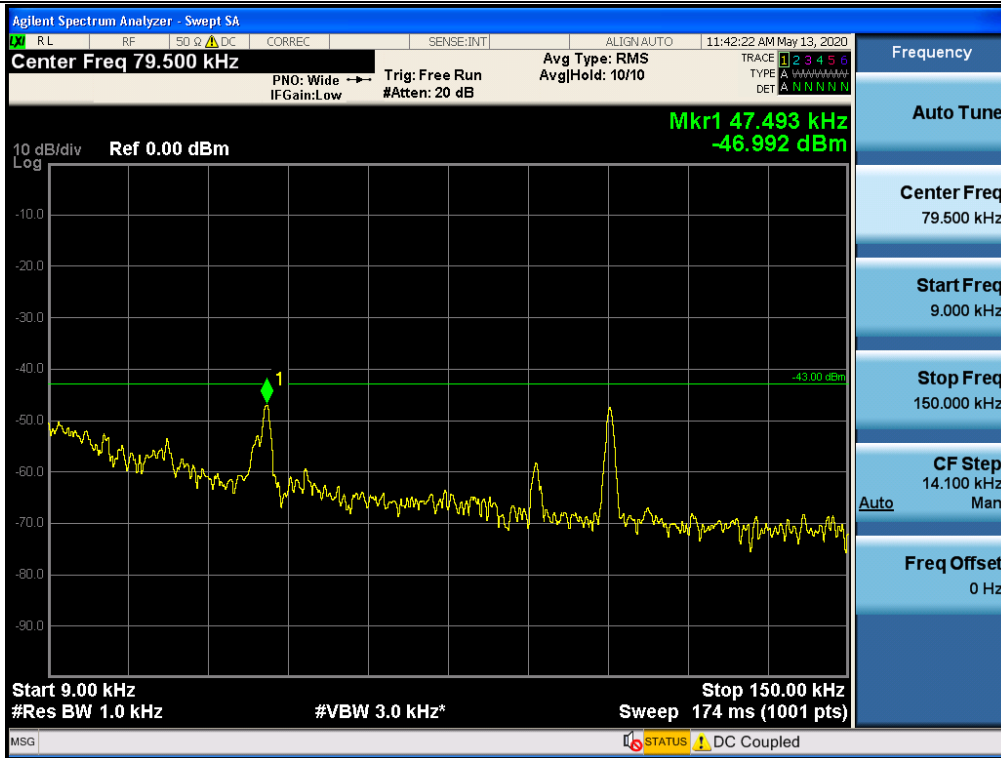

Spurious / PCS / Downlink / CDMA / Middle / 150 kHz ~ 30 MHz

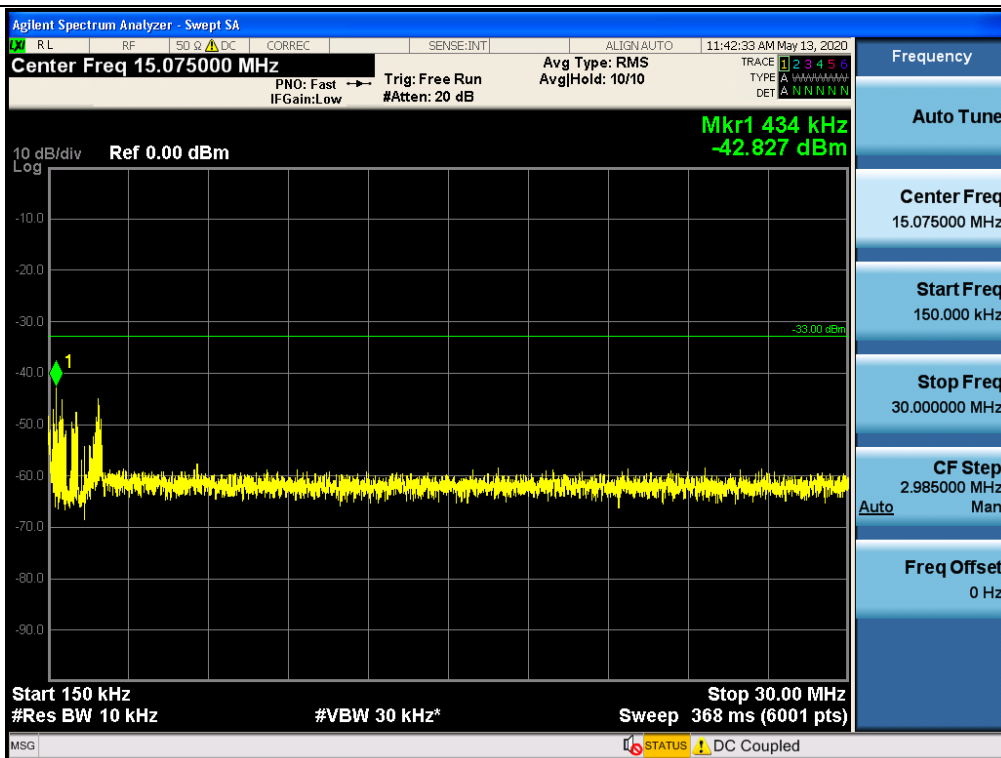

Spurious / PCS / Downlink / CDMA / Middle / 30 MHz ~ Low Edge-10

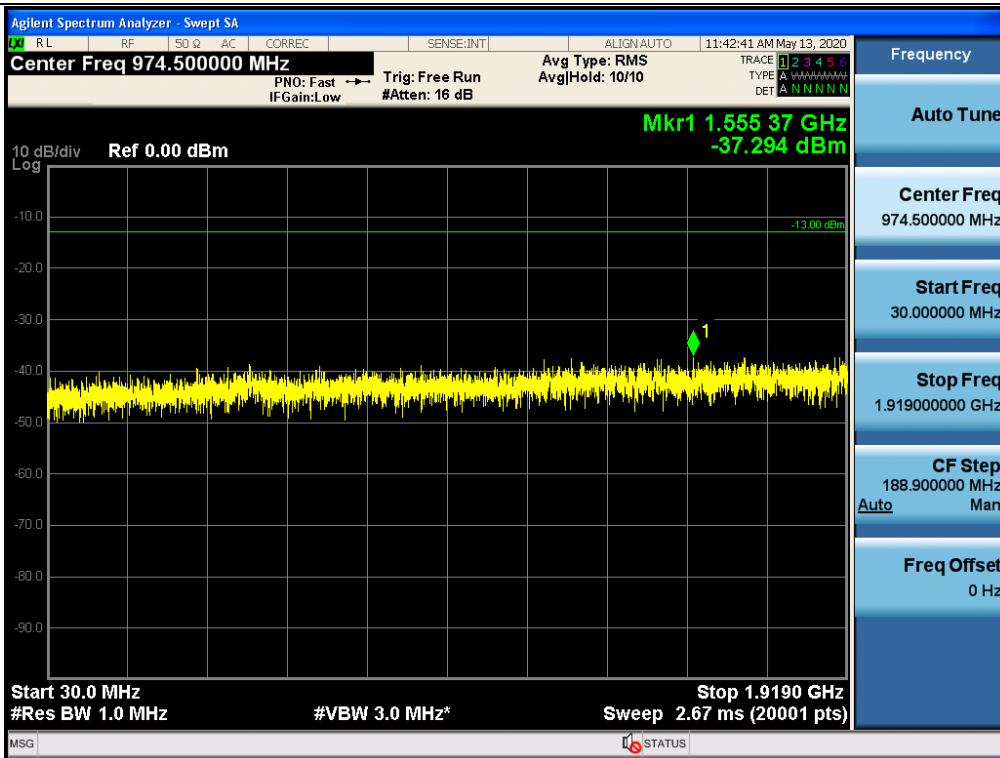

Spurious / PCS / Downlink / CDMA / Middle / Low Edge-10 ~ Low Edge

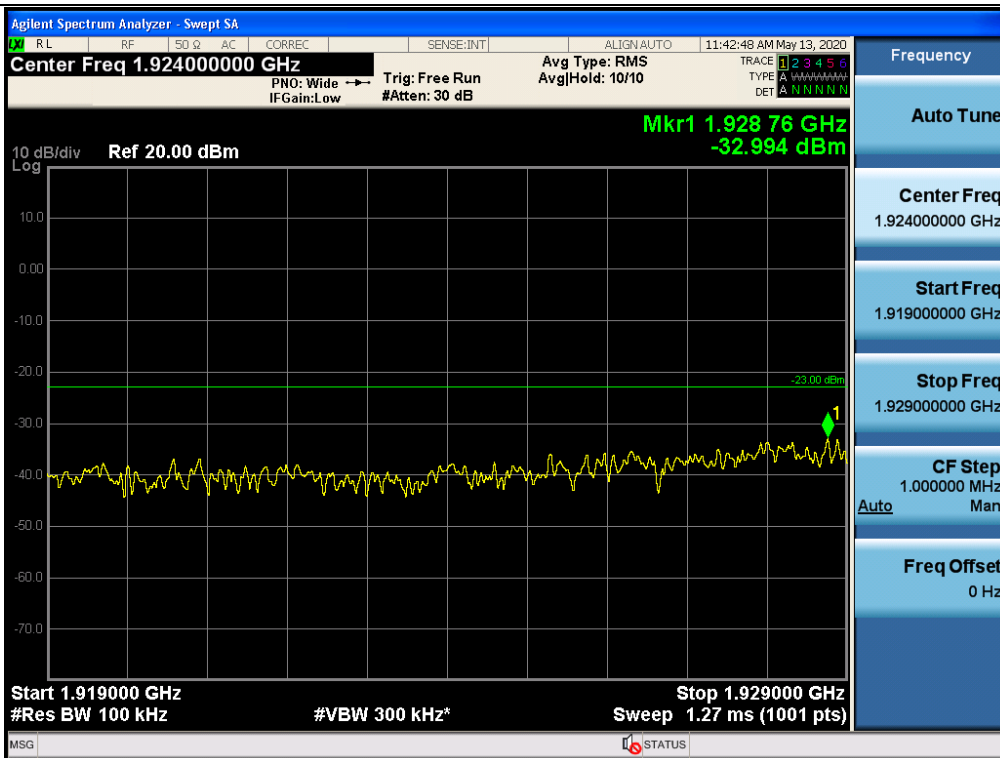

Spurious / PCS / Downlink / CDMA / Middle / High Edge ~ High Edge+10

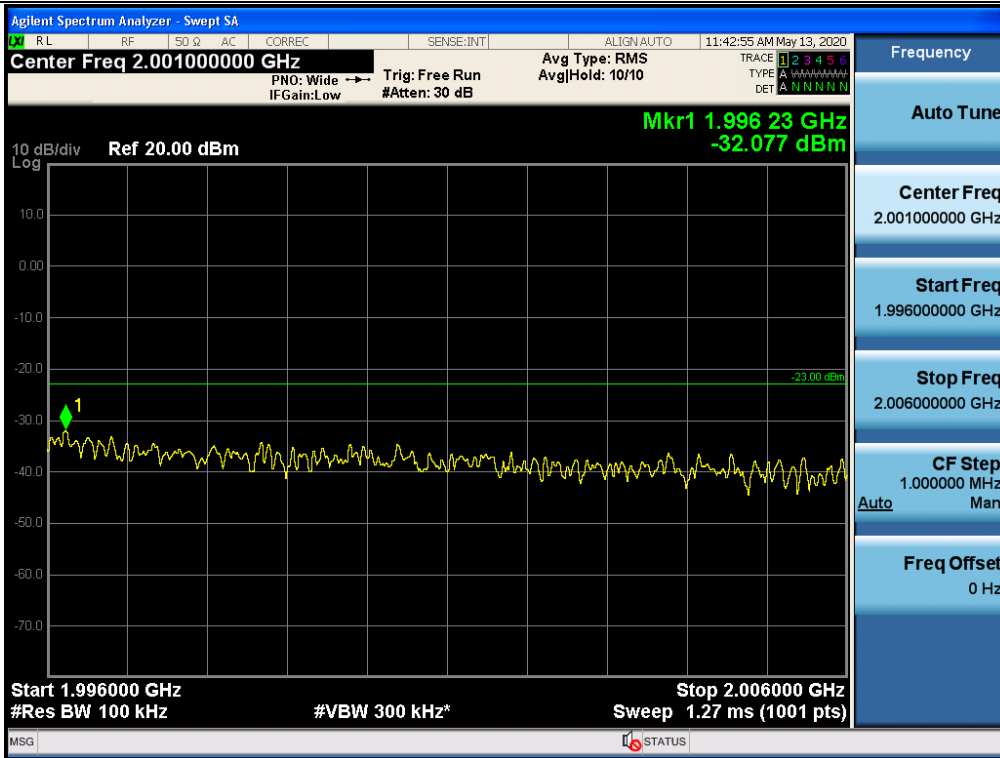

Spurious / PCS / Downlink / CDMA / Middle / High Edge+10 ~ 10 GHz

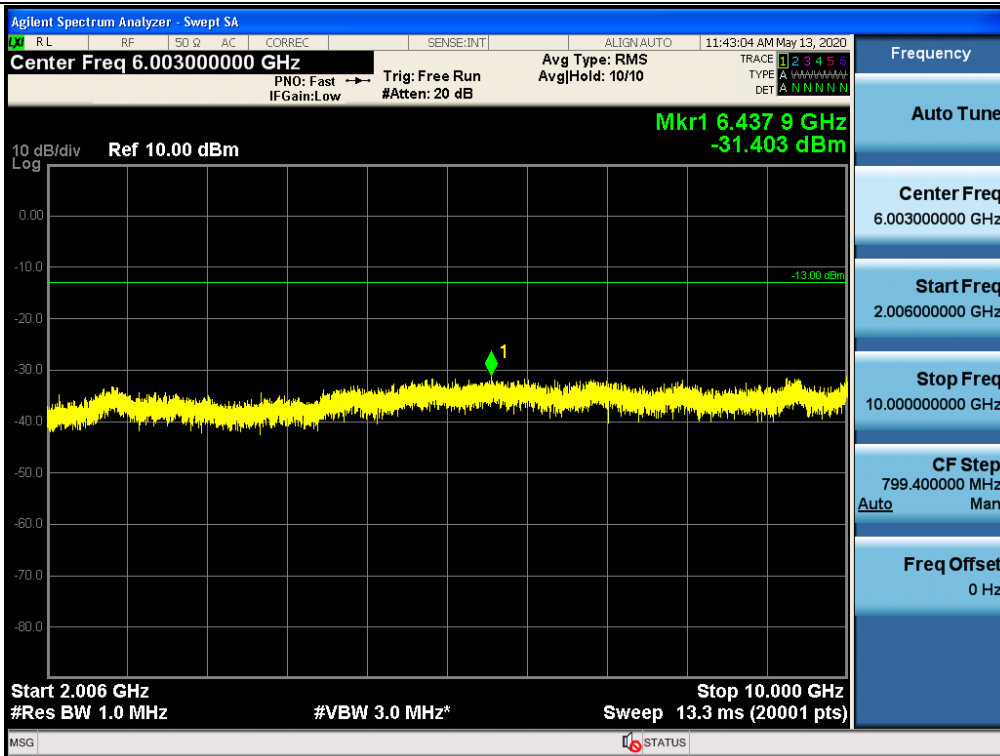

Spurious / PCS / Downlink / CDMA / Middle / 10 GHz ~ 26.5 GHz

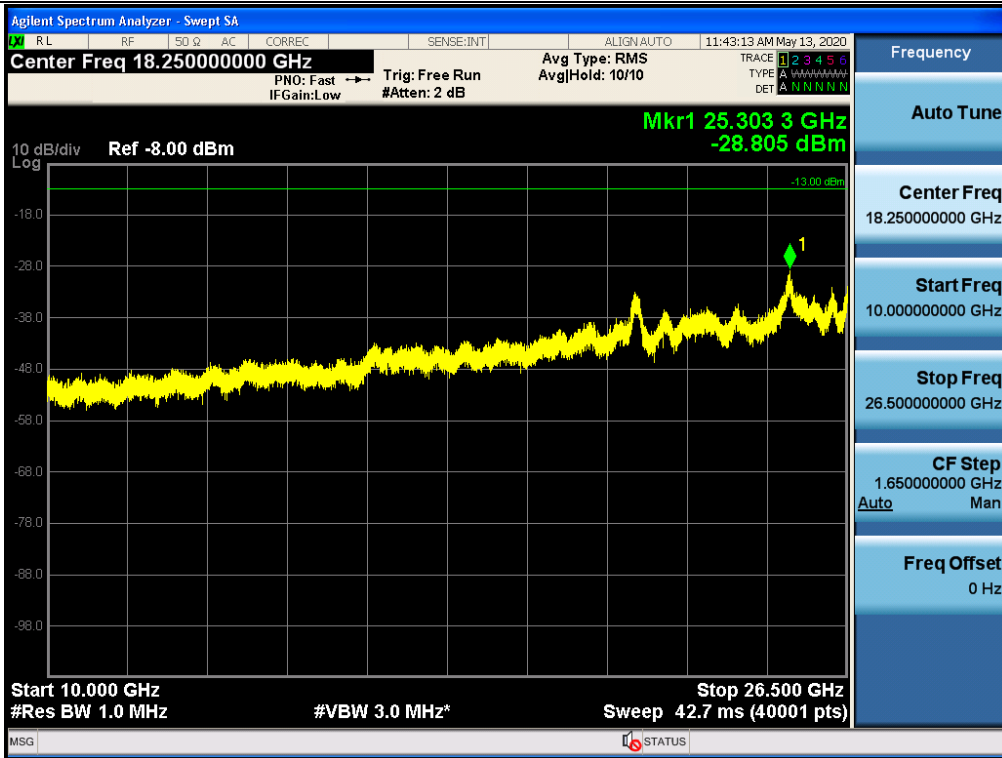

Spurious / PCS / Downlink / CDMA / High / 9 kHz ~ 150 kHz

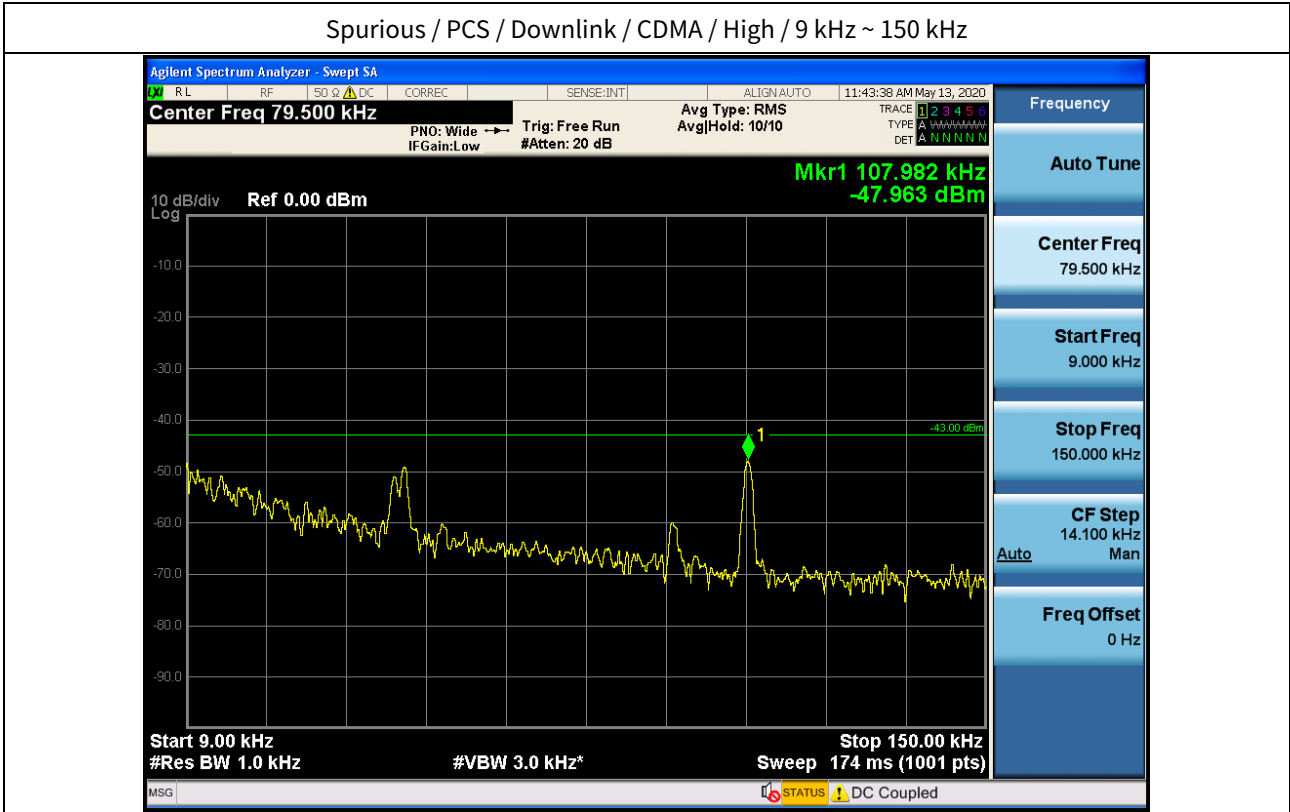

Spurious / PCS / Downlink / CDMA / High / 150 kHz ~ 30 MHz

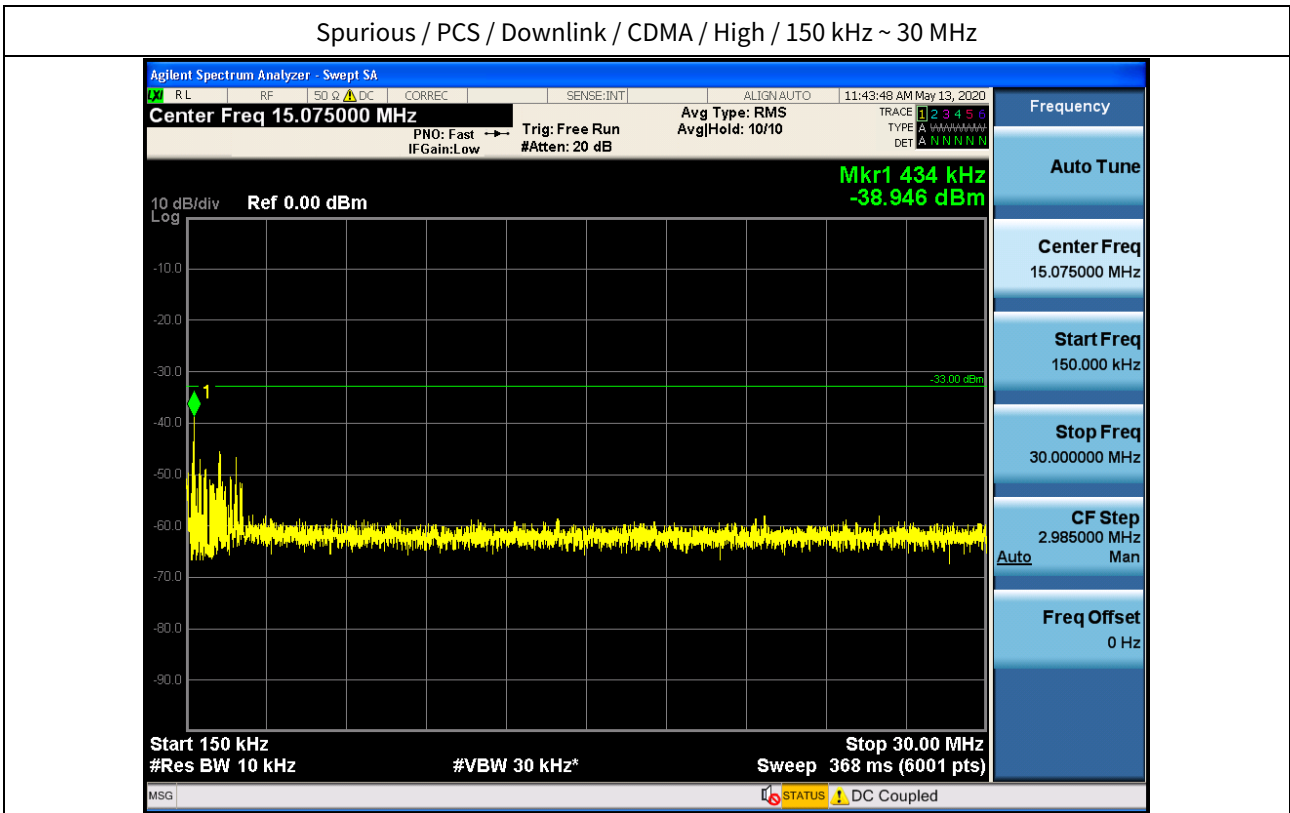

Spurious / PCS / Downlink / CDMA / High / 30 MHz ~ Low Edge-10

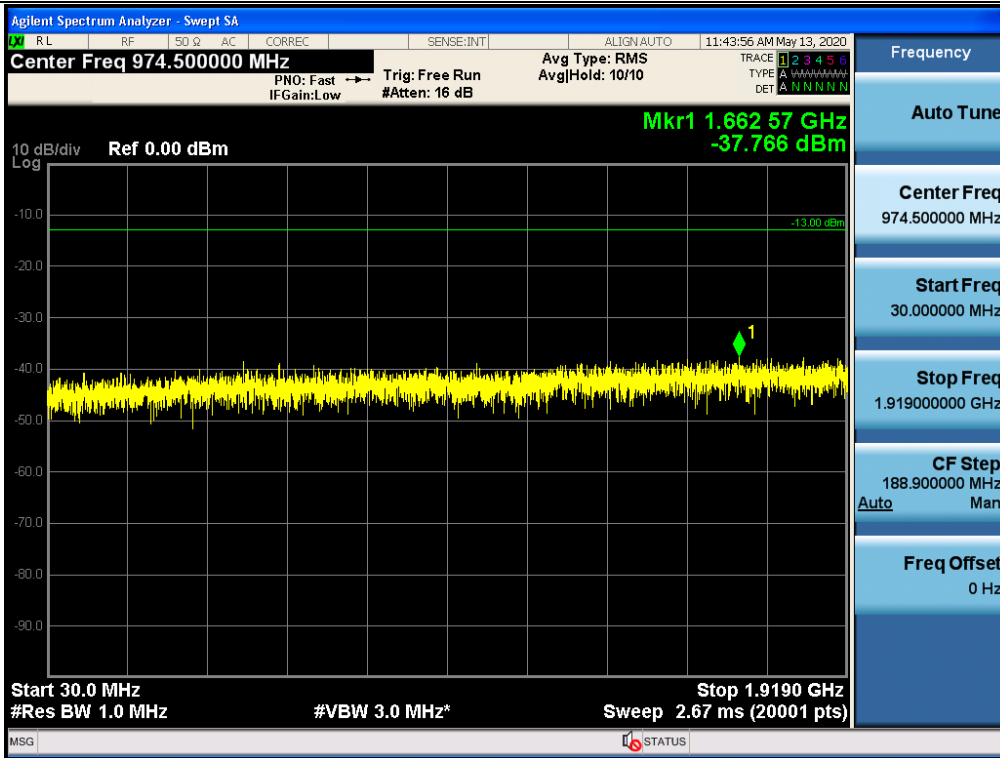

Spurious / PCS / Downlink / CDMA / High / Low Edge-10 ~ Low Edge

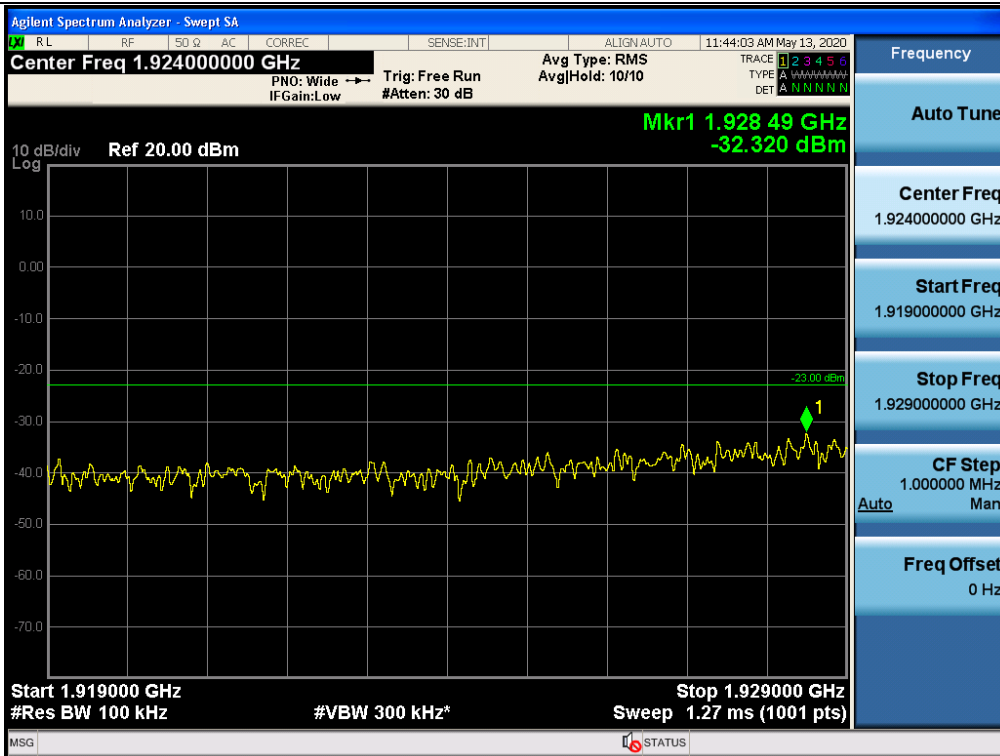

Spurious / PCS / Downlink / CDMA / High / High Edge ~ High Edge+10



Spurious / PCS / Downlink / CDMA / High / High Edge+10 ~ 10 GHz

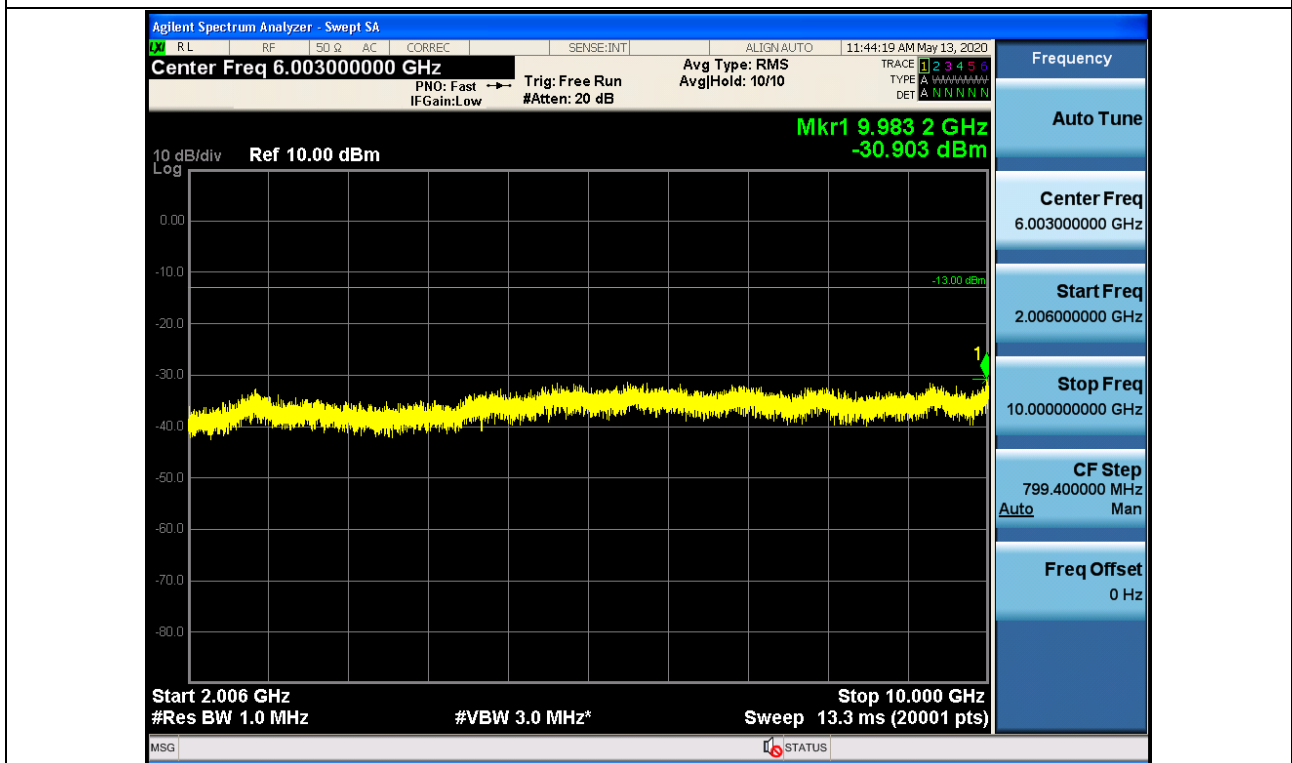

Spurious / PCS / Downlink / CDMA / High / 10 GHz ~ 26.5 GHz

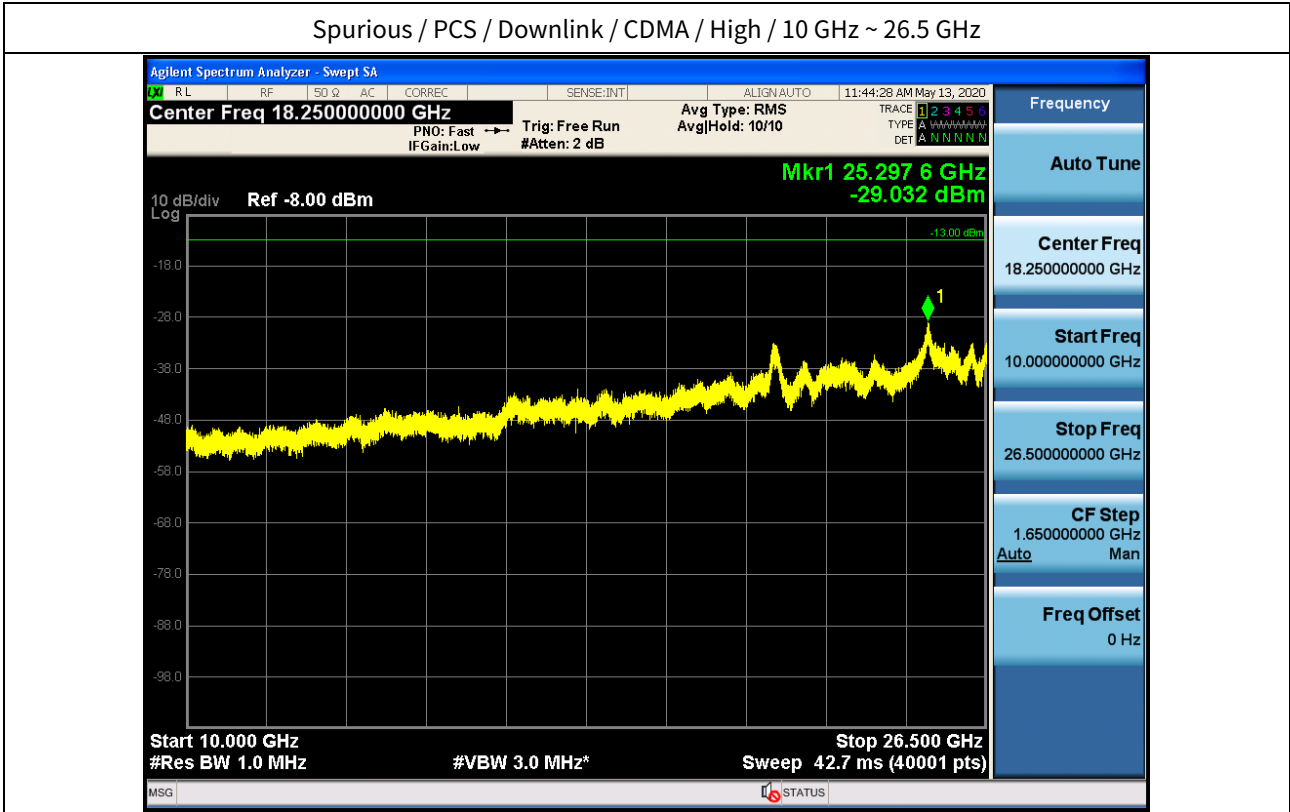

Spurious / PCS / Downlink / WCDMA / Low / 9 kHz ~ 150 kHz

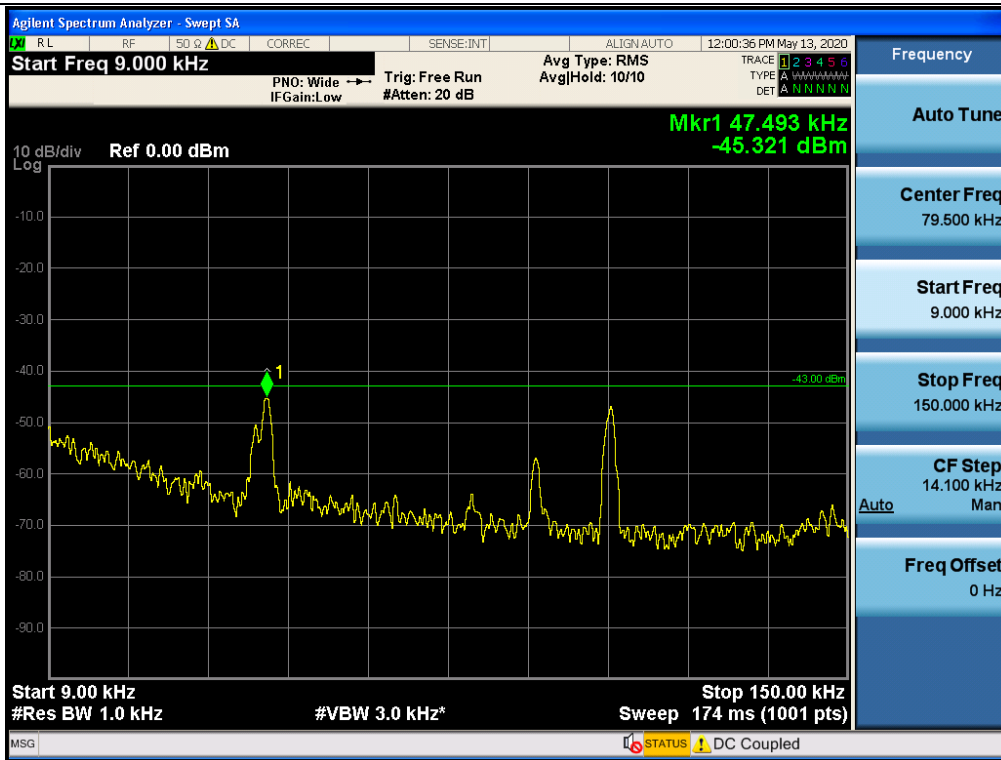

Spurious / PCS / Downlink / WCDMA / Low / 150 kHz ~ 30 MHz

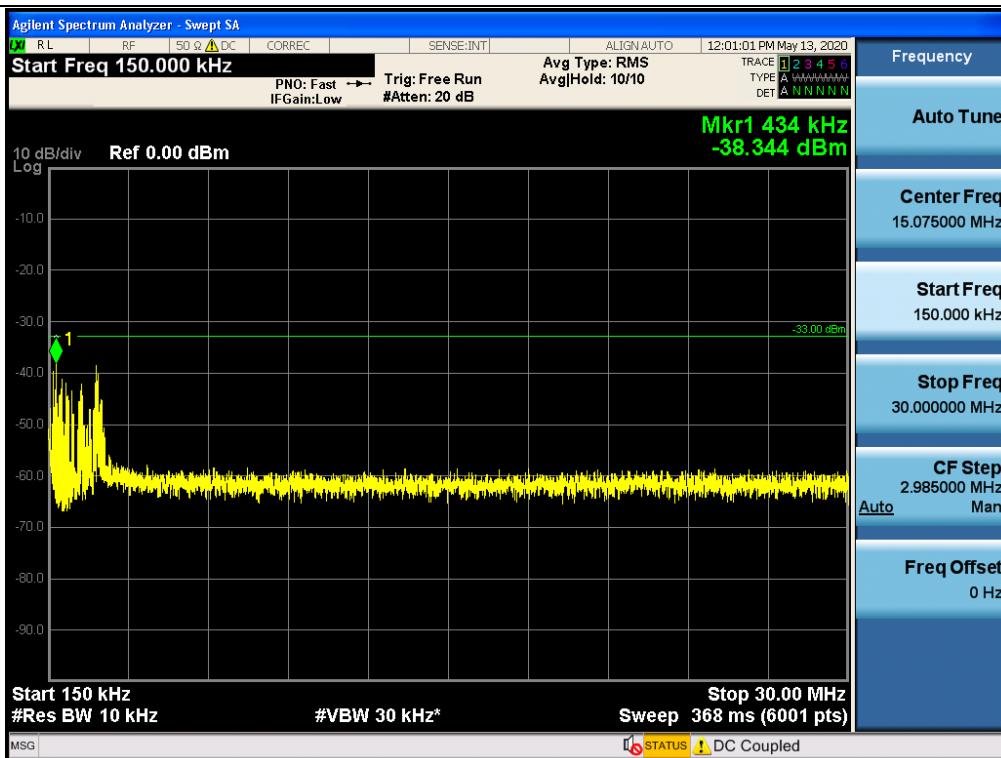

Spurious / PCS / Downlink / WCDMA / Low / 30 MHz ~ Low Edge-10

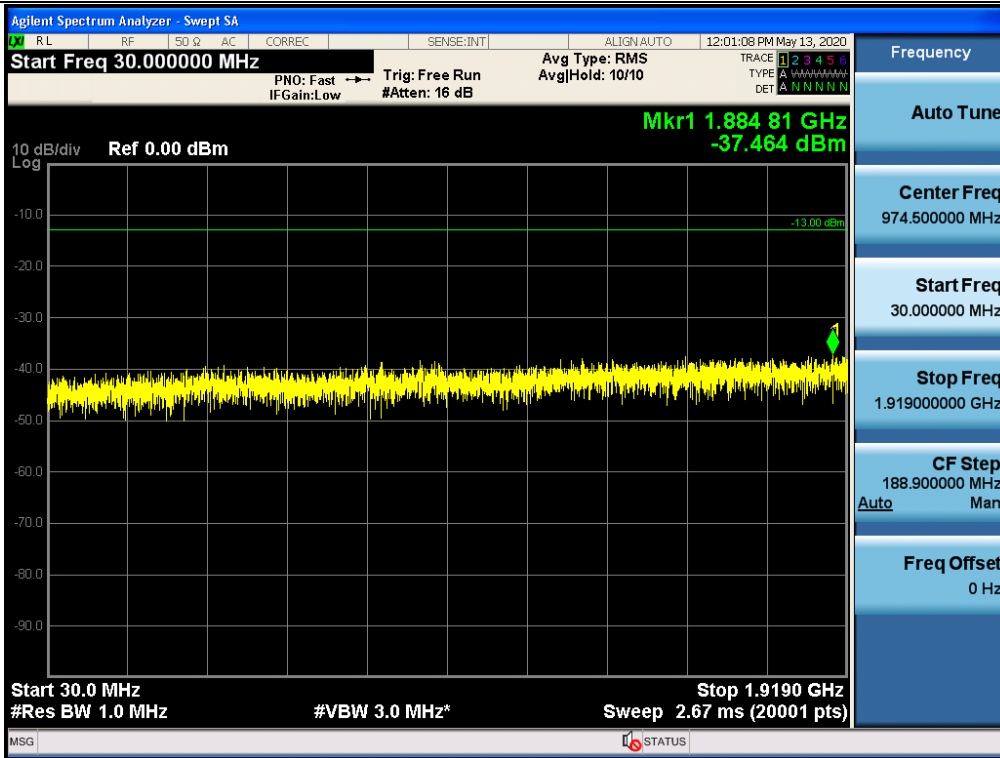

Spurious / PCS / Downlink / WCDMA / Low / Low Edge-10 ~ Low Edge

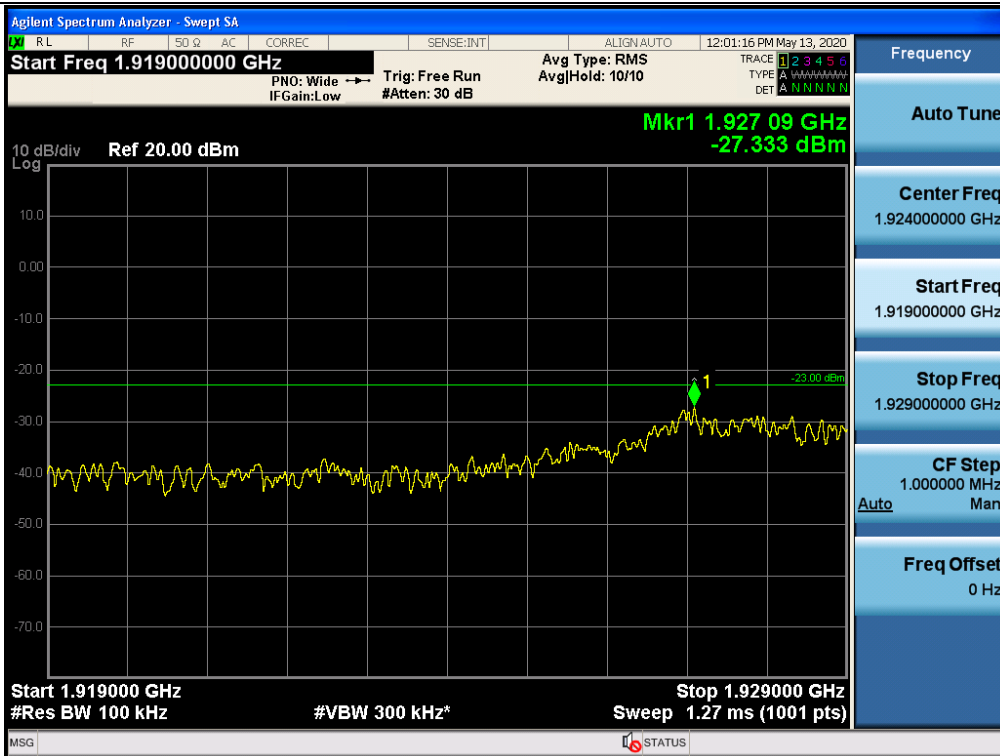

Spurious / PCS / Downlink / WCDMA / Low / High Edge ~ High Edge+10

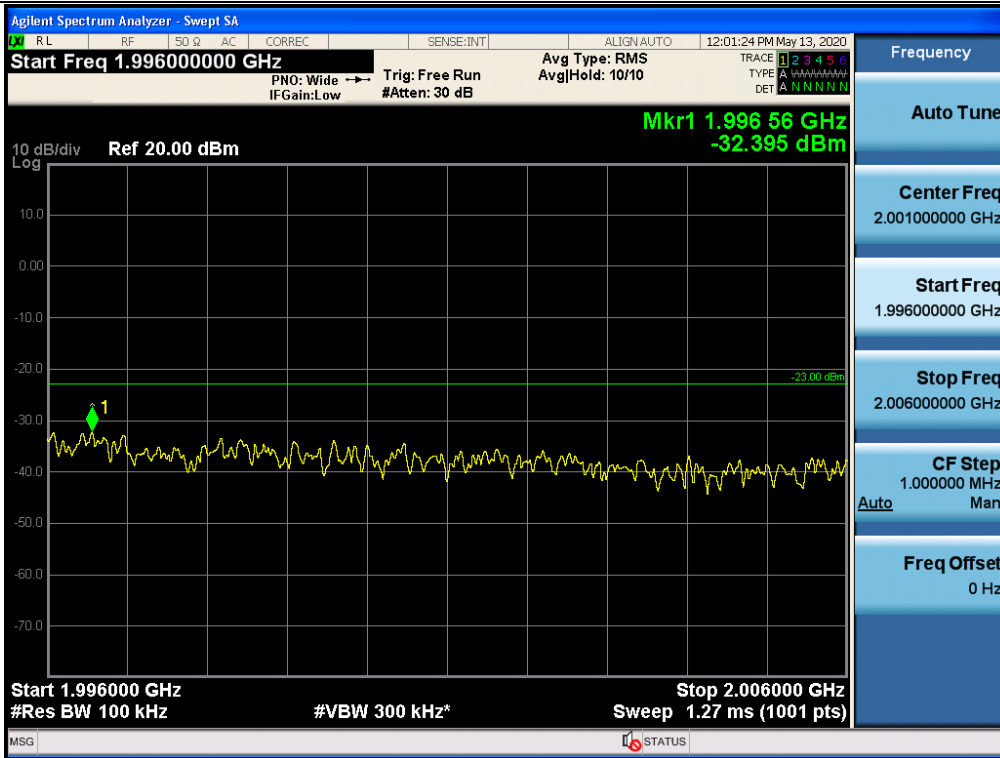

Spurious / PCS / Downlink / WCDMA / Low / High Edge+10 ~ 10 GHz

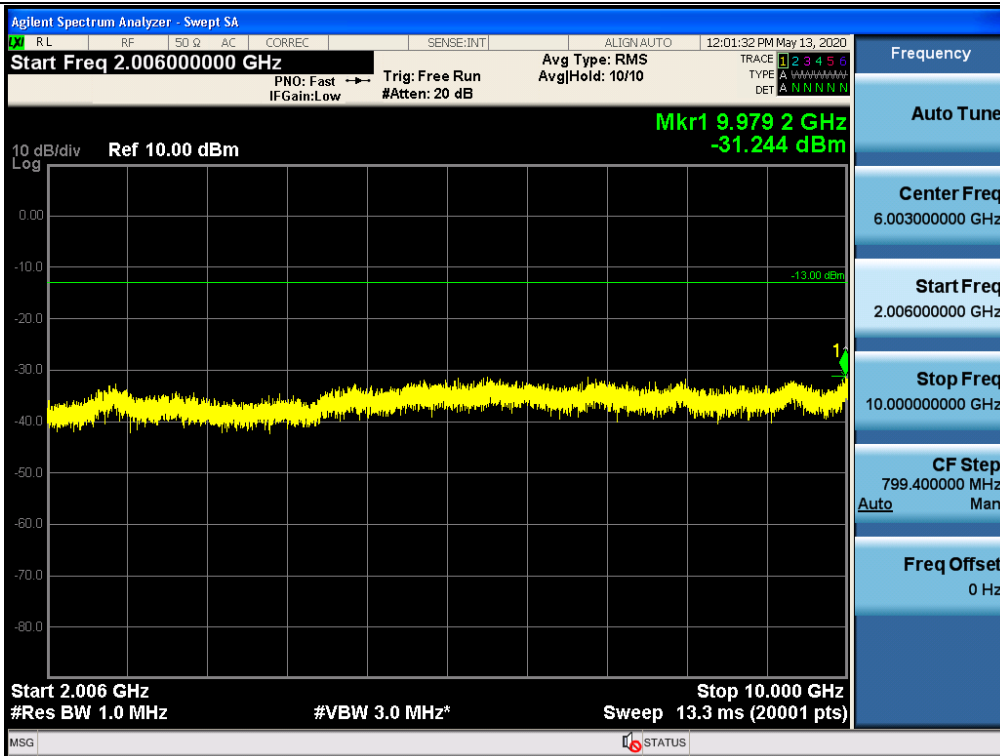

Spurious / PCS / Downlink / WCDMA / Low / 10 GHz ~ 26.5 GHz

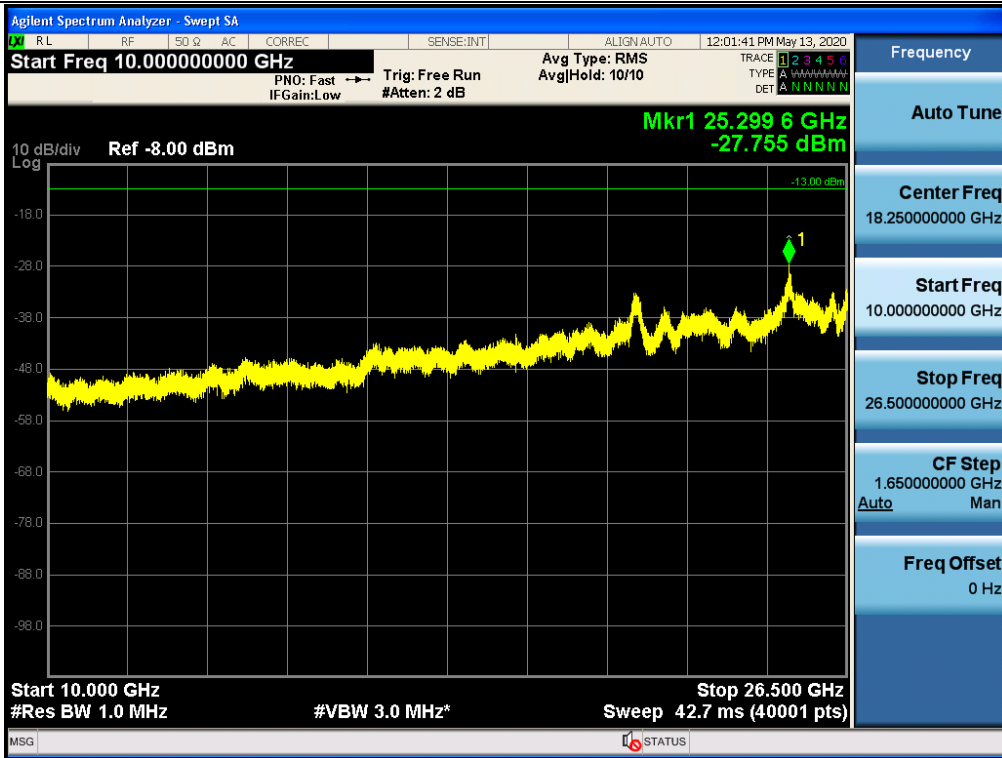

Spurious / PCS / Downlink / WCDMA / Middle / 9 kHz ~ 150 kHz

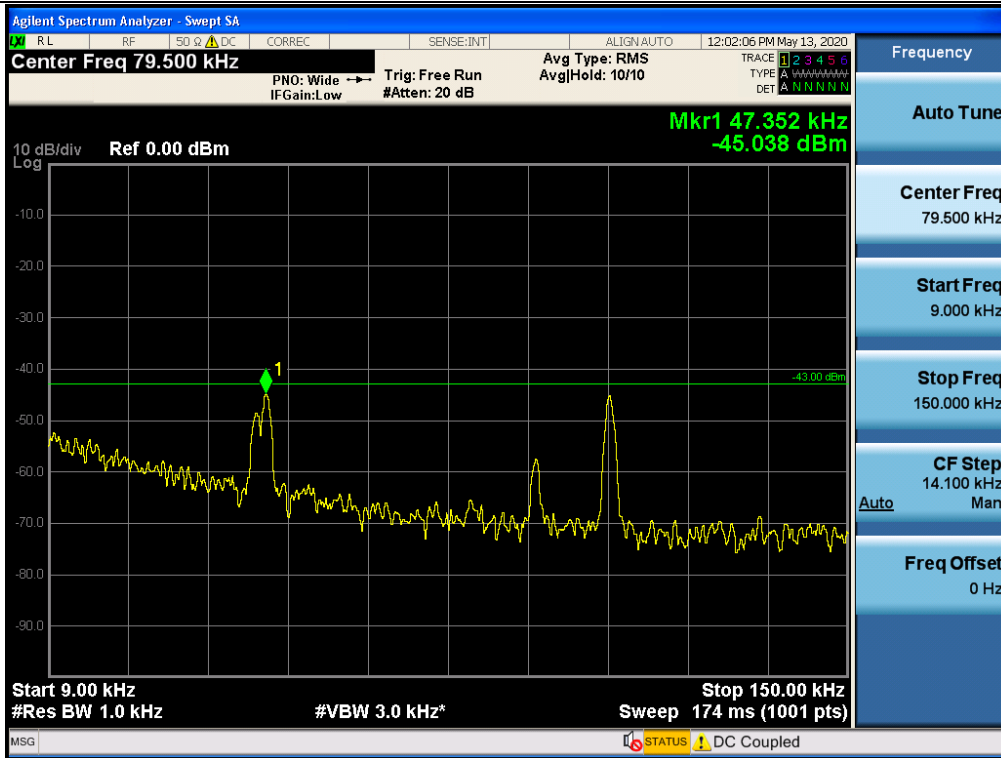

Spurious / PCS / Downlink / WCDMA / Middle / 150 kHz ~ 30 MHz

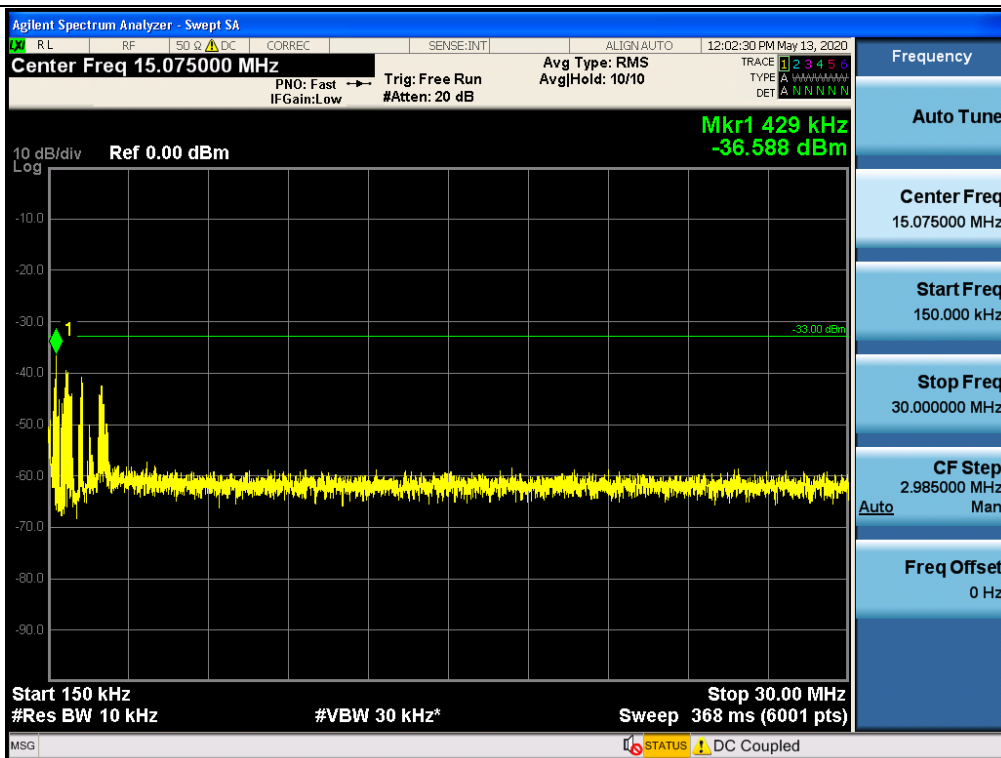

Spurious / PCS / Downlink / WCDMA / Middle / 30 MHz ~ Low Edge-10

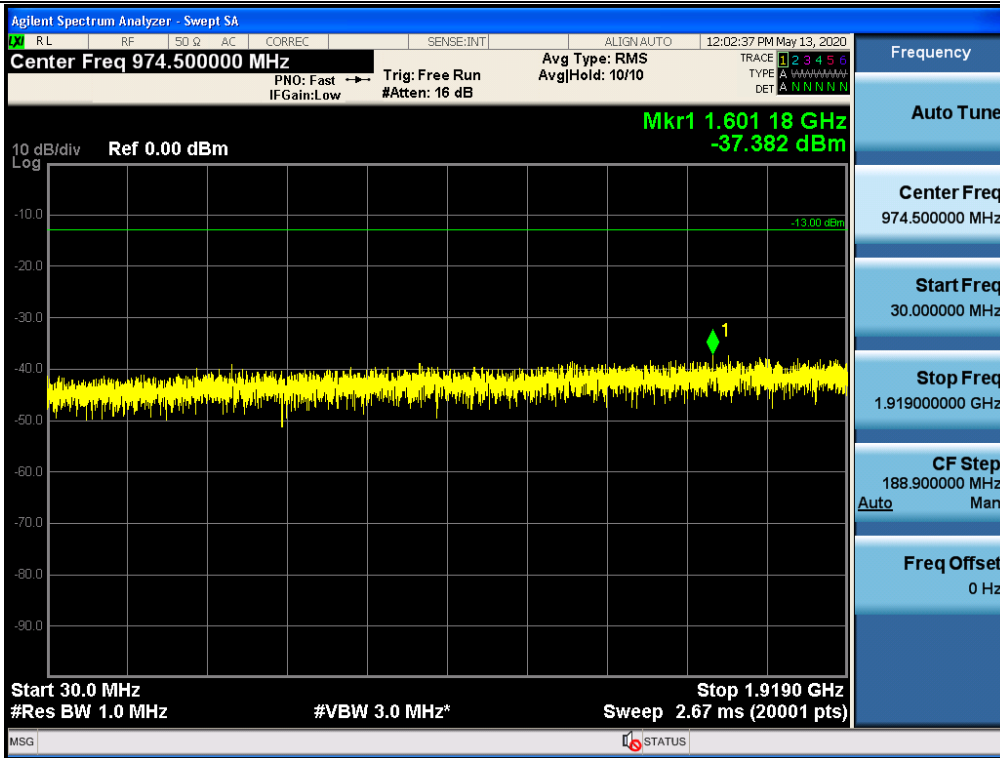

Spurious / PCS / Downlink / WCDMA / Middle / Low Edge-10 ~ Low Edge

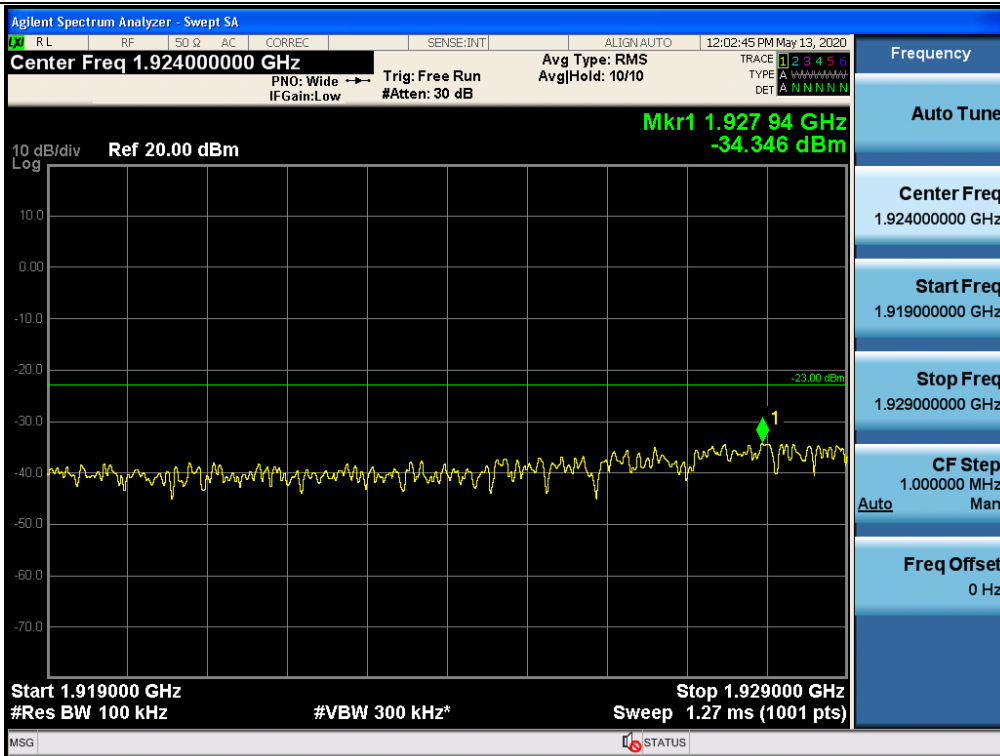

Spurious / PCS / Downlink / WCDMA / Middle / High Edge ~ High Edge+10

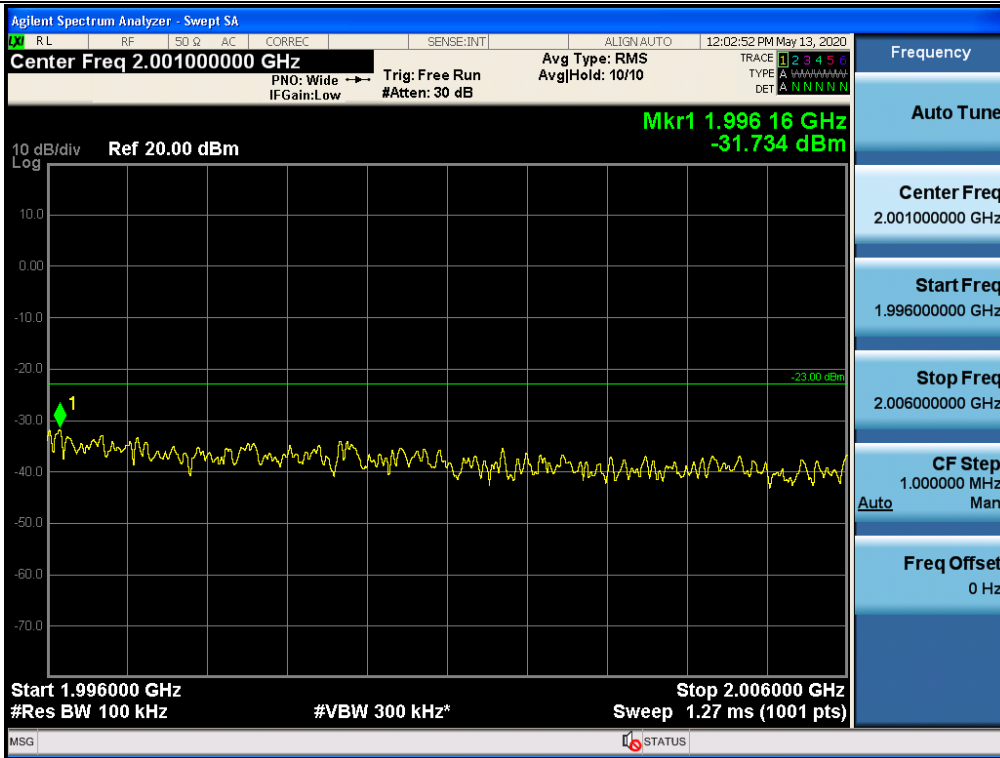

Spurious / PCS / Downlink / WCDMA / Middle / High Edge+10 ~ 10 GHz

