

TEST REPORT

FCC Test for N20-HRDU_600

Certification

APPLICANT
SOLiD, Inc.

REPORT NO.
HCT-RF-1907-FC025

DATE OF ISSUE
July 31, 2019

HCT Co., Ltd.

74, Seoicheon-ro 578beon-gil, Majang-myeon, Icheon-si, Gyeonggi-do, 17383 KOREA
Tel. +82 31 634 6300 F ax. +82 31 645 6401



HCT Co., Ltd.

74, Seoicheon-ro 578beon-gil, Majang-myeon, Icheon-si, Gyeonggi-do, 17383 KOREA
Tel. +82 31 634 6300 Fax. +82 31 645 6401

TEST REPORT

FCC Test for N20-
HRDU_600

REPORT NO.
HCT-RF-1907-FC025

DATE OF ISSUE
July 31, 2019

Other ID
-

Applicant **SOLiD, Inc.**
10, 9th Floor, SOLiD Space, Pangyoyeok-ro 220, Bundang-gu, Seongnam-si,
Gyeonggi-do, 463-400, South Korea

Eut Type ALLIANCE_N20
Model Name N20-HRDU_600

FCC ID W6UNH600

Output Power 43 dBm (20 W)

Date of Test June 24, 2019 ~ July 01, 2019

Tested by
Kwang Il Yoon

(signature)

Technical Manager
Jong Seok Lee

(signature)

HCT CO., LTD.

Soo Chan Lee
SooChan Lee / CEO

REVISION HISTORY

The revision history for this test report is shown in table.

Revision No.	Date of Issue	Description
0	July 31, 2019	Initial Release

The result shown in this test report refer only to the sample(s) tested unless otherwise stated.

The measurements shown in this report were made in accordance with the procedures indicated, and the emissions from this equipment were found to be within the limits applicable. I assume full responsibility for the accuracy and completeness of these measurements, and for the qualifications of all persons taking them. It is further stated that upon the basis of the measurements made, the equipment tested is capable of operation in accordance with the requirements of the FCC Rules under normal use and maintenance.

CONTENTS

1. GENERAL INFORMATION	5
1.1. APPLICANT INFORMATION	5
1.2. PRODUCT INFORMATION	5
1.3. TEST INFORMATION	5
2. FACILITIES AND ACCREDITATIONS	6
2.1. FACILITIES	6
2.2. EQUIPMENT	6
3. TEST SPECIFICATIONS	7
3.1. STANDARDS	7
3.2. ADDITIONAL DESCRIPTIONS ABOUT TEST	8
3.3. MEASUREMENT UNCERTAINTY	10
3.4. STANDARDS ENVIRONMENTAL TEST CONDITIONS	10
3.5. TEST DIAGRAMS	11
4. TEST EQUIPMENTS	12
5. TEST RESULT	13
5.1. AGC THRESHOLD	13
5.2. OUT-OF-BAND REJECTION	15
5.3. INPUT-VERSUS-OUTPUT SIGNAL COMPARISON	17
5.4. INPUT/OUTPUT POWER AND AMPLIFIER/BOOSTER GAIN	25
5.5. OUT-OF-BAND/OUT-OF-BLOCK EMISSIONS AND SPURIOUS EMISSIONS	28
5.6. RADIATED SPURIOUS EMISSIONS	79
6. Annex A_EUT AND TEST SETUP PHOTO	81

1. GENERAL INFORMATION

1.1. APPLICANT INFORMATION

Company Name	SOLiD, Inc.
Company Address	10, 9th Floor, SOLiD Space, Pangyoyeok-ro 220, Bundang-gu, Seongnam-si, Gyeonggi-do, 463-400, South Korea

1.2. PRODUCT INFORMATION

EUT Type	ALLIANCE_N20				
Power Supply	120 V AC, -48 V DC				
Frequency Range	<table border="1"> <thead> <tr> <th>Band Name</th> <th>Downlink (MHz)</th> </tr> </thead> <tbody> <tr> <td>600 MHz Service</td> <td>617 ~ 652</td> </tr> </tbody> </table>	Band Name	Downlink (MHz)	600 MHz Service	617 ~ 652
Band Name	Downlink (MHz)				
600 MHz Service	617 ~ 652				
Tx Output Power	43 dBm (20 W)				
Antenna Peak Gain	Manufacturer does not provide an Antenna.				

1.3. TEST INFORMATION

FCC Rule Parts	CFR 47 Part 2, Part 27
Measurement Standards	KDB 935210 D05 v01r03, ANSI C63.26-2015, ANSI/TIA-603-E-2016, KDB 971168 D01 v03r01
Test Location	HCT CO., LTD. 74, Seoicheon-ro 578beon-gil, Majang-myeon, Icheon-si, Gyeonggi-do, 17383, Rep. of KOREA

2. FACILITIES AND ACCREDITATIONS

2.1. FACILITIES

The SAC(Semi-Anechoic Chamber) and conducted measurement facility used to collect the radiated data are located at the 74, Seoicheon-ro 578beon-gil, Majang-myeon, Icheon-si, Gyeonggi-do, 17383, Rep. of KOREA.

The site is constructed in conformance with the requirements of ANSI C63.4 (Version: 2014) and CISPR Publication 22.

Detailed description of test facility was submitted to the Commission and accepted dated April 02, 2018 (Registration Number: KR0032).

2.2. EQUIPMENT

Radiated emissions are measured with one or more of the following types of linearly polarized antennas: tuned dipole, bi-conical, log periodic, bi-log, and/or ridged waveguide, horn. Spectrum analyzers with pre-selectors and quasi-peak detectors are used to perform radiated measurements.

Calibrated wideband preamplifiers, coaxial cables, and coaxial attenuators are also used for making measurements.

All receiving equipment conforms to CISPR Publication 16-1, "Radio Interference Measuring Apparatus and Measurement Methods".

3. TEST SPECIFICATIONS

3.1. STANDARDS

The following tests were conducted on a sample of the equipment for the purpose of demonstrating compliance with FCC Part 2 and Par 27.

Description	Reference	Results
AGC threshold	KDB 935210 D05 v01r03 3.2	Compliant
Out-of-band rejection	KDB 935210 D05 v01r03 3.3	Compliant
Input-versus-output signal comparison	§ 2.1049	Compliant
Input/output power and amplifier/booster gain	§ 2.1046, § 27.50(c)	Compliant
Out-of-band/out-of-block emissions and spurious emissions	§ 2.1051, § 27.53(g)	Compliant
Spurious emissions radiated	§ 2.1053, § 27.53	Compliant

3.2. ADDITIONAL DESCRIPTIONS ABOUT TEST

Except for the following cases, EUT was tested under normal operating conditions.

: Out-of-band rejection test requires maximum gain condition without AGC

The test was generally based on the method of KDB 935210 D05 v01r03 and only followed ANSI C63.26-2015 if there was no test method in KDB standard.

EUT was tested with following modulated signals provide by applicant.

Band Name	Tested signals
600 MHz Service	LTE 5 MHz, 10 MHz, 20 MHz

The frequency stability measurement has been omitted in accordance with section 3.7 of KDB 935210 D05 v01r03.

: It can be confirmed through input-versus-output signal comparison test that EUT does not alter the input signal.

The tests results included actual loss value for attenuator and cable combination as shown in the table below.

: Input Path

Correction factor table			
Frequency (MHz)	Factor (dB)	Frequency (MHz)	Factor (dB)
500	0.394	800	0.479
550	0.238	850	0.537
600	0.287	900	0.536
650	0.455	950	0.569
700	0.425	1000	0.457
750	0.473	1050	0.573

: Output Path

Correction factor table			
Frequency (MHz)	Factor (dB)	Frequency (MHz)	Factor (dB)
2	31.060	5000	39.061
10	30.153	5500	38.673
20	30.026	6000	38.669
30	29.924	6500	38.414
40	29.997	7000	37.847
50	30.021	7500	37.864
100	30.186	8000	37.571
200	30.709	8500	36.882
300	31.003	9000	36.807
400	31.206	9500	36.639
500	31.441	10000	37.826
600	31.548	-	-
700	31.908	-	-
800	32.127	-	-
900	32.408	-	-
1000	32.558	-	-
1200	33.256	-	-
1400	33.722	-	-
1600	34.501	-	-
1800	34.984	-	-
2000	35.743	-	-
2500	37.577	-	-
3000	39.050	-	-
3500	39.772	-	-
4000	39.902	-	-
4500	39.409	-	-

3.3. MEASUREMENT UNCERTAINTY

Description	Reference	Results
AGC threshold	-	± 0.87 dB
Out-of-band rejection	-	± 0.58 MHz
Input-versus-output signal comparison	OBW > 5 MHz	± 0.58 MHz
Input/output power and amplifier/booster gain	-	± 0.87 dB
Out-of-band/out-of-block emissions and spurious emissions	-	± 1.08 dB
Spurious emissions radiated	$f \leq 1$ GHz	± 4.80 dB
	$f > 1$ GHz	± 6.07 dB

* Coverage factor $k = 2$, Confidence levels of 95 %

3.4. STANDARDS ENVIRONMENTAL TEST CONDITIONS

Temperature	+15 °C to +35 °C
Relative humidity	30 % to 60 %
Air pressure	860 mbar to 1 060 mbar

3.5. TEST DIAGRAMS

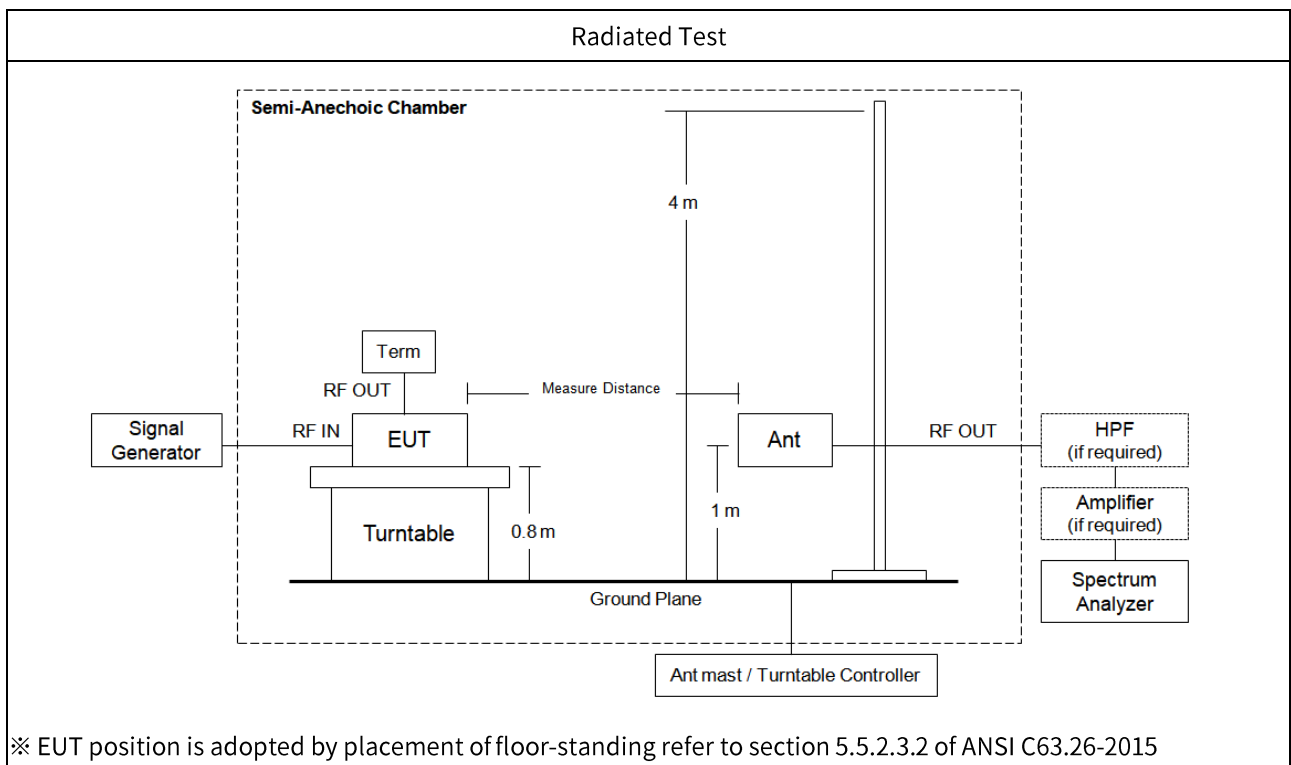
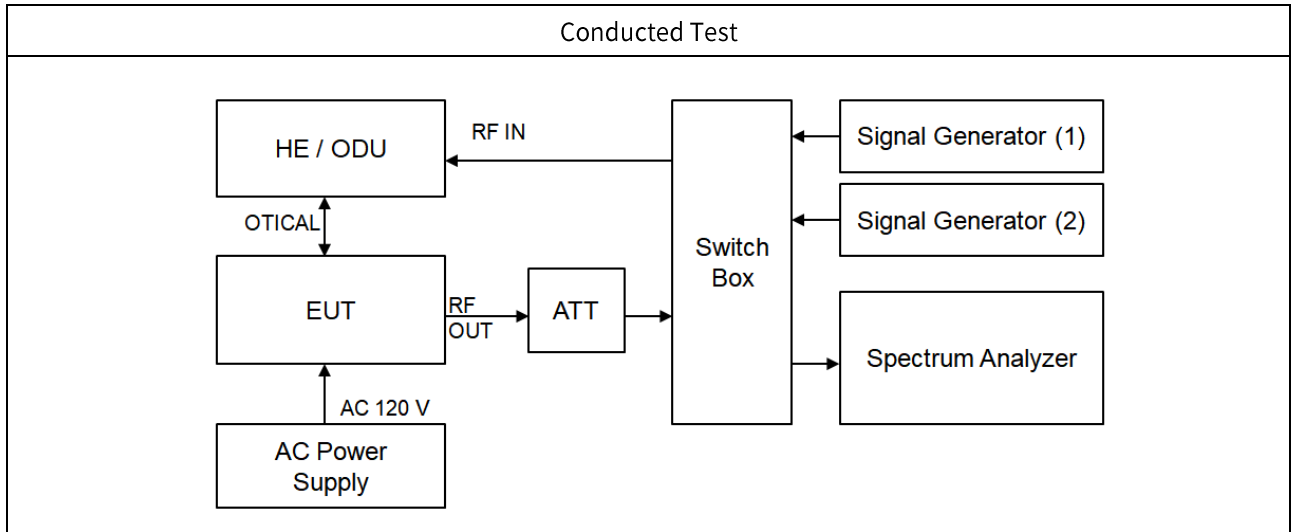

4. TEST EQUIPMENTS

Manufacturer	Model / Equipment	Calibration Date	Calibration Interval	Serial No.
Agilent	N9020A / MXA Signal Analyzer	05/08/2019	Annual	MY51110063
Agilent	N5182A / MXG Vector Signal Generator	08/03/2018	Annual	MY46240523
Agilent	N5182A / MXG Vector Signal Generator	01/18/2019	Annual	MY47070406
Agilent	8498A / 30 dB Attenuator	02/18/2019	Annual	51161
KEITHLEY	S46 / Switch	N/A	N/A	1088024
Deayoung ENT	DFSS60 / AC Power Supply	04/04/2019	Annual	1003030-1
Innco system	CO3000 / Controller(Antenna mast)	N/A	N/A	CO3000-4p
Innco system	MA4640/800-XP-EP / Antenna Position Tower	N/A	N/A	N/A
Audix	EM1000 / Controller	N/A	N/A	060520
Audix	- / Turn Table	N/A	N/A	N/A
Rohde&Schwarz	- / Loop Antenna	08/23/2018	Biennial	1513-175
Schwarzbeck	VULB 9168 / Hybrid Antenna	08/31/2018	Biennial	00895
Schwarzbeck	BBHA 9120D / Horn Antenna	06/28/2018	Biennial	1300
Schwarzbeck	BBHA9170 / Horn Antenna(15 GHz ~ 40 GHz)	12/04/2017	Biennial	BBHA9170541
Rohde&Schwarz	FSP (9 kHz ~ 40 GHz) / Spectrum Analyzer	07/24/2018	Annual	100843
CERNEX	CBLU1183540B-01 / Power Amplifier	12/21/2018	Annual	25540
CERNEX	CBL06185030 / Power Amplifier	03/26/2019	Annual	28550
CERNEX	CBL18265035 / Power Amplifier	01/03/2019	Annual	22966
CERNEX	CBL26405040 / Power Amplifier	06/29/2018	Annual	25956

5. TEST RESULT

5.1. AGC THRESHOLD

Test Requirement:

KDB 935210 D05 v01r03

Testing at and above the AGC threshold is required.

Test Procedures:

Measurements were in accordance with the test methods section 3.2 of KDB 935210 D05 v01r03.

In the case of fiber-optic distribution systems, the RF input port of the equipment under test (EUT) refers to the RF input of the supporting equipment RF to optical convertor; see also descriptions and diagrams for typical DAS booster systems in KDB Publication 935210 D02

Devices intended to be directly connected to an RF source (donor port) only need to be evaluated for any over-the-air transmit paths.

- a) Connect a signal generator to the input of the EUT.
- b) Connect a spectrum analyzer or power meter to the output of the EUT using appropriate attenuation as necessary.
- c) The signal generator should initially be configured to produce either of the required test signals.
- d) Set the signal generator frequency to the center frequency of the EUT operating band.
- e) While monitoring the output power of the EUT, measured using the methods of ANSI C63.26-2015 subclause 5.2.4.4.1, increase the input level until a 1 dB increase in the input signal power no longer causes a 1 dB increase in the output signal power.
- f) Record this level as the AGC threshold level.
- g) Repeat the procedure with the remaining test signal.

Output power measurement in subclause 5.2.4.4.1 of ANSI C63.26

- a) Set span to $2 \times$ to $3 \times$ the OBW.
- b) Set RBW = 1% to 5% of the OBW.
- c) Set VBW $\geq 3 \times$ RBW.
- d) Set number of measurement points in sweep $\geq 2 \times$ span / RBW.
- e) Sweep time: auto-couple
- f) Detector = power averaging (rms).

g) If the EUT can be configured to transmit continuously, then set the trigger to free run.

h) Omit

i) Trace average at least 100 traces in power averaging (rms) mode if sweep is set to auto-couple. To accurately determine the average power over multiple symbols, it can be necessary to increase the number of traces to be averaged above 100 or, if using a manually configured sweep time, increase the sweep time.

j) Compute the power by integrating the spectrum across the OBW of the signal using the instrument's band or channel power measurement function, with the band/channel limits set equal to the OBW band edges. If the instrument does not have a band or channel power function, then sum the spectrum levels (in linear power units) at intervals equal to the RBW extending across the entire OBW of the spectrum.

Test Results:

Test Band	Link	Signal	Center Frequency (MHz)	AGC Threshold Level (dBm)	Output Level (dBm)
600 MHz Service	Downlink	LTE 5 MHz	634.50	-15.00	43.09
		LTE 10 MHz	634.50	-15.00	43.43
		LTE 20 MHz	634.50	-15.00	42.80

5.2. OUT-OF-BAND REJECTION

Test Requirement:

KDB 935210 D05 v01r03

Out-of-band rejection required.

Test Procedures:

Measurements were in accordance with the test methods section 3.3 of KDB 935210 D05 v01r03.

Adjust the internal gain control of the EUT to the maximum gain for which equipment certification is sought.

- a) Connect a signal generator to the input of the EUT.
- b) Configure a swept CW signal with the following parameters:
 - 1) Frequency range = $\pm 250\%$ of the passband, for each applicable CMRS band.
 - 2) Level = a sufficient level to affirm that the out-of-band rejection is > 20 dB above the noise floor and will not engage the AGC during the entire sweep.
 - 3) Dwell time = approximately 10 ms.
 - 4) Number of points = $\text{SPAN}/(\text{RBW}/2)$.
- c) Connect a spectrum analyzer to the output of the EUT using appropriate attenuation.
- d) Set the span of the spectrum analyzer to the same as the frequency range of the signal generator.
- e) Set the resolution bandwidth (RBW) of the spectrum analyzer to be 1 % to 5 % of the EUT passband, and the video bandwidth (VBW) shall be set to $\geq 3 \times \text{RBW}$.
- f) Set the detector to Peak Max-Hold and wait for the spectrum analyzer's spectral display to fill.
- g) Place a marker to the peak of the frequency response and record this frequency as f_0 .
- h) Place two markers, one at the lowest and the other at the highest frequency of the envelope of the spectral display, such that each marker is at or slightly below the -20 dB down amplitude, to determine the 20 dB bandwidth.
- i) Capture the frequency response of the EUT.
- j) Repeat for all frequency bands applicable for use by the EUT.

Test Results:

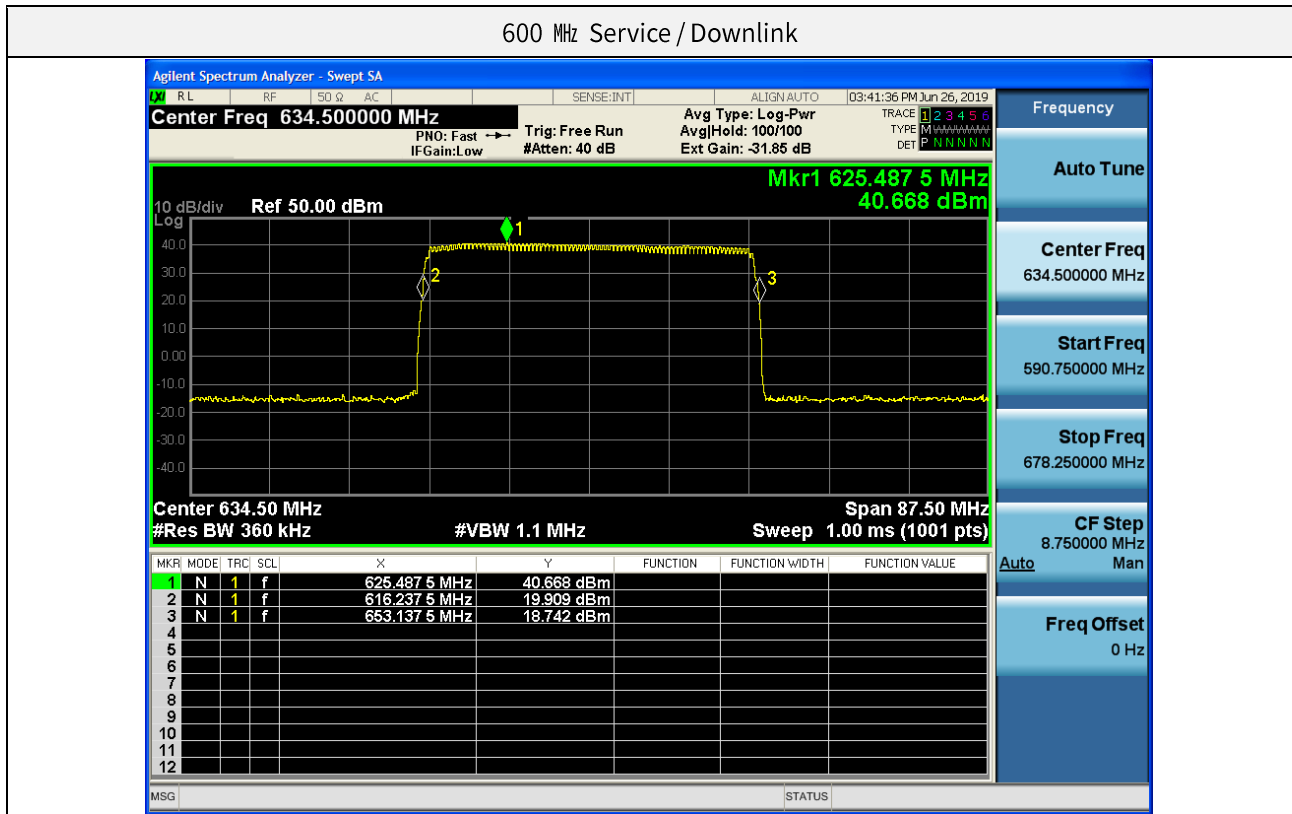

5.3. INPUT-VERSUS-OUTPUT SIGNAL COMPARISON

Test Requirement:

§ 2.1049 Measurements required: Occupied bandwidth.

The occupied bandwidth, that is the frequency bandwidth such that, below its lower and above its upper frequency limits, the mean powers radiated are each equal to 0.5 percent of the total mean power radiated by a given emission shall be measured under the specified conditions of § 2.1049 (a) through (i) as applicable.

Test Procedures:

Measurements were in accordance with the test methods section 3.4 of KDB 935210 D05 v01r03.

- a) Connect a signal generator to the input of the EUT.
- b) Configure the signal generator to transmit the AWGN signal.
- c) Configure the signal amplitude to be just below the AGC threshold level (see 3.2), but not more than 0.5 dB below.
- d) Connect a spectrum analyzer to the output of the EUT using appropriate attenuation.
- e) Set the spectrum analyzer center frequency to the center frequency of the operational band under test. The span range of the spectrum analyzer shall be between 2 times to 5 times the emission bandwidth (EBW) or alternatively, the OBW.
- f) The nominal RBW shall be in the range of 1 % to 5 % of the anticipated OBW, and the VBW shall be $\geq 3 \times \text{RBW}$.
- g) Set the reference level of the instrument as required to preclude the signal from exceeding the maximum spectrum analyzer input mixer level for linear operation. In general, the peak of the spectral envelope must be more than $[10 \log (\text{OBW} / \text{RBW})]$ below the reference level.
Steps f) and g) may require iteration to enable adjustments within the specified tolerances.
- h) The noise floor of the spectrum analyzer at the selected RBW shall be at least 36 dB below the reference level.
- i) Set spectrum analyzer detection function to positive peak.
- j) Set the trace mode to max hold.
- k) Determine the reference value: Allow the trace to stabilize. Set the spectrum analyzer marker to the highest amplitude level of the displayed trace (this is the reference value) and record the associated frequency.
- l) Place two markers, one at the lowest and the other at the highest frequency of the envelope of the spectral display, such that each marker is at or slightly below the -26 dB down amplitude. The 26 dB EBW (alternatively OBW) is the positive frequency difference between the two markers. If the spectral envelope crosses the -26 dB down amplitude at multiple points, the lowest or highest frequency shall be selected as the frequencies that are the furthest removed from the center frequency at which the spectral envelope crosses the -26 dB down amplitude point.
- m) Repeat steps e) to l) with the input signal connected directly to the spectrum analyzer (i.e., input signal measurement).
- n) Compare the spectral plot of the input signal (determined from step m) to the output signal (determined from step l) to affirm that they are similar (in passband and rolloff characteristic features and relative spectral

locations), and include plot(s) and descriptions in test report.

o) Repeat the procedure [steps e) to n)] with the input signal amplitude set to 3 dB above the AGC threshold.

p) Repeat steps e) to o) with the signal generator set to the narrowband signal.

q) Repeat steps e) to p) for all frequency bands authorized for use by the EUT.

Test Results:
Tabular data of Output Occupied Bandwidth

Test Band	Link	Signal	Center Frequency (MHz)	99 % OBW (MHz)	26 dB OBW (MHz)
600 MHz Service	Downlink	LTE 5 MHz	634.50	4.5220	5.027
		LTE 10 MHz	634.50	9.0224	10.028
		LTE 20 MHz	634.50	17.9949	20.011

Tabular data of Input Occupied Bandwidth

Test Band	Link	Signal	Center Frequency (MHz)	99 % OBW (MHz)	26 dB OBW (MHz)
600 MHz Service	Downlink	LTE 5 MHz	634.50	4.5145	5.052
		LTE 10 MHz	634.50	9.0023	10.002
		LTE 20 MHz	634.50	18.0178	19.949

Tabular data of 3 dB above the AGC threshold Output Occupied Bandwidth

Test Band	Link	Signal	Center Frequency (MHz)	99 % OBW (MHz)	26 dB OBW (MHz)
600 MHz Service	Downlink	LTE 5 MHz	634.50	4.5220	5.051
		LTE 10 MHz	634.50	9.0211	10.005
		LTE 20 MHz	634.50	18.0185	20.082

Measured Occupied Bandwidth Comparison

Test Band	Link	Signal	Variant of Input and output Occupied Bandwidth (%)	Variant of Input and 3 dB above the AGC threshold output Occupied Bandwidth (%)
600 MHz Service	Downlink	LTE 5 MHz	-0.495	-0.020
		LTE 10 MHz	0.260	0.030
		LTE 20 MHz	0.311	0.667

* Change in input-output OBW is less than $\pm 5\%$.

Plot data of Occupied Bandwidth

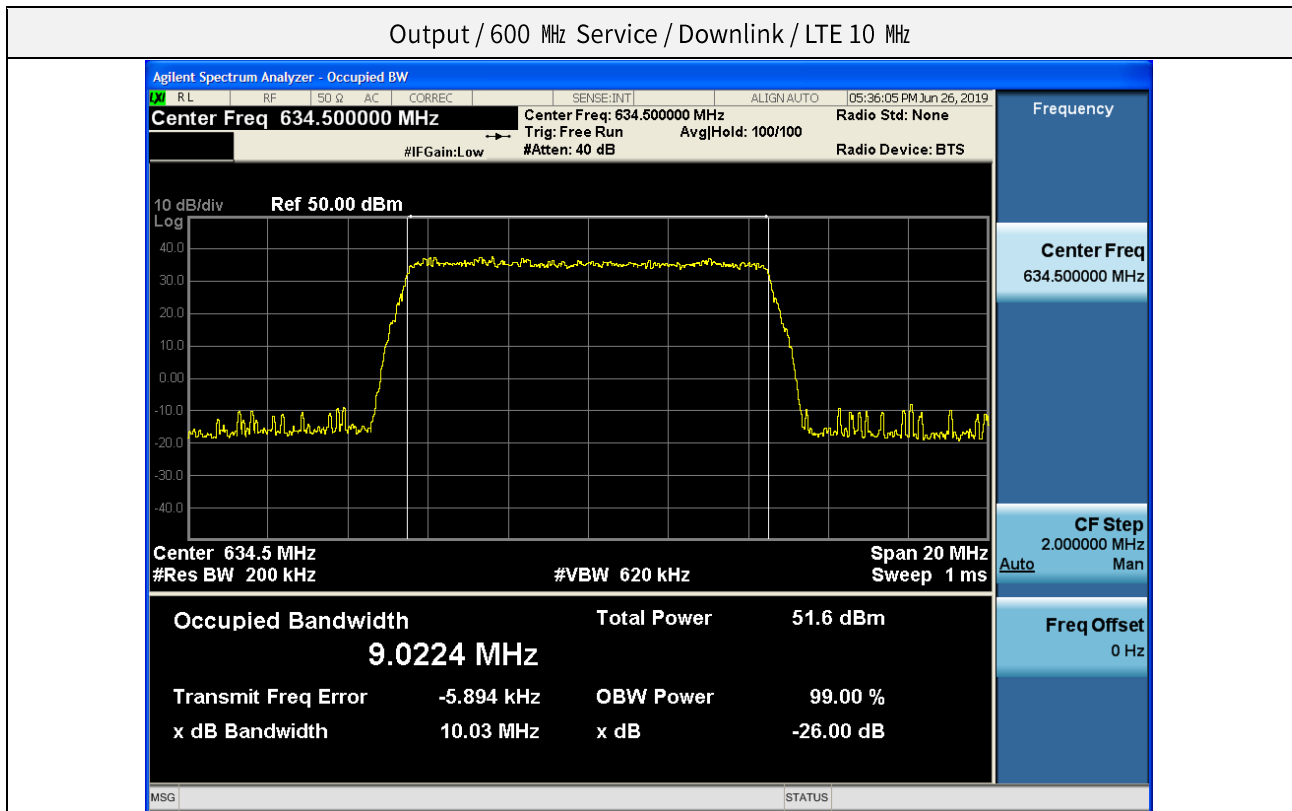
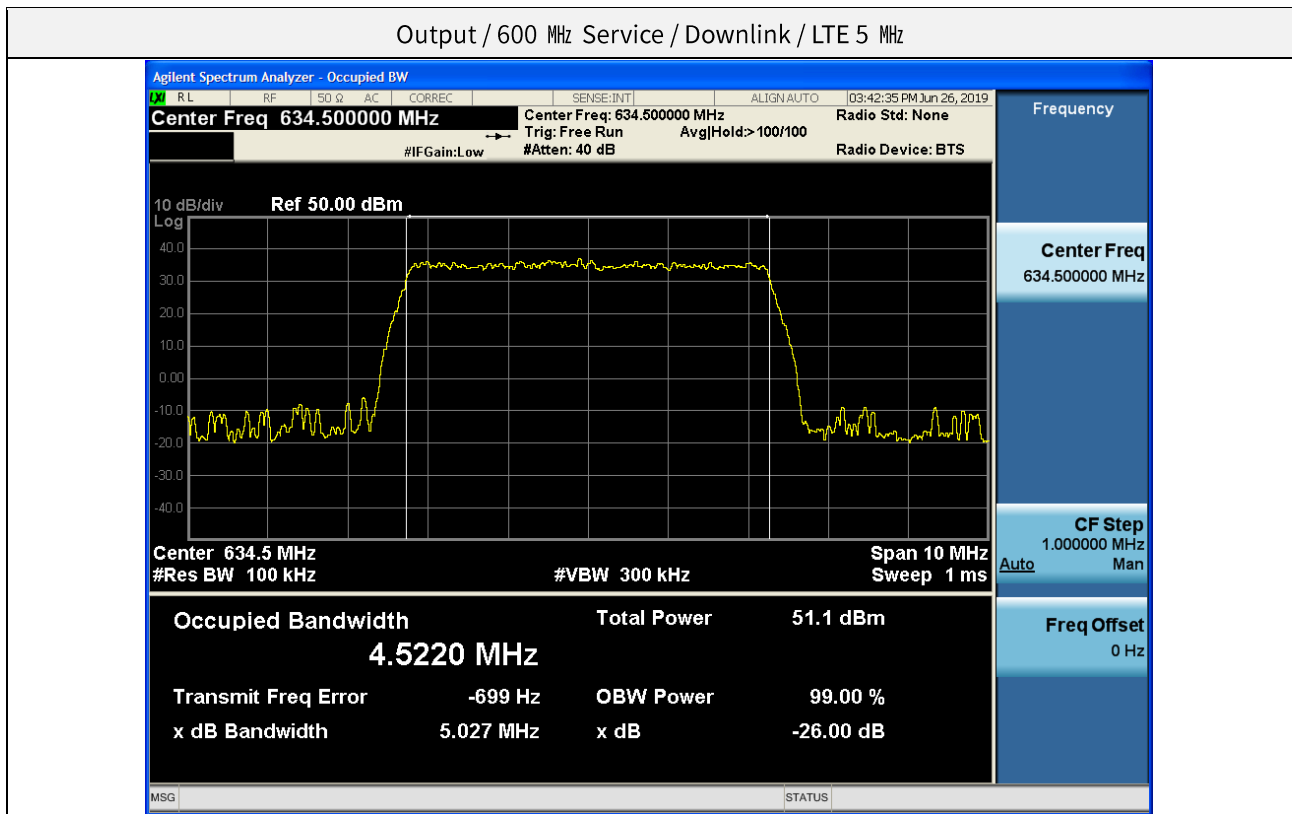

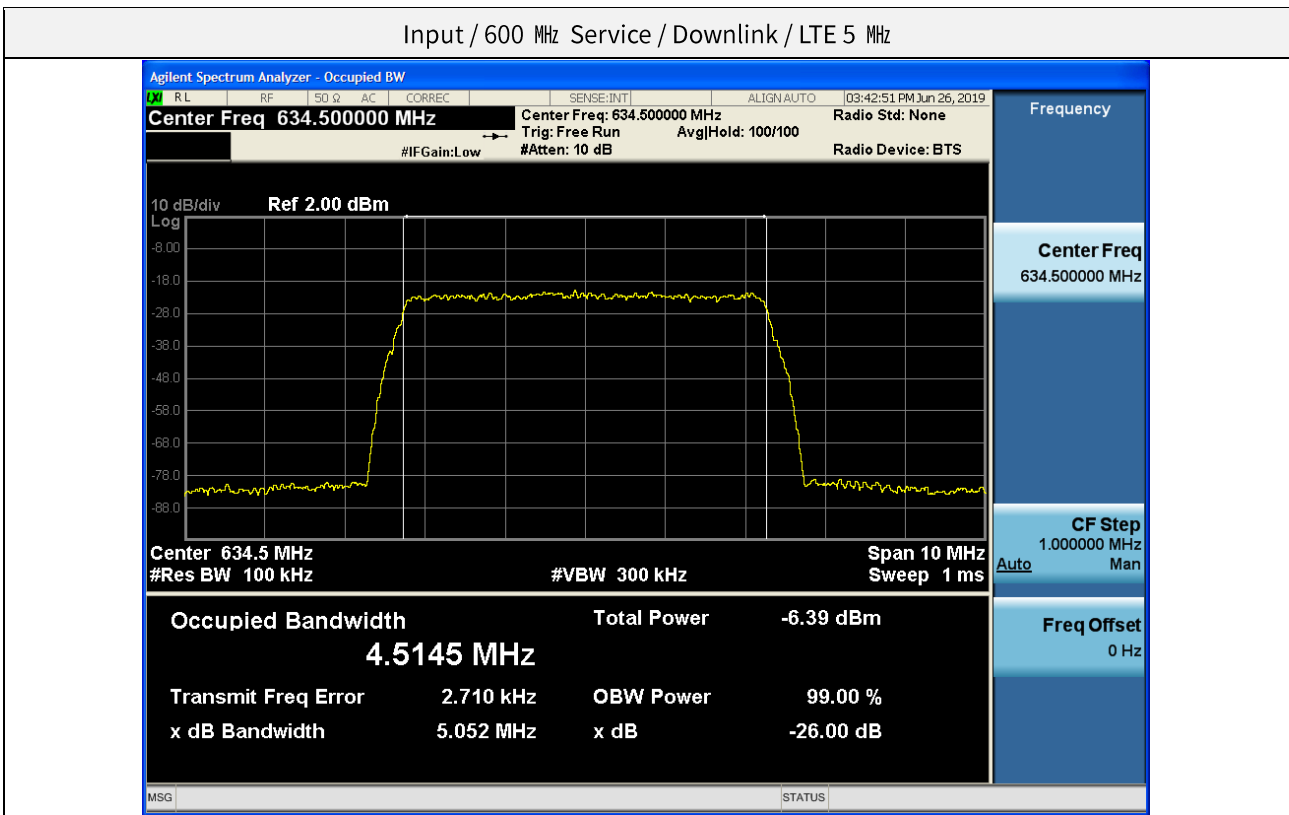
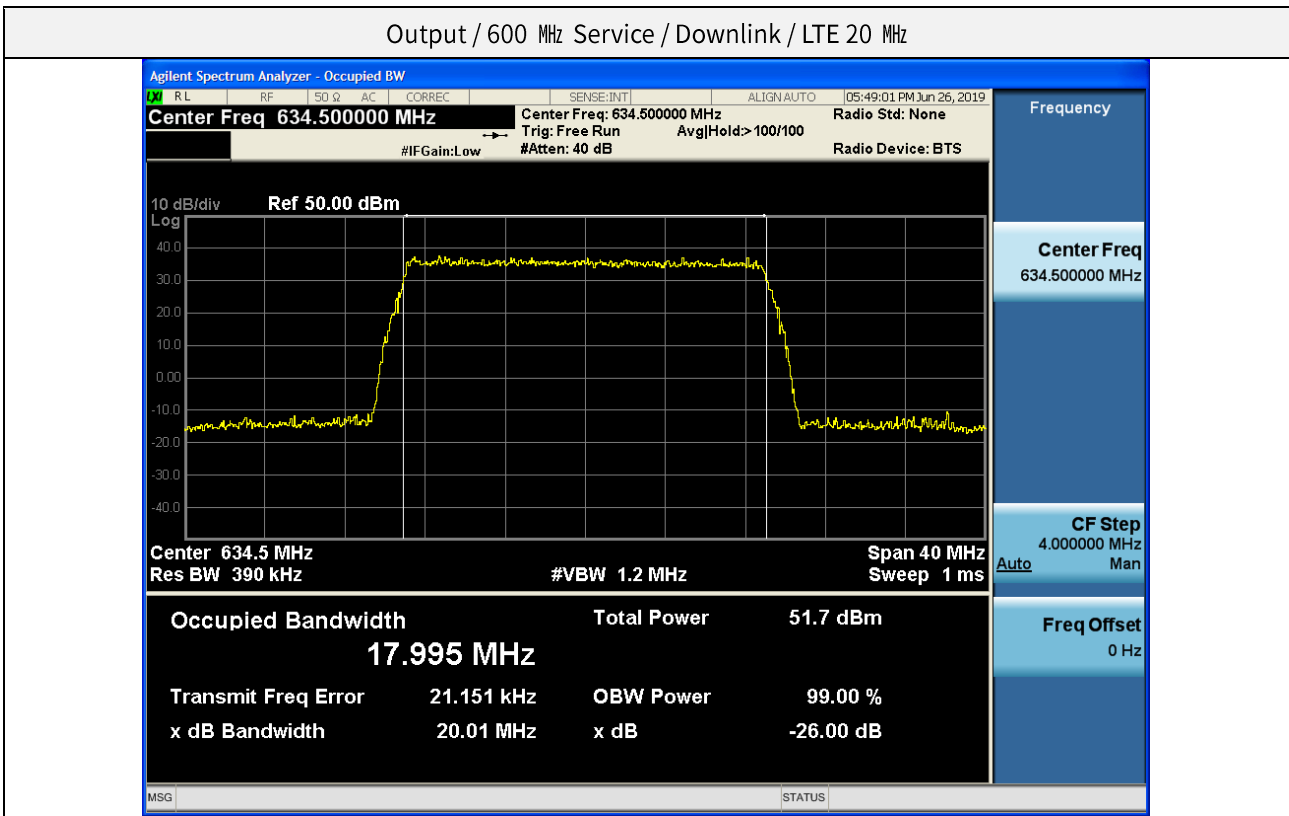

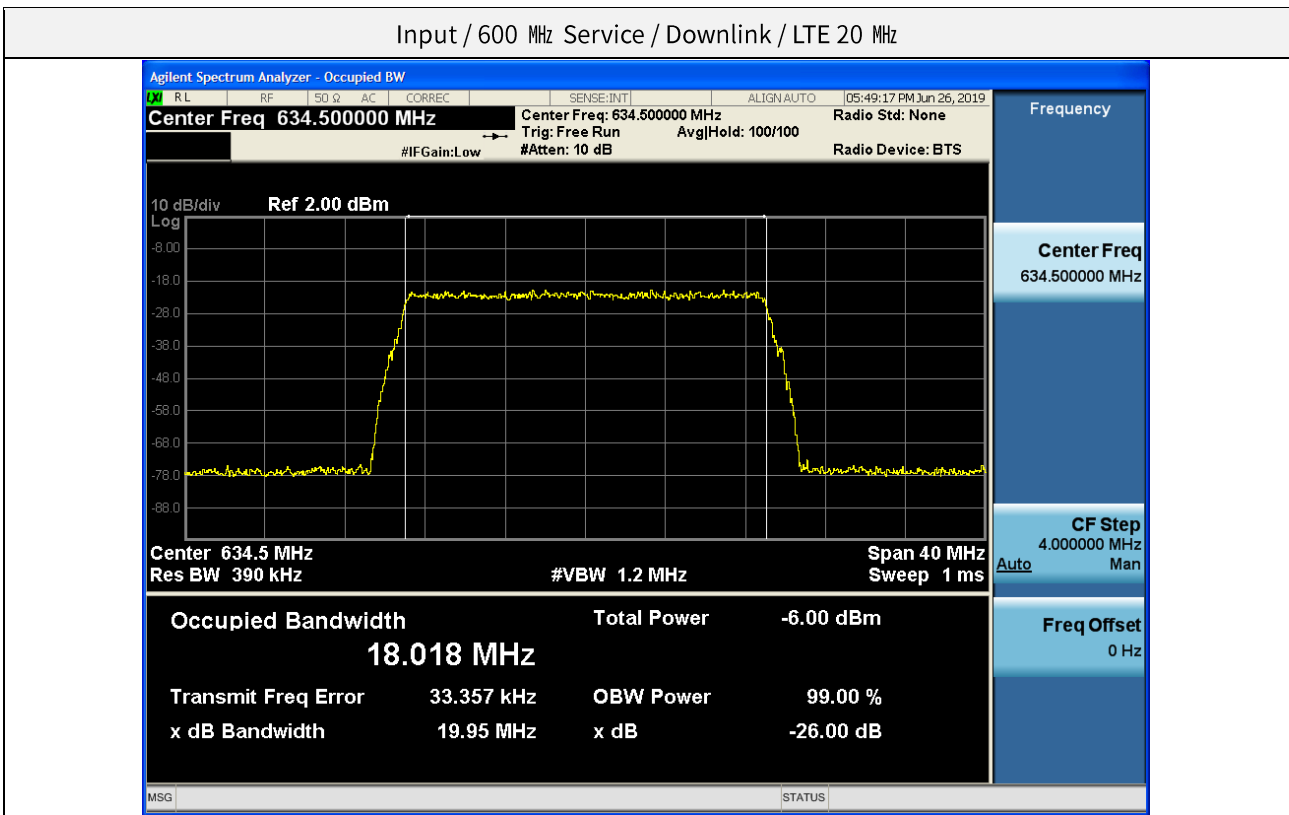
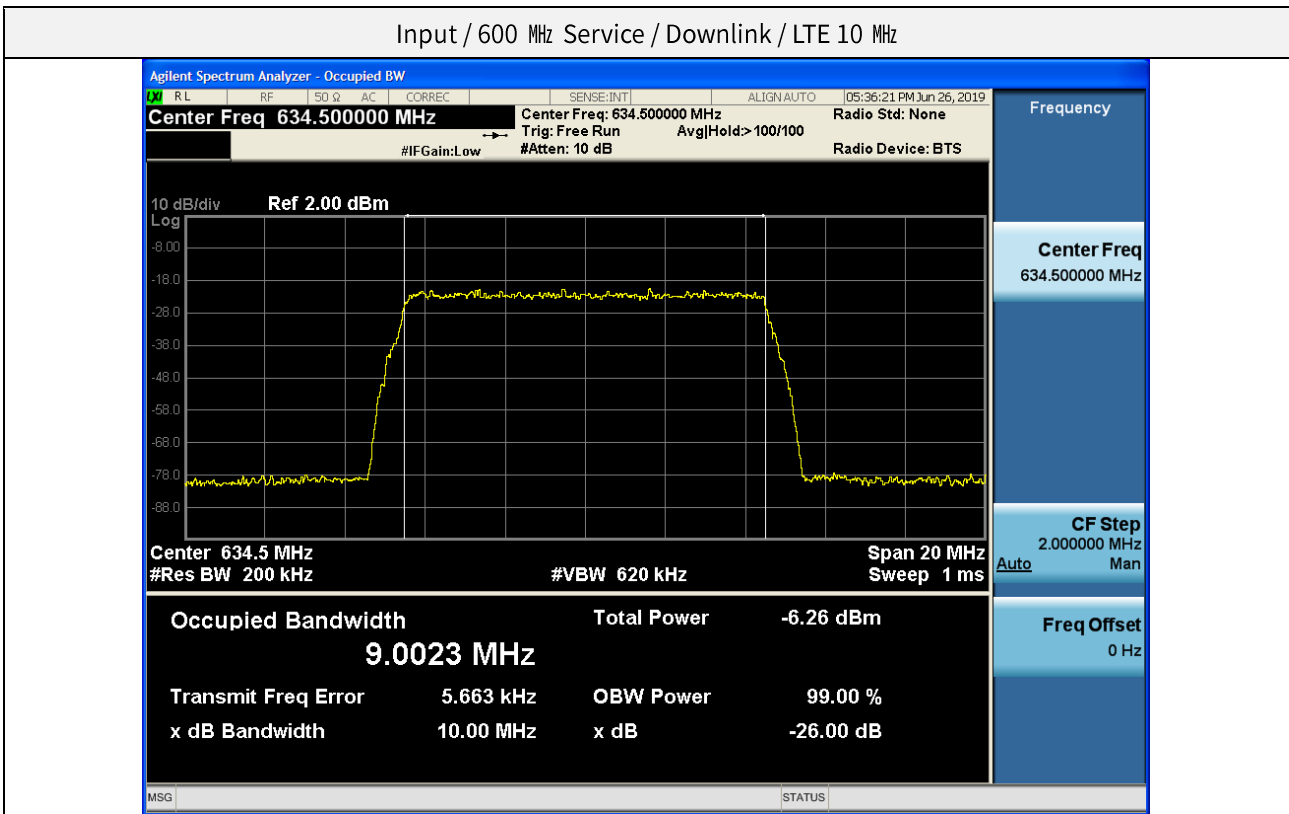

3 dB above the AGC threshold output / 600 MHz Service / Downlink / LTE 5 MHz

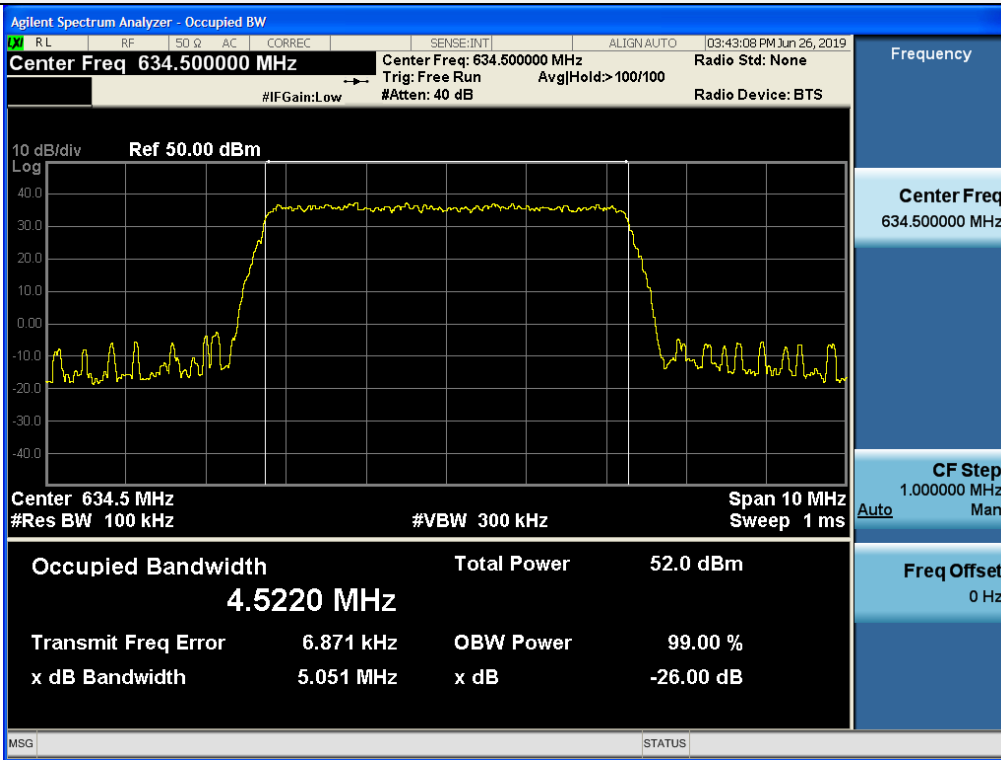

3 dB above the AGC threshold output / 600 MHz Service / Downlink / LTE 10 MHz

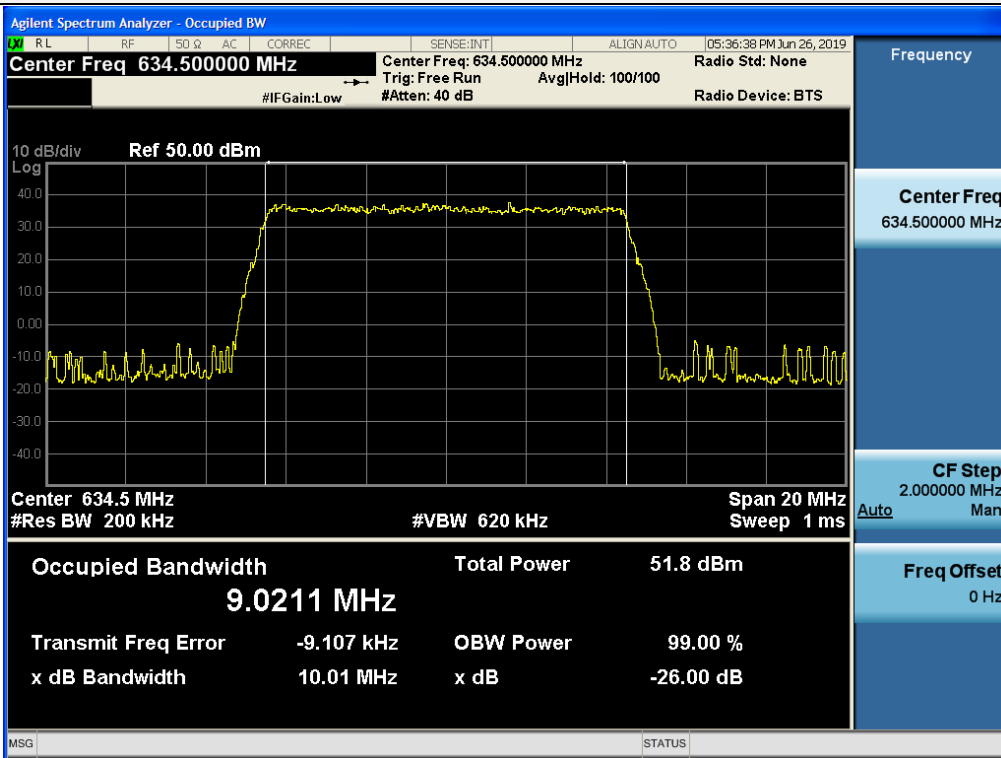

3 dB above the AGC threshold output / 600 MHz Service / Downlink / LTE 20 MHz

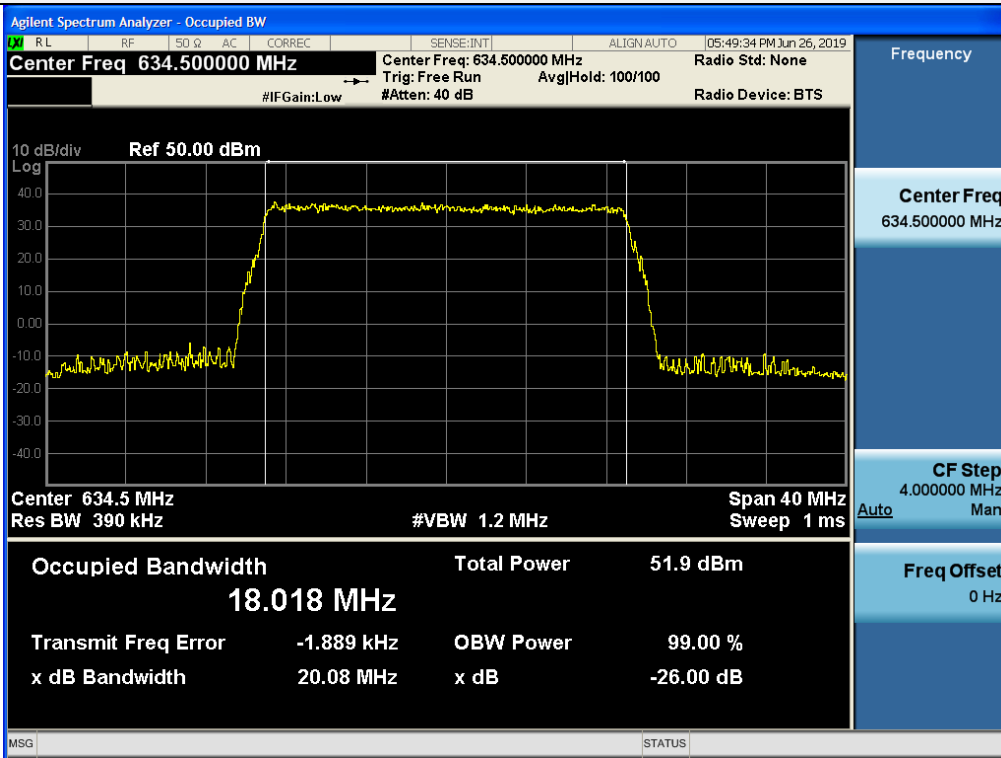

5.4. INPUT/OUTPUT POWER AND AMPLIFIER/BOOSTER GAIN

Test Requirement:

§ 2.1046 Measurements required: RF power output.

(a) For transmitters other than single sideband, independent sideband and controlled carrier radiotelephone, power output shall be measured at the RF output terminals when the transmitter is adjusted in accordance with the tune-up procedure to give the values of current and voltage on the circuit elements specified in § 2.1033(c)(8). The electrical characteristics of the radio frequency load attached to the output terminals when this test is made shall be stated.

(b) For single sideband, independent sideband, and single channel, controlled carrier radiotelephone transmitters the procedure specified in paragraph (a) of this section shall be employed and, in addition, the transmitter shall be modulated during the test as specified and applicable in § 2.1046 (b) (1-5). In all tests, the input level of the modulating signal shall be such as to develop rated peak envelope power or carrier power, as appropriate, for the transmitter.

(c) For measurements conducted pursuant to paragraphs (a) and (b) of this section, all calculations and methods used by the applicant for determining carrier power or peak envelope power, as appropriate, on the basis of measured power in the radio frequency load attached to the transmitter output terminals shall be shown. Under the test conditions specified, no components of the emission spectrum shall exceed the limits specified in the applicable rule parts as necessary for meeting occupied bandwidth or emission limitations.

§ 27.50 Power limits and duty cycle.

(c) The following power and antenna height requirements apply to stations transmitting in the 600 MHz band and the

698-746 MHz band:

(3) Fixed and base stations transmitting a signal with an emission bandwidth greater than 1 MHz must not exceed an ERP of 1000 watts/MHz and an antenna height of 305 m HAAT, except that antenna heights greater than 305 m HAAT are permitted if power levels are reduced below 1000 watts/MHz ERP in accordance with Table 3 of this section;

TABLE 3 TO §27.50—PERMISSIBLE POWER AND ANTENNA HEIGHTS FOR BASE AND FIXED STATIONS IN THE 600 MHz, 698-757 MHz, 758-763 MHz, 776-787 MHz AND 788-793 MHz BANDS TRANSMITTING A SIGNAL WITH AN EMISSION BANDWIDTH GREATER THAN 1 MHz

Antenna height (AAT) in meters (feet)	Effective radiated power (ERP) per MHz (watts/MHz)
Above 1372 (4500)	65
Above 1220 (4000) To 1372 (4500)	70
Above 1067 (3500) To 1220 (4000)	75
Above 915 (3000) To 1067 (3500)	100
Above 763 (2500) To 915 (3000)	140
Above 610 (2000) To 763 (2500)	200
Above 458 (1500) To 610 (2000)	350
Above 305 (1000) To 458 (1500)	600
Up to 305 (1000)	1000

Test Procedures:

Measurements were in accordance with the test methods section 3.5 of KDB 935210 D05 v01r03.

Adjust the internal gain control of the EUT to the maximum gain for which the equipment certification is being sought. Any EUT attenuation settings shall be set to their minimum value.

Input power levels (uplink and downlink) should be set to maximum input ratings while confirming that the device is not capable of operating in saturation (non-linear mode) at the rated input levels, including during the performance of the input/output power measurements.

3.5.2 Measuring the EUT mean input and output power

- a) Connect a signal generator to the input of the EUT.
- b) Configure to generate the test signal.
- c) The frequency of the signal generator shall be set to the frequency f_0 as determined from out-of-band rejection test.
- d) Connect a spectrum analyzer or power meter to the output of the EUT using appropriate attenuation as necessary.
- e) Set the signal generator output power to a level that produces an EUT output level that is just below the AGC threshold, but not more than 0.5 dB below.
- f) Measure and record the output power of the EUT; use ANSI C63.26-2015 subclause 5.2.4.4.1, for power measurement.
- g) Remove the EUT from the measurement setup. Using the same signal generator settings, repeat the power measurement at the signal generator port, which was used as the input signal to the EUT, and record as the input power. EUT gain may be calculated as described in 3.5.5.
- h) Repeat steps f) and g) with input signal amplitude set to 3 dB above the AGC threshold level.
- i) Repeat steps e) to h) with the narrowband test signal.
- j) Repeat steps e) to i) for all frequency bands authorized for use by the EUT.

3.5.5 Calculating amplifier, repeater, or industrial booster gain

After the input and output power levels have been measured as described in the preceding subclauses, the gain of the EUT can be determined from:

$$\text{Gain (dB)} = \text{output power (dBm)} - \text{input power (dBm)}.$$

Report the gain for each authorized operating frequency band, and each test signal stimulus.

Note1. *If f_0 that determined from out-of-band test is smaller or greater than difference of test signal's center frequency and operation band block, test is performed at the lowest or the highest frequency that test signals can be passed.*

Test Results:

Tabular data of Input / Output Power and Gain

Test Band	Link	Signal	f ₀ Frequency (MHz)	Input Power (dBm)	Output Power (dBm)	Gain (dB)
600 MHz Service	Downlink	LTE 5 MHz	625.49	-14.74	43.38	58.12
		LTE 10 MHz	625.49	-14.98	43.37	58.35
		LTE 20 MHz	627.00	-14.82	43.11	57.93

Tabular data of Input / 3 dB above AGC threshold Output Power and Gain

Test Band	Link	Signal	f ₀ Frequency (MHz)	Input Power (dBm)	Output Power (dBm)	Gain (dB)
600 MHz Service	Downlink	LTE 5 MHz	625.49	-14.74	43.28	58.02
		LTE 10 MHz	625.49	-14.98	43.10	58.08
		LTE 20 MHz	627.00	-14.82	43.42	58.24

5.5. OUT-OF-BAND/OUT-OF-BLOCK EMISSIONS AND SPURIOUS EMISSIONS

Test Requirements:

§ 2.1051 Measurements required: Spurious emissions at antenna terminals.

The radio frequency voltage or powers generated within the equipment and appearing on a spurious frequency shall be checked at the equipment output terminals when properly loaded with a suitable artificial antenna. Curves or equivalent data shall show the magnitude of each harmonic and other spurious emission that can be detected when the equipment is operated under the conditions specified in § 2.1049 as appropriate. The magnitude of spurious emissions which are attenuated more than 20 dB below the permissible value need not be specified.

§ 27.53 Emission limits.

(g) For operations in the 600 MHz band and the 698-746 MHz band, the power of any emission outside a licensee's frequency band(s) of operation shall be attenuated below the transmitter power (P) within the licensed band(s) of operation, measured in watts, by at least $43 + 10 \log (P)$ dB. Compliance with this provision is based on the use of measurement instrumentation employing a resolution bandwidth of 100 kilohertz or greater. However, in the 100 kilohertz bands immediately outside and adjacent to a licensee's frequency block, a resolution bandwidth of at least 30 kHz may be employed.

Test Procedures:

Measurements were in accordance with the test methods section 3.6 of KDB 935210 D05 v01r03.

Spurious emissions shall be measured using a single test signal sequentially tuned to the low, middle, and high channels or frequencies within each authorized frequency band of operation.

Out-of-band/out-of-block emissions (including intermodulation products) shall be measured under each of the following two stimulus conditions:

- a) two adjacent test signals sequentially tuned to the lower and upper frequency band/block edges;*
- b) a single test signal, sequentially tuned to the lowest and highest frequencies or channels within the frequency band/block under examination.*

NOTE—Single-channel boosters that cannot accommodate two simultaneous signals within the passband may be excluded from the test stipulated in step a).

3.6.2 Out-of-band/out-of-block emissions conducted measurements

- a) Connect a signal generator to the input of the EUT.

If the signal generator is not capable of generating two modulated carriers simultaneously, then two discrete signal generators can be connected with an appropriate combining network to support this two-signal test.

- b) Set the signal generator to produce two AWGN signals as previously described.
- c) Set the center frequencies such that the AWGN signals occupy adjacent channels, as defined by industry standards such as 3GPP or 3GPP2, at the upper edge of the frequency band or block under test.

- d) Set the composite power levels such that the input signal is just below the AGC threshold, but not more than 0.5 dB below. The composite power can be measured using the procedures provided in KDB Publication 971168, but it will be necessary to expand the power integration bandwidth so as to include both of the transmit channels.
- e) Connect a spectrum analyzer to the output of the EUT using appropriate attenuation as necessary.
- f) Set the RBW = reference bandwidth in the applicable rule section for the supported frequency band.
- g) Set the VBW = $3 \times$ RBW.
- h) Set the detector to power averaging (rms) detector.
- i) Set the Sweep time = auto-couple.

- j) Set the spectrum analyzer start frequency to the upper block edge frequency, and the stop frequency to the upper block edge frequency plus 300 kHz or 3 MHz, for frequencies below and above 1 GHz, respectively.
- k) Trace average at least 100 traces in power averaging (rms) mode.
- l) Use the marker function to find the maximum power level.
- m) Capture the spectrum analyzer trace of the power level for inclusion in the test report.
- n) Repeat steps k) to m) with the composite input power level set to 3 dB above the AGC threshold.
- o) Reset the frequencies of the input signals to the lower edge of the frequency block or band under test.
- p) Reset the spectrum analyzer start frequency to the lower block edge frequency minus 300 kHz or 3 MHz, for frequencies below and above 1 GHz, respectively, and the stop frequency to the lower band or block edge frequency.
- q) Repeat steps k) to n).
- r) Repeat steps a) to q) with the signal generator configured for a single test signal tuned as close as possible to the block edges.

- s) Repeat steps a) to r) with the narrowband test signal.
- t) Repeat steps a) to s) for all authorized frequency bands or blocks used by the EUT.

3.6.3 Spurious emissions conducted measurements

- a) Connect a signal generator to the input of the EUT.
- b) Set the signal generator to produce the broadband test signal as previously described.
- c) Set the center frequency of the test signal to the lowest available channel within the frequency band or block.
- d) Set the EUT input power to a level that is just below the AGC threshold, but not more than 0.5 dB below.
- e) Connect a spectrum analyzer to the output of the EUT using appropriate attenuation as necessary.
- f) Set the RBW = reference bandwidth in the applicable rule section for the supported frequency band of operation.
- g) Set the VBW $\geq 3 \times$ RBW.
- h) Set the Sweep time = auto-couple.

i) Set the spectrum analyzer start frequency to the lowest RF signal generated in the equipment, without going below 9 kHz, and the stop frequency to the lower band/block edge frequency minus 100 kHz or 1 MHz, as specified in the applicable rule part.

The number of measurement points in each sweep must be $\geq (2 \times \text{span}/\text{RBW})$, which may require that the measurement range defined by the start and stop frequencies be subdivided, depending on the available number of measurement points provided by the spectrum analyzer.

j) Select the power averaging (rms) detector function.

k) Trace average at least 10 traces in power averaging (rms) mode.

l) Use the peak marker function to identify the highest amplitude level over each measured frequency range.

Record the frequency and amplitude and capture a plot for inclusion in the test report.

m) Reset the spectrum analyzer start frequency to the upper band/block edge frequency plus 100 kHz or 1 MHz, as specified in the applicable rule part, and the spectrum analyzer stop frequency to 10 times the highest frequency of the fundamental emission. The number of measurement points in each sweep must be $\geq (2 \times \text{span}/\text{RBW})$, which may require that the measurement range defined by the start and stop frequencies be subdivided, depending on the available number of measurement points provided by the spectrum analyzer.

n) Trace average at least 10 traces in power averaging (rms) mode.

o) Use the peak marker function to identify the highest amplitude level over each of the measured frequency ranges. Record the frequency and amplitude and capture a plot for inclusion in the test report; also provide tabular data, if

required.

p) Repeat steps i) to o) with the input test signals firstly tuned to a middle band/block frequency/channel, and then tuned to a high band/block frequency/channel.

q) Repeat steps b) to p) with the narrowband test signal.

r) Repeat steps b) to q) for all authorized frequency bands/blocks used by the EUT.

Note: In 9 kHz-150 kHz and 150 kHz-30 MHz bands, RBW was reduced to 0.1 % and 1 % of the reference bandwidth for measuring unwanted emission level (typically, 1 MHz if the authorized frequency band is above 1 GHz) and power was integrated. (1% = +30 dB, 10% = +20 dB)

Test Results: Plot data of Out-of-band/out-of-block emissions

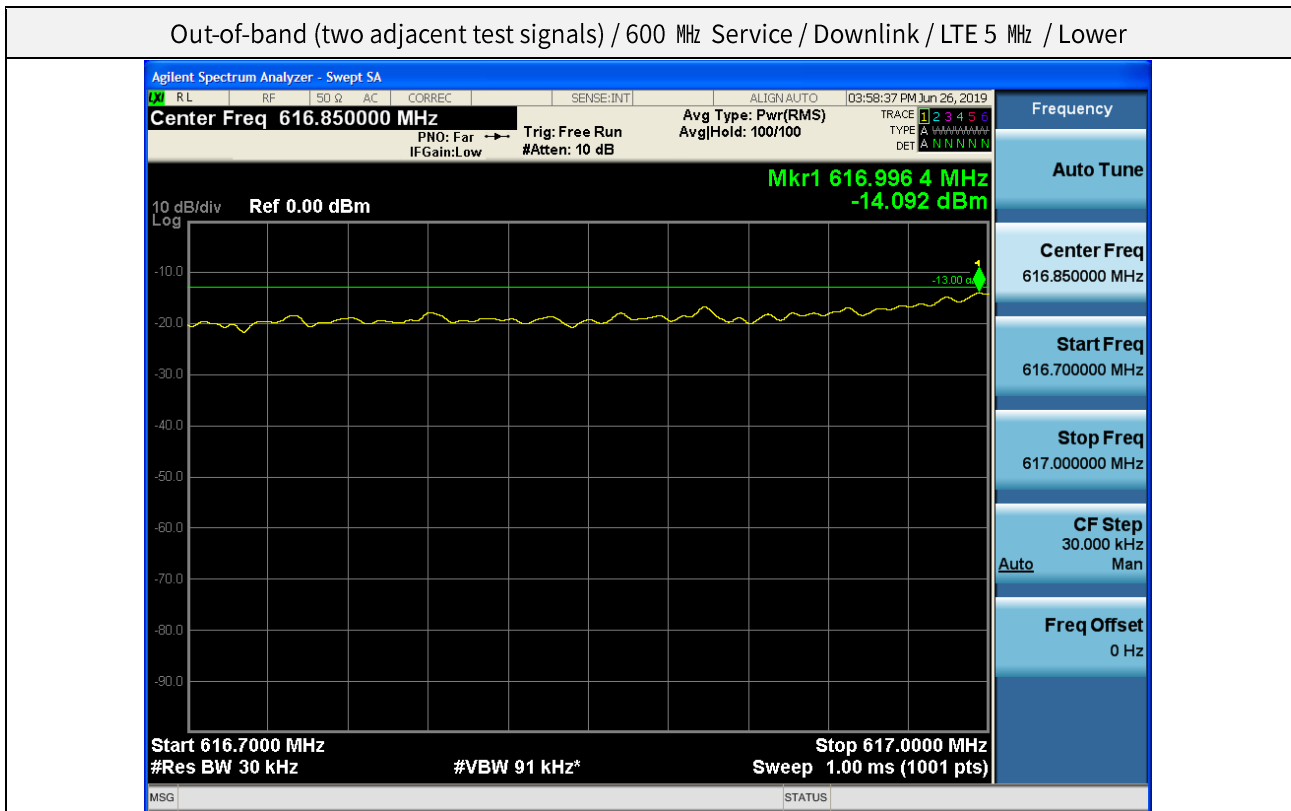
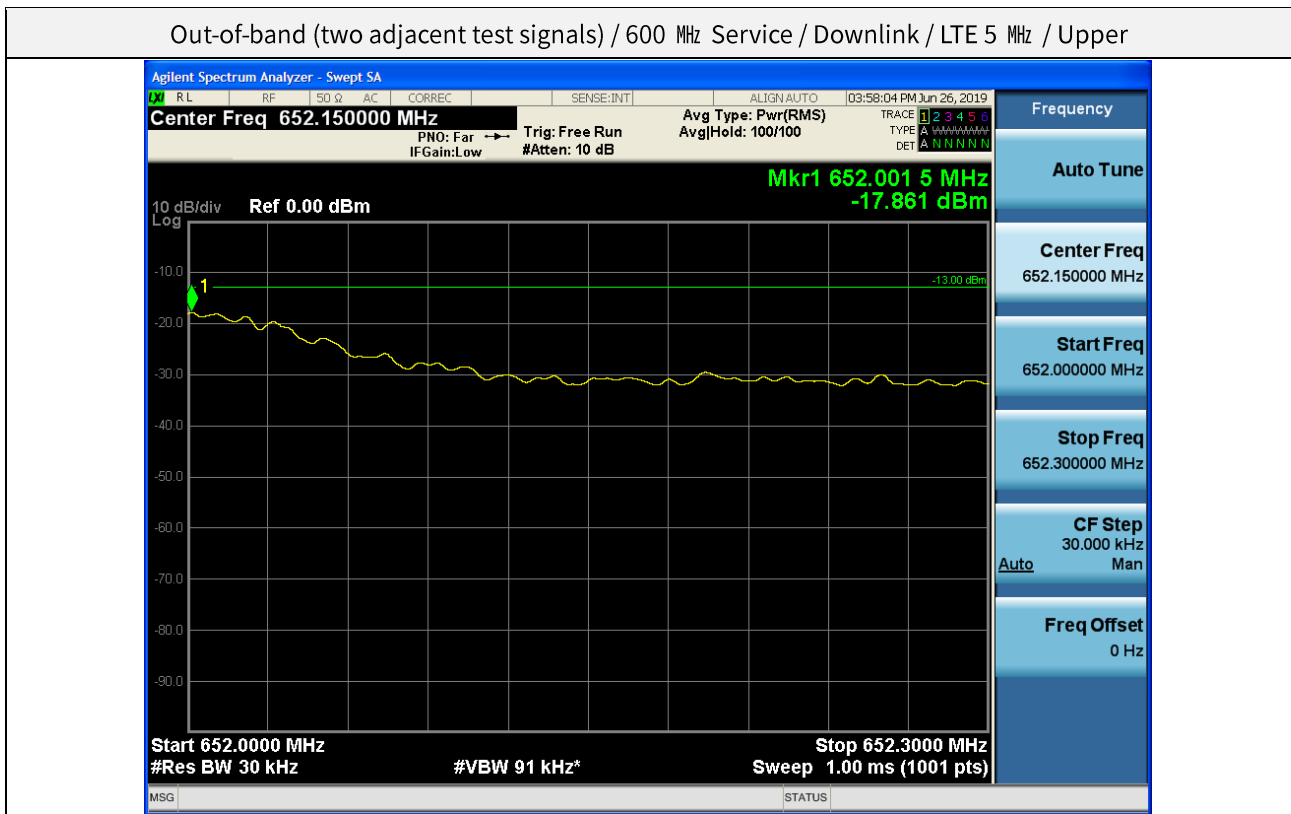

Out-of-band (two adjacent test signals) / 600 MHz Service / Downlink / LTE 10 MHz / Upper

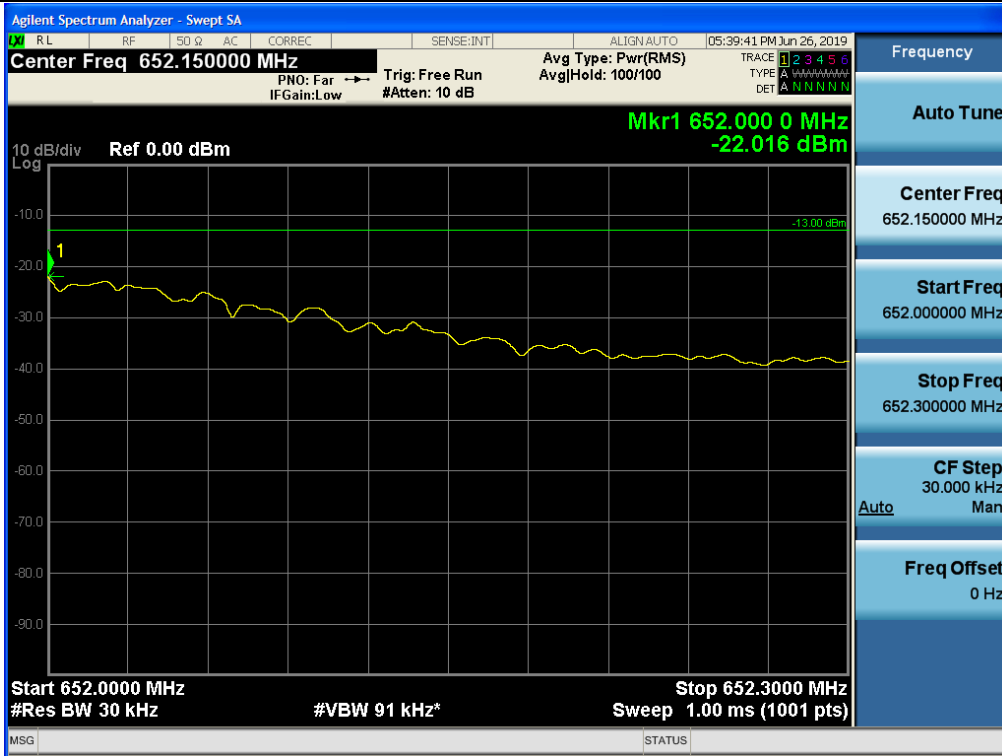

Out-of-band (two adjacent test signals) / 600 MHz Service / Downlink / LTE 10 MHz / Lower

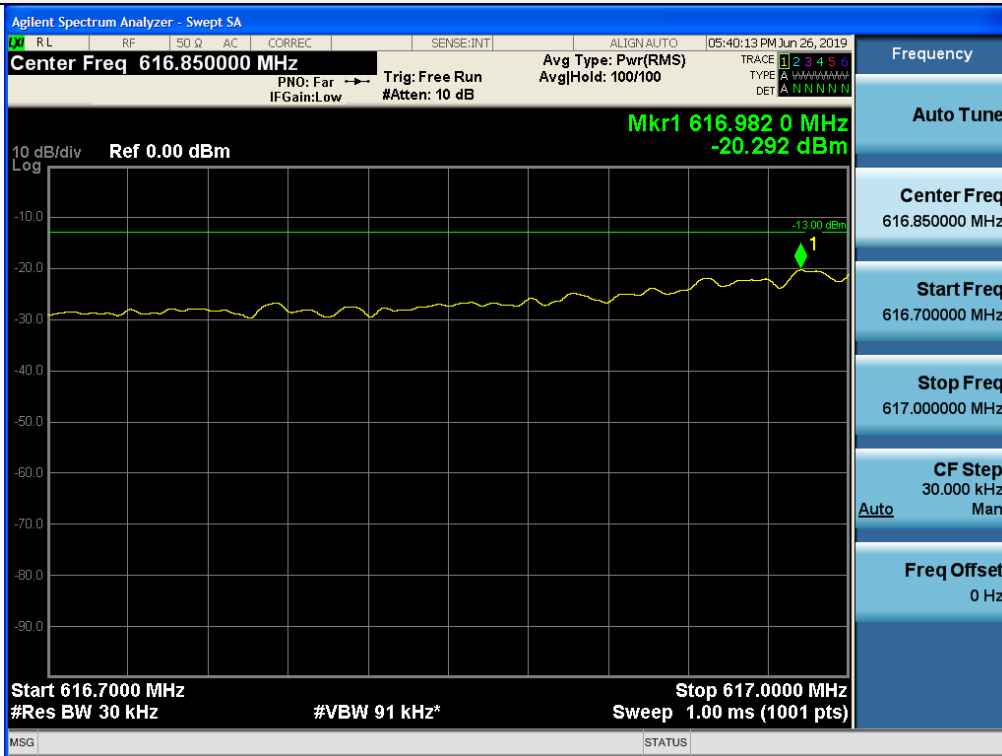

Out-of-band (two adjacent test signals) / 600 MHz Service / Downlink / LTE 20 MHz / Upper

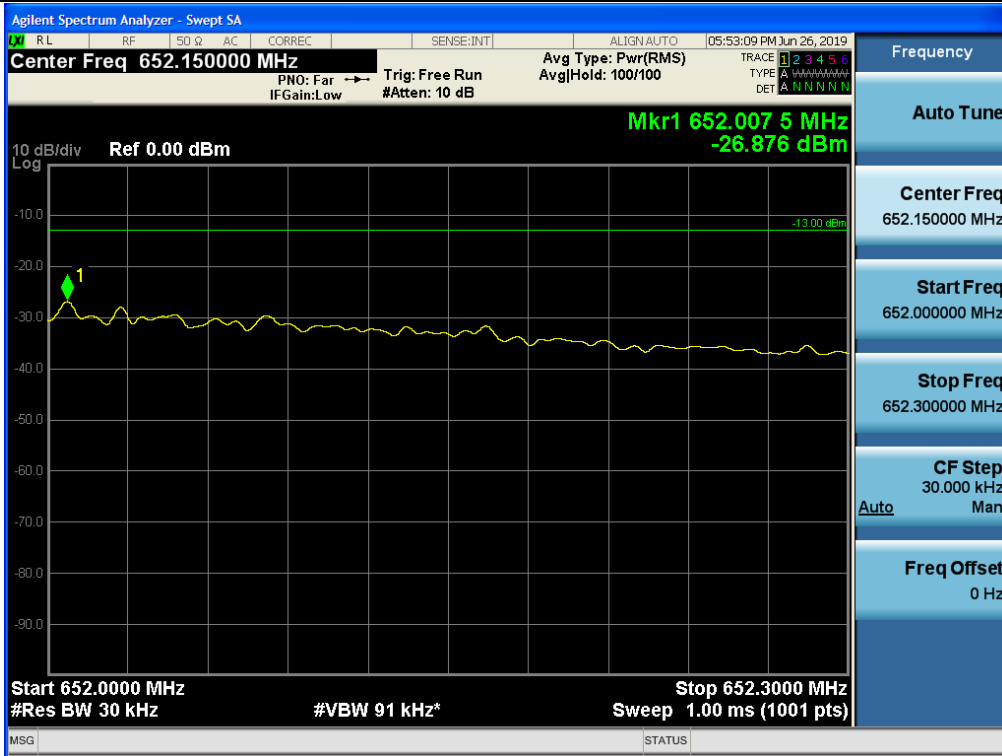

Out-of-band (two adjacent test signals) / 600 MHz Service / Downlink / LTE 20 MHz / Lower

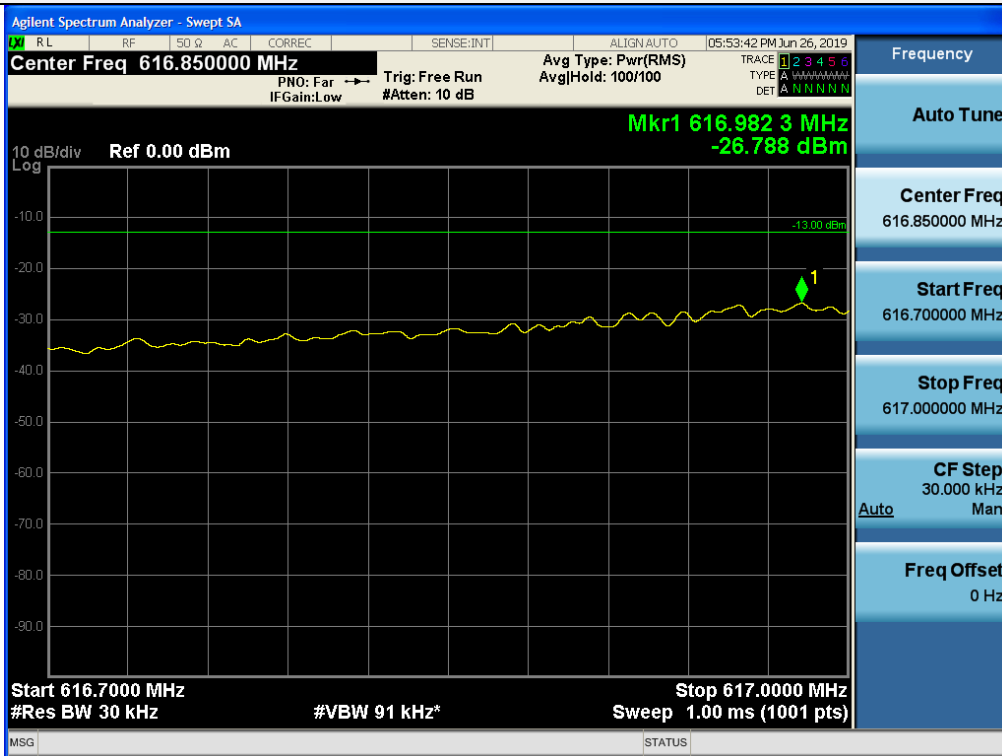

+3 dB above Out-of-band (two adjacent test signals) / 600 MHz Service / Downlink / LTE 5 MHz / Upper

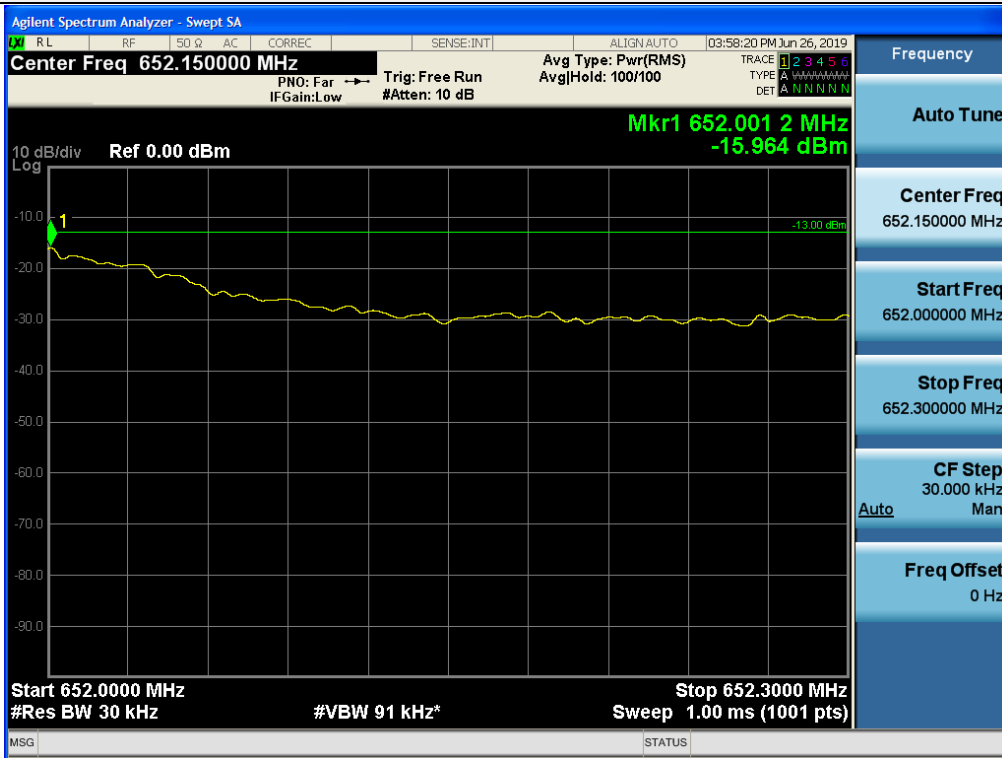

+3 dB above Out-of-band (two adjacent test signals) / 600 MHz Service / Downlink / LTE 5 MHz / Lower

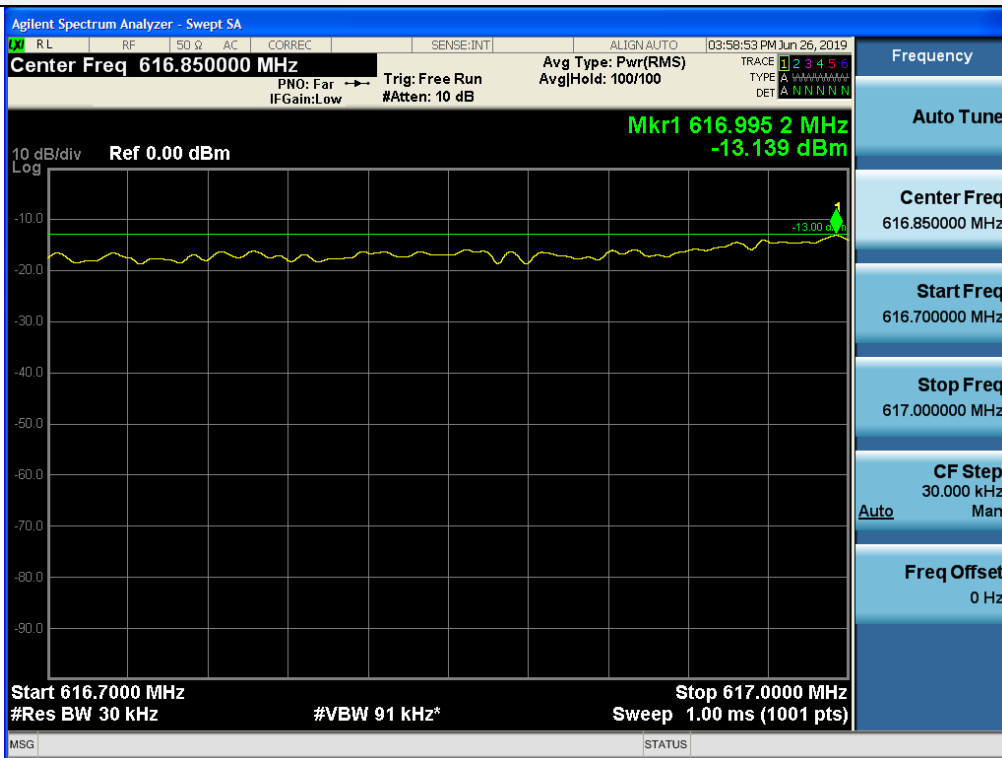

+3 dB above Out-of-band (two adjacent test signals) / 600 MHz Service / Downlink / LTE 10 MHz / Upper

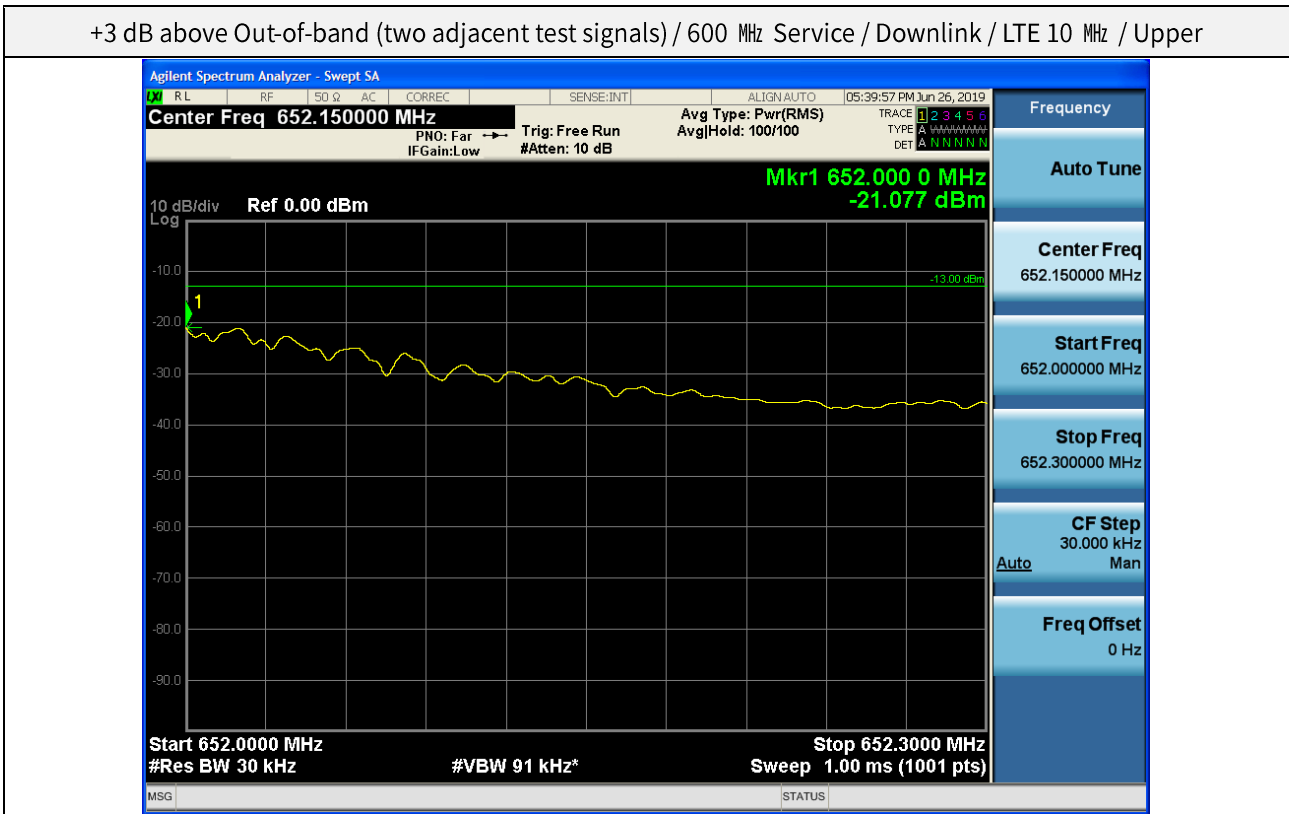

+3 dB above Out-of-band (two adjacent test signals) / 600 MHz Service / Downlink / LTE 10 MHz / Lower

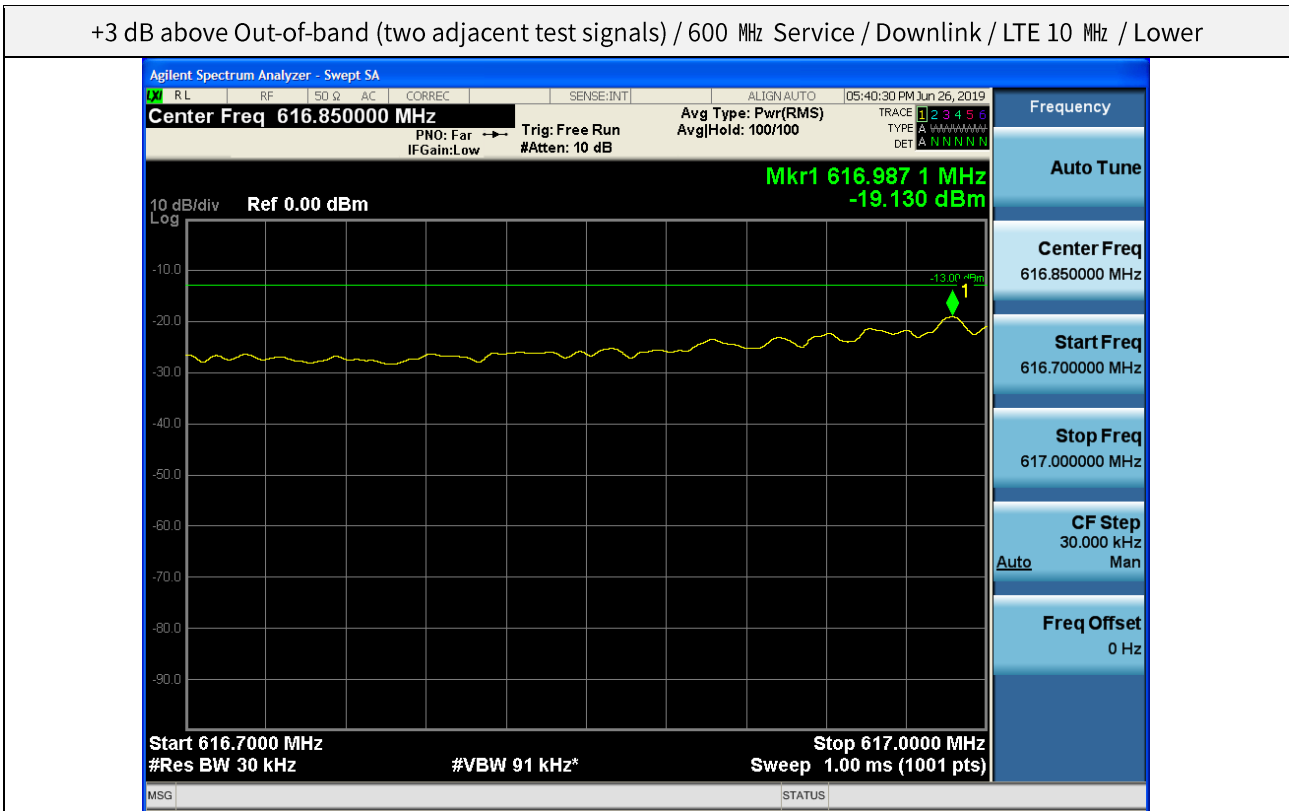

+3 dB above Out-of-band (two adjacent test signals) / 600 MHz Service / Downlink / LTE 20 MHz / Upper

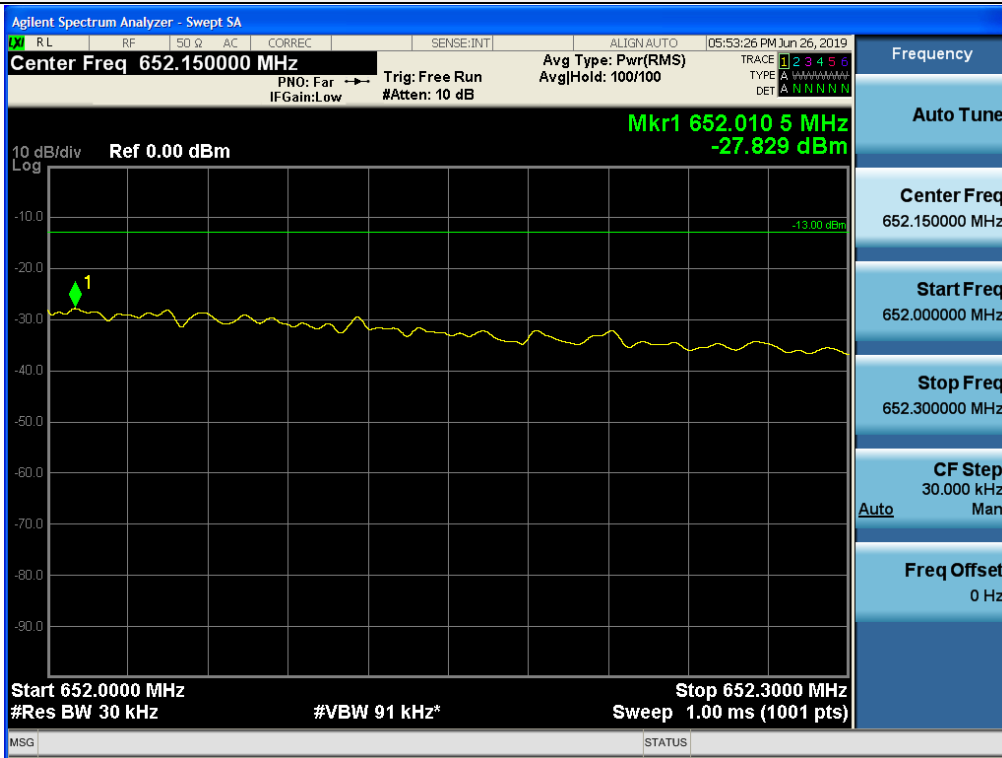

+3 dB above Out-of-band (two adjacent test signals) / 600 MHz Service / Downlink / LTE 20 MHz / Lower

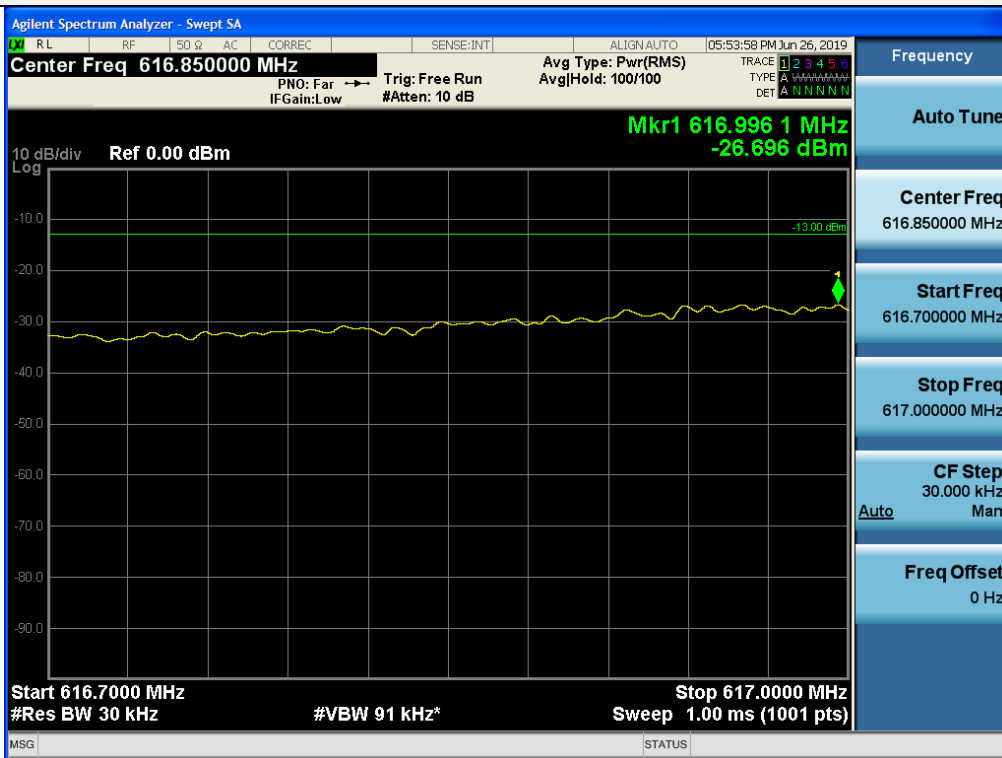

Out-of-band (single test signal) / 600 MHz Service / Downlink / LTE 5 MHz / Upper



Out-of-band (single test signal) / 600 MHz Service / Downlink / LTE 5 MHz / Lower

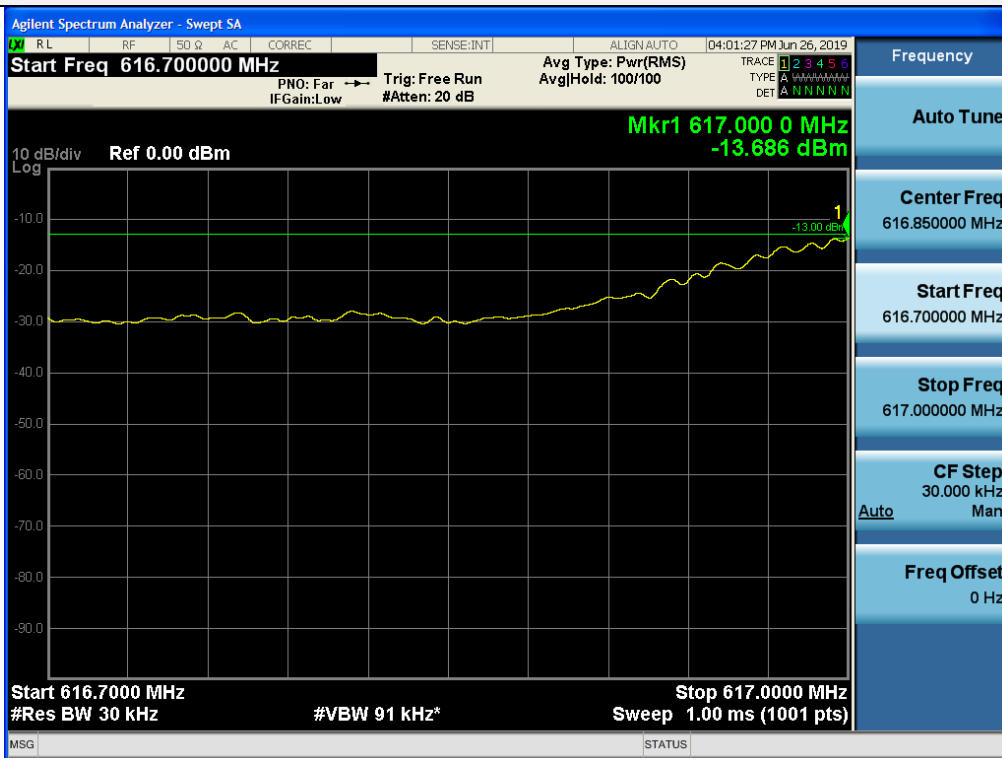

Out-of-band (single test signal) / 600 MHz Service / Downlink / LTE 10 MHz / Upper

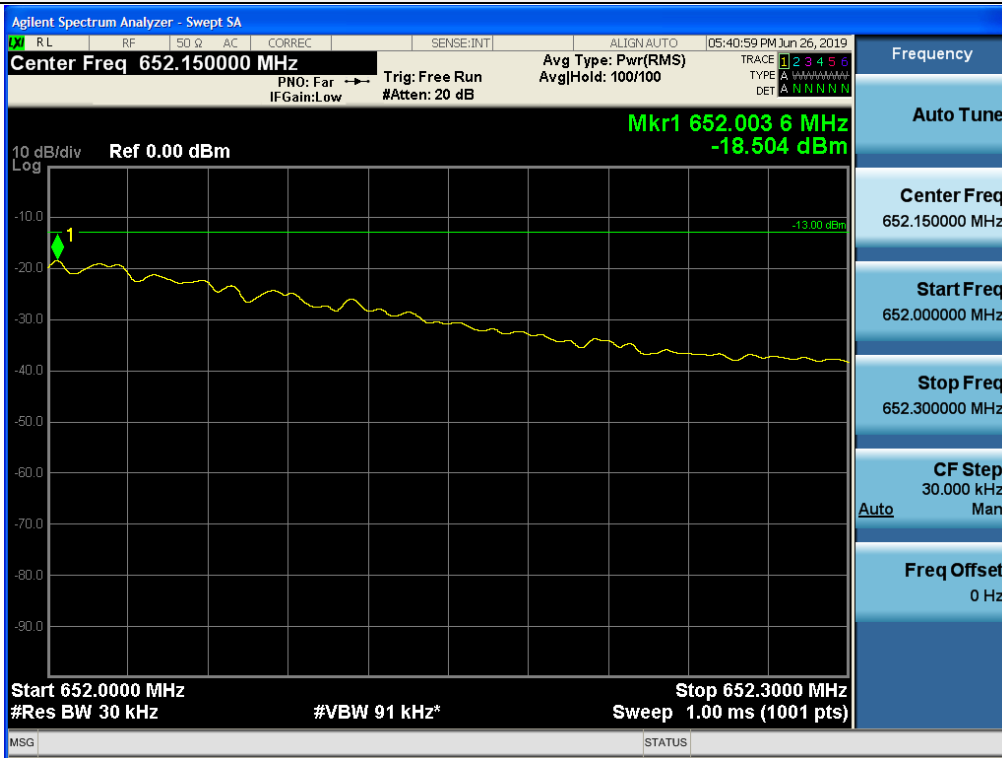

Out-of-band (single test signal) / 600 MHz Service / Downlink / LTE 10 MHz / Lower

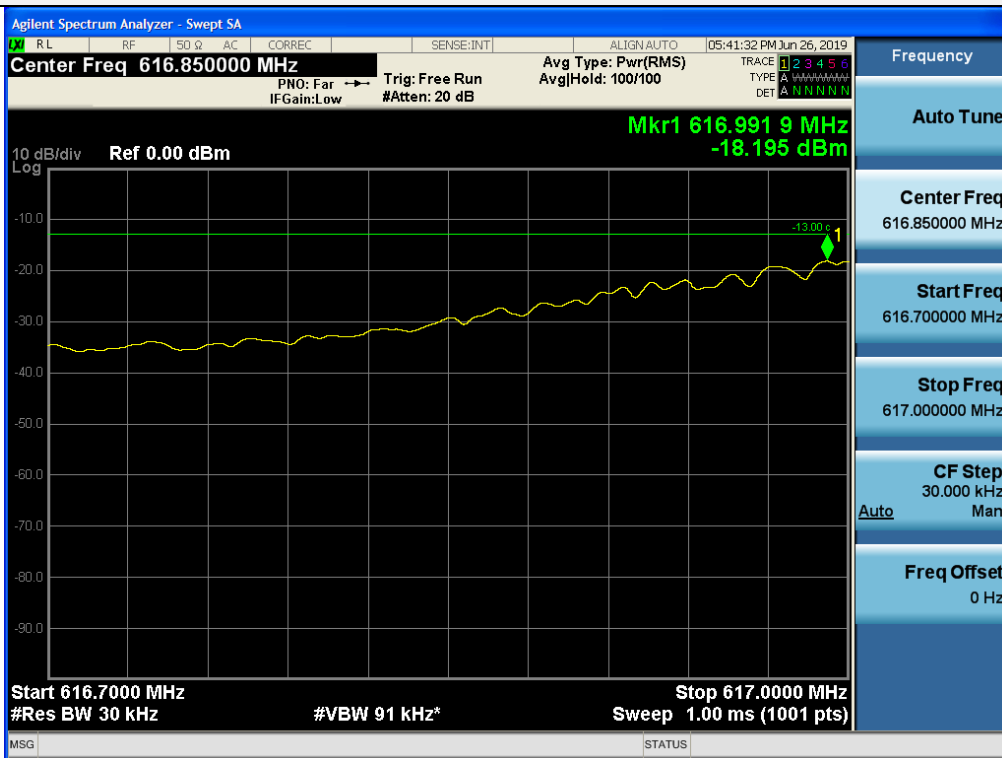

Out-of-band (single test signal) / 600 MHz Service / Downlink / LTE 20 MHz / Upper

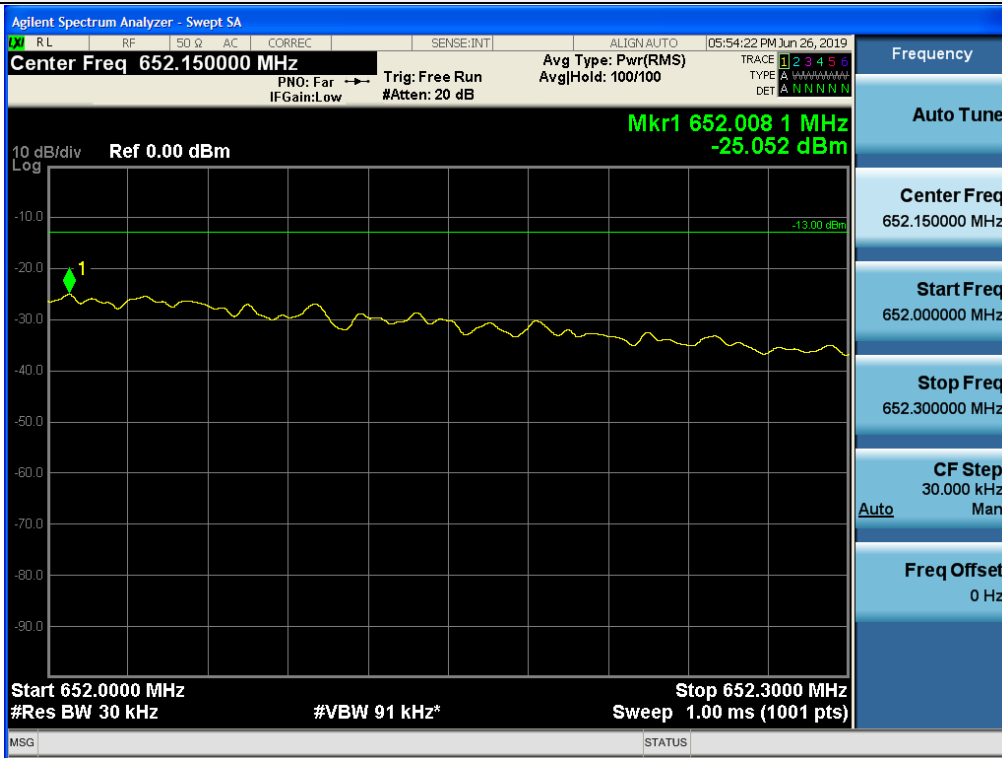

Out-of-band (single test signal) / 600 MHz Service / Downlink / LTE 20 MHz / Lower

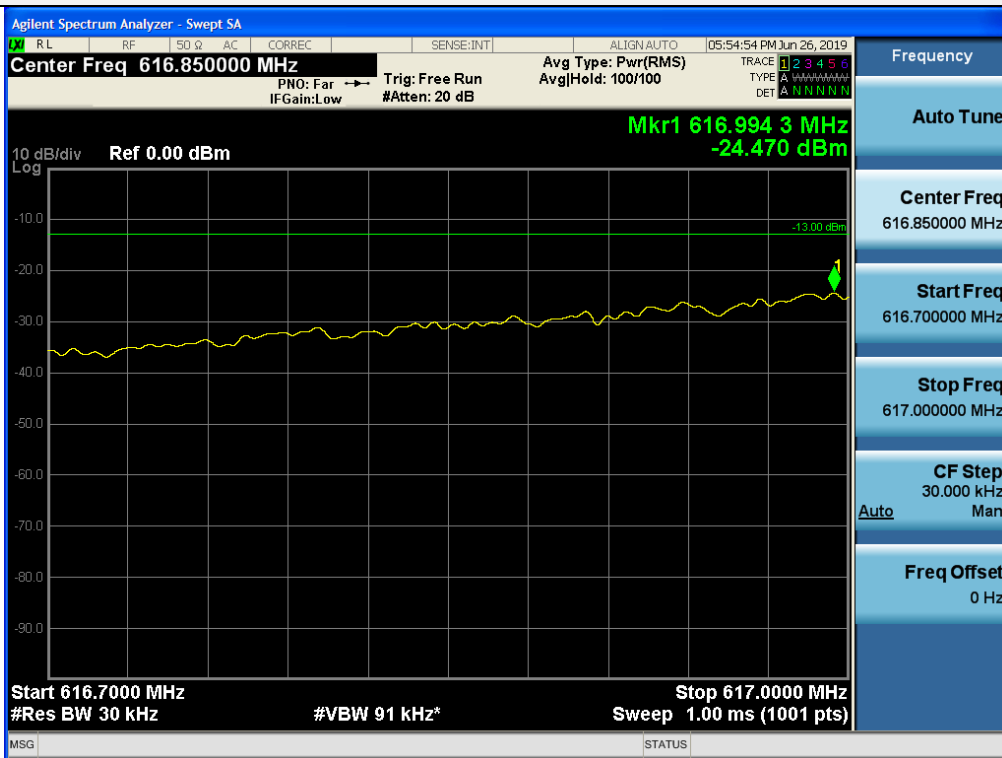

+3 dB above Out-of-band (single test signal) / 600 MHz Service / Downlink / LTE 5 MHz / Upper

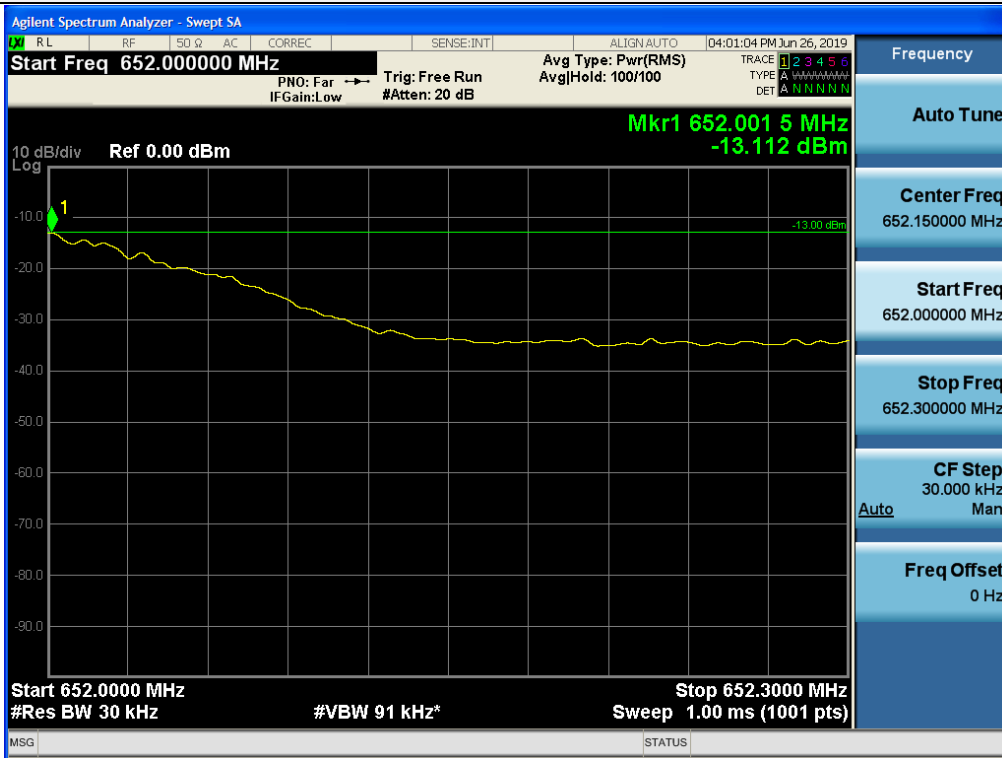

+3 dB above Out-of-band (single test signal) / 600 MHz Service / Downlink / LTE 5 MHz / Lower

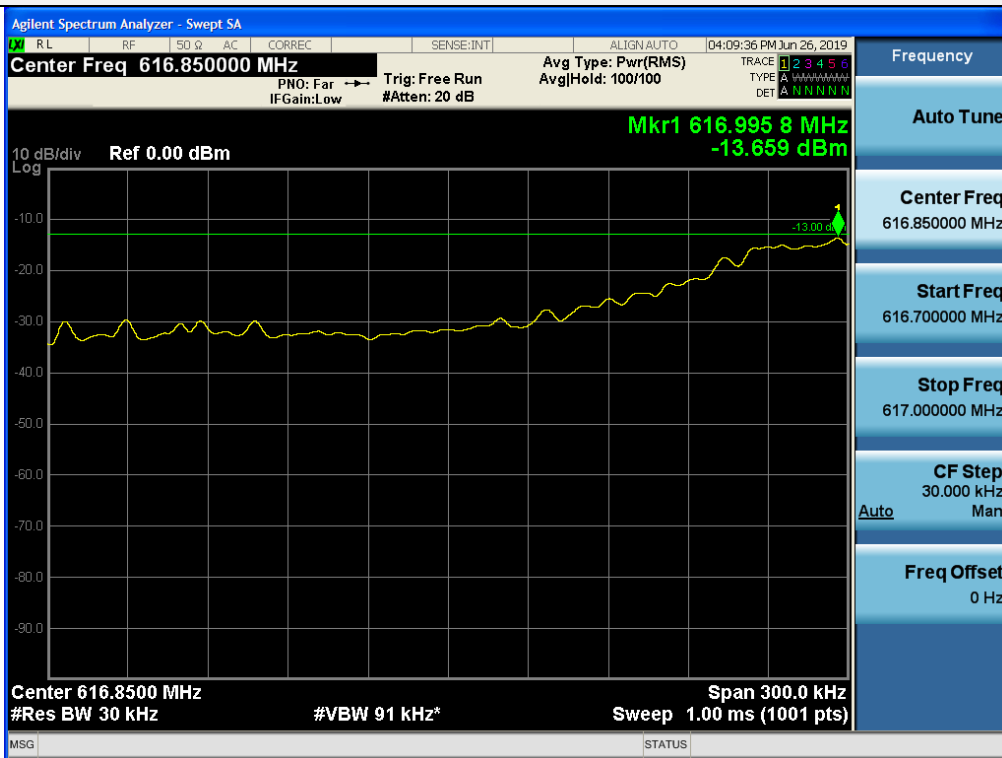

+3 dB above Out-of-band (single test signal) / 600 MHz Service / Downlink / LTE 10 MHz / Upper

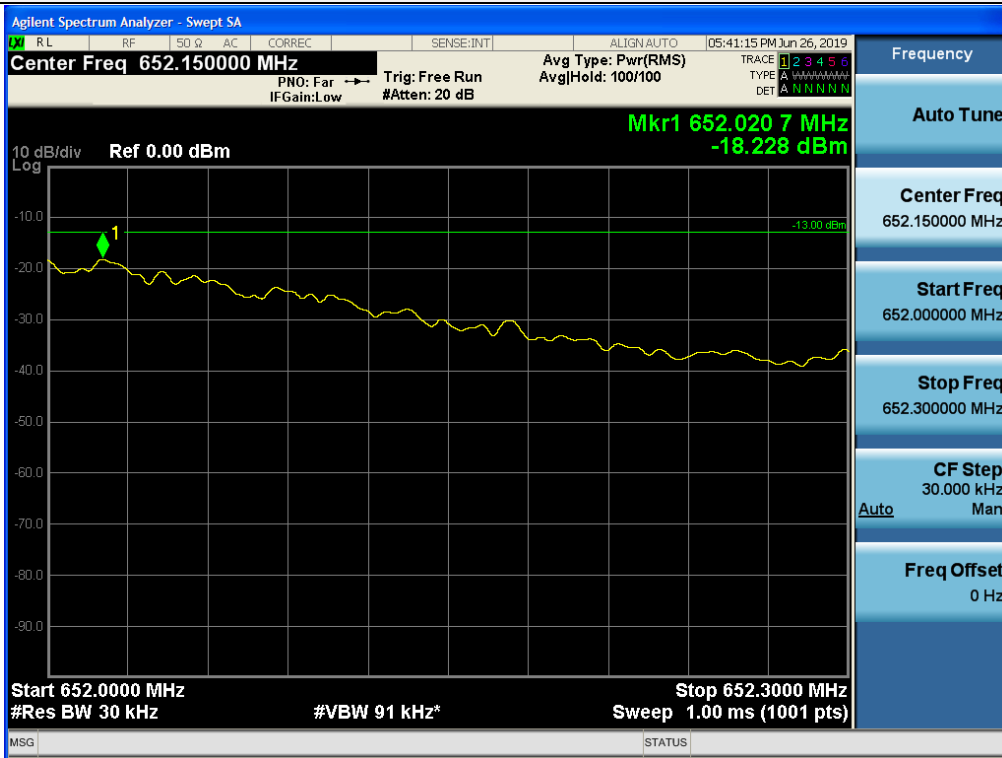

+3 dB above Out-of-band (single test signal) / 600 MHz Service / Downlink / LTE 10 MHz / Lower

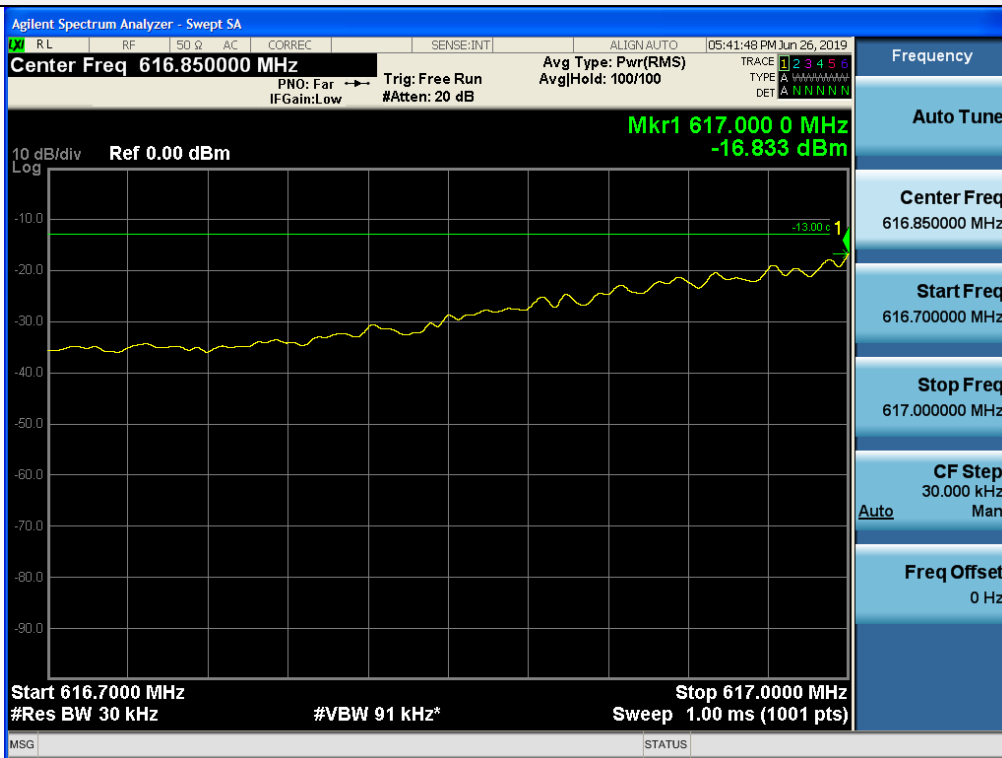

+3 dB above Out-of-band (single test signal) / 600 MHz Service / Downlink / LTE 20 MHz / Upper

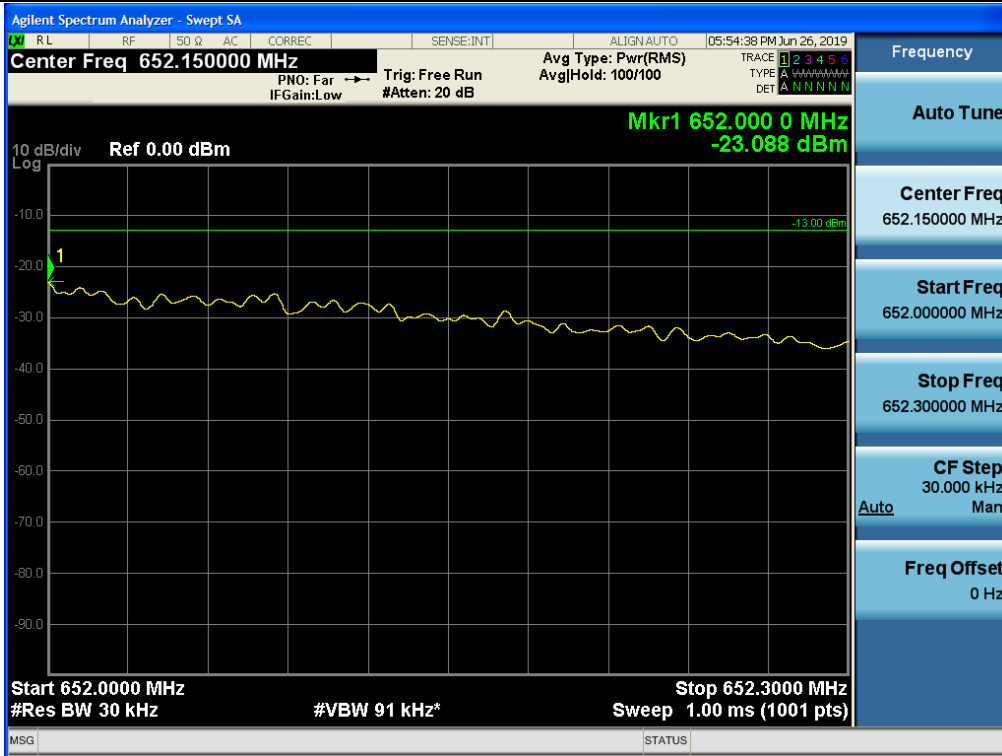

+3 dB above Out-of-band (single test signal) / 600 MHz Service / Downlink / LTE 20 MHz / Lower

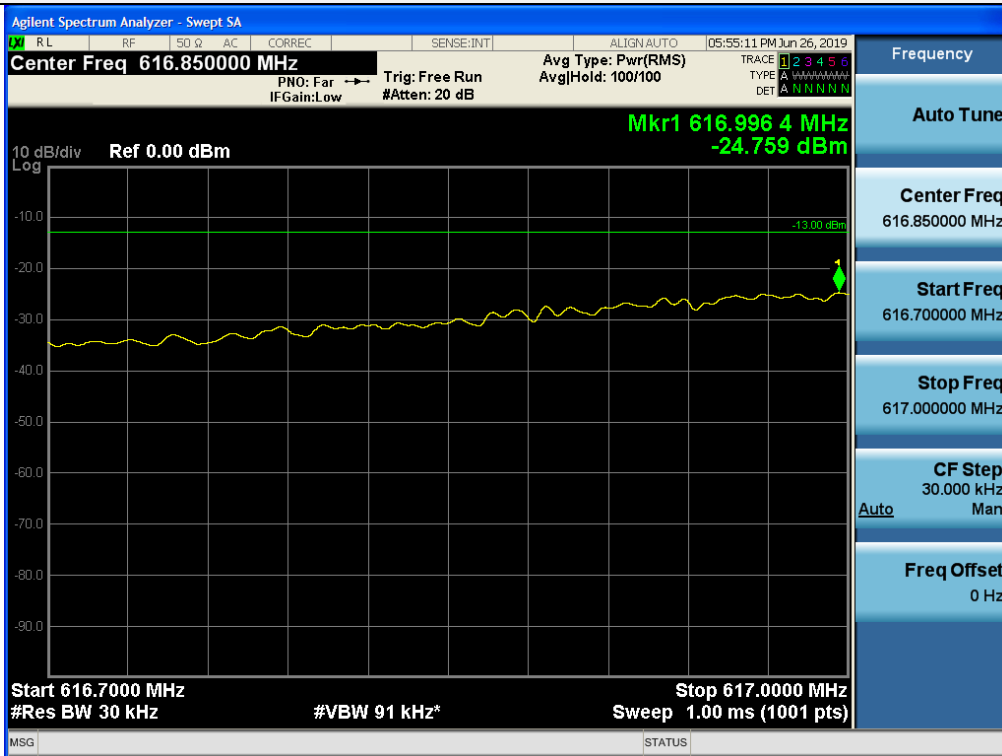

Plot data of Spurious Emissions

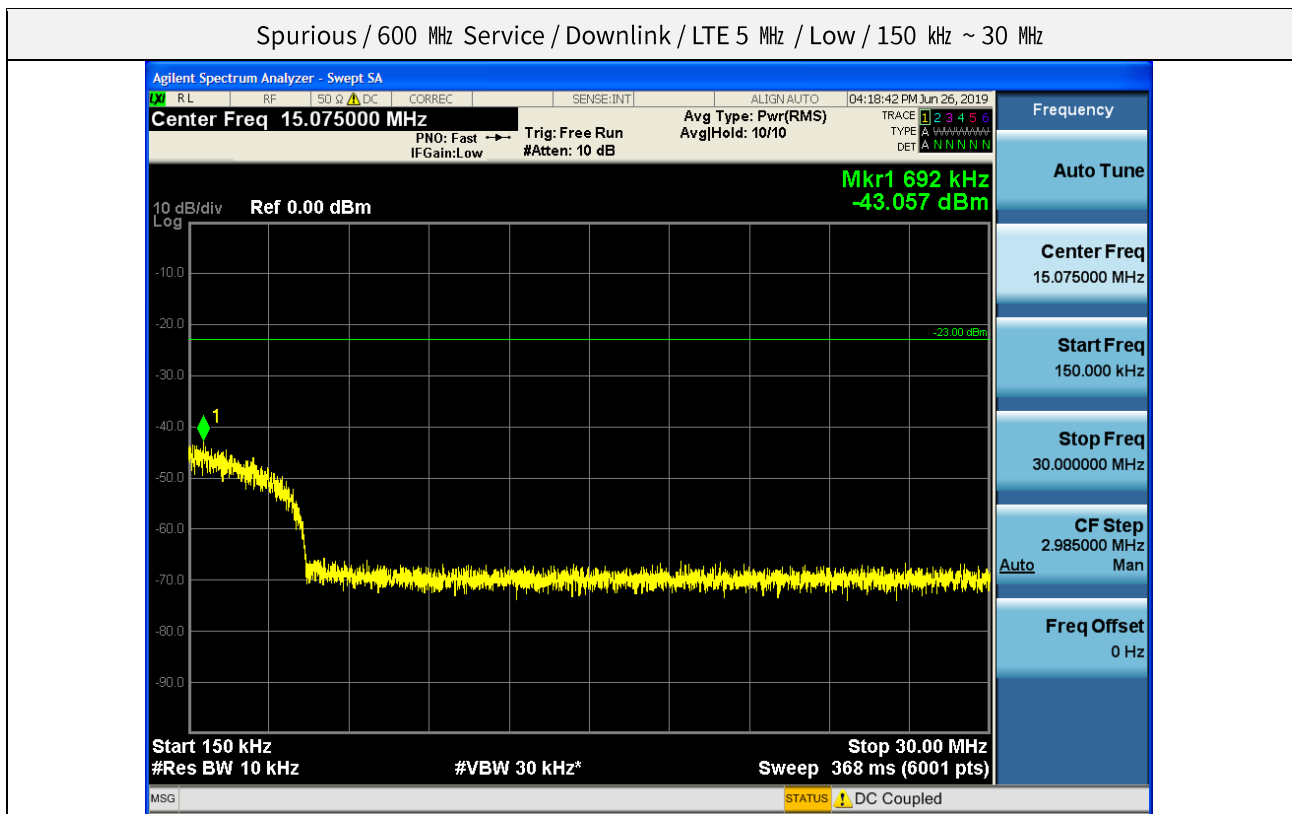
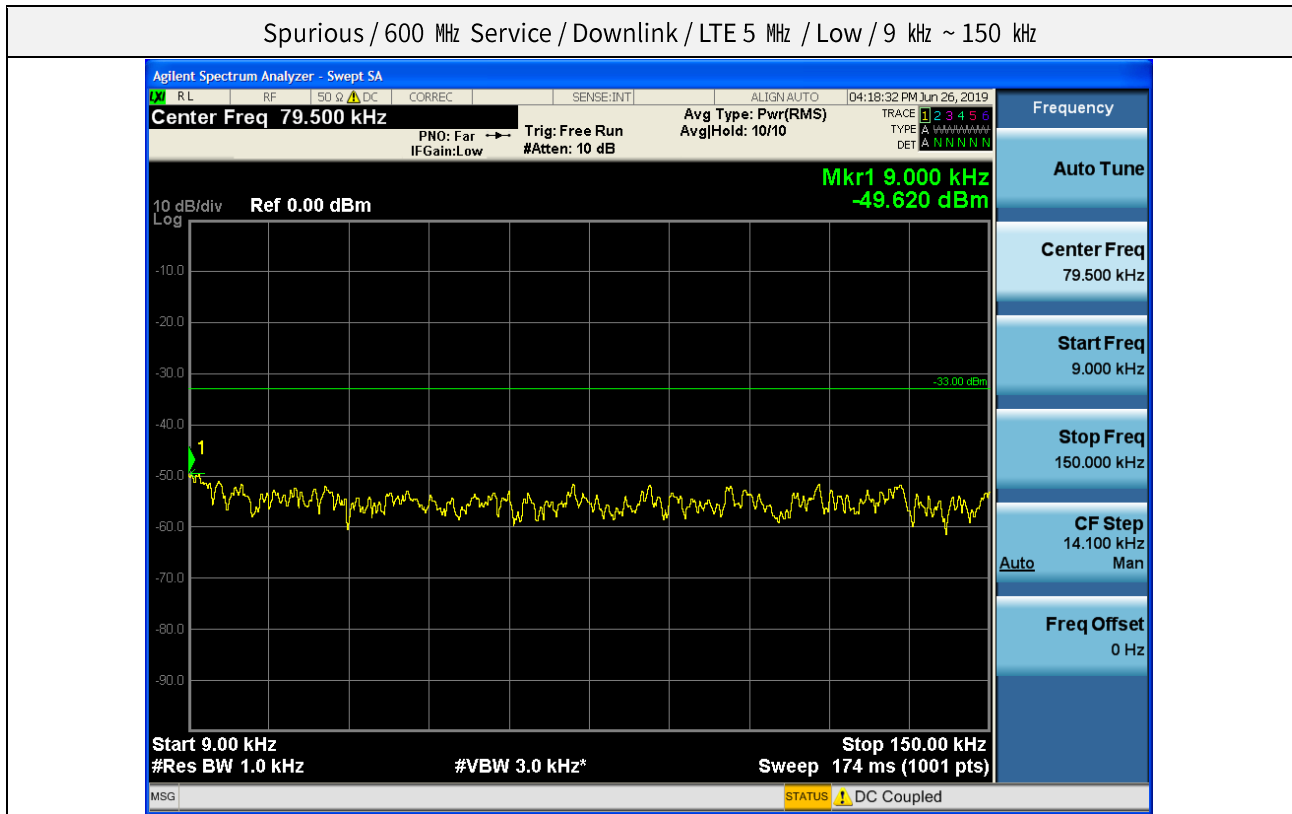

Spurious / 600 MHz Service / Downlink / LTE 5 MHz / Low / 30 MHz ~ Low Edge - 10.1 MHz

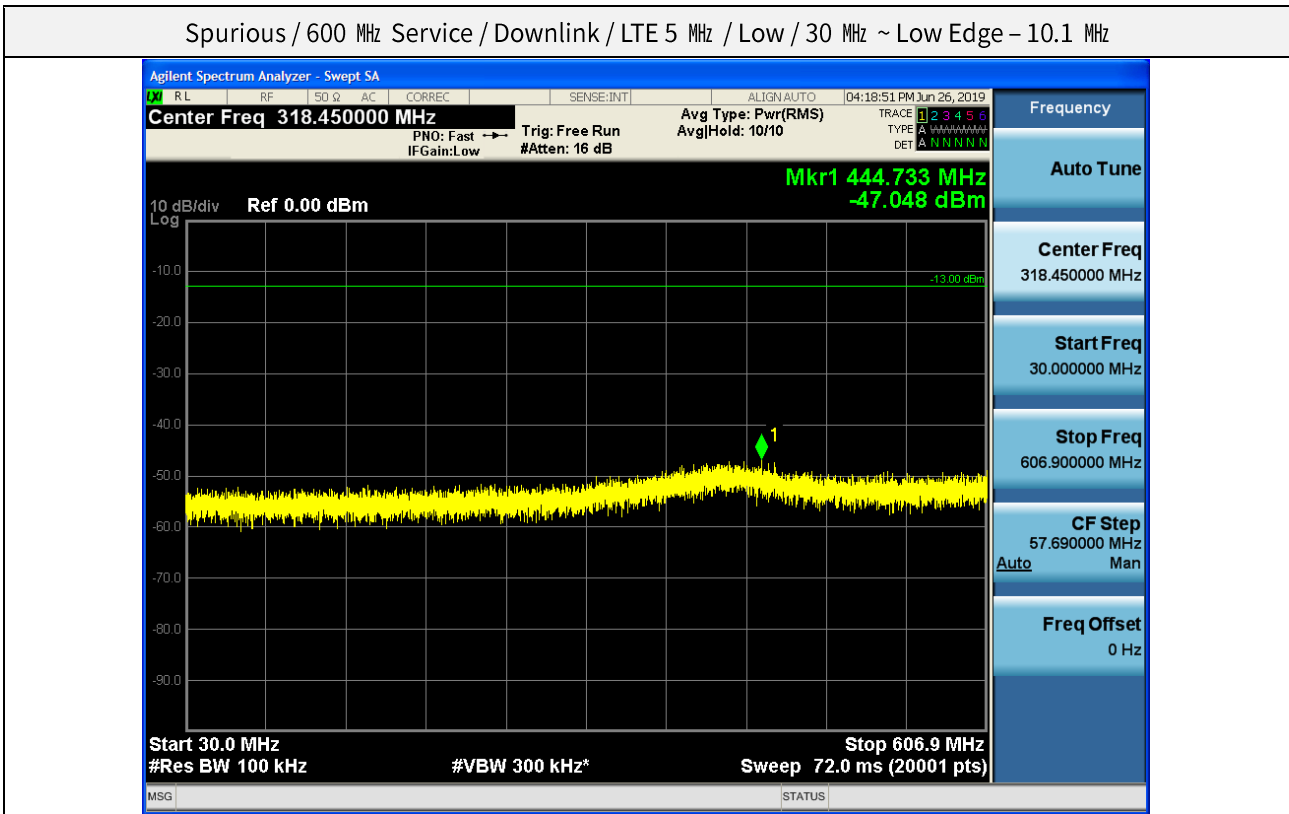

Spurious / 600 MHz Service / Downlink / LTE 5 MHz / Low / Low Edge - 10.1 MHz ~ Low Edge - 0.1 MHz

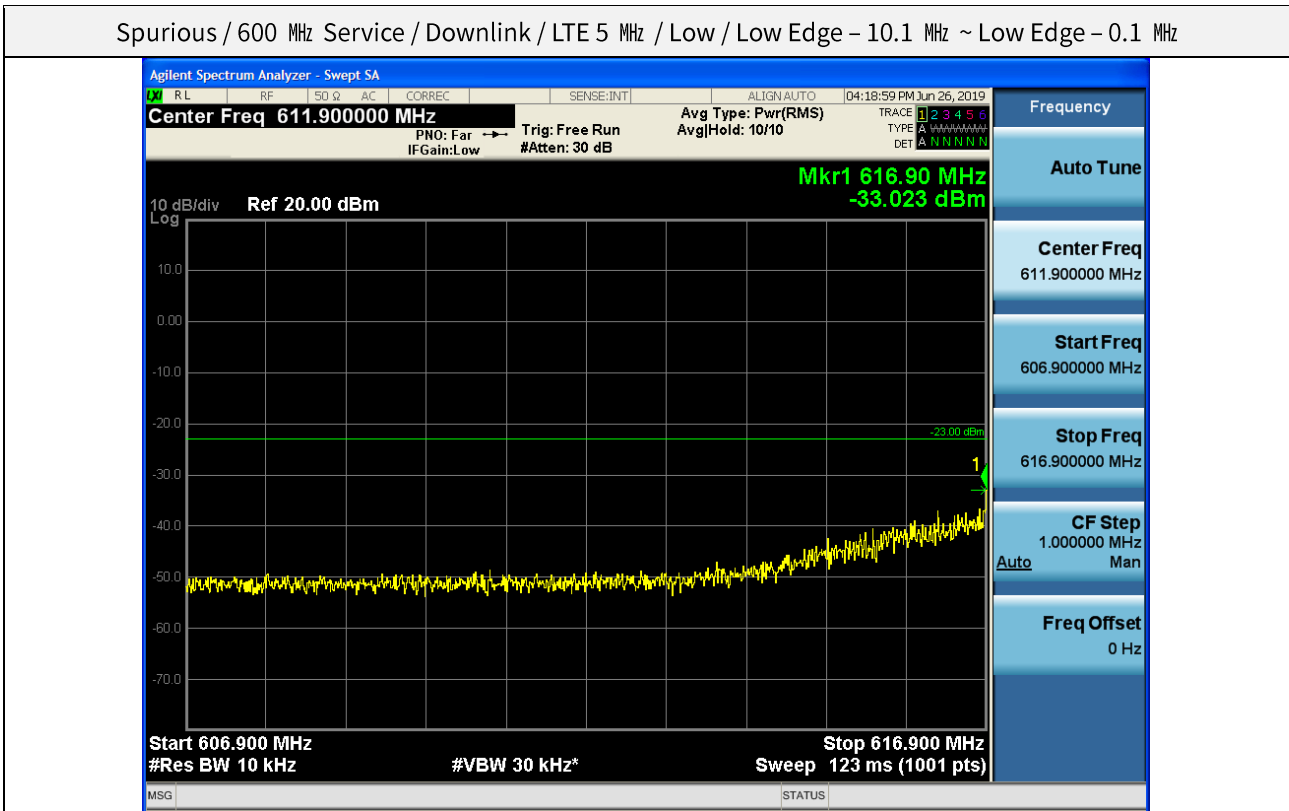

Spurious / 600 MHz Service / Downlink / LTE 5 MHz / Low / High Edge + 0.1 MHz ~ High Edge + 10.1 MHz

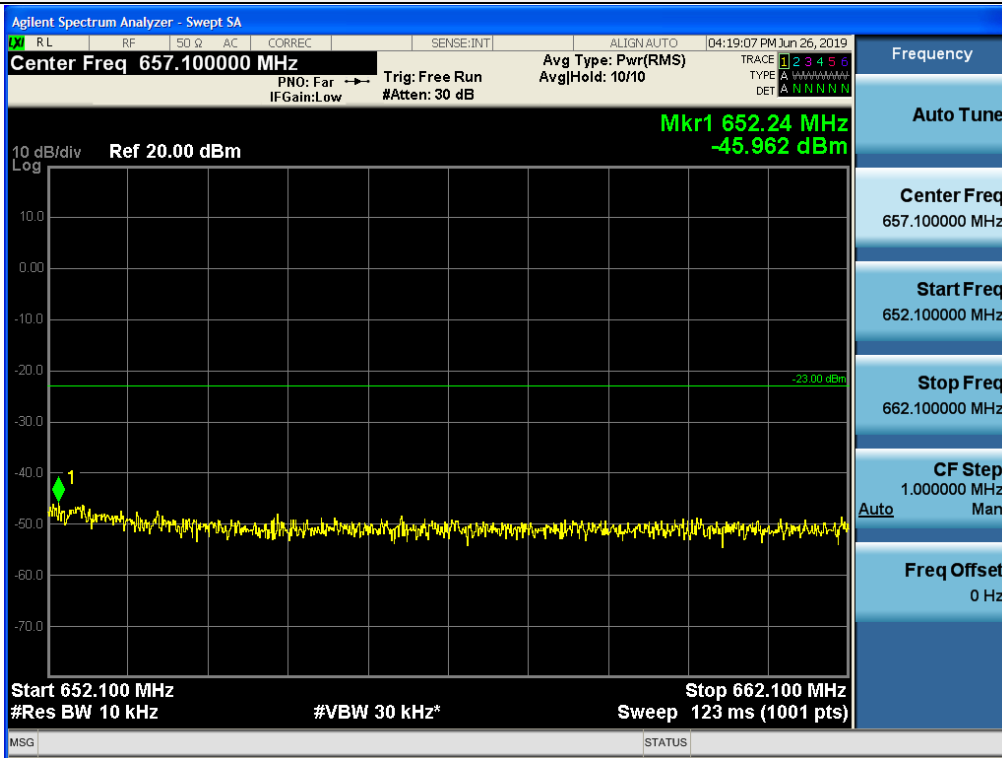

Spurious / 600 MHz Service / Downlink / LTE 5 MHz / Low / High Edge + 10.1 MHz ~ 1 GHz

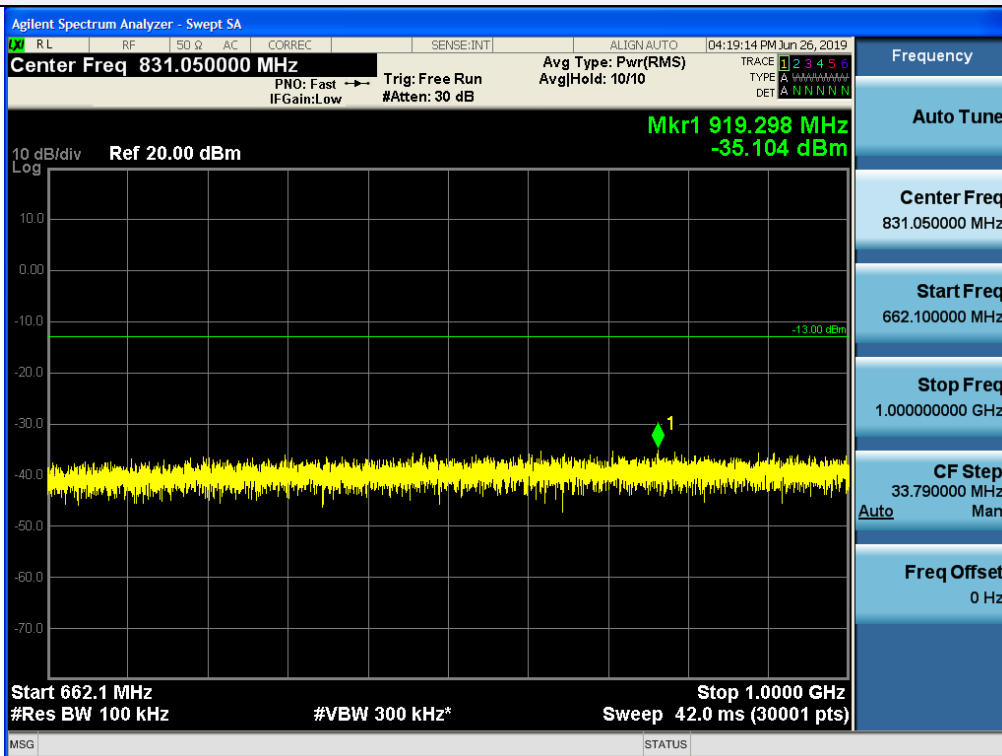

Spurious / 600 MHz Service / Downlink / LTE 5 MHz / Low / 1 GHz ~ 10 GHz

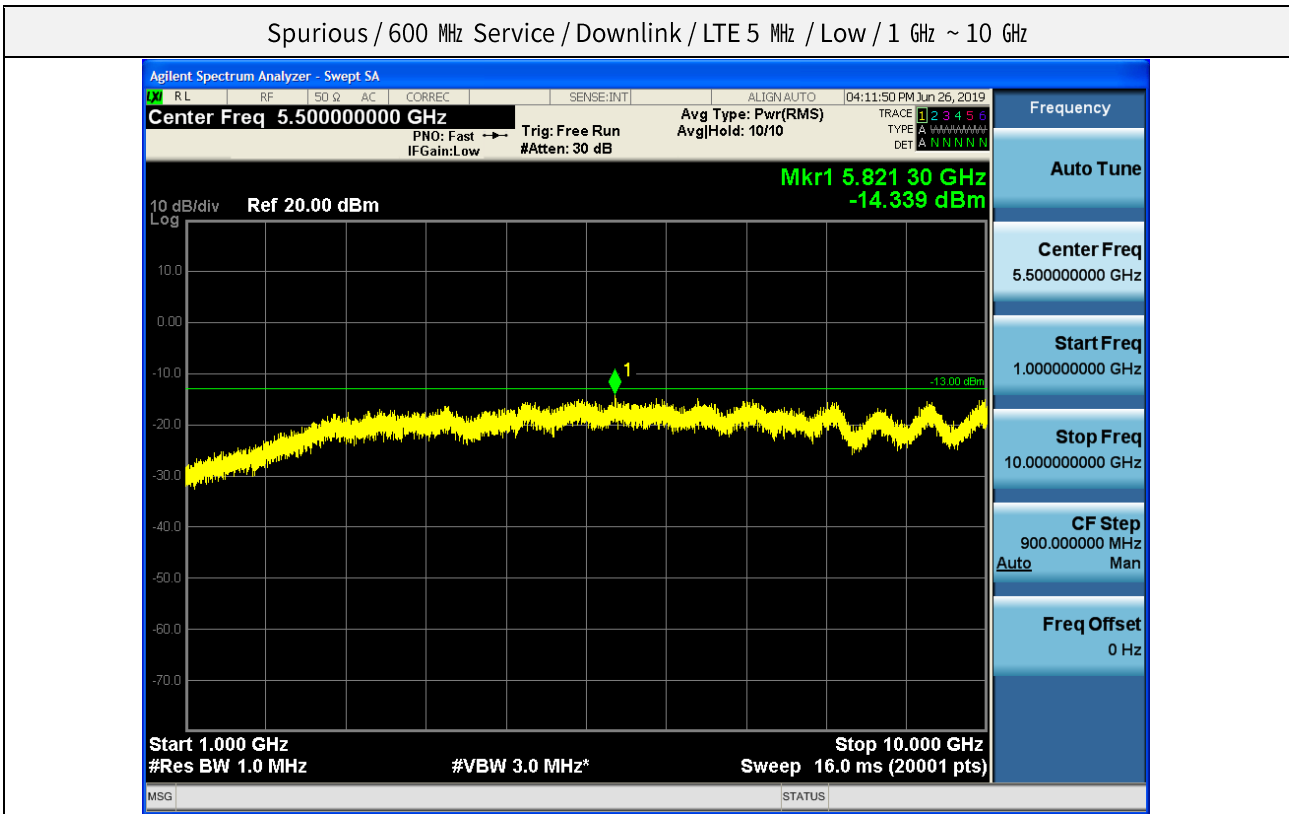

Spurious / 600 MHz Service / Downlink / LTE 5 MHz / Middle / 9 kHz ~ 150 kHz

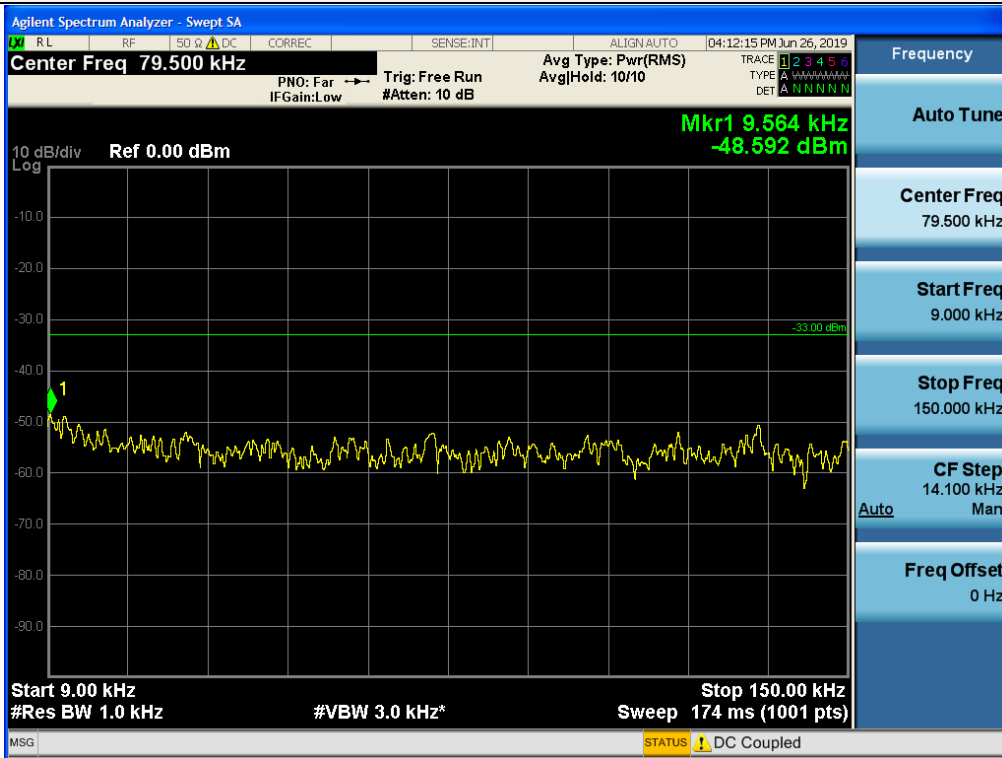

Spurious / 600 MHz Service / Downlink / LTE 5 MHz / Middle / 150 kHz ~ 30 MHz

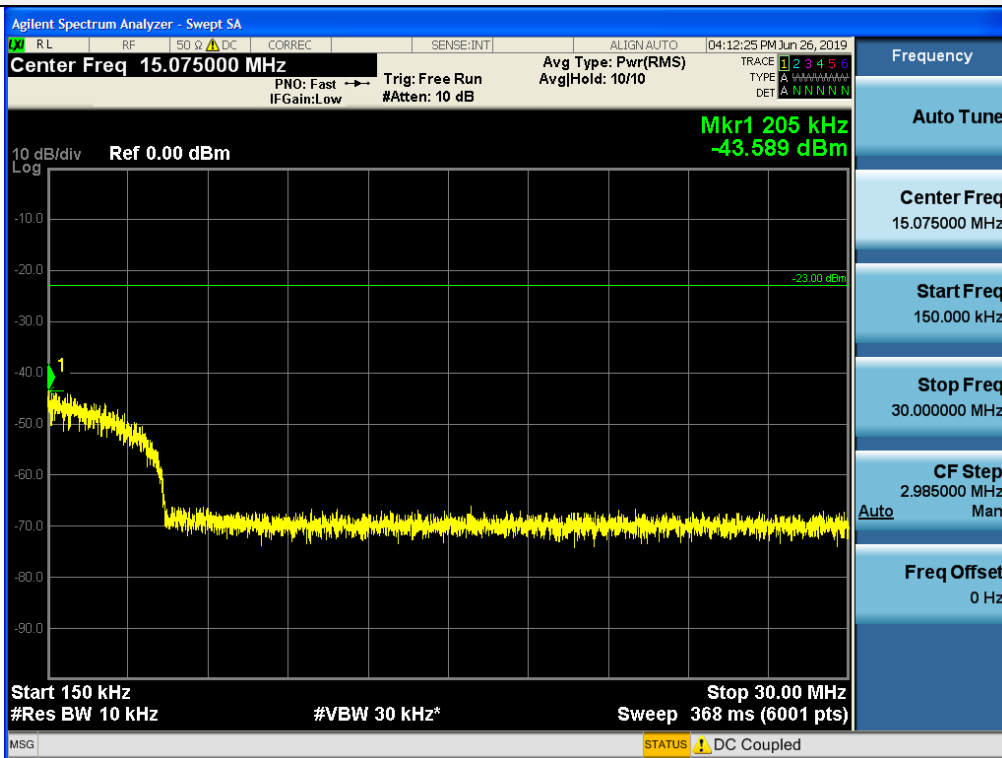

Spurious / 600 MHz Service / Downlink / LTE 5 MHz / Middle / 30 MHz ~ Low Edge - 10.1 MHz

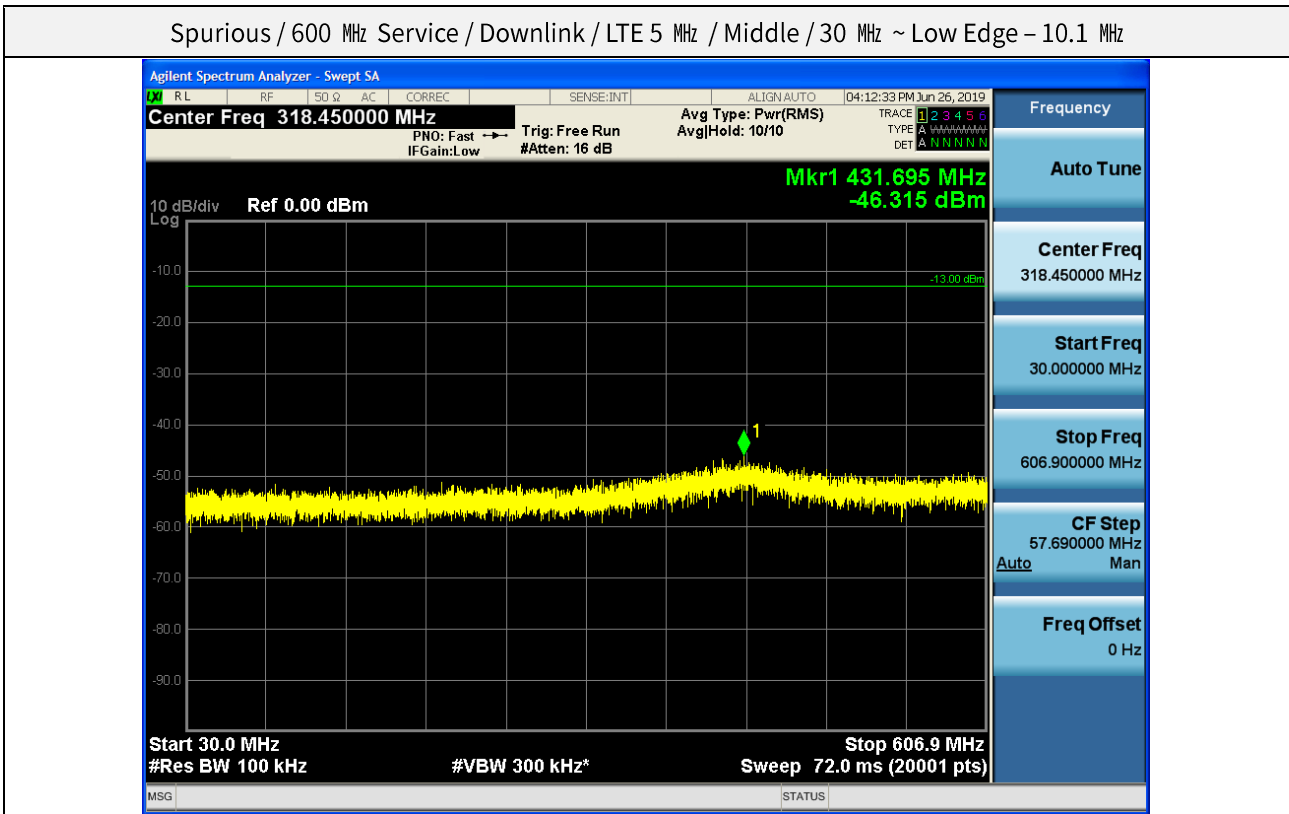

Spurious / 600 MHz Service / Downlink / LTE 5 MHz / Middle / Low Edge - 10.1 MHz ~ Low Edge - 0.1 MHz

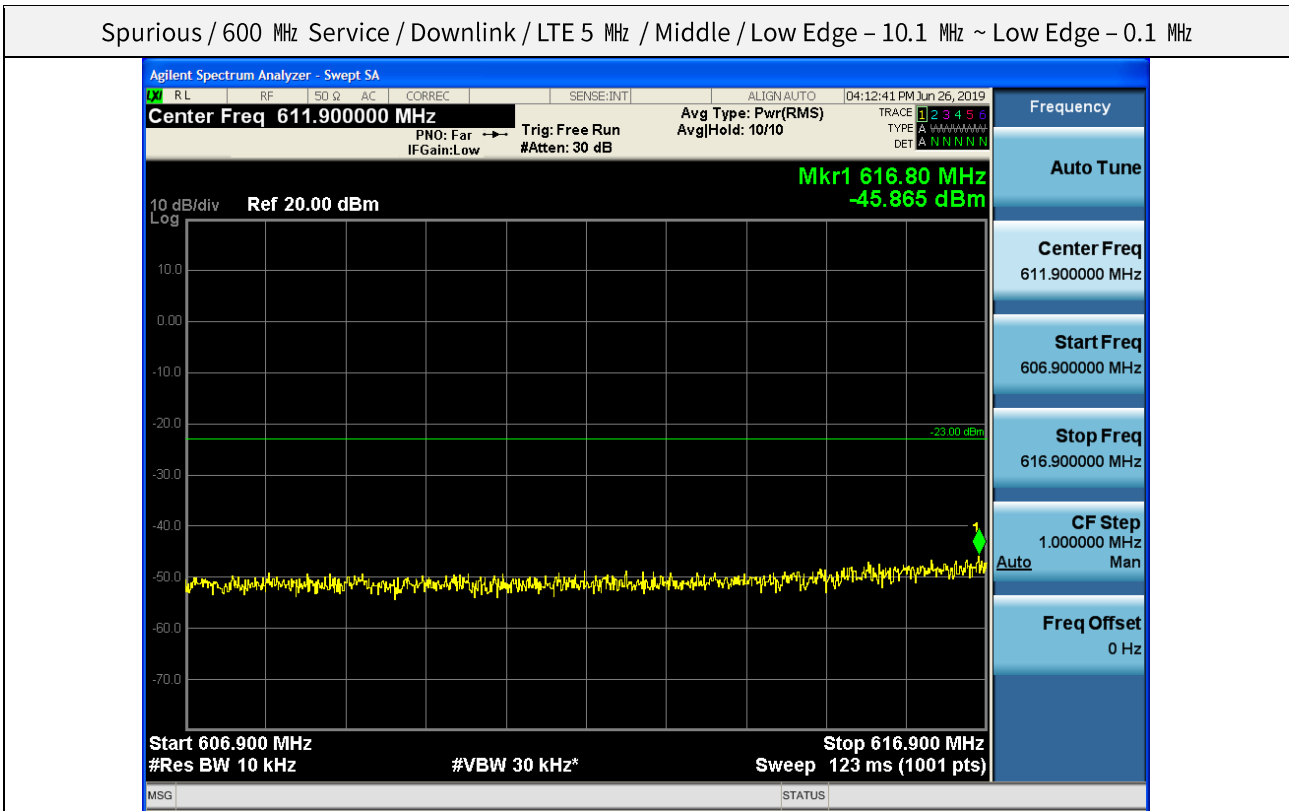

Spurious / 600 MHz Service / Downlink / LTE 5 MHz / Middle / High Edge + 0.1 MHz ~ High Edge + 10.1 MHz

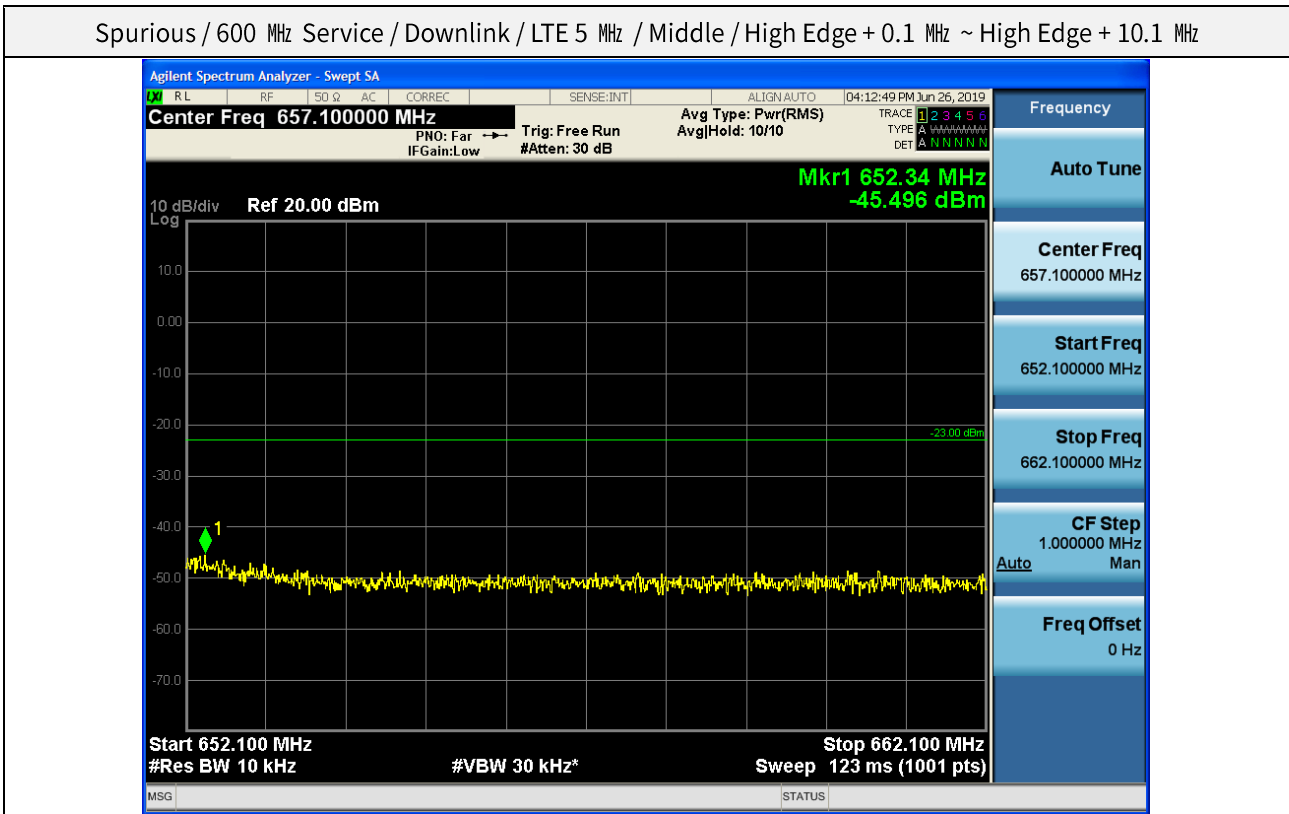

Spurious / 600 MHz Service / Downlink / LTE 5 MHz / Middle / High Edge + 10.1 MHz ~ 1 GHz

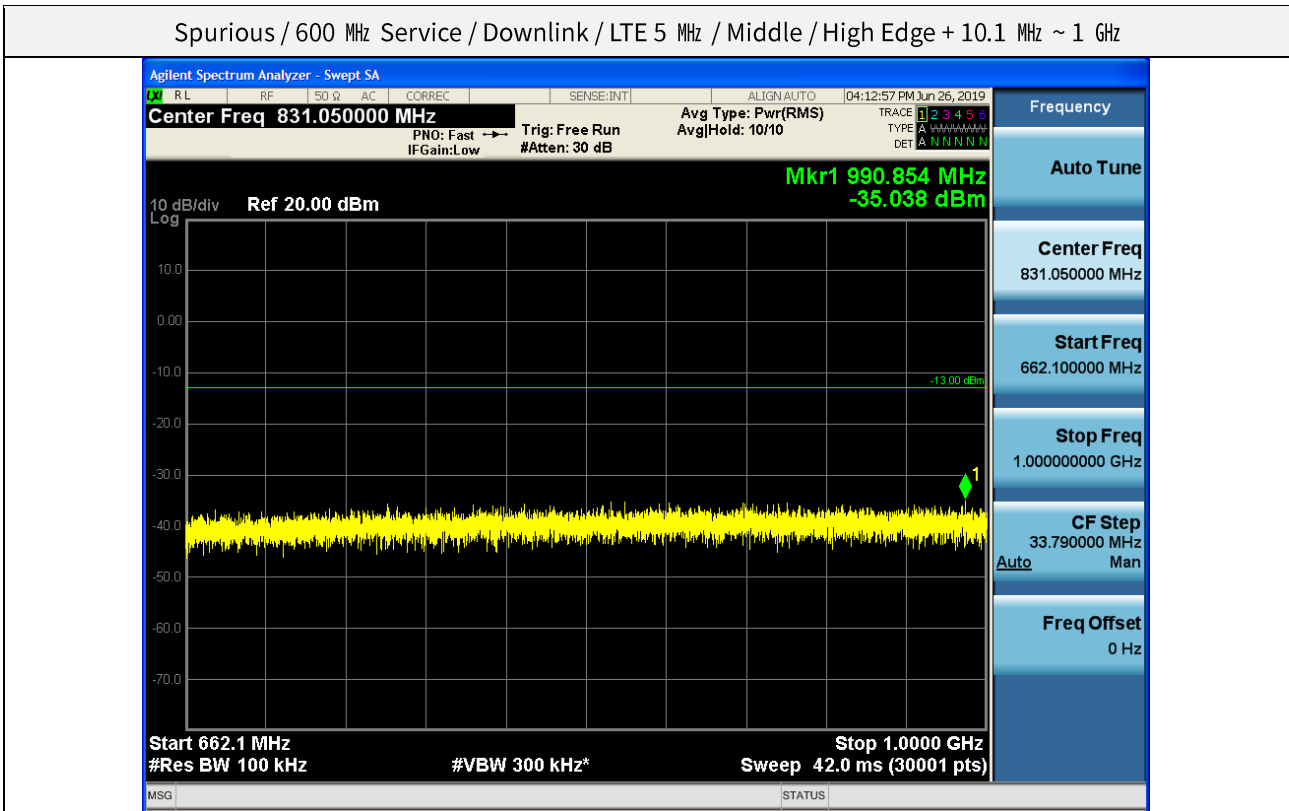

Spurious / 600 MHz Service / Downlink / LTE 5 MHz / Middle / 1 GHz ~ 10 GHz

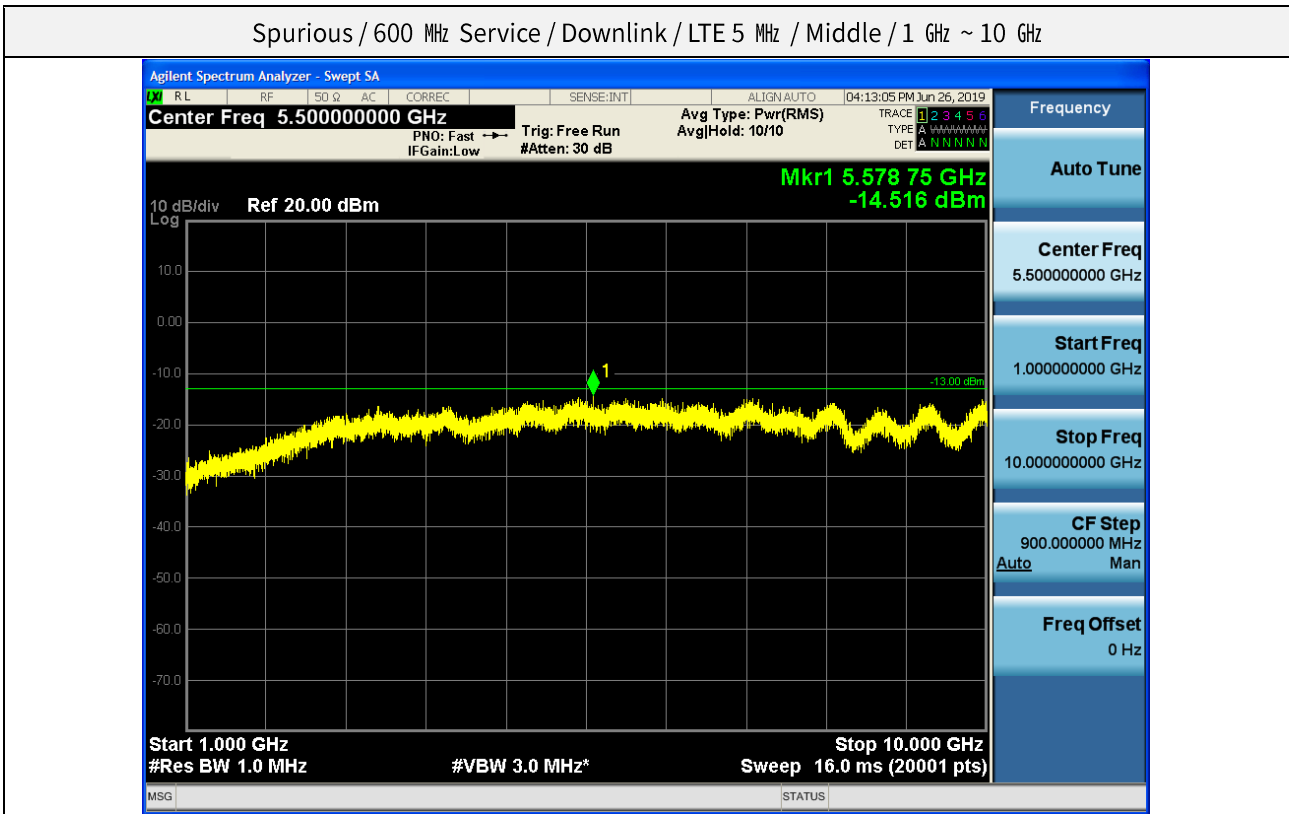

Spurious / 600 MHz Service / Downlink / LTE 5 MHz / High / 9 kHz ~ 150 kHz

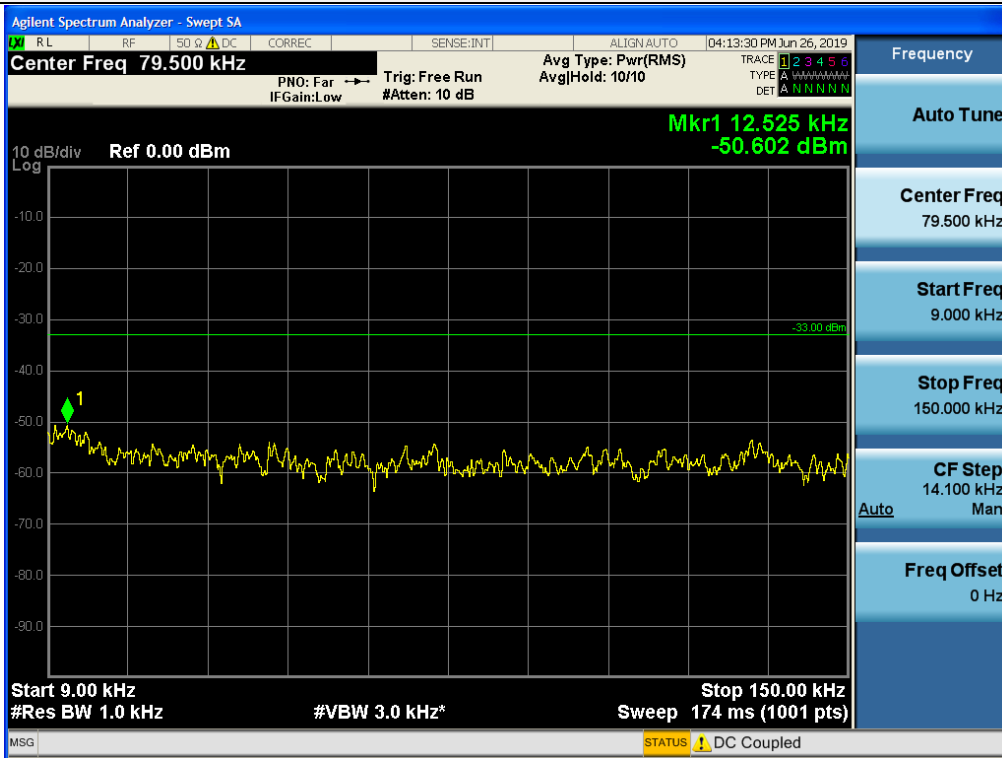

Spurious / 600 MHz Service / Downlink / LTE 5 MHz / High / 150 kHz ~ 30 MHz

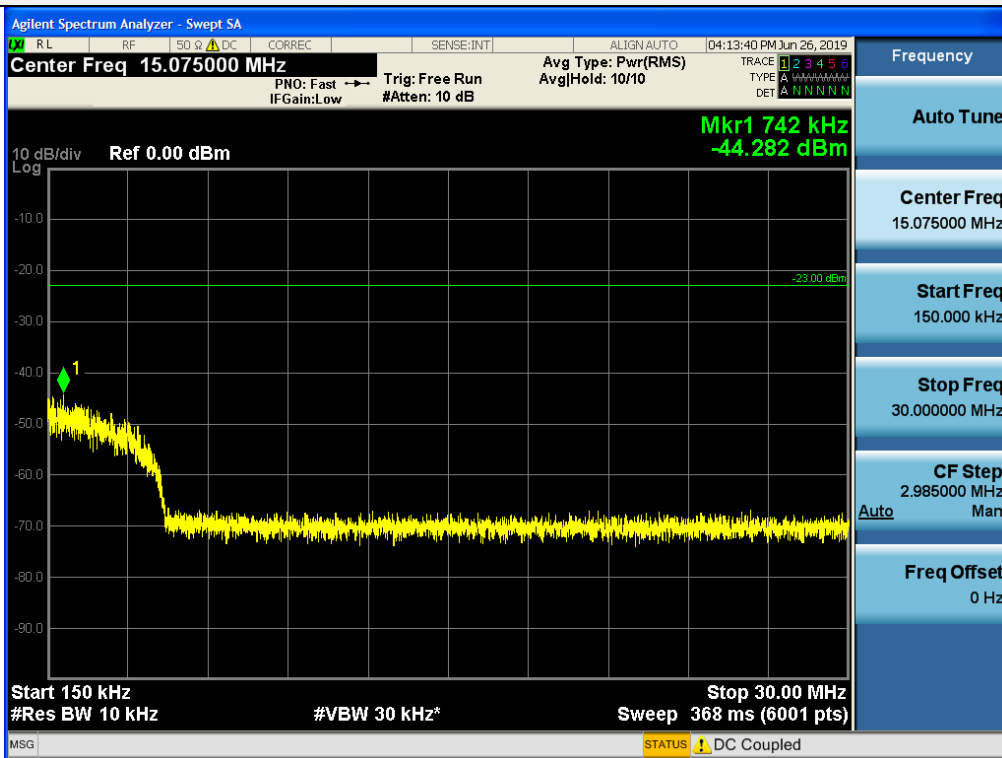

Spurious / 600 MHz Service / Downlink / LTE 5 MHz / High / 30 MHz ~ Low Edge - 10.1 MHz

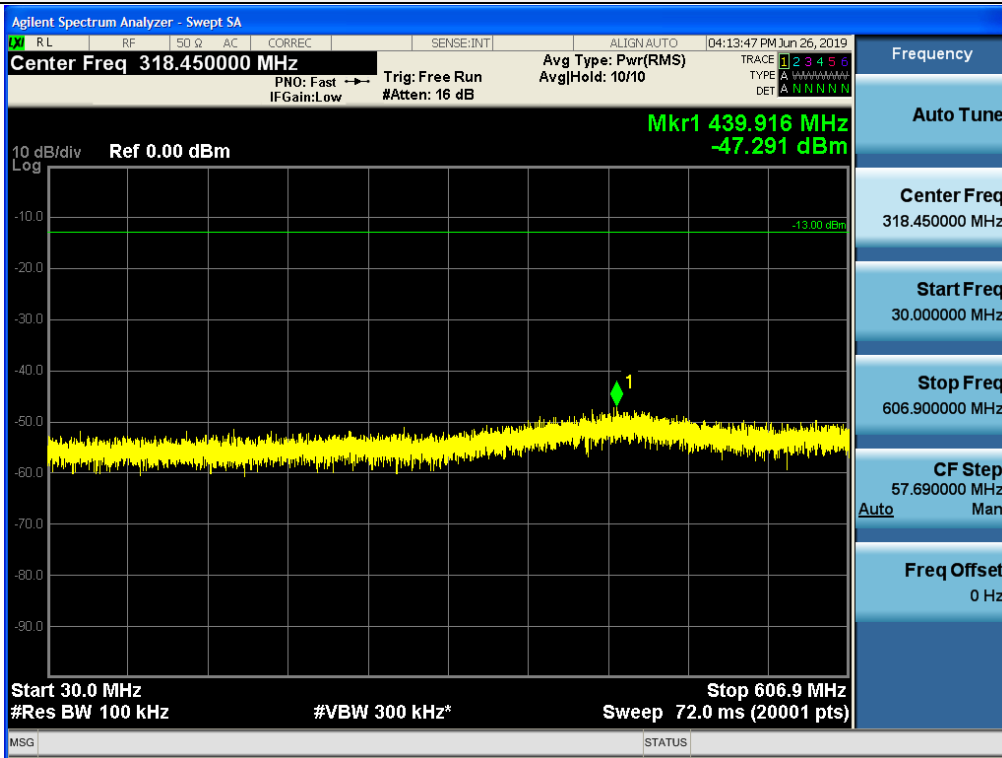

Spurious / 600 MHz Service / Downlink / LTE 5 MHz / High / Low Edge - 10.1 MHz ~ Low Edge - 0.1 MHz

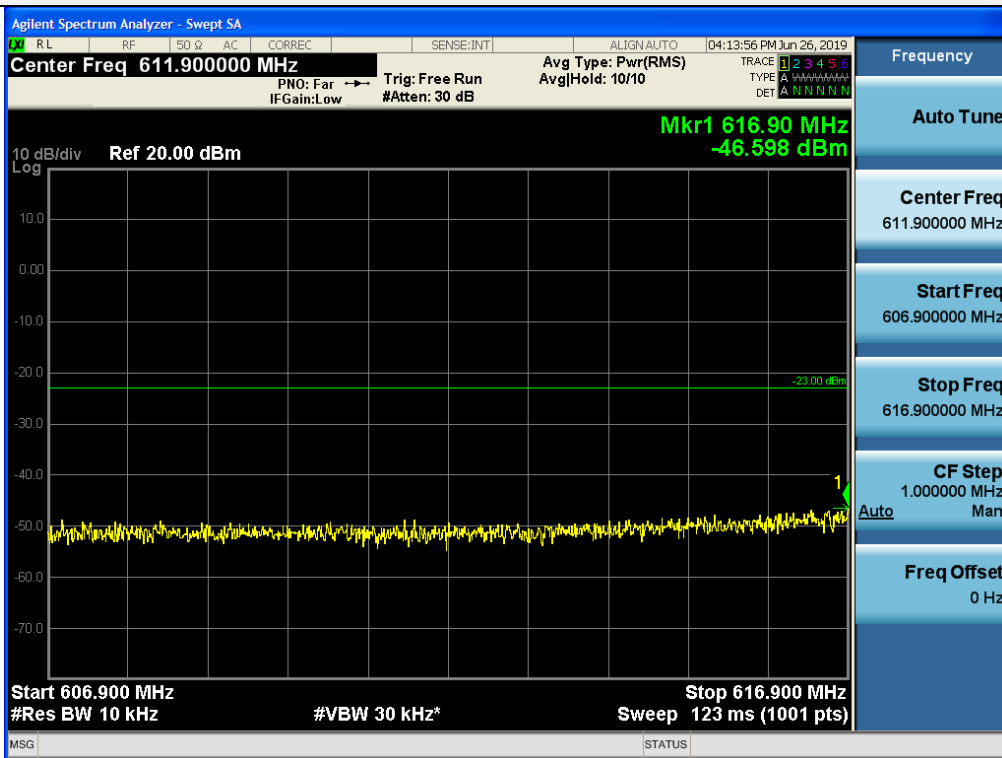

Spurious / 600 MHz Service / Downlink / LTE 5 MHz / High / High Edge + 0.1 MHz ~ High Edge + 10.1 MHz

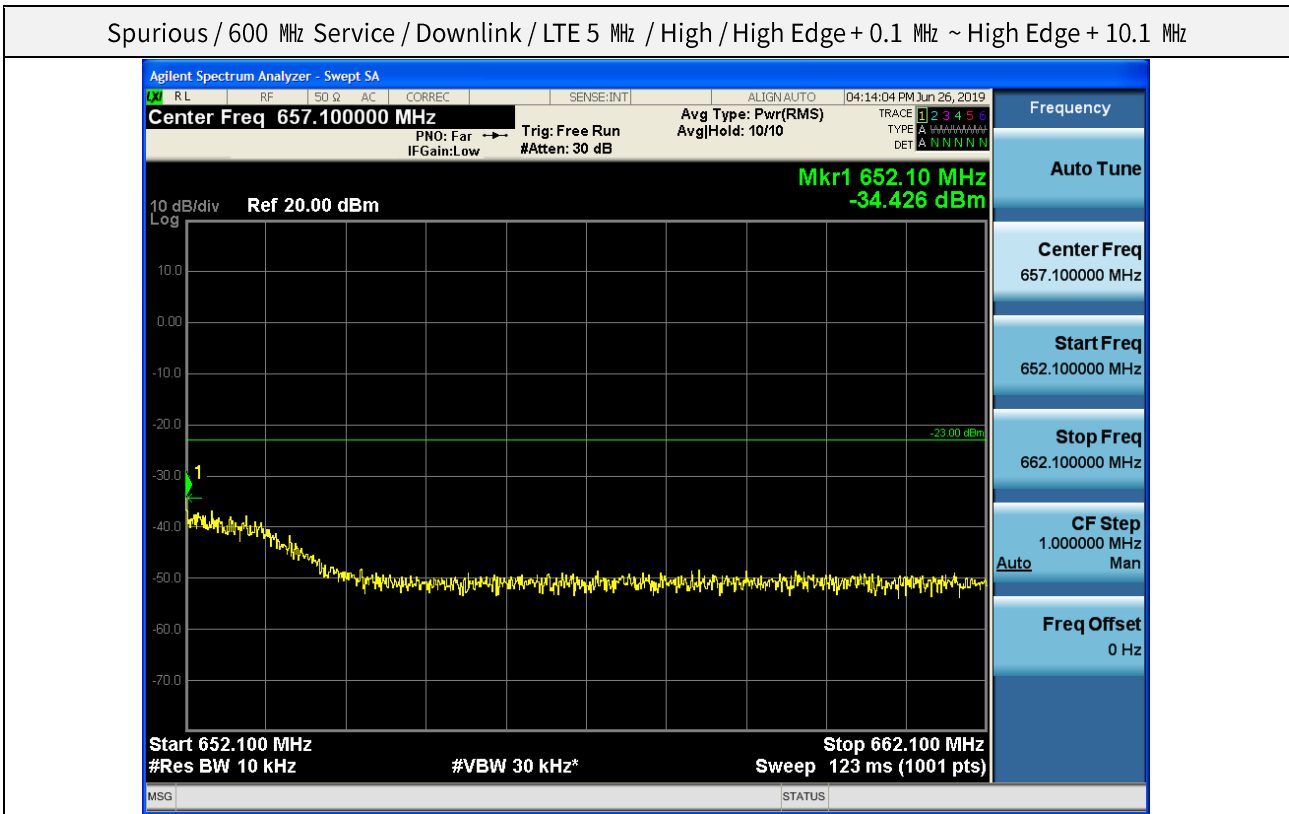

Spurious / 600 MHz Service / Downlink / LTE 5 MHz / High / High Edge + 10.1 MHz ~ 1 GHz

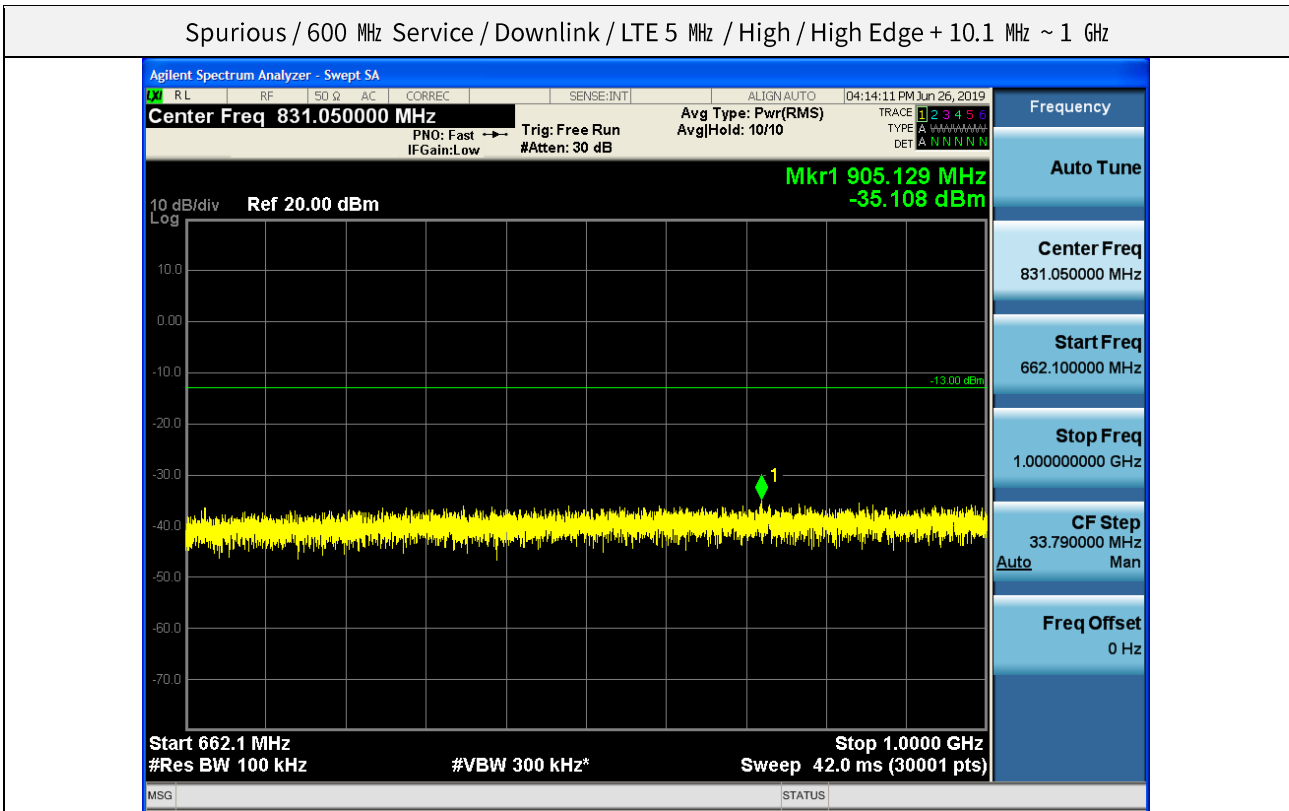

Spurious / 600 MHz Service / Downlink / LTE 5 MHz / High / 1 GHz ~ 10 GHz

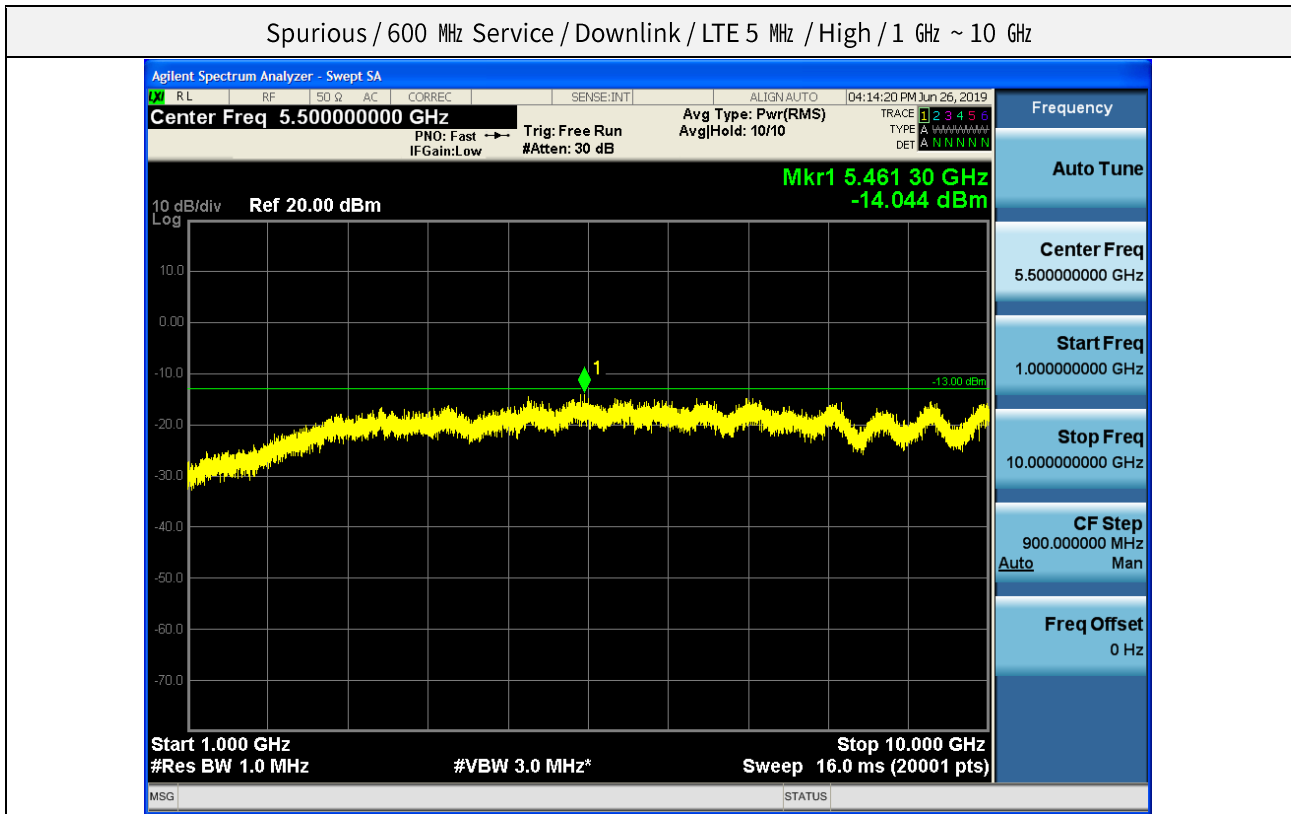

Spurious / 600 MHz Service / Downlink / LTE 10 MHz / Low / 9 kHz ~ 150 kHz

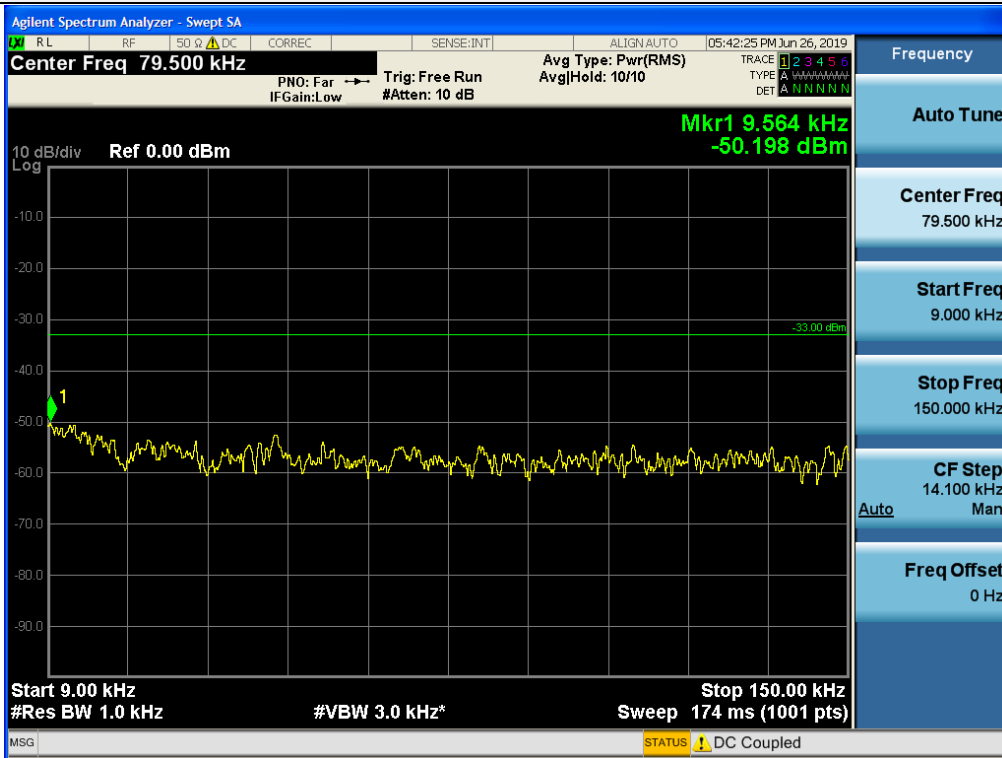

Spurious / 600 MHz Service / Downlink / LTE 10 MHz / Low / 150 kHz ~ 30 MHz

