



# Compliance Testing, LLC

Previously Flom Test Lab

EMI, EMC, RF Testing Experts Since 1963

toll-free: (866) 311-3268

fax: (480) 926-3598

<http://www.ComplianceTesting.com>

[info@ComplianceTesting.com](mailto:info@ComplianceTesting.com)

## Test Report

Prepared for: Solid Technologies

Model: MRDU-AWS1-B

Description: 5 WATT AWS-1 Amplifier Module  
Chassis: ALLIANCE 5W Optical Unit Chassis, AC Power

FCC ID: W6UHMAWS1M

To

FCC Part 27

Date of Issue: September 8, 2014

On the behalf of the applicant:

Solid Technologies  
4332 E Siesta Lane  
Phoenix, AZ 85050

Attention of:

Gregory Glenn  
(408) 649-4803  
E-Mail: [greg.glenn@solid.com](mailto:greg.glenn@solid.com)

Prepared By  
Compliance Testing, LLC  
1724 S. Nevada Way  
Mesa, AZ 85204  
(480) 926-3100 phone / (480) 926-3598 fax  
[www.compliancetesting.com](http://www.compliancetesting.com)  
Project No: p1440026

**Mike Graffeo**  
Project Test Engineer

This report may not be reproduced, except in full, without written permission from Compliance Testing  
All results contained herein relate only to the sample tested



### Test Report Revision History

Revision	Date	Revised By	Reason for Revision
1.0	5/7/14	Mike Graffeo	Original Document
2.0	5/27/14	Mike Graffeo	1) Remove reference to part 22 and part 24 2) Added Output port vs. frequency
3.0	9/8/14	Amanda Reed	Remove MIMO references to correct model description



## Table of Contents

<b><u>Description</u></b>	<b><u>Page</u></b>
Standard Test Conditions and Engineering Practices	5
Licensing and Module and Frequency Range Cross Reference	6
Test Result Summary	7
Carrier Output Power	8
Spurious Emissions (Transmitter Conducted)	10
Spurious Emissions (Transmitter Radiated)	15
Intermodulation	18
Occupied Bandwidth	21
Out of Band Rejection	25
Test Equipment Utilized	27



## ILAC / A2LA

Compliance Testing, LLC, has been accredited in accordance with the recognized International Standard ISO/IEC 17025:2005. This accreditation demonstrates technical competence for a defined scope and the operation of a laboratory quality management system (refer joint ISO-ILAC-IAF Communiqué dated January 2009)

The tests results contained within this test report all fall within our scope of accreditation, unless noted below.

Please refer to <http://www.compliancetesting.com/labscope.html> for current scope of accreditation.

**Testing Certificate Number: 2152.01**



**FCC-Site Reg. #349717**

**IC Site Reg. #2044A-2**

**Non-accredited tests contained in this report:**

**N/A**



**Test and Measurement Data**

Subpart  
2.1033(c)(14):

All tests and measurement data shown were performed in accordance with FCC Rules and Regulations, Part 2, Subpart J and the following individual Part 27 Signal Booster.

**Standard Test Conditions and Engineering Practices**

Except as noted herein, the following conditions and procedures were observed during the testing.

In accordance with ANSI/C63.4-2009, and unless otherwise indicated in the specific measurement results, the ambient temperature of the actual EUT was maintained within the range of 10° to 40°C (50° to 104°F) unless the particular equipment requirements specify testing over a different temperature range. Also, unless otherwise indicated, the humidity levels were in the range of 10% to 90% relative humidity.

Environmental Conditions		
Temp (°C)	Humidity (%)	Pressure (mbar)
21.6 - 29.0	40.2 - 57.9	964.7 - 969.4

Measurement results, unless otherwise noted, are worst-case measurements.

**EUT Description**

**Model:** MRDU-AWS1-B

**Description:** 5 WATT AWS-1 Amplifier Module

**Firmware:** N/A

**Software:** SOLiD ALLIANCE REL6.0 Management V16.1\_03\_29\_2014

**Accessories:** None

**Cables:** None

**Modifications:** None

**Additional Information:**

The EUT is an amplifier for boosting the signal of cellular phone signals and data communication devices. The following frequency bands and emission types are utilized. It is considered an industrial booster.

**Antenna Output Port Utilized:** Ant2

Frequency Band (MHz)	
<b>Downlink</b>	2110 to 2155
<b>Emission Designator</b>	F9W,G7D,GXW,G7W

**EUT Operation during Tests**

The EUT was in a normal operating condition.

Note: An additional signal generator was needed to be on at all times to provide a “clock” to keep the EUT functioning



## Licensing and Module and Frequency Range Cross Reference

<b>Module Licensing vs and Module and Frequency Range</b>		
<b>FCC ID</b>	<b>Model Name</b>	<b>Frequency Range (MHz)</b>
W6UHMAWS1M	MRDU-AWS1-B	2110-2155



## Test Result Summary

Specification	Test Name	Pass, Fail, N/A	Comments
Part 27	Carrier Output Power	Pass	
Part 27	Spurious Emissions (Transmitter Conducted)	Pass	
Part 27	Spurious Emissions (Transmitter Radiated)	Pass	
Part 27	Intermodulation	Pass	
Part 27	Occupied Bandwidth	Pass	
Part 27	Out of Band Rejection	Pass	
Part 27	Frequency Stability (Temperature Variation)	N/A	The EUT does not perform frequency translation
Part 27	Frequency Stability (Voltage Variation)	N/A	The EUT does not perform frequency translation



**Carrier Output Power**

**Name of Test:** Carrier Output Power  
**Test Equipment Utilized:** i00405, i00266, i00379

**Engineer:** Mike Graffeo  
**Test Date:** 5/5/14

**Test Procedure**

The EUT was connected to a spectrum analyzer through a 40 dB power attenuator. A signal generator was utilized to produce a CW input signal. The RF input level was increased while monitoring the output power. The input RF drive level was increased until the EUT output reached saturation (the output stopped increasing) whereby the maximum power level and gain was achieved. The downlink power and gain levels for the low, middle, and high channels are recorded in the following table.

**Test Setup**

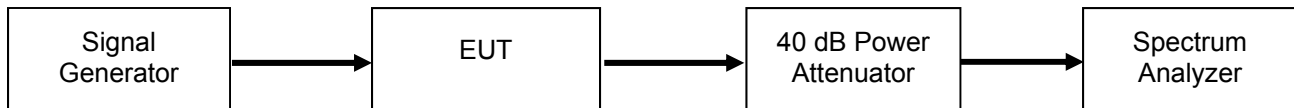





## Downlink Test Results

### 2110 - 2155 MHz Band

Tuned Frequency (MHz)	Input Power (dBm)	Output Power (dBm)	Gain (dB)
2110	-14.1	37	51.1
2132.5	-14.0	37	51.0
2155	-14.1	37	51.1



**Spurious Emissions (Transmitter Conducted)**

**Name of Test:** Spurious Emissions (Transmitter Conducted) **Engineer:** Mike Graffeo  
**Test Equipment Utilized:** i00405, i00266, i00379 **Test Date:** 5/8/14

**Test Procedure**

The EUT was connected to a spectrum analyzer through a 40 dB power attenuator. Two signal generators were utilized to produce a two tone signal with the channel spacing set so the intermodulation products fell within the operational band. The input signal level was increased until the intermodulation products were as close as possible to the maximum allowable level of -13 dBm without being greater than that limit. The downlink conducted spurious emissions were examined to beyond the 10<sup>th</sup> harmonic of the fundamental signal and no spurious emissions were detected. The two tones selected were near the center of the operational band and as there were no detectable emissions only a single test was performed per operational band. The worst case out of band emission for each operational band is indicated in the table below. Plots are provided to show there are no additional emissions.

**Test Setup**

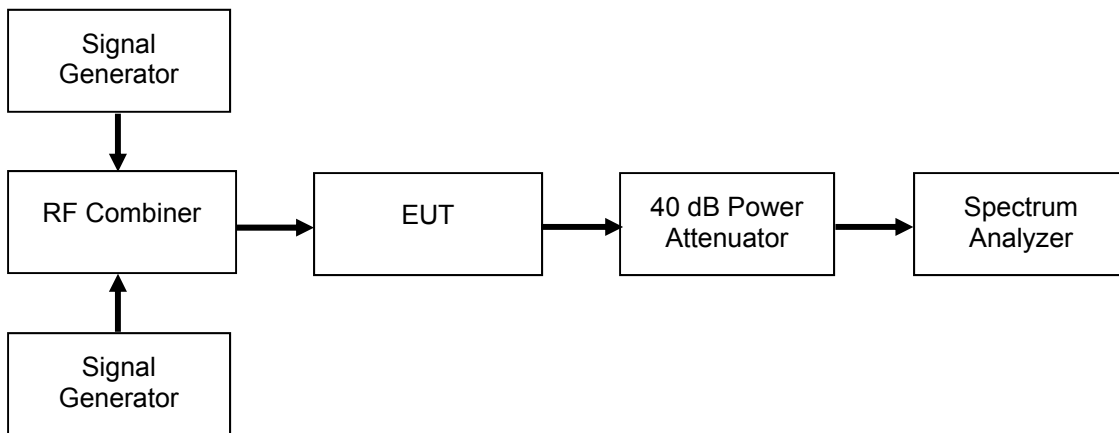

**Test Results**

Frequency Band (MHz)	Measured Level (dBm)	Limit (dBm)	Margin (dB)	Result
2110 to 2155	-35.57	-13	-22.57	Pass

**Note 1:** The peaks in the plots without a marker represent the two tone signal at which the EUT was tested with (fundamental frequency).



### Downlink Test Plots

2110 – 2155 MHz Band  
30 MHz to 1 GHz

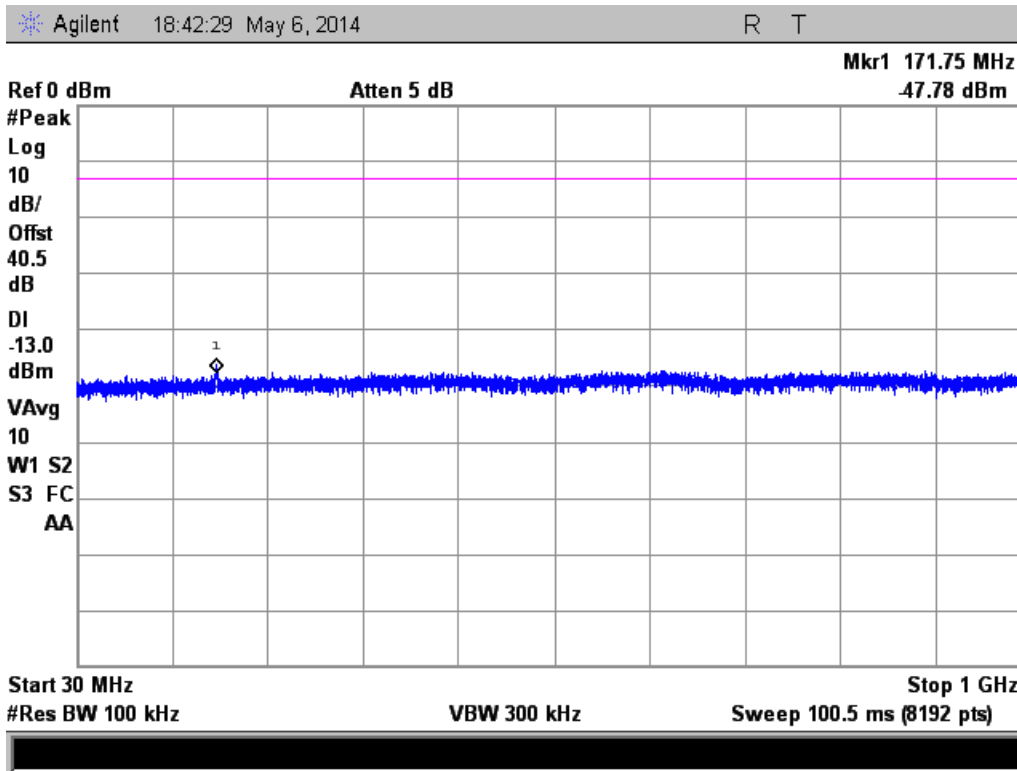

2110 – 2155 MHz Band  
1 GHz to 4 GHz

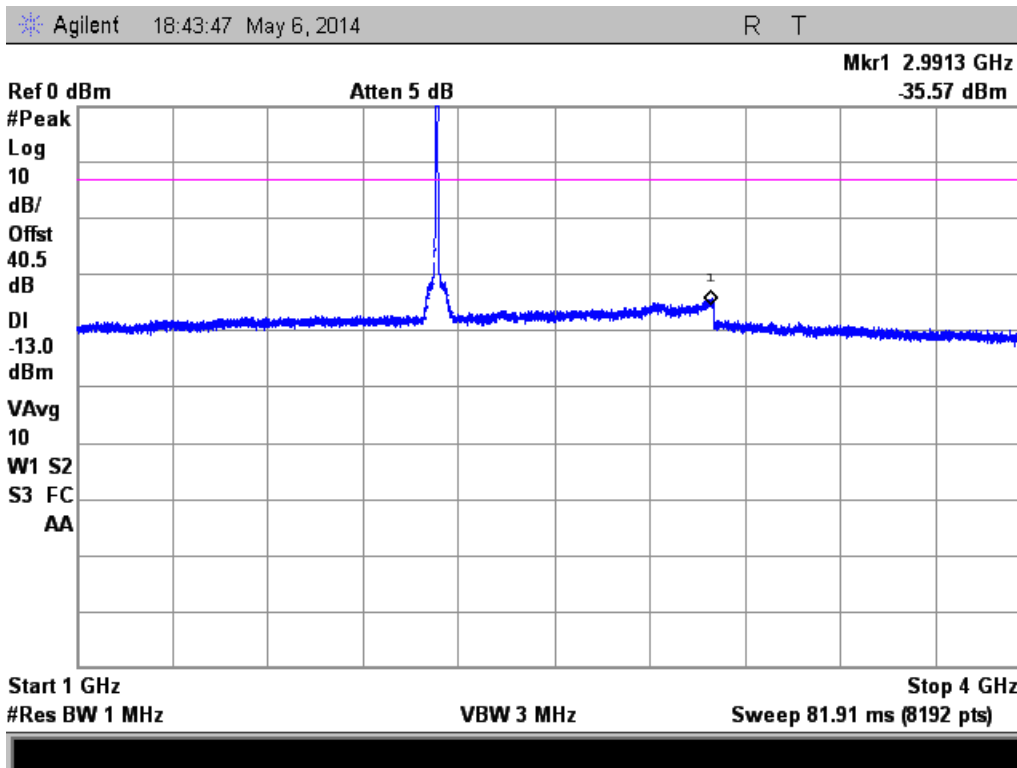



### 2110 – 2155 MHz Band 4 GHz to 8 GHz

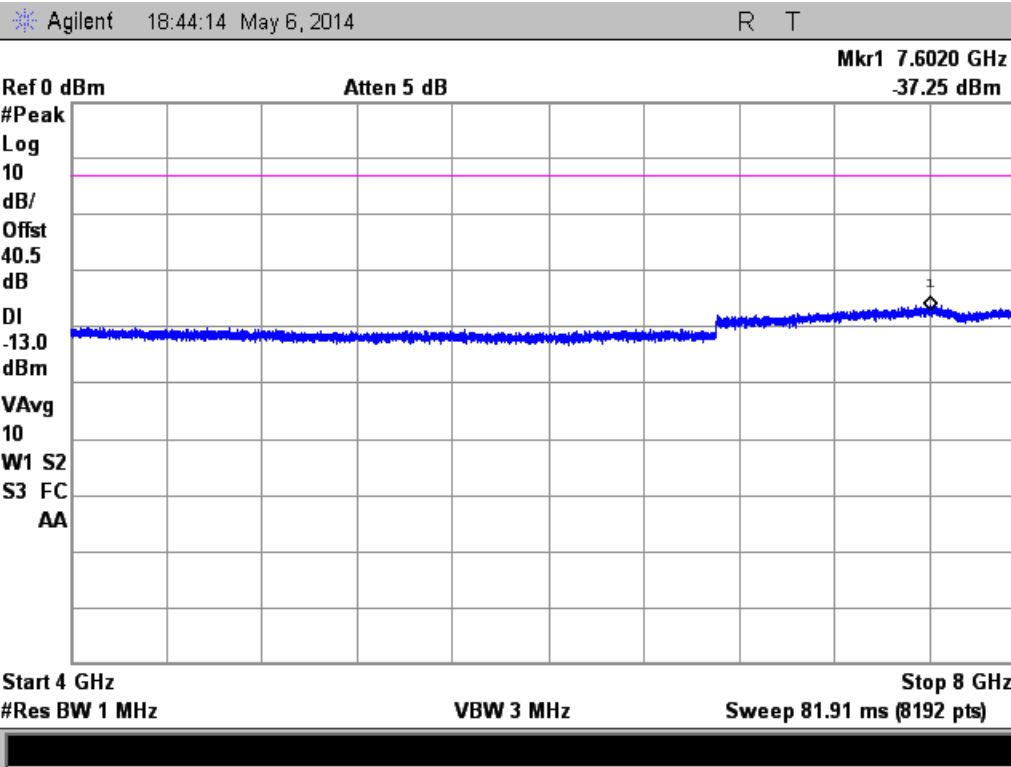

### 2110 – 2155 MHz Band 8 GHz to 12 GHz

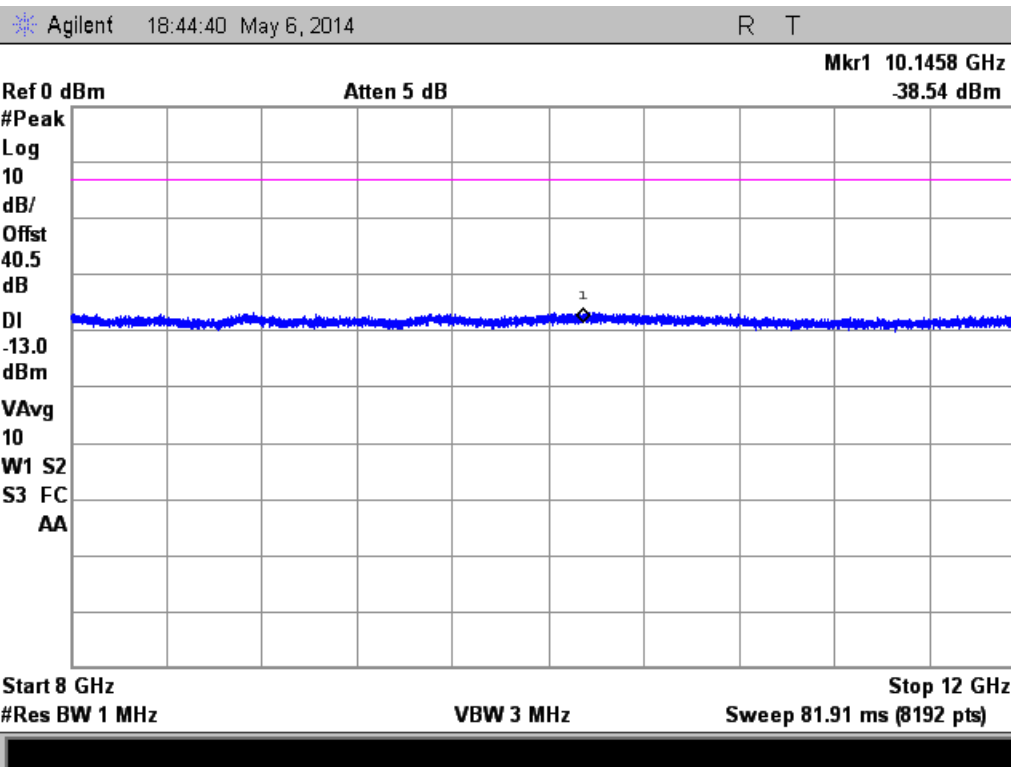



### 2110 – 2155 MHz Band 12 GHz to 16 GHz

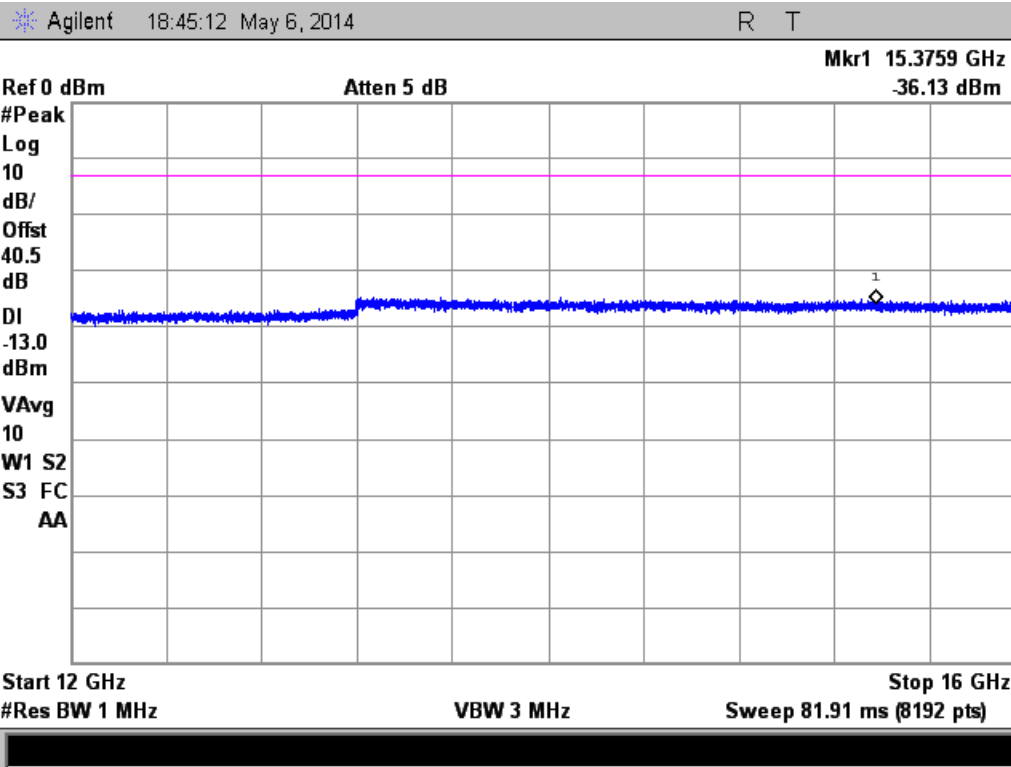

### 2110 – 2155 MHz Band 16 GHz to 20 GHz

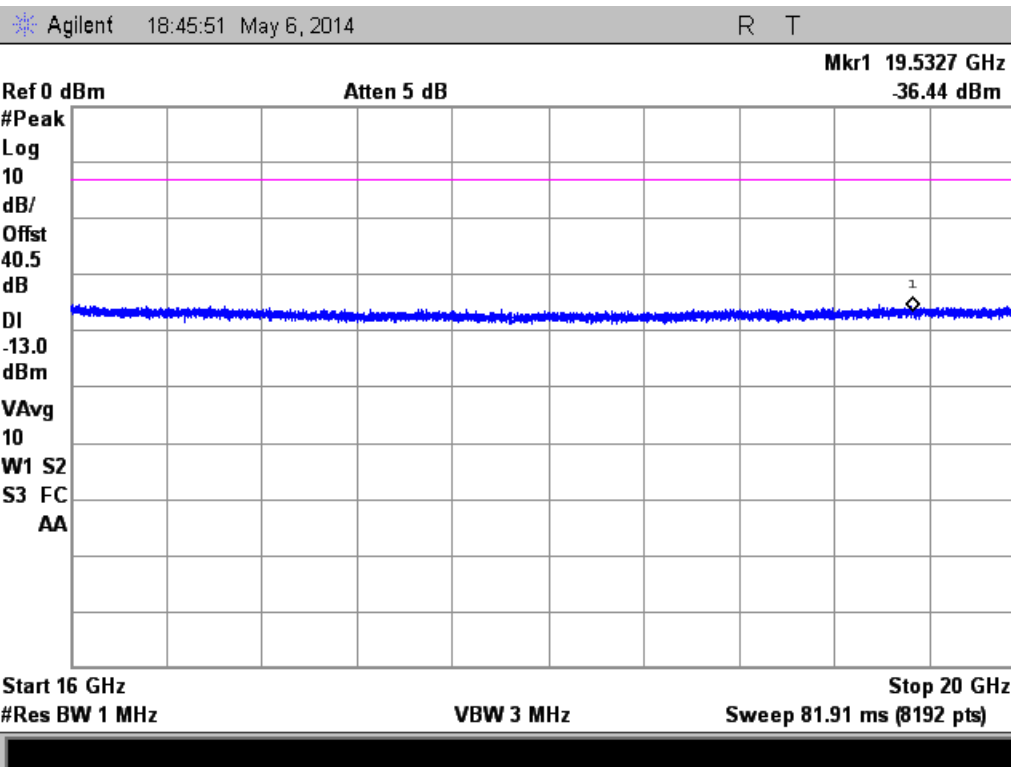



### 2110 – 2155 MHz Band 20 GHz to 24 GHz

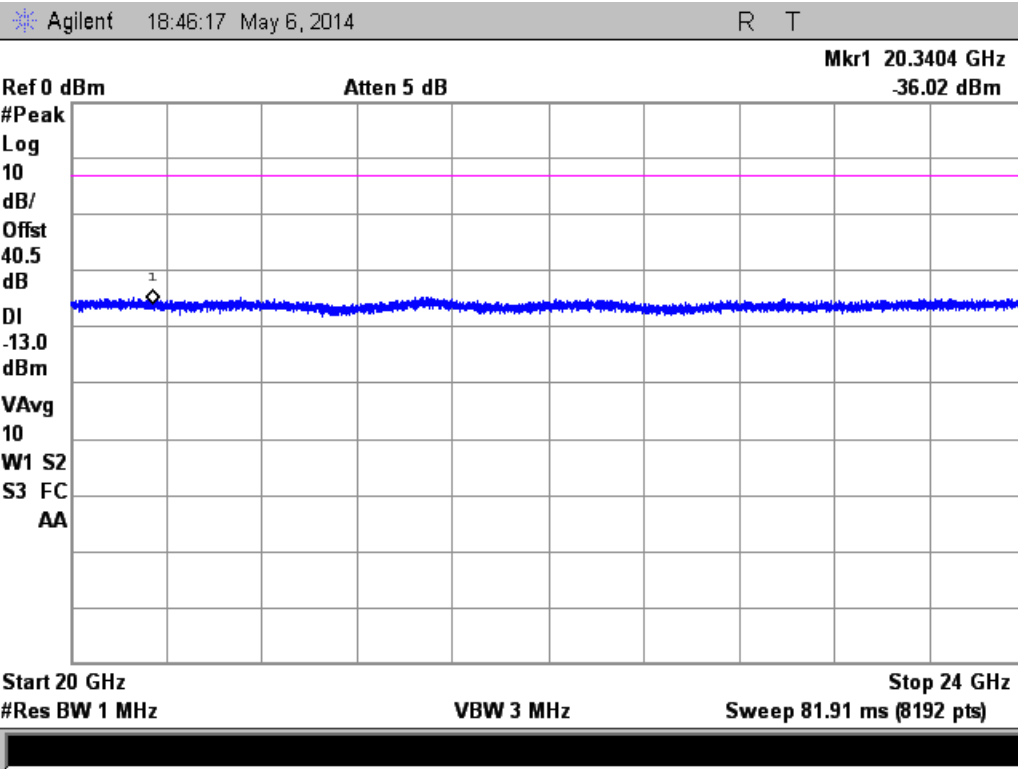



## Spurious Emissions (Transmitter Radiated)

**Name of Test:** Spurious Emissions (Transmitter Radiated)

**Engineer:** Mike Graffeo

**Test Equipment Utilized:** i00405, i00266, i00379, i00103

**Test Date:** 5/7/14

### Test Procedure

- A) Connect the equipment as illustrated below.
- B) Adjust the spectrum analyzer to the following settings:
  - 1) Resolution Bandwidth 100 kHz (< 1 GHz), 1 MHz (> 1GHz)
  - 2) Video Bandwidth  $\geq 3$  times Resolution Bandwidth, or 30 kHz
  - 3) Sweep Speed  $\leq 2000$  Hz/second
  - 4) Detector Mode = Mean or Average Power
- C) Place the transmitter to be tested on the turntable in the standard test site. The transmitter is transmitting into a non-radiating load that is placed on the turntable. The RF cable to this load should be of minimum length.
- D) For each spurious measurement the test antenna should be adjusted to the correct length for the frequency involved. This length may be determined from a calibration ruler supplied with the equipment. Measurements shall be made from the lowest radio frequency generated in the equipment to the tenth harmonic of the carrier, except for the region close to the carrier equal to  $\pm$  the test bandwidth (see Section 1.3.4.4).
- E) For each spurious frequency, raise and lower the test antenna from 1 m to 4 m to obtain a maximum reading on the spectrum analyzer with the test antenna at horizontal polarity. Repeat this procedure to obtain the highest possible reading. Record this maximum reading.
- F) Repeat Step E) for each spurious frequency with the test antenna polarized vertically.
- G) Reconnect the equipment as illustrated.
- H) Keep the spectrum analyzer adjusted as in Step B).
- I) Remove the transmitter and replace it with a substitution antenna (the antenna should be half wavelength for each frequency involved). The center of the substitution antenna should be approximately at the same location as the center of the transmitter. At lower frequencies, where the substitution antenna is very long, this will be impossible to achieve when the antenna is polarized vertically. In such case the lower end of the antenna should be 0.3 m above the ground.
- J) Feed the substitution antenna at the transmitter end with a signal generator connected to the antenna by means of a non-radiating cable. With the antennas at both ends horizontally polarized and with the signal generator tuned to a particular spurious frequency, raise and lower the test antenna to obtain a maximum reading at the spectrum analyzer. Adjust the level of the signal generator output until the previously recorded maximum reading for this set of conditions is obtained. This should be done carefully repeating the adjustment of the test antenna and generator output.
- K) Repeat Step J) with both antennas vertically polarized for each spurious frequency.
- L) Calculate power in dBm into a reference ideal half-wave dipole antenna by reducing the readings obtained in Steps J) and K) by the power loss in the cable between the generator and the antenna and further corrected for the gain of the substitution antenna used relative to an ideal half-wave dipole antenna.
- M) The levels recorded in Step L) are absolute levels of radiated spurious emissions in dBm. The radiated spurious emissions in dB can be calculated by the following:  
$$\text{Radiated spurious emissions dB} = 10\log_{10}(\text{TX power in watts}/0.001) - \text{the levels in Step I)}$$

*NOTE: It is permissible that the other antennas provided can be referenced to a dipole.*



### Test Setup

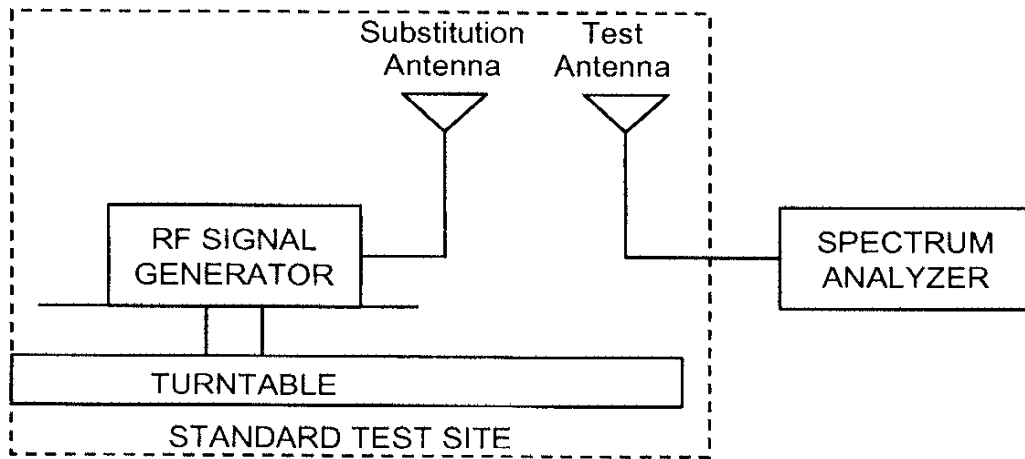
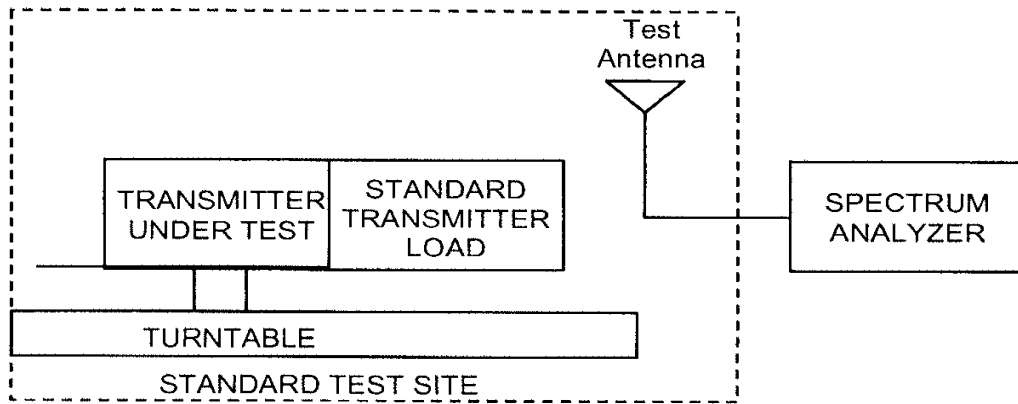





### Downlink Test Results

#### 2110 - 2155 MHz Band 2132.5 MHz Tuned Frequency

Measured Frequency (MHz)	Measured Level (dBm)	Limit (dBm)	Margin (dB)	Result
4265	-35.93	-13	-22.93	Pass
6397.5	-32.03	-13	-19.03	Pass
8530	-18.50	-13	-5.50	Pass

The conducted spurious emissions testing did not indicate any potential failures therefore only the center channel of each operational band was evaluated.

No other emissions were detected. All emissions were lower than -13 dBm.



### Intermodulation

**Name of Test:** Intermodulation  
**Test Equipment Utilized:** i00405, i00266, i00379

**Engineer:** Mike Graffeo  
**Test Date:** 5/7/14

### Test Procedure

The EUT was connected to a spectrum analyzer through a 40 dB power attenuator. Two signal generators were utilized to produce a two tone signal with the channel spacing set so the intermodulation products fell within the operational band. The input signal level was increased until the intermodulation products were as close as possible to the maximum allowable level of -13 dBm without being greater than that limit. The downlink intermodulation products within the operational band were examined. The two tones near the lower edge and the upper edge were plotted. The input signal level, peak output power, and intermodulation level are listed in the summary table.

### Test Setup

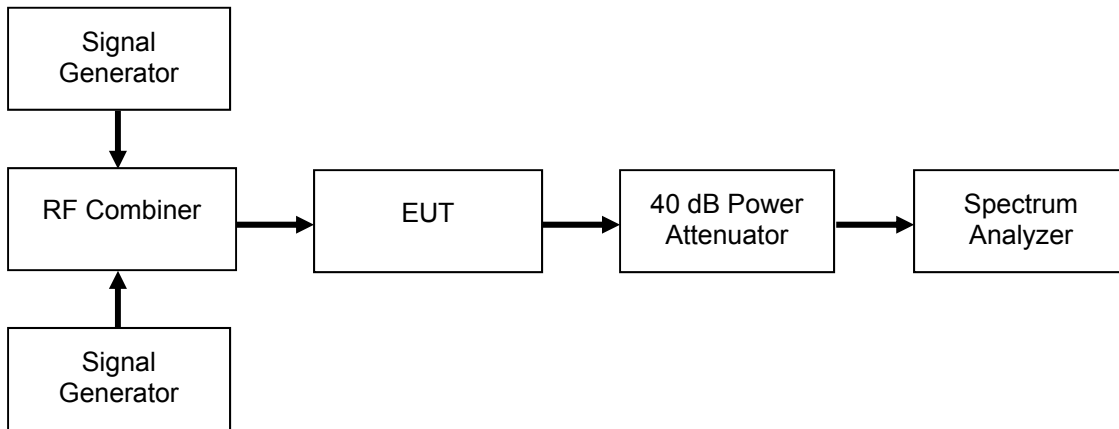



### Downlink Test Results

#### 2110 - 2155 MHz Band

<b>P<sub>01</sub> – P<sub>02</sub> Frequency Pair (MHz)</b>	<b>Input Power (dBm)</b>	<b>Intermodulation Level (dBm)</b>	<b>P<sub>01</sub> (dBm)</b>	<b>P<sub>mean</sub> (dBm)</b>	<b>Gain (dB)</b>
2120 - 2125	-14.90	-19.23	34.48	37.48	49.38
2140 - 2145	-14.40	-15.04	34.29	37.29	48.69



### Downlink Test Plots 2110 - 2155 MHz Band

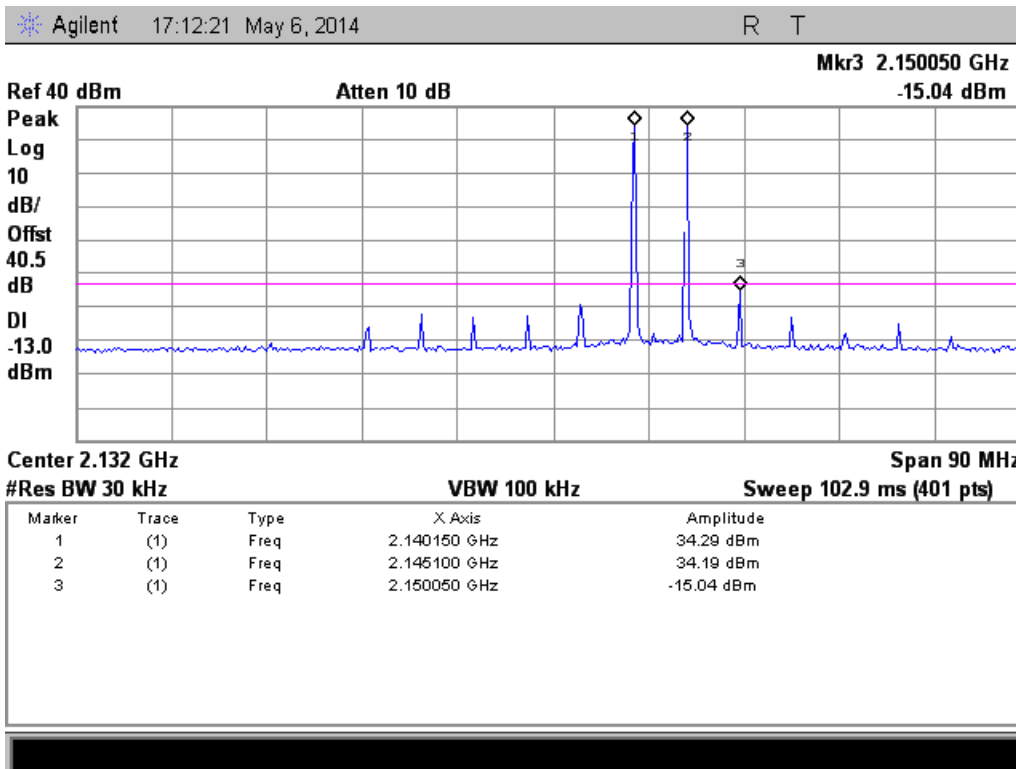
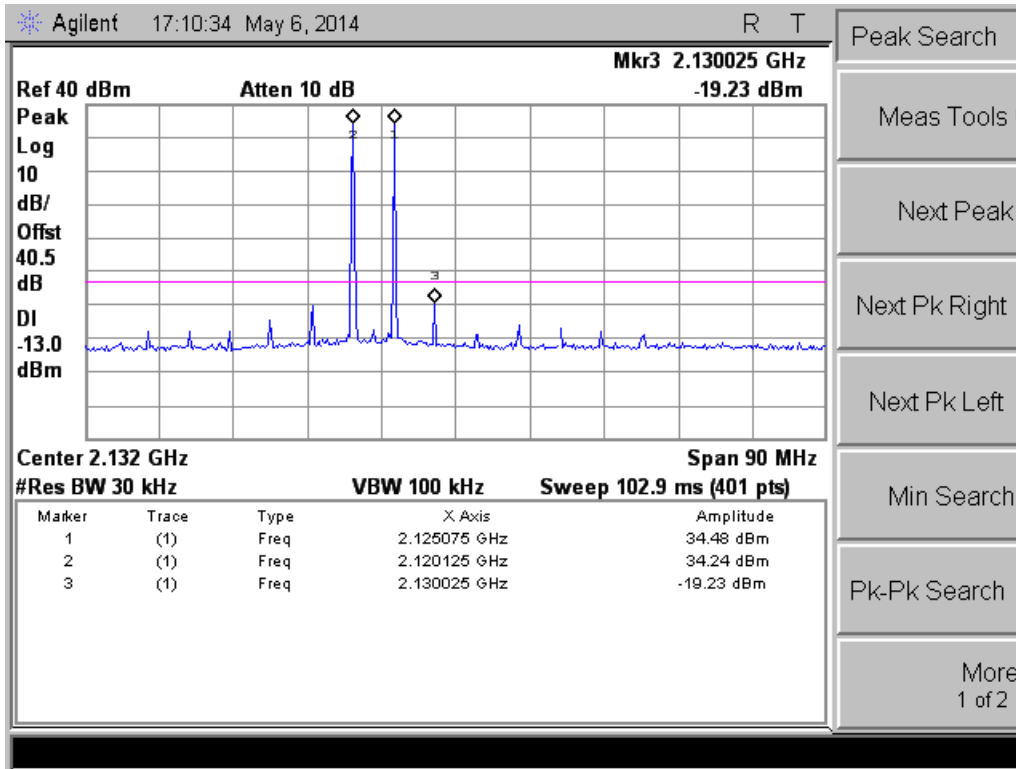



### Occupied Bandwidth

**Name of Test:**

Occupied Bandwidth

**Engineer:** Mike Graffeo

**Test Equipment Utilized:**

i00405, i00266, i00379

**Test Date:** 5/7/14

### Test Procedure

The EUT was connected to a spectrum analyzer through a 40 dB power attenuator as required. A signal generator was utilized to produce the following signals; GSM, CDMA, and WCDMA. The RF input level was set to the level as determined by the intermodulation testing requirements. The input and output spectrums were observed and the plots captured to ensure that the signals remained similar with minimal non-linearity in accordance to FCC guidelines. The center channel of each band was measured. All emissions are within the pass band.

### Test Setup

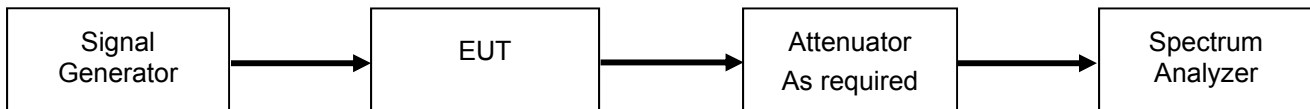



### GSM Downlink Test Plots

2110 - 2155 MHz Band

Input

Agilent 17:27:40 May 6, 2014 R T

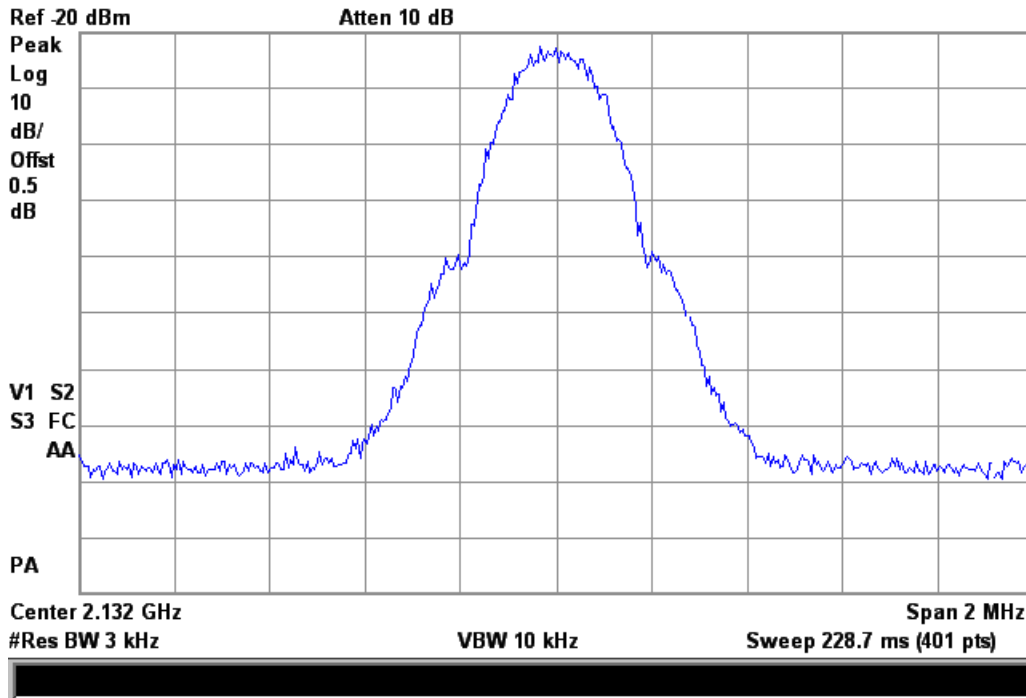

Output

Agilent 17:44:39 May 6, 2014 R T

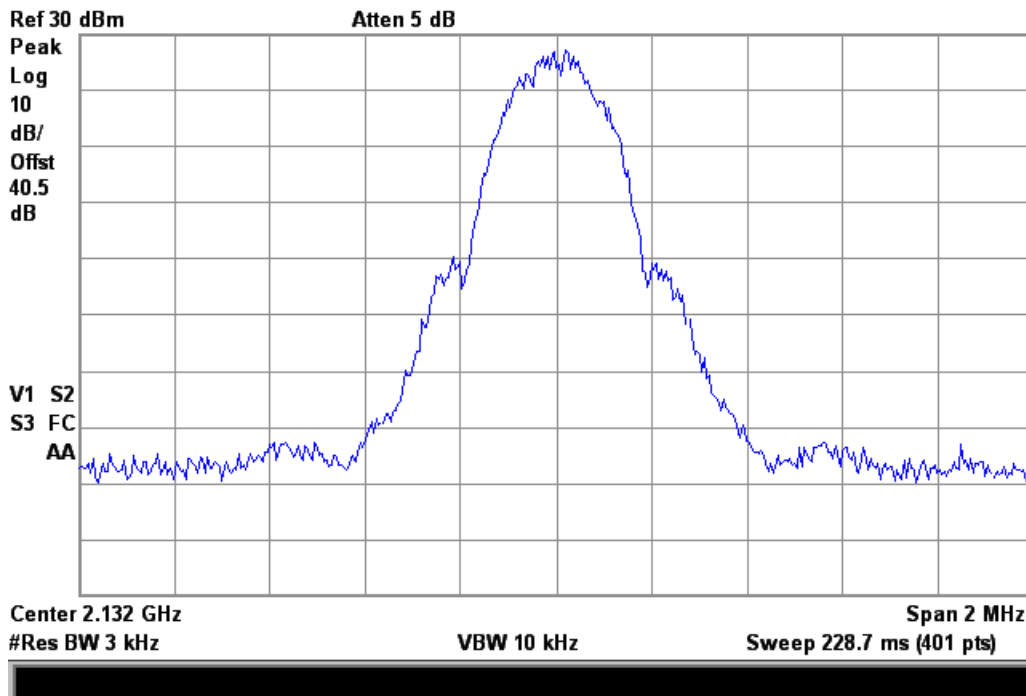



### CDMA Downlink Test Plots

#### 2110 - 2155 MHz Band

#### Input

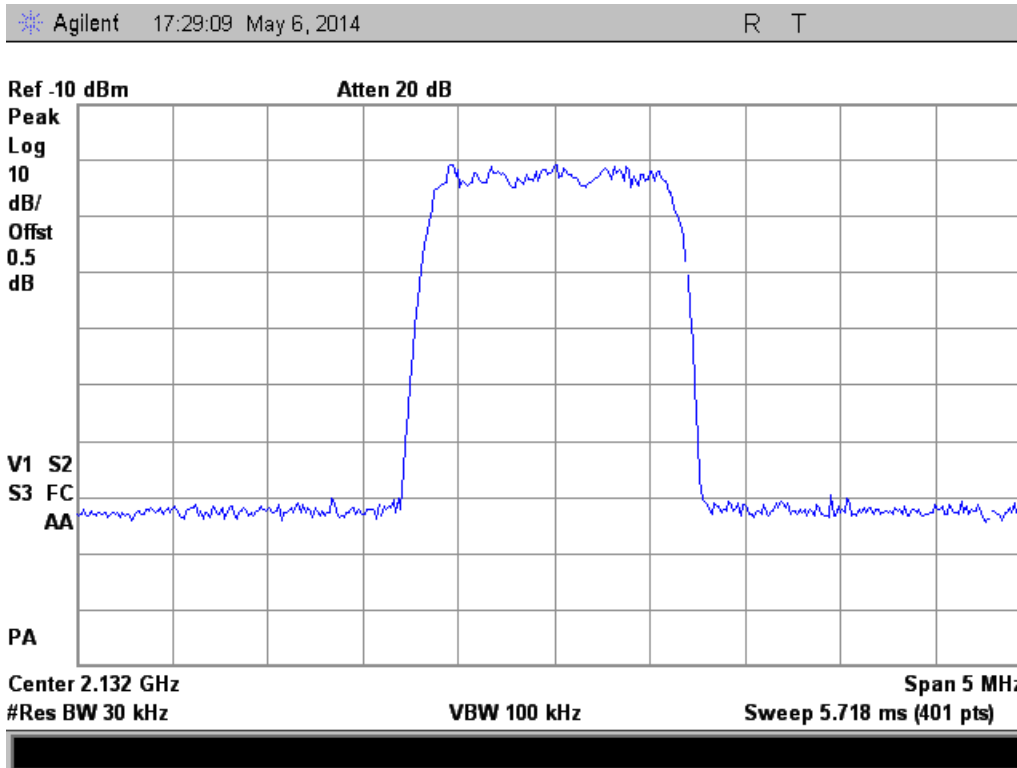

#### Output

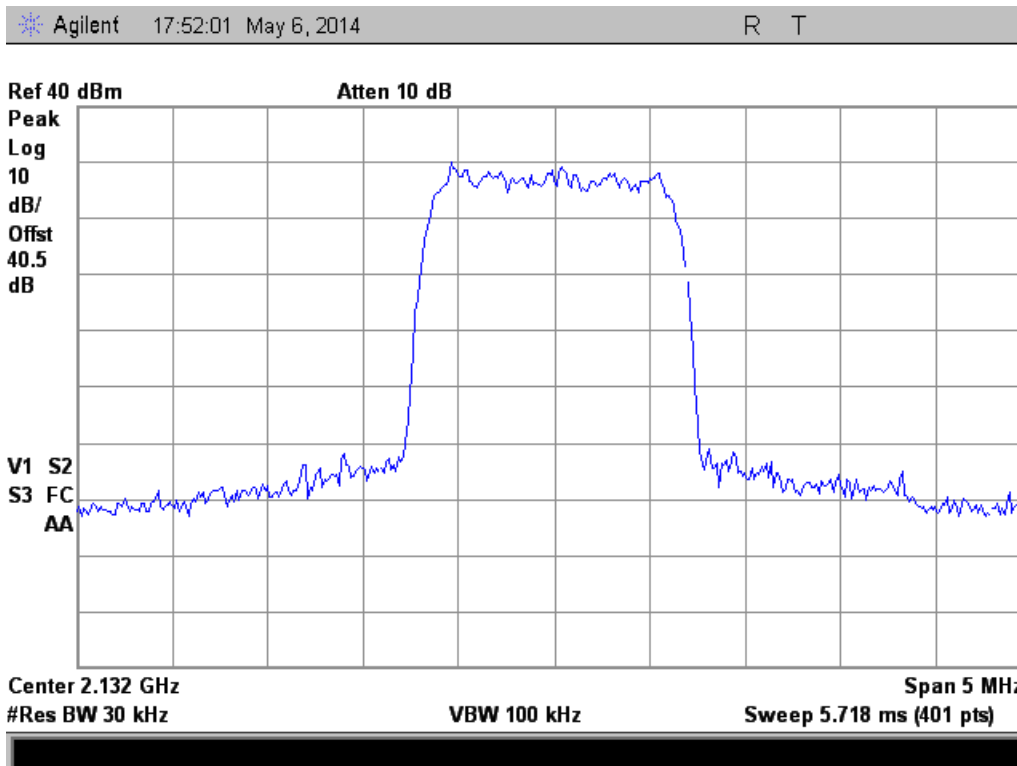



### WCDMA Downlink Test Plots

#### 2110 - 2155 MHz Band

#### Input

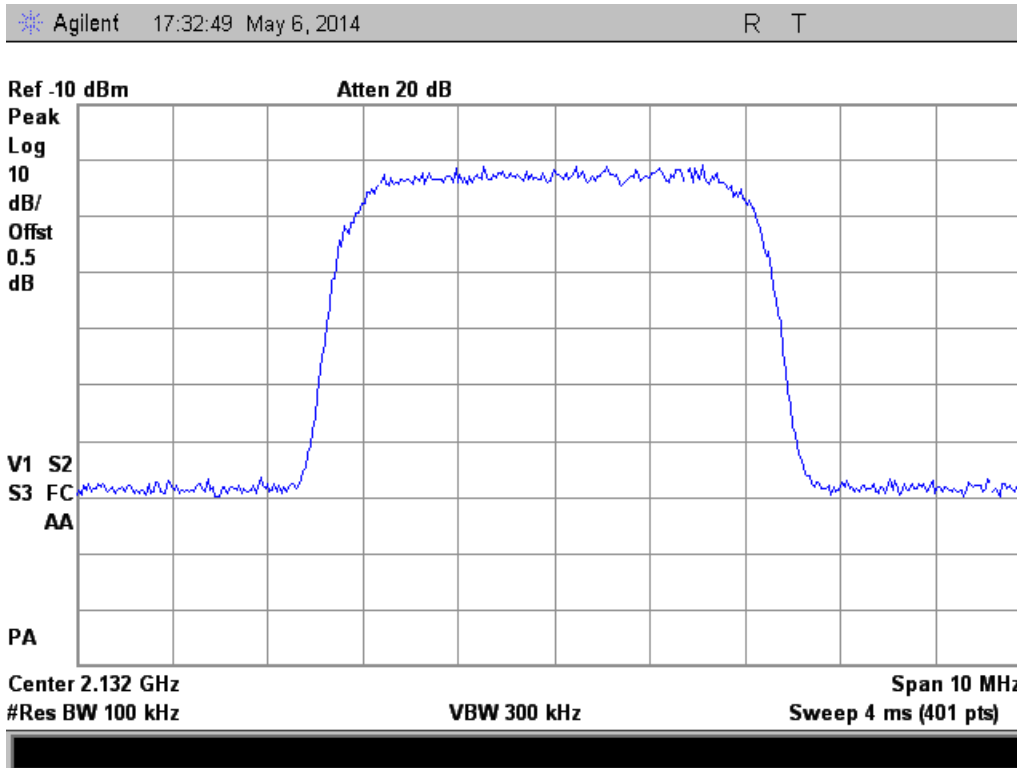

#### Output

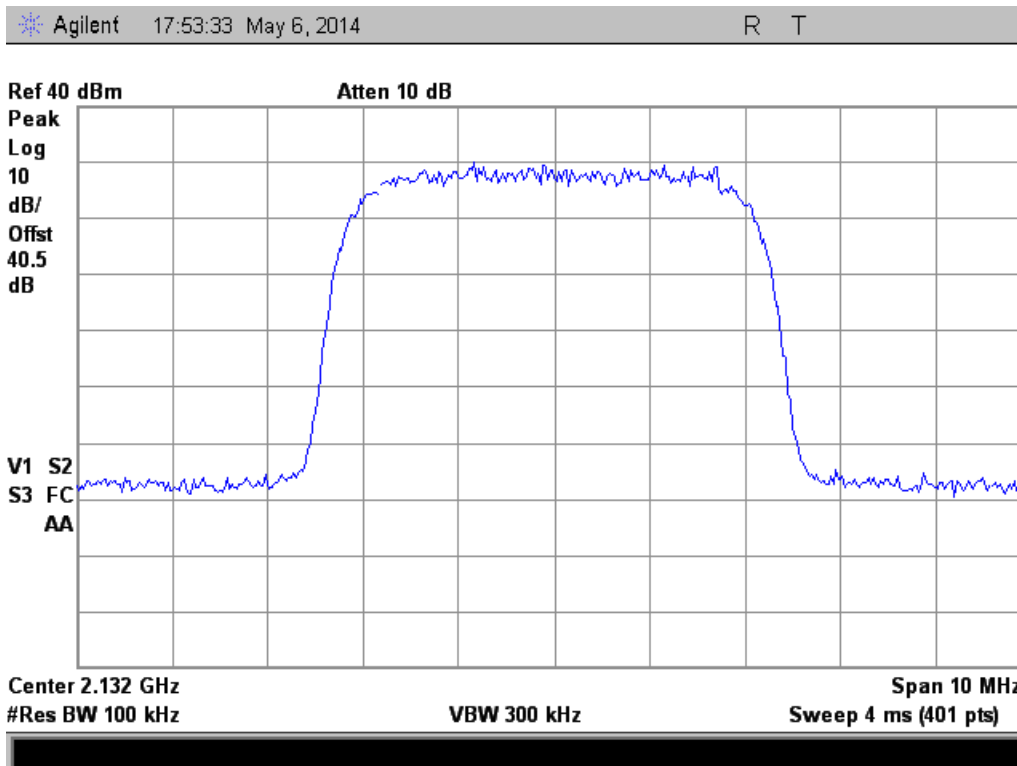





## Out of Band Rejection

**Name of Test:** Out of Band Rejection  
**Test Equipment Utilized:** i00405, i00266, i00379

**Engineer:** Mike Graffeo  
**Test Date:** 5/7/14

### Test Procedure

The EUT was connected to a spectrum analyzer through a 40 dB power attenuator. A signal generator was utilized to produce a swept CW signal with the RF input level set to the level determined by the intermodulation testing requirements. The downlink filter response and bandwidth were measured. The marker table function of the spectrum analyzer was used to show the band edges and the 20 dB bandwidth of the pass band filter.

### Test Setup





### Downlink Test Plots

### 2110 - 2155 MHz Band

Agilent 12:08:12 May 5, 2014 R T

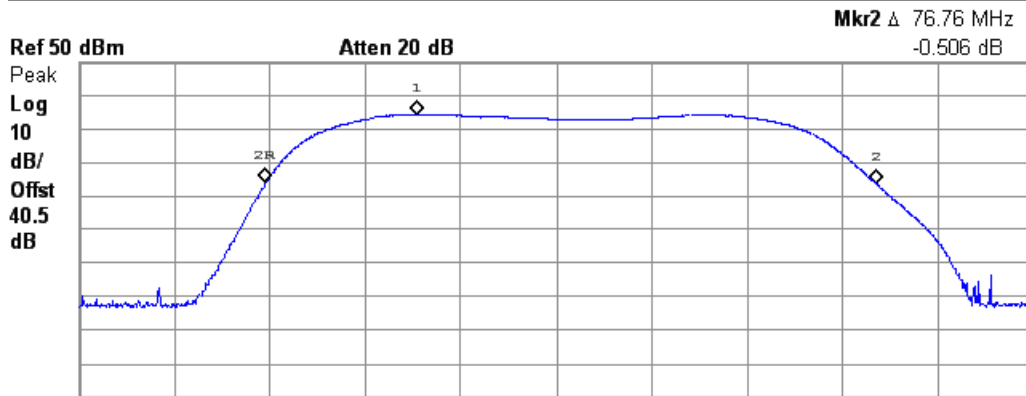



### Test Equipment Utilized

Description	Manufacturer	Model #	CT Asset #	Last Cal Date	Cal Due Date
Signal Generator	Rohde & Schwarz	SMU200A	i00405	12/11/13	12/11/14
Signal Generator	Rohde & Schwarz	SMT03	i00266	5/1/14	5/1/15
Humidity / Temp Meter	Newport	IBTHX-W-5	i00282	3/24/14	3/24/15
EMI Analyzer	Agilent	E7405A	i00379	1/14/14	1/14/15
Horn Antenna	EMCO	3115	i00103	12/11/12	12/11/14
Power Attenuator	Lucas Weinschel	24-40-12	S/N: AY3295	Verified on: 8/19/13	

In addition to the above listed equipment standard RF connectors and cables were utilized in the testing of the described equipment. Prior to testing these components were tested to verify proper operation.

END OF TEST REPORT



**Test Setup Photos**  
**FCC ID: W6UHMAWS1M**

**RF Test Setup**



**Radiated Test Setup**

