



HERCULES(Alliance 5W Remote Unit)

User Manual

SOLiD, Inc.

10,9th Floor, SOLiD Space220 Pangyoyeok-ro, Bundang-gu, Seongnam-si, Gyeonggi-do, Korea 393-400

Tel : +82-31-627-6290 Fax : +82-31-627-6209

REVISION HISTORY

Version	Issue Date	No. of Pages	Initials	Details of Revision Changes
V 1.0	September. 07, 2014		Original	
V1.1	June 29, 2017	all	Update	Change the model name from AWS-1_M to AWS13_M (Updated RDU CPU Firmware)
V1.2	Sep 9, 2017	37,38	Update	Change name of Gain item Gain[dB] to Gain[dB] (Only RU)
V1.3	June 26, 2019	all	Update	Add the new band module, 600LTE
V1.4	March 26, 2020	all	Update	Add 900ISM

Technical Support

SOLiD serial numbers must be available to authorize technical support and/or to establish a return authorization for defective units. The serial numbers are located on the back of the unit, as well as on the box in which they were delivered. Additional support information may be obtained by accessing the SOLiD Tehcnology, Inc. website at www.solid.co.kr or send emailat kehan@solid.co.kr

This manual is produced by Global Business Division Business Team 1. Printed in Korea.

Contents

Section1	Safety & Certification Notice	5
Section2	Introduction	9
2.1	Purpose	10
2.2	HERCULES	11
Section3	Functional Description	12
3.1	General	13
3.2	Component of HERCULES Remote Unit	14
3.3	Dimension	16
Section4	System Installation	17
4.1	Remote Unit Installation	19
4.1.1	Remote Unit Enclosure installation	19
4.1.2	How to expand ADD ON ROU at the Remote Unit	23
4.1.3	Remote Unit Power Cabling	25
4.1.4	Remote Unit Ground cabling	26
4.1.5	Optical Cabling	28
4.1.6	Mounting of MRDU	30
Section5	System Specifications	35
5.1	Physical Specifications	36
5.2	RF performance	37
5.3	Certification	38

Contents of Figure

Figure 3.1 – Remote Unit Block Diagram.....	13
Figure 3.2 – Inside of Remote Unit	14
Figure 3.3 – RemoteUnit Dimension.....	16
Figure 4.1 – Exterior of Remote Unit.....	19
Figure 4.2 – Dimension used to install REMOTEUNIT on the WALL	20
Figure 4.3 – Procedures of installation	21
Figure 4.5 – Connection diagram between Remote Unit and ADD ON ROU (DC type)	24
Figure 4.6 – Location of Ground Terminal	26
Figure 4.7 – Information of Terminal	26
Figure 4.8 – How to install Ground Terminal	27
Figure 4.9 – Location of Optical Connector	28
Figure 4.10 – Information of Optical Connector.....	28
Figure 4.11 – How to install Optical Cabling.....	29
Figure 4.12 – Location of MRDU	30
Figure 4.13 – How to mount MRDU	31
Figure 4.14 – How to mount FAN Unit	32
Figure 4.15 – How to mount FAN Unit	33

Section1

Safety & Certification Notice

“Only qualified personnel should handle the DAS equipment. Any person involved in installation or service of the DAS should understand and follow these safety guidelines.”

- Obey all general and regional safety regulations relating to work on high voltage installations, as well as regulations covering correct use of tools and personal protective equipment.
- The power supply unit in repeaters contains dangerous voltage level, which can cause electric shock. Switch the mains off prior to any work in such a repeater. Any local regulations are to be followed when servicing repeaters.
- To prevent electrical shock, switch the main power supply off prior to working with the DAS System or Fiber BDA. Never install or use electrical equipment in a wet location or during a lightning storm.
- When working with units outdoors, make sure to securely fasten the door or cover in an open position to prevent the door from slamming shut in windy conditions.
- Use this unit only for the purpose specified by the manufacturer. Do not modify or fit any spare parts that are not sold or recommended by the manufacturer. This could cause fires, electric shock or other injuries.
- Do not operate this unit on or close to flammable materials, as the unit may reach high temperatures due to power dissipation.
- Do not use any solvents, chemicals, or cleaning solutions containing alcohol, ammonia, or abrasives on the DAS equipment. Alcohol may be used to clean fiber optic cabling ends and connectors.
- Do not look into the ends of any optical fiber or directly into the optical transceiver of any digital unit. Use an optical spectrum analyzer to verify active fibers. Place a protective cap over any radiating transceiver or optical fiber connector to avoid the potential of radiation exposure.
- Allow sufficient fiber length to permit routing without severe bends.
- For pluggable equipment, make sure to install the socket outlet near the equipment so that it is easily accessible.
- Certification
 - FCC: This equipment complies with the applicable sections of Title 47 CFR Parts 15,22,24,27 and 90
 - UL/CUL: This equipment complies with UL and CUL 1950-1 Standard for safety for information technology equipment, including electrical business equipment
 - FDA/CDRH: This equipment uses a Class 1 LASER according to FDA/CDRH Rules. This product conforms to all applicable standards of 21 CFR Chapter 1, Subchapter J, Part 1040

- A readily accessible disconnect device shall be incorporated external to the equipment.
- This power of this system shall be supplied through wiring installed in a normal building.
If powered directly from the mains distribution system, it shall be used additional protection, such as overvoltage protection device
- Only 50 ohm rated antennas, cables and passive equipment shall be used with this remote. Any equipment attached to this device not meeting this standard may cause degradation and unwanted signals in the bi-directional system. All components connected to this device must operate in the frequency range of this device.
- Only 50 ohm rated antennas, cables and passive components operating from 150 - 3 GHz shall be used with this device.
- The head end unit must always be connected to the Base Station using a direct cabled connection. This system has not been approved for use with a wireless connection via server antenna to the base station.
- Round terminals located on the side of a 1 mm² (16 AWG) or more wires Using permanently connected to earth.(green/yellow color)
- Access can only be gained by SERVICE PERSONS or by USERS who have been instructed about the reasons for the restrictions applied to the location and about any precautions that shall be taken; and

- Access is through the use of a TOOL or lock and key, or other means of security, and is controlled by the authority responsible for the location.

- Notice! Be careful not to touch the Heat-sink part due to high temperature.



- Use of, and/or coupling devices not conforming with ERP/EIRP and/or indoor-only restrictions is prohibited.

- Home/ personal use are prohibited.

- Signal booster warning label message should include

<FCC>

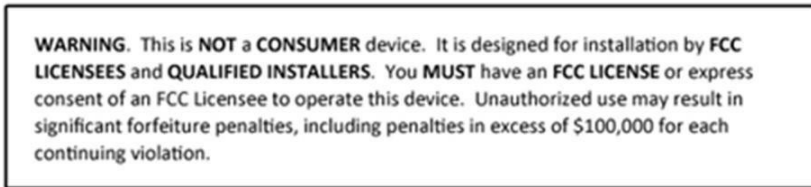

<IC>

WARNING: This is NOT a CONSUMER device. It is designed for installation by an installer approved by an ISED licensee. You MUST have an ISED LICENCE or the express consent of an ISED licensee to operate this device.



CAUTION
DOUBLE POLE/NEUTRAL FUSING

Section2

Introduction

-
- 2.1 Purpose
 - 2.2 HERCULES

2.1 Purpose

HERCULES is a coverage system for in-building services delivering voice and data in high quality and for seamlessly. As a distributed antenna system, it provides analog and digital phone systems that are served in multiple bands through one antenna. The system covers general public institutions and private facilities.

- Shopping malls
- Hotels
- Campus areas
- Airports
- Clinics
- Subways
- Multi-use stadiums, convention centers, etc.

The system helps improve in-building radio environments in poor condition and make better poor RSSI and Ec/Io. By providing communication services at every corner of buildings, the system enables users to make a call at any site of buildings. The system uses both analog (AMPS) and digital (TDMA, CDMA and WCDMA) methods. The HERCULES system supports communication standards and public interface protocols in worldwide use.

- Frequencies: 600MHz, 700MHz, 700MHz_MIMO, 850MHz, 900PA, 900 ISM, 1900MHz, 2100MHz, 2500MHz
- Voice protocols: AMPS, TDMA, CDMA, GSM, IDEN, etc.
- Data protocols: EDGE, GPRS, WCDMA, CDMA2000, Paging, LTE etc.

HERCULES is in modular structure per frequency. To provide desired frequency in a building, all you need to do is to insert a corresponding frequency module into each unit. As it delivers multiple signals with one optical cable, the system, in one-body type, does not require additional facilities whenever new frequency is added. The system is featured with the following:

- Flexibility & Scalability
- Support fiber-optic ports up to 60
- Clustering multiple-buildings (campus) as one coverage
- Modular structures
- Modular frequency upgrade
- Plug-in type module
- Multi-Band, Multi Operator

- Signals with a plurality of service provider transmits simultaneously
- Support multi-operator in a band
- Low OPEX / CAPEX
- Compact design
- Upgradable design
- Easy installation and maintenance

2.2 HERCULES

Hercules is one of series of Alliance DAS and has 5W composite output power for every band, excluding the 900ISM module.

RDU that is integrated on package with Duplexer, Power amplifier and RF unit can be mounted up to 6 in the enclosure.

Hercules transports signals that multiple operators and multiple technologies are moved at a same time from Base station to a remote location over the same fiber.

It is available in single and multi-band configuration supporting 600M, 700M, 700M MIMO , 850M , 800I , 900PA, 900ISM , 700P , 800P , 1700/2100M, 1700/2100MHz MIMO, 1900M, 2500M in parallel.

It has been specifically tested under a various air interfaces such as iDEN, GSM, CDMA2000, EV-DO, WCDMA, LTE , ect. The 900ISM module is specifically for use with the Kona Mega IOT Gateway as a source.

Section3

Functional Description

-
- 3.1 General
 - 3.2 Component of HERCULES Remote Unit
 - 3.3 Dimension

3.1 General

There are many components;

- R-Optic : Remote Optical Unit
- RCPU : Remote Central Processor Unit
- RPSU(AC) : Remote AC Power Supply Unit(When using the AC input power)
- RPSU(DC) : Remote DC Power Supply Unit(When using the DC input power)
- RDU1-6 : Remote Drive Unit
- CU1: CombiningUnit
- CU2: CombiningUnit

3.2 Component of HERCULES Remote Unit

Remote Unit receives TX optical signals from Head-End and converts them into RF signals. The converted RF signals are amplified through High Power Amp in a corresponding RDU, combined with Multiplexer module and then radiated to the antenna port.

When receiving RX signals through the antenna port, this unit filters out-of-band signals in a corresponding RDU and sends the results to Remote Optic Module to make electronic-optical conversion of them. After converted, the signals are sent to a upper device of ODU. ROU can be equipped with up to six RDUs (Remote Drive Unit). The following table describes components on Remote Unit

Unit	Description
RDU+BPF x6	Remote Drive Unit
	Filter and amplify TX signals
	Filter and amplify RX signals
	Remove other signals through BPF
RPSU(AC)	Remote AC Power Supply Unit
	Input power: 120 VAC +/- 10%
	Output power: +29 VDC
RPSU(DC)	Remote DC Power Supply Unit
	Input power: -48 VDC +/- 10%
	Output power: +29 VDC
R-OPTIC	Remote Optic
	Make RF conversion of TX optical signals;
	Convert RX RF signals into optical signals; Compensates optical loss
	Communicates with BIU/OEU though the FSK modem
	5dBo optical link between ODU(OM4) and ROU
	10dBo optical link between ODU(OM1) and ROU
	Fiber Connector: SC/APC Connector
	Fiber Type: Single Mode Fiber
Optical Wavelength: 1310/1550 WDM	
	Remote Central Processor Unit



RCPU	Controls signal of each unit
	Monitors BIU/ODU/OEU through FSK communication
CU1(Multiplexer)	CU1
	Combine TX signals from 7 RDUs; Distribute RX signals to 7 RDUs
	Furthermore, there is reserved RDU slot to support 2600LTE
ROU Enclosure	Enable you to use a single antenna port
	Enclosure to satisfy IP66
Input SIU	Vertical Mount
	Wall Mount
Output SIU	Input System Interface Unit
	Distributes power and signals to each module
Output SIU	Output System Interface Unit
	Interfacing with multiplexer

3.3 Dimension

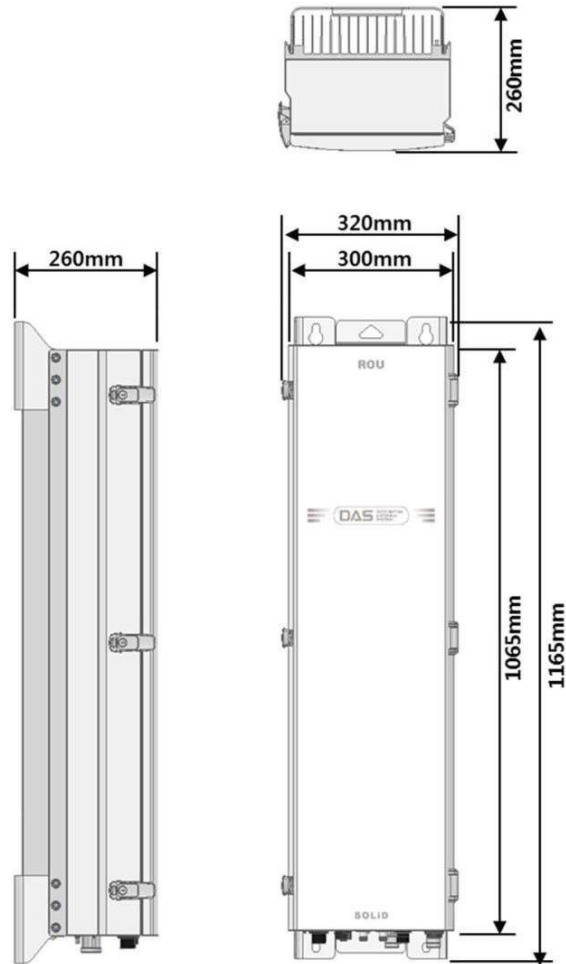

Figure 3.3 – Remote Unit Dimension

ITEM	SPECIFICATION	REMARK
Size(Width, Height, Depth)	320 x 1165 x 260mm	Including Bracket
Weight	62kg / 137lb	Fully loaded
Power Consumption	510W	Fully loaded
Operating Temperature	-25 to +55°C / -13 to 131°F	Ambient Temperature
Operating Humidity	0 to 90%, non-condensing	

Section4

System Installation

4.1 Remote Unit Installation

This chapter describes how to install each unit and optical cables, along with power cabling method. In detail, the chapter describes how to install shelves or enclosures of each unit, Power Cabling method and Optic Cabling and RF Interface. The needed accessories and tools are list up in the below table.

Steps for installation	Accessories	Included	Tool	Remark
Remote Enclosure Installation	M12 Bolt (4EA)	X	Spanner(19mm)	-
Power Connection_AC	AC 120V power cable (1EA) [2 meter, with MIL-5015 type Connector (MS-3106A- 18-10S) at one end, AC Plug at another end]	○	-	-
Power Connection_DC	DC -48V power cable (1EA) [2 meter, with MIL-5015 type Connector (MS-3106A- 18-10S) at one end, 4.5 ϕ square lugs at another end]	○	-	-
Optical Connection	Optical Cable Assembly Connector (1EA) [SOLI-FIBER-ASS'Y, by LTW]	○	-	For more details,

	OPTIC SC/APC Cable (1EA)	X	-	refer to 4.1.5
Ground Connection	M6 Screw (1EA)	○	No.2 Screw driver (+)	For more details,
	Lug (1EA)	○	Crimping Tool	refer to
	Max. AWG #6 Cable	X		4.1.4
Antennal Connection	RF Cable (1 or 2EA)	X	Spanner (33mm)	2 EA is required in case of MIMO.
MRDU Installation	-	-	No.1 Screw driver (+)	For more details, refer to 4.1.6
Connection with ADD ON ROU	AC power cable (1 EA) [1.5 meter, with MIL-5015 type Connector (MS-3106A-16-10S) and Circular Connector (C016_20H003_100_12, by LTW)]	○	-	-
	Data Interface cable (1 EA) [1.5 meter, with MIL-5015 type Connector (MS-3106A-14S-5S) at both ends]	○	-	-
	RF interface cable (2EA) [1.5 meter, with N male connector at both ends]	○	-	-
FAN Unit (Option)	Inner Fan Cable	○	Spanner (10mm)-	For more details,
	Fan Unit	○	-	
	M6 Screw (1EA)	X	No.2 Screw driver (+)	refer to 4.1.7

4.2 Remote Unit Installation

4.2.1 Remote Unit Enclosure installation

Remote Unit is designed to be water- and dirt-proof. The unit has the structure of one-Body enclosure. It satisfies water-proof and quake-proof standards equivalent of NEMA4(IP66). Basically Remote Unit is attached with wall mountable bracket. Remote Unit can be mounted into either of wall or on a pole.



Figure 4.1 – Exterior of Remote Unit

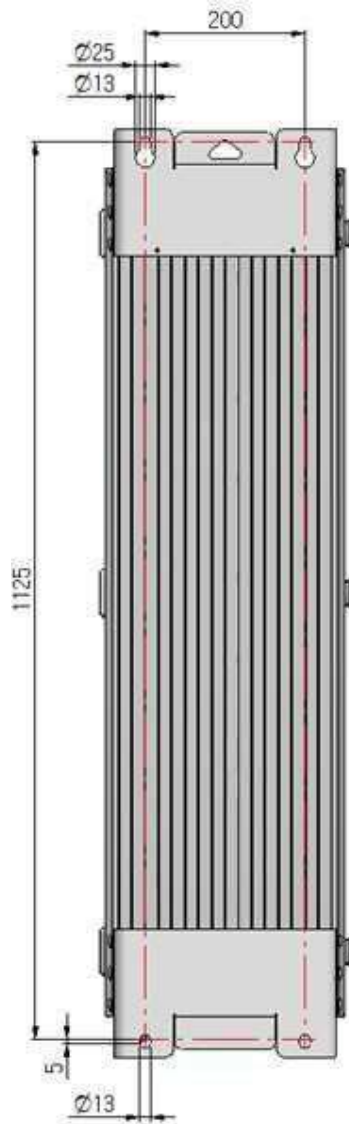

Figure 4.2 – Dimension used to install REMOTE UNIT on the WALL

Remote Unit Wall Mount Installation

Remote Unit's installation bracket is attached on Enclosure when is delivered. It doesn't need to remove bracket to install enclosure. simply after installing 4 of M12 mounting bolts, secure 4 mounting bolts tightly. First, install 2 of M12 mounting bolts roughly half way on the enclosure and install enclosure over the bolts and secure tightly.

Second, install 2 of M12 mounting bolts under the enclosure and secure tightly.

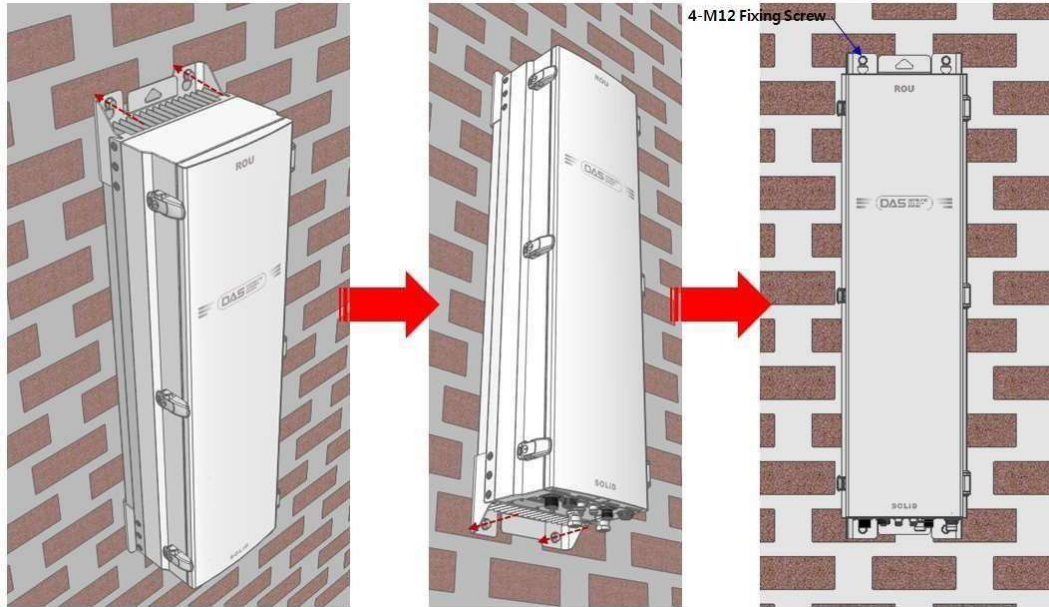

Figure 4.3 – Procedures of installation

Remote Unit Components

Remote Unit has the following components:





No.	Unit	Description	Remark
Common Part	Enclosure	Including Wall mounting bracket	1EA
	RCPU	-	1EA
	R_OPTIC	With SC/ACP adaptor(only Remote Unit)	1EA,optional
	RPSU	AC 120V or DC-48V	1EA
	Power Cable	MS Connector with 4 hole	1EA
	MRDU	MRDU-850CEL MRDU-1900PCS MRDU-AWS13 MRDU-2500LTE(Reserved) MRDU-600_700LTE_FN MRDU-2300WCS MRDU-900ISM	ANT1
	CU1	Internal Combiner unit for 600, 700, 850, 1900, 2100, 2300 and 2500	ANT1

Basically, the common part of Remote Unit should have an enclosure and it is equipped with RCPU to inquire and control state of each module, R_OPTIC to make both of electronic-optical and optical- electronic conversions, RPSU to supply power for Remote Unit. It should have Power Cable for external rectifier or to supply required power.

In addition, MRDU can be mounted and removed to provide service for desired band.

4.1.1 How to expand ADD ON ROU at the Remote Unit

Remote Unit can expand ARU up to 1. The three item is needed for connection between Remote Unit and ADD ON ROU. ADD ON ROU's components additively have 3 item except for enclosure like below

Accessories	Description	Qty	Specification	Remark
1	TX RF Cable	1	N(M)STtoSMA(M) ST_1.5M	
2	RX RF Cable	1	N(M)STtoSMA(M) ST_1.5M	
3	I/O Cable	1	IEC 61076-2- 101(8pin_F) ST_1.5m	
4	Power Cable (AC type only)	1	MIL-5015(16-10_F) ST to Circular(eco mate 3+PE_M) ST_1.5m	

The following picture shows the connection diagram between Remote Unit and ADD ON ROUs

For expanding ADD ON ROU at the Remote Unit within the proper cable length provided. The cables between Remote Unit and ADD ON ROU have each 1.5m length.

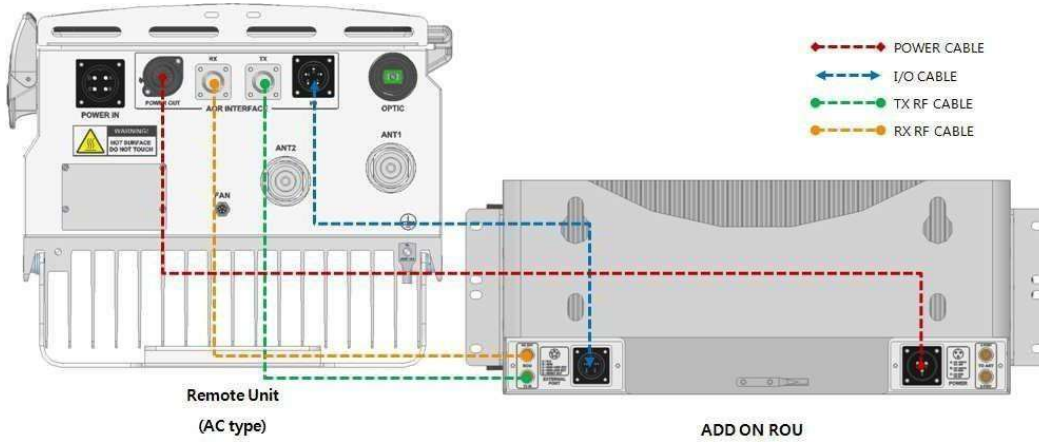

Figure 4.4 – Connection diagram between Remote Unit and ADD ON ROU (AC type)

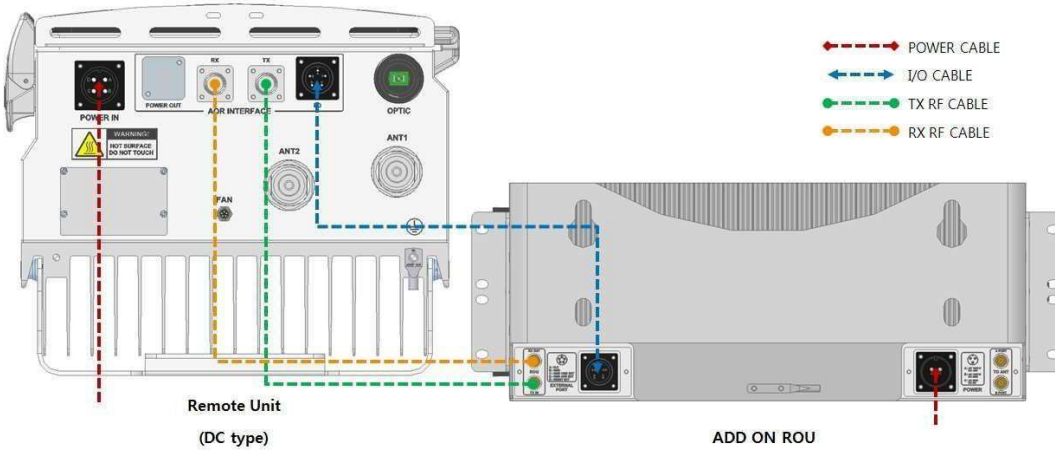

Figure 4.5 – Connection diagram between Remote Unit and ADD ON ROU (DC type)

4.1.2 Remote Unit Power Cabling

AC Power

Remote Unit supports only AC120V of input power. Provided outside power cable is only one type.

The pin description of AC port is below. You should connect exact polarity of AC.

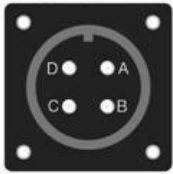
Port outlook	MS Connector numbering	Name	Description
	A	AC_H	AC Hot
	B	AC_N	AC Neutral
	C	N.C	Not Connected
	D	F.G	Frame Ground

Check if the connection is the same as one seen in the table above and make sure to turn the power ON.

Provided AC power cable's outlook is below

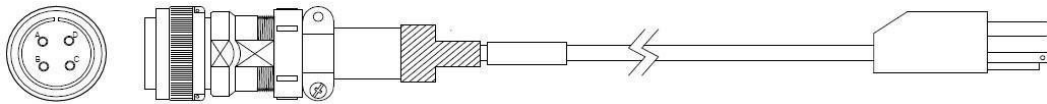

DC Power

Remote Unit supports only DC48V of input power. Provided outside power cable is only one type.

The pin description of DC port is below. You should connect exact polarity of DC.

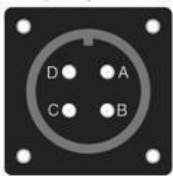
Port outlook	MS Connector numbering	Name	Description
	A	N.C	Not Connected
	B	N.C	Not Connected
	C	+V	+48V
	D	-V	-48V

Check if the connection is the same as one seen in the table above and make sure to turn the power ON.

Provided DC power cable's outlook is below

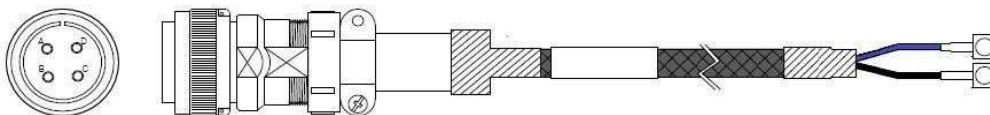

4.1.3 Remote Unit Ground cabling

The Grounding terminal is located at the bottom of Remote Unit enclosure fixed by M6 screw. Compression terminal is attached already when is delivered. The recommended thickness of cable is AWG#6 copper grounding wire

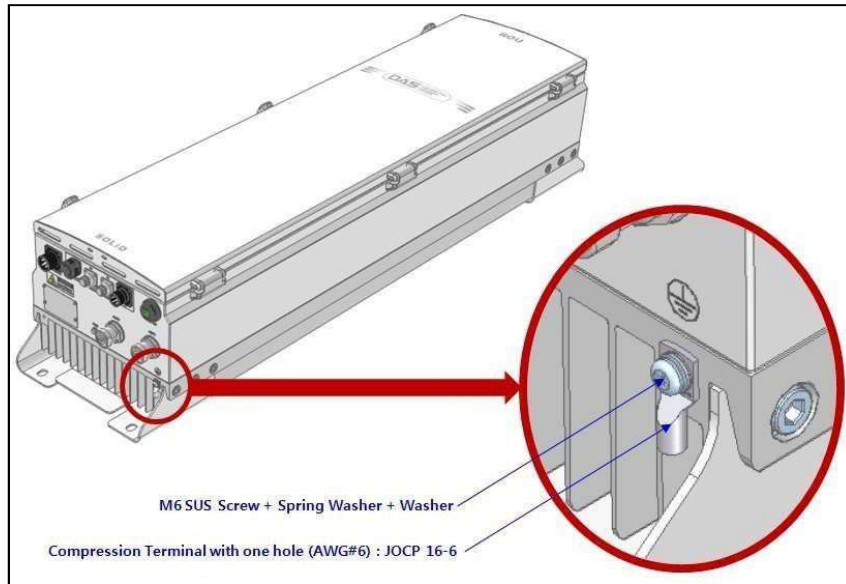
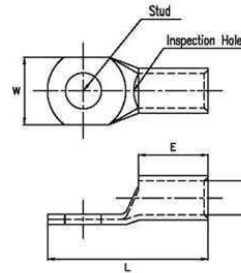

Figure 4.6 – Location of Ground Terminal

The specification of compression terminal is like below

TUBULAR CABLE LUGS, ONE-HOLE, ROUND COMPRESSED TYPE-CP

- Material : Electrolytic Copper (TPC)
- Surface : Tin Plated
- With Inspection Hole to visually assure full Conductor insertion.
- Color Coded to Show Proper Die Number and Color 10_{max}-70_{max}
- To IEC 60228 Class 2 and Class 5
- UL Listed 486A-486B up to 35KV



Part Number	Wire Range				Stud Size	Dimension (mm)				Code Cable Die Color & No.	Q'ty/bag
	CODE		FL EX			W	E	L	d		
	AWG	mm ²	AWG	mm ²							
JOCP 16-5					M5	12	13	29	5.4	Blue 24	300
JOCP 16-6	6	16	6	16	M6						
JOCP 16-8					M8	14		33			
JOCP 16-10					M10	16	34				

Figure 4.7 – Information of Terminal

The required part number is JOCT 16-6 supporting AWG 6. The way to install the grounding cable comply with below procedures

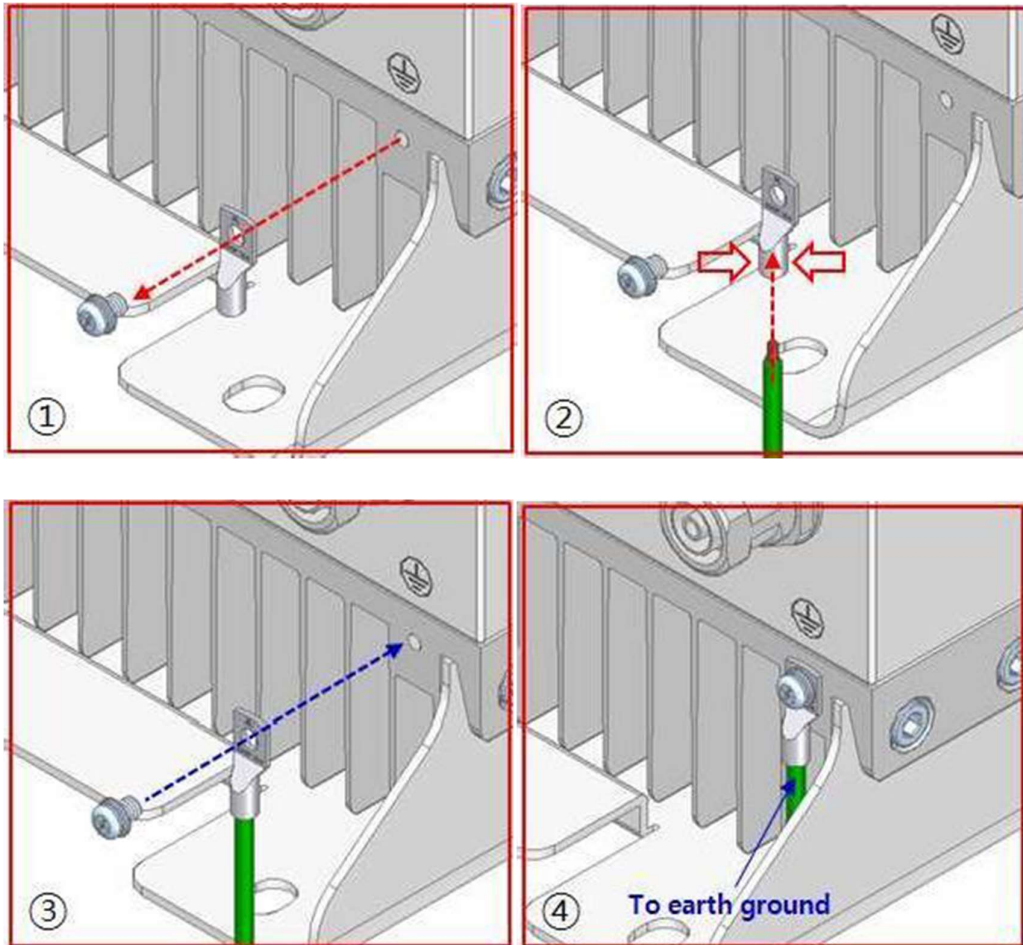

Figure 4.8 – How to install Ground Terminal

The procedures are

1. Loosen a two M6 screws and then take compression terminal off
2. Insert AWG#6 Grounding Wire into terminal and then compress a terminal using tool
3. Assemble the terminal which made in step “2” using 2xM6 screws
4. Cut the ground wire to proper length and connect it to the earth ground source

4.1.4 Optical Cabling

The Optical Connector is located at the bottom of Remote Unit enclosure fixed. Optical Cable can be connected by using connectors.

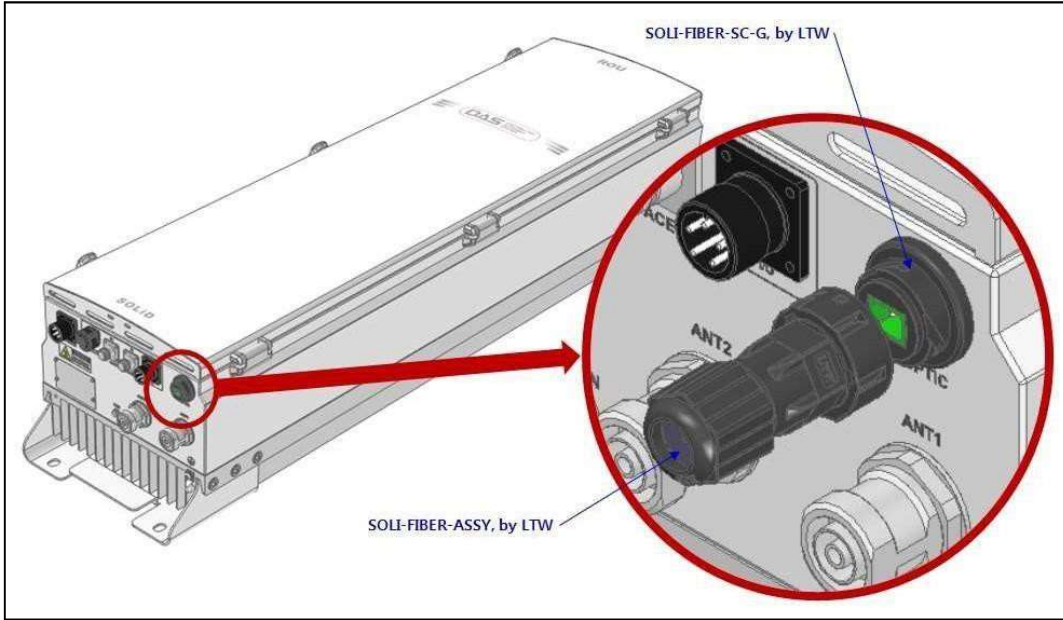

Figure 4.9 – Location of Optical Connector

The specification of compression Optic Connector is like below

SOLI-FIBER-ASSY

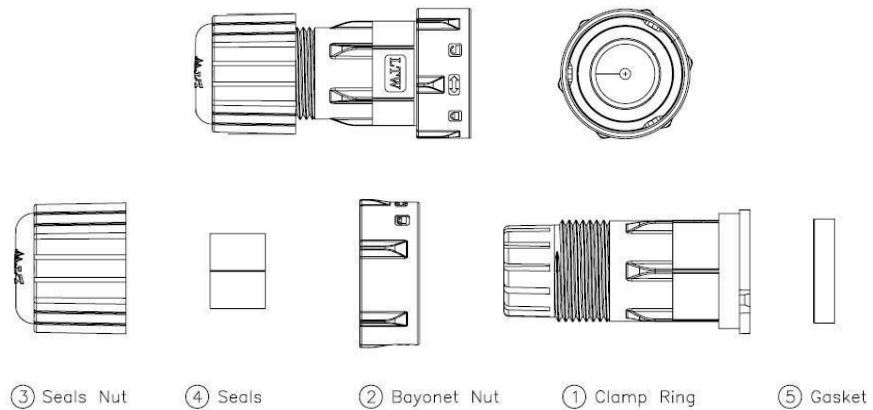

Figure 4.10 – Information of Optical Connector

The way to install the Optical cable comply with below procedures

The procedures are

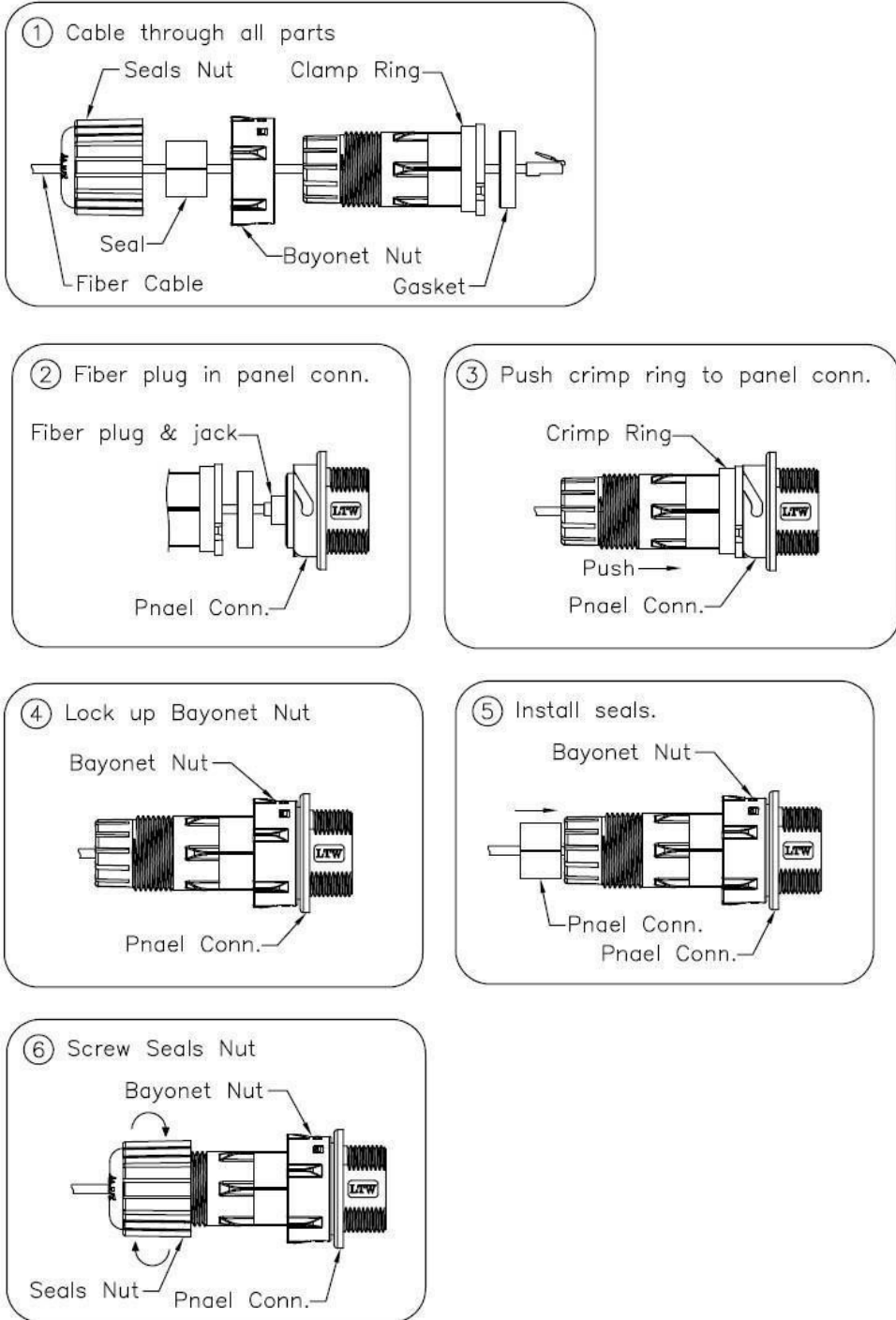

Figure 4.11 – How to install Optical Cabling

4.1.5 Mounting of MRDU

Remote Unit has slots to enable up to 6 MRDU modules to be mounted in it.

You can mount a MRDU into designated slot surely. It is not possible to provide services with a MRDU module alone; you need to connect MRDU cavity duplexer antenna port with CU's designated port.

Installation Diagram for MROU Module Assembly

- 1) Install each MRDU into its designated location as shown in the graphic.
- 2) If MRDUs are inserted in slot #5 or #6, install the optional combiner unit (CU) according to these guidelines:

Option 1: CU_607085IC19AWS132325

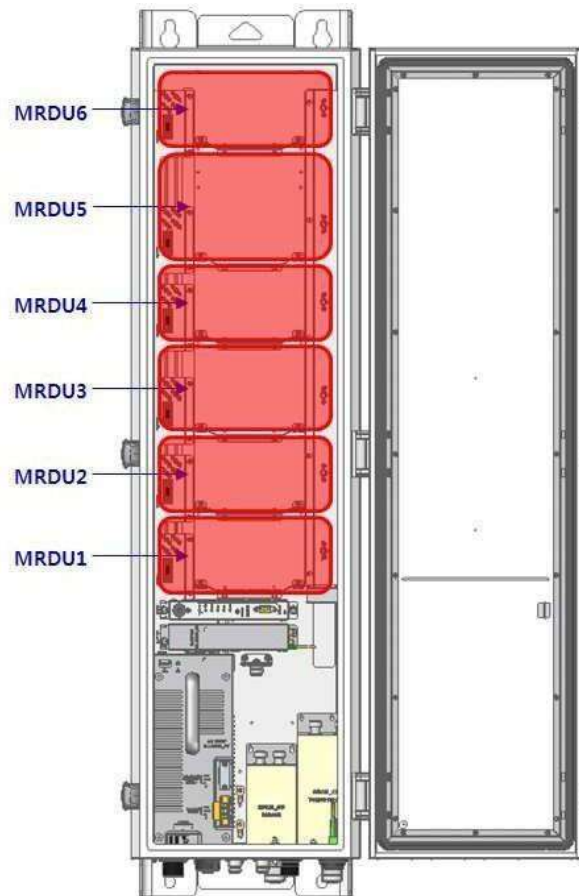

Figure 4.12 Location of MRDU

The Remote Unit holds a maximum of 6 MRDUs. Guide brackets on the bottom of each MRDU slot simplify installation as described below. MRDU installation requires a +No.1 tip size screwdriver.

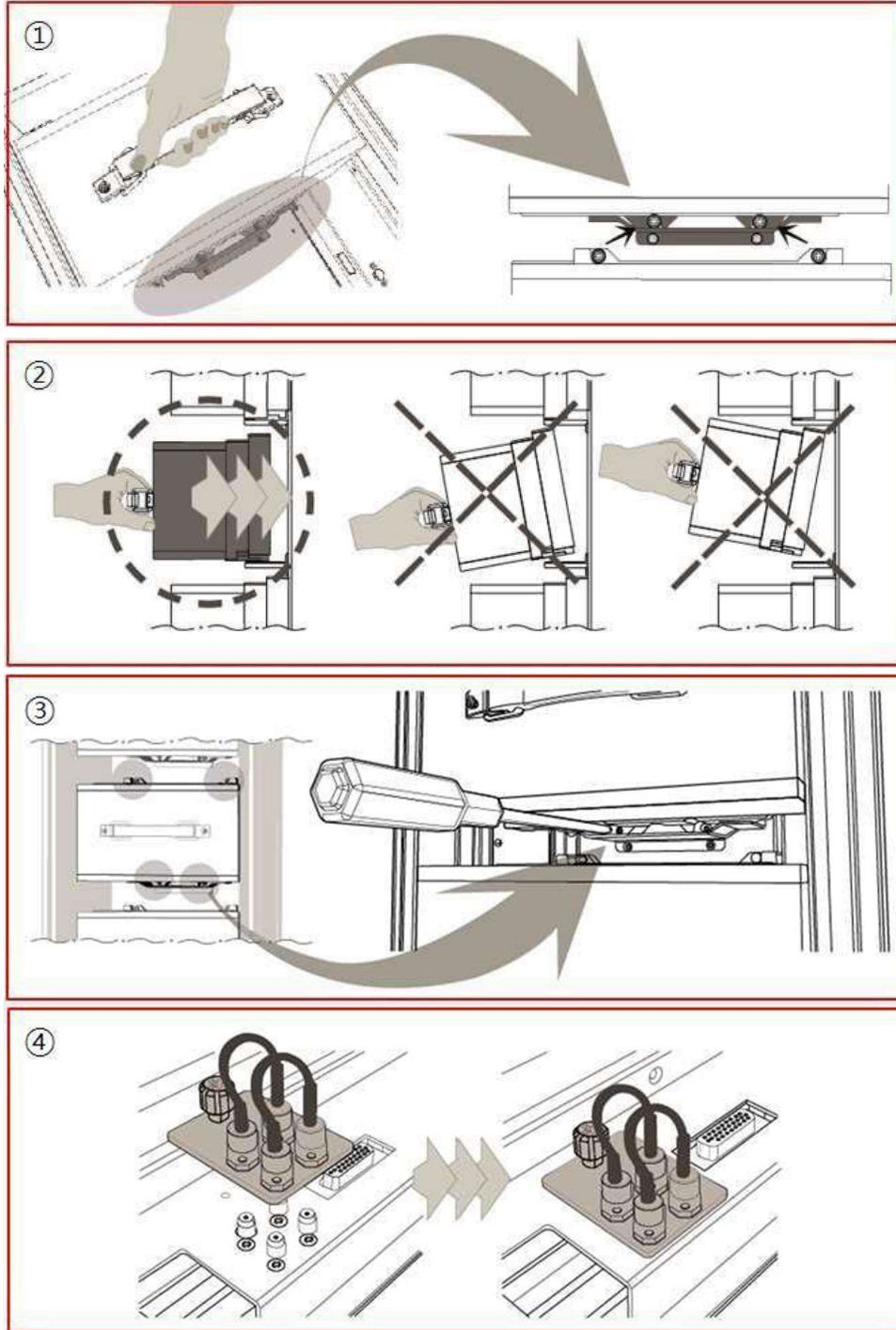

Figure 4.13 – How to mount MRDU

The procedures are

1. Lift the MRDU onto the guide bracket and ensure the MRDU is level left to right
2. Push the MRDU into the corresponding slot in the direction of the heat sink while levelling the MRDU to guide bracket
3. Make sure the MRDU is firmly inserted into the corresponding slot. Tighten the 4 corner screws to secure the unit
4. Install MRDU blank cards in all unused slots in the remote. First insert the blank card into the corresponding slot, then tighten the captive screw to secure it

4.1.6 How to mount FANUnit

FAN unit is required to be installed on the bottom of the 5W remote as shown in the below figure. In the case that MROU temperature on GUI exceeds 70°C (1580F), the fan unit is required to be installed on the bottom of the remote unit.

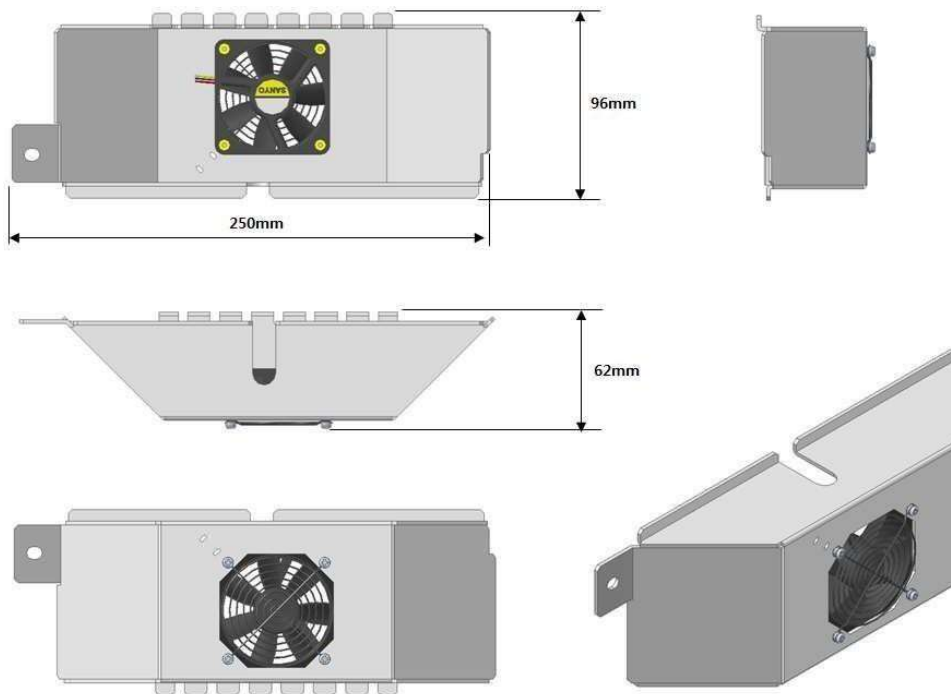

Figure 4.14 – How to mount FAN Unit

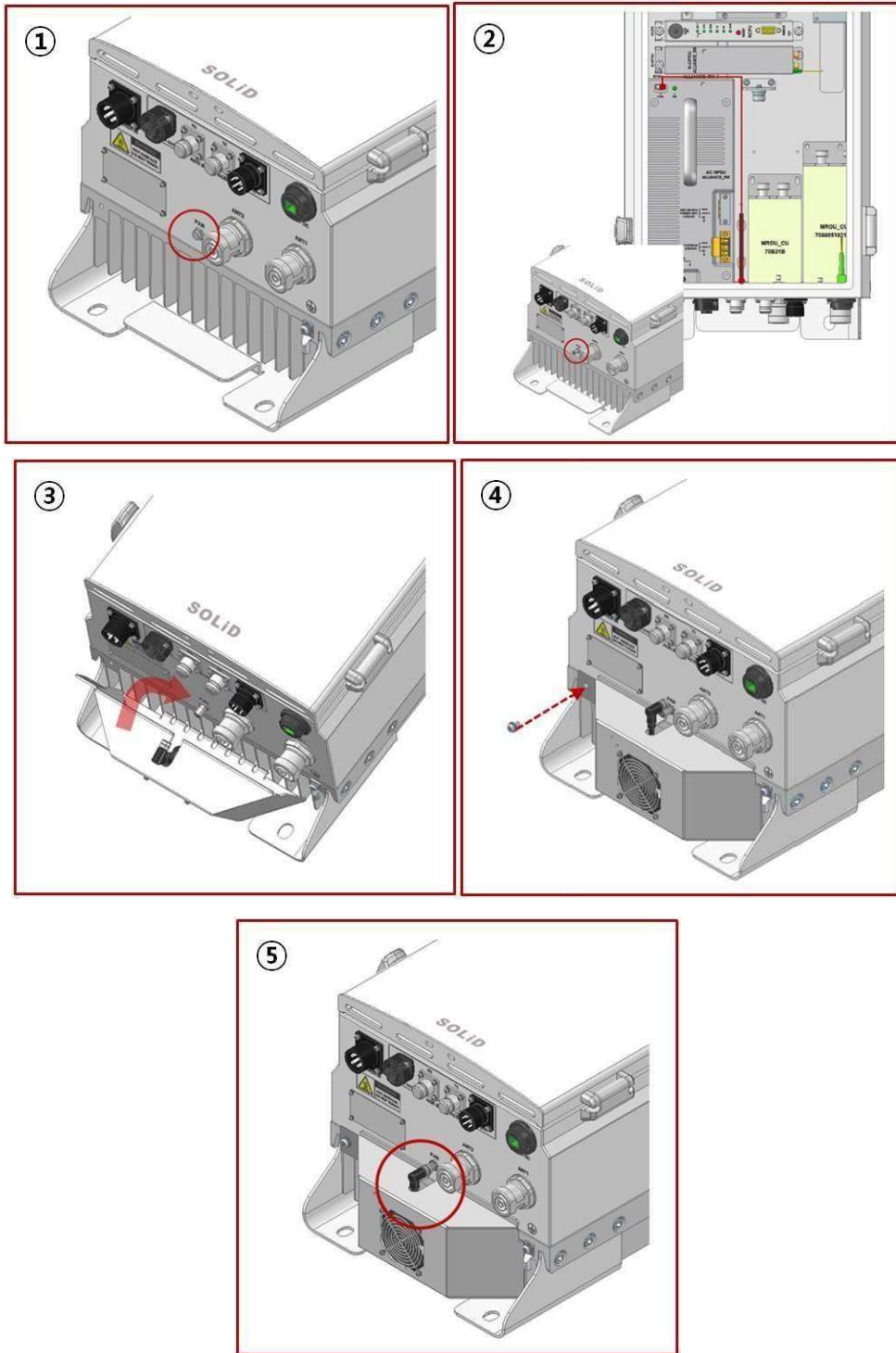

Figure 4.15 – How to mount FAN Unit

The procedures are

1. Remove dummy bolt attached at FAN Port
2. Connect internal FAN cable to the FAN Port, and connect with the connector located on the top of PSU.
3. Install fan unit to the bottom of 5W remote with aligning heatsink pin to the guided groove.
4. Secure the fan unit by tightening M6 screw located on the leftcorner.
5. After securing the FAN Unit, connect the cable from FAN unit to FAN port.

4.2 900ISM Application

When including the MRDU_900ISM module in the MROU, the module must be used only to amplify signals from the following signal sources, due to the way that systems are certified in this band:

List of approved 900ISM signal sources:

1. Kona Mega IOT Gateway (FCC ID: 2ALEPT0004279)

The overall system topology will be similar to as shown below when 900ISM is deployed:

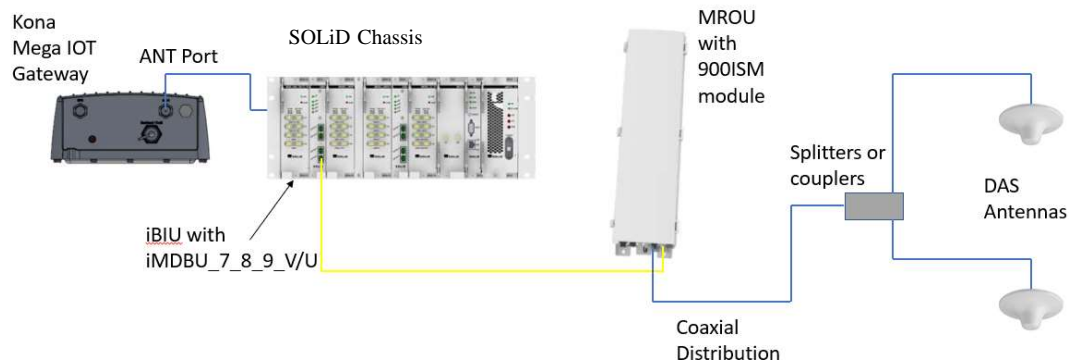

In the example above, the combined losses of the coaxial distribution and splitters, plus the antenna gain in dBi, must not exceed 6dB, for a maximum EIRP of 36dBm per antenna in the 900ISM band. Antennas used must be typical DAS antennas with gain < 6dBi in the 900MHz band.

Section5

System Specifications

-
- 6.1 Physical Specifications
 - 6.2 RF Performance
 - 6.3 Certification

5.1 Physical Specifications

Parameter	ROU
Nominal Impedance(input and output)	50 ohm
RF Connectors	DIN Female (7/16)
Mounting Type	Wall Mounting
Serial Interface connector	(1) RS-232 9-pin
	D-sub, male
Fiber connector	(1) SC/APC for ODU
LED Alarm and Status Indicator	Power LED
	TX LED
	RX LED
	LD LED
	PD LED
	ALARM LED
	RESET Button
AC Power	108~132V AC, 50/60Hz
DC Power	-40.8 ~ -57.6V DC
Environmental Condition & IP Rating	IP66
Maximum Power Consumption	510W at full load
Enclosure Dimensions (mm)	320 x 1165 x 260mm
Weight (Full Load)	62kg
Optical Data	
Wavelength TX/RX	1310/1550nm
Maximum Optical Loss	10dBo
Fiber Optic Connector	SC/APC

5.2 RF performance

MRDU Specifications Per band

Downlink

Unit naming	Description	Gain(dB) [Only RU]	Bandwidth(MHz)	output power(dBm)	Frequency range
MRDU 600_700LTE_FN	Dual	49	35	+39	617 – 652MHz
		49	39	+39	729 – 768MHz
MRDU 850C	Single,	49	25	+39	869 - 894MHz
MRDU 850IC	Dual,	49	7	+37	862 - 869MHz
		49	25	+37	869 - 894MHz
MRDU 1900P	Single,	53	65	+37	1930 - 1995MHz
MRDU 700LTE	Single,	49	28	+37	728 - 756MHz
MRDU AWS13	Single,	54.2	70	+38.2	2110 - 2180MHz
MRDU 700LTE_MIMO	Single,	53	28	+37	728 - 756MHz
MRDU_AWS13_M	Single,	53	70	+37	2110 - 2180MHz
MRDU 900I	Single,	49	12	+37	929 - 941MHz
MRDU 900ISM	Single	50	5	+30	923 – 928MHz
MRDU 700P+800	Dual,	49	17	+37	758 - 775MHz
		49	10	+37	851 - 861MHz
MRDU 2300_WCS	Single	53	10	+37	2350 – 2360MHz
MRDU 2.5TDD	Single	53	193.2	+37	2496.8 - 2690MHz (FCC)
					2500 – 2690MHz (IC)
MRDU 2600_FDD	Single	53	70	+37	2620 – 2690MHz
MRDU_1900P_M	Single,	53	65	+37	1930 - 1995MHz
MRDU_2500_60TDD_M	Single	53	193.2	+37	2496.8 - 2690MHz (FCC)
					2500 – 2690MHz (IC)
MRDU_700LTE_FN	Single,	49	40	+37	728 - 768MHz
MRDU_700LTE_FN +FirstNet	Single,	57	40	+37	728 - 768MHz
MRDU_800I_850C	Single,	57	25	+37	869 - 894MHz
MRDU 1900P	Single,	57	65	+37	1930 - 1995MHz
MRDU_AWS13	Single	57	70	+37	2110 - 2180MHz
MRDU_2500_100TDD	Single	48.5	194	+37	2496.8 - 2690MHz (FCC)

Uplink

Unit naming	Description	Gain(dB) [Only RU]	Bandwidth(MHz)	output power(dBm)	Frequency range
MRDU 600_700LTE_FN	Dual	47	53	-5	663 – 716MHz
		48	21	-4	777 – 798MHz
MRDU 850C	Single,	47	25	-5	824 - 849MHz
MRDU 850IC	Dual,	47	7	-5	817 - 824MHz
		47	25	-5	824 - 849MHz
MRDU 1900P	Single,	47	65	-5	1850 - 1915MHz
MRDU 700LTE	Single,	47	17	-5	699 - 716MHz
		47	10	-5	777 –787MHz
MRDU AWS13	Single,	47	70	-5	1710 – 1780MHz
MRDU 700LTE_MIMO	Single,	47	17	-5	699 - 716MHz
		47	10	-5	777 –787MHz
MRDU_AWS13_M	Single,	47	70	-5	1710 – 1780MHz
MRDU 900I	Single,	47	6	-5	896 - 902MHz
MRDU_900ISM	Single	47	17	-3	902 – 919MHz
MRDU 700P+800	Dual,	47	17	-5	788 - 805MHz
		47	10	-5	806 - 816MHz
MRDU 2300_WCS	Single	47	10	-5	2305 – 2315MHz
MRDU 2.5TDD	Single	47	189.6	-5	2496.8 - 2690MHz (FCC)
					2500 – 2690MHz (IC)
MRDU 2600_FDD	Single	47	70	-5	2500 – 2570MHz
MRDU_1900P_M	Single,	47	65	-5	1850 - 1915MHz
MRDU_2500_60TDD_M	Single	47	193.2	-5	2496.8 - 2690MHz (FCC)
					2500 – 2690MHz (IC)
MRDU_700LTE_FN	Single,	47	40	-5	698 - 716MHz
					777 –798MHz
MRDU_700LTE_FN +FirstNet	Single,	47	40	-5	698 - 716MHz 777 –798MHz
MRDU_2500_100TDD	Single,	47	194	-5	2496 - 2690MHz (FCC) 2500 – 2690MHz (IC)

5.3 Certification

Title	Standards	Remarks
Environmental		
Temperature range	-25°C to +55°C/ -13 to 131°F	Ambient Temperature
Humidity Range	0% ~ 90%	Non-condensing
Sealing (Remote Unit)	IEC 60 529 EN 60 529	IP66 Complaint



FCC/IC User Warning

FCC PART 15.105 STATEMENT

This equipment has been tested and found to comply with the limits for a Class A digital device, pursuant to part 15 of the FCC Rules. These limits are designed to provide reasonable protection against harmful interference when the equipment is operated in a commercial environment. This equipment generates, uses, and can radiate radio frequency energy and, if not installed and used in accordance with the instruction manual, may cause harmful interference to radio communications. Operation of this equipment in a residential area is likely to cause harmful interference in which case the user will be required to correct the interference at his own expense.

FCC PART 15.21 STATEMENT

Any changes or modifications not expressly approved by the party responsible for compliance could void the user's authority to operate this equipment.

RF EXPOSURE STATEMENT

This equipment complies with RF radiation exposure limits set forth for an uncontrolled environment. This equipment should be installed and operated with a minimum distance of 400 cm between the radiator and your body. This transmitter must not be co-located or operating in conjunction with any other antenna or transmitter. RF exposure will be addressed at time of installation and the use of higher gain antennas require larger separation distances. (Max. antenna gain: DL6 dBi)

RSS-GEN, SEC. 7.1.2 – (TRANSMITTERS)

Under Industry Canada regulations, this radio transmitter may only operate using an antenna of a type and maximum (or lesser) gain approved for the transmitter by Industry Canada. To reduce potential radio interference to other users, the antenna type and its gain should be so chosen that the equivalent isotropically radiated power (e.i.r.p.) is not more than that necessary for successful communication.

Conformément à la réglementation d'Industrie Canada, le présent émetteur radio peut fonctionner avec une antenne d'un type et d'un gain maximal (ou inférieur) approuvé pour l'émetteur par Industrie Canada. Dans le but de réduire les risques de brouillage radioélectrique à l'intention des autres utilisateurs, il faut choisir le type d'antenne et son gain de sorte que la puissance isotrope rayonnée équivalente (p.i.r.e.) ne dépasse pas l'intensité nécessaire à l'établissement d'une communication satisfaisante.

RSS-GEN, SEC. 7.1.2 – (DETACHABLE ANTENNAS)

This radio transmitter (identify the device by certification number, or model number if Category II) has been approved by Industry Canada to operate with the antenna types listed below with the maximum permissible gain and required antenna impedance for each antenna type indicated. Antenna types not included in this list, having a gain greater than the maximum gain indicated for that type, are strictly prohibited for use with this device.

Le présent émetteur radio (identifier le dispositif par son numéro de certification ou son numéro de modèle s'il fait partie du matériel de catégorie I) a été approuvé par Industrie Canada pour fonctionner avec les types d'antenne énumérés ci-dessous et ayant un gain admissible maximal et l'impédance requise pour chaque type d'antenne. Les types d'antenne non inclus dans cette liste, ou dont le gain est supérieur au gain maximal indiqué, sont strictement interdits pour l'exploitation de l'émetteur.

RF RADIATION EXPOSURE

This equipment complies with RF radiation exposure limits set forth for an uncontrolled environment. This equipment should be installed and operated with a minimum distance of 400cm between the radiator and your body. This transmitter must not be co-located or operating in conjunction with any other antenna or transmitter. RF exposure will be addressed at time of installation and the use of higher gain antennas require larger separation distances. (Max. antenna gain: DL6 dBi general)

RSS-102 RF EXPOSURE

L'antenne (ou les antennes) doit être installée de façon à maintenir à tout instant une distance minimum de au moins 400 cm entre la source de radiation (l'antenne) et toute personne physique. Cet appareil ne doit pas être installé ou utilisé en conjonction avec une autre antenne ou émetteur. (Max. antenna gain: DL6 dBi)