

# ***Section 5***

## **System Installation**

---

### **5.1 HROU Installation**



This chapter describes how to install each unit and optical cables, along with power cabling method.

In detail, the chapter describes how to install shelves or enclosures of each unit, Power Cabling method and Optic Cabling and RF Interface. Furthermore, by showing power consumption of modules to be installed in each unit, it presents Power Cabling budget in a simple way. Then, it describes the quantity of components of modules to be installed in each unit and expansion method.

## 5.1 HROU Installation

### 5.1.1 Tools

Tools needed for installation is below

No	Tools	Q'ty	Specification	Remark
1		1	+ , 3Ø Length is more than 20mm	For fixing RDU
2		1	20mm	To tighten antenna port

### 5.1.2 HROU Enclosure installation

HROU is designed to be water- and dirt-proof. The unit has the structure of one-Body enclosure. It satisfies water-proof and quake-proof standards equivalent of NEMA4(IP66). The way to install for both HMRU and ARU has same. Basically HROU is attached with wall mountable bracket. This wall mountable bracket can be unattached by loosening screws on the both side of enclosure. HROU can be mounted into either of wall or on a pole.

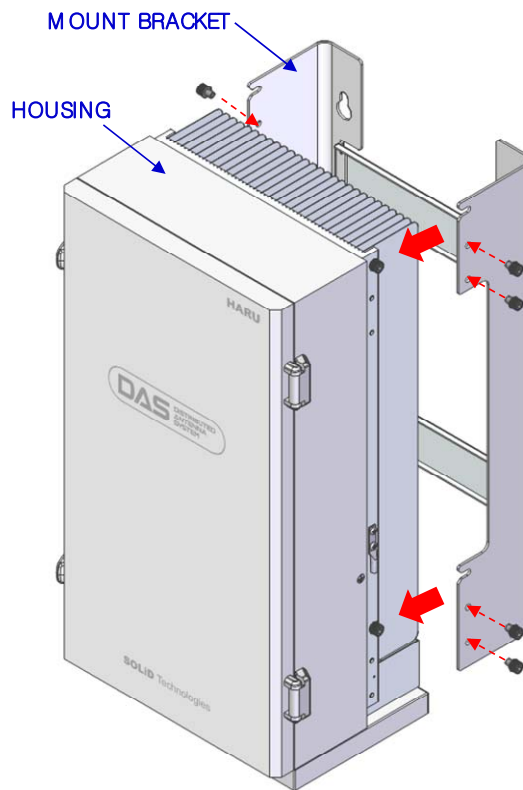
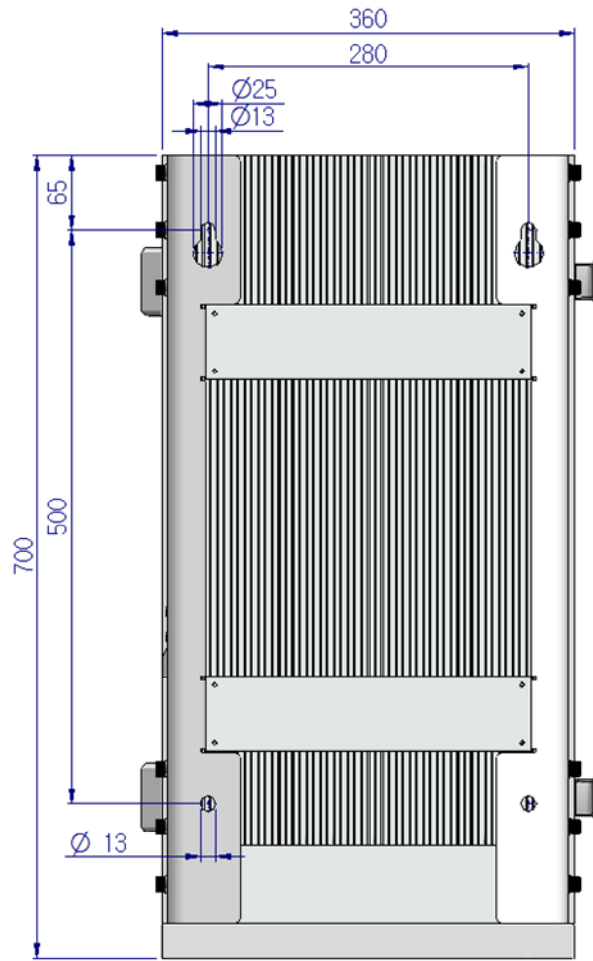

Figure 5.1 – How to install HROU



**Figure 5.2 – Dimension used to install HROU on the WALL**

## HROU Wall Mount Installation

Turn M12 Fixing Screws by half on the wall and fully fix the screw with a Wall Mount Bracket on it. For convenience, the Wall Mount Bracket has fixing holes to let you easily mount an enclosure. Turn the M5 Wrench Bolt by half at each side of the Heatsink of the enclosure.

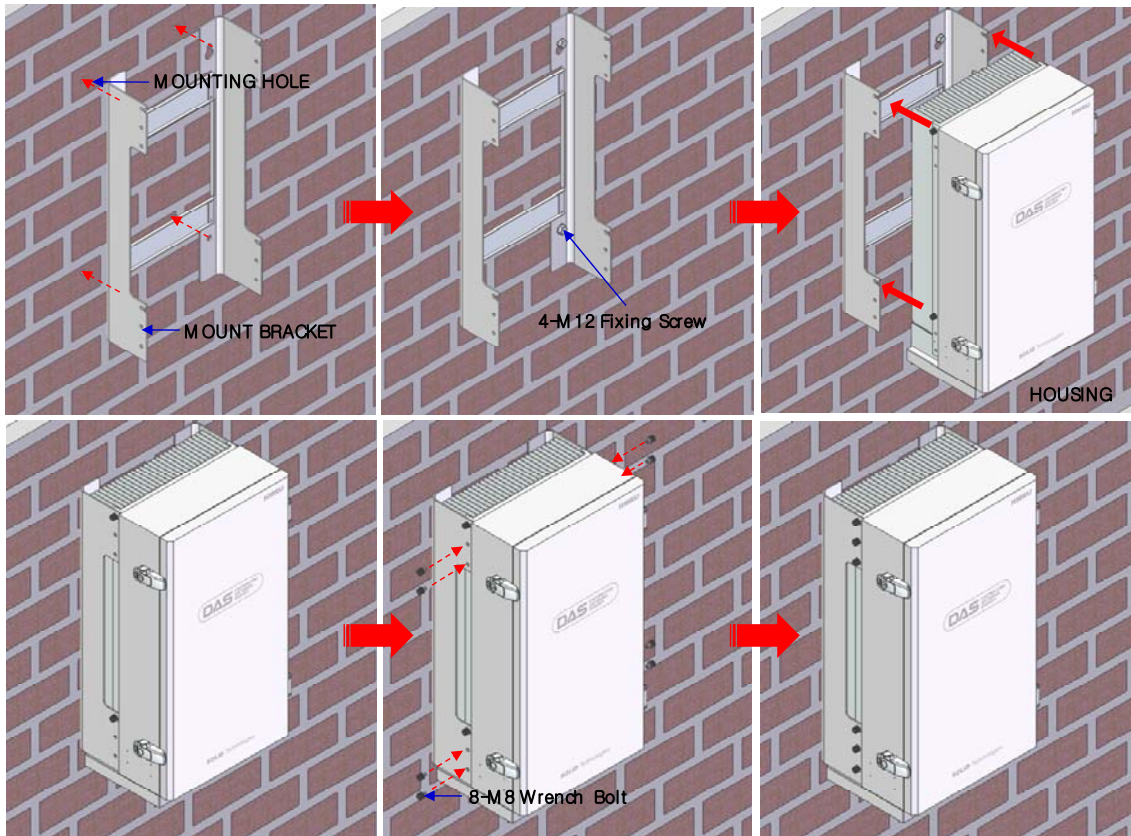

**Figure 5.3 – Procedures of installation**

Put the enclosure with the M5 Wrench Bolt fixed on the fixing groove and fix the M5 Wrench Bolts into the remaining fixing holes.

In this case, you will use 12 M5 Wrench Bolts in total except bolts used for the fixing groove.

## HROU components

HROU has the following components:



No.	Unit	Description	Remark
Common Part	Enclosure	Including Wall mounting bracket	1EA
	RCPU	-	1EA
	R_OPTIC	With SC/ACP adaptor	1EA, optional
	RPSU	AC 120V	1EA
		-	1EA
	Power Cable	- MS Connector with 4 hole to AC 120 plug(AC) - MS Connector with 3 lug termination(battery)	Each 1EA
Optional Part	RDU	1900PCS RDU 44.5 850CEL RDU 44.5 700LTE RDU 44.5 AWS-1 RDU 44.5 700PS RDU 44.5 800I/PS RDU 44.5 900I RDU 44.5	Up to 2EA to be mounted

Basically, the common part of HROU should have an enclosure and it is equipped with RCPU to inquire and control state of each module, R\_OPTIC to make both of electronic-optical and optical-electronic conversions, RPSU to supply power for HROU. It should have Power Cable for external rectifier or to supply required power.

In addition, RDU can be mounted and removed to provide service for desired band (Optional).

### 5.1.3 How to expand ARU at the HMRU

HMRU can expand ARU up to 3. The three item is needed for connection between HMRU and HARU. HARU's components additively have 3 item except for enclosure like below

Accessories	Description	Qty	Specification	Remark
1	TX RF Cable	1	SMBL(M) ST_3M	
2	RX RF Cable	1	SMBL(M) ST_3M	
3	I/O Cable	1	xxxx	

Following picture shows the connection diagram between HMRU and HARUs

For expanding HARU at the HMRU in proper cable length provided, we recommend MRU be located at middle of among ARUs. The cables between HMRU and HARU have each 3m length

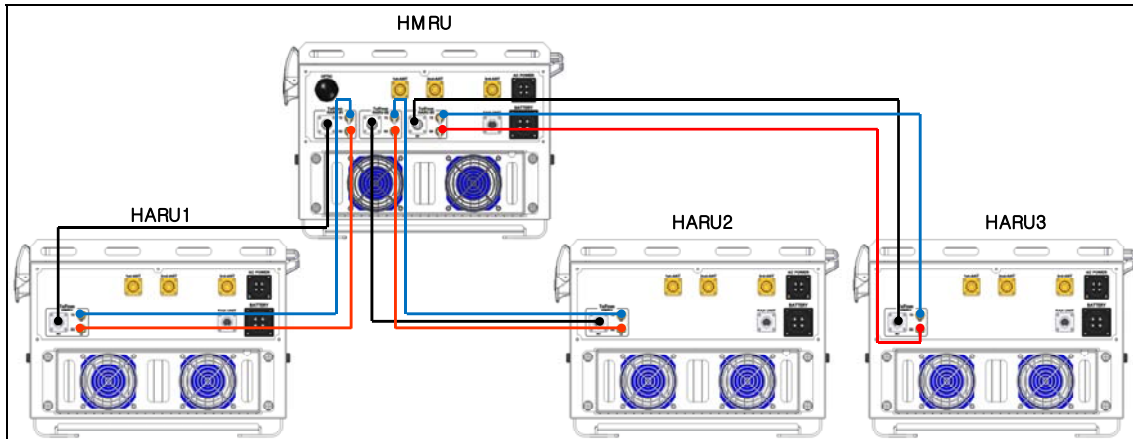

**Figure 5.4 – Connection diagram between HMRU and HARU**

Table below shows the point to connect between HMRU and HARU according to ARU order.

	MRU port name	1 <sup>st</sup> ARU port name	2 <sup>nd</sup> ARU port name	3 <sup>rd</sup> ARU port name	Remark
ARU #1	TX	TX	-	-	
	RX	RX	-	-	
	I/O	I/O	-	-	
ARU #2	TX	-	TX		
	RX	-	RX		
	I/O	-	I/O		
ARU #3	TX	-	-	TX	
	RX	-	-	RX	
	I/O	-	-	I/O	



## 5.1.4 HROU Power Cabling

### AC Power cabling

HROU supports only AC120V of input power. Provided outside power cable is only one type. The pin discription of AC port is below. You should connect exact polarity of AC.

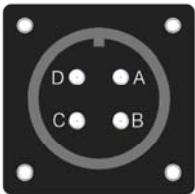
Port outlook	MS Connector numbering	Name	Description
<p><b>AC POWER</b></p>  <p>A : AC_H B : AC_N C : N.C D : F.G ⚡</p>	A	AC_H	AC Hot
	B	AC_N	AC Neutral
	C	N.C	Not Connected
	D	F.G	Frame Ground

Check if the connection is the same as one seen in the table above and make sure to turn the power ON.

### Battery cabling

The battery port provides either charging mode or discharging mode. According to system power, you should calculate battery capacity and connect

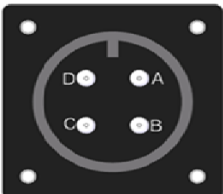
Port outlook	MS Connector numbering	Name	Description
<p><b>BATTERY</b></p>  <p><b>A : +BATT</b> <b>B : -BATT</b> <b>C : N.C</b> <b>D : N.C</b></p>	A	+BATT	Positive polarity
	B	-BATT	Negative polarity
	C	N.C	Not Connected
	D	N.C	Not Connected

If you use battery through external battery pack, turn Battery switch on and if you don't use battery port, you should turn Battery switch off

### 5.1.5 HROU Ground cabling

The Grounding terminal is located at the right of HROU enclosure fixed by M6 screw. Compression terminal is attached already when is delivered. The best thickness of cable is AWG#6 copper grounding wire

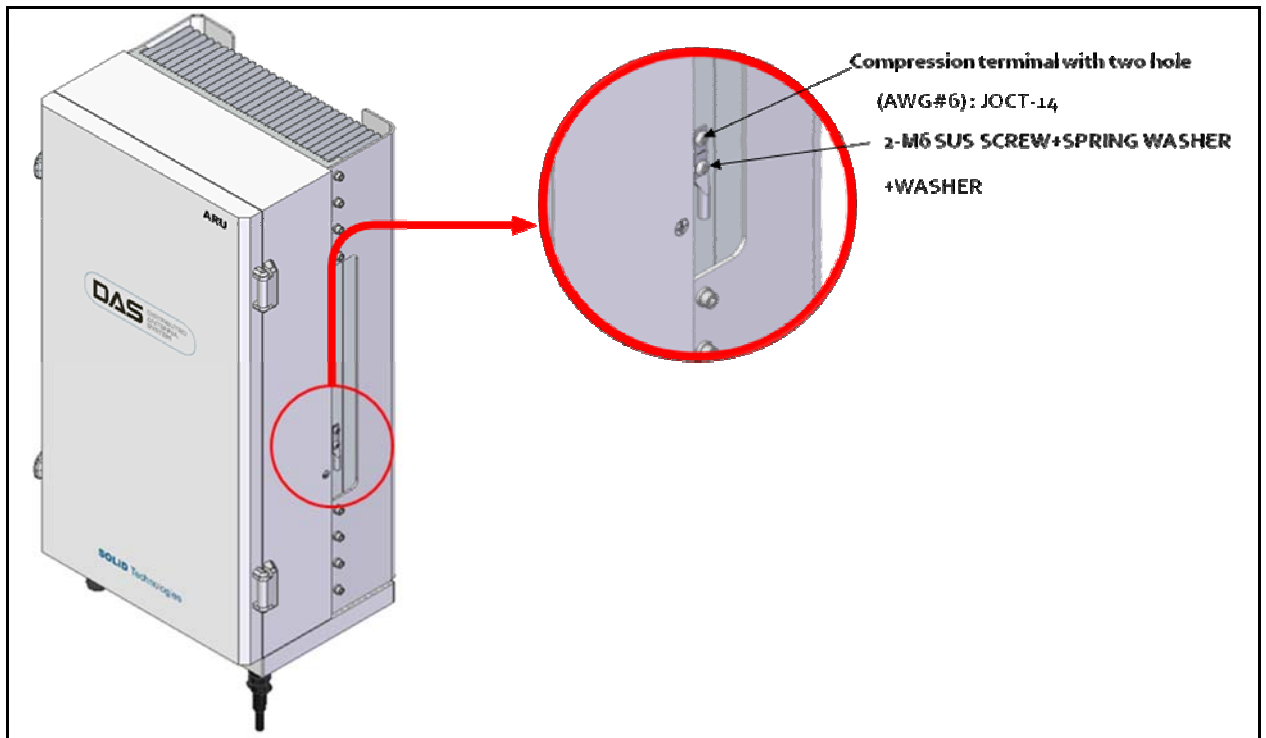

Figure 5.5 – Location of Ground Terminal

The specification of compression terminal is like below

**Compression Terminal information**

- TWO-HOLE
- Material : Electrolytic Copper (TPC)
- Surface : Tin Plated
- UL Listed 486A up to 35kv

Part Number	Wire Range		Dimension (mm)									Crimping Tools	die
	AWG	mm	B	G	E	K	L	A	d	D	T		
JOCT 55	12-10	4, 5.5, 6	7.2	35.0	19.0	5.5	59.0		3.8	5.2	1.4	GY-35	5.5
JOCT 8	8	8, 10	9.2	38.0	19.6	5.2	60.0		4.5	6.5	1.8	GY-35	8
JOCT 14	6	14, 16	10.6	38.0	20.5	6.7	64.0	22.0	5.8	7.4	1.6	GY-35	14
JOCT 22	4	22, 25	14.0	40.0	27.0	9.3	75.0		7.7	10.0	2.3	GY-35	22
JOCT 38	2	35, 38	17.3	45.0	32.0	12.0	86.0		9.4	12.0	2.6	GY-35	38

Figure 5.6 – Information of Terminal

The required part number is JOCT 14 supporting AWG 6. The way to install the grounding cable comply with below procedures

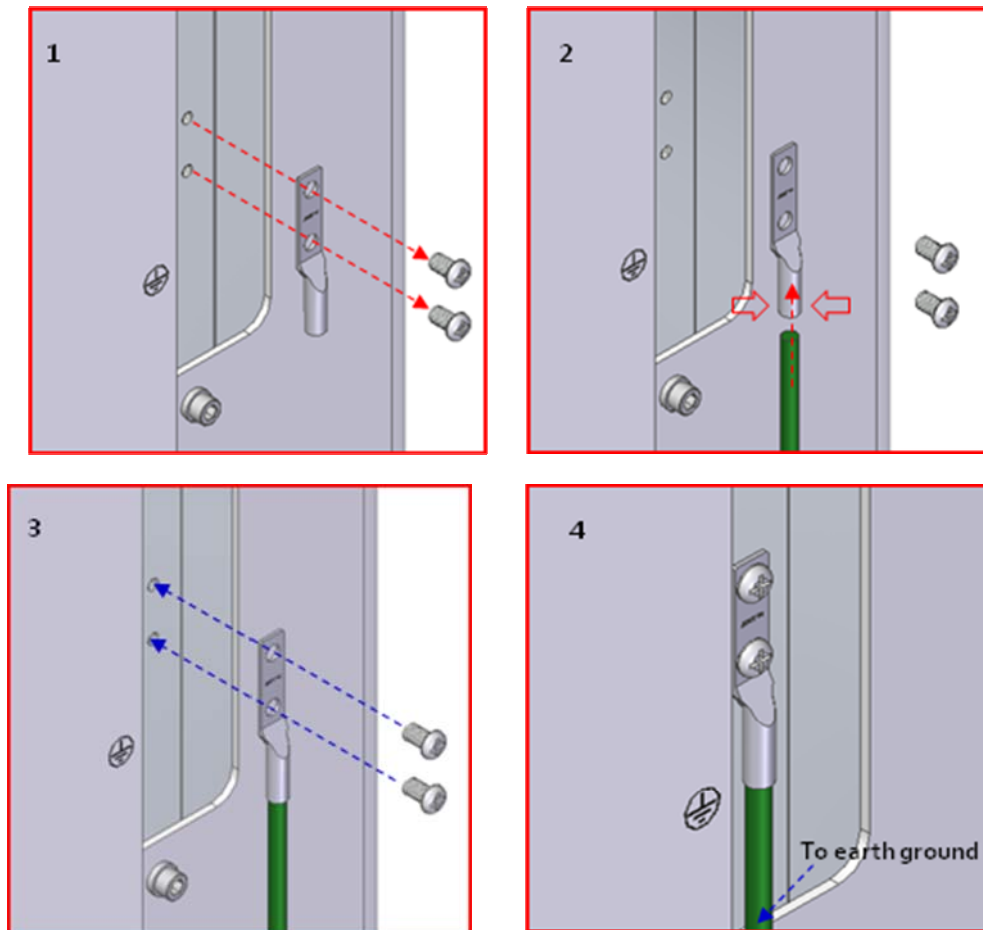

**Figure 5.7 – How to install Ground Terminal**

The procedures are

1. Loosen a two M6 screws and then take compression terminal off
2. Insert AWG#6 Grounding Wire into terminal and then compress a terminal using tool
3. Assemble the terminal which made in step “2” using 2xM6 screws
4. Cut the ground wire to proper length and connect it to the earth ground source

### 5.1.6 Optical Cabling

HROU makes optical-electronic conversion of TX signals from upper ODU and OEU and makes electronic- optical conversion of RX signals. HROU has one optical module in it. As WDM is installed in the R\_OPTIC module, two pieces of wavelength (TX:1310nm, RX:1550nm) can be sent/received with one optical core at the same time. HROU has SC/APC of optical adaptor type.

For optical adaptor, SC/APC type can be used only. To prevent the optical access part from being marred by dirt, it should be covered with a cap during moving. Before optical cable put it on optical port, you need to clean up them using alcohol to remove dirt.

Optical cable port support water-proof type. Therefore, to prevent it from water and dirt you should install as procedures below

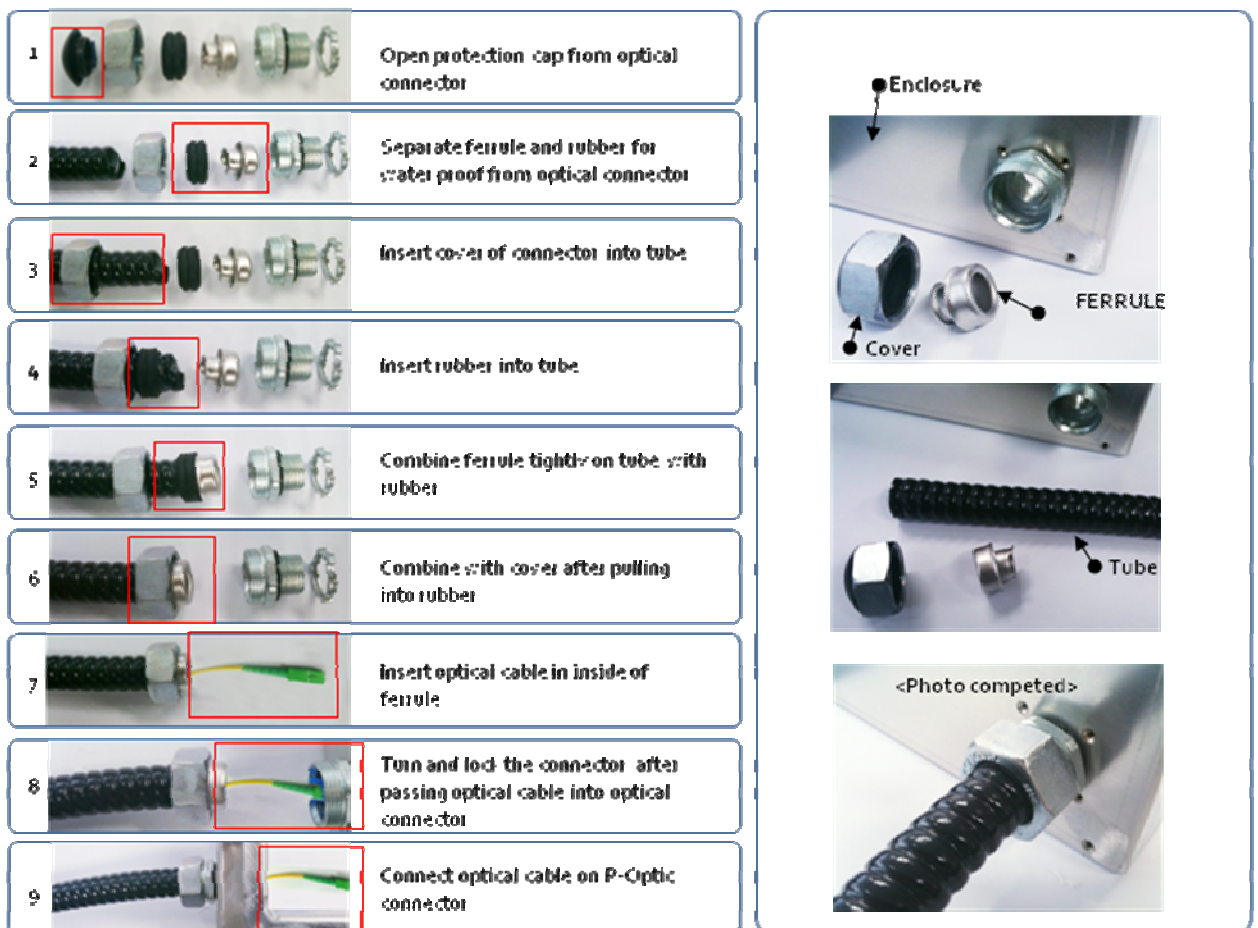

Figure 5.8 – How to work optical port

The picture below is wrong installation diagram



**Figure 5.9 – Wrong optical port installation method**

Optical cables should be inserted into Optic Port outside of HROU. In the inside, you go through the fixed devices to fix more tight. At this time, curvature of the optical cable should be in at least  $10\varnothing$  to prevent optical link margin from adding optical loss. Through GUI, check if PD value of ROPTIC is in a tolerable range (+10~-2dBm).

### 5.1.7 Mounting of RDU

HROU has slots to enable up to two RDU modules to be mounted in it. You can mount a RDU into any slot. It is not possible to provide services with a RDU module alone; you need to connect RDU cavity duplexer antenna port with antenna port of enclosure.

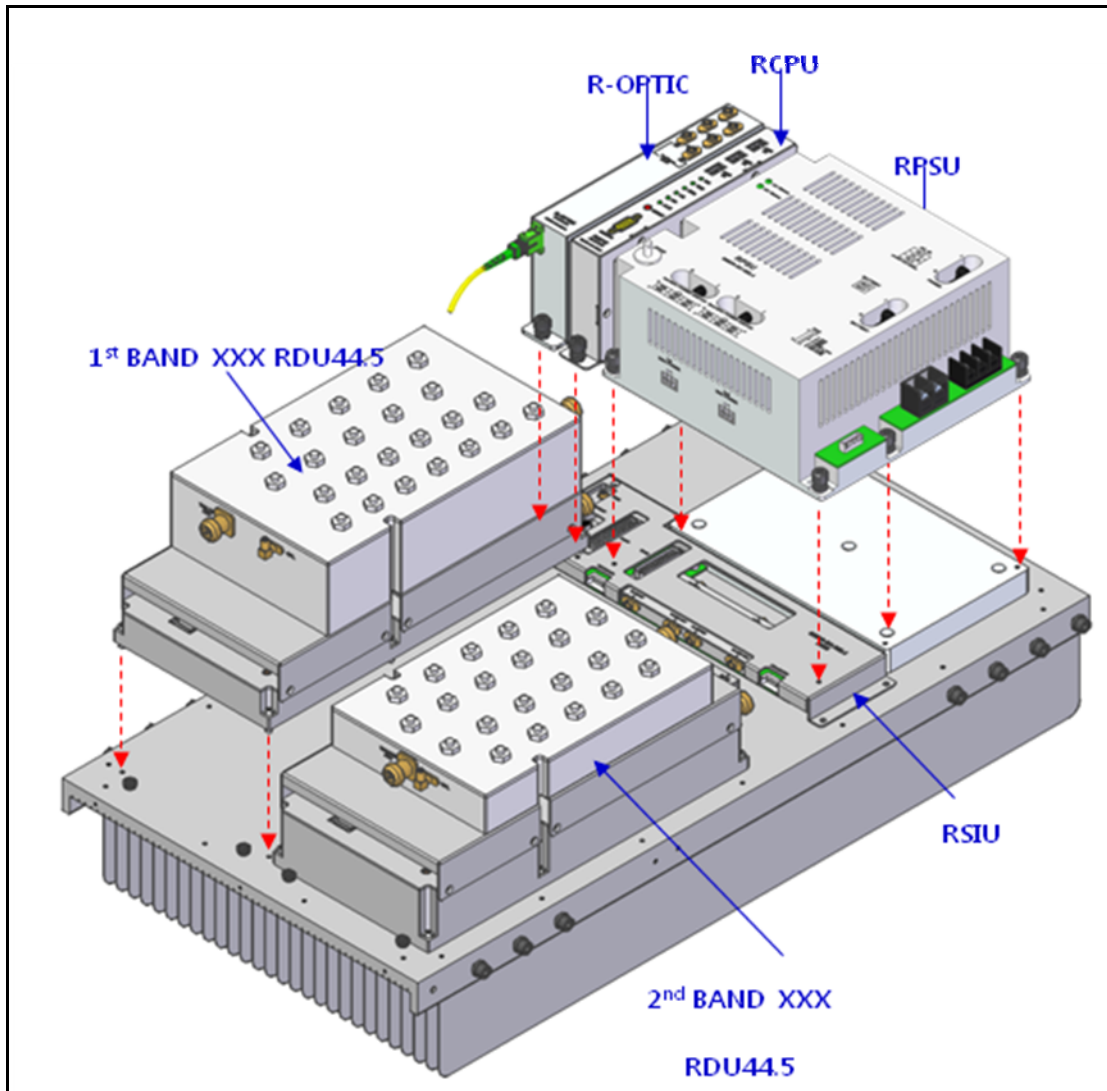
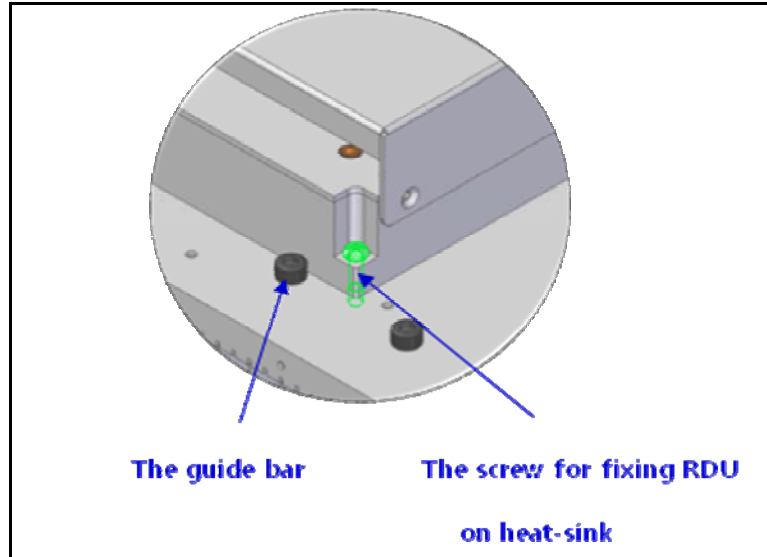

Figure 5.10 – How to mount RDU

Because there are the guide bar, it assists RDU to move exact location. The screw for fixing RDU on the heat-sink is already attached on RDU and so you can assemble RDU easily.



**Figure 5.11 – The Guide bar**

The additive provided accessories with RDU are 4cables like below

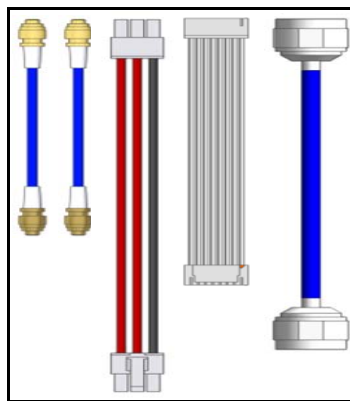
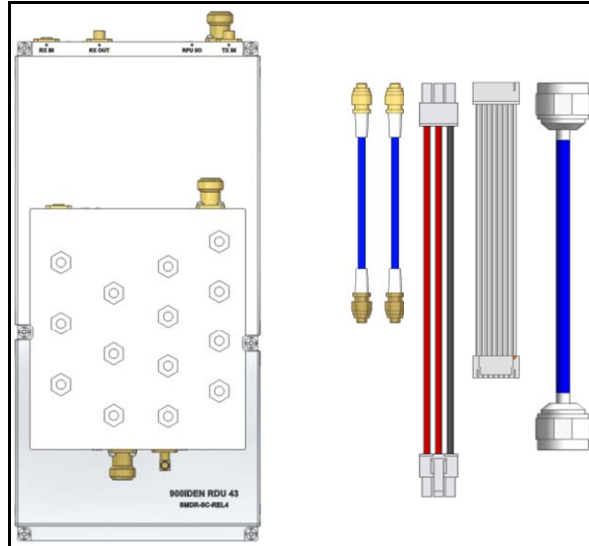

**Figure 5.12 – RDU accessories**

Accessories	Description	Qty	Specification	Remark
1	RDU RF TX cable	1	SMBL(M) ST	
2	RDU RF RX cable	1	SMBL(M) ST	
3	RDU power	1	MOLED 5557-06	
4	RDU I/O	1	SMH200-16C	
5	RDU RF antenna	1	N-type(M) ST	

**For example, How to install XXX RDU 44.5**

The provided components of RDU are below.



**Figure 5.12 – RDU and accessories**



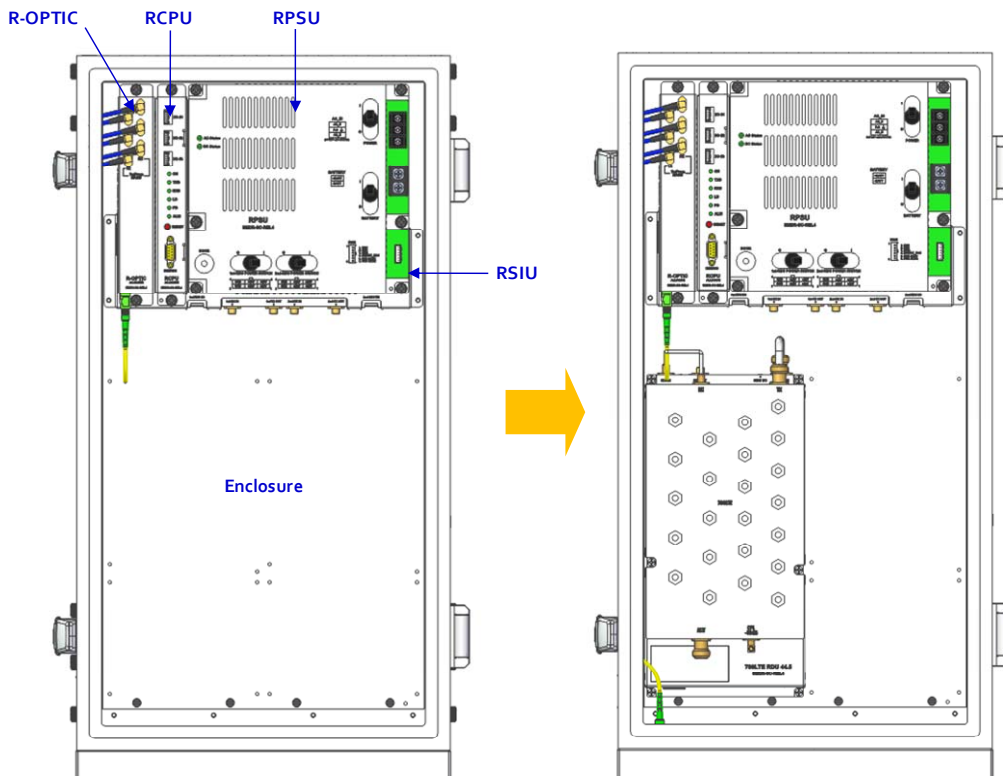

We provide RDU to extra package from ROU common enclosure. In the empty RDU space, you first mount the RDU at 1<sup>st</sup> RDU space like below

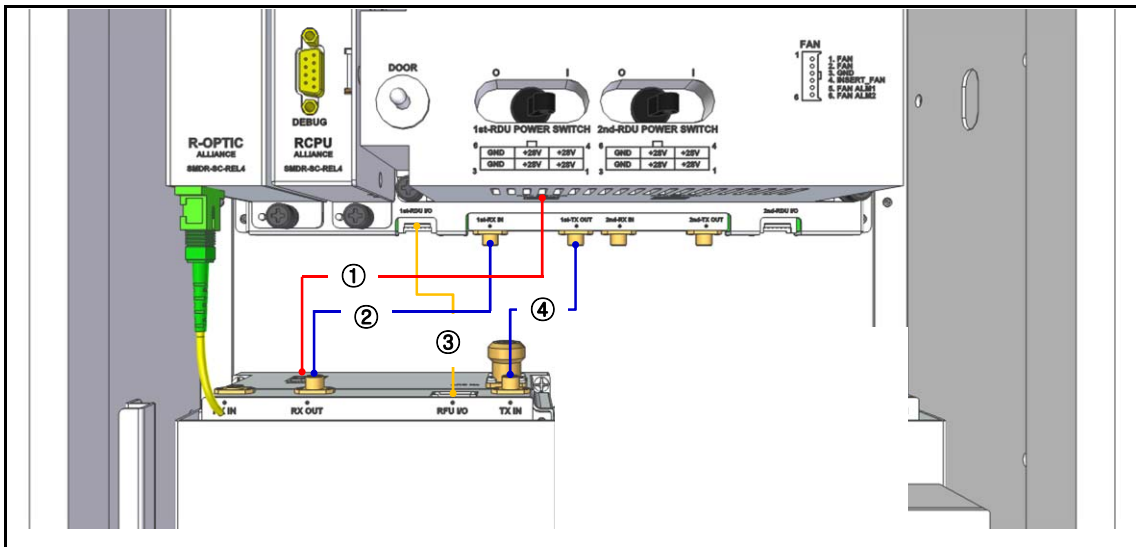

**Figure 5.13 – Installation diagram of RDU**



Second, connect cables between PSU/SIU and RDU like below  
We recommend to assemble in order

1. RDU power : 
2. RDU RF RX cable : 
3. RDU I/O : 
4. RDU RF TX cable : 



**Figure 5.14 – Connection diagram of RDU1**

Third, connect RDU's antenna cable to antenna port of enclosure.

5. RDU RF antenna : 

When you unmount RDU from enclosure, if you work in the reverse order you can unmount RDU easily

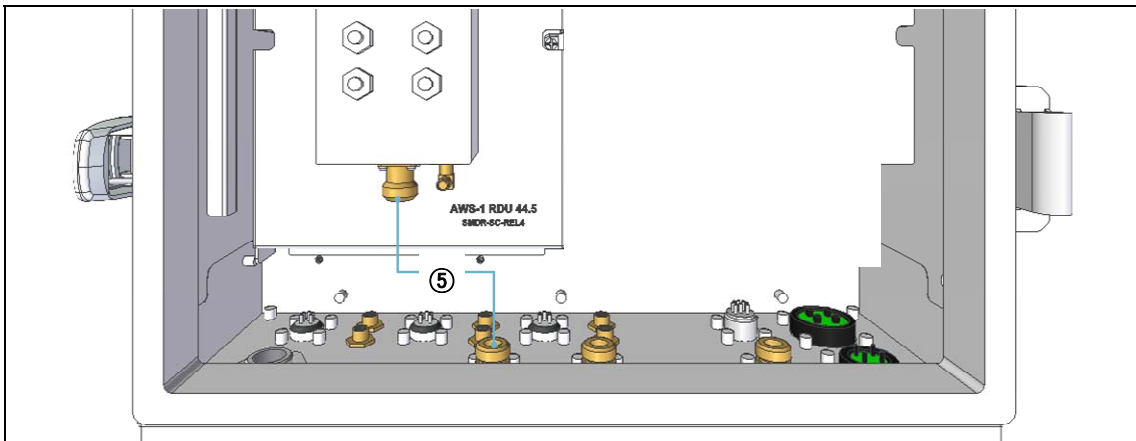
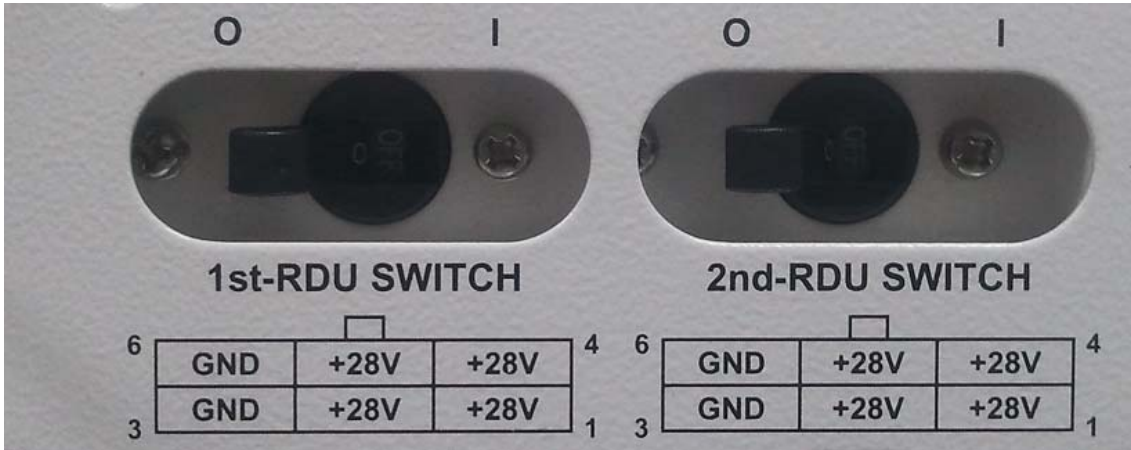

Figure 5.14 – Connection diagram of RDU2



Before it assemble RDU at the ROU enclosure, should turn RDU switch off like below



When all connections are completed, should turn RDU switch on

At this time, the switch's direction is at O : the status of turn it off and I : the status of turn it on.

### 5.1.8 How to mount FAN Unit

Fan unit will be delivered without connecting with enclosure because FAN connector is subject to be broken by external impact. After you install enclosure, you should mount FAN Unit.

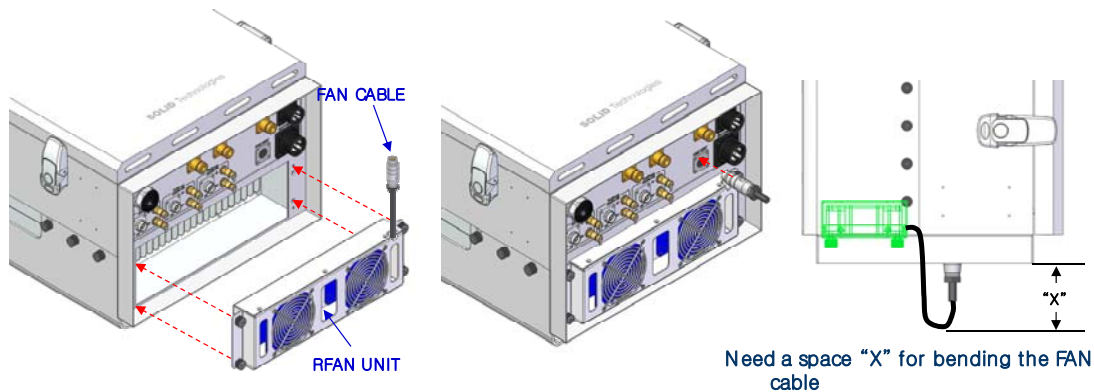

**Figure 5.14 – How to mount FAN Unit**

The screw for fixing FAN unit is already embedded in the FAN Unit.

First, push FAN Unit to designated location of enclosure.

Second, fix four screws for fixing Fan unit using driver

Third, connect Fan connector each other

Fourth, guarantee proper space “X” for bending the FAN cable

FAN unit have two fans inside to support proper cooling of enclosure. Each fan is operated separately according to RDU insertion and temperature.

Fan’s rpm is varied according to temperate of PAU of RDU in two steps. FAN on/off can be operated manually but basically we delivered enclosure with operating auto mode. Here, auto mode repeats on/off operation according to setting temperature range in advance.

### 5.1.9 Consumption of HROU

The following table shows power consumption of HROU component:

Part	Unit	Consumption Power	Remark
Common Part	Enclosure	HMRU : 50W	
	RCPU		
	ROPTIC	HARU : 40W	
	RPSU		
RDUs	1900PCS RDU44.5	350W	
	850CEL RDU44.5	300W	
	700LTE RDU44.5	300W	
	AWS-1 RDU44.5	330W	
	700PS RDU44.5	320W	
	800I/PS RDU44.5	300W	
	900I RDU44.5	300W	

For power consumption of HROU, the common part consumes 50W and 40W at the HMRU and HARU. Depending on the quantity of each RDU, you can add overall power consumption of HROU. Note that when you calculate Power Budget.

# ***Section 6***

## **Operation**

---

### **6.1 HROU Operation**

This chapter describes operation of SMDR-NH124. It deals with procedures and operations for normal system operation after installation. It also describes operations per unit and interworking methods.

## 6.1 HROU Operation

The figure below shows the level of the system link of Alliance DAS (BIU-ODU-HROU). This section describes HROU-related information. HROU receives various signals through optical modules. The signals are filtered only for corresponding signal band from a corresponding RDU module and amplified with a High Power Amplifier. RDU's output power is radiated through antenna port of enclosure. HMRU can drop up to 3ARUs using RF cables

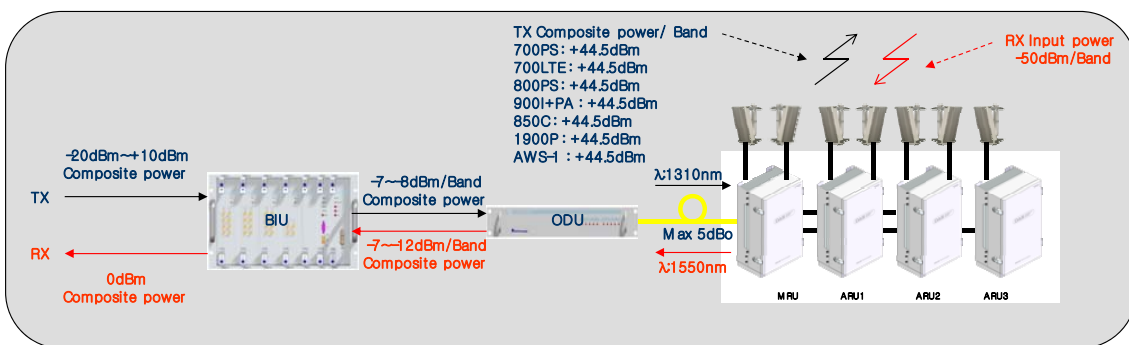

Figure 6.1 – Level diagram

### 6.1.1 HROU Operation

HROU is in one-body enclosure type. And this can be installed on a wall basically. HMRU can expand HARU up to 3. HMRU transmit/receives signal from ODU or OEU and transmits TX signal to HARU, receive RX signals from HARU.















HMRU can support optical loss up to 10dBo for DOU with 1 optical port, and up to 5dBo for DOU with 4optical ports. According to optical loss, HMRU compensates optical loss based on internal calculation formula. Per band, it can control output power and ALC function, AGC function and shutdown function.

HMRU and HARU provide antenna port each band.

The following show operational procedures after installation of HROU.

## 1) Checking the status of HROU's LED Indicator

After turning on the switch of the power supply in HROU, check information on each module's LED of the system. The table below shows normal/abnormal cases depending on the status of each module's LED.

Unit	LED		Indicates
RCPU	ON		Green: HROU is normally power-supplied.
	LD		Green: Laser Diode is normal.
			Red: Laser Diode is abnormal.
	PD		Green: Photo Diode is normal.
			Red: Photo Diode is abnormal; check optical cables.
	TXD		Green flicker: TX transmitting FSK data to BIU/OEU.
	RXD		Green flicker: RX receiving FSK data from BIU/OEU.
	ALM		Green: HROU system is normal.
		Red: HROU system is abnormal; check the alarm through RS-232C.	
RDU	ON		The power is not supplied.
			The power is supplied
RPSU	AC Status		The power is supplied
			The power is not supplied
	DC Status		DC output power is good
			DC output power is abnormal by over-current, etc

## 2) ID Setting

Connect an RS-232 Cable(Direct Cable) for connection with DEBUG port of HROU RCPU. Execute GUI (Graphic User Interface). When you connect HROU directly with a Serial port, the screen will show the TREE of a direct line of units connected with HROU. Basic HROU ID is set as ODU1-DOU1-HROU1. Set it with the ID of a designed HROU. Before setting an HROU ID, you need to check if HROU is connected with the optical port of ODU or OEU (See System Topology at "Setting whether to use BIU").



**Figure 6.2 – ID setting Menu**

Check current setting ID through Get button, and then set ID you want to set



If HROUs with same ID is connected to BIU, the screen will get fail to read status information on the HROUs with the same ID. Therefore, make sure not to duplicate set HROU ID.

## 3) Checking Communication LED of RCPU

Check if TXD and RXD LED indicator on RCPU make a communication. Receiving FSK signals from BIU, HROU sends requested status value to BIU. During reception, RXD LED flicks. During transmission, on the other hand, TXD LED flicks. At this time, you need to check if whether to use a corresponding HROU is checked on (See "whether to use BIU OEU/HROU").

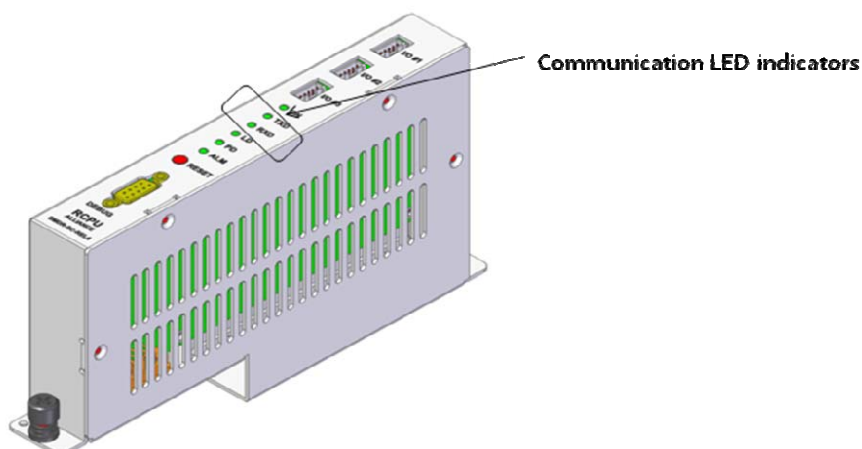

**Figure 6.3 – Communication LED indicator**



#### 4) HROU Optic Comp Operation

HROU(HMRU) has the function of automatically compensating for optical loss. It can do the work for up to 10dBo of optical loss. Set "TX OPTIC COMP" of HROU as "ON." Optical compensation of HROU can not be made without communication with such units in upper level as ODU or OEU. For 1dBo of optical loss, basic TX OPTIC ATT is 24dB; for 10dBo of optical loss, TX OPTIC ATT is 4dB. OPTIC COMP works only one time before it stays dormant.

The figure below shows a screen for OPTIC Information in HROU GUI.

LD POWER means output level of HROU Laser Diode, which is sent to a upper unit by HROU.

PD POWER means input level of Photo Diode to be received from a upper unit.

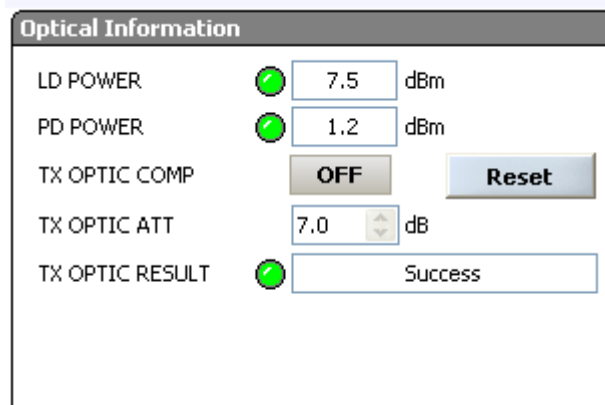

**Figure 6.4 – Optic information window**

During optical compensation, the Result window shows "Processing" and then a result value.

There are three types of results as follows:

1. Success: The optical compensation is normally made.
2. Over Optic Loss: Generated optical loss is more than 12dBo.
3. Communication Fail: Communication with HROU is in poor condition.



If HROU does not make optical compensation, there will be errors in the budget of system link. It can cause lower output level or make Spurious Emission not satisfying for a standard.

## 5) RDU Setting

Mount RDUs you want to offer service up to 2 according to the procedurs described at chatper 5. After all cables are connected completely, turn the RDU switch on. Check if the LED become green. Through GUI, check if the ID of RDU module is inquired at 1<sup>st</sup> band and 2<sup>nd</sup> band. When you select the tab of a corresponding slot (HMRU, HARU) from the main window of HROU, you can inquire and set the status of a corresponding RDU module.

Acces	ROUs	1ST BAND	2ND BAND
	<b>HMRU</b>	800PS	1900PCS
	HARU1	700PS	850C
	HARU2	NONE	NONE
	HARU3	NONE	NONE

**Figure 6.5 – Information HROU and RDU ID**

If band ID is shown, cables connection and communication is well.

- 1) Turn TX AMP On/off on
- 2) After setting AGS leve you want to set and execute TX OUT AGS
- 3) Checking if TX OUT POWER is proper level you want to
- 4) Turn TX OUT SD on
- 5) Check if the alarms occurred. If alarm arise, refer to “troubleshooting manual”

2nd Band 1900PCS
RDU SWITCH ON

TX OUT ATT <input type="text" value="10.0"/> dB	RX IN ATT <input type="text" value="6.0"/> dB
TX OUT POWER <input type="text" value="40.9"/> dBm	RX IN POWER <input type="text" value="-100.0"/> dBm
TX OUT HIGH <input type="text" value="45.0"/> dBm	RX IN ALC <b>OFF</b> <input type="text" value="-45.0"/> dBm
TX OUT LOW <input type="text" value="10.0"/> dBm	MODULE RESET <input type="button" value="Reset"/>
TX OUT SD <b>OFF</b>	
TX OUT ALC <b>OFF</b> <input type="text" value="40.0"/> dBm	
TX OUT AGS <b>OFF</b> <input type="text" value="44.5"/> dBm	
TX OUT AGS RESULT <input type="text" value="Success"/>	

---

AMP Information

Over Power	TX AMP On/Off <input type="button" value="ON"/>
High Temp	AMP RESET <input type="button" value="Reset"/>
VSWR	
Other	

---

FAN    FAN On/Off

FAN Auto En

**Figure 6.6 – RDU Setting window**

The table below shows maximally available Composite Powerlevels that can be set per band:

RDU Band	Composite power	Setting range
700PS	44.5dBm	44.5 ~ 19.5dBm
700LTE	44.5dBm	44.5 ~ 19.5dBm
800PS	44.5dBm	44.5 ~ 19.5dBm
850Cellular	44.5dBm	44.5 ~ 19.5dBm
900I+Paging	44.5dBm	44.5 ~ 19.5dBm
1900PCS	44.5dBm	44.5 ~ 19.5dBm
AWS-1	44.5dBm	44.5 ~ 19.5dBm

AGS function enables you to adjust output power as you like. While the AGS function is being executed, the Result window shows "Processing" and then a result value. There are three types of results as follows:

- A. Success: The AGS function is normally completed.
- B. Not Operate OPTIC Comp: Optic Comp is not executed yet.
- C. Lack of ATT: There is no available attenuation.

Use various upper/lower limits. The following table shows recommended limit settings:

Item	Recommended Limit	Remark
TX OUT HIGH ALM	Max Composit Power+1dB	Alarm
TX OUTPUT LOW ALM	20dBm	Alarm
TX OUTPUT ALC	Max Composit Power	Auto Level control
RX ALC	-45dBm	

TX OUTPUT HIGH ALM : If current value is higher than a setting value, alarm will be genrated.

TX OUTPUT LOW ALM : If current value is lower than a setting value, alarm will be genrated

TX OUTPUT HIGH ALM/LOW ALM tends to work only as warning.

When you activate ("ON") RX ALC, inputs will be restricted depending on a setting value.

## 6) FAN operation

FAN operates each RDU and you can turn it on or off through FAN on/off. But if FAN Auto En is executing, user can't control FAN on/off. If you want to turn fan off, first turn FAN Auto En off.



**Figure 6.7 – Fan information**

FAN operates two modes,

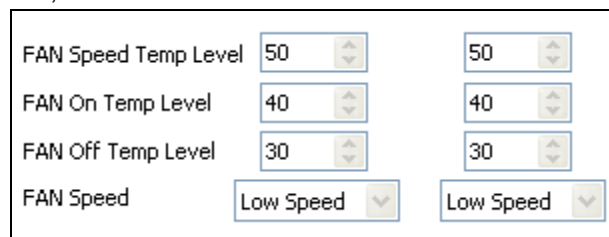

**Figure 6.8 – Fan setting window**

1. FAN On/OFF
  - A. According to temperature, fan repeats on/off operation.
  - B. FAN On Temp Level : The temperature of turning fan on
  - C. FAN Off Temp Level : The temperature of turning fan off
2. Low RPM or High RPM
  - A. According to temperature, fan rpm is varied
  - B. FAN Speed Temp Level : while turning fan on, if current temperature is lower than setting level the fan operates in Low speed and higher than setting level the fan operates in High speed.