

TEST REPORT

FCC Test for eROU_40403434L2_X
Certification

APPLICANT
SOLiD, Inc.

REPORT NO.
HCT-RF-2310-FC081

DATE OF ISSUE
October 20, 2023

Tested by
Sang Su Lee

Technical Manager
Jong Seok Lee

HCT CO., LTD.
Bongjai Huh
BongJai Huh / CEO



HCT Co., Ltd.

74, Seoicheon-ro 578beon-gil, Majang-myeon, Icheon-si, Gyeonggi-do, 17383 KOREA
Tel. +82 31 634 6300 Fax. +82 31 645 6401

TEST REPORT

FCC Test for
eROU_40403434L2_X

REPORT NO.
HCT-RF-2310-FC081

DATE OF ISSUE
October 20, 2023

Additional Model
eROU_40403434L1_N, eROU_40403434L1_X, eROU_40403434L2_N

Applicant **SOLiD, Inc.**
10, 9th Floor, SOLiD Space, Pangyoyeok-ro 220, Bundang-gu, Seongnam-si,
Gyeonggi-do, 463-400, South Korea

Eut Type DAS System
Model Name eROU_40403434L2_X

FCC ID W6UER40403434

Output Power	3.7 GHz Service	3.45 GHz Service
	ANT 1: 24 dBm	ANT 1: 22 dBm
	ANT 2: 24 dBm	ANT 2: 22 dBm
	2Tx MIMO: 27 dBm	2Tx MIMO: 25 dBm

Date of Test September 11, 2023 ~ October 18, 2023

FCC Rule Parts: CFR 47 Part 2, Part 27

The result shown in this test report refer only to the sample(s) tested unless otherwise stated.
This test results were applied only to the test methods required by the standard.

REVISION HISTORY

The revision history for this test report is shown in table.

Revision No.	Date of Issue	Description
0	October 20, 2023	Initial Release

The measurements shown in this report were made in accordance with the procedures indicated, and the emissions from this equipment were found to be within the limits applicable. I assume full responsibility for the accuracy and completeness of these measurements, and for the qualifications of all persons taking them. It is further stated that upon the basis of the measurements made, the equipment tested is capable of operation in accordance with the requirements of the FCC Rules under normal use and maintenance.

Test Report Statement:

The above Test Report is not related to the accredited test result by (KS Q) ISO/IEC 17025 and KOLAS(Korea Laboratory Accreditation Scheme) / A2LA(American Association for Laboratory Accreditation)(4114.01), which signed the ILAC-MRA.

If this report is required to confirmation of authenticity, please contact to www.hct.co.kr

CONTENTS

1. GENERAL INFORMATION	5
1.1. APPLICANT INFORMATION	5
1.2. PRODUCT INFORMATION	5
1.3. TEST INFORMATION	5
2. FACILITIES AND ACCREDITATIONS	6
2.1. FACILITIES	6
2.2. EQUIPMENT	6
3. TEST SPECIFICATIONS	7
3.1. STANDARDS	7
3.2. ADDITIONAL DESCRIPTIONS ABOUT TEST	8
3.3. MEASUREMENT UNCERTAINTY	10
3.4. STANDARDS ENVIRONMENTAL TEST CONDITIONS	10
3.5. TEST DIAGRAMS	11
4. TEST EQUIPMENTS	13
5. TEST RESULT	14
5.1. AGC THRESHOLD	14
5.2. OUT-OF-BAND REJECTION	16
5.3. INPUT-VERSUS-OUTPUT SIGNAL COMPARISON	19
5.4. INPUT/OUTPUT POWER AND AMPLIFIER/BOOSTER GAIN	66
5.5. OUT-OF-BAND/OUT-OF-BLOCK EMISSIONS AND SPURIOUS EMISSIONS	106
5.6. RADIATED SPURIOUS EMISSIONS	242
5.7. FREQUENCY STABILITY	248
6. Annex A_EUT AND TEST SETUP PHOTO	253

1. GENERAL INFORMATION

1.1. APPLICANT INFORMATION

Company Name	SOLiD, Inc.
Company Address	10, 9th Floor, SOLiD Space, Pangyoyeok-ro 220, Bundang-gu, Seongnam-si, Gyeonggi-do, 463-400, South Korea

1.2. PRODUCT INFORMATION

EUT Type	DAS System	
EUT Serial Number	erou40403434_L2_#26	
Power Supply	DC 39 ~ 57 Vdc	
Frequency Range	Band Name	Downlink (MHz)
	3.7 GHz Service	3 700 ~ 3 980
	3.45 GHz Service	3 450 ~ 3 550
Tx Output Power	3.7 GHz Service ANT 1: 24 dBm ANT 2: 24 dBm 2Tx MIMO: 27 dBm	3.45 GHz Service ANT 1: 22 dBm ANT 2: 22 dBm 2Tx MIMO: 25 dBm
Antenna Peak Gain	SISO: Antenna Peak Gain: 17 dBi (External) Antenna Peak Gain: 5.5 dBi (Internal) MIMO: Directional Peak Gain: 20 dBi (External) Directional Peak Gain: 8.5 dBi (Internal)	

1.3. TEST INFORMATION

FCC Rule Parts	CFR 47 Part 2, Part 27
Measurement Standards	KDB 935210 D05 v01r04, KDB 971168 D01 v03r01, KDB 662911 D01 v02r01, ANSI C63.26-2015
Test Location	HCT CO., LTD. 74, Seoicheon-ro 578beon-gil, Majang-myeon, Icheon-si, Gyeonggi-do, 17383, Rep. of KOREA

2. FACILITIES AND ACCREDITATIONS

2.1. FACILITIES

The SAC(Semi-Anechoic Chamber) and conducted measurement facility used to collect the radiated data are located at the 74, Seoicheon-ro 578beon-gil, Majang-myeon, Icheon-si, Gyeonggi-do, 17383, Rep. of KOREA.

The site is constructed in conformance with the requirements of ANSI C63.4 (Version: 2014) and CISPR Publication 22.

Detailed description of test facility was submitted to the Commission and accepted dated March 31, 2022 (CAB identifier: KR0032).

2.2. EQUIPMENT

Radiated emissions are measured with one or more of the following types of linearly polarized antennas: tuned dipole, bi-conical, log periodic, bi-log, and/or ridged waveguide, horn. Spectrum analyzers with pre-selectors and quasi-peak detectors are used to perform radiated measurements.

Calibrated wideband preamplifiers, coaxial cables, and coaxial attenuators are also used for making measurements.

All receiving equipment conforms to CISPR Publication 16-1, "Radio Interference Measuring Apparatus and Measurement Methods."



3. TEST SPECIFICATIONS

3.1. STANDARDS

The following tests were conducted on a sample of the equipment for the purpose of demonstrating compliance with FCC Part 2, Part 27

Description	Reference	Results
AGC threshold	KDB 935210 D05 v01r04 3.2	Compliant
Out-of-band rejection	KDB 935210 D05 v01r04 3.3	Compliant
Input-versus-output signal comparison	§ 2.1049	Compliant
Input/output power and amplifier/booster gain	§ 2.1046, § 27.50(j)(2), § 27.50(k)(2), § 27.50(j)(4), § 27.50(k)(4)	Compliant
Out-of-band/out-of-block emissions and spurious emissions	§ 2.1051, § 27.53(l)(1), § 27.53(n)(1)	Compliant
Spurious emissions radiated	§ 2.1053, § 27,53(l)(1), § 27.53(n)(1)	Compliant
Frequency Stability	§ 2.1055 § 27.54	Compliant

3.2. ADDITIONAL DESCRIPTIONS ABOUT TEST

Except for the following cases, EUT was tested under normal operating conditions.

: Out-of-band rejection test requires maximum gain condition without AGC.

The test was generally based on the method of KDB 935210 D05 v01r04 and only followed ANSI C63.26-2015 if there was no test method in KDB standard.

EUT was tested with following modulated signals provide by applicant.

Band Name	Tested signals
3.7 GHz Service	5G NR 20 MHz
	5G NR 40 MHz
	5G NR 60 MHz
	5G NR 80 MHz
	5G NR 100 MHz
3.45 GHz Service	5G NR 20 MHz
	5G NR 40 MHz
	5G NR 60 MHz
	5G NR 80 MHz
	5G NR 100 MHz

This model has both external (eROU_40403434L1_X, eROU_40403434L2_X) and internal (eROU_40403434L1_N, eROU_40403434L2_N) types. The internal type is equipped with the internal antenna in it. Thus, we fully tested the external type and then Radiated Spurious Emissions for the internal type after spot-checking.

The tests results included actual loss value for attenuator and cable combination as shown in the table below.

: Input Path

Correction factor table			
Frequency (MHz)	Factor (dB)	Frequency (MHz)	Factor (dB)
3 300	2.222	3 700	2.596
3 350	2.062	3 750	2.588
3 400	2.033	3 800	2.720
3 450	2.031	3 850	2.560
3 500	2.037	3 900	2.489
3 550	1.984	3 950	2.646
3 600	2.635	4 000	2.488
3 650	2.706	-	-

: Output Path

Correction factor table

Frequency (MHz)	Factor (dB)	Frequency (MHz)	Factor (dB)
0.009	19.300	16 000	25.586
40	19.299	17 000	25.956
80	19.353	18 000	26.146
100	19.390	19 000	26.362
200	19.574	20 000	27.163
300	19.793	21 000	27.455
400	19.949	22 000	29.372
500	19.969	23 000	35.143
600	20.110	24 000	29.397
700	20.229	25 000	28.230
800	20.240	26 000	28.160
900	20.310	27 000	27.418
1 000	20.413	28 000	27.807
2 000	20.948	29 000	28.141
3 000	21.356	30 000	27.905
4 000	21.996	31 000	28.505
5 000	22.309	32 000	28.525
6 000	22.325	33 000	28.709
7 000	22.903	34 000	29.476
8 000	23.342	35 000	28.757
9 000	23.638	36 000	29.081
10 000	23.909	37 000	28.754
11 000	24.381	38 000	28.934
12 000	24.746	39 000	29.045
13 000	25.012	40 000	27.997
14 000	25.242	-	-
15 000	25.421	-	-

3.3. MEASUREMENT UNCERTAINTY

Description	Condition	Uncertainty
Radiated Disturbance	9 kHz ~ 30 MHz	± 4.14 dB
	30 MHz ~ 1 GHz	± 5.82 dB
	1 GHz ~ 18 GHz	± 5.74 dB
	18 GHz ~ 40 GHz	± 5.76 dB

Note: Coverage factor $k=2$, Confidence levels of 95 %

3.4. STANDARDS ENVIRONMENTAL TEST CONDITIONS

Temperature	+15 °C to +35 °C
Relative humidity	30 % to 60 %
Air pressure	860 mbar to 1 060 mbar

3.5. TEST DIAGRAMS

Conducted Test

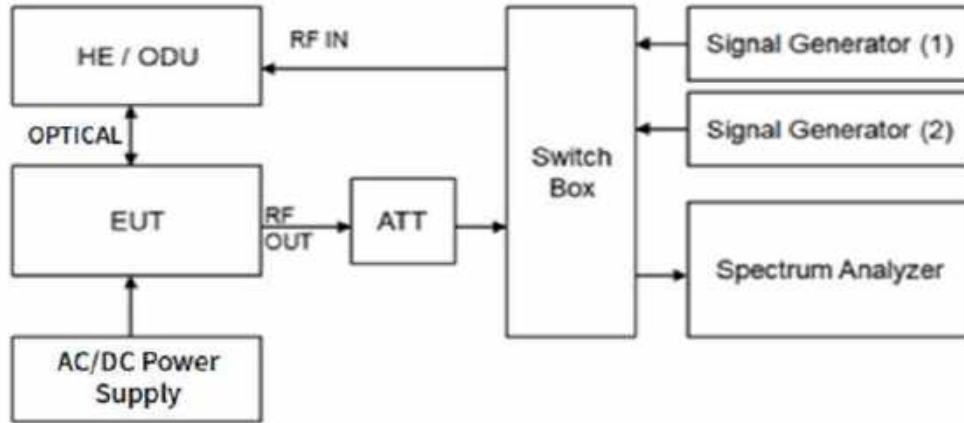

Radiated Test

30 MHz ~ 1 GHz

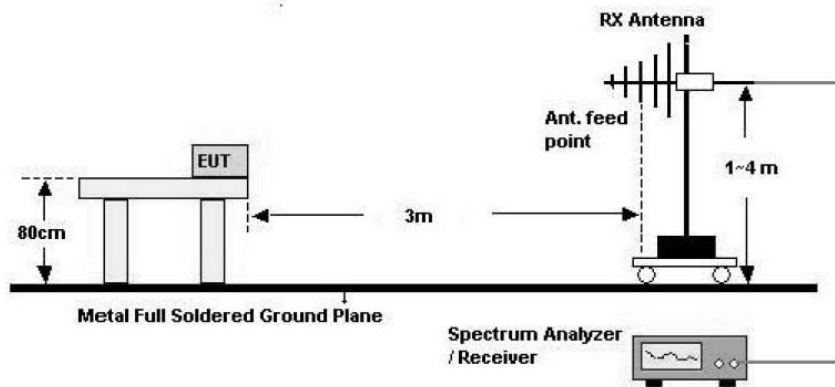

Above 1 GHz

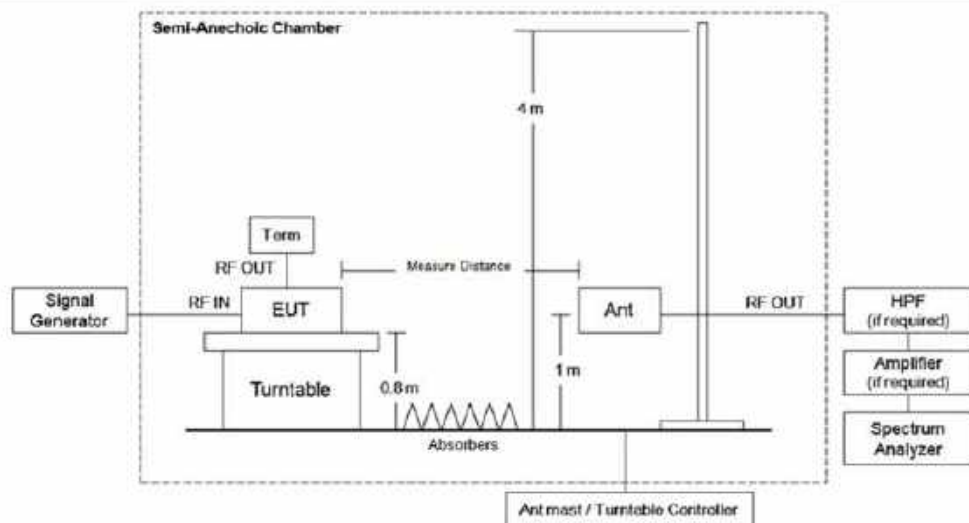

Frequency Stability

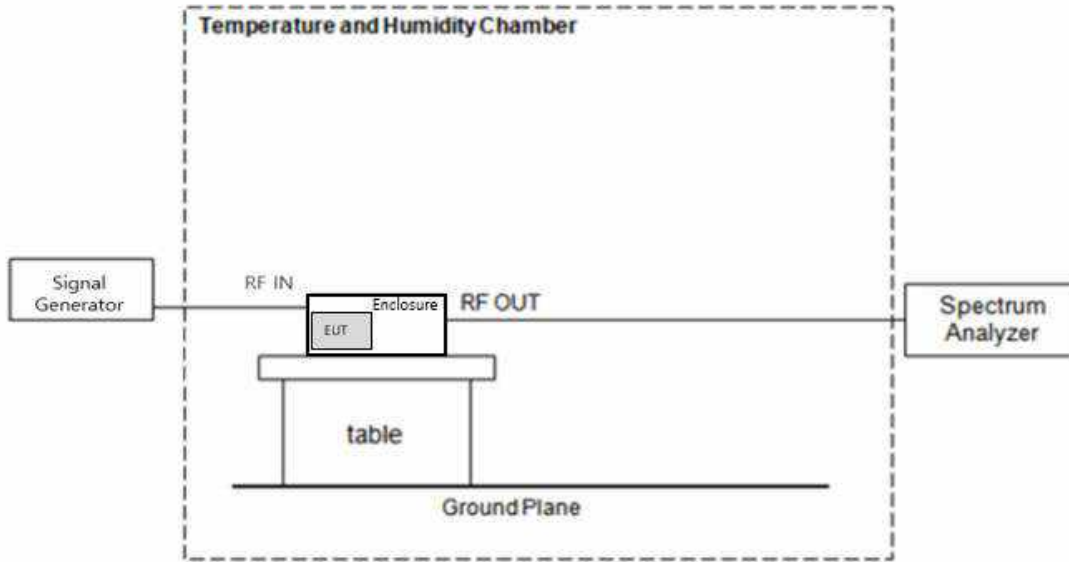

4. TEST EQUIPMENTS

Equipment	Model	Manufacturer	Serial No.	Due to Calibration	Calibration Interval
PXA Signal Analyzer	N9030A	Keysight	MY49431434	01/02/2024	Annual
MXG Vector Signal Generator	N5182A	Agilent	MY46240807	12/23/2023	Annual
MXG Vector Signal Generator	N5182A	Agilent	MY47070406	02/15/2024	Annual
20 dB Attenuator	FAS-23-20	MCLI	103756	01/03/2024	Annual
^(a) 30 dB Attenuator	WA93-30-33	Weinschel Associates	0166	11/21/2023	Annual
^(a) 50Ω Termination	908A	H.P.	N/A	N/A	N/A
DC Power Supply	PWR800L	KIKUSUI	LJ003448	05/24/2024	Annual
Temperature & Humidity Chamber	PL-4KP	ESPEC	14021890	09/27/2024	Annual
Switch	S46	KEITHLEY	1088024	N/A	N/A
Controller (Antenna Mast & Turn Table)	CO3000	Innco systems	CO3000/1251/ 48920320/P	N/A	N/A
Antenna Position Tower	MA4640/800-XP-ET	Innco systems	N/A	N/A	N/A
Turn Table	N/A	Ets	N/A	N/A	N/A
Turn Table	DS2000-S	Innco systems	N/A	N/A	N/A
Loop Antenna	FMZB 1513	Schwarzbeck	1513-333	03/17/2024	Biennial
Trilog Super Broadband Antenna	VULB 9168	Schwarzbeck	9168-0895	08/16/2024	Biennial
Horn Antenna	BBHA 9120D	Schwarzbeck	02296	05/18/2024	Biennial
Horn Antenna (15 GHz ~ 40 GHz)	BBHA9170	Schwarzbeck	BBHA9170124	03/28/2025	Biennial
Spectrum Analyzer	FSP40	Rohde & Schwarz	100843	11/08/2023	Annual
Amp & Filter Bank Switch Controller	FBSM-01B	TNM system	TM20090002	N/A	N/A
RF Switching System	FBSR-04C(LNA)	TNM system	S4L4	08/18/2024	Annual
High Pass Filter	WHNX6.0/26.5G-6SS	Wainwright Instruments	1	01/19/2024	Annual
Low Noise Amplifier	TK-PA1840H	TESTEK	170011-L	10/24/2023	Annual

^(a)This equipment has been used to each port, but we only listed one equipment for simplicity.

Note:

1. Equipment listed above that calibrated during the testing period was set for test after the calibration.
2. Equipment listed above that has a calibration due date during the testing period, the testing is completed before equipment expiration date.

5. TEST RESULT

5.1. AGC THRESHOLD

Test Requirement:

KDB 935210 D05 v01r04

Testing at and above the AGC threshold is required.

Test Procedures:

Measurements were in accordance with the test methods section 3.2 of KDB 935210 D05 v01r04.

In the case of fiber-optic distribution systems, the RF input port of the equipment under test (EUT) refers to the RF input of the supporting equipment RF to optical convertor; see also descriptions and diagrams for typical DAS System booster systems in KDB Publication 935210 D02

Devices intended to be directly connected to an RF source (donor port) only need to be evaluated for any over-the-air transmit paths.

- a) Connect a signal generator to the input of the EUT.
- b) Connect a spectrum analyzer or power meter to the output of the EUT using appropriate attenuation as necessary.
- c) The signal generator should initially be configured to produce either of the required test signals.
- d) Set the signal generator frequency to the center frequency of the EUT operating band.
- e) While monitoring the output power of the EUT, measured using the methods of ANSI C63.26-2015 subclause 5.2.4.4.1, increase the input level until a 1 dB increase in the input signal power no longer causes a 1 dB increase in the output signal power.
- f) Record this level as the AGC threshold level.
- g) Repeat the procedure with the remaining test signal.

Output power measurement in subclause 5.2.4.4.1 of ANSI C63.26

- a) Set span to $2 \times$ to $3 \times$ the OBW.
- b) Set RBW = 1% to 5% of the OBW.
- c) Set VBW $\geq 3 \times$ RBW.
- d) Set number of measurement points in sweep $\geq 2 \times$ span / RBW.
- e) Sweep time: auto-couple
- f) Detector = power averaging (rms).
- g) If the EUT can be configured to transmit continuously, then set the trigger to free run.
- h) Omit
- i) Trace average at least 100 traces in power averaging (rms) mode if sweep is set to auto-couple. To accurately determine the average power over multiple symbols, it can be necessary to increase the number of traces to be averaged above 100 or, if using a manually configured sweep time, increase the sweep time.



- j) Compute the power by integrating the spectrum across the OBW of the signal using the instrument's band or channel power measurement function, with the band/channel limits set equal to the OBW band edges. If the instrument does not have a band or channel power function, then sum the spectrum levels (in linear power units) at intervals equal to the RBW extending across the entire OBW of the spectrum.

Test Results:

Test Band	Link	Signal	Center Frequency (MHz)	AGC Threshold Level (dBm)	Output Level (dBm)
3.7 GHz Service (ANT 1)	Downlink	5G NR 20 MHz	3 840.00	-20	23.80
		5G NR 40 MHz	3 840.00	-20	23.57
		5G NR 60 MHz	3 840.00	-20	23.72
		5G NR 80 MHz	3 840.00	-20	23.51
		5G NR 100 MHz	3 840.00	-20	23.52
3.45 GHz Service (ANT 1)		5G NR 20 MHz	3 500.00	-20	21.80
		5G NR 40 MHz	3 500.00	-20	21.61
		5G NR 60 MHz	3 500.00	-20	21.82
		5G NR 80 MHz	3 500.00	-20	21.94
		5G NR 100 MHz	3 500.00	-20	21.74
3.7 GHz Service (ANT 2)		5G NR 20 MHz	3 840.00	-20	23.60
		5G NR 40 MHz	3 840.00	-20	23.59
		5G NR 60 MHz	3 840.00	-20	23.56
		5G NR 80 MHz	3 840.00	-20	23.64
		5G NR 100 MHz	3 840.00	-20	23.85
3.45 GHz Service (ANT 2)		5G NR 20 MHz	3 500.00	-20	21.76
		5G NR 40 MHz	3 500.00	-20	21.59
		5G NR 60 MHz	3 500.00	-20	21.61
		5G NR 80 MHz	3 500.00	-20	21.92
		5G NR 100 MHz	3 500.00	-20	21.76

5.2. OUT-OF-BAND REJECTION

Test Requirement:

KDB 935210 D05 v01r04

Out-of-band rejection required.

Test Procedures:

Measurements were in accordance with the test methods section 3.3 of KDB 935210 D05 v01r04.

A signal booster shall reject amplification of other signals outside of its passband. Adjust the internal gain control of the EUT (if so equipped) to the maximum gain for which equipment certification is sought.

- a) Connect a signal generator to the input of the EUT.
- b) Configure a swept CW signal with the following parameters:
 - 1) Frequency range = $\pm 250\%$ of the passband, for each applicable CMRS band.
 - 2) Level = a sufficient level to affirm that the out-of-band rejection is > 20 dB above the noise floor and will not engage the AGC during the entire sweep.
 - 3) Dwell time = approximately 10 ms.
 - 4) Number of points = $\text{SPAN}/(\text{RBW}/2)$.
- c) Connect a spectrum analyzer to the output of the EUT using appropriate attenuation.
- d) Set the span of the spectrum analyzer to the same as the frequency range of the signal generator.
- e) Set the resolution bandwidth (RBW) of the spectrum analyzer to be 1 % to 5 % of the EUT passband, and the video bandwidth (VBW) shall be set to $\geq 3 \times \text{RBW}$.
- f) Set the detector to Peak Max-Hold and wait for the spectrum analyzer's spectral display to fill.
- g) Place a marker to the peak of the frequency response and record this frequency as f_0 .
- h) Place two markers, one at the lowest and the other at the highest frequency of the envelope of the spectral display, such that each marker is at or slightly below the -20 dB down amplitude, to determine the 20 dB bandwidth.
- i) Capture the frequency response of the EUT.
- j) Repeat for all frequency bands applicable for use by the EUT.

Test Results:

3.7 GHz Service (ANT 1) / Downlink

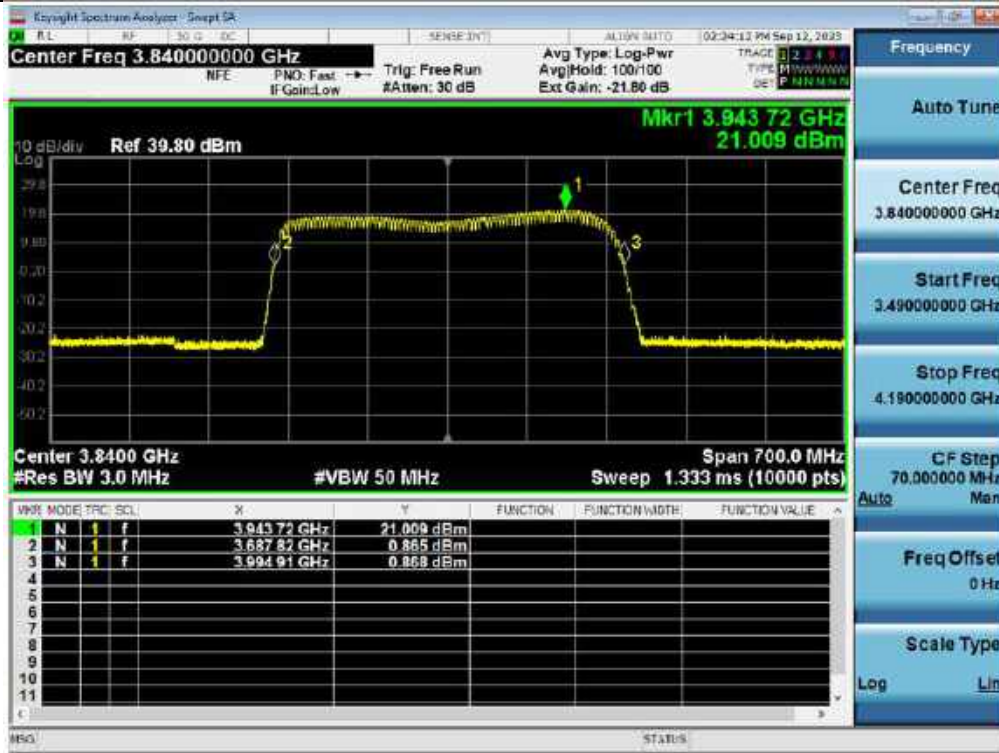

3.45 GHz Service (ANT 1) / Downlink

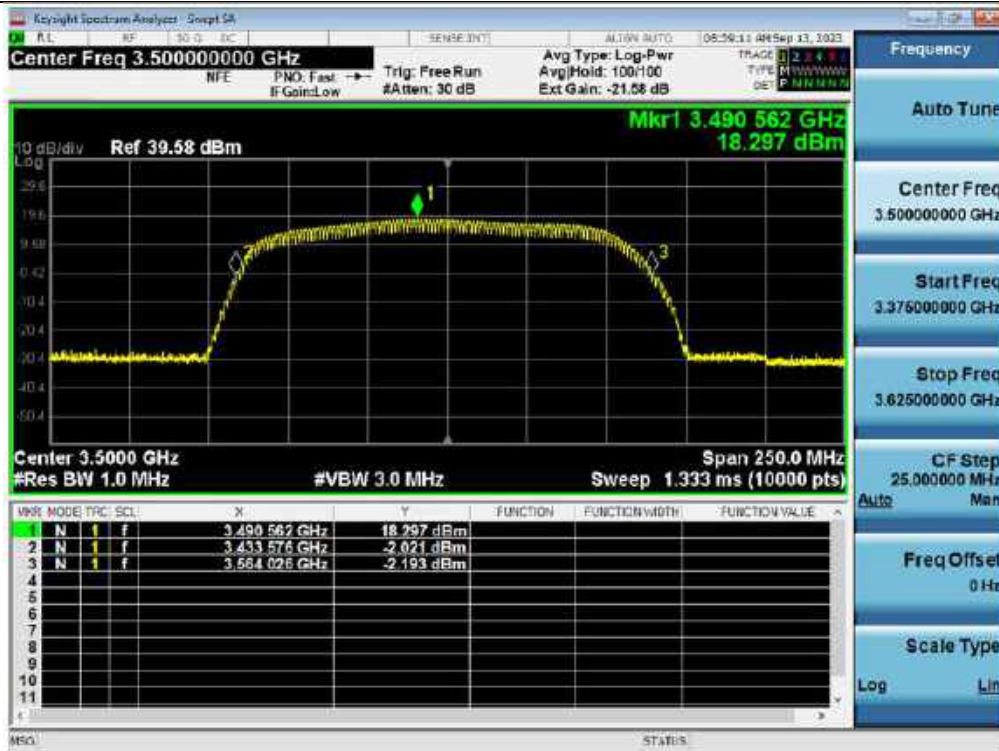

3.7 GHz Service (ANT 2) / Downlink

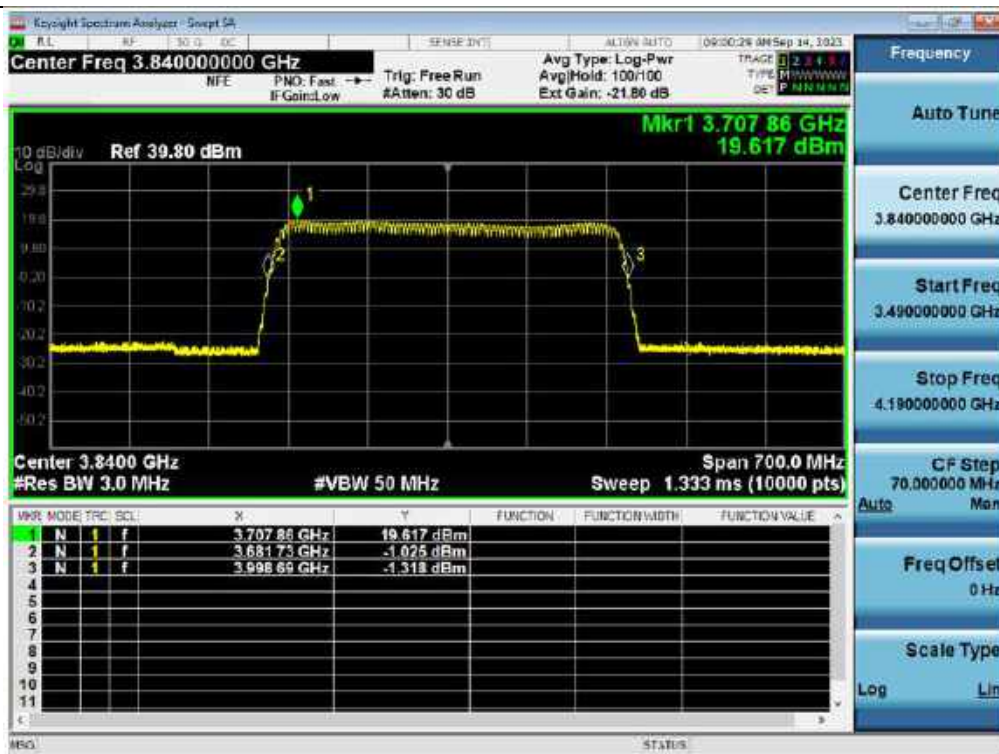

3.45 GHz Service (ANT 2) / Downlink

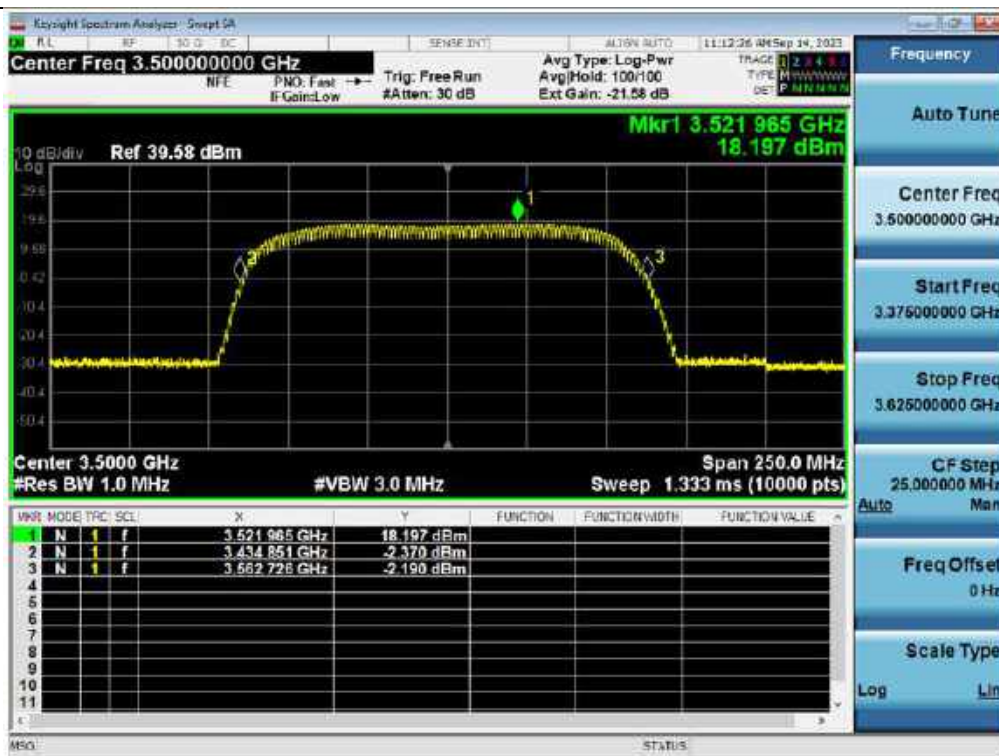

5.3. INPUT-VERSUS-OUTPUT SIGNAL COMPARISON

Test Requirement:

§ 2.1049 Measurements required: Occupied bandwidth.

The occupied bandwidth, that is the frequency bandwidth such that, below its lower and above its upper frequency limits, the mean powers radiated are each equal to 0.5 percent of the total mean power radiated by a given emission shall be measured under the specified conditions of § 2.1049 (a) through (i) as applicable.

Test Procedures:

Measurements were in accordance with the test methods section 3.4 of KDB 935210 D05 v01r04.

A 26 dB bandwidth measurement shall be performed on the input signal and the output signal; alternatively, the 99% OBW can be measured and used. See KDB Publication 971168 [R8] for more information on measuring OBW.

- a) Connect a signal generator to the input of the EUT.
- b) Configure the signal generator to transmit the AWGN signal.
- c) Configure the signal amplitude to be just below the AGC threshold level (see 3.2), but not more than 0.5 dB below.
- d) Connect a spectrum analyzer to the output of the EUT using appropriate attenuation.
- e) Set the spectrum analyzer center frequency to the center frequency of the operational band under test. The span range of the spectrum analyzer shall be between 2 times to 5 times the emission bandwidth (EBW) or alternatively, the OBW.
- f) The nominal RBW shall be in the range of 1 % to 5 % of the anticipated OBW, and the VBW shall be $\geq 3 \times$ RBW.
- g) Set the reference level of the instrument as required to preclude the signal from exceeding the maximum spectrum analyzer input mixer level for linear operation. In general, the peak of the spectral envelope must be more than $[10 \log (\text{OBW} / \text{RBW})]$ below the reference level. Steps f) and g) may require iteration to enable adjustments within the specified tolerances.
- h) The noise floor of the spectrum analyzer at the selected RBW shall be at least 36 dB below the reference level.
- i) Set spectrum analyzer detection function to positive peak.
- j) Set the trace mode to max hold.
- k) Determine the reference value: Allow the trace to stabilize. Set the spectrum analyzer marker to the highest amplitude level of the displayed trace (this is the reference value) and record the associated frequency.
- l) Place two markers, one at the lowest and the other at the highest frequency of the envelope of the spectral display, such that each marker is at or slightly below the -26 dB down amplitude. The 26 dB EBW (alternatively OBW) is the positive frequency difference between the two markers. If the spectral envelope crosses the -26 dB down amplitude at multiple points, the lowest or highest frequency shall be selected as the frequencies that are the furthest removed from the center frequency at which the spectral envelope crosses the -26 dB down amplitude point.
- m) Repeat steps e) to l) with the input signal connected directly to the spectrum analyzer (i.e., input signal

measurement).

- n) Compare the spectral plot of the input signal (determined from step m) to the output signal (determined from step l) to affirm that they are similar (in passband and rolloff characteristic features and relative spectral locations), and include plot(s) and descriptions in test report.
- o) Repeat the procedure [steps e) to n)] with the input signal amplitude set to 3 dB above the AGC threshold.
- p) Repeat steps e) to o) with the signal generator set to the narrowband signal.
- q) Repeat steps e) to p) for all frequency bands authorized for use by the EUT.

Test Results:

Tabular data of Output Occupied Bandwidth

Test Band	Link	Signal	Center Frequency (MHz)	99 % OBW (MHz)	26 dB OBW (MHz)
3.7 GHz Service (ANT 1)	Downlink	5G NR 20 MHz	3 840.00	18.288	19.430
		5G NR 40 MHz	3 840.00	37.972	40.032
		5G NR 60 MHz	3 840.00	57.953	60.976
		5G NR 80 MHz	3 840.00	77.754	81.559
		5G NR 100 MHz	3 840.00	97.840	102.539
3.45 GHz Service (ANT 1)		5G NR 20 MHz	3 500.00	18.273	19.465
		5G NR 40 MHz	3 500.00	37.831	40.016
		5G NR 60 MHz	3 500.00	57.782	60.854
		5G NR 80 MHz	3 500.00	77.137	81.454
		5G NR 100 MHz	3 500.00	96.154	102.149
3.7 GHz Service (ANT 2)		5G NR 20 MHz	3 840.00	18.266	19.452
		5G NR 40 MHz	3 840.00	37.987	39.937
		5G NR 60 MHz	3 840.00	58.048	60.937
		5G NR 80 MHz	3 840.00	77.680	81.525
		5G NR 100 MHz	3 840.00	97.426	102.265
3.45 GHz Service (ANT 2)	5G NR 20 MHz	3 500.00	18.254	19.408	
	5G NR 40 MHz	3 500.00	37.966	39.966	
	5G NR 60 MHz	3 500.00	58.009	60.916	
	5G NR 80 MHz	3 500.00	77.428	81.512	
	5G NR 100 MHz	3 500.00	96.363	102.258	

Tabular data of Input Occupied Bandwidth

Test Band	Link	Signal	Center Frequency (MHz)	99 % OBW (MHz)	26 dB OBW (MHz)
3.7 GHz Service (ANT 1)	Downlink	5G NR 20 MHz	3 840.00	18.234	19.448
		5G NR 40 MHz	3 840.00	38.092	39.985
		5G NR 60 MHz	3 840.00	57.958	60.944
		5G NR 80 MHz	3 840.00	77.659	81.505
		5G NR 100 MHz	3 840.00	97.396	102.407
3.45 GHz Service (ANT 1)		5G NR 20 MHz	3 500.00	18.261	19.433
		5G NR 40 MHz	3 500.00	38.001	40.038
		5G NR 60 MHz	3 500.00	57.942	60.909
		5G NR 80 MHz	3 500.00	77.611	81.497
		5G NR 100 MHz	3 500.00	97.146	102.325
3.7 GHz Service (ANT 2)		5G NR 20 MHz	3 840.00	18.275	19.423
		5G NR 40 MHz	3 840.00	37.958	39.983
		5G NR 60 MHz	3 840.00	57.900	60.967
		5G NR 80 MHz	3 840.00	77.616	81.559
		5G NR 100 MHz	3 840.00	97.278	102.444
3.45 GHz Service (ANT 2)	5G NR 20 MHz	3 500.00	18.245	19.452	
	5G NR 40 MHz	3 500.00	37.936	39.906	
	5G NR 60 MHz	3 500.00	57.920	60.937	
	5G NR 80 MHz	3 500.00	77.631	81.533	
	5G NR 100 MHz	3 500.00	97.237	102.377	

Tabular data of 3 dB above the AGC threshold Output Occupied Bandwidth

Test Band	Link	Signal	Center Frequency (MHz)	99 % OBW (MHz)	26 dB OBW (MHz)
3.7 GHz Service (ANT 1)	Downlink	5G NR 20 MHz	3 840.00	18.259	19.389
		5G NR 40 MHz	3 840.00	37.930	39.959
		5G NR 60 MHz	3 840.00	58.064	60.942
		5G NR 80 MHz	3 840.00	77.841	81.609
		5G NR 100 MHz	3 840.00	97.647	102.375
3.45 GHz Service (ANT 1)		5G NR 20 MHz	3 500.00	18.264	19.459
		5G NR 40 MHz	3 500.00	37.851	39.990
		5G NR 60 MHz	3 500.00	57.762	60.863
		5G NR 80 MHz	3 500.00	77.211	81.418
		5G NR 100 MHz	3 500.00	96.080	102.080
3.7 GHz Service (ANT 2)		5G NR 20 MHz	3 840.00	18.281	19.482
		5G NR 40 MHz	3 840.00	37.928	39.983
		5G NR 60 MHz	3 840.00	57.995	60.970
		5G NR 80 MHz	3 840.00	77.639	81.576
		5G NR 100 MHz	3 840.00	97.318	102.439
3.45 GHz Service (ANT 2)	5G NR 20 MHz	3 500.00	18.252	19.456	
	5G NR 40 MHz	3 500.00	38.095	39.935	
	5G NR 60 MHz	3 500.00	58.034	60.971	
	5G NR 80 MHz	3 500.00	77.555	81.536	
	5G NR 100 MHz	3 500.00	96.466	102.271	



Tabular data of 3 dB above the AGC threshold Input Occupied Bandwidth

Test Band	Link	Signal	Center Frequency (MHz)	99 % OBW (MHz)	26 dB OBW (MHz)
3.7 GHz Service (ANT 1)	Downlink	5G NR 20 MHz	3 840.00	18.260	19.378
		5G NR 40 MHz	3 840.00	38.023	39.900
		5G NR 60 MHz	3 840.00	57.997	60.973
		5G NR 80 MHz	3 840.00	77.735	81.577
		5G NR 100 MHz	3 840.00	97.379	102.463
3.45 GHz Service (ANT 1)		5G NR 20 MHz	3 500.00	18.238	19.466
		5G NR 40 MHz	3 500.00	38.022	39.991
		5G NR 60 MHz	3 500.00	57.888	60.914
		5G NR 80 MHz	3 500.00	77.702	81.493
		5G NR 100 MHz	3 500.00	97.107	102.192
3.7 GHz Service (ANT 2)		5G NR 20 MHz	3 840.00	18.295	19.454
		5G NR 40 MHz	3 840.00	38.000	39.990
		5G NR 60 MHz	3 840.00	57.986	60.953
		5G NR 80 MHz	3 840.00	77.621	81.540
		5G NR 100 MHz	3 840.00	97.423	102.415
3.45 GHz Service (ANT 2)	5G NR 20 MHz	3 500.00	18.249	19.436	
	5G NR 40 MHz	3 500.00	37.932	39.980	
	5G NR 60 MHz	3 500.00	57.981	60.928	
	5G NR 80 MHz	3 500.00	77.681	81.573	
	5G NR 100 MHz	3 500.00	97.390	102.386	

Measured Occupied Bandwidth Comparison

Test Band	Link	Signal	Variant of Input and output 26 dB Occupied Bandwidth (%)	Variant of Input and 3 dB above the AGC threshold output 26 dB Occupied Bandwidth (%)
3.7 GHz Service (ANT 1)	Downlink	5G NR 20 MHz	-0.093	0.057
		5G NR 40 MHz	0.118	0.148
		5G NR 60 MHz	0.053	-0.051
		5G NR 80 MHz	0.066	0.039
		5G NR 100 MHz	0.129	-0.086
3.45 GHz Service (ANT 1)		5G NR 20 MHz	0.165	-0.036
		5G NR 40 MHz	-0.055	-0.003
		5G NR 60 MHz	-0.090	-0.084
		5G NR 80 MHz	-0.053	-0.092
		5G NR 100 MHz	-0.172	-0.110
3.7 GHz Service (ANT 2)		5G NR 20 MHz	0.149	0.144
		5G NR 40 MHz	-0.115	-0.018
		5G NR 60 MHz	-0.049	0.028
		5G NR 80 MHz	-0.042	0.044
		5G NR 100 MHz	-0.175	0.023
3.45 GHz Service (ANT 2)		5G NR 20 MHz	-0.226	0.103
		5G NR 40 MHz	0.150	-0.113
		5G NR 60 MHz	-0.034	0.071
		5G NR 80 MHz	-0.026	-0.045
		5G NR 100 MHz	-0.116	-0.112

Note: Change in input-output OBW is less than $\pm 5\%$.



Plot data of Occupied Bandwidth

Output / 3.7 GHz Service (ANT1) / Downlink / 5G NR 20 MHz

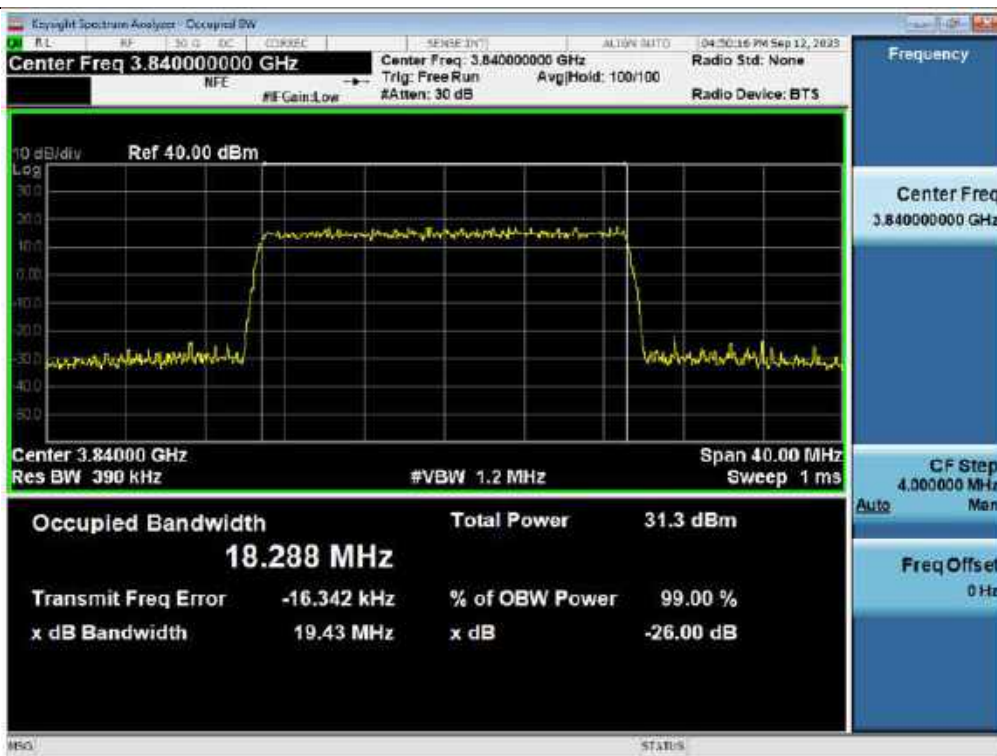

Input / 3.7 GHz Service (ANT1) / Downlink / 5G NR 20 MHz

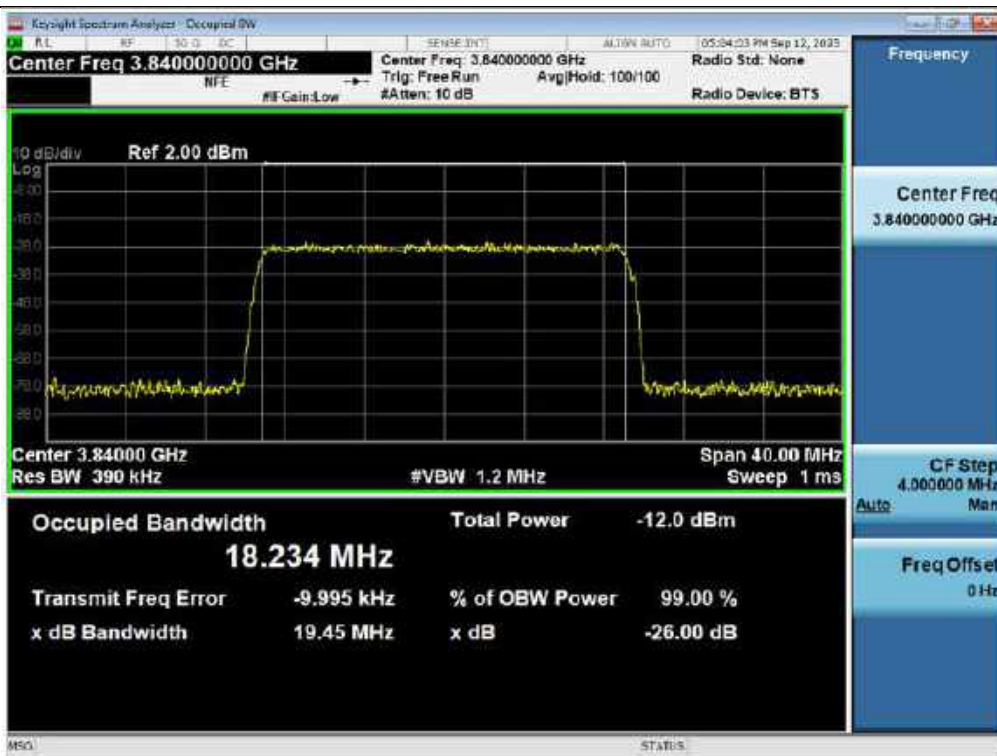

3 dB above the AGC threshold output / 3.7 GHz Service (ANT1) / Downlink / 5G NR 20 MHz

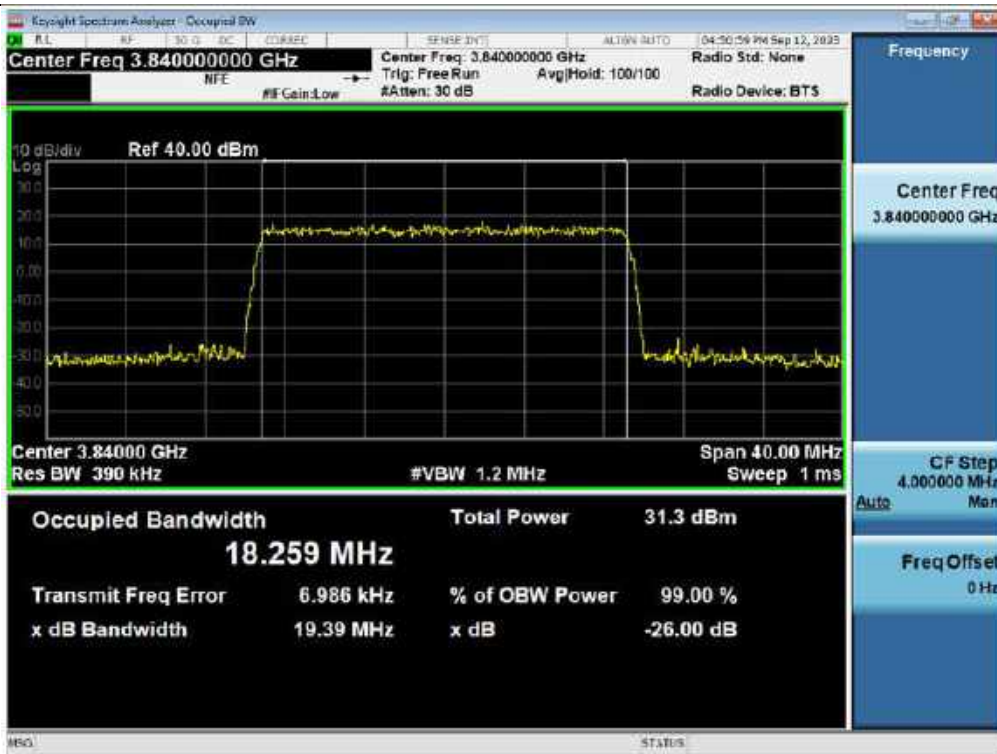

3 dB above the AGC threshold Input / 3.7 GHz Service (ANT1) / Downlink / 5G NR 20 MHz

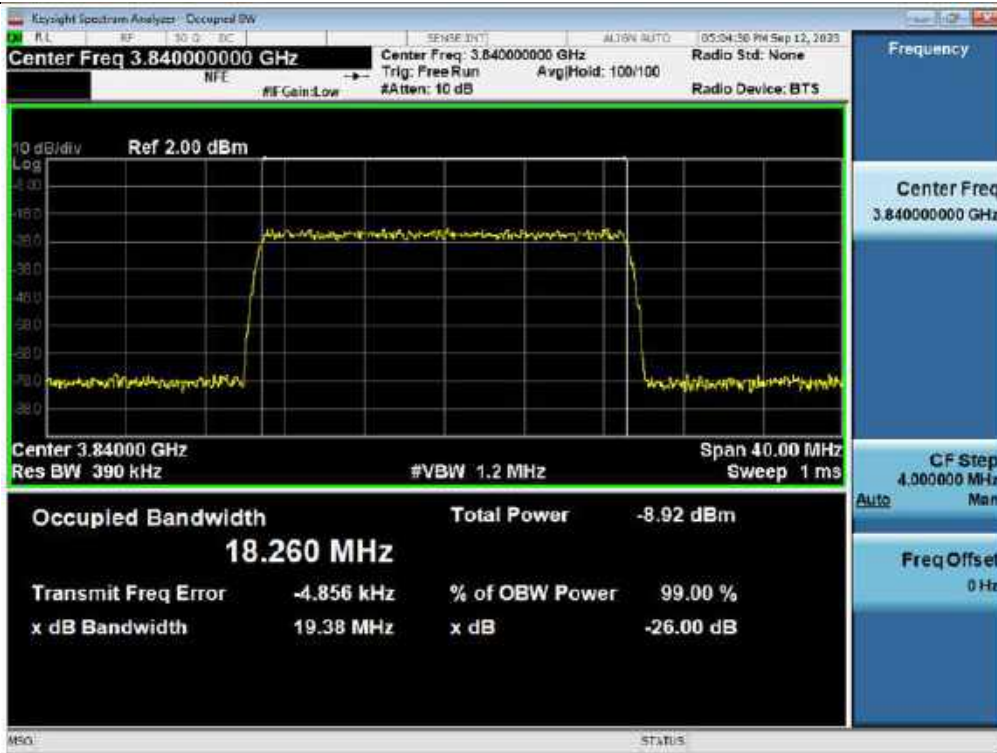

Output / 3.7 GHz Service (ANT1) / Downlink / 5G NR 40 MHz

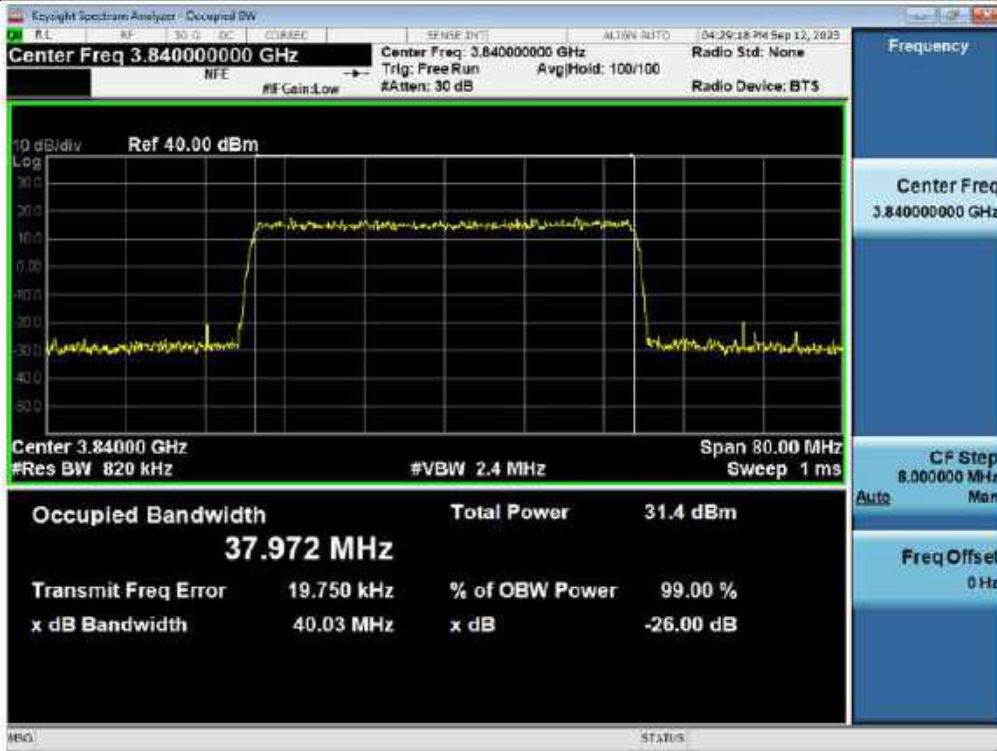

Input / 3.7 GHz Service (ANT1) / Downlink / 5G NR 40 MHz

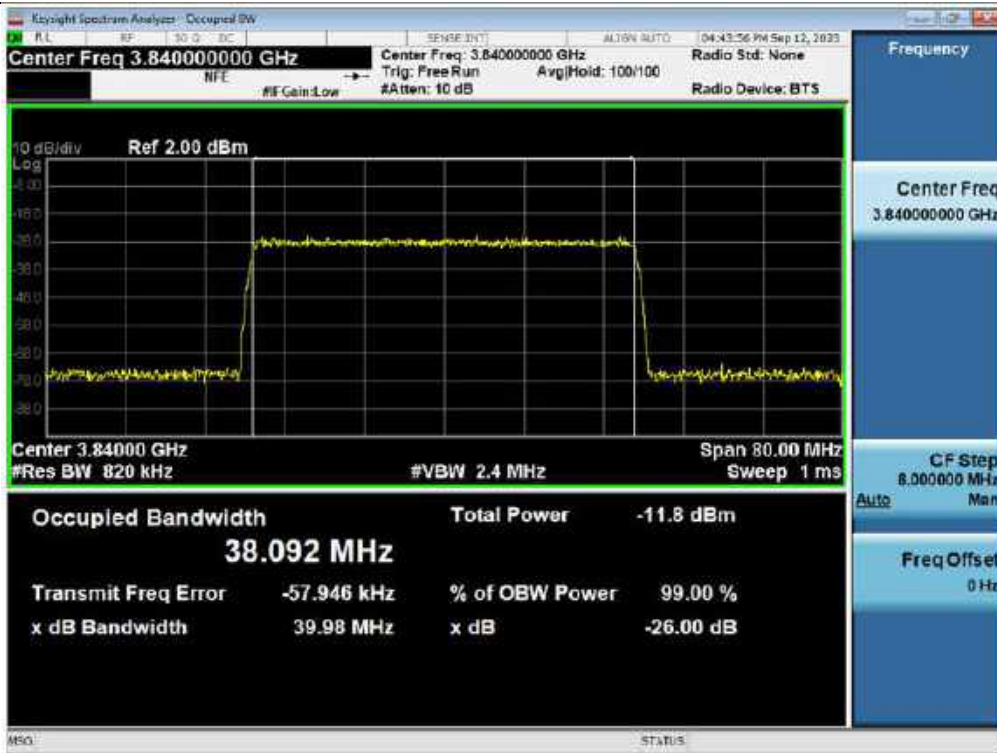

3 dB above the AGC threshold output / 3.7 GHz Service (ANT1) / Downlink / 5G NR 40 MHz

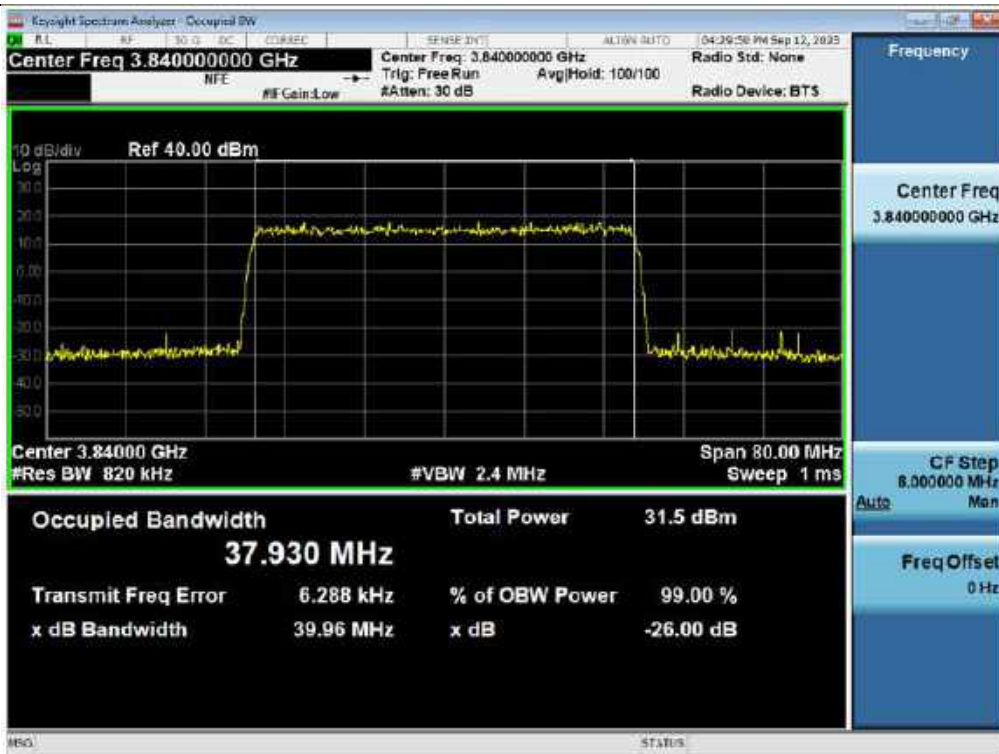

3 dB above the AGC threshold Input / 3.7 GHz Service (ANT1) / Downlink / 5G NR 40 MHz

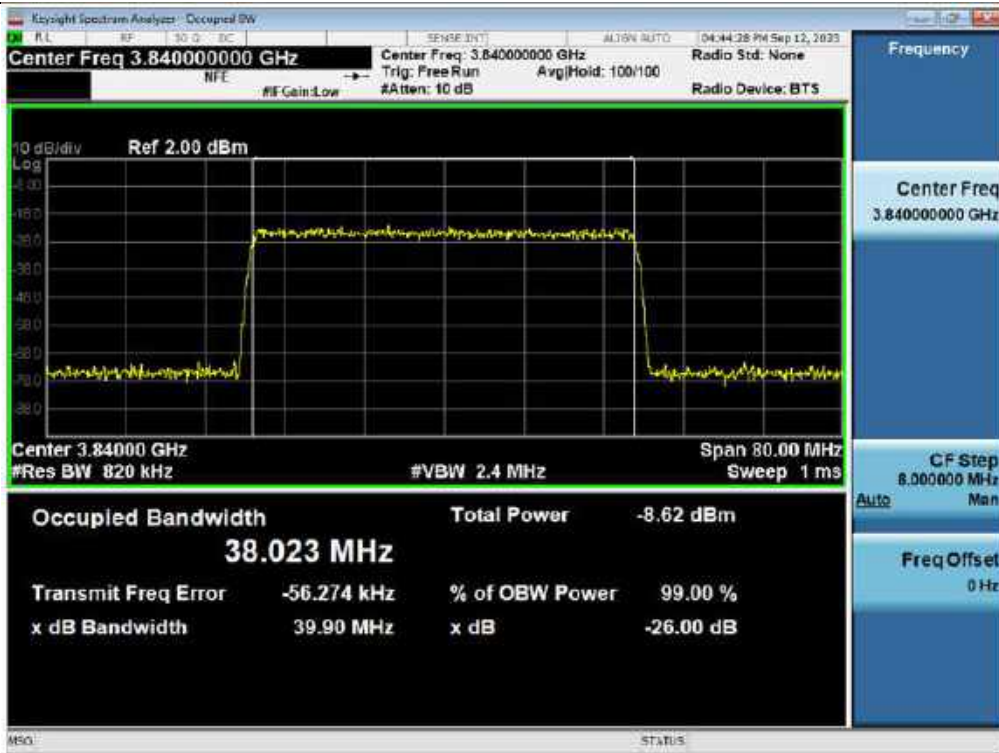

Output / 3.7 GHz Service (ANT1) / Downlink / 5G NR 60 MHz

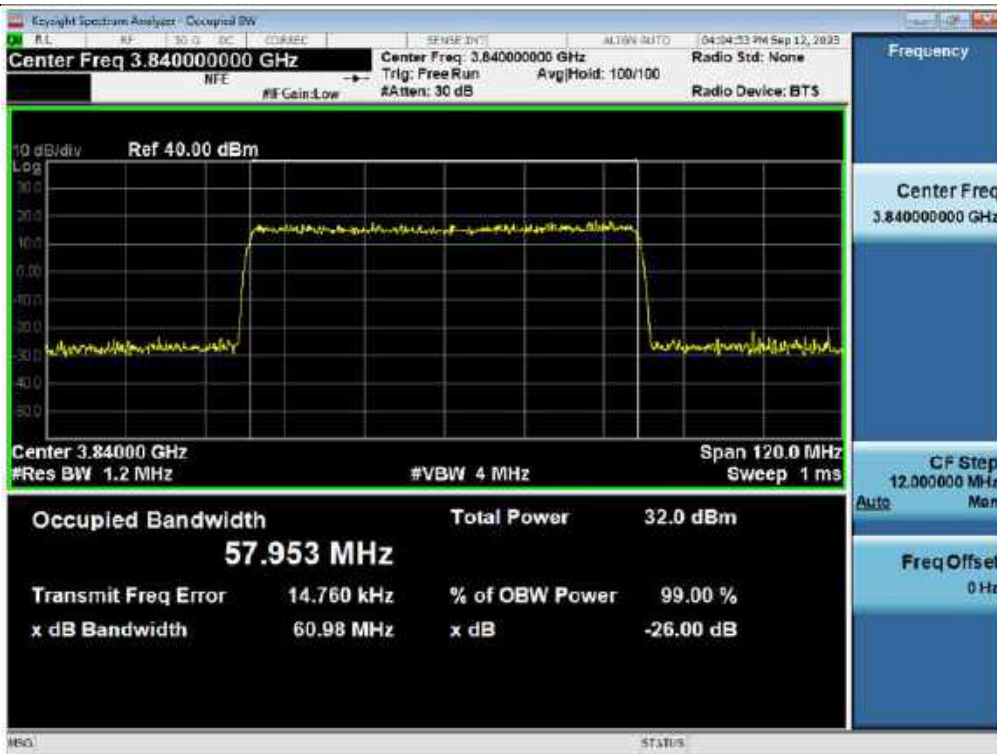

Input / 3.7 GHz Service (ANT1) / Downlink / 5G NR 60 MHz

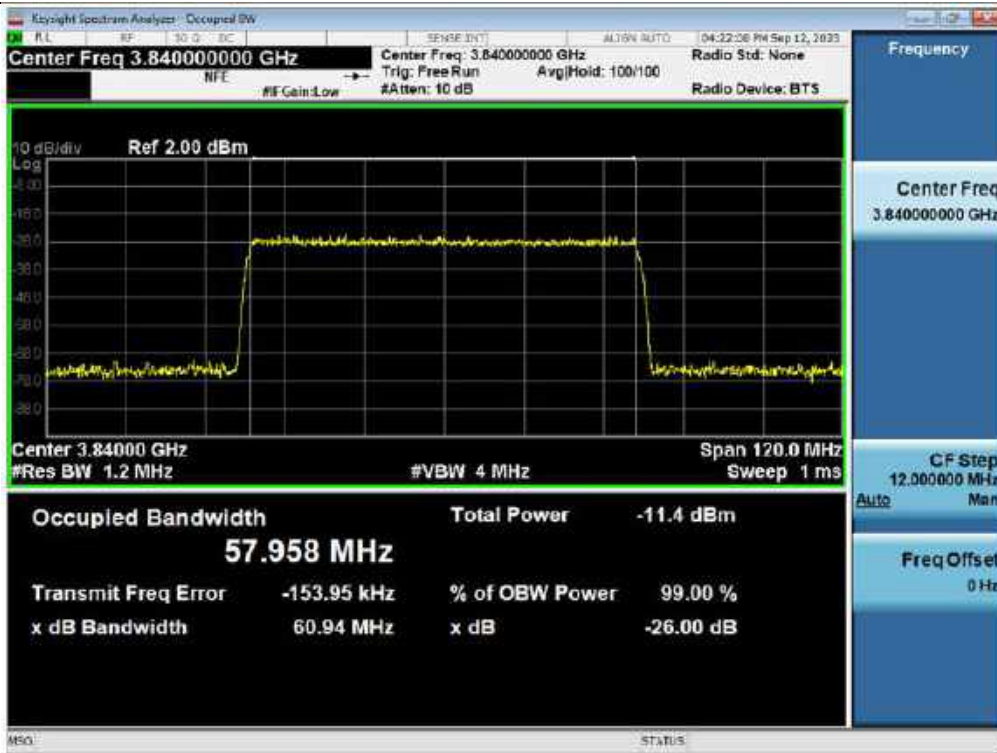

3 dB above the AGC threshold output / 3.7 GHz Service (ANT1) / Downlink / 5G NR 60 MHz

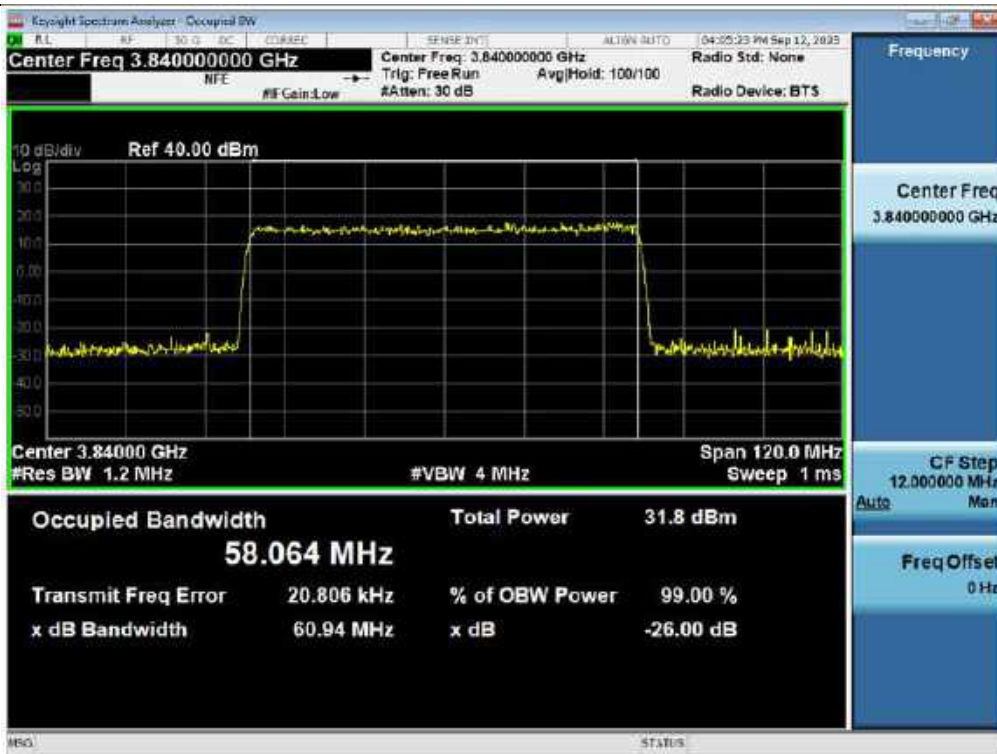

3 dB above the AGC threshold Input / 3.7 GHz Service (ANT1) / Downlink / 5G NR 60 MHz

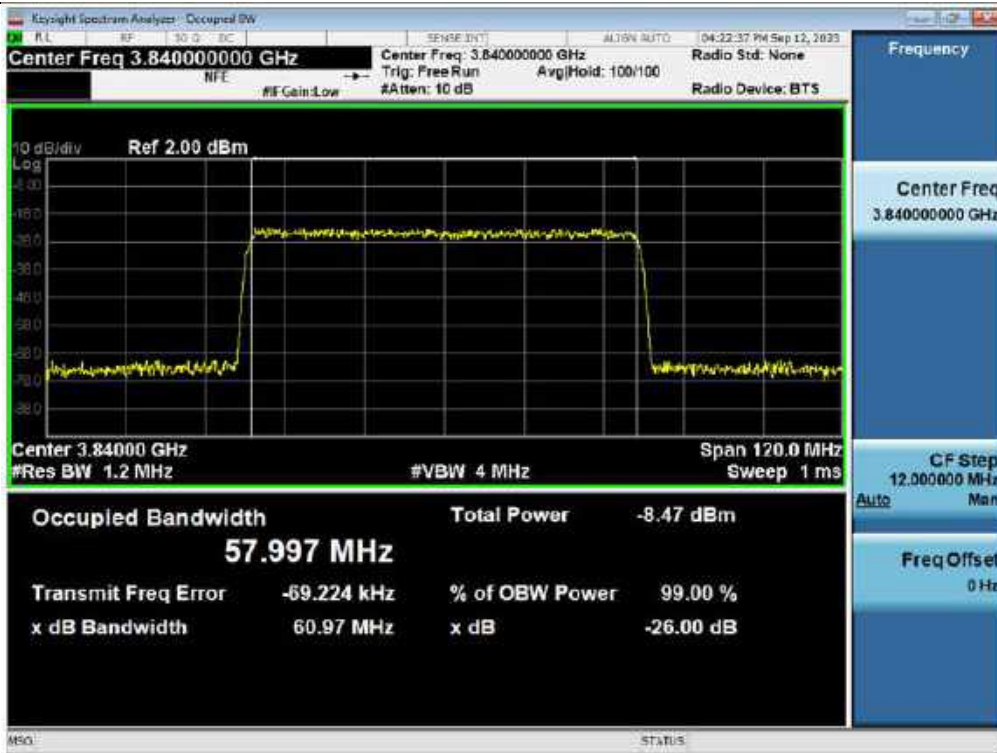



Output / 3.7 GHz Service (ANT1) / Downlink / 5G NR 80 MHz

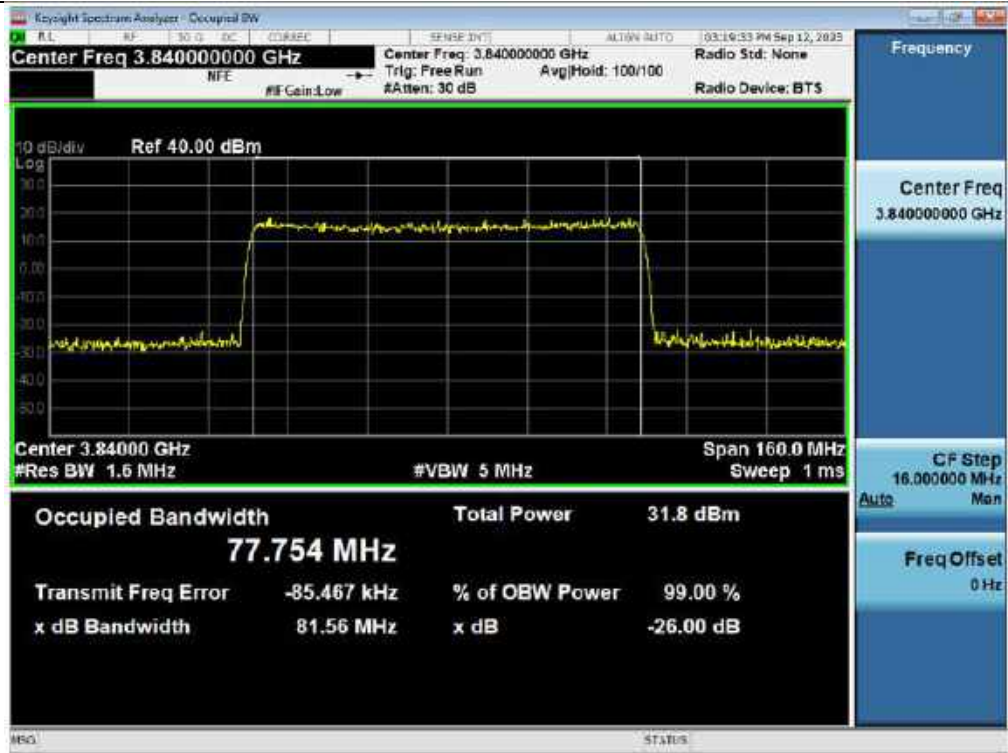

Input / 3.7 GHz Service (ANT1) / Downlink / 5G NR 80 MHz



3 dB above the AGC threshold output / 3.7 GHz Service (ANT1) / Downlink / 5G NR 80 MHz



3 dB above the AGC threshold Input / 3.7 GHz Service (ANT1) / Downlink / 5G NR 80 MHz

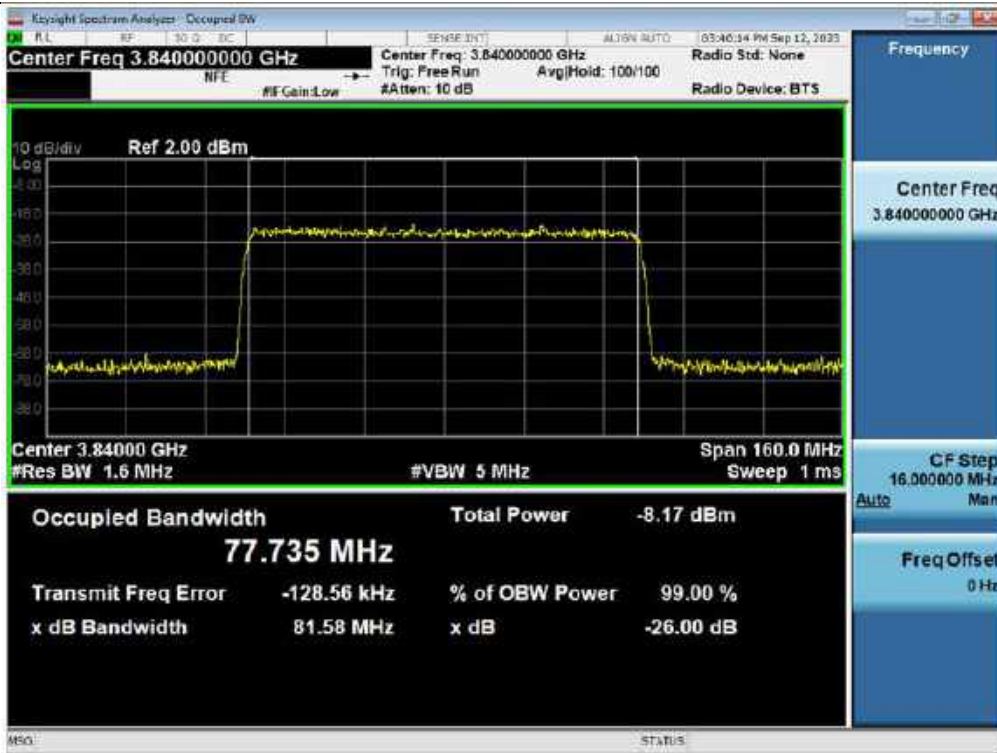

Output / 3.7 GHz Service (ANT1) / Downlink / 5G NR 100 MHz



Input / 3.7 GHz Service (ANT1) / Downlink / 5G NR 100 MHz

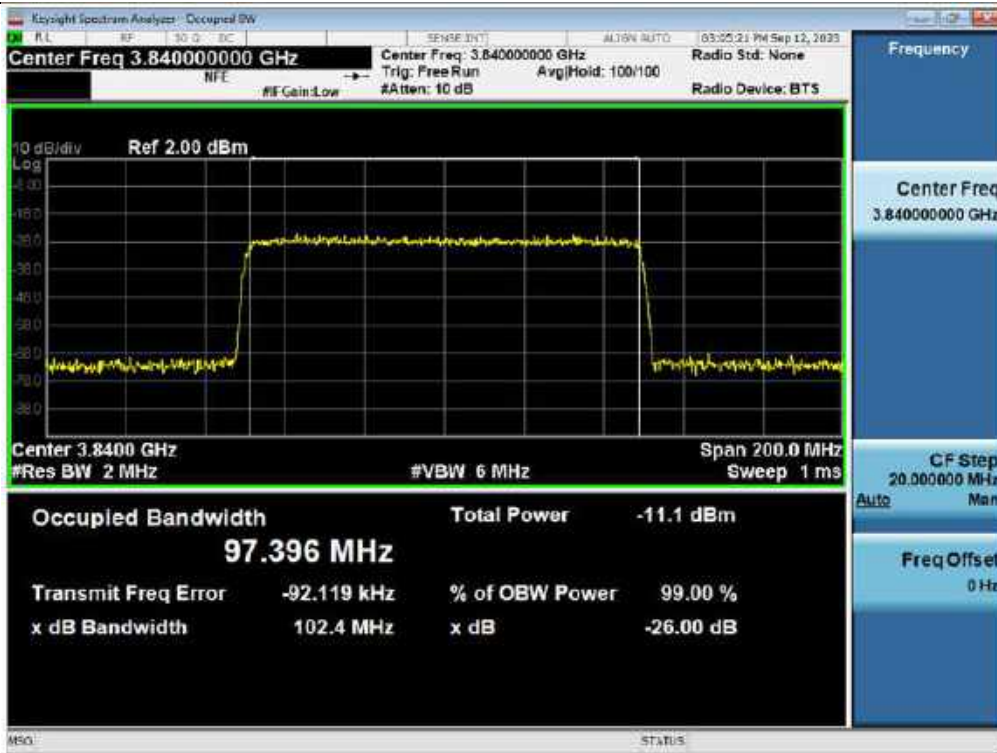

3 dB above the AGC threshold output / 3.7 GHz Service (ANT1) / Downlink / 5G NR 100 MHz

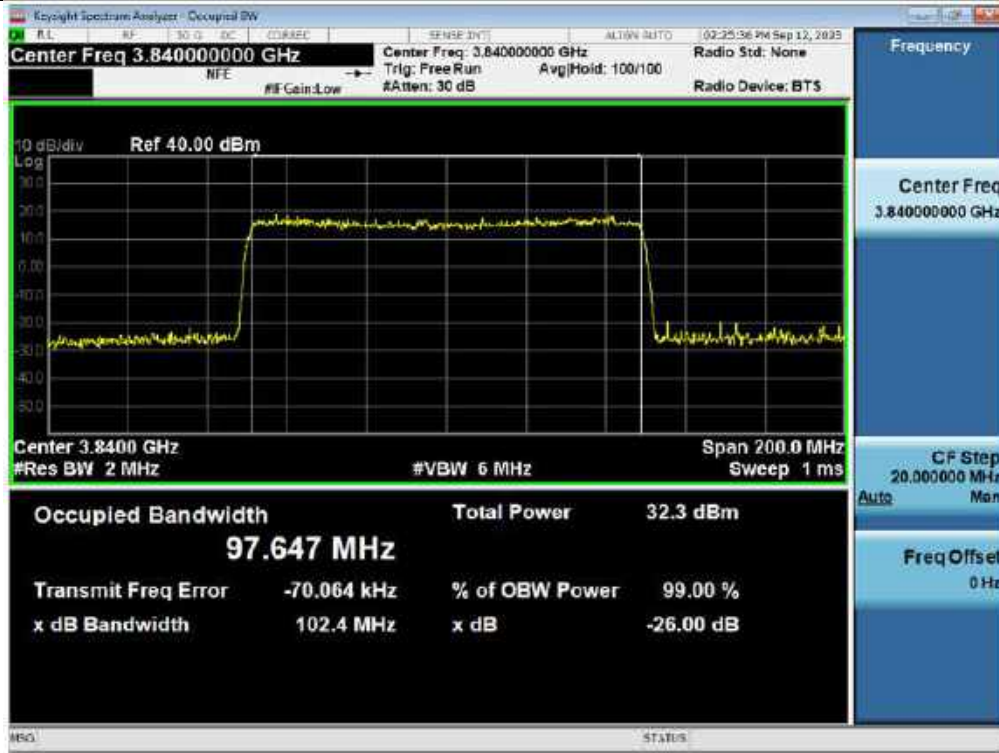

3 dB above the AGC threshold Input / 3.7 GHz Service (ANT1) / Downlink / 5G NR 100 MHz



Output / 3.45 GHz Service (ANT1) / Downlink / 5G NR 20 MHz

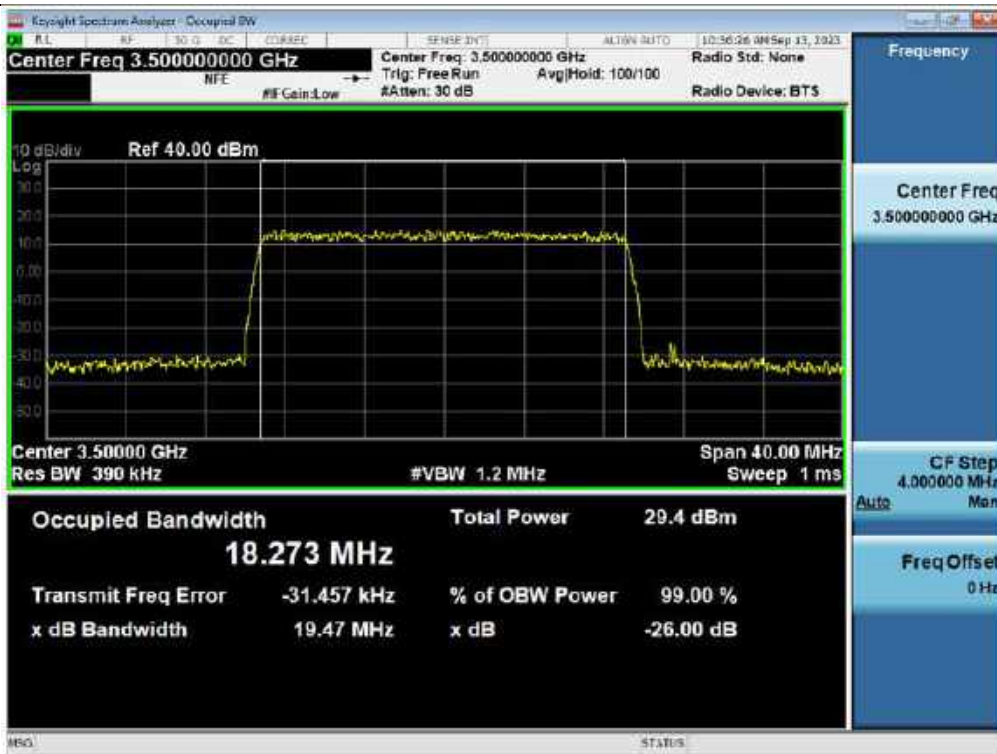

Input / 3.45 GHz Service (ANT1) / Downlink / 5G NR 20 MHz

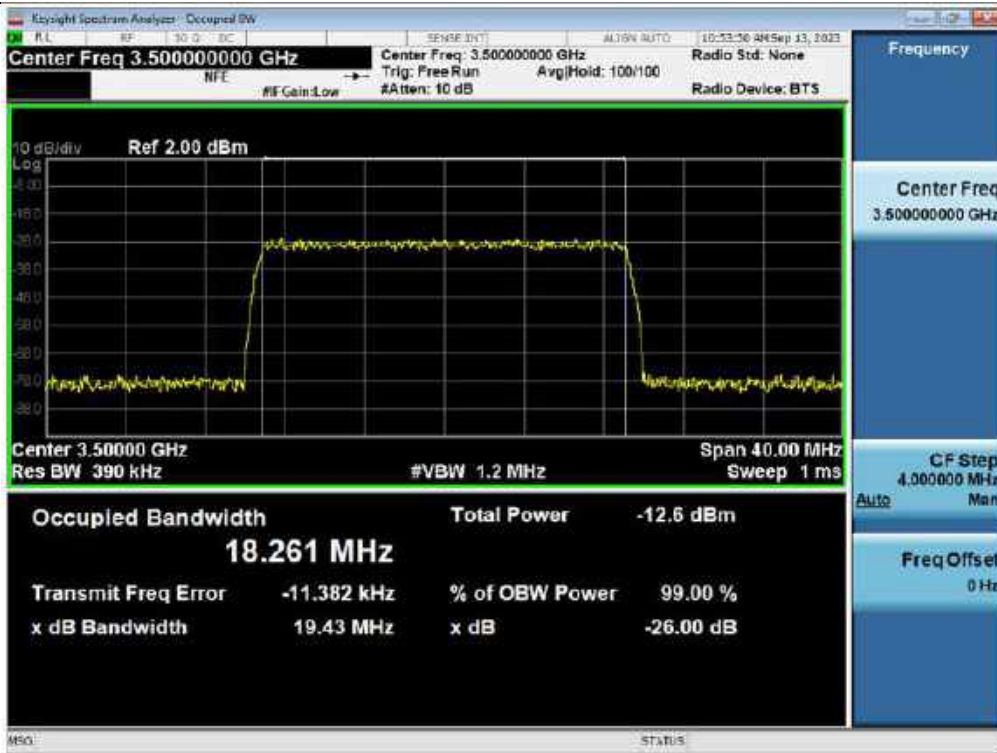

3 dB above the AGC threshold output / 3.45 GHz Service (ANT1) / Downlink / 5G NR 20 MHz

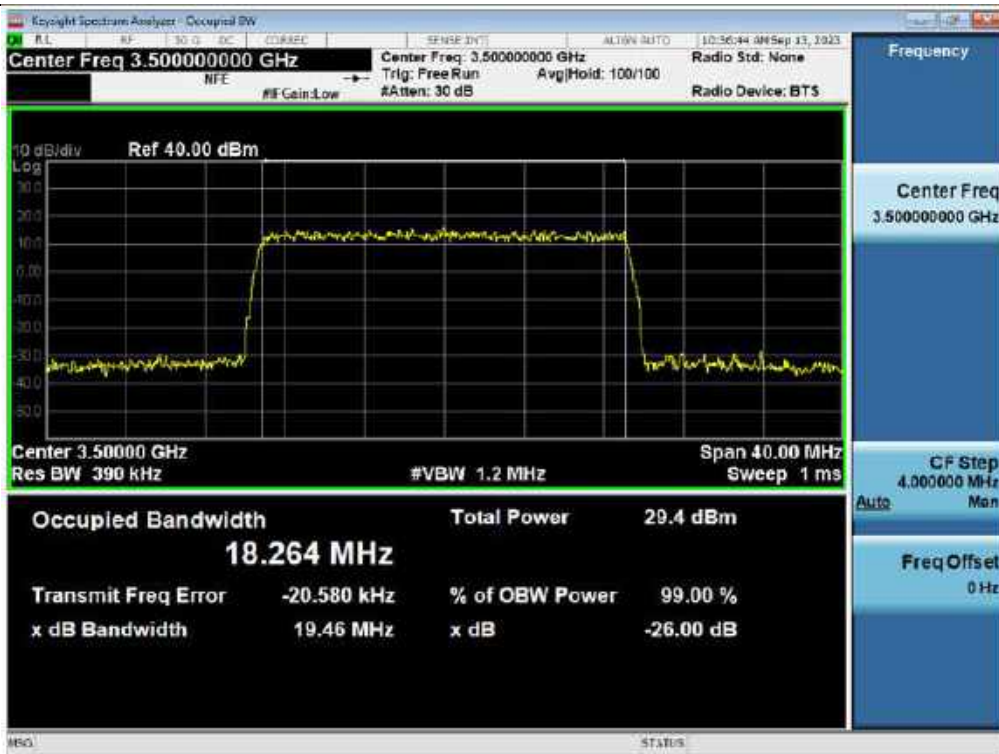

3 dB above the AGC threshold Input / 3.45 GHz Service (ANT1) / Downlink / 5G NR 20 MHz

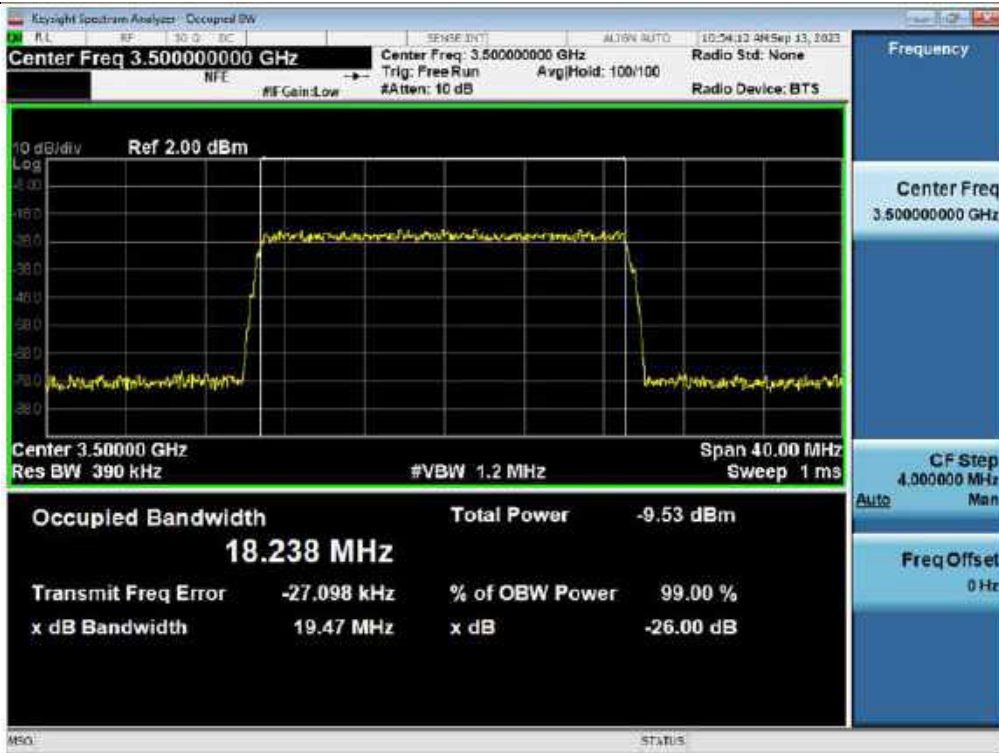

Output / 3.45 GHz Service (ANT1) / Downlink / 5G NR 40 MHz



Input / 3.45 GHz Service (ANT1) / Downlink / 5G NR 40 MHz

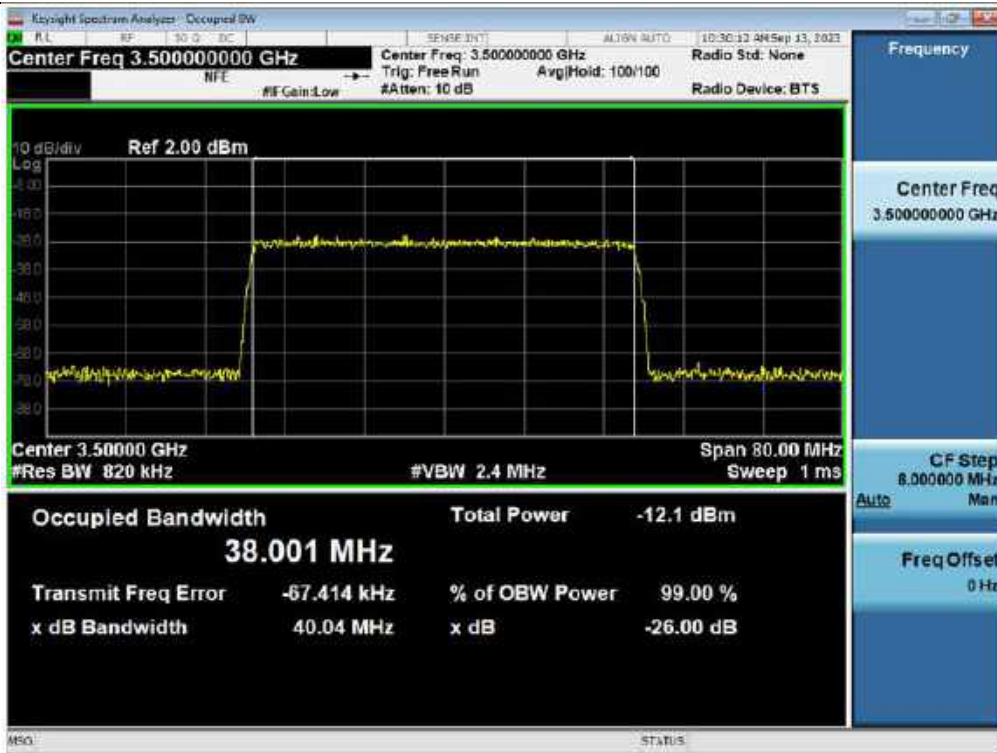

3 dB above the AGC threshold output / 3.45 GHz Service (ANT1) / Downlink / 5G NR 40 MHz



3 dB above the AGC threshold Input / 3.45 GHz Service (ANT1) / Downlink / 5G NR 40 MHz

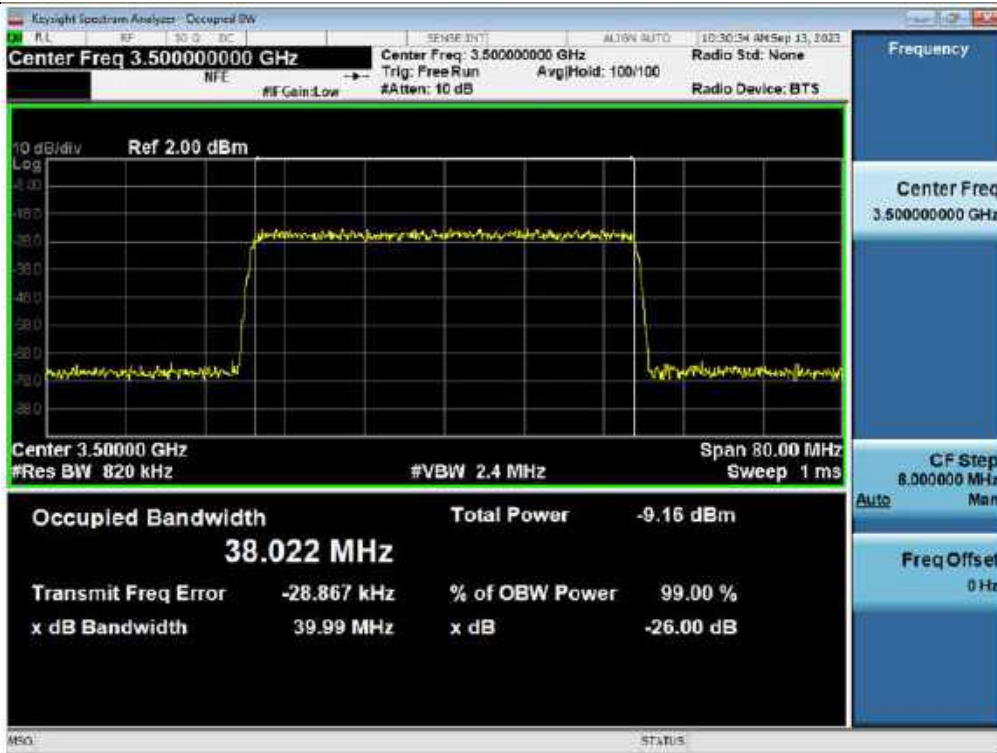

Output / 3.45 GHz Service (ANT1) / Downlink / 5G NR 60 MHz



Input / 3.45 GHz Service (ANT1) / Downlink / 5G NR 60 MHz



3 dB above the AGC threshold output / 3.45 GHz Service (ANT1) / Downlink / 5G NR 60 MHz



3 dB above the AGC threshold Input / 3.45 GHz Service (ANT1) / Downlink / 5G NR 60 MHz

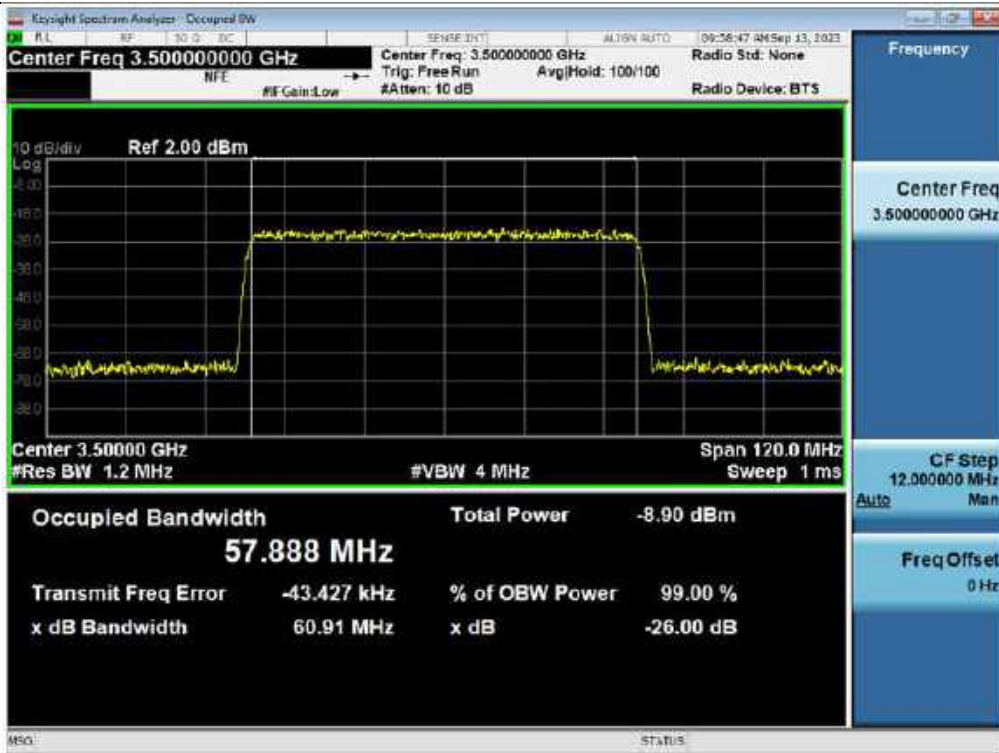

Output / 3.45 GHz Service (ANT1) / Downlink / 5G NR 80 MHz



Input / 3.45 GHz Service (ANT1) / Downlink / 5G NR 80 MHz

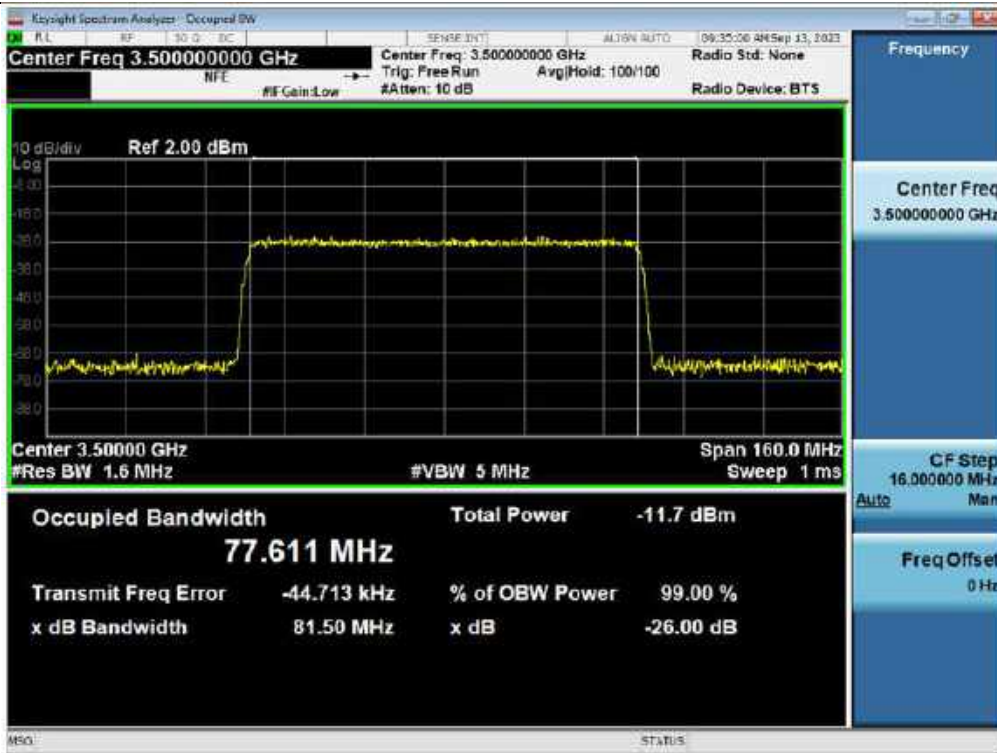

3 dB above the AGC threshold output / 3.45 GHz Service (ANT1) / Downlink / 5G NR 80 MHz



3 dB above the AGC threshold Input / 3.45 GHz Service (ANT1) / Downlink / 5G NR 80 MHz

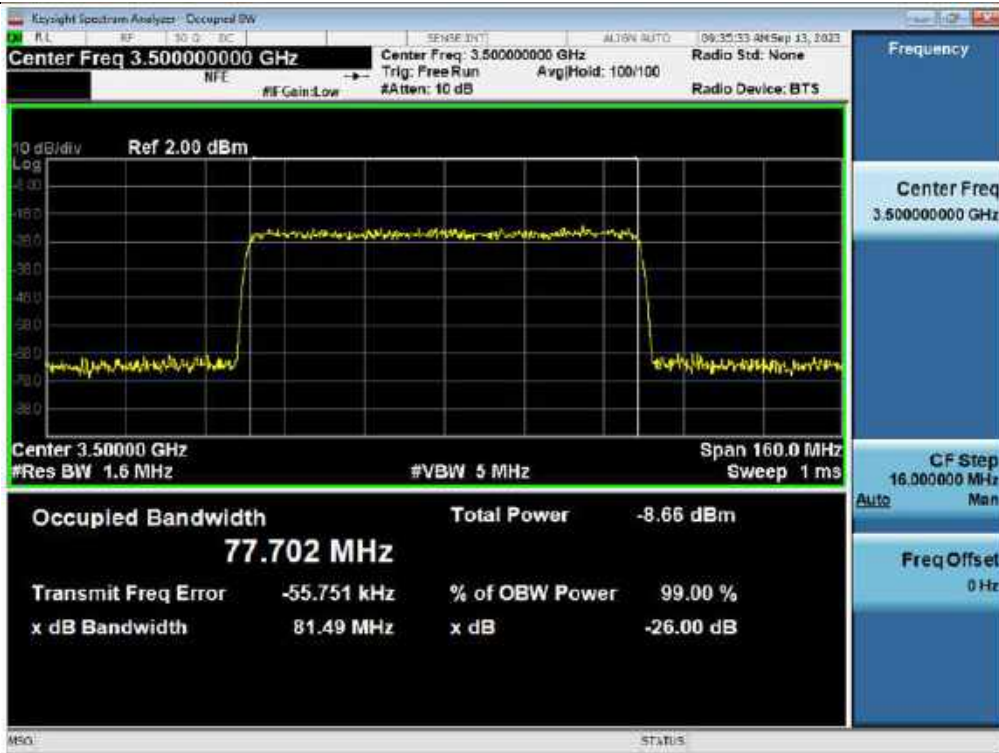

Output / 3.45 GHz Service (ANT1) / Downlink / 5G NR 100 MHz



Input / 3.45 GHz Service (ANT1) / Downlink / 5G NR 100 MHz

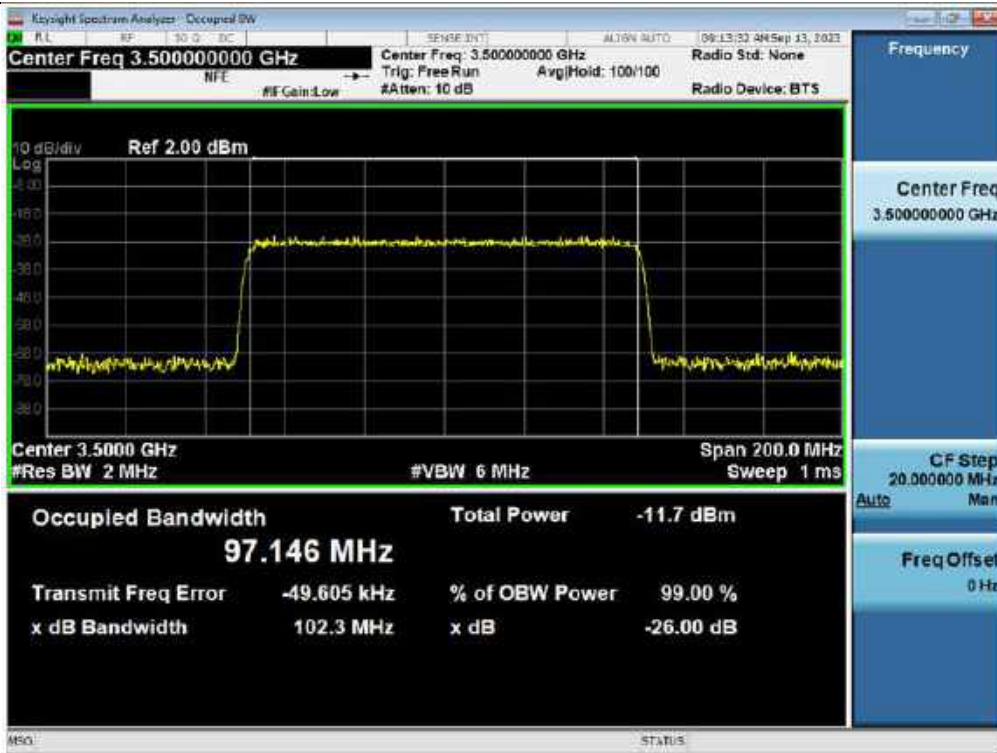

3 dB above the AGC threshold output / 3.45 GHz Service (ANT1) / Downlink / 5G NR 100 MHz



3 dB above the AGC threshold Input / 3.45 GHz Service (ANT1) / Downlink / 5G NR 100 MHz

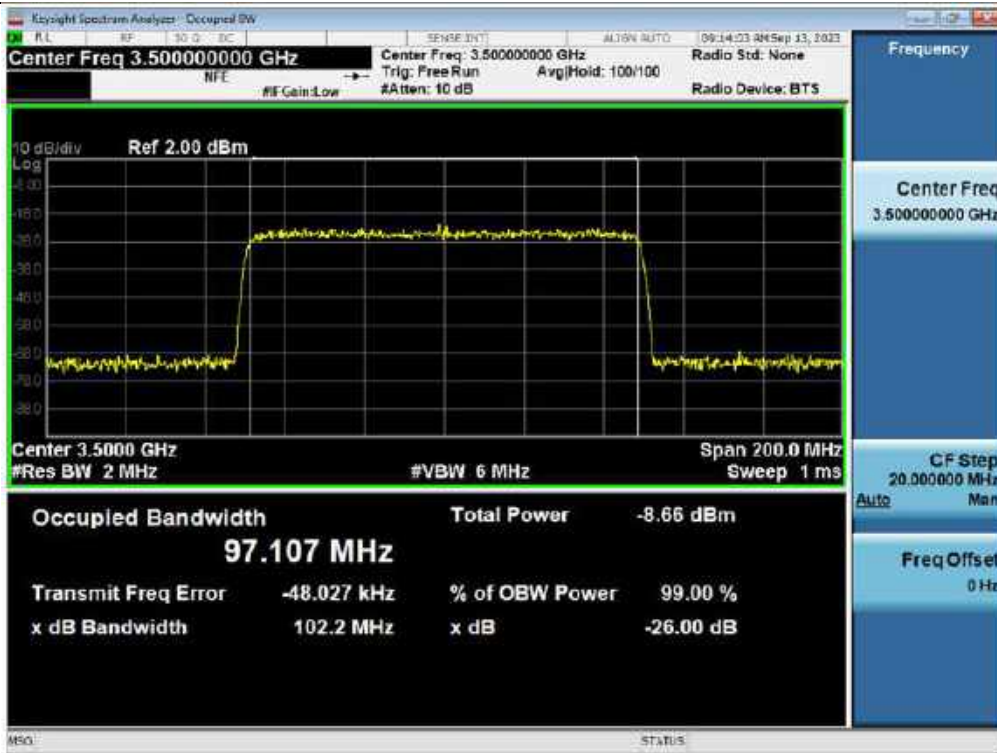

Output / 3.7 GHz Service (ANT 2) / Downlink / 5G NR 20 MHz

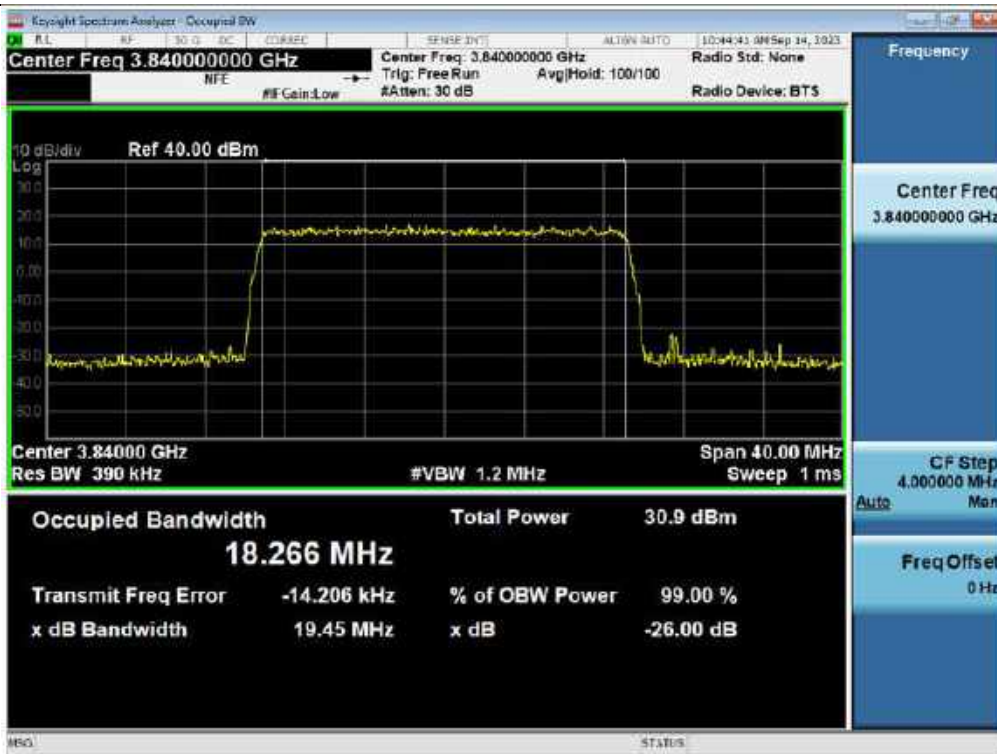

Input / 3.7 GHz Service (ANT 2) / Downlink / 5G NR 20 MHz

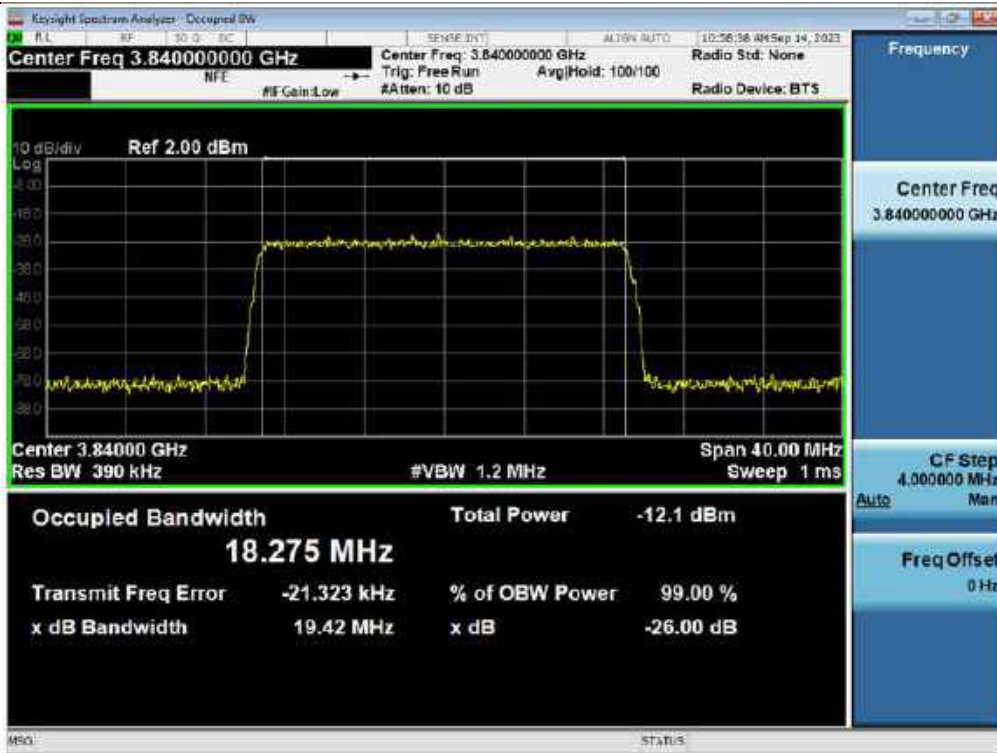

3 dB above the AGC threshold output / 3.7 GHz Service (ANT 2) / Downlink / 5G NR 20 MHz

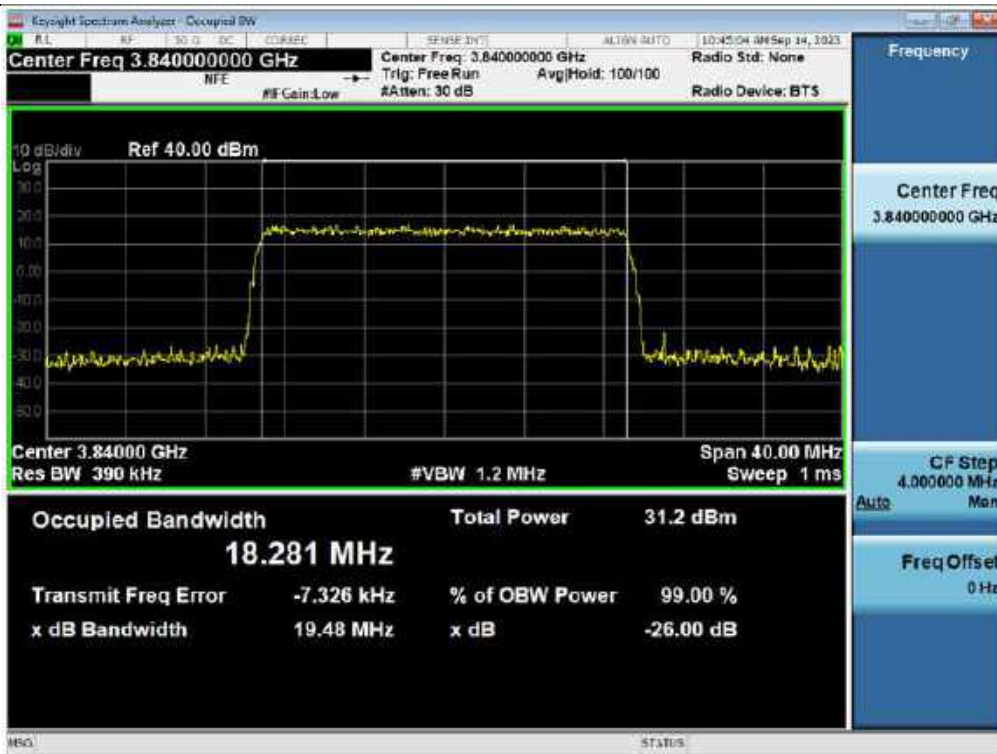

3 dB above the AGC threshold Input / 3.7 GHz Service (ANT 2) / Downlink / 5G NR 20 MHz

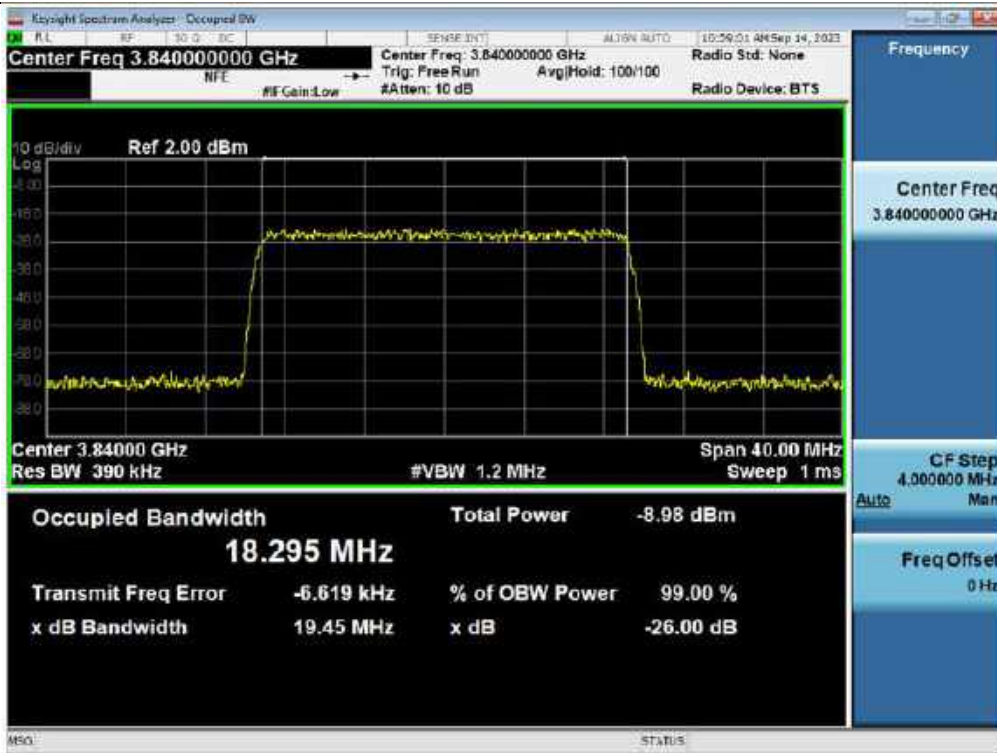

Output / 3.7 GHz Service (ANT 2) / Downlink / 5G NR 40 MHz

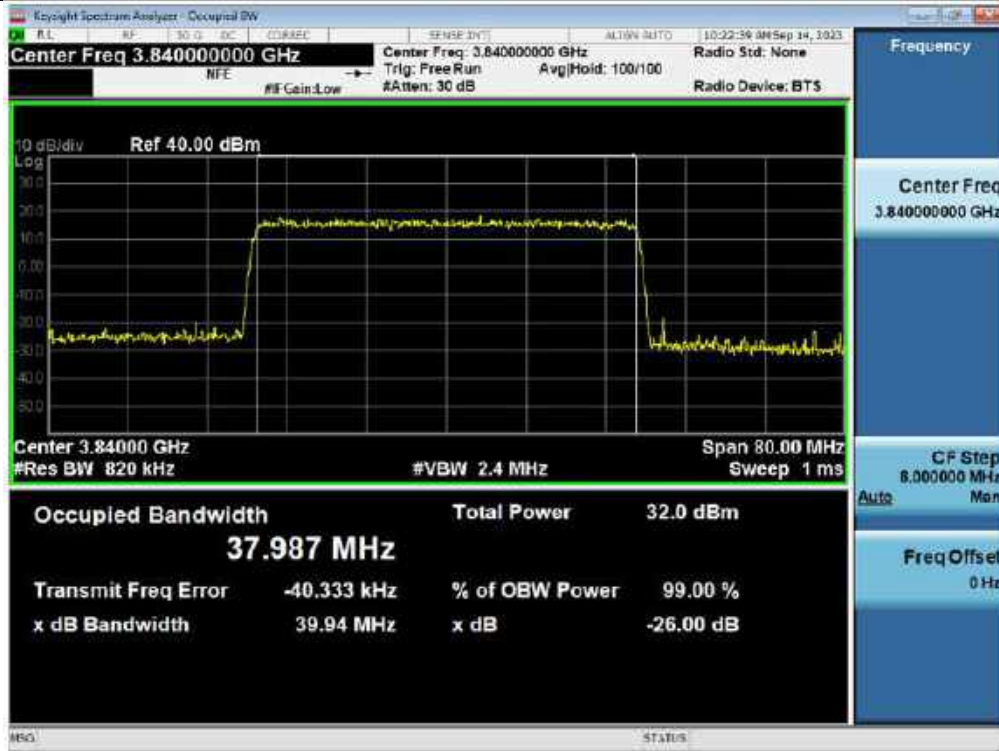

Input / 3.7 GHz Service (ANT 2) / Downlink / 5G NR 40 MHz

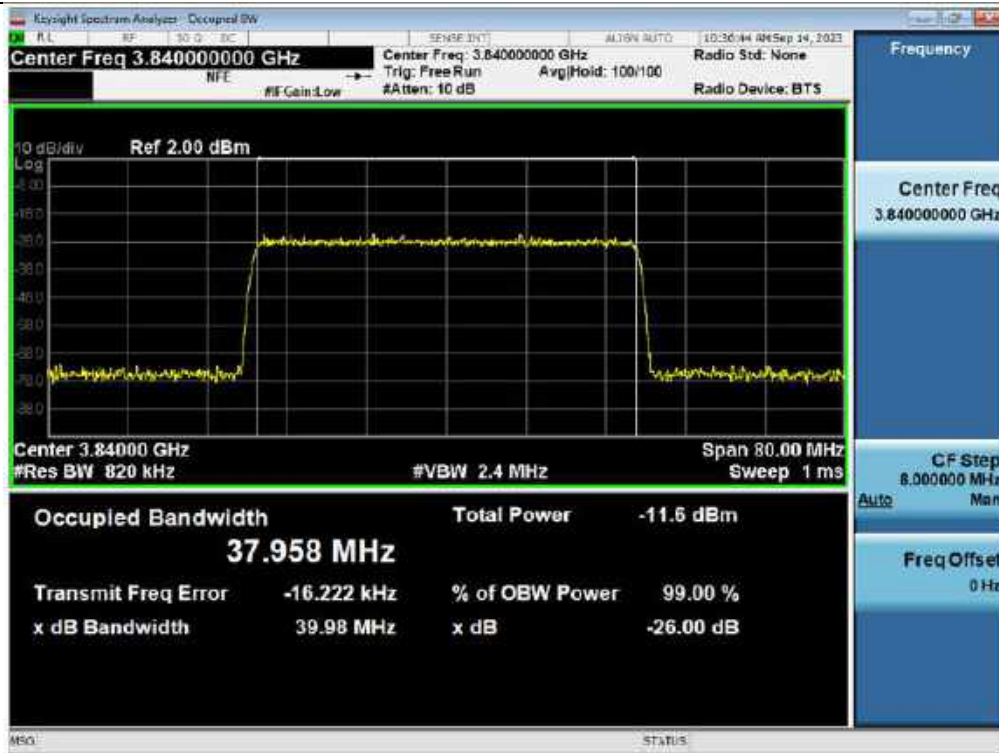

3 dB above the AGC threshold output / 3.7 GHz Service (ANT 2) / Downlink / 5G NR 40 MHz

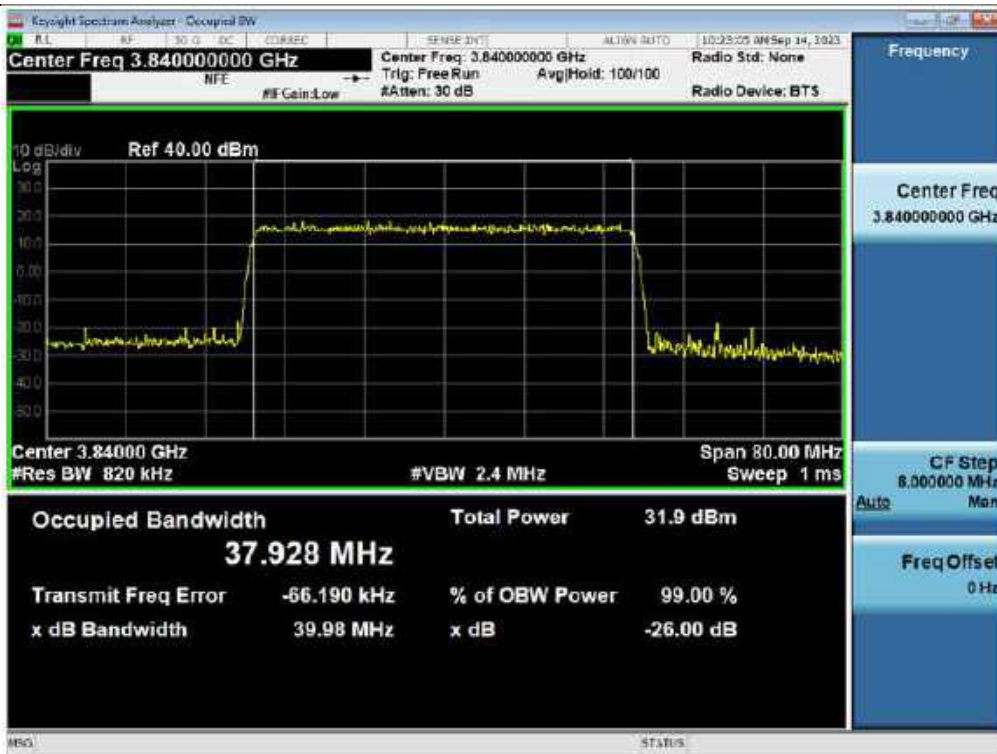

3 dB above the AGC threshold Input / 3.7 GHz Service (ANT 2) / Downlink / 5G NR 40 MHz

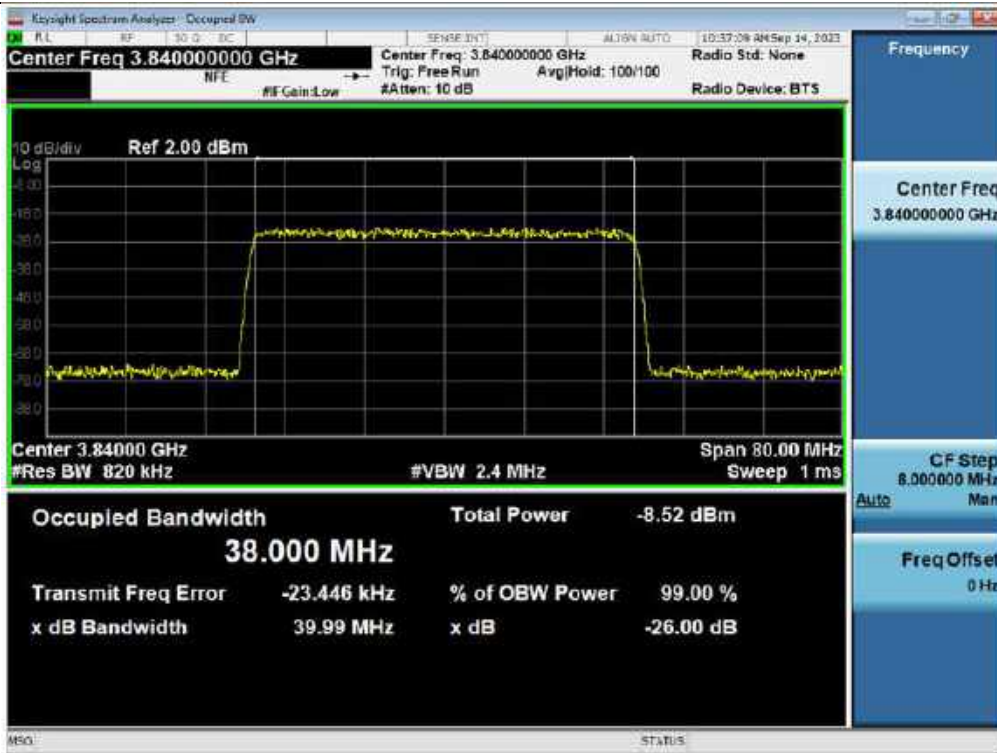

Output / 3.7 GHz Service (ANT 2) / Downlink / 5G NR 60 MHz

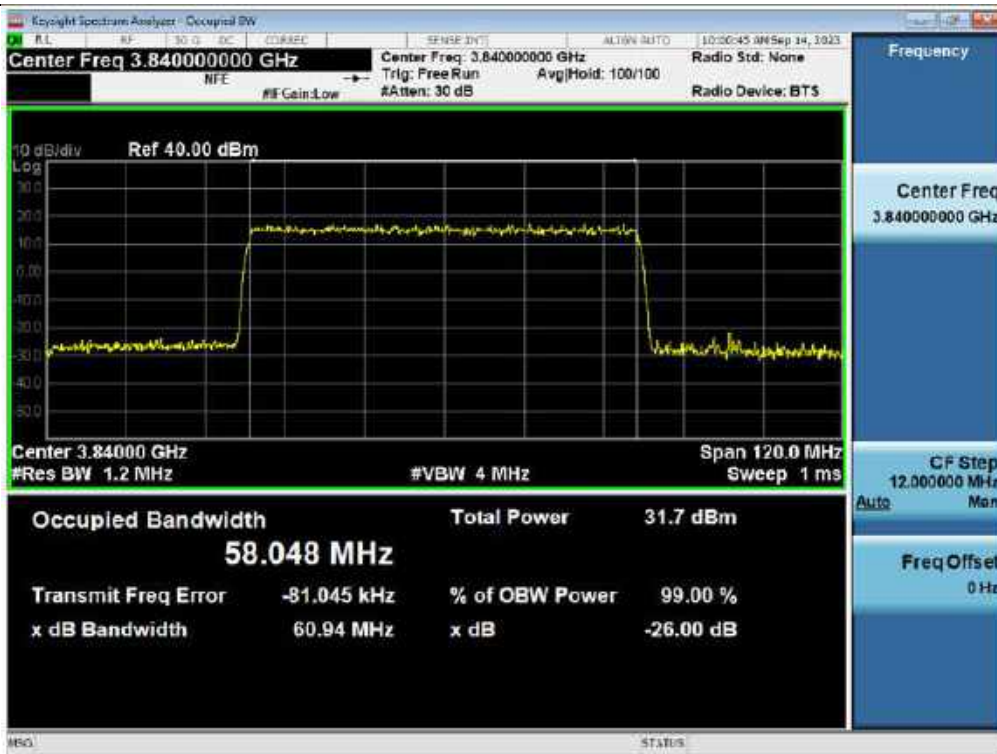

Input / 3.7 GHz Service (ANT 2) / Downlink / 5G NR 60 MHz

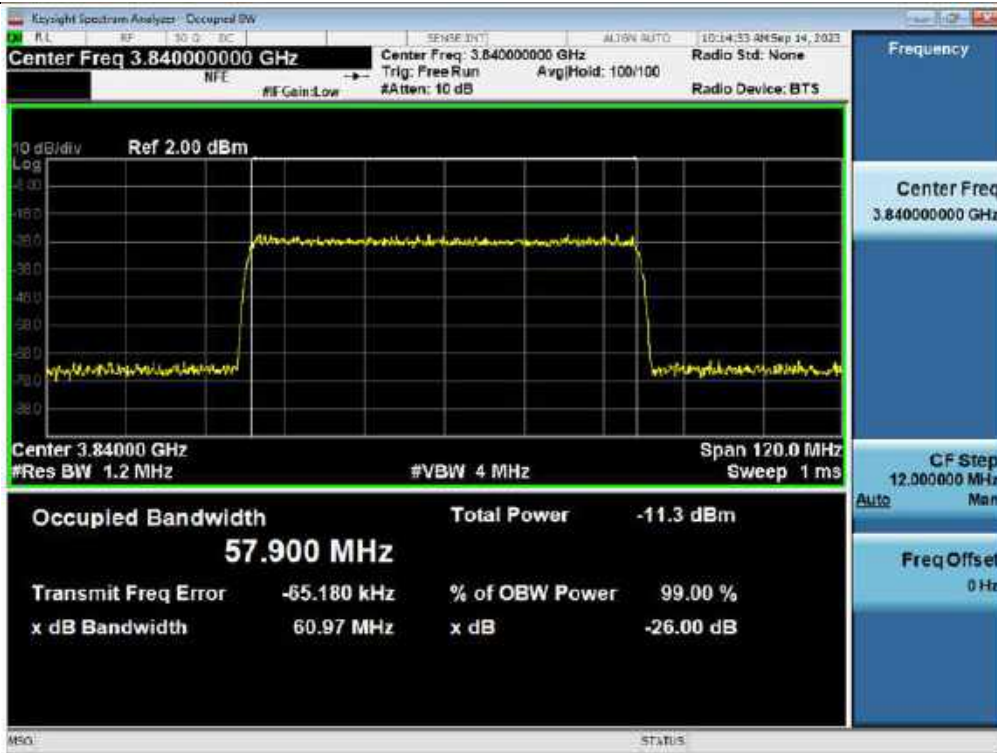

3 dB above the AGC threshold output / 3.7 GHz Service (ANT 2) / Downlink / 5G NR 60 MHz



3 dB above the AGC threshold Input / 3.7 GHz Service (ANT 2) / Downlink / 5G NR 60 MHz

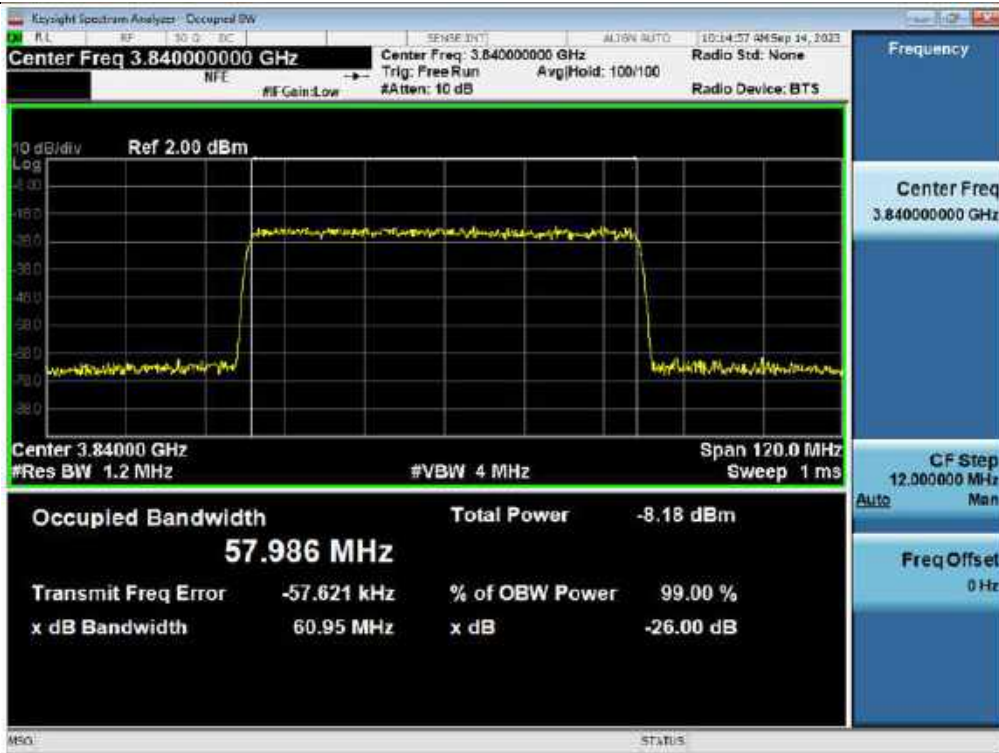

Output / 3.7 GHz Service (ANT 2) / Downlink / 5G NR 80 MHz



Input / 3.7 GHz Service (ANT 2) / Downlink / 5G NR 80 MHz

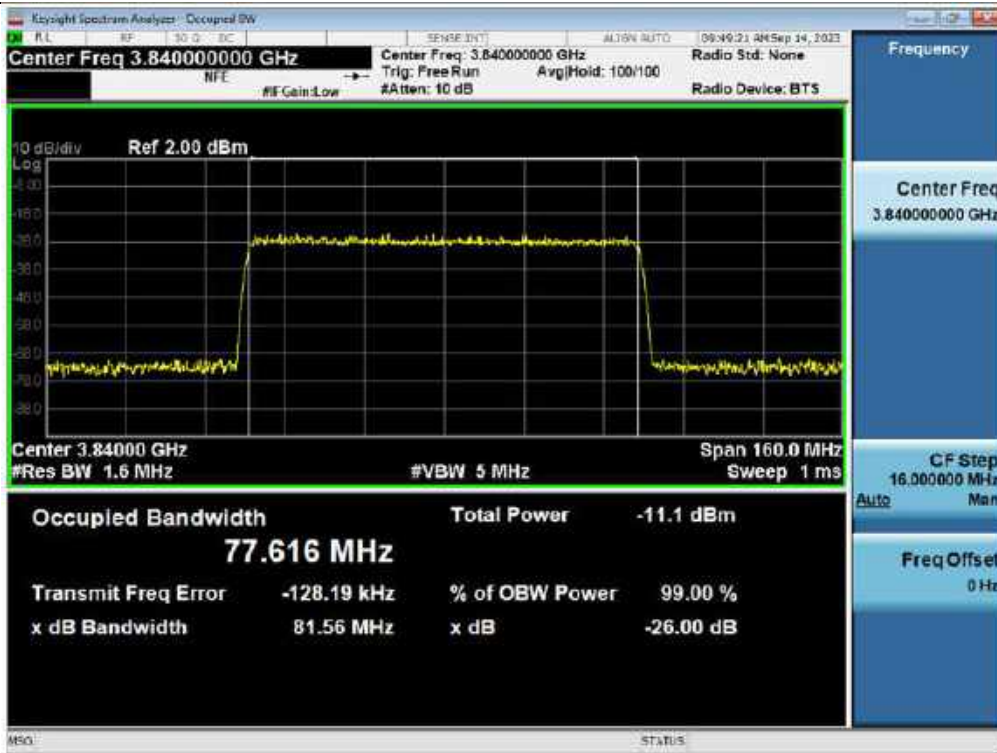

3 dB above the AGC threshold output / 3.7 GHz Service (ANT 2) / Downlink / 5G NR 80 MHz

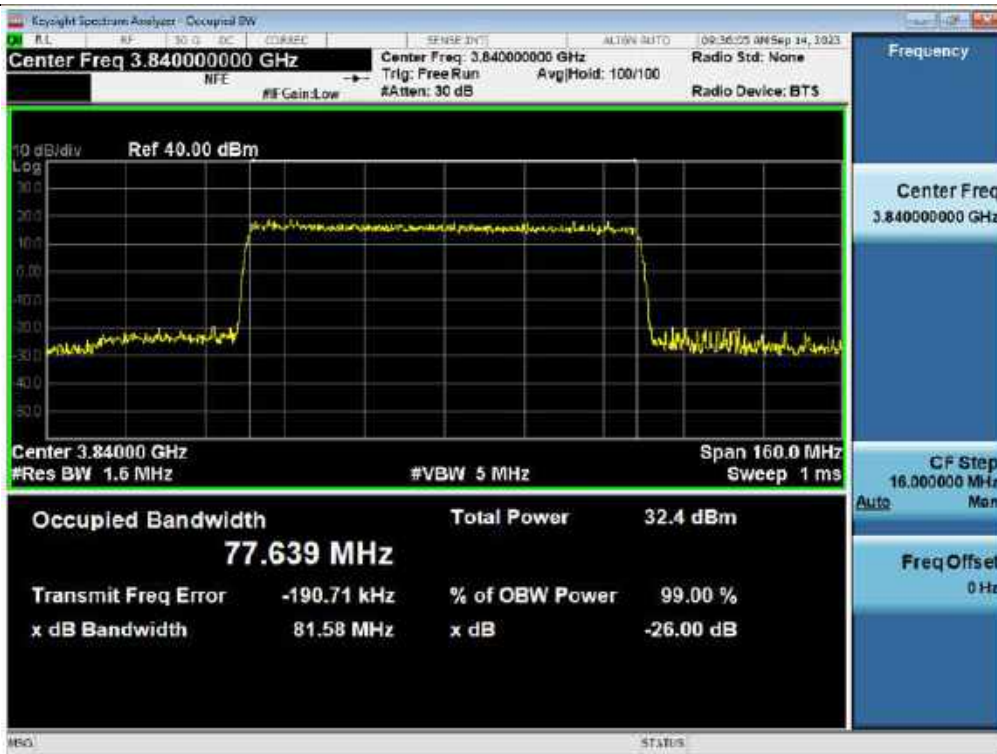

3 dB above the AGC threshold Input / 3.7 GHz Service (ANT 2) / Downlink / 5G NR 80 MHz

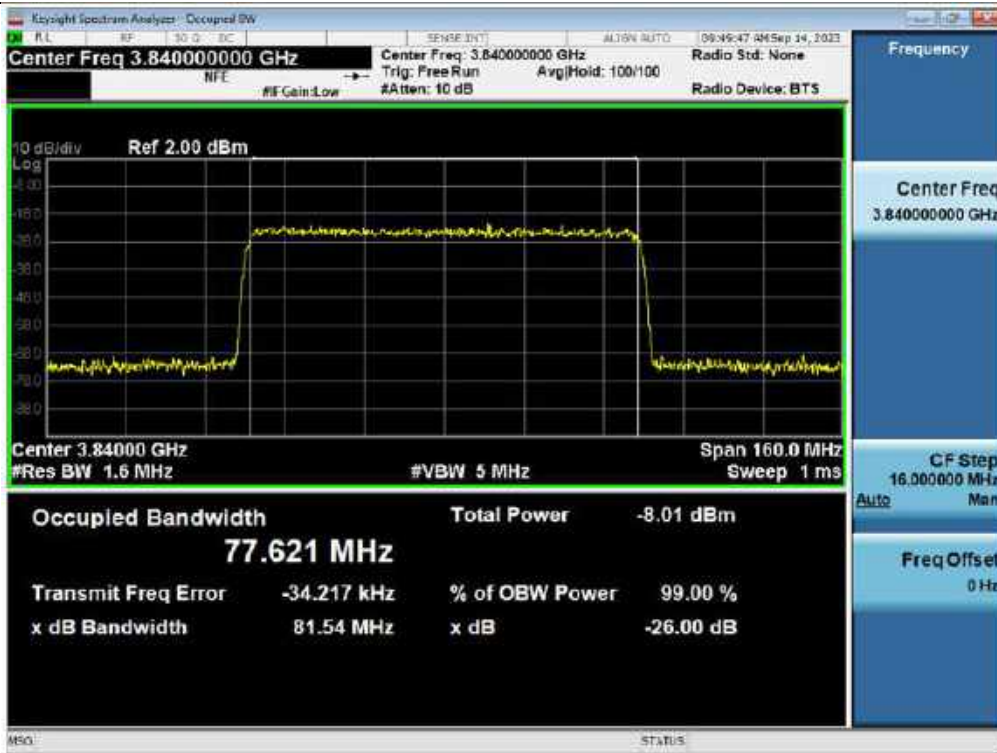

Output / 3.7 GHz Service (ANT 2) / Downlink / 5G NR 100 MHz



Input / 3.7 GHz Service (ANT 2) / Downlink / 5G NR 100 MHz

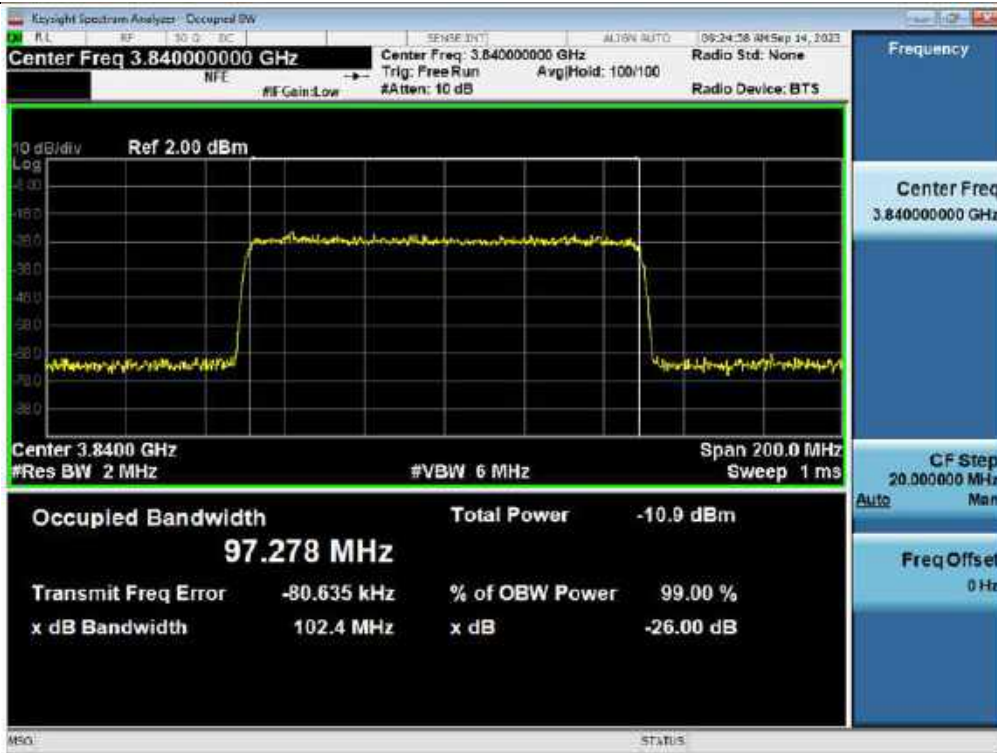

3 dB above the AGC threshold output / 3.7 GHz Service (ANT 2) / Downlink / 5G NR 100 MHz

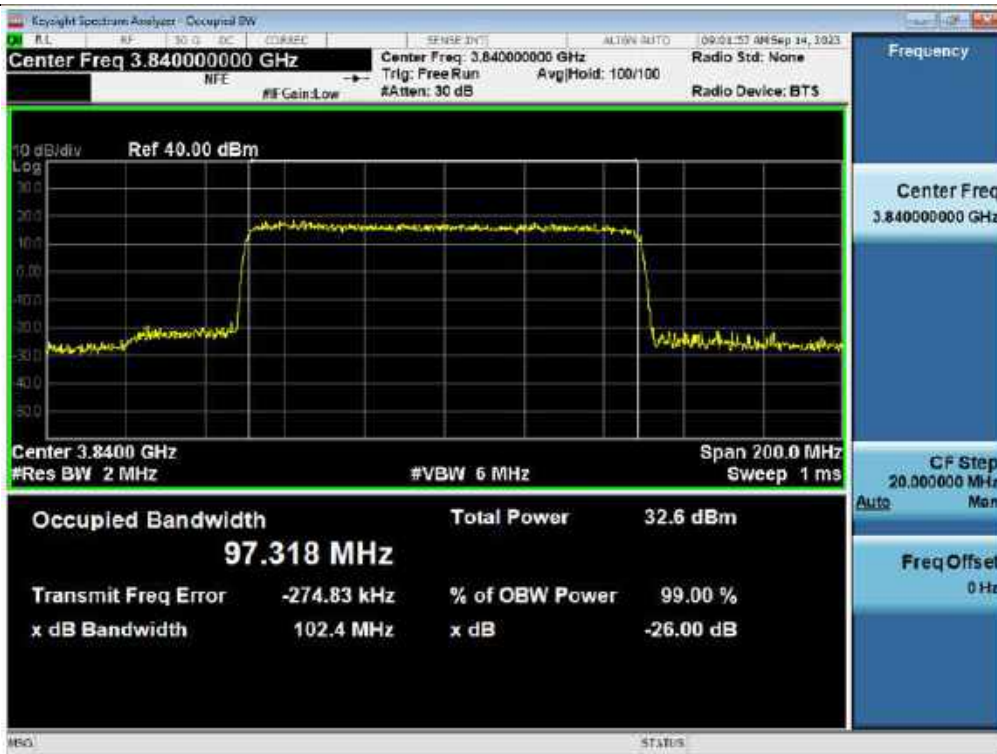

3 dB above the AGC threshold Input / 3.7 GHz Service (ANT 2) / Downlink / 5G NR 100 MHz

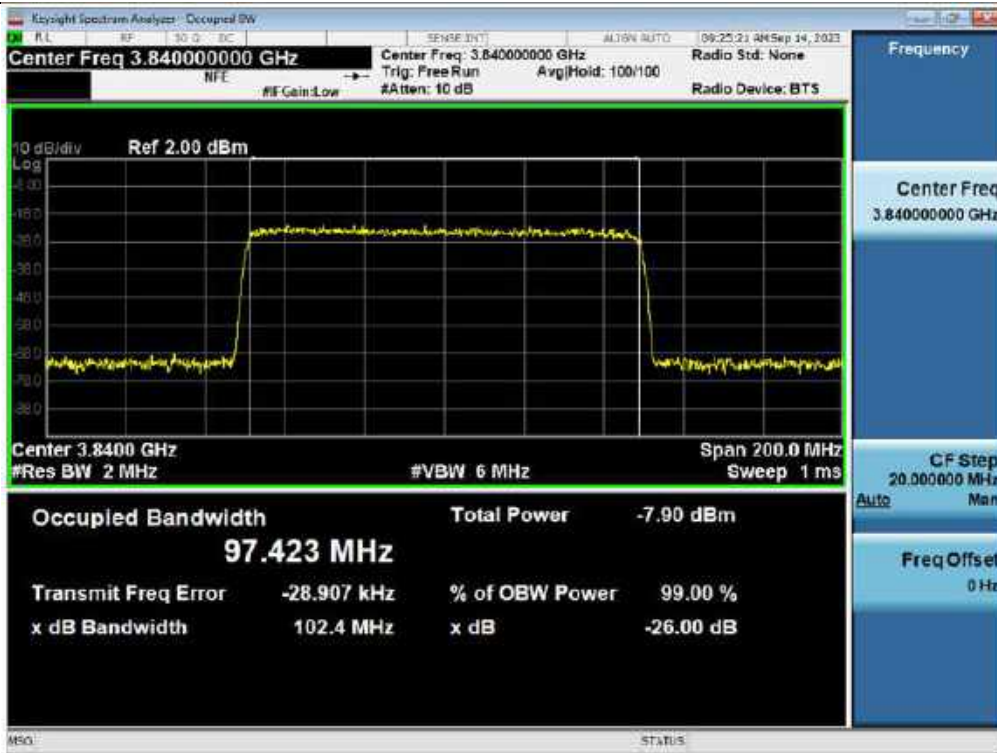

Output / 3.45 GHz Service (ANT 2) / Downlink / 5G NR 20 MHz

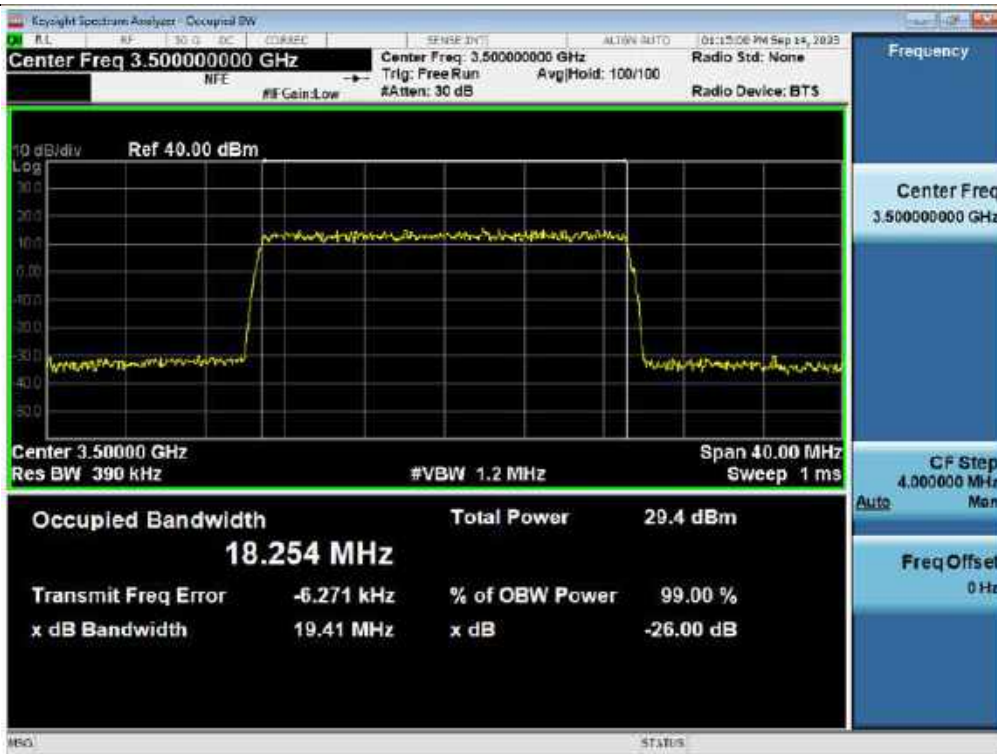

Input / 3.45 GHz Service (ANT 2) / Downlink / 5G NR 20 MHz

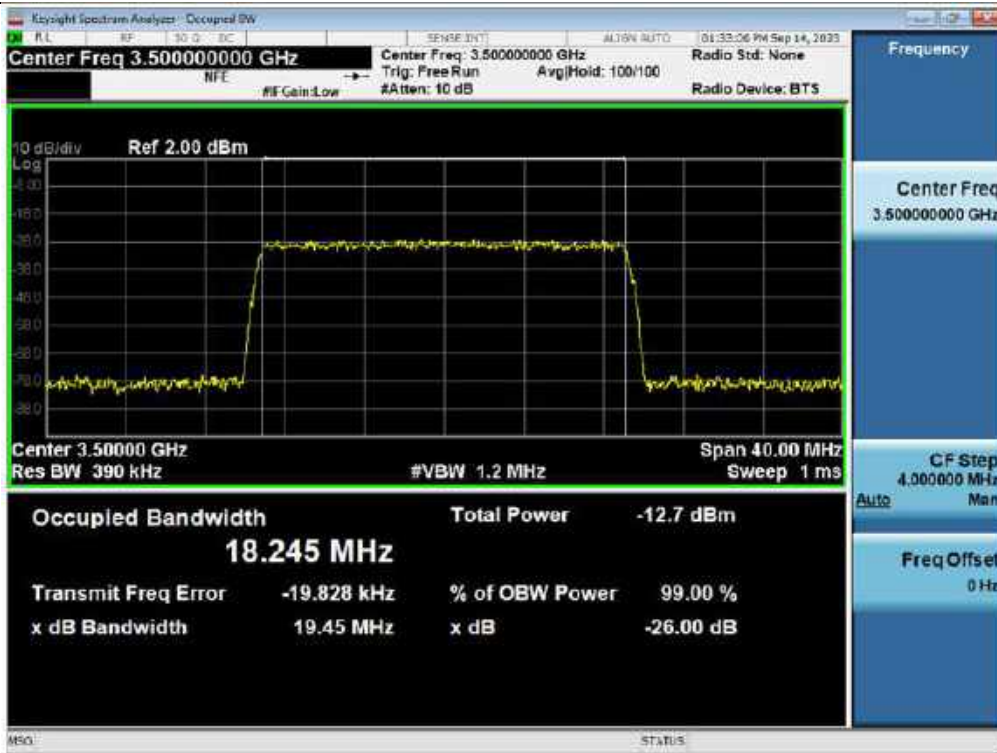

3 dB above the AGC threshold output / 3.45 GHz Service (ANT 2) / Downlink / 5G NR 20 MHz

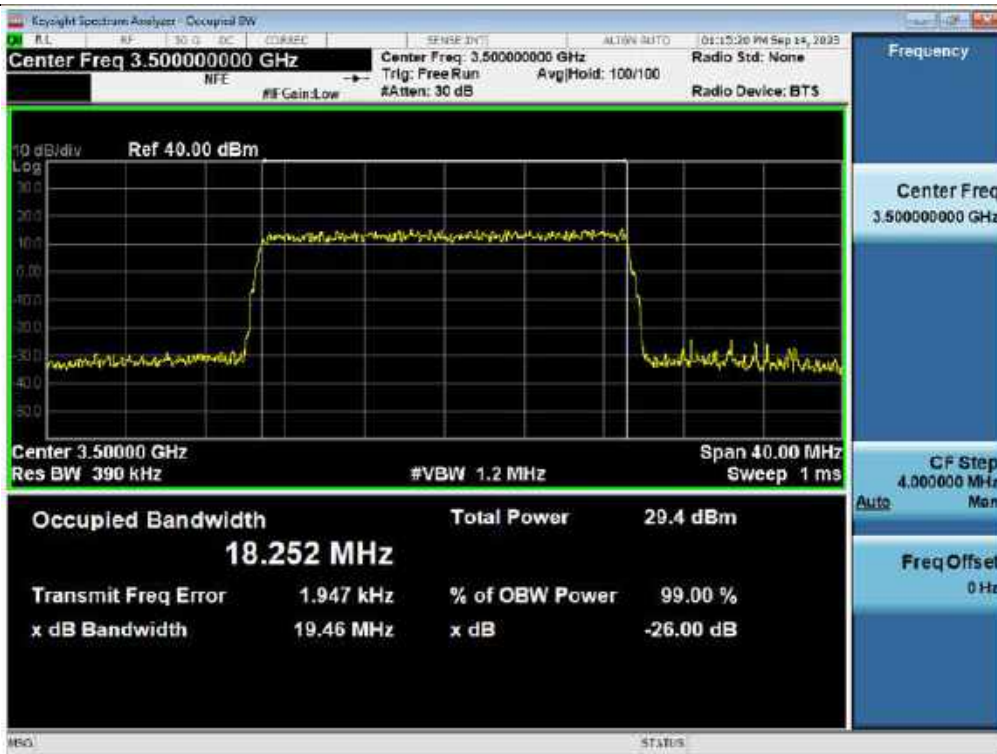

3 dB above the AGC threshold Input / 3.45 GHz Service (ANT 2) / Downlink / 5G NR 20 MHz

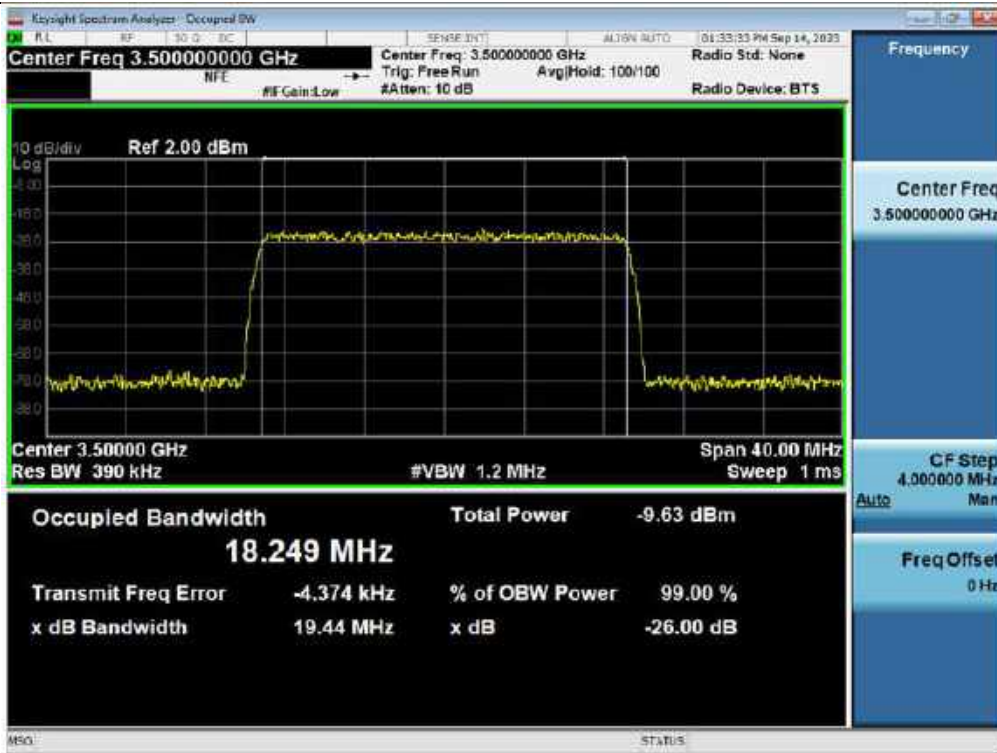

Output / 3.45 GHz Service (ANT 2) / Downlink / 5G NR 40 MHz

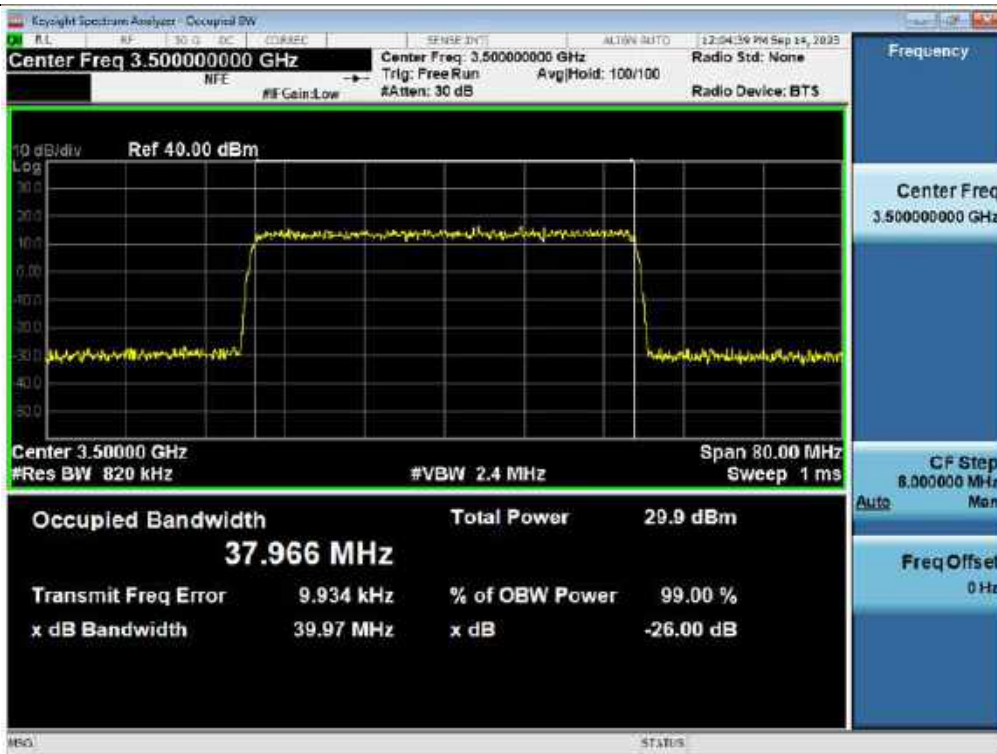

Input / 3.45 GHz Service (ANT 2) / Downlink / 5G NR 40 MHz

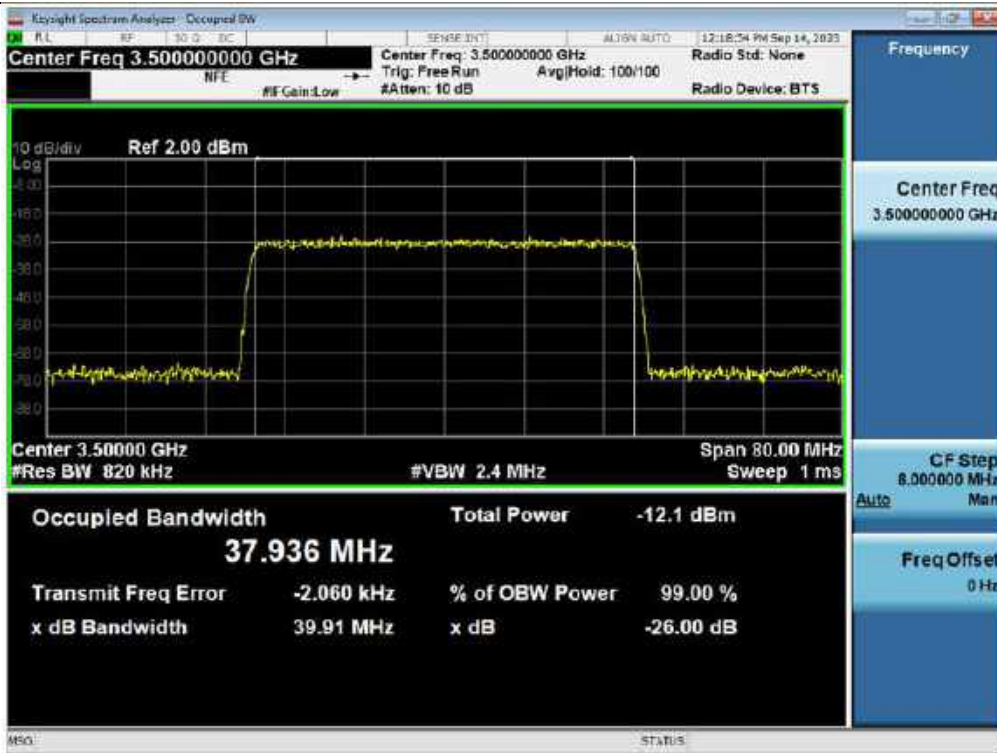

3 dB above the AGC threshold output / 3.45 GHz Service (ANT 2) / Downlink / 5G NR 40 MHz

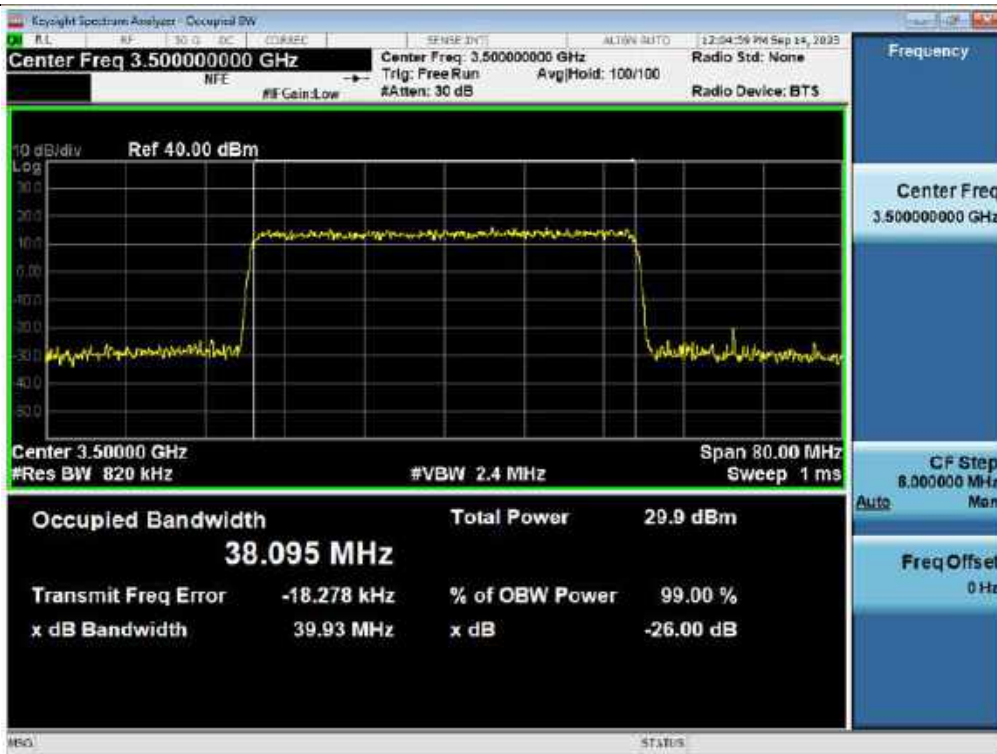

3 dB above the AGC threshold Input / 3.45 GHz Service (ANT 2) / Downlink / 5G NR 40 MHz

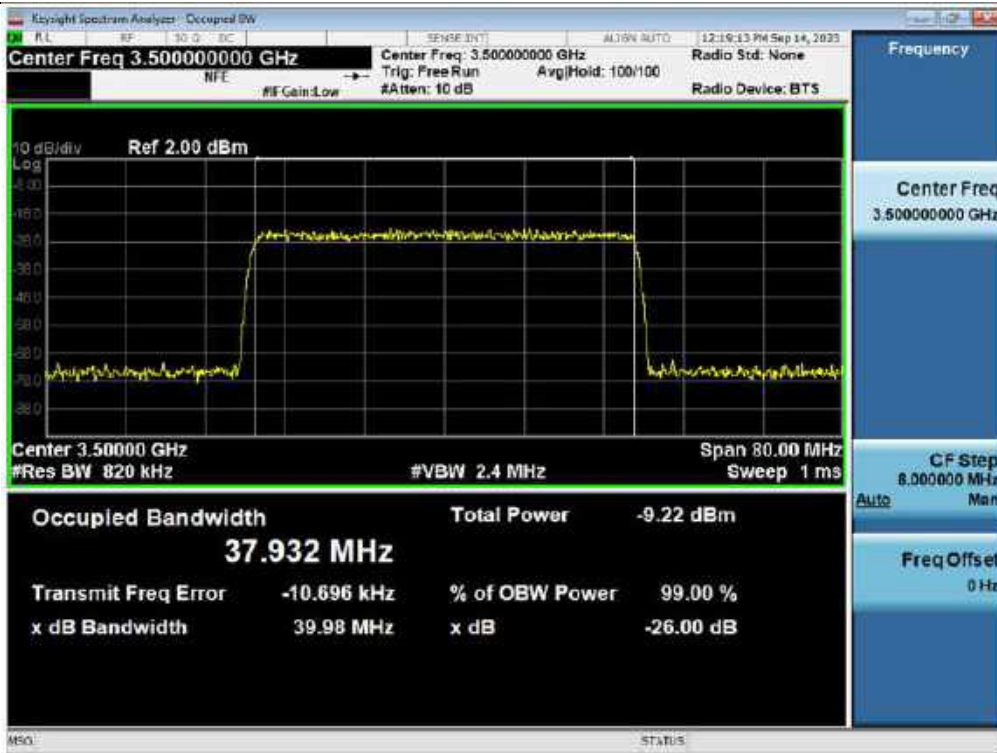

Output / 3.45 GHz Service (ANT 2) / Downlink / 5G NR 60 MHz



Input / 3.45 GHz Service (ANT 2) / Downlink / 5G NR 60 MHz



3 dB above the AGC threshold output / 3.45 GHz Service (ANT 2) / Downlink / 5G NR 60 MHz



3 dB above the AGC threshold Input / 3.45 GHz Service (ANT 2) / Downlink / 5G NR 60 MHz

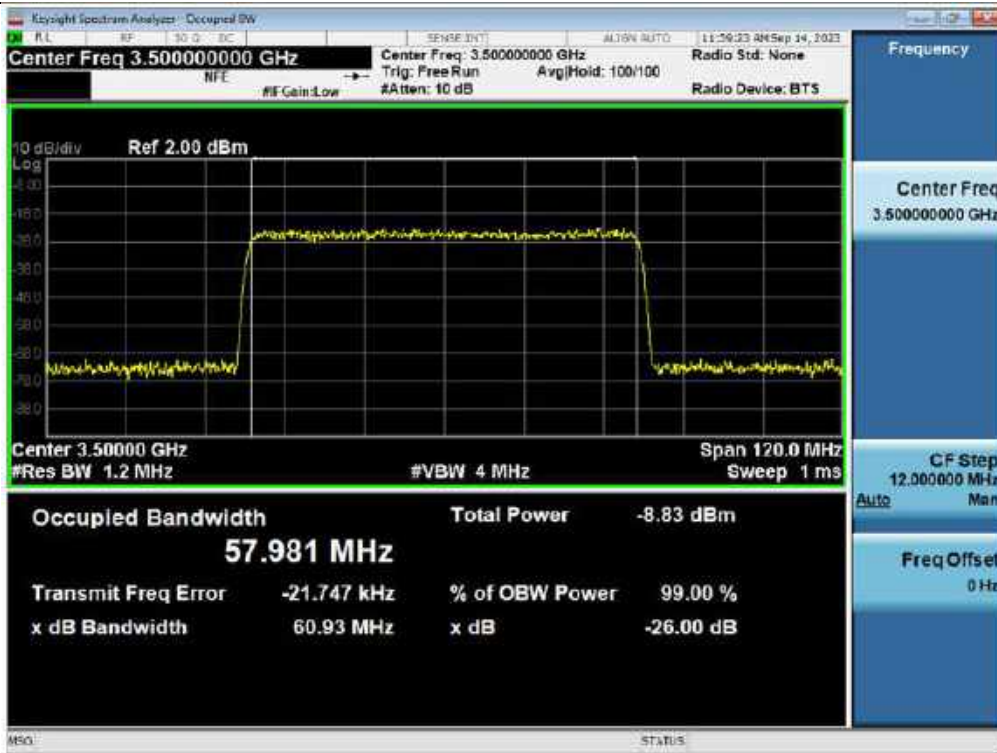

Output / 3.45 GHz Service (ANT 2) / Downlink / 5G NR 80 MHz



Input / 3.45 GHz Service (ANT 2) / Downlink / 5G NR 80 MHz

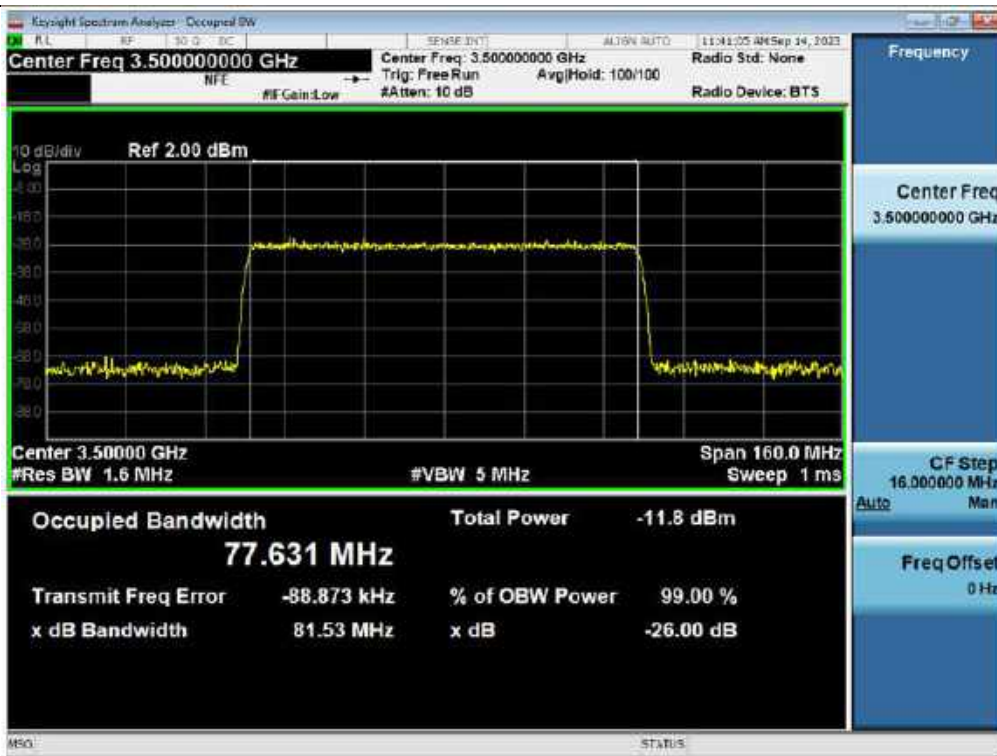

3 dB above the AGC threshold output / 3.45 GHz Service (ANT 2) / Downlink / 5G NR 80 MHz



3 dB above the AGC threshold Input / 3.45 GHz Service (ANT 2) / Downlink / 5G NR 80 MHz

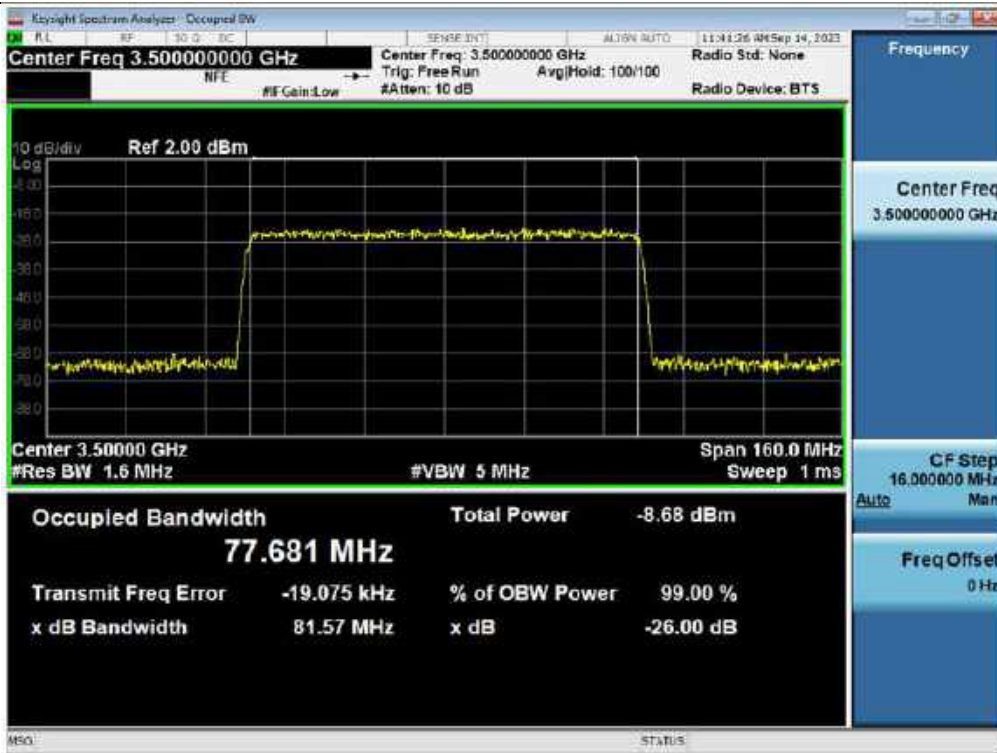

Output / 3.45 GHz Service (ANT 2) / Downlink / 5G NR 100 MHz



Input / 3.45 GHz Service (ANT 2) / Downlink / 5G NR 100 MHz

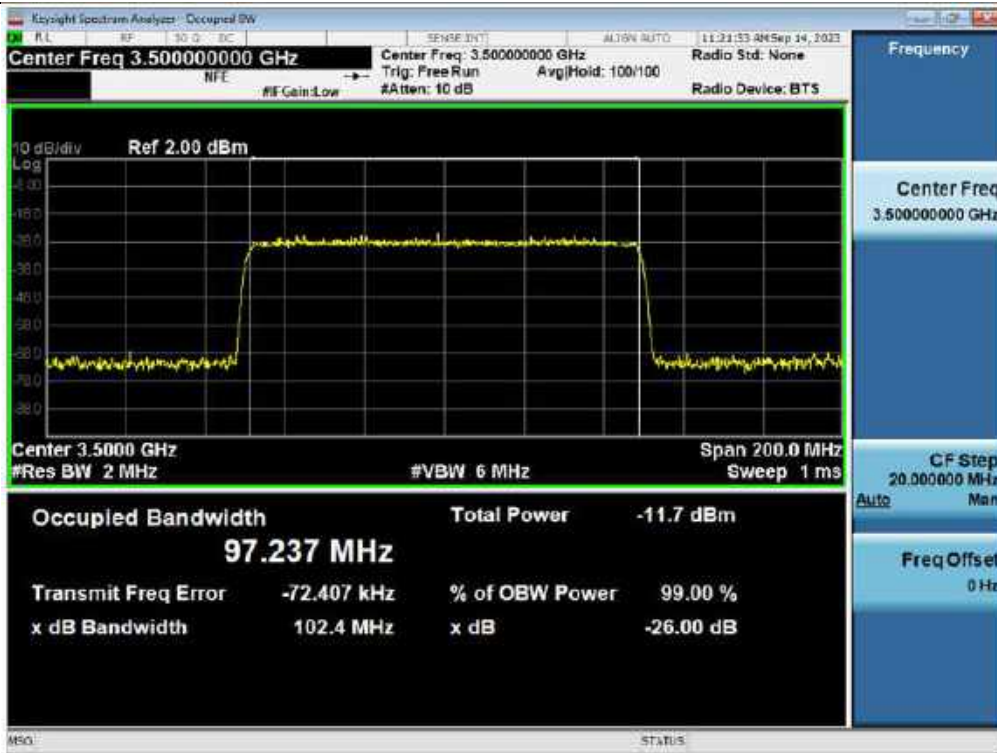

3 dB above the AGC threshold output / 3.45 GHz Service (ANT 2) / Downlink / 5G NR 100 MHz



3 dB above the AGC threshold Input / 3.45 GHz Service (ANT 2) / Downlink / 5G NR 100 MHz



5.4. INPUT/OUTPUT POWER AND AMPLIFIER/BOOSTER GAIN

Test Requirement:

§ 2.1046 Measurements required: RF power output.

- (a) For transmitters other than single sideband, independent sideband and controlled carrier radiotelephone, power output shall be measured at the RF output terminals when the transmitter is adjusted in accordance with the tune-up procedure to give the values of current and voltage on the circuit elements specified in § 2.1033(c)(8). The electrical characteristics of the radio frequency load attached to the output terminals when this test is made shall be stated.
- (b) For single sideband, independent sideband, and single channel, controlled carrier radiotelephone transmitters the procedure specified in paragraph (a) of this section shall be employed and, in addition, the transmitter shall be modulated during the test as specified and applicable in § 2.1046 (b) (1-5). In all tests, the input level of the modulating signal shall be such as to develop rated peak envelope power or carrier power, as appropriate, for the transmitter.
- (c) For measurements conducted pursuant to paragraphs (a) and (b) of this section, all calculations and methods used by the applicant for determining carrier power or peak envelope power, as appropriate, on the basis of measured power in the radio frequency load attached to the transmitter output terminals shall be shown. Under the test conditions specified, no components of the emission spectrum shall exceed the limits specified in the applicable rule parts as necessary for meeting occupied bandwidth or emission limitations.

§ 27.50 Power limits and duty cycle.

- (j) The following power requirements apply to stations transmitting in the 3700-3980 MHz band:
 - (2) The power of each fixed or base station transmitting in the 3700-3980 MHz band and situated in any geographic location other than that described in paragraph (j)(1) of this section is limited to an EIRP of 1640 Watts/MHz. This limit applies to the aggregate power of all antenna elements in any given sector of a base station.
 - (4) Equipment employed must be authorized in accordance with the provisions of § 27.51. Power measurements for transmissions by stations authorized under this section may be made either in accordance with a Commission-approved average power technique or in compliance with paragraph (j)(5) of this section. In measuring transmissions in this band using an average power technique, the peak-to-average ratio (PAR) of the transmission may not exceed 13 dB.

- (k) The following power requirements apply to stations transmitting in the 3450-3550 MHz band:
- (2) The power of each fixed or base station transmitting in the 3450-3550 MHz band and situated in any geographic location other than that described in paragraph (k)(1) of this section is limited to an EIRP of 1640 Watts/MHz. This limit applies to the aggregate power of all antenna elements in any given sector of a base station.
 - (4) Equipment employed must be authorized in accordance with the provisions of §27.51. Power measurements for transmissions by stations authorized under this section may be made either in accordance with a Commission-approved average power technique or in compliance with paragraph (k)(5) of this section. In measuring transmissions in this band using an average power technique, the peak-to-average ratio (PAR) of the transmission may not exceed 13 dB.

Test Procedures:

Measurements were in accordance with the test methods section 3.5 of KDB 935210 D05 v01r04.

Adjust the internal gain control of the EUT to the maximum gain for which the equipment certification is being sought. Any EUT attenuation settings shall be set to their minimum value.

Input power levels (uplink and downlink) should be set to maximum input ratings while confirming that the device is not capable of operating in saturation (non-linear mode) at the rated input levels, including during the performance of the input/output power measurements.

3.5.2 Measuring the EUT mean input and output power

- a) Connect a signal generator to the input of the EUT.
- b) Configure to generate the test signal.
- c) The frequency of the signal generator shall be set to the frequency f_0 as determined from out-of-band rejection test.
- d) Connect a spectrum analyzer or power meter to the output of the EUT using appropriate attenuation as necessary.
- e) Set the signal generator output power to a level that produces an EUT output level that is just below the AGC threshold, but not more than 0.5 dB below.
- f) Measure and record the output power of the EUT; use ANSI C63.26-2015 subclause 5.2.4.4.1, for power measurement.
- g) Remove the EUT from the measurement setup. Using the same signal generator settings, repeat the power measurement at the signal generator port, which was used as the input signal to the EUT, and record as the input power. EUT gain may be calculated as described in 3.5.5.
- h) Repeat steps f) and g) with input signal amplitude set to 3 dB above the AGC threshold level.
- i) Repeat steps e) to h) with the narrowband test signal.
- j) Repeat steps e) to i) for all frequency bands authorized for use by the EUT.

3.5.5 Calculating amplifier, repeater, or industrial booster gain

After the input and output power levels have been measured as described in the preceding subclauses, the gain of the EUT can be determined from:

$$\text{Gain (dB)} = \text{output power (dBm)} - \text{input power (dBm)}.$$

Report the gain for each authorized operating frequency band, and each test signal stimulus.

Note

If f_0 that determined from out-of-band test is smaller or greater than difference of test signal's center frequency and operation band block, test is performed at the lowest or the highest frequency that test signals can be passed.

Test Results:

Tabular data of Input / Output Power and Gain

Test Band	Signal	f ₀ Frequency	Input Power	Output Power	Gain
		(MHz)	(dBm)		(dB)
3.7 GHz Service (ANT 1)	5G NR 20 MHz	3 943.72	-19.63	24.25	43.88
	5G NR 40 MHz	3 943.72	-19.78	23.69	43.47
	5G NR 60 MHz	3 943.72	-19.74	23.96	43.70
	5G NR 80 MHz	3 940.00	-19.78	23.66	43.44
	5G NR 100 MHz	3 930.00	-19.82	23.75	43.57
3.45 GHz Service (ANT 1)	5G NR 20 MHz	3 490.56	-20.07	22.31	42.38
	5G NR 40 MHz	3 490.56	-20.09	22.02	42.11
	5G NR 60 MHz	3 490.56	-20.10	22.25	42.35
	5G NR 80 MHz	3 490.56	-20.11	22.23	42.34
	5G NR 100 MHz	3 500.00	-20.25	21.79	42.04
3.7 GHz Service (ANT 2)	5G NR 20 MHz	3 710.00	-19.88	24.08	43.96
	5G NR 40 MHz	3 720.00	-19.86	24.09	43.95
	5G NR 60 MHz	3 730.00	-19.78	23.86	43.64
	5G NR 80 MHz	3 740.00	-19.75	23.98	43.73
	5G NR 100 MHz	3 750.00	-19.74	24.02	43.76
3.45 GHz Service (ANT 2)	5G NR 20 MHz	3 521.96	-20.15	22.19	42.34
	5G NR 40 MHz	3 521.96	-20.20	22.13	42.33
	5G NR 60 MHz	3 520.00	-20.10	21.99	42.09
	5G NR 80 MHz	3 510.00	-20.20	22.28	42.48
	5G NR 100 MHz	3 500.00	-20.18	21.78	41.96

Tabular data of Input / 3 dB above AGC threshold Output Power and Gain

Test Band	Signal	f ₀ Frequency	Input Power	Output Power	Gain
		(MHz)	(dBm)		(dB)
3.7 GHz Service (ANT 1)	5G NR 20 MHz	3 943.72	-16.58	24.18	40.76
	5G NR 40 MHz	3 943.72	-16.71	23.61	40.32
	5G NR 60 MHz	3 943.72	-16.66	23.86	40.52
	5G NR 80 MHz	3 940.00	-16.70	23.60	40.30
	5G NR 100 MHz	3 930.00	-16.75	23.66	40.41
3.45 GHz Service (ANT 1)	5G NR 20 MHz	3 490.56	-17.06	22.29	39.35
	5G NR 40 MHz	3 490.56	-17.07	21.99	39.06
	5G NR 60 MHz	3 490.56	-17.07	22.22	39.29
	5G NR 80 MHz	3 490.56	-17.09	22.21	39.30
	5G NR 100 MHz	3 500.00	-17.26	21.70	38.96
3.7 GHz Service (ANT 2)	5G NR 20 MHz	3 710.00	-16.87	24.07	40.94
	5G NR 40 MHz	3 720.00	-16.86	24.06	40.92
	5G NR 60 MHz	3 730.00	-16.76	23.85	40.61
	5G NR 80 MHz	3 740.00	-16.75	23.98	40.73
	5G NR 100 MHz	3 750.00	-16.75	23.96	40.71
3.45 GHz Service (ANT 2)	5G NR 20 MHz	3 521.96	-17.16	22.16	39.32
	5G NR 40 MHz	3 521.96	-17.18	22.12	39.30
	5G NR 60 MHz	3 520.00	-17.09	21.97	39.06
	5G NR 80 MHz	3 510.00	-17.19	22.23	39.42
	5G NR 100 MHz	3 500.00	-17.16	21.72	38.88

Tabular data of equivalent isotropically radiated power(E.I.R.P.)

Test Band	Signal	f ₀ Frequency (MHz)	Output PSD (dBm/MHz)	Ant. Gain (dBi)	E.I.R.P. (dBm/MHz)	Calculated (W/MHz)	Limit (W/MHz)
3.7 GHz Service (ANT 1)	5G NR 20 MHz	3 943.72	12.87	17.0	29.87	0.97	1640
	5G NR 40 MHz	3 943.72	9.03	17.0	26.03	0.40	
	5G NR 60 MHz	3 943.72	7.82	17.0	24.82	0.30	
	5G NR 80 MHz	3 940.00	6.41	17.0	23.40	0.22	
	5G NR 100 MHz	3 930.00	5.72	17.0	22.72	0.19	
3.45 GHz Service (ANT 1)	5G NR 20 MHz	3 490.56	10.90	17.0	27.90	0.62	
	5G NR 40 MHz	3 490.56	7.62	17.0	24.62	0.29	
	5G NR 60 MHz	3 490.56	6.16	17.0	23.16	0.21	
	5G NR 80 MHz	3 490.56	5.27	17.0	22.27	0.17	
	5G NR 100 MHz	3 500.00	3.75	17.0	20.75	0.12	
3.7 GHz Service (ANT 2)	5G NR 20 MHz	3 710.00	12.69	17.0	29.69	0.93	
	5G NR 40 MHz	3 720.00	9.80	17.0	26.80	0.48	
	5G NR 60 MHz	3 730.00	8.09	17.0	25.09	0.32	
	5G NR 80 MHz	3 740.00	6.92	17.0	23.92	0.25	
	5G NR 100 MHz	3 750.00	6.06	17.0	23.06	0.20	
3.45 GHz Service (ANT 2)	5G NR 20 MHz	3 521.96	10.75	17.0	27.75	0.60	
	5G NR 40 MHz	3 521.96	7.55	17.0	24.55	0.29	
	5G NR 60 MHz	3 520.00	5.79	17.0	22.79	0.19	
	5G NR 80 MHz	3 510.00	4.95	17.0	21.95	0.16	
	5G NR 100 MHz	3 500.00	3.48	17.0	20.48	0.11	

Note: Downlink E.I.R.P.(dBm/MHz) = Output PSD(dBm/MHz) + Ant. Gain(dBi)



MIMO Tabular data of equivalent isotropically radiated power(E.I.R.P.)

Test Band	Signal	Directional Ant. Gain	E.I.R.P.		Limit
		(dBi)	(dBm/MHz)	(W/MHz)	(W/MHz)
3.7 GHz Service (ANT1 + ANT2)	5G NR 20 MHz	20.0	35.79	3.79	1640
	5G NR 40 MHz	20.0	32.44	1.75	
	5G NR 60 MHz	20.0	30.97	1.25	
	5G NR 80 MHz	20.0	29.68	0.93	
	5G NR 100 MHz	20.0	28.90	0.78	
3.45 GHz Service (ANT1 + ANT2)	5G NR 20 MHz	20.0	33.84	2.42	
	5G NR 40 MHz	20.0	30.60	1.15	
	5G NR 60 MHz	20.0	28.99	0.79	
	5G NR 80 MHz	20.0	28.12	0.65	
	5G NR 100 MHz	20.0	26.63	0.46	

Tabular data of 3 dB above AGC threshold equivalent isotropically radiated power(E.I.R.P.)

Test Band	Signal	f ₀ Frequency (MHz)	Output PSD (dBm/MHz)	Ant. Gain (dBi)	E.I.R.P. (dBm/MHz)	Calculated (W/MHz)	Limit (W/MHz)
3.7 GHz Service (ANT 1)	5G NR 20 MHz	3 943.72	12.68	17.0	29.68	0.93	1640
	5G NR 40 MHz	3 943.72	8.96	17.0	25.96	0.39	
	5G NR 60 MHz	3 943.72	7.57	17.0	24.57	0.29	
	5G NR 80 MHz	3 940.00	6.28	17.0	23.28	0.21	
	5G NR 100 MHz	3 930.00	5.48	17.0	22.48	0.18	
3.45 GHz Service (ANT 1)	5G NR 20 MHz	3 490.56	10.79	17.0	27.79	0.60	
	5G NR 40 MHz	3 490.56	7.47	17.0	24.47	0.28	
	5G NR 60 MHz	3 490.56	5.96	17.0	22.96	0.20	
	5G NR 80 MHz	3 490.56	5.20	17.0	22.20	0.17	
	5G NR 100 MHz	3 500.00	3.75	17.0	20.75	0.12	
3.7 GHz Service (ANT 2)	5G NR 20 MHz	3 710.00	12.52	17.0	29.52	0.90	
	5G NR 40 MHz	3 720.00	9.90	17.0	26.90	0.49	
	5G NR 60 MHz	3 730.00	8.03	17.0	25.03	0.32	
	5G NR 80 MHz	3 740.00	6.84	17.0	23.84	0.24	
	5G NR 100 MHz	3 750.00	5.97	17.0	22.97	0.20	
3.45 GHz Service (ANT 2)	5G NR 20 MHz	3 521.96	10.51	17.0	27.51	0.56	
	5G NR 40 MHz	3 521.96	7.43	17.0	24.43	0.28	
	5G NR 60 MHz	3 520.00	5.63	17.0	22.63	0.18	
	5G NR 80 MHz	3 510.00	4.69	17.0	21.69	0.15	
	5G NR 100 MHz	3 500.00	3.37	17.0	20.37	0.11	

Note: Downlink E.I.R.P.(dBm/MHz) = Output PSD(dBm/MHz) + Ant. Gain(dBi)



MIMO Tabular data of 3 dB above AGC threshold equivalent isotropically radiated power(E.I.R.P.)

Test Band	Signal	Directional Ant. Gain	E.I.R.P.		Limit
		(dBi)	(dBm/MHz)	(W/MHz)	(W/MHz)
3.7 GHz Service (ANT1 + ANT2)	5G NR 20 MHz	20.0	35.61	3.64	1640
	5G NR 40 MHz	20.0	32.47	1.77	
	5G NR 60 MHz	20.0	30.82	1.21	
	5G NR 80 MHz	20.0	29.58	0.91	
	5G NR 100 MHz	20.0	28.74	0.75	
3.45 GHz Service (ANT1 + ANT2)	5G NR 20 MHz	20.0	33.66	2.32	
	5G NR 40 MHz	20.0	30.46	1.11	
	5G NR 60 MHz	20.0	28.81	0.76	
	5G NR 80 MHz	20.0	27.96	0.63	
	5G NR 100 MHz	20.0	26.57	0.45	

Tabular data of PAPR

Test Band	Signal	f ₀ Frequency (MHz)	0.1 % PAPR (dB)
3.7 GHz Service (ANT 1)	5G NR 20 MHz	3 943.72	8.12
	5G NR 40 MHz	3 943.72	8.24
	5G NR 60 MHz	3 943.72	8.17
	5G NR 80 MHz	3 940.00	8.23
	5G NR 100 MHz	3 930.00	8.22
3.45 GHz Service (ANT 1)	5G NR 20 MHz	3 490.56	8.40
	5G NR 40 MHz	3 490.56	8.43
	5G NR 60 MHz	3 490.56	8.47
	5G NR 80 MHz	3 490.56	8.44
	5G NR 100 MHz	3 500.00	8.41
3.7 GHz Service (ANT 2)	5G NR 20 MHz	3 710.00	8.22
	5G NR 40 MHz	3 720.00	8.34
	5G NR 60 MHz	3 730.00	8.37
	5G NR 80 MHz	3 740.00	8.41
	5G NR 100 MHz	3 750.00	8.40
3.45 GHz Service (ANT 2)	5G NR 20 MHz	3 521.96	8.41
	5G NR 40 MHz	3 521.96	8.40
	5G NR 60 MHz	3 520.00	8.40
	5G NR 80 MHz	3 510.00	8.40
	5G NR 100 MHz	3 500.00	8.38

Plot data of PSD

PSD / 3.7 GHz Service (ANT 1) / Downlink / 5G NR 20 MHz

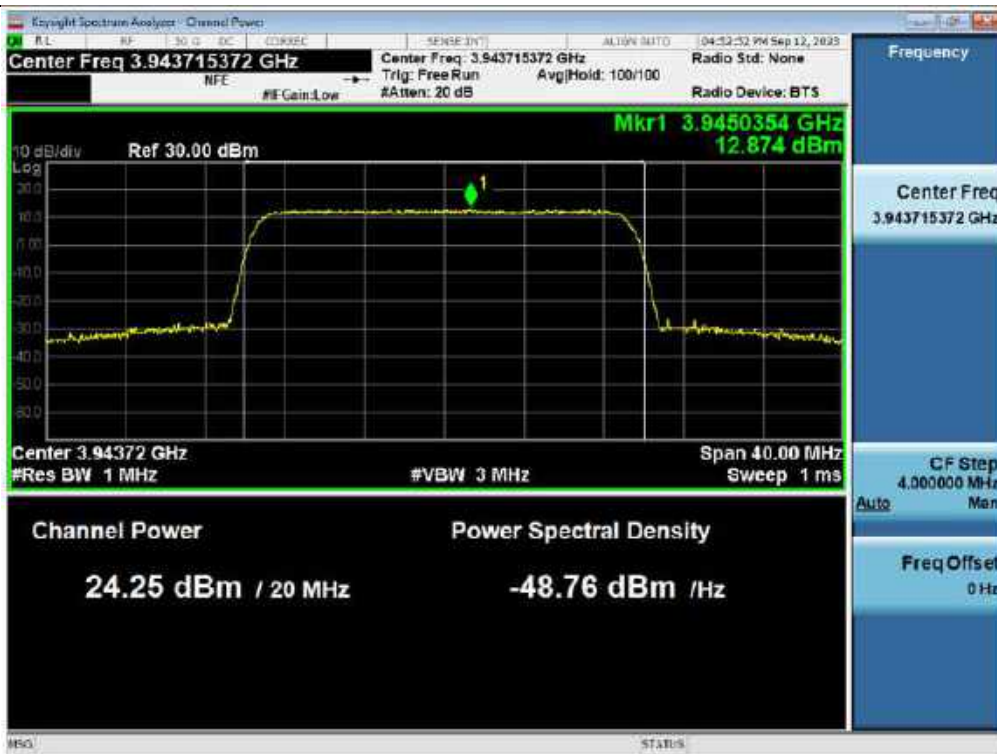

3 dB above the AGC threshold PSD / 3.7 GHz Service (ANT 1) / Downlink / 5G NR 20 MHz

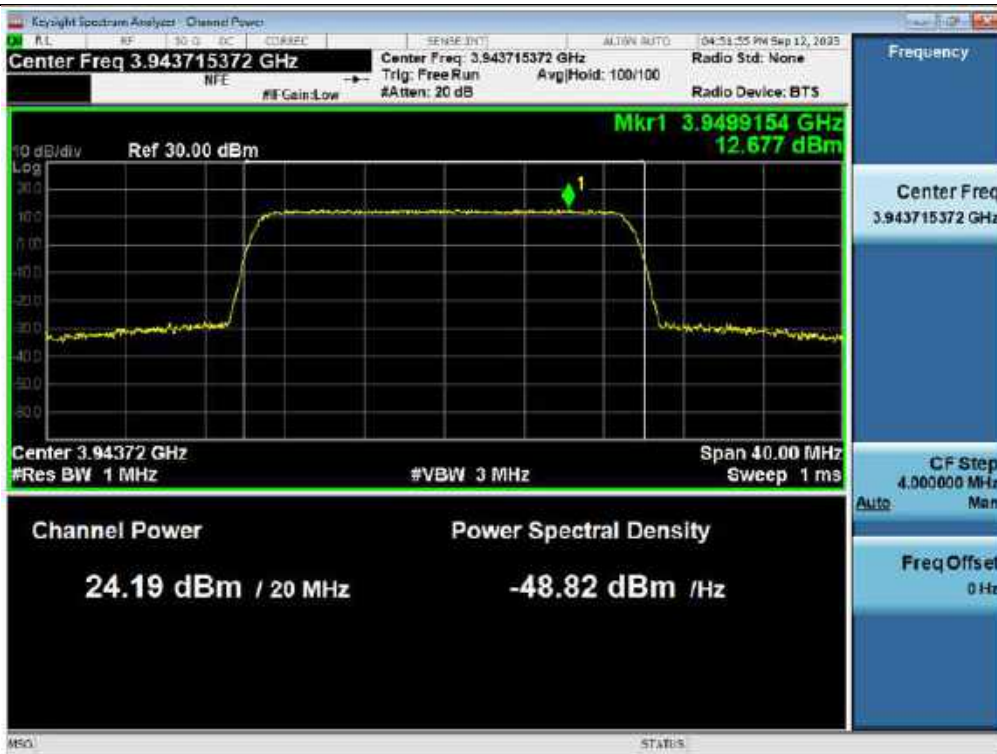

PSD / 3.7 GHz Service (ANT 1) / Downlink / 5G NR 40 MHz



3 dB above the AGC threshold PSD / 3.7 GHz Service (ANT 1) / Downlink / 5G NR 40 MHz

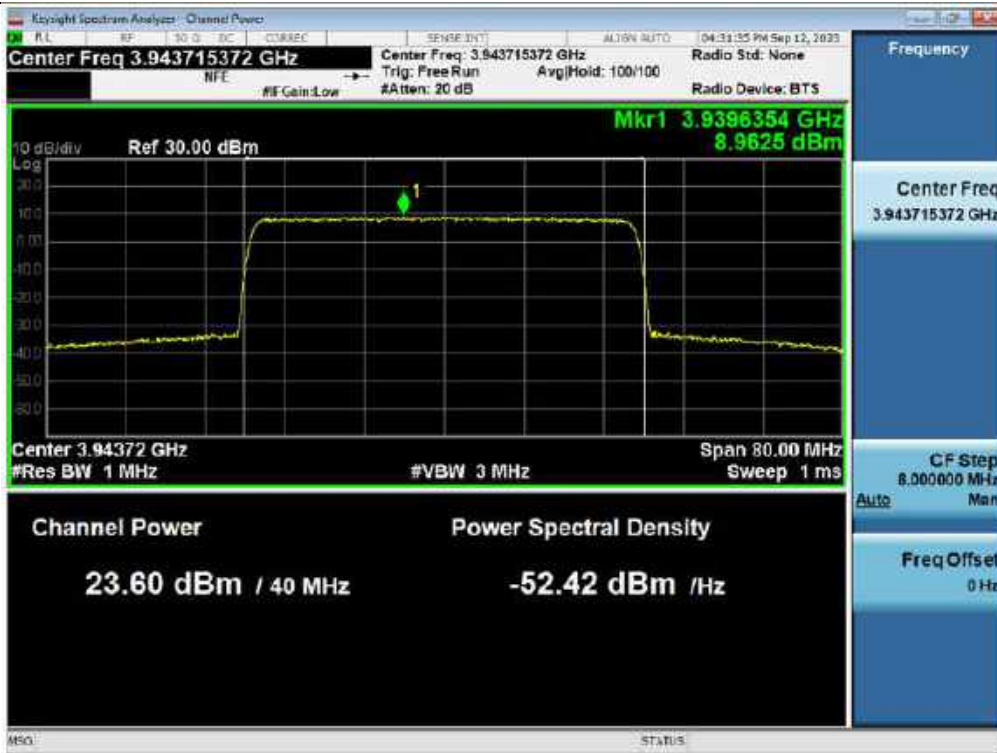

PSD / 3.7 GHz Service (ANT 1) / Downlink / 5G NR 60 MHz



3 dB above the AGC threshold PSD / 3.7 GHz Service (ANT 1) / Downlink / 5G NR 60 MHz



PSD / 3.7 GHz Service (ANT 1) / Downlink / 5G NR 80 MHz



3 dB above the AGC threshold PSD / 3.7 GHz Service (ANT 1) / Downlink / 5G NR 80 MHz



PSD / 3.7 GHz Service (ANT 1) / Downlink / 5G NR 100 MHz



3 dB above the AGC threshold PSD / 3.7 GHz Service (ANT 1) / Downlink / 5G NR 100 MHz





PSD / 3.45 GHz Service (ANT 1) / Downlink / 5G NR 20 MHz

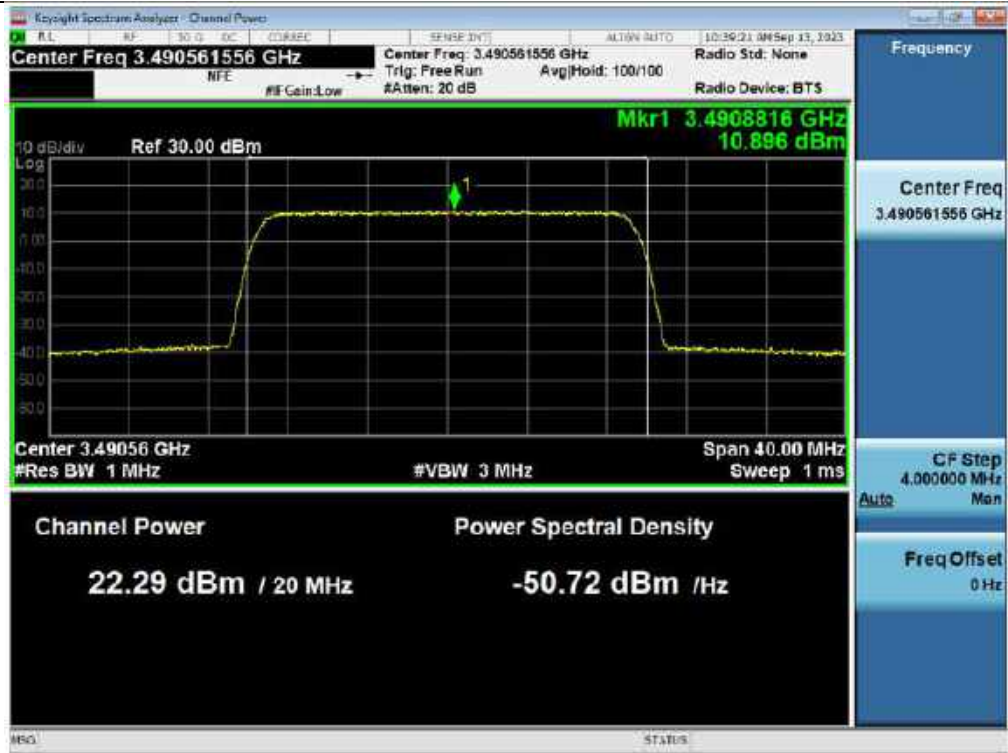

3 dB above the AGC threshold PSD / 3.45 GHz Service (ANT 1) / Downlink / 5G NR 20 MHz

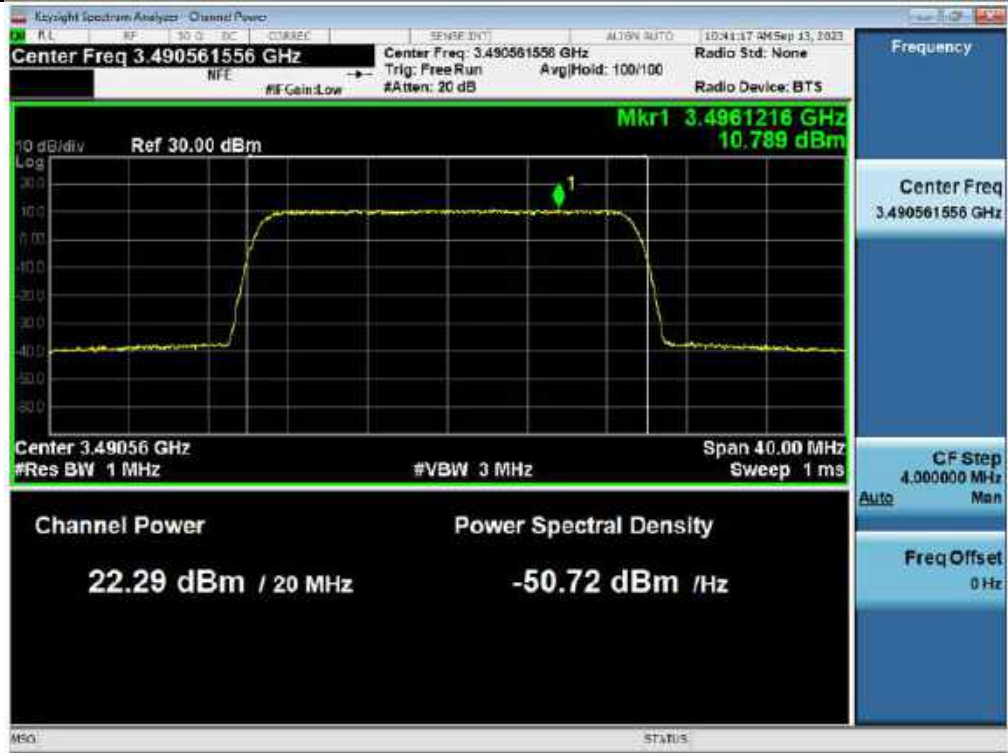

PSD / 3.45 GHz Service (ANT 1) / Downlink / 5G NR 40 MHz

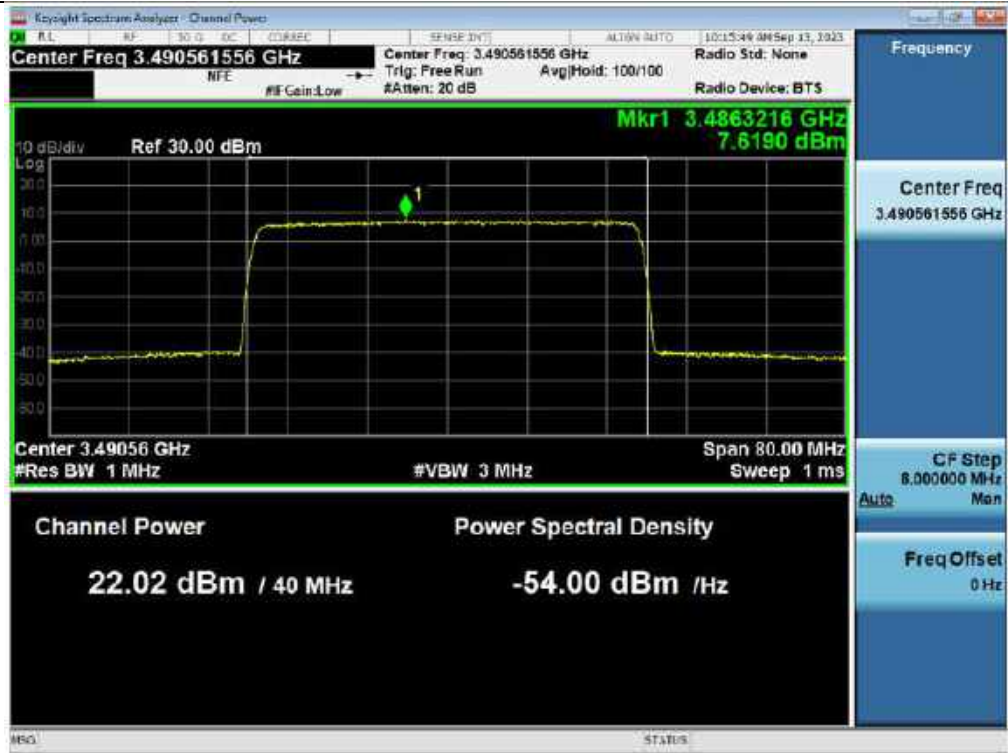

3 dB above the AGC threshold PSD / 3.45 GHz Service (ANT 1) / Downlink / 5G NR 40 MHz

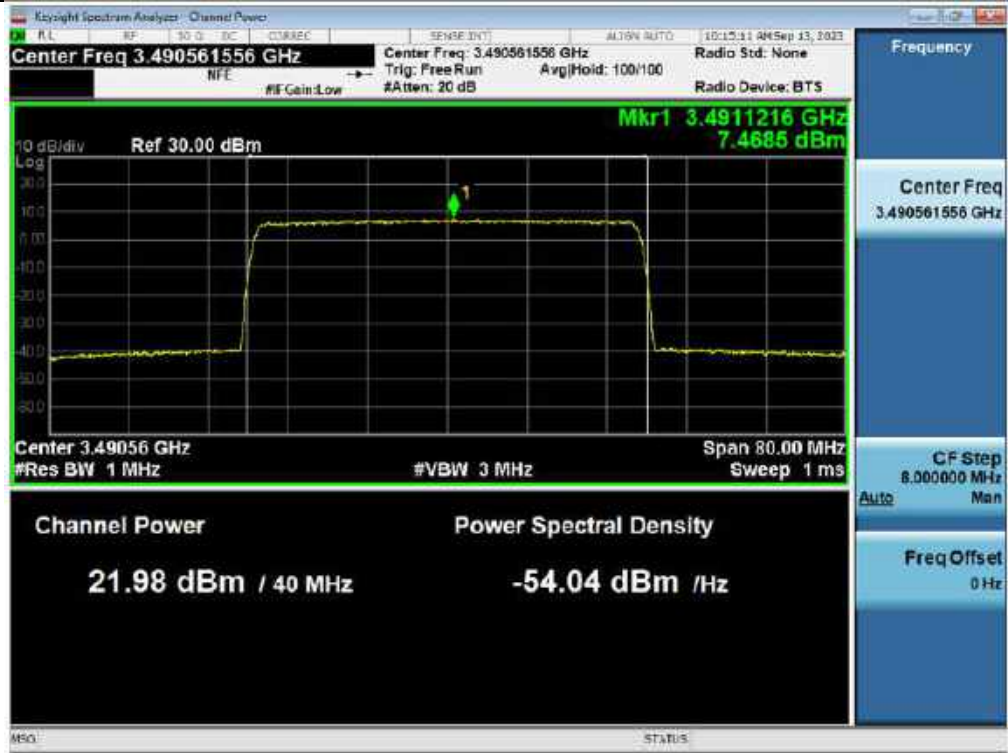

PSD / 3.45 GHz Service (ANT 1) / Downlink / 5G NR 60 MHz

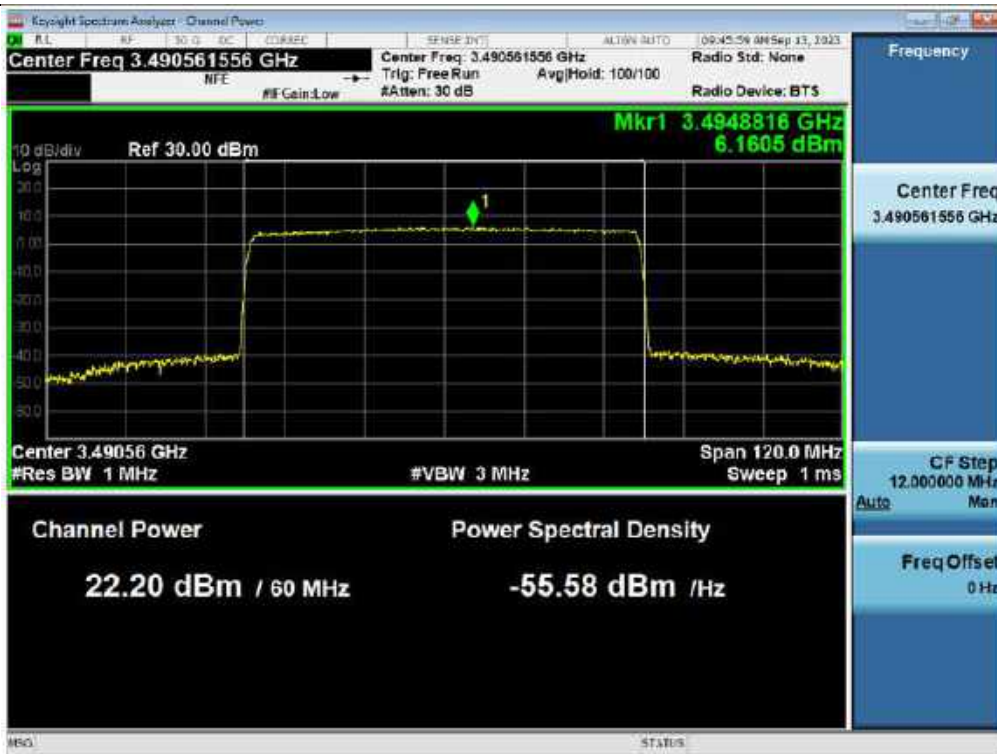

3 dB above the AGC threshold PSD / 3.45 GHz Service (ANT 1) / Downlink / 5G NR 60 MHz

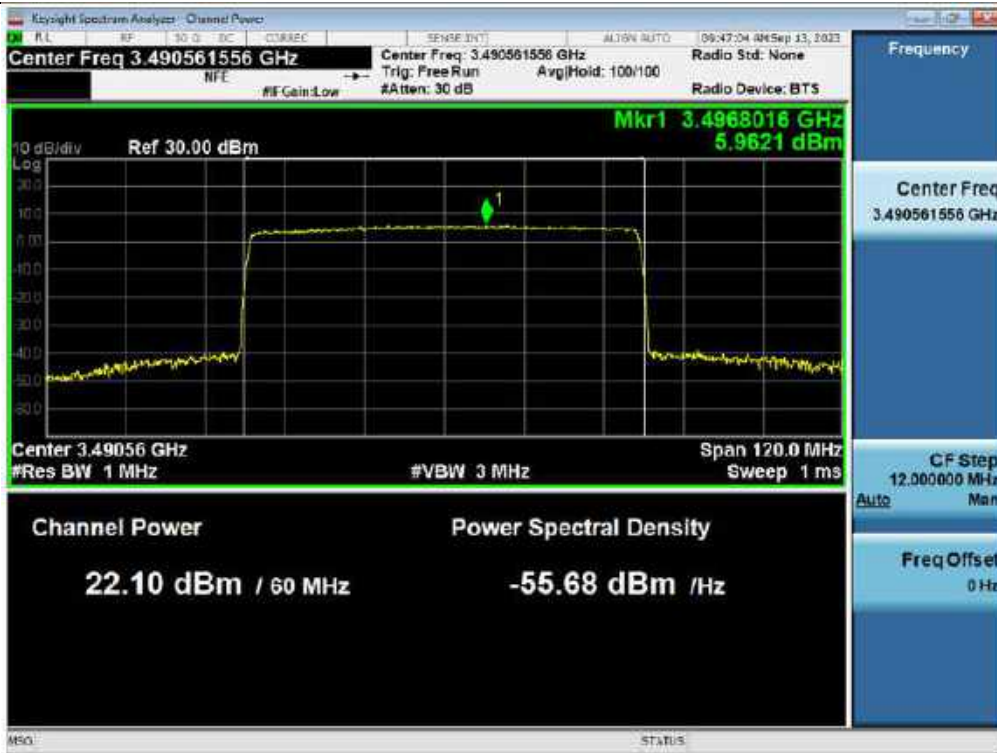

PSD / 3.45 GHz Service (ANT 1) / Downlink / 5G NR 80 MHz



3 dB above the AGC threshold PSD / 3.45 GHz Service (ANT 1) / Downlink / 5G NR 80 MHz



PSD / 3.45 GHz Service (ANT 1) / Downlink / 5G NR 100 MHz



3 dB above the AGC threshold PSD / 3.45 GHz Service (ANT 1) / Downlink / 5G NR 100 MHz



PSD / 3.7 GHz Service (ANT 2) / Downlink / 5G NR 20 MHz

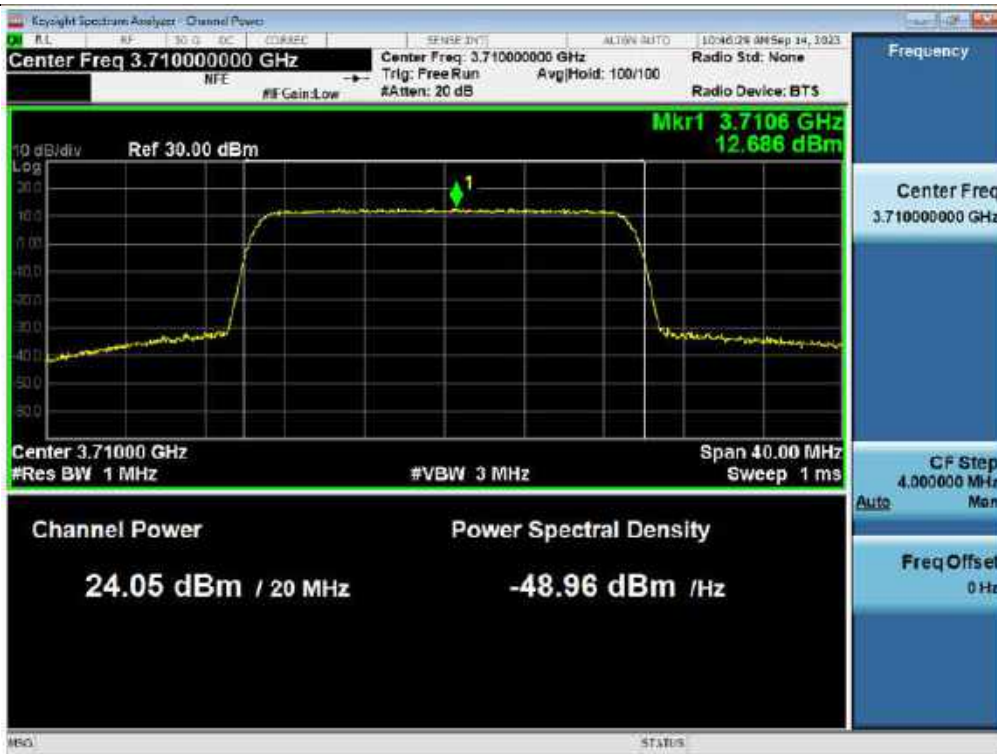

3 dB above the AGC threshold PSD / 3.7 GHz Service (ANT 2) / Downlink / 5G NR 20 MHz

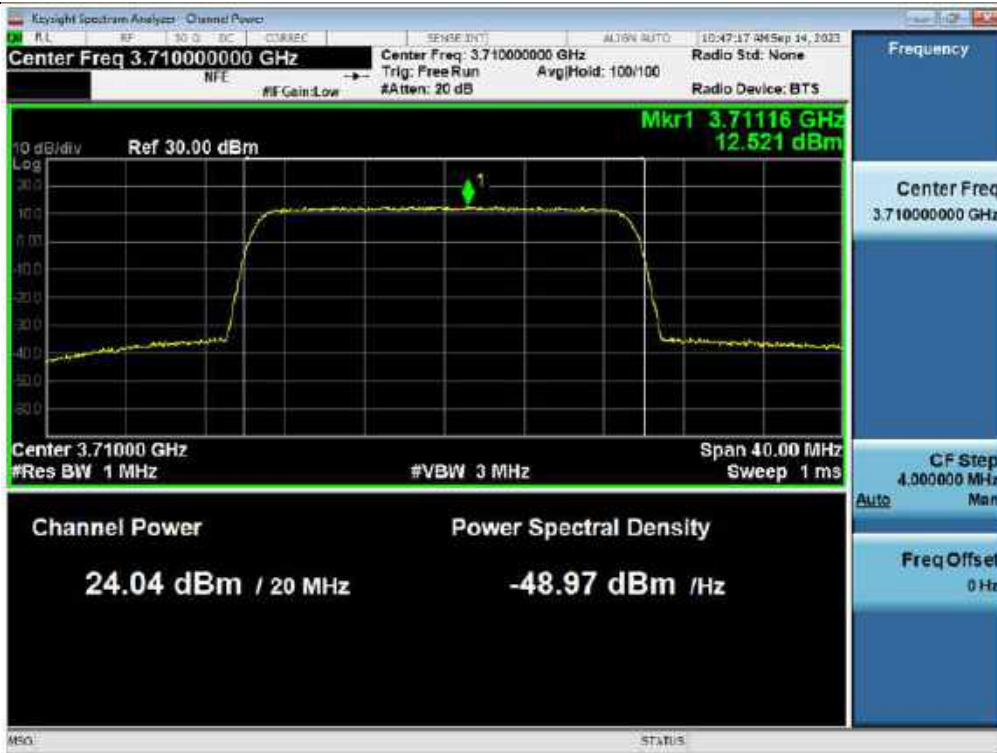

PSD / 3.7 GHz Service (ANT 2) / Downlink / 5G NR 40 MHz



3 dB above the AGC threshold PSD / 3.7 GHz Service (ANT 2) / Downlink / 5G NR 40 MHz



PSD / 3.7 GHz Service (ANT 2) / Downlink / 5G NR 60 MHz



3 dB above the AGC threshold PSD / 3.7 GHz Service (ANT 2) / Downlink / 5G NR 60 MHz



PSD / 3.7 GHz Service (ANT 2) / Downlink / 5G NR 80 MHz

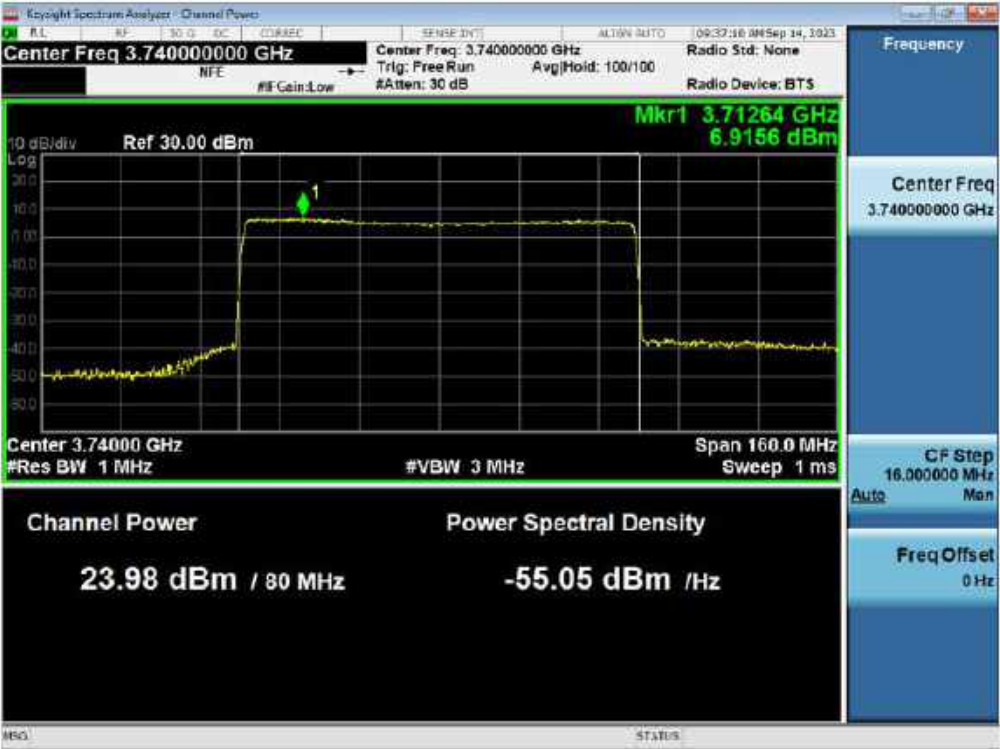

3 dB above the AGC threshold PSD / 3.7 GHz Service (ANT 2) / Downlink / 5G NR 80 MHz



PSD / 3.7 GHz Service (ANT 2) / Downlink / 5G NR 100 MHz



3 dB above the AGC threshold PSD / 3.7 GHz Service (ANT 2) / Downlink / 5G NR 100 MHz



PSD / 3.45 GHz Service (ANT 2) / Downlink / 5G NR 20 MHz



3 dB above the AGC threshold PSD / 3.45 GHz Service (ANT 2) / Downlink / 5G NR 20 MHz

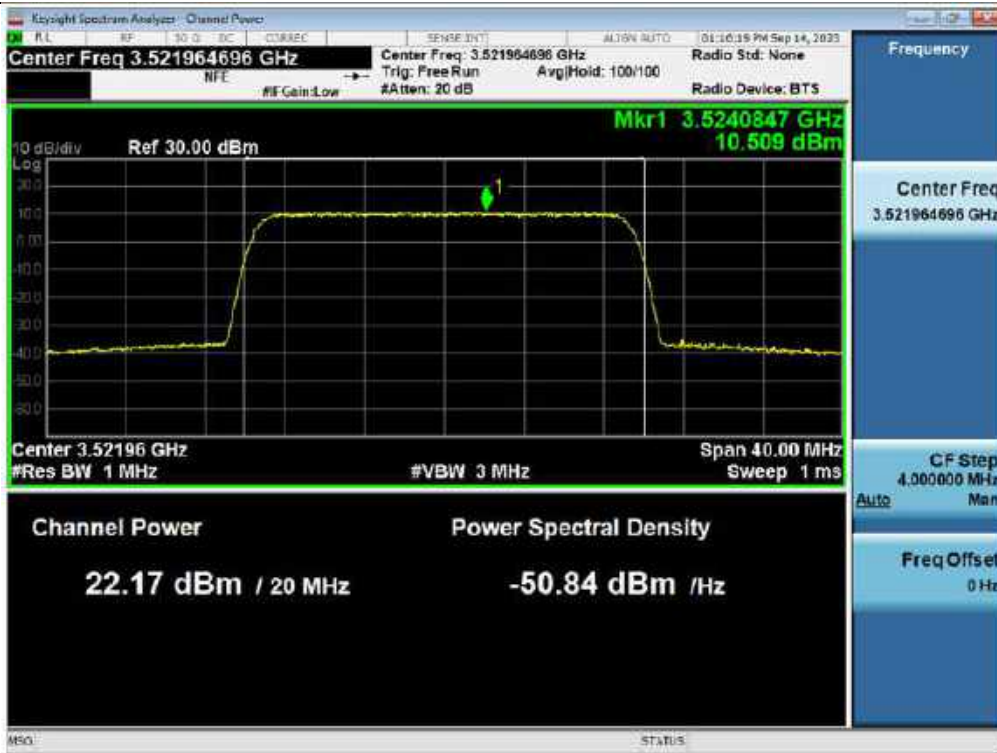

PSD / 3.45 GHz Service (ANT 2) / Downlink / 5G NR 40 MHz



3 dB above the AGC threshold PSD / 3.45 GHz Service (ANT 2) / Downlink / 5G NR 40 MHz



PSD / 3.45 GHz Service (ANT 2) / Downlink / 5G NR 60 MHz



3 dB above the AGC threshold PSD / 3.45 GHz Service (ANT 2) / Downlink / 5G NR 60 MHz





PSD / 3.45 GHz Service (ANT 2) / Downlink / 5G NR 80 MHz



3 dB above the AGC threshold PSD / 3.45 GHz Service (ANT 2) / Downlink / 5G NR 80 MHz



PSD / 3.45 GHz Service (ANT 2) / Downlink / 5G NR 100 MHz



3 dB above the AGC threshold PSD / 3.45 GHz Service (ANT 2) / Downlink / 5G NR 100 MHz

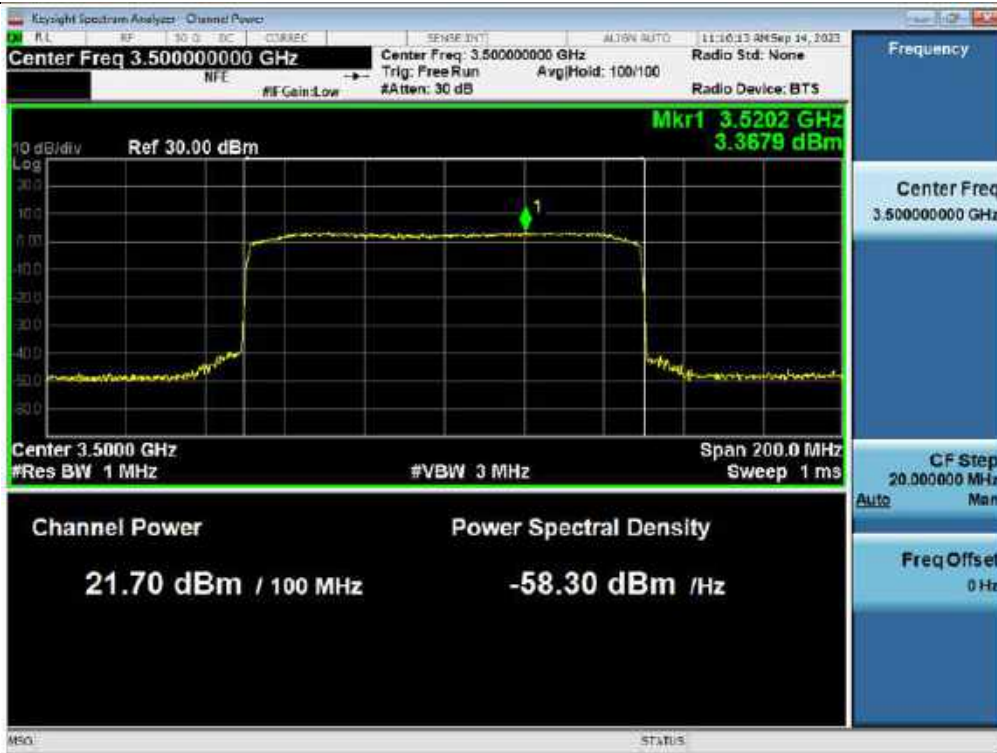

Plot data of PAPR

PAPR / 3.7 GHz Service (ANT 1) / Downlink / 5G NR 20 MHz

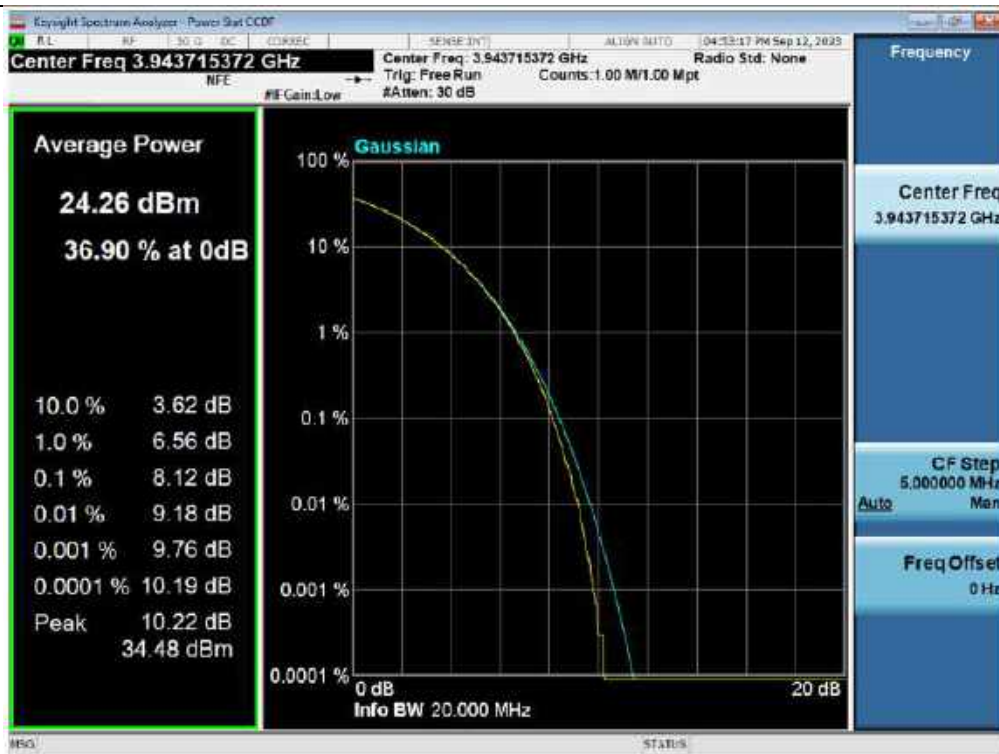

PAPR / 3.7 GHz Service (ANT 1) / Downlink / 5G NR 40 MHz

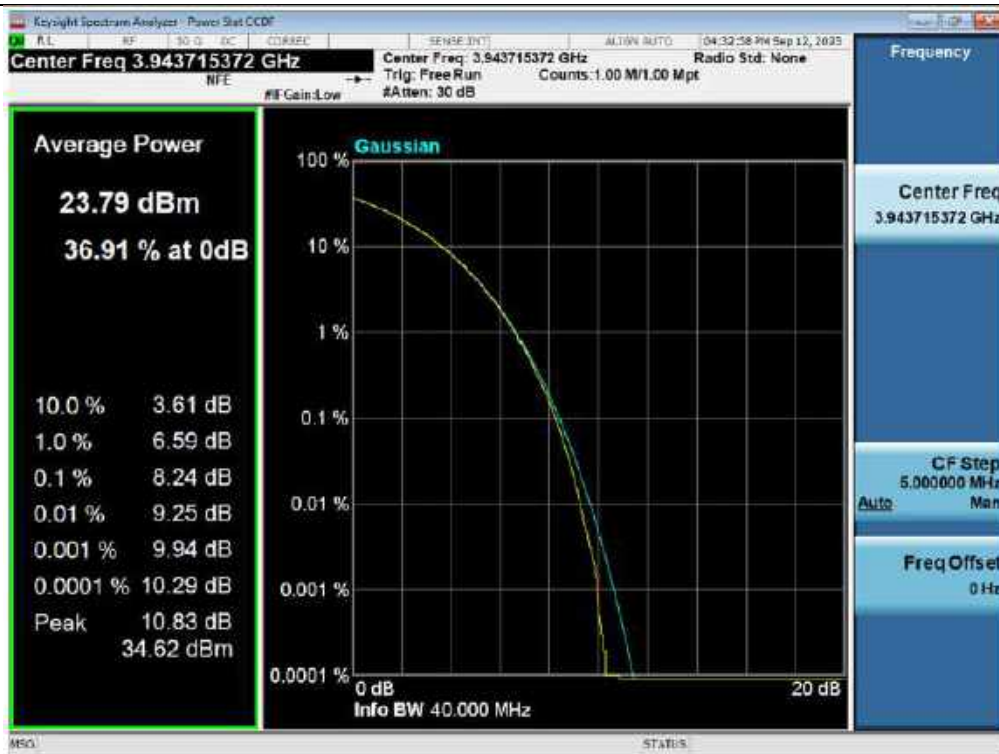

PAPR / 3.7 GHz Service (ANT 1) / Downlink / 5G NR 60 MHz

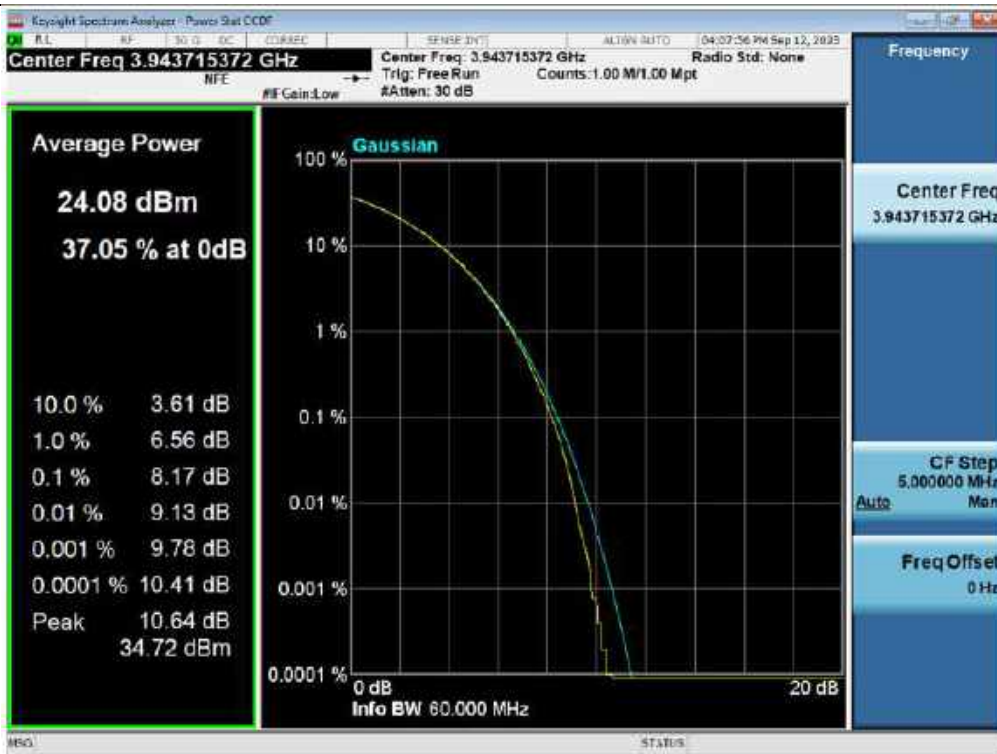

PAPR / 3.7 GHz Service (ANT 1) / Downlink / 5G NR 80 MHz

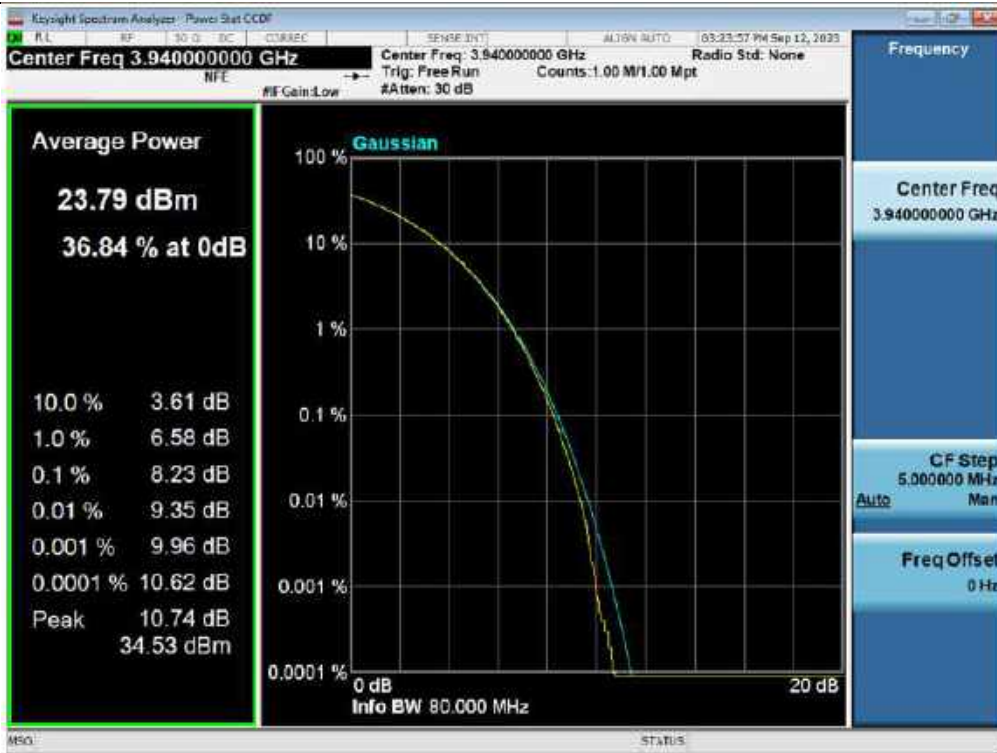

PAPR / 3.7 GHz Service (ANT 1) / Downlink / 5G NR 100 MHz

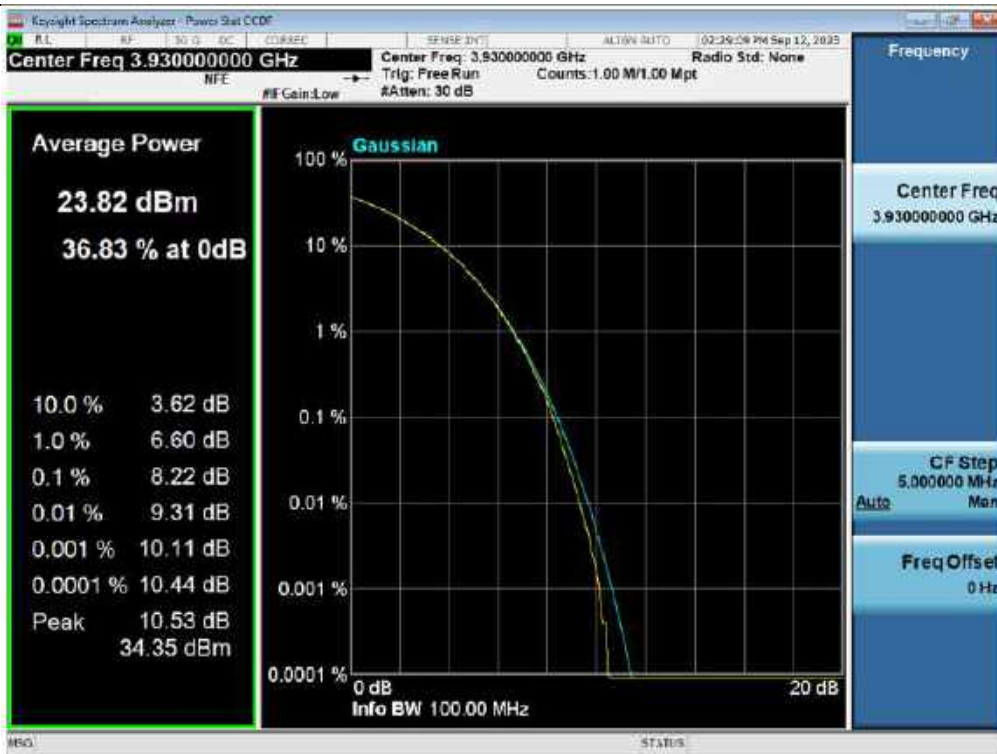

PAPR / 3.45 GHz Service (ANT 1) / Downlink / 5G NR 20 MHz



PAPR / 3.45 GHz Service (ANT 1) / Downlink / 5G NR 40 MHz

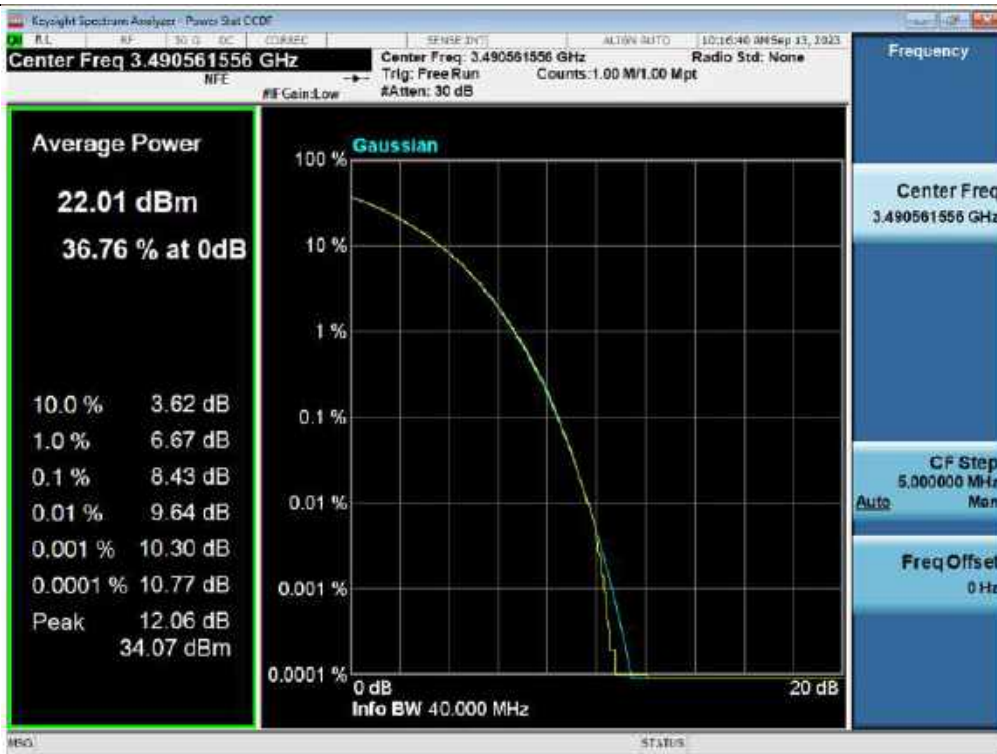

PAPR / 3.45 GHz Service (ANT 1) / Downlink / 5G NR 60 MHz



PAPR / 3.45 GHz Service (ANT 1) / Downlink / 5G NR 80 MHz

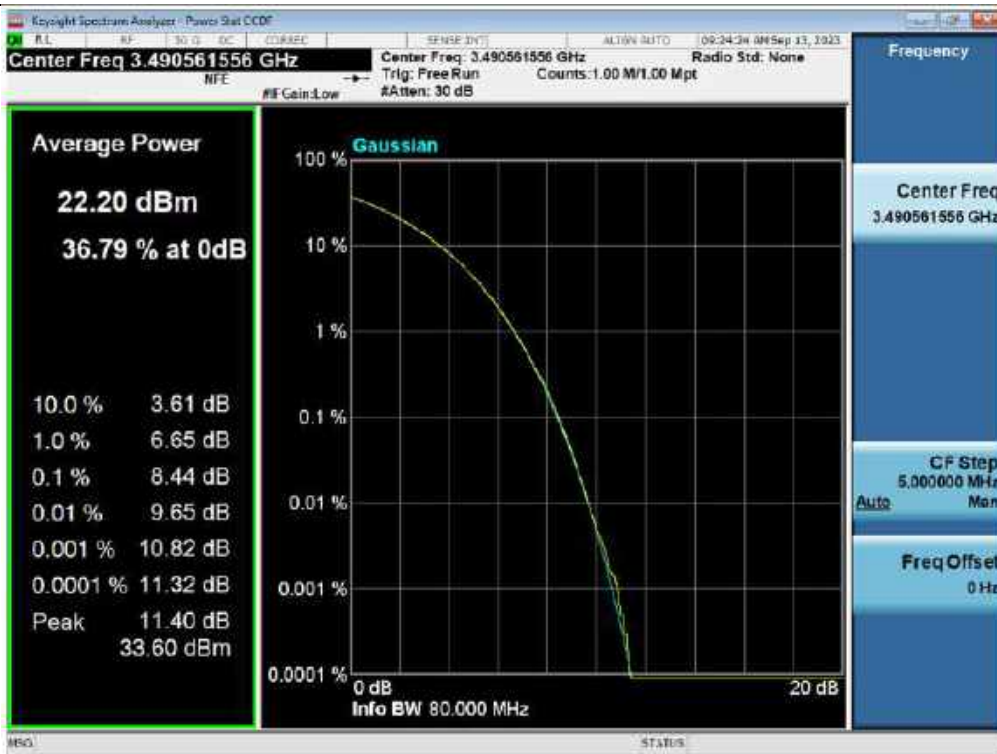

PAPR / 3.45 GHz Service (ANT 1) / Downlink / 5G NR 100 MHz

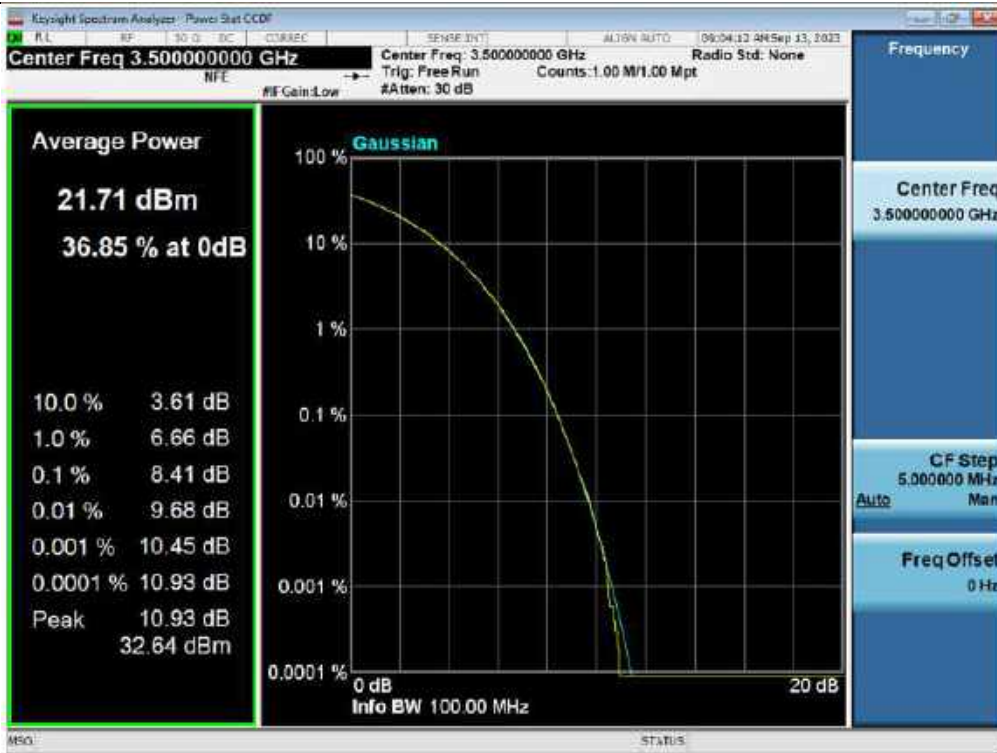

PAPR / 3.7 GHz Service (ANT 2) / Downlink / 5G NR 20 MHz

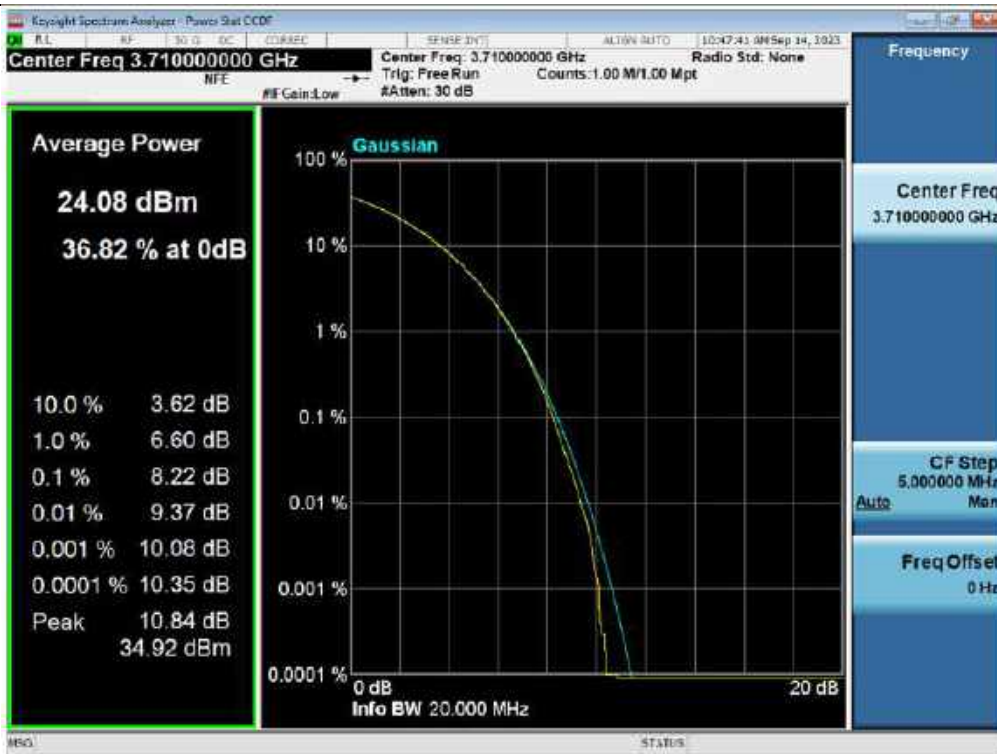

PAPR / 3.7 GHz Service (ANT 2) / Downlink / 5G NR 40 MHz



PAPR / 3.7 GHz Service (ANT 2) / Downlink / 5G NR 60 MHz

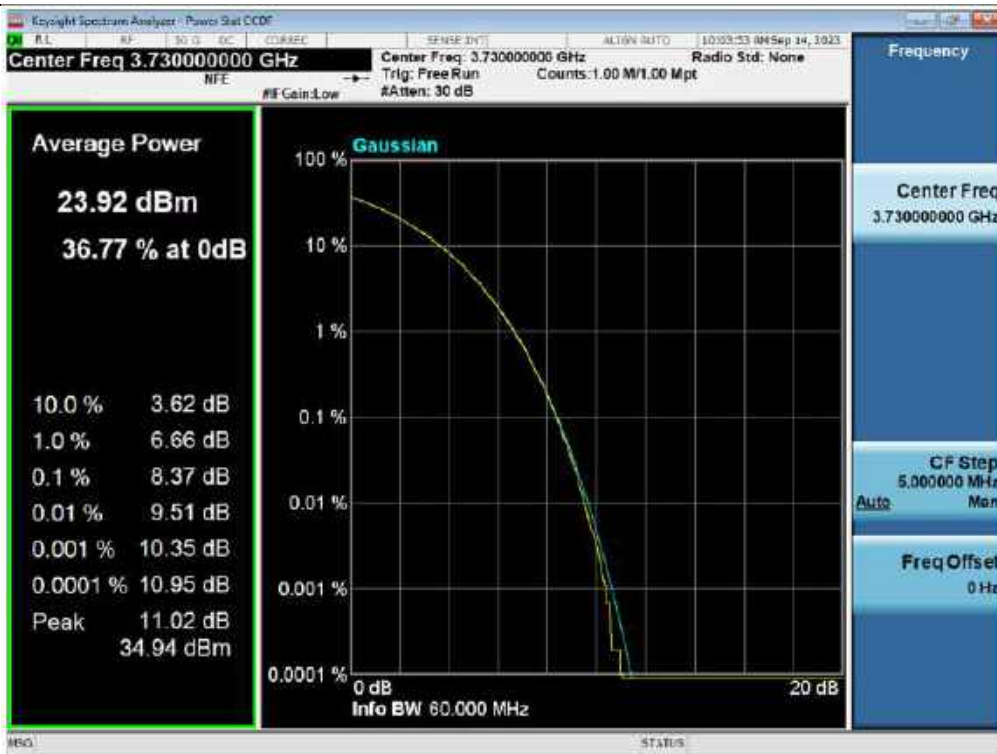

PAPR / 3.7 GHz Service (ANT 2) / Downlink / 5G NR 80 MHz

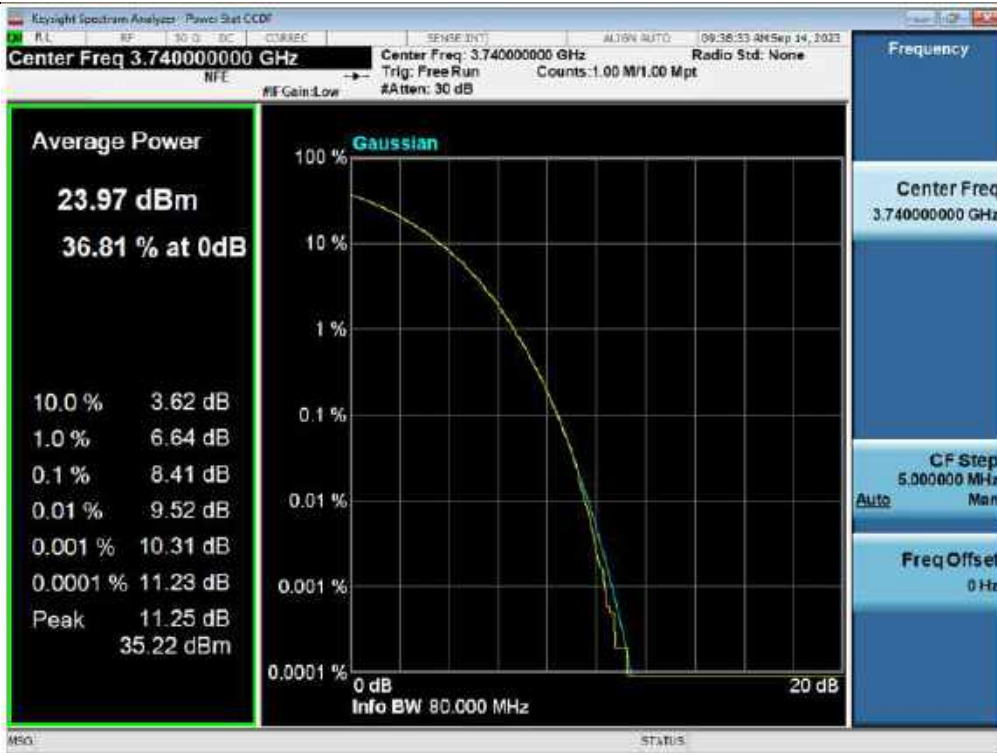

PAPR / 3.7 GHz Service (ANT 2) / Downlink / 5G NR 100 MHz

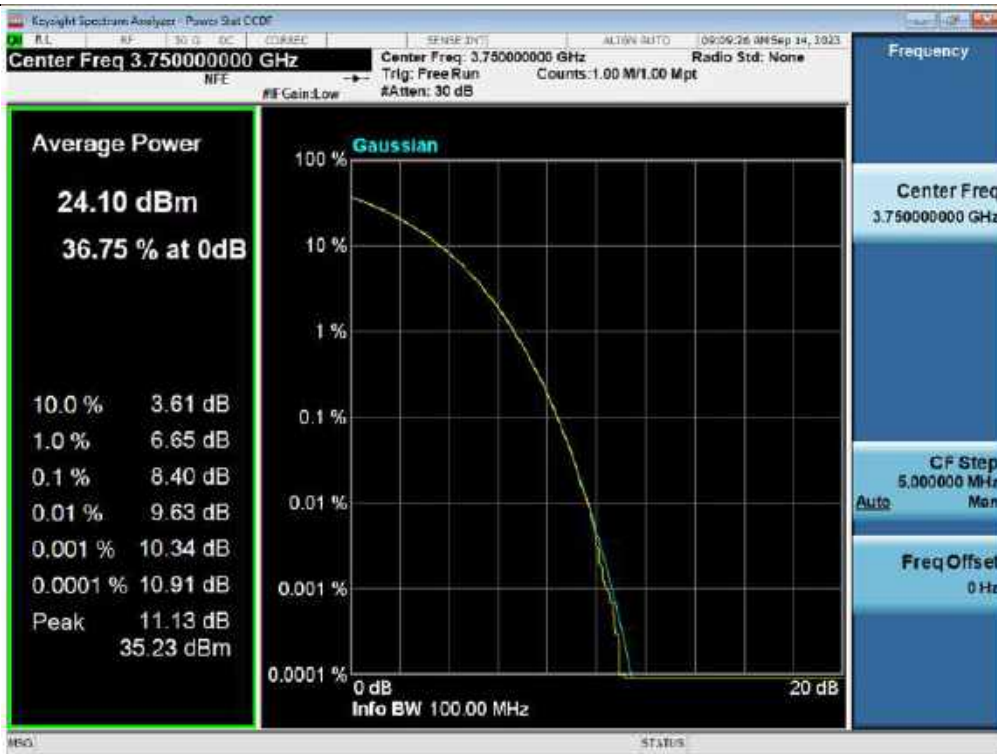

PAPR / 3.45 GHz Service (ANT 2) / Downlink / 5G NR 20 MHz



PAPR / 3.45 GHz Service (ANT 2) / Downlink / 5G NR 40 MHz

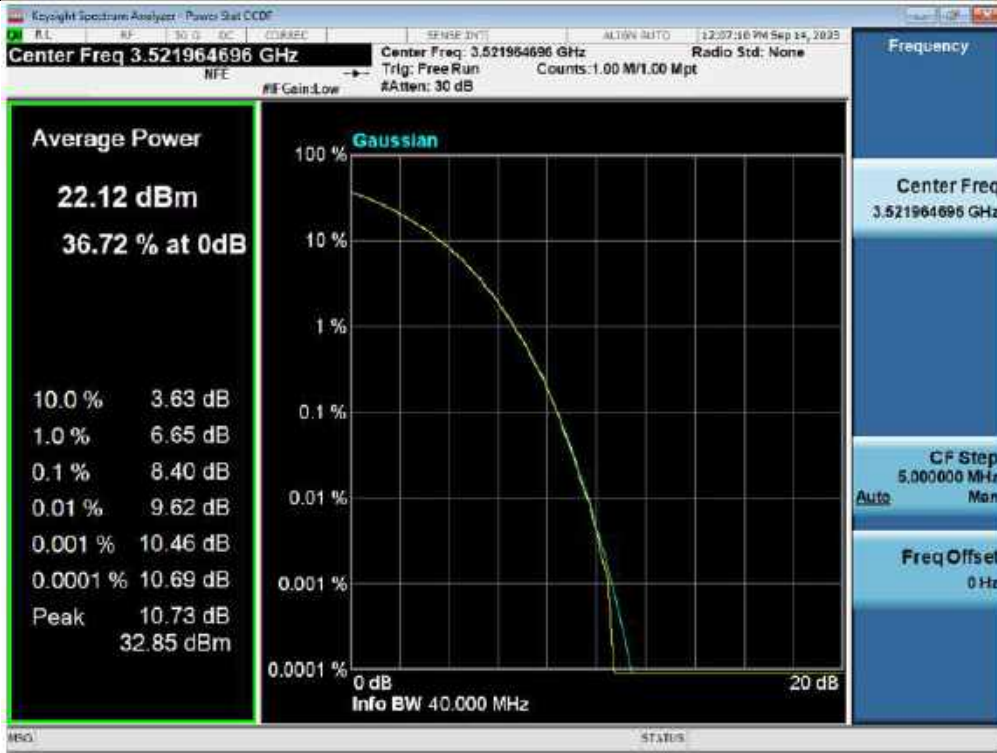

PAPR / 3.45 GHz Service (ANT 2) / Downlink / 5G NR 60 MHz

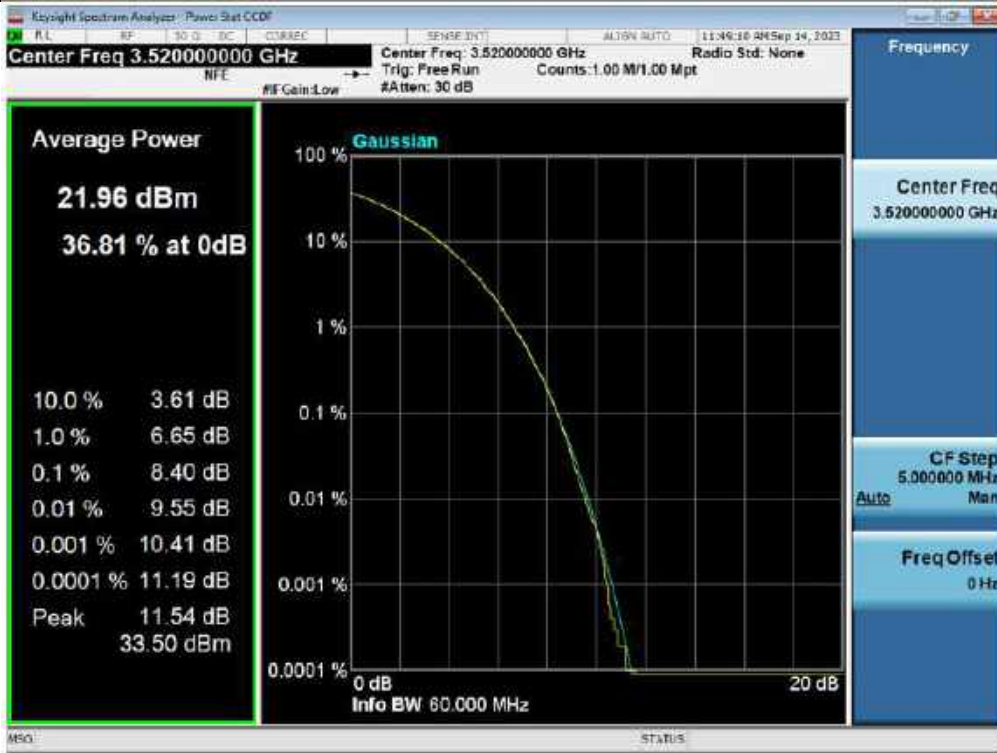

PAPR / 3.45 GHz Service (ANT 2) / Downlink / 5G NR 80 MHz

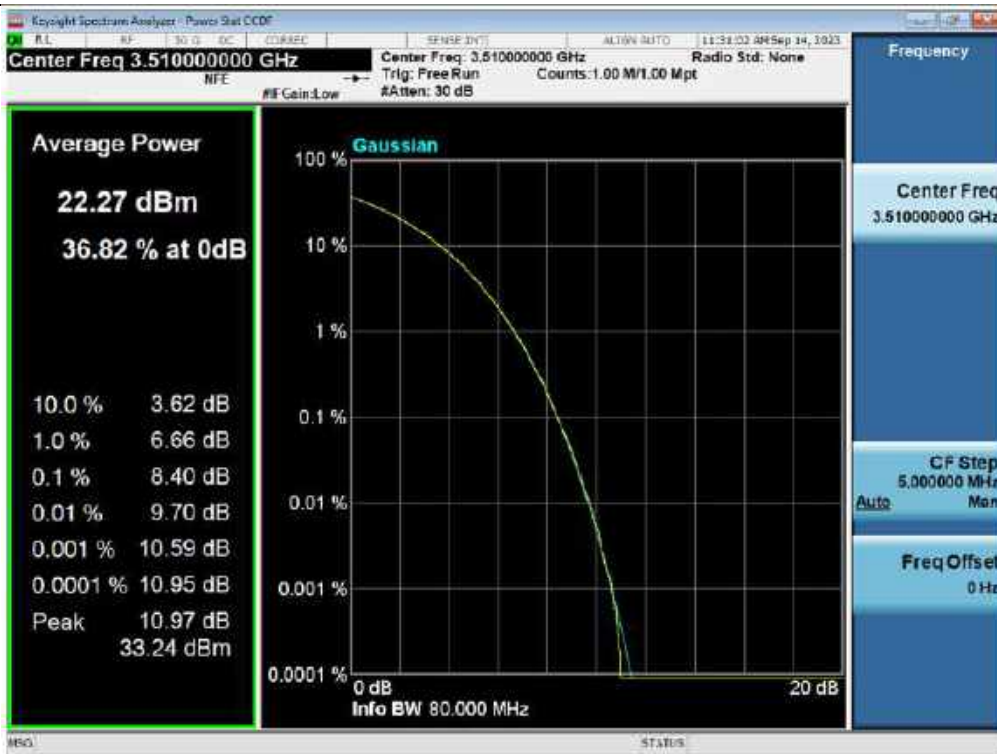

PAPR / 3.45 GHz Service (ANT 2) / Downlink / 5G NR 100 MHz



5.5. OUT-OF-BAND/OUT-OF-BLOCK EMISSIONS AND SPURIOUS EMISSIONS

Test Requirements:

§ 2.1051 Measurements required: Spurious emissions at antenna terminals:

The radio frequency voltage or powers generated within the equipment and appearing on a spurious frequency shall be checked at the equipment output terminals when properly loaded with a suitable artificial antenna. Curves or equivalent data shall show the magnitude of each harmonic and other spurious emission that can be detected when the equipment is operated under the conditions specified in § 2.1049 as appropriate. The magnitude of spurious emissions which are attenuated more than 20 dB below the permissible value need not be specified.

§ 27.53 Emission limits.

- (l) 3.7 GHz Service. The following emission limits apply to station transmitting in the 3700-3980 MHz band:
 - (1) For base station operations in the 3700-3980 MHz band, the conducted power of any emission outside the licensee's authorized bandwidth shall not exceed -13 dBm/MHz. Compliance with this paragraph (l)(1) is based on the use of measurement instrumentation employing a resolution bandwidth of 1 megahertz or greater. However, in the 1 megahertz bands immediately outside and adjacent to the licensee's frequency block, a resolution bandwidth of at least one percent of the emission bandwidth of the fundamental emission of the transmitter may be employed. The emission bandwidth is defined as the width of the signal between two points, one below the carrier center frequency and one above the carrier center frequency, outside of which all emissions are attenuated at least 26 dB below the transmitter power.

- (n) 3.45 GHz Service. The following emission limits apply to station transmitting in the 3450-3550 MHz band:
 - (1) For base station operations in the 3450-3550 MHz band, the conducted power of any emission outside the licensee's authorized bandwidth shall not exceed -13 dBm/MHz. Compliance with the provisions of this paragraph (n)(1) is based on the use of measurement instrumentation employing a resolution bandwidth of 1 megahertz or greater. However, in the 1 megahertz bands immediately outside and adjacent to the licensee's frequency block, a resolution bandwidth of at least one percent of the emission bandwidth of the fundamental emission of the transmitter may be employed, but limited to a maximum of 200 kHz. The emission bandwidth is defined as the width of the signal between two points, one below the carrier center frequency and one above the carrier center frequency, outside of which all emissions are attenuated at least 26 dB below the transmitter power. Notwithstanding the channel edge requirement of -13 dBm per megahertz, for base station operations in the 3450-3550 MHz band, the conducted power of any emission below 3440 MHz or above 3560 MHz shall not exceed -25 dBm/MHz, and the conducted power of emissions below 3430 MHz or above 3570 MHz shall not exceed -40 dBm/MHz.

Test Procedures:

Measurements were in accordance with the test methods section 3.6 of KDB 935210 D05 v01r04.

Spurious emissions shall be measured using a single test signal sequentially tuned to the low, middle, and high channels or frequencies within each authorized frequency band of operation.

Out-of-band/out-of-block emissions (including intermodulation products) shall be measured under each of the following two stimulus conditions:

- a) two adjacent test signals sequentially tuned to the lower and upper frequency band/block edges;
- b) a single test signal, sequentially tuned to the lowest and highest frequencies or channels within the frequency band/block under examination.

NOTE—Single-channel boosters that cannot accommodate two simultaneous signals within the passband may be excluded from the test stipulated in step a).

3.6.2 Out-of-band/out-of-block emissions conducted measurements

- a) Connect a signal generator to the input of the EUT.
If the signal generator is not capable of generating two modulated carriers simultaneously, then two discrete signal generators can be connected with an appropriate combining network to support this two-signal test.
- b) Set the signal generator to produce two AWGN signals as previously described.
- c) Set the center frequencies such that the AWGN signals occupy adjacent channels, as defined by industry standards such as 3GPP or 3GPP2, at the upper edge of the frequency band or block under test.
- d) Set the composite power levels such that the input signal is just below the AGC threshold, but not more than 0.5 dB below. The composite power can be measured using the procedures provided in KDB Publication 971168, but it will be necessary to expand the power integration bandwidth so as to include both of the transmit channels.
- e) Connect a spectrum analyzer to the output of the EUT using appropriate attenuation as necessary.
- f) Set the RBW = reference bandwidth in the applicable rule section for the supported frequency band.
- g) Set the VBW = $3 \times$ RBW.
- h) Set the detector to power averaging (rms) detector.
- i) Set the Sweep time = auto-couple.
- j) Set the spectrum analyzer start frequency to the upper block edge frequency, and the stop frequency to the upper block edge frequency plus 300 kHz or 3 MHz, for frequencies below and above 1 GHz, respectively.
- k) Trace average at least 100 traces in power averaging (rms) mode.
- l) Use the marker function to find the maximum power level.
- m) Capture the spectrum analyzer trace of the power level for inclusion in the test report.
- n) Repeat steps k) to m) with the composite input power level set to 3 dB above the AGC threshold.
- o) Reset the frequencies of the input signals to the lower edge of the frequency block or band under test.
- p) Reset the spectrum analyzer start frequency to the lower block edge frequency minus 300 kHz or 3 MHz, for frequencies below and above 1 GHz, respectively, and the stop frequency to the lower band or block edge frequency.

- q) Repeat steps k) to n).
- r) Repeat steps a) to q) with the signal generator configured for a single test signal tuned as close as possible to the block edges.
- s) Repeat steps a) to r) with the narrowband test signal.
- t) Repeat steps a) to s) for all authorized frequency bands or blocks used by the EUT.

3.6.3 Spurious emissions conducted measurements

- a) Connect a signal generator to the input of the EUT.
- b) Set the signal generator to produce the broadband test signal as previously described.
- c) Set the center frequency of the test signal to the lowest available channel within the frequency band or block.
- d) Set the EUT input power to a level that is just below the AGC threshold, but not more than 0.5 dB below.
- e) Connect a spectrum analyzer to the output of the EUT using appropriate attenuation as necessary.
- f) Set the RBW = reference bandwidth in the applicable rule section for the supported frequency band of operation.
- g) Set the VBW $\geq 3 \times$ RBW.
- h) Set the Sweep time = auto-couple.
- i) Set the spectrum analyzer start frequency to the lowest RF signal generated in the equipment, without going below 9 kHz, and the stop frequency to the lower band/block edge frequency minus 1 MHz.
The number of measurement points in each sweep must be $\geq (2 \times \text{span}/\text{RBW})$, which may require that the measurement range defined by the start and stop frequencies be subdivided, depending on the available number of measurement points provided by the spectrum analyzer.
- j) Select the power averaging (rms) detector function.
- k) Trace average at least 10 traces in power averaging (rms) mode.
- l) Use the peak marker function to identify the highest amplitude level over each measured frequency range. Record the frequency and amplitude and capture a plot for inclusion in the test report.
- m) Reset the spectrum analyzer start frequency to the upper band/block edge frequency plus 1 MHz, and the spectrum analyzer stop frequency to 10 times the highest frequency of the fundamental emission. The number of measurement points in each sweep must be $\geq (2 \times \text{span}/\text{RBW})$, which may require that the measurement range defined by the start and stop frequencies be subdivided, depending on the available number of measurement points provided by the spectrum analyzer.
- n) Trace average at least 10 traces in power averaging (rms) mode.
- o) Use the peak marker function to identify the highest amplitude level over each of the measured frequency ranges. Record the frequency and amplitude and capture a plot for inclusion in the test report; also provide tabular data, if required.
- p) Repeat steps i) to o) with the input test signals firstly tuned to a middle band/block frequency/channel, and then tuned to a high band/block frequency/channel.
- q) Repeat steps b) to p) with the narrowband test signal.
- r) Repeat steps b) to q) for all authorized frequency bands/blocks used by the EUT.

Note:

1. In some bands, RBW was reduced to 0.1 %, 1 %, and 10 % of the reference bandwidth for measuring out-of-band and unwanted spurious emissions level, so the limit lines were compensated according to section 5.7.2 of ANSI C63.26-2015.

Reduced RBW	0.1 %	1 %	10 %
Limit line compensation	-30 dB	-20 dB	-10 dB

2. We applied MIMO Limit Values because they are the worst according to KDB 662911 D01 v02r01.

- 2Tx MIMO correction: $10 \log(NANT) = 10 \log(2) = 3.01 \text{ dB}$
- 13 dBm/MHz - $10 \log(2) = -16.01 \text{ dBm/MHz}$
- 25 dBm/MHz - $10 \log(2) = -28.01 \text{ dBm/MHz}$
- 40 dBm/MHz - $10 \log(2) = -43.01 \text{ dBm/MHz}$



Test Results: Plot data of Out-of-band/out-of-block emissions

Out-of-band (two adjacent test signals) / 3.7 GHz Service (ANT 1) / Downlink / 5G NR 20 MHz / Lower

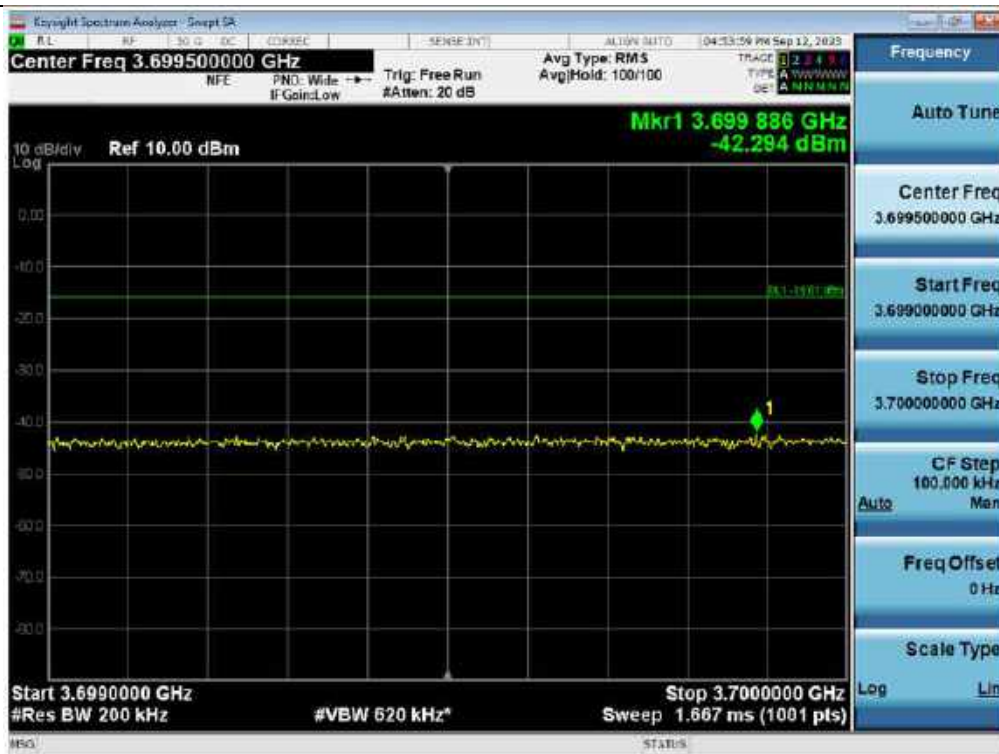

Out-of-band (two adjacent test signals) / 3.7 GHz Service (ANT 1) / Downlink / 5G NR 20 MHz / Upper



3 dB above Out-of-band (two adjacent test signals) / 3.7 GHz Service (ANT 1) / Downlink / 5G NR 20 MHz / Lower



3 dB above Out-of-band (two adjacent test signals) / 3.7 GHz Service (ANT 1) / Downlink / 5G NR 20 MHz / Upper

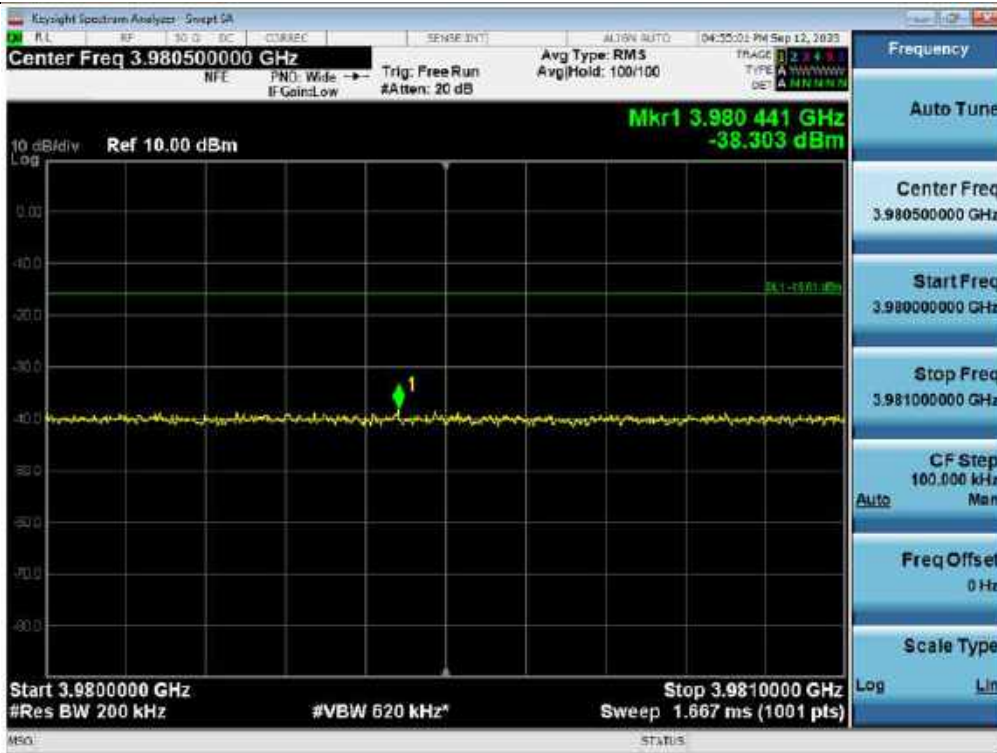

Out-of-band (two adjacent test signals) / 3.7 GHz Service (ANT 1) / Downlink / 5G NR 40 MHz / Lower

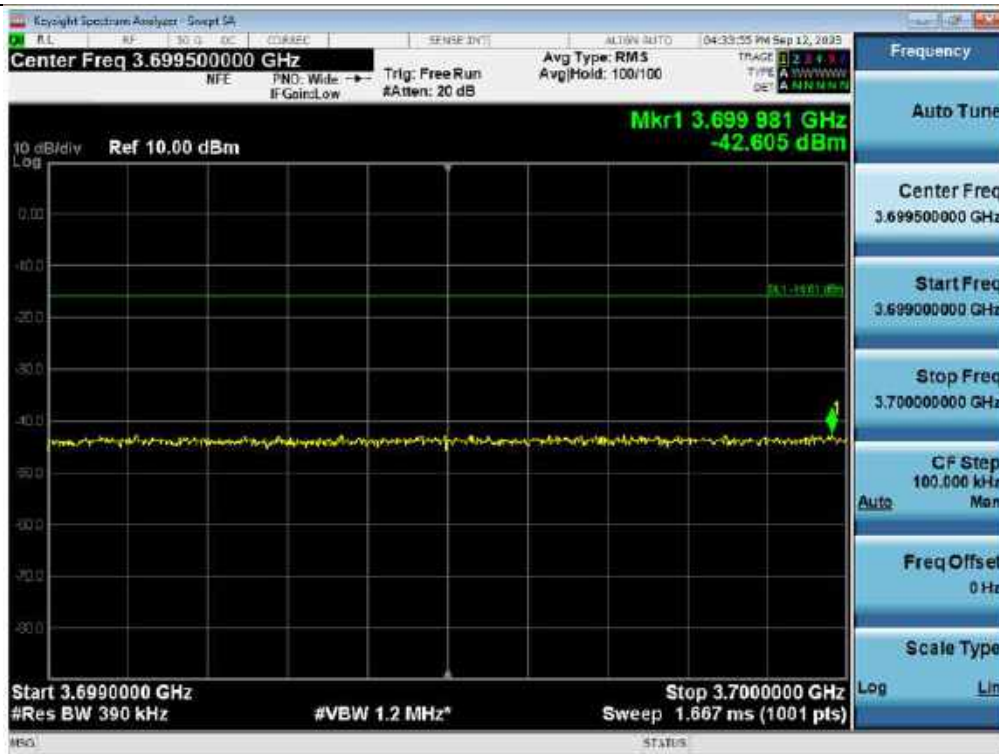

Out-of-band (two adjacent test signals) / 3.7 GHz Service (ANT 1) / Downlink / 5G NR 40 MHz / Upper

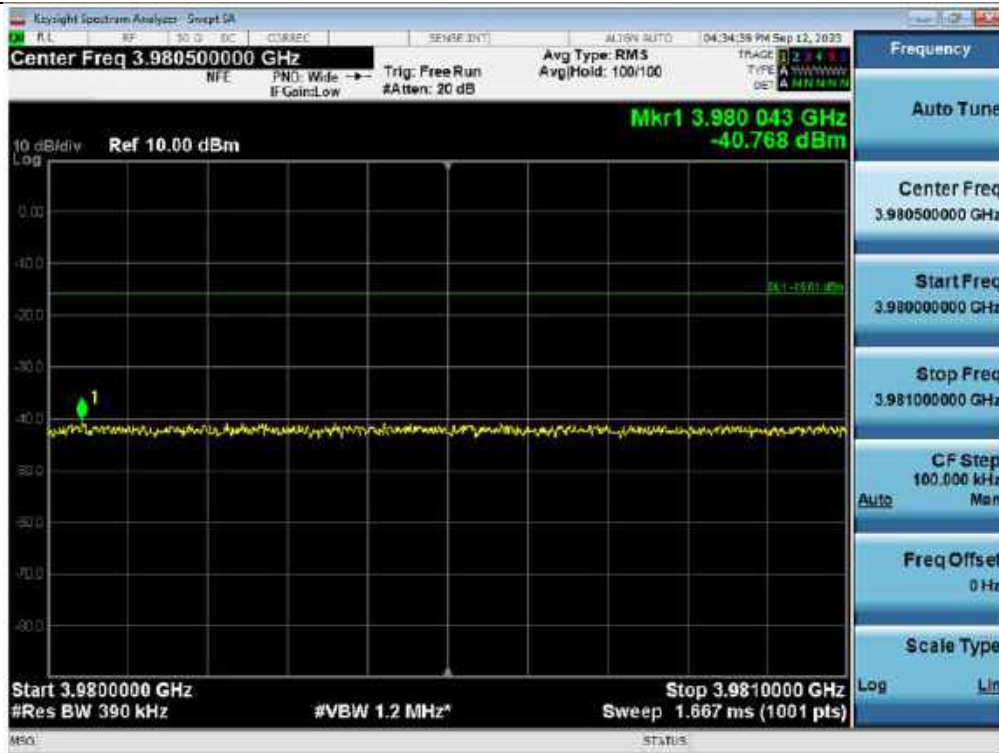

3 dB above Out-of-band (two adjacent test signals) / 3.7 GHz Service (ANT 1) / Downlink / 5G NR 40 MHz / Lower

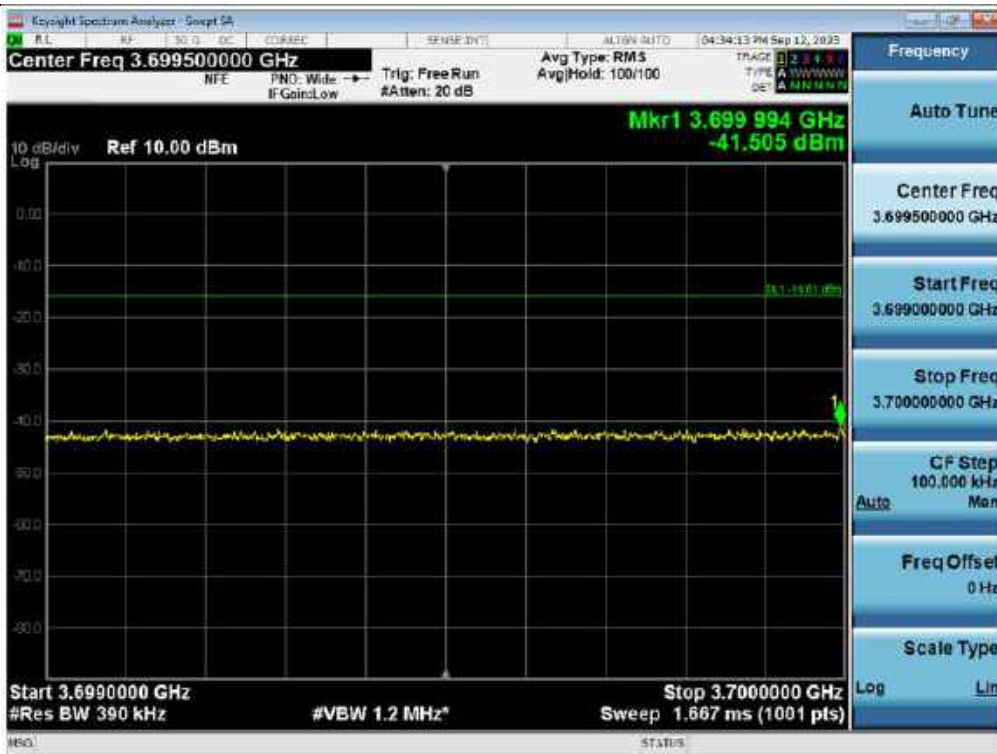

3 dB above Out-of-band (two adjacent test signals) / 3.7 GHz Service (ANT 1) / Downlink / 5G NR 40 MHz / Upper

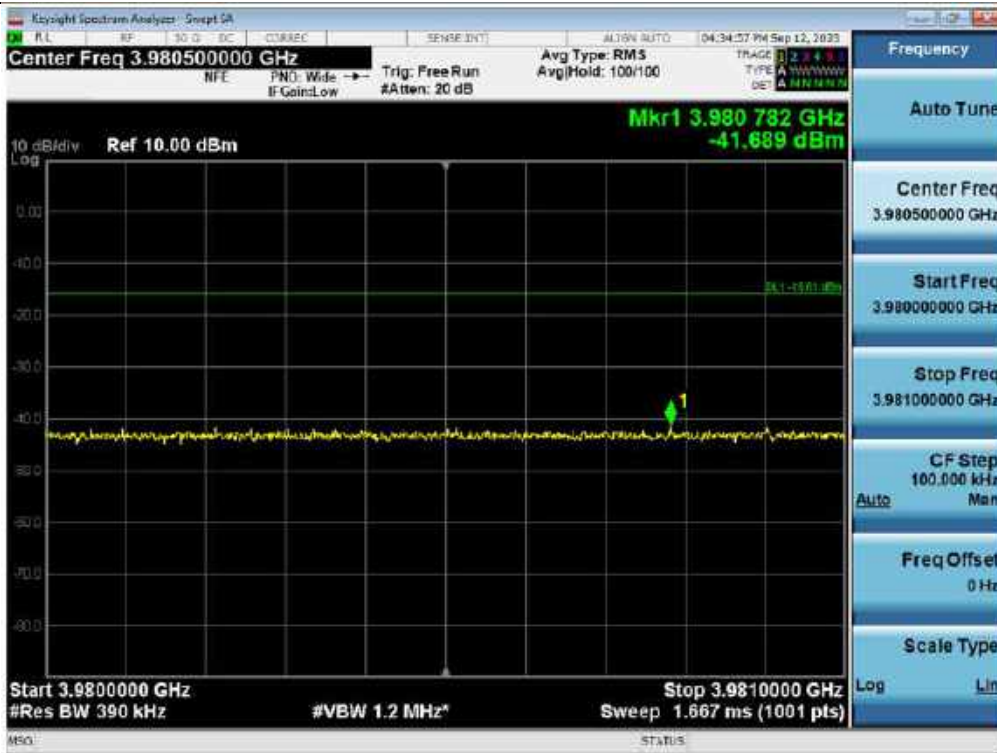

Out-of-band (two adjacent test signals) / 3.7 GHz Service (ANT 1) / Downlink / 5G NR 60 MHz / Lower

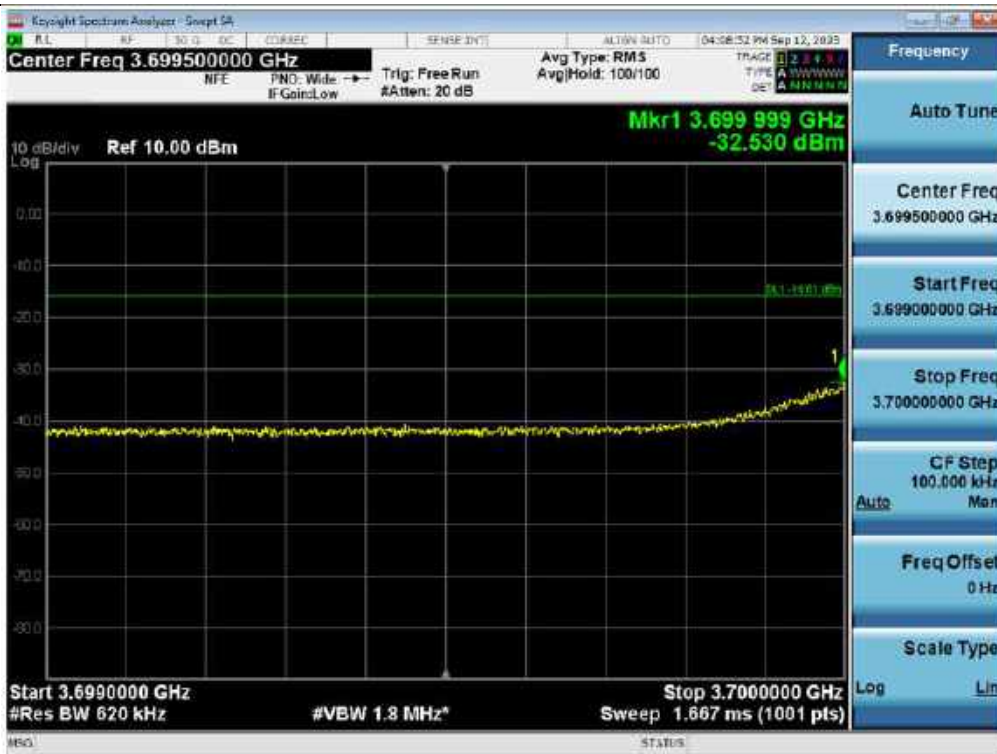

Out-of-band (two adjacent test signals) / 3.7 GHz Service (ANT 1) / Downlink / 5G NR 60 MHz / Upper



3 dB above Out-of-band (two adjacent test signals) / 3.7 GHz Service (ANT 1) / Downlink / 5G NR 60 MHz / Lower



3 dB above Out-of-band (two adjacent test signals) / 3.7 GHz Service (ANT 1) / Downlink / 5G NR 60 MHz / Upper

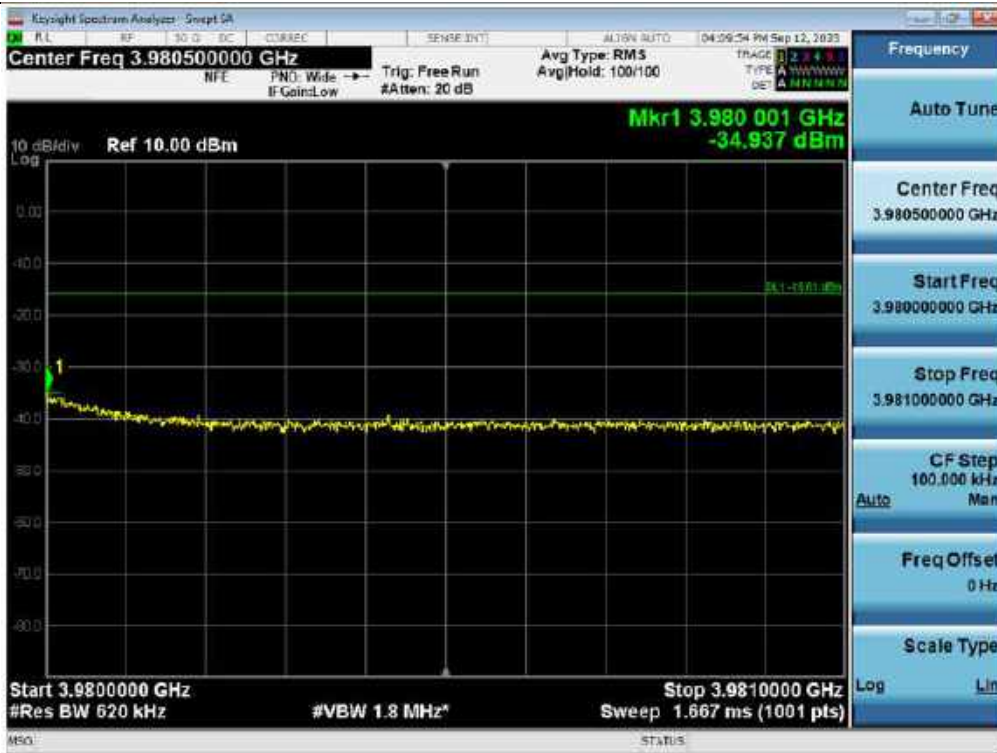

Out-of-band (two adjacent test signals) / 3.7 GHz Service (ANT 1) / Downlink / 5G NR 80 MHz / Lower



Out-of-band (two adjacent test signals) / 3.7 GHz Service (ANT 1) / Downlink / 5G NR 80 MHz / Upper

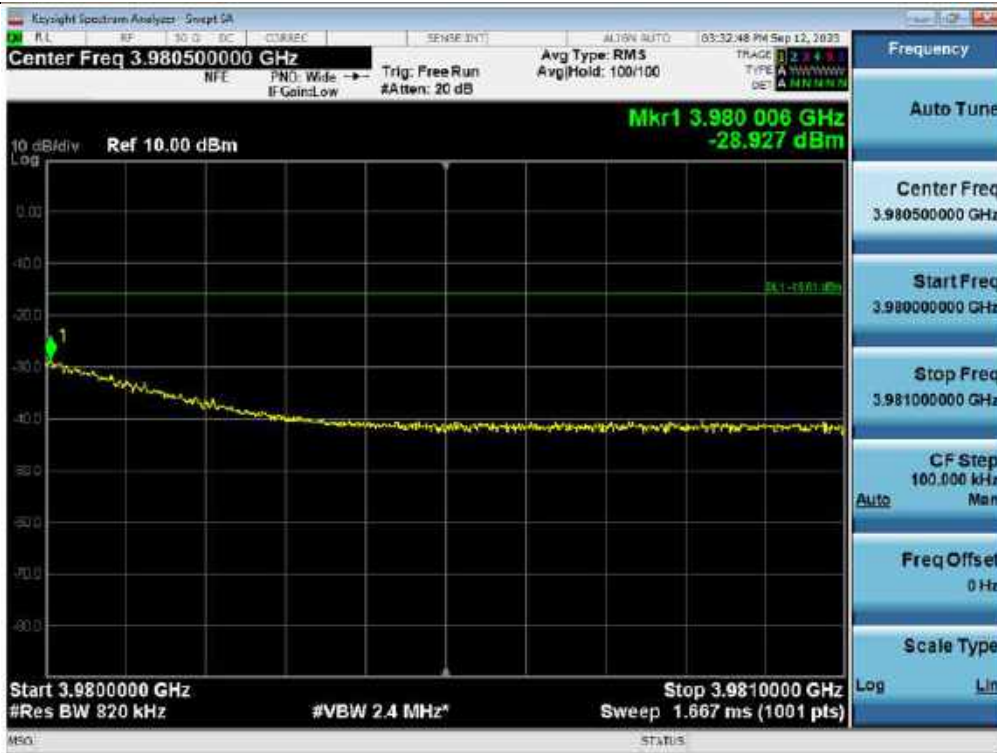

3 dB above Out-of-band (two adjacent test signals) / 3.7 GHz Service (ANT 1) / Downlink / 5G NR 80 MHz / Lower



3 dB above Out-of-band (two adjacent test signals) / 3.7 GHz Service (ANT 1) / Downlink / 5G NR 80 MHz / Upper

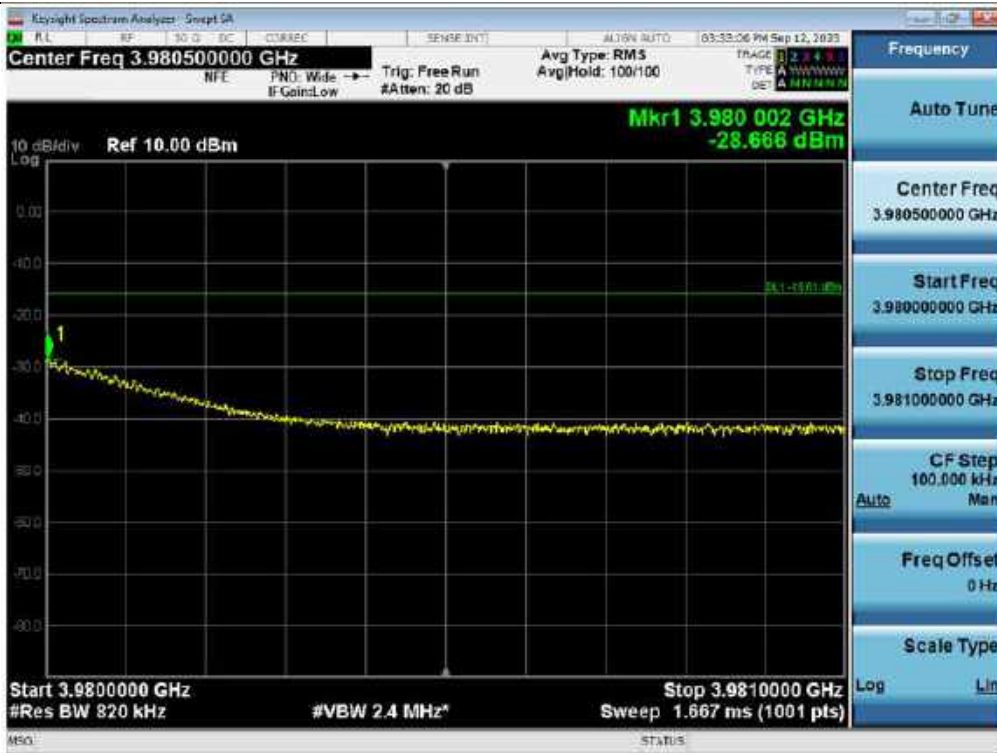

Out-of-band (two adjacent test signals) / 3.7 GHz Service (ANT 1) / Downlink / 5G NR 100 MHz / Lower

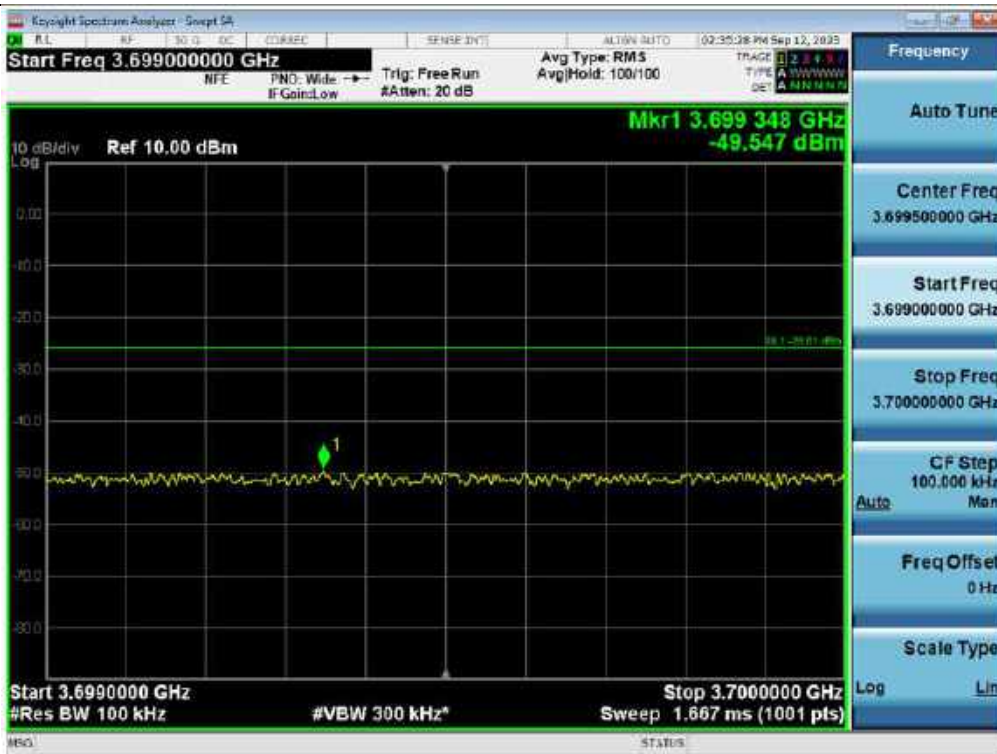

Out-of-band (two adjacent test signals) / 3.7 GHz Service (ANT 1) / Downlink / 5G NR 100 MHz / Upper



3 dB above Out-of-band (two adjacent test signals) / 3.7 GHz Service (ANT 1) / Downlink / 5G NR 100 MHz / Lower

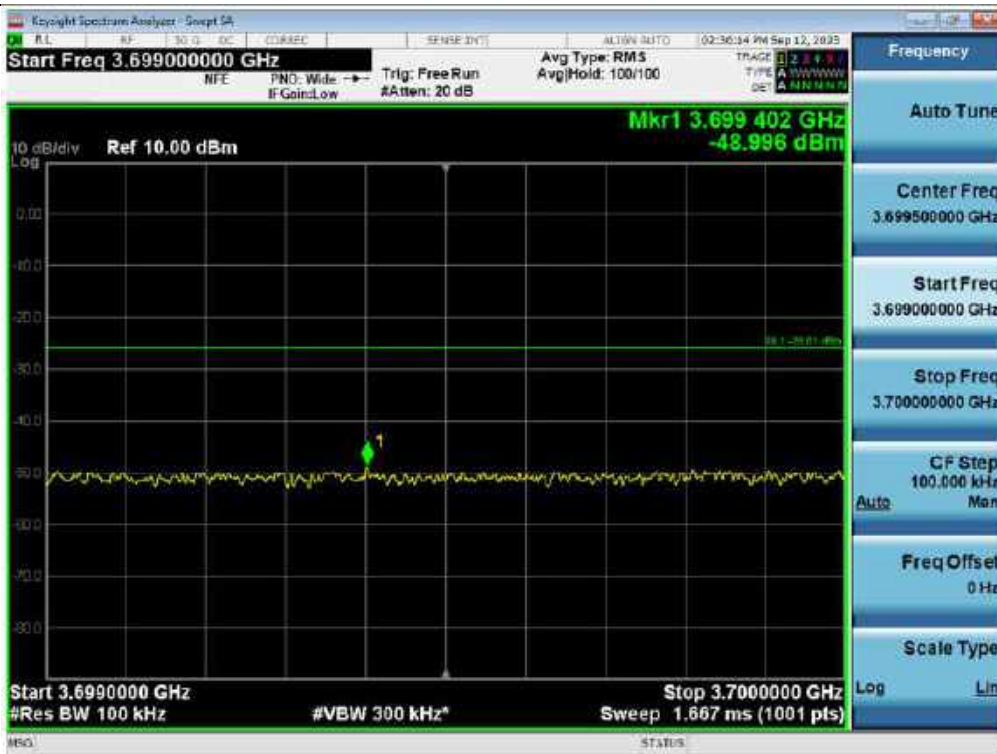

3 dB above Out-of-band (two adjacent test signals) / 3.7 GHz Service (ANT 1) / Downlink / 5G NR 100 MHz / Upper



Out-of-band (two adjacent test signals) / 3.45 GHz Service (ANT 1) / Downlink / 5G NR 20 MHz / Lower



Out-of-band (two adjacent test signals) / 3.45 GHz Service (ANT 1) / Downlink / 5G NR 20 MHz / Upper



3 dB above Out-of-band (two adjacent test signals) / 3.45 GHz Service (ANT 1) / Downlink / 5G NR 20 MHz / Lower



3 dB above Out-of-band (two adjacent test signals) / 3.45 GHz Service (ANT 1) / Downlink / 5G NR 20 MHz / Upper



Out-of-band (two adjacent test signals) / 3.45 GHz Service (ANT 1) / Downlink / 5G NR 40 MHz / Lower



Out-of-band (two adjacent test signals) / 3.45 GHz Service (ANT 1) / Downlink / 5G NR 40 MHz / Upper



3 dB above Out-of-band (two adjacent test signals) / 3.45 GHz Service (ANT 1) / Downlink / 5G NR 40 MHz / Lower



3 dB above Out-of-band (two adjacent test signals) / 3.45 GHz Service (ANT 1) / Downlink / 5G NR 40 MHz / Upper

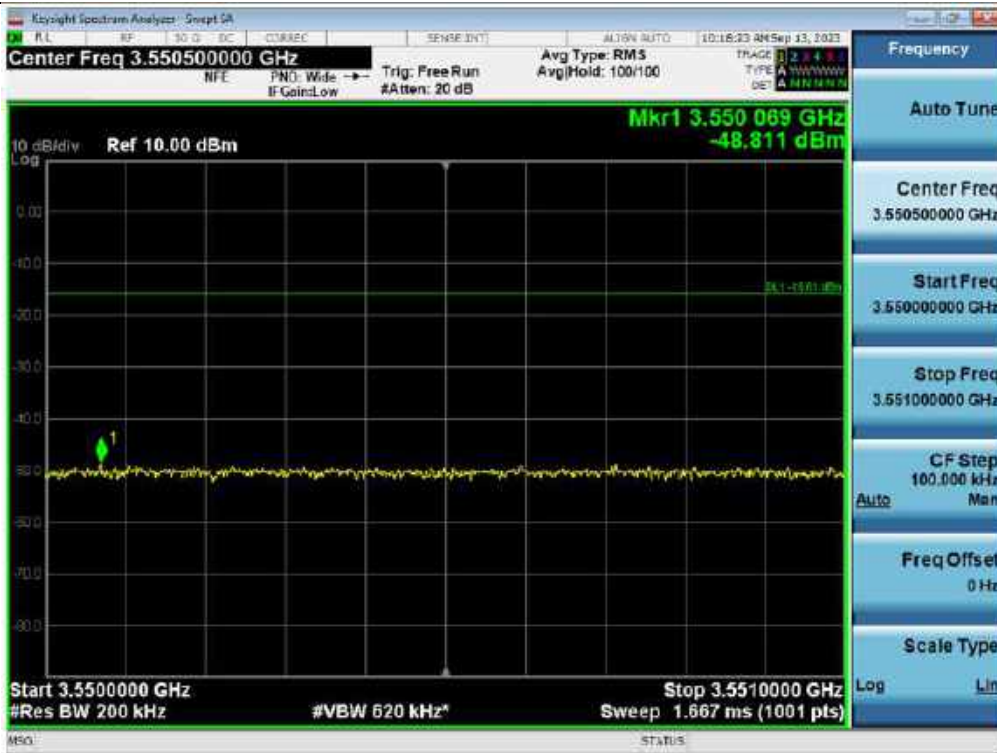

Out-of-band (single test signal) / 3.7 GHz Service (ANT 1) / Downlink / 5G NR 20 MHz / Lower

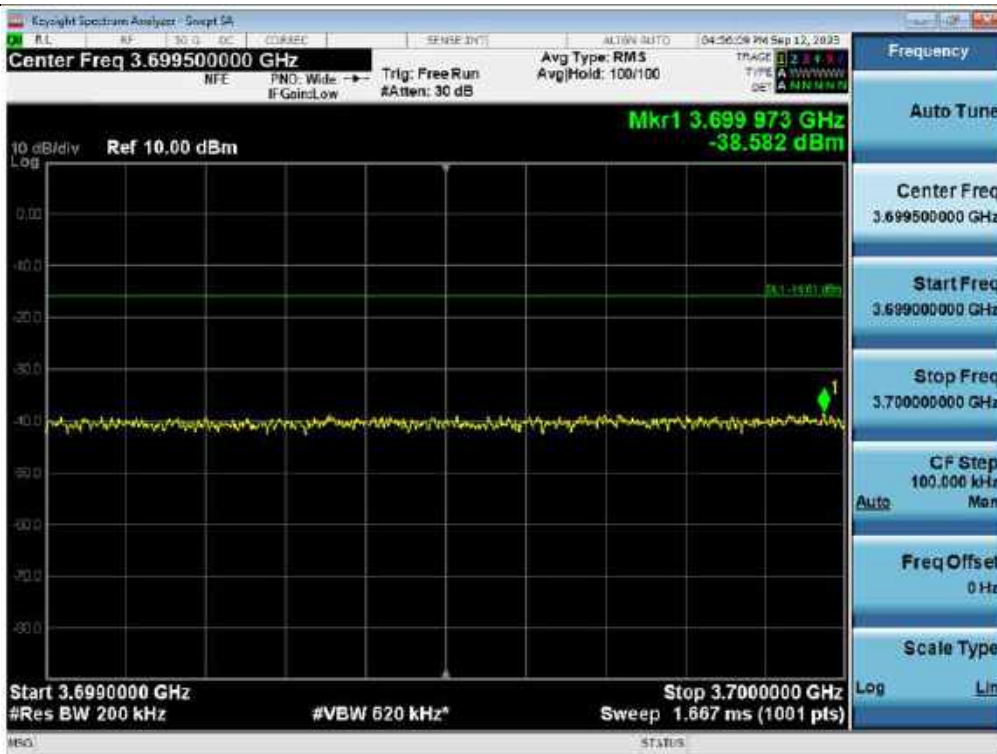

Out-of-band (single test signal) / 3.7 GHz Service (ANT 1) / Downlink / 5G NR 20 MHz / Upper

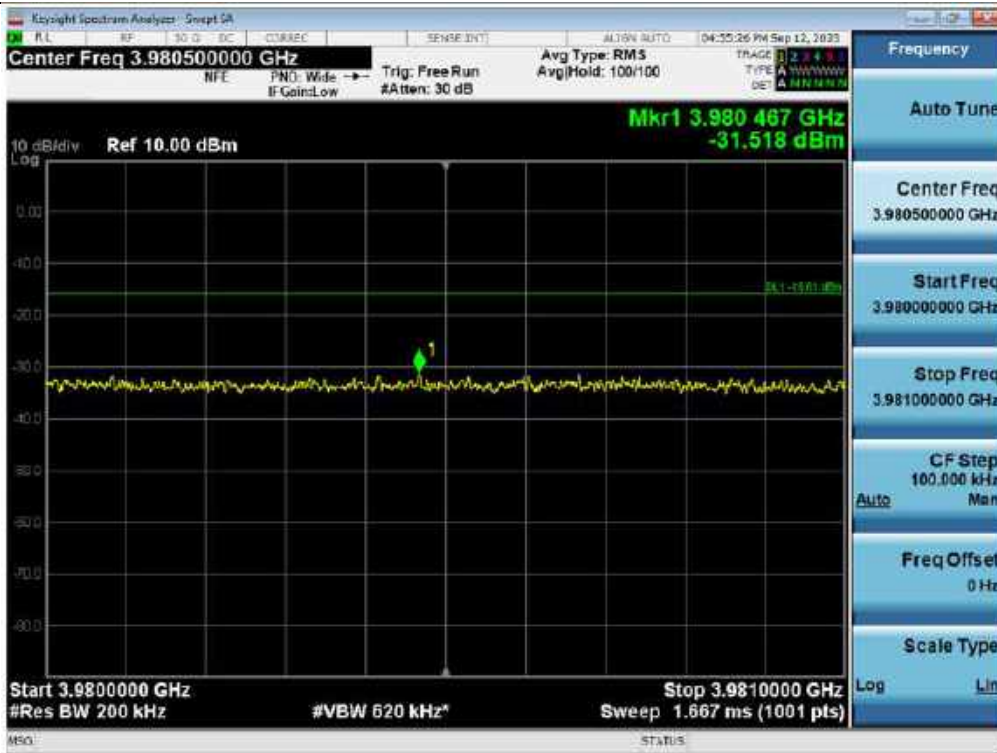

+3 dB above Out-of-band (single test signal) / 3.7 GHz Service (ANT 1) / Downlink / 5G NR 20 MHz / Lower

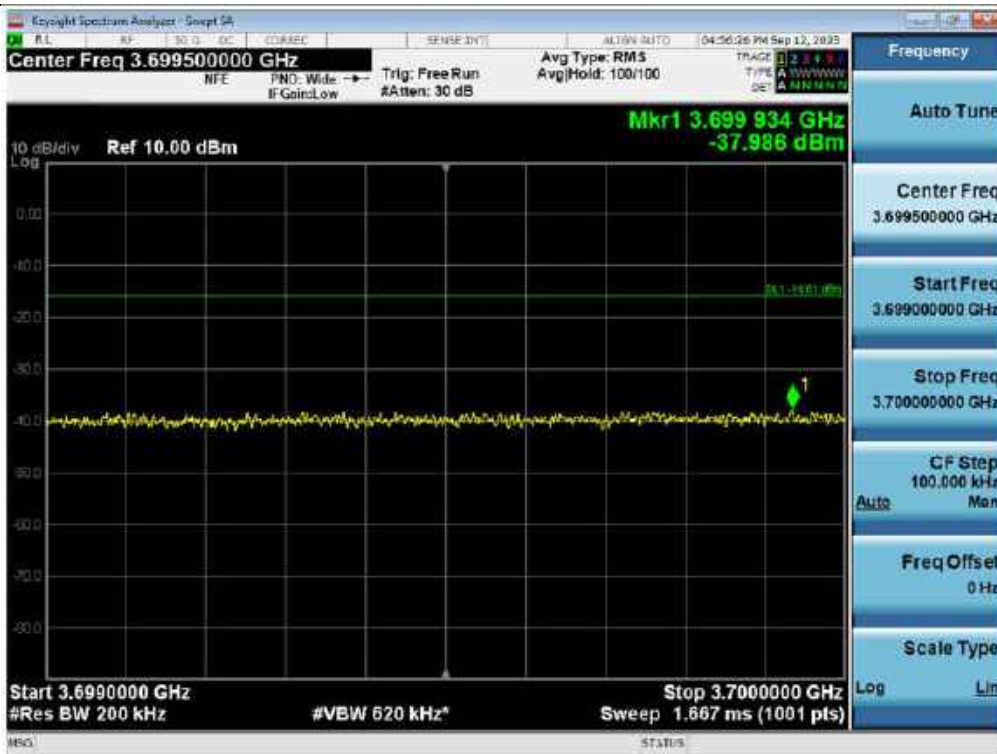

+3 dB above Out-of-band (single test signal) / 3.7 GHz Service (ANT 1) / Downlink / 5G NR 20 MHz / Upper

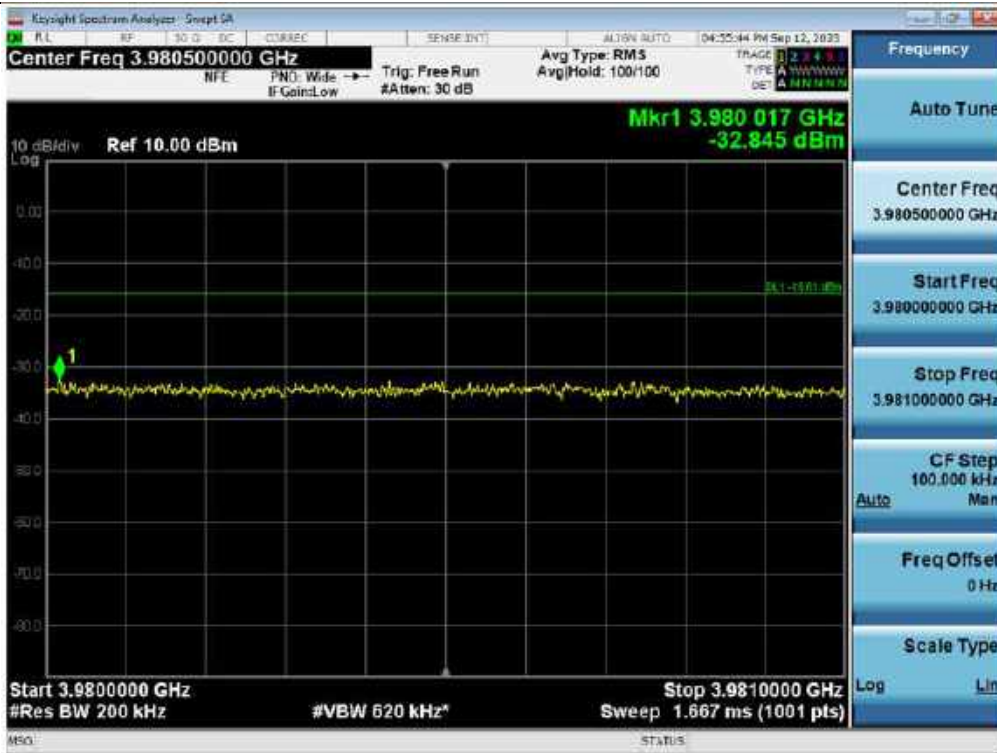

Out-of-band (single test signal) / 3.7 GHz Service (ANT 1) / Downlink / 5G NR 40 MHz / Lower



Out-of-band (single test signal) / 3.7 GHz Service (ANT 1) / Downlink / 5G NR 40 MHz / Upper

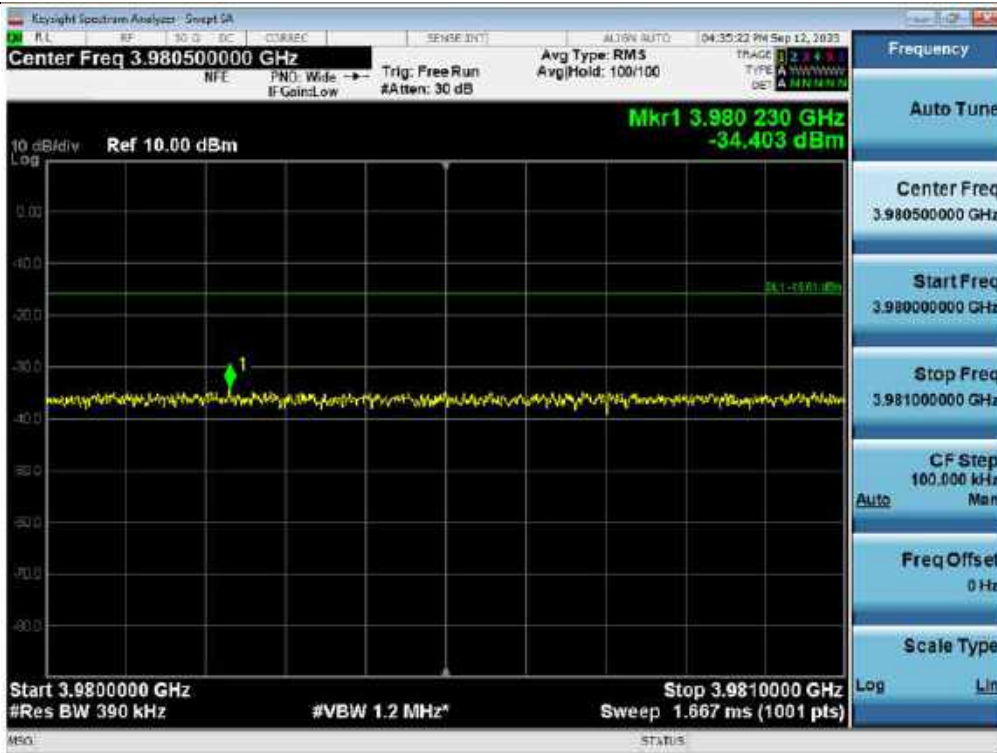

+3 dB above Out-of-band (single test signal) / 3.7 GHz Service (ANT 1) / Downlink / 5G NR 40 MHz / Lower

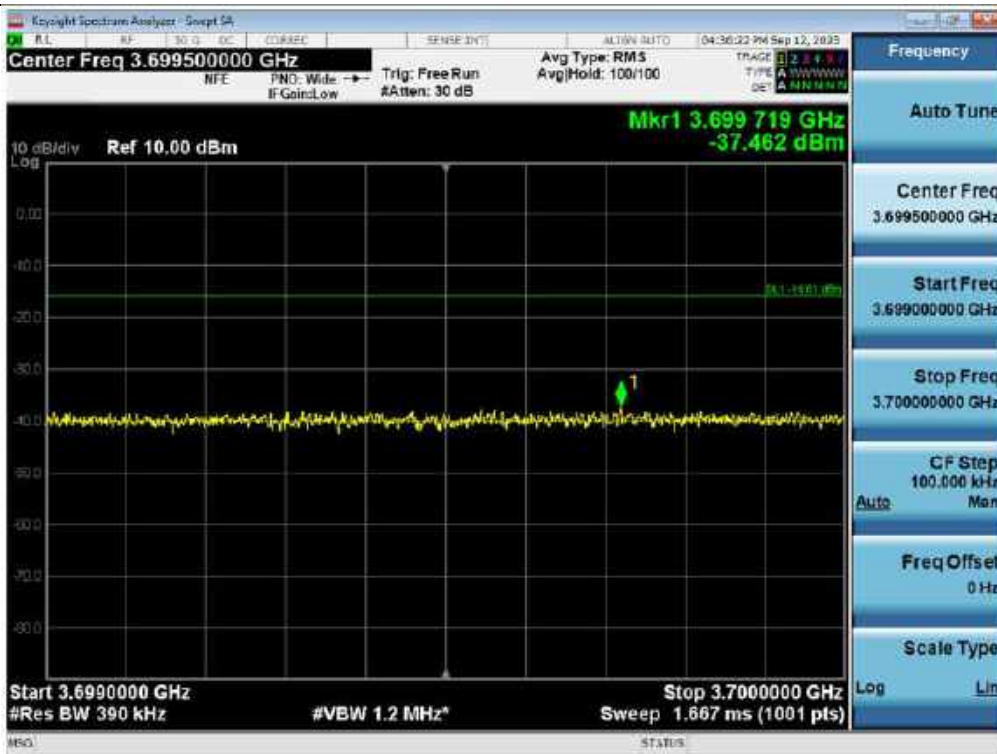

+3 dB above Out-of-band (single test signal) / 3.7 GHz Service (ANT 1) / Downlink / 5G NR 40 MHz / Upper

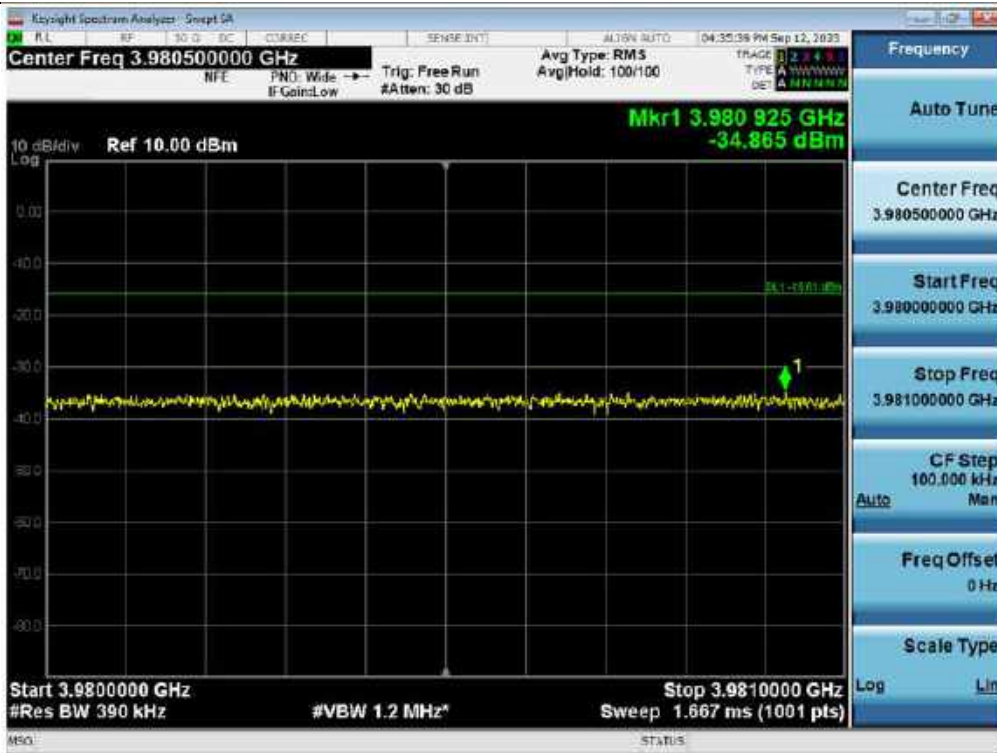

Out-of-band (single test signal) / 3.7 GHz Service (ANT 1) / Downlink / 5G NR 60 MHz / Lower



Out-of-band (single test signal) / 3.7 GHz Service (ANT 1) / Downlink / 5G NR 60 MHz / Upper

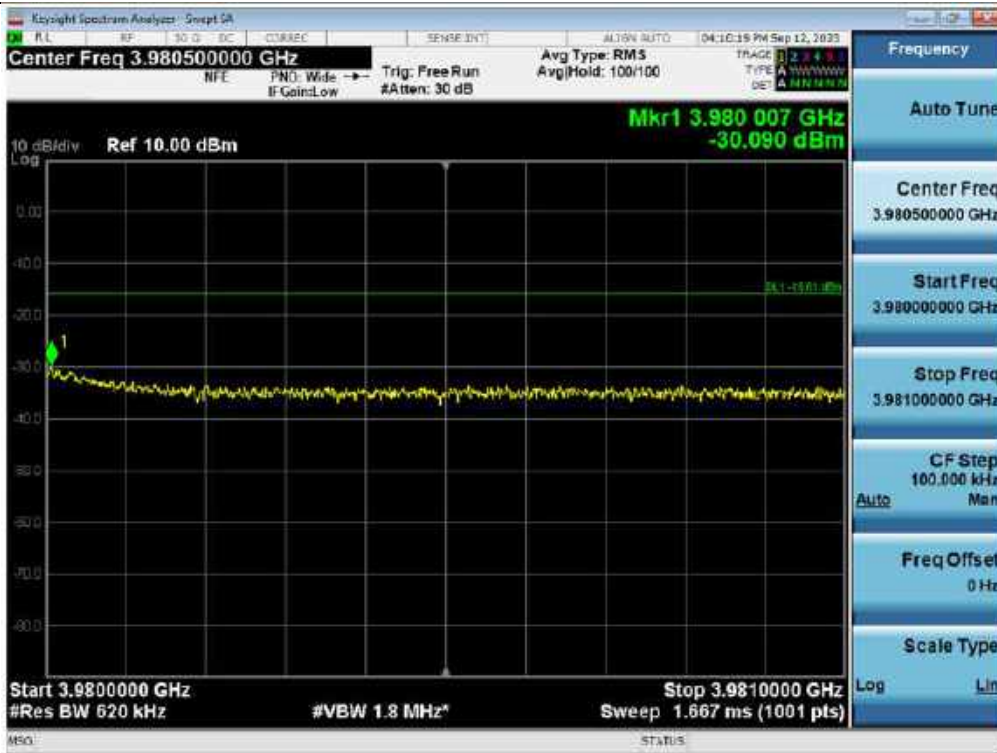

+3 dB above Out-of-band (single test signal) / 3.7 GHz Service (ANT 1) / Downlink / 5G NR 60 MHz / Lower

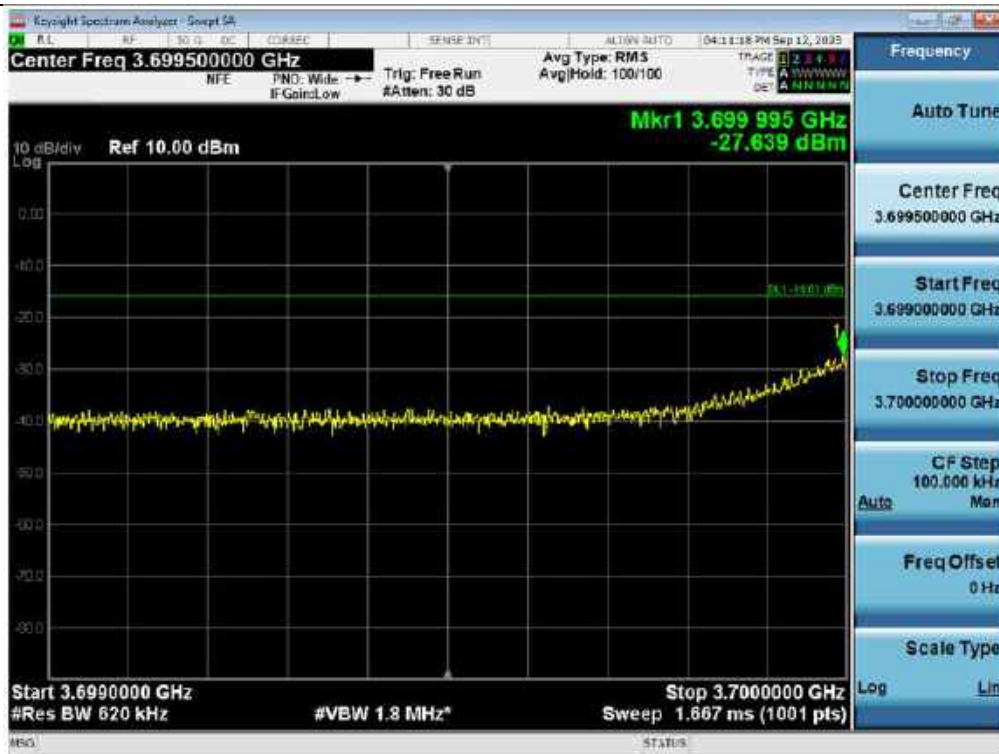

+3 dB above Out-of-band (single test signal) / 3.7 GHz Service (ANT 1) / Downlink / 5G NR 60 MHz / Upper

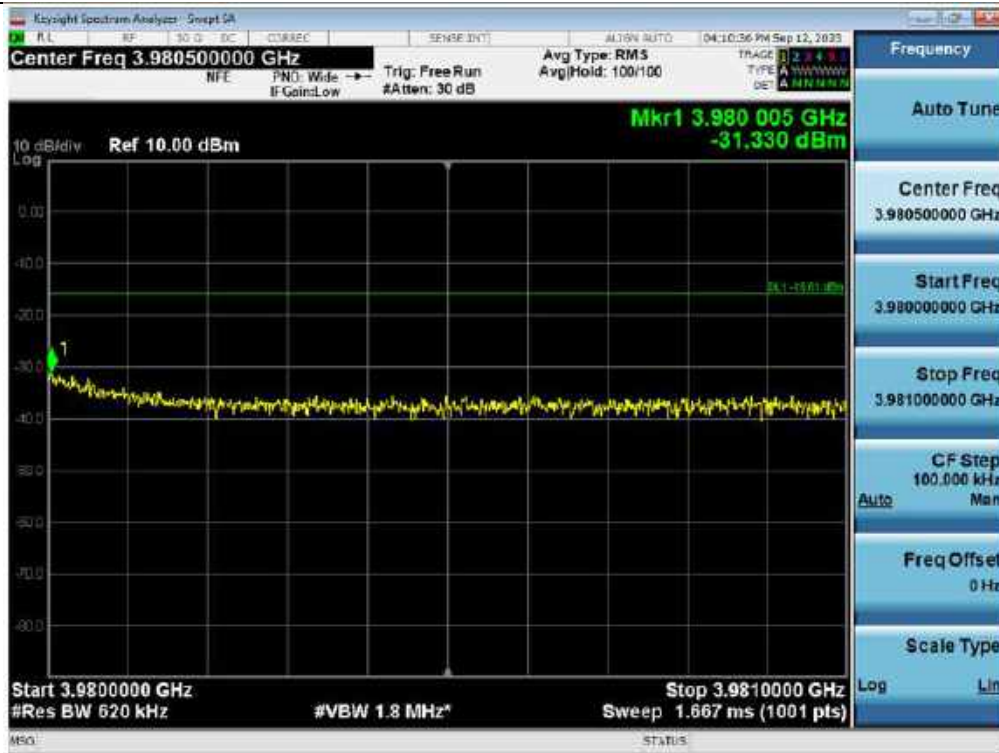

Out-of-band (single test signal) / 3.7 GHz Service (ANT 1) / Downlink / 5G NR 80 MHz / Lower



Out-of-band (single test signal) / 3.7 GHz Service (ANT 1) / Downlink / 5G NR 80 MHz / Upper

