



FCC PART 15C TEST REPORT FOR CERTIFICATION  
On Behalf of

Rosewill Inc.

300Mbps Wireless N Router

Model No.: RNX-N360RT

FCC ID: W6RRNX-N360RT

Prepared for : Rosewill Inc.  
17708 Rowland Street, City of Industry, CA91748, USA

Prepared By : Audix Technology (Shenzhen) Co., Ltd.  
No. 6, Ke Feng Rd., 52 Block,  
Shenzhen Science & Industrial Park,  
Nantou, Shenzhen, Guangdong, China

Tel: (0755) 26639496

Report Number : ACS-F12183  
Date of Test : Aug.12~19, 2012  
Date of Report : Sep.03, 2012

**TABLE OF CONTENTS**

<u>Description</u>	<u>Page</u>
<b>1. SUMMARY OF STANDARDS AND RESULTS.....</b>	<b>1-1</b>
1.1. Description of Standards and Results .....	1-1
<b>2. GENERAL INFORMATION .....</b>	<b>2-1</b>
2.1. Description of Device (EUT) .....	2-1
2.2. Test Information.....	2-2
2.3. Tested Supporting System Details .....	2-3
2.4. Block diagram of connection between the EUT and simulators .....	2-3
2.5. Test Facility .....	2-4
2.6. Measurement Uncertainty (95% confidence levels, k=2) .....	2-4
<b>3. POWER LINE CONDUCTED EMISSION TEST .....</b>	<b>3-1</b>
3.1. Test Equipments.....	3-1
3.2. Block Diagram of Test Setup.....	3-1
3.3. Power Line Conducted Emission Test Limits.....	3-1
3.4. Configuration of EUT on Test .....	3-2
3.5. Operating Condition of EUT.....	3-2
3.6. Test Procedure.....	3-2
3.7. Power Line Conducted Emission Test Results .....	3-2
<b>4. RADIATED EMISSION TEST .....</b>	<b>4-1</b>
4.1. Test Equipment .....	4-1
4.2. Block Diagram of Test Setup.....	4-1
4.3. Radiated Emission Limit.....	4-2
4.4. EUT Configuration on Test.....	4-3
4.5. Operating Condition of EUT.....	4-3
4.6. Test Procedure.....	4-3
4.7. Radiated Emission Test Results .....	4-4
<b>5. CONDUCTED SPURIOUS EMISSIONS.....</b>	<b>5-1</b>
5.1. Test Equipment .....	5-1
5.2. Limit.....	5-1
5.3. Test Procedure.....	5-1
<b>6. BAND EDGE COMPLIANCE TEST .....</b>	<b>6-1</b>
6.1. Test Equipment .....	6-1
6.2. Limit.....	6-1
6.3. Test Produce .....	6-1
6.4. Test Results .....	6-1
<b>7. 6dB Bandwidth Test.....</b>	<b>7-1</b>
7.1. Test Equipment .....	7-1
7.2. Limit.....	7-1
7.3. Test Procedure.....	7-1
7.4. Test Results .....	7-1
<b>8. OUTPUT POWER TEST .....</b>	<b>8-1</b>
8.1. Test Equipment .....	8-1
8.2. Limit (FCC Part 15C 15.247 b(3)).....	8-1
8.3. Test Procedure.....	8-1
8.4. Test Results .....	8-2
<b>9. POWER SPECTRAL DENSITY TEST .....</b>	<b>9-1</b>
9.1. Test Equipment .....	9-1

9.2.	Limit.....	9-1
9.3.	Test Procedure.....	9-1
9.4.	Test Results .....	9-2
<b>10.</b>	<b>ANTENNA REQUIREMENT .....</b>	<b>10-1</b>
10.1.	STANDARD APPLICABLE.....	10-1
10.2.	ANTENNA CONNECTED CONSTRUCTION .....	10-1
<b>11.</b>	<b>MPE ESTIMATION.....</b>	<b>11-1</b>
11.1.	Limit for General Population/ Uncontrolled Exposures .....	11-1
11.2.	Estimation Result .....	11-1
<b>12.</b>	<b>DEVIATION TO TEST SPECIFICATIONS.....</b>	<b>12-1</b>
<b>13.</b>	<b>PHOTOGRAPH OF TEST .....</b>	<b>13-1</b>
13.1.	Photos of Power Line Conducted Emission Test.....	13-1
13.2.	Photos of Radiated Emission Test.....	13-2
<b>14.</b>	<b>PHOTOGRAPH OF EUT .....</b>	<b>14-1</b>



FCC ID: W6RRNX-N360RT

### TEST REPORT CERTIFICATION

Applicant : Rosewill Inc.  
 Manufacturer : Rosewill Inc.  
 EUT Description : 300Mbps Wireless N Router  
 FCC ID : W6RRNX-N360RT

(A) MODEL NO. : RNX-N360RT  
 (B) SERIAL NO. : N/A  
 (C) POWER SUPPLY : DC 9V From PC Input  
 (D) TEST VOLTAGE : DC 9V From PC Input AC 120V/60Hz

Tested for comply with:  
FCC Rules and Regulations Part 15 Subpart C: 2008

Test procedure used:  
ANSI C63.10:2009

The device described above is tested by AUDIX TECHNOLOGY (SHENZHEN) CO., LTD. to confirm comply with all the FCC Part 15 Subpart C requirements.

The test results are contained in this test report and AUDIX TECHNOLOGY (SHENZHEN) CO., LTD. is assumed full responsibility for the accuracy and completeness of these tests. Also, this report shows that the Equipment Under Test (EUT) is to be technically compliant with the FCC and IC requirements.

This Report is made under FCC Part 2.1075. No modifications were required during testing to bring this product into compliance.

This report applies to above tested sample only. This report shall not be reproduced in part without written approval of AUDIX TECHNOLOGY (SHENZHEN) CO., LTD.

Date of Test : Aug.12~19, 2012 Report of date: Sep.03, 2012

Prepared by : Selina Liu Reviewed by : Sunny Lu  
Selina Liu / Supervisor Sunny Lu / Assistant Manager



Approved & Authorized Signer : Ken Lu  
Ken Lu / Manager

## 1. SUMMARY OF STANDARDS AND RESULTS

### 1.1. Description of Standards and Results

The EUT have been tested according to the applicable standards as referenced below.

EMISSION		
Description of Test Item	Standard	Results
Power Line Conducted Emission	FCC Part 15: 15.207 ANSI C63.10: 2009	PASS
Radiated Emission	FCC Part 15: 15.209 ANSI C63.10: 2009	PASS
Band Edge Compliance	FCC Part 15: 15.247 ANSI C63.10: 2009	PASS
Conducted spurious emissions	FCC Part 15: 15.247 ANSI C63.10: 2009	PASS
6dB Bandwidth	FCC Part 15: 15.247 ANSI C63.10: 2009	PASS
Peak Output Power	FCC Part 15: 15.247 ANSI C63.10: 2009	PASS
Power Spectral Density	FCC Part 15: 15.247 ANSI C63.10: 2009	PASS
Antenna requirement	FCC Part 15: 15.203	PASS

## 2. GENERAL INFORMATION

### 2.1. Description of Device (EUT)

Product Name	:	300Mbps Wireless N Router
Model Number	:	RNX-N360RT
FCC ID	:	W6RRNX-N360RT
Operation Frequency	:	IEEE 802.11b: 2412MHz—2462MHz IEEE 802.11g: 2412MHz—2462MHz IEEE 802.11n HT20: 2412MHz—2462MHz IEEE 802.11n HT40: 2422MHz—2452MHz
Channel Number	:	IEEE 802.11b/g, IEEE 802.11n HT20: 11 Channels IEEE 802.11n HT40: 7Channels
Modulation Technology	:	IEEE 802.11b: DSSS(CCK,DQPSK,DBPSK) IEEE 802.11g: OFDM(64QAM, 16QAM, QPSK, BPSK) IEEE 802.11n HT20, HT40: OFDM (64QAM, 16QAM, QPSK,BPSK)
Antenna Assembly Gain	:	MIMO 2X2 Dipole Antenna, 3dBi Gain,one antenna Auxiliary Rx only
Applicant	:	Rosewill Inc. 17708 Rowland Street, City of Industry, CA91748, USA
Manufacturer	:	Rosewill Inc. 17708 Rowland Street, City of Industry, CA91748, USA
Power Adapter	:	Manufacture: VASATA M/N: P090085-2B1 Unshielded Detachable 1.5m
Date of Test	:	Aug.12~19, 2012
Date of Receipt	:	Aug.11, 2012
Sample Type	:	Prototype production



## 2.2. Test Information

A special test software was used to control EUT work in Continuous TX mode(100% duty cycle), and select test channel, wireless mode and data rate.

Tested mode, channel, and data rate information			
Mode	data rate (Mbps)(see Note)	Channel	Frequency (MHz)
IEEE 802.11b	1	Low :CH1	2412
	1	Middle: CH6	2437
	1	High: CH11	2462
IEEE 802.11g	6	Low :CH1	2412
	6	Middle: CH6	2437
	6	High: CH11	2462
IEEE 802.11n HT20	6.5	Low :CH1	2412
	6.5	Middle: CH6	2437
	6.5	High: CH11	2462
IEEE 802.11n HT40	13.5	Low :CH1	2422
	13.5	Middle: CH4	2437
	13.5	High: CH7	2452
<p>Note 1: According exploratory test, EUT will have maximum output power in those data rate, so those data rate were used for all test.</p> <p>Note 2: According to explore test: Chain 0 has the worst case emission, so choose chain 0 for the Radiated emission and band-edge test for 11b/g mode. As to 11n Mode, test with the two antenna transmitting simultaneously.</p>			

### 2.3. Tested Supporting System Details

No.	Description	ACS No.	Manufacturer	Model	Serial Number	Approved type
1.	Personal Computer	Test PC M	DELL	Studio 540	224XK2X	<input checked="" type="checkbox"/> FCC DoC <input checked="" type="checkbox"/> BSMI ID:R33002
		Power Cord: Unshielded, Detachable, 1.8m Display Card: HD3450 (DVI+VGA+HDMI)				
2.	Monitor	ACS-EMC-LM03R	DELL	1907FPt	CN-009759-71618 -6CG-BDWV	<input checked="" type="checkbox"/> FCC DoC <input checked="" type="checkbox"/> BSMI ID: R3A002
		Power Cord: Unshielded, Detachable, 1.8m VGA Cable: Shielded, Detachable, 2.0m (with two cores) DVI Cable: Shielded, Detachable, 2.0m (with two cores)				
3.	USB Mouse	ACS-EMC-M03R	DELL	M056UO	512023253	<input checked="" type="checkbox"/> FCC DoC <input checked="" type="checkbox"/> BSMI ID: R41108
		Power Cord: shielded, Undetachable, 1.8m				
4.	USB Keyboard	ACS-EMC- K03R	DELL	SK-8115	CN-ODJ313-7161 6-711-04WJ	<input checked="" type="checkbox"/> FCC DoC <input checked="" type="checkbox"/> BSMI ID: T3A002
		Power Cord: shielded, Undetachable, 2.0m				

### 2.4. Block diagram of connection between the EUT and simulators

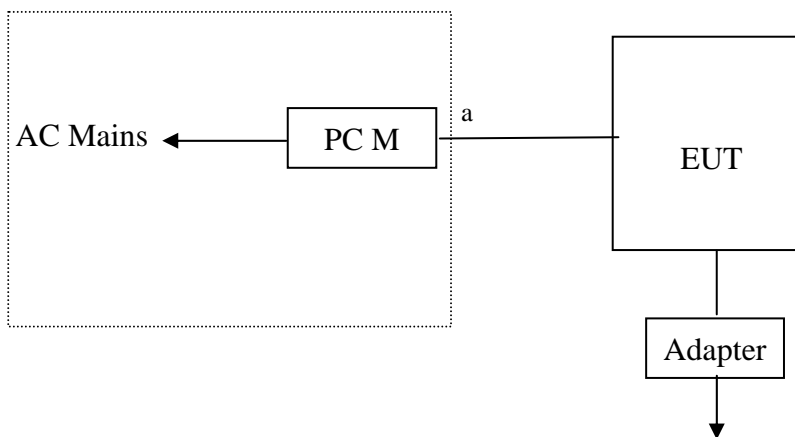

a: LAN port

**(EUT: 300Mbps Wireless N Router)**



2.5. Test Facility

Site Description

Name of Firm : Audix Technology (Shenzhen) Co., Ltd.  
No. 6, Ke Feng Rd., 52 Block, Shenzhen  
Science & Industrial Park, Nantou,  
Shenzhen, Guangdong, China

3m Anechoic Chamber : Certificated by FCC, USA  
Registration Number: 90454  
Valid Date: Feb.22, 2015

3m & 10m Anechoic Chamber : Certificated by FCC, USA  
Registration Number: 794232  
Valid Date: Dec.30, 2012

EMC Lab. : Certificated by Industry Canada  
Registration Number: IC 5183A-1  
Valid Date: Jun.13, 2014

: Certificated by DAkkS, Germany  
Registration No: D-PL-12151-01-01  
Valid Date: Feb.01, 2014

Accredited by NVLAP, USA  
NVLAP Code: 200372-0  
Valid Date: Mar.31, 2013

2.6. Measurement Uncertainty (95% confidence levels, k=2)

Test Item	Uncertainty
Uncertainty for Conduction emission test in No. 1 Conduction	3.6dB(9KHz to 150KHz)
	3.2dB (150KHz to 30MHz)
Uncertainty for Radiation Emission test in 3m chamber	3.6 dB(30~200MHz, Polarize: H)
	3.8 dB(30~200MHz, Polarize: V)
	4.2 dB(200M~1GHz, Polarize: H)
	3.8 dB(200M~1GHz, Polarize: V)
Uncertainty for Radiation Emission test in 3m chamber (1GHz-18GHz)	3.1dB (Distance: 3m Polarize: V)
	3.7 dB (Distance: 3m Polarize: H)
Uncertainty for Radiated Spurious Emission test in RF chamber	3.57 dB
Uncertainty for Conduction Spurious emission test	2.00 dB
Uncertainty for Output power test	0.73 dB
Uncertainty for Power density test	2.00 dB
Uncertainty for Frequency range test	$7 \times 10^{-8}$
Uncertainty for Bandwidth test	83 kHz
Uncertainty for DC power test	0.038 %
Uncertainty for test site temperature and humidity	0.6°C
	3%

### 3. POWER LINE CONDUCTED EMISSION TEST

#### 3.1. Test Equipments

Item	Equipment	Manufacturer	Model No.	Serial No.	Last Cal.	Cal. Interval
1.	Test Receiver	Rohde & Schwarz	ESHS10	838693/001	Oct.31, 11	1 Year
2.	L.I.S.N.#1	Rohde & Schwarz	ESH2-Z5	834066/011	Oct.31, 11	1 Year
3.	L.I.S.N.#3	Kyoritsu	KNW-242C	8-1920-1	May.08, 12	1 Year
4.	Terminator	Hubersuhner	50Ω	No. 1	May.08, 12	1 Year
5.	Terminator	Hubersuhner	50Ω	No. 2	May.08, 12	1 Year
6.	RF Cable	Fujikura	3D-2W	No.1	May.08, 12	1 Year
7.	Coaxial Switch	Anritsu	MP59B	M50564	May.08, 12	1 Year
8.	Pulse Limiter	Rohde & Schwarz	ESH3-Z2	100341	May.08, 12	1 Year

#### 3.2. Block Diagram of Test Setup

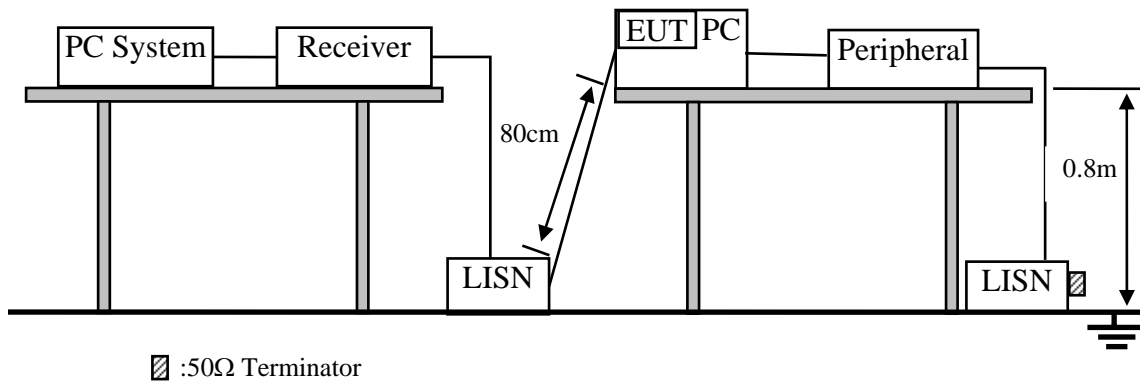

#### 3.3. Power Line Conducted Emission Test Limits

Frequency	Maximum RF Line Voltage	
	Quasi-Peak Level dB(μV)	Average Level dB(μV)
150kHz ~ 500kHz	66 ~ 56*	56 ~ 46*
500kHz ~ 5MHz	56	46
5MHz ~ 30MHz	60	50

Notes: 1. \* Decreasing linearly with logarithm of frequency.  
 2. The lower limit shall apply at the transition frequencies.

### 3.4. Configuration of EUT on Test

The following equipment are installed on Power Line Conducted Emission Test to meet the commission requirement and operating regulations in a manner which tends to maximize its emission characteristics in a normal application.

#### 3.4.1. EZ Connect<sup>™</sup> N 11n Wireless PCI Adapter (EUT)

Model Number : RNX-N360RT  
Serial Number : N/A

3.4.2. Support Equipment: As Tested Supporting System Details, in Section 2.3.

### 3.5. Operating Condition of EUT

3.5.1. Setup the EUT and simulator as shown as Section 2.4.

3.5.2. Turned on the power of all equipment.

3.5.3. PC run test software to control EUT work in Tx mode.

### 3.6. Test Procedure

The EUT was placed on a non-metallic table, 80cm above the ground plane. The EUT Power Via PC connected to the power mains through a line impedance stabilization network (L.I.S.N. 1#). This provides a 50 ohm coupling impedance for the EUT (Please refer the block diagram of the test setup and photographs). The AC line are checked to find out the maximum conducted emission. In order to find the maximum emission levels, the relative positions of equipment and all of the interface cables shall be changed according to ANSI C63.10: 2009 on Conducted Emission Test.

The bandwidth of test receiver (R & S ESHS10) is set at 9kHz.

The frequency range from 150kHz to 30MHz is checked.

### 3.7. Power Line Conducted Emission Test Results

**PASS.**

(All emissions not reported below are too low against the prescribed limits.)

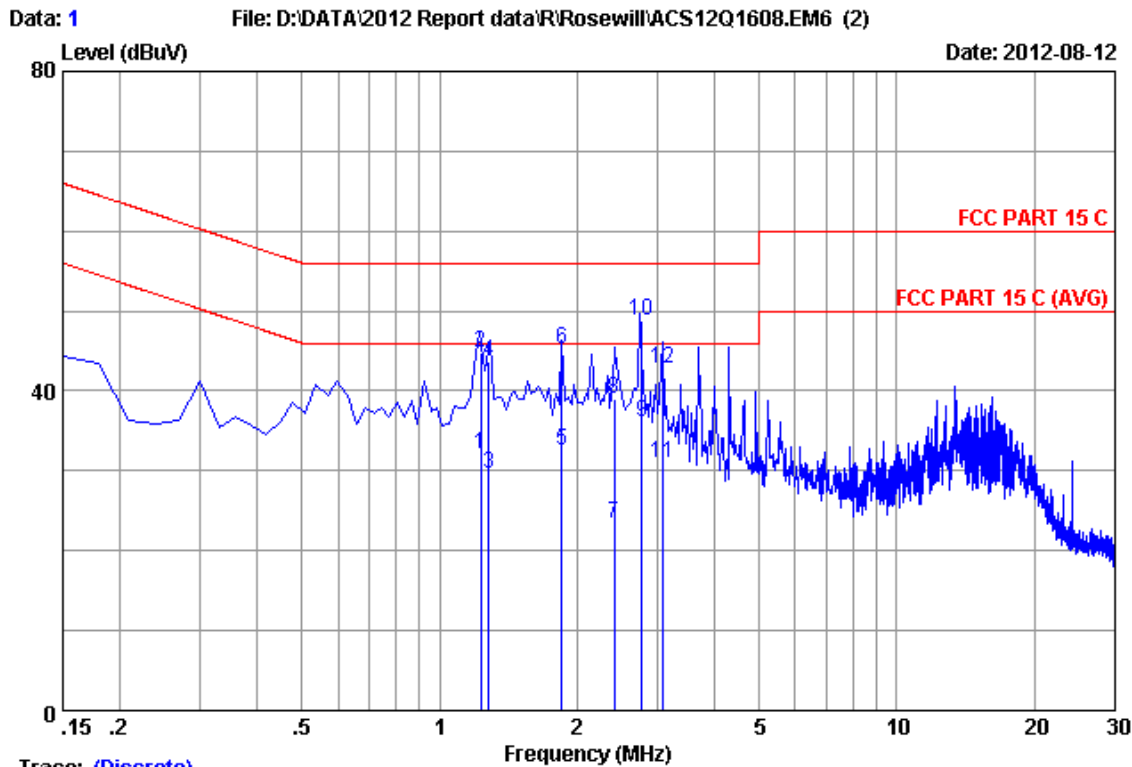

Trace: (Discrete)

Site no :1#conduction Data No :1  
 Dis./Ant. \*\*: 2012 ESH2-25 LINE  
 Limit :FCC PART 15 C  
 Env./Ins. :22.9\*C/45% Engineer :Leo-Li  
 EUT :300Mbps Wireless N Router  
 :DC 9V From Adapter Input AC 120V/60Hz  
 Power Rating :Tx Mode  
 Test Mode :M/N:RNX-N360RT

No	Freq (MHz)	LISN Factor (dB)	Cable Loss (dB)	Reading (dBuV)	Emission Level (dBuV)	Limits (dBuV)	Margin (dB)	Remark
1	1.233	0.18	9.94	22.00	32.12	46.00	13.88	Average
2	1.233	0.18	9.94	34.60	44.72	56.00	11.28	QP
3	1.280	0.18	9.94	19.50	29.62	46.00	16.38	Average
4	1.280	0.18	9.94	33.60	43.72	56.00	12.28	QP
5	1.850	0.20	9.94	22.29	32.43	46.00	13.57	Average
6	1.850	0.20	9.94	35.09	45.23	56.00	10.77	QP
7	2.410	0.21	9.94	13.30	23.45	46.00	22.55	Average
8	2.410	0.21	9.94	28.90	39.05	56.00	16.95	QP
9	2.770	0.22	9.94	25.89	36.05	46.00	9.95	Average
10	2.770	0.22	9.94	38.69	48.85	56.00	7.15	QP
11	3.090	0.22	9.94	20.80	30.96	46.00	15.04	Average
12	3.090	0.22	9.94	32.70	42.86	56.00	13.14	QP

Remarks: 1.Emission Level=LISN Factor+Cable Loss(Include 10dB pulse limit)+Reading.  
 2.If the average limit is met when using a quasi-peak detector. the EUT shall be deemed to meet both limits and measurement with average detector is unnecessary.

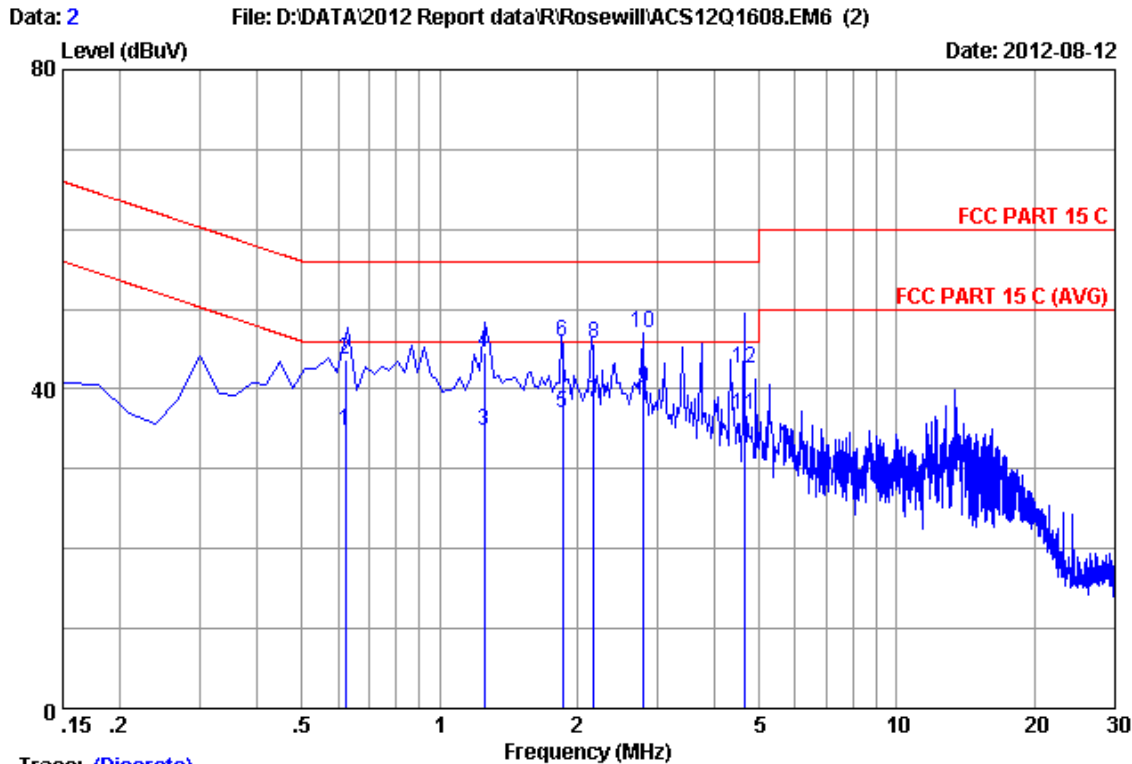

Trace: (Discrete)

Site no :1#conduction Data No :2  
 Dis./Ant. \*\*: 2012 ESH2-Z5 NEUTRAL  
 Limit :FCC PART 15 C  
 Env./Ins. :22.9\*C/45% Engineer :Leo-Li  
 EUT :300Mbps Wireless N Router  
 :DC 9V From Adapter Input AC 120V/60Hz  
 Power Rating :Tx Mode  
 Test Mode :M/N:RXN-N360RT

No	Freq (MHz)	LISN Factor (dB)	Cable Loss (dB)	Reading (dBuV)	Emission Level (dBuV)	Limits (dBuV)	Margin (dB)	Remark
1	0.62300	0.16	9.95	24.59	34.70	46.00	11.30	Average
2	0.62300	0.16	9.95	33.59	43.70	56.00	12.30	QP
3	1.250	0.18	9.94	24.60	34.72	46.00	11.28	Average
4	1.250	0.18	9.94	34.50	44.62	56.00	11.38	QP
5	1.860	0.20	9.94	26.89	37.03	46.00	8.97	Average
6	1.860	0.20	9.94	35.79	45.93	56.00	10.07	QP
7	2.170	0.20	9.94	28.20	38.34	46.00	7.66	Average
8	2.170	0.20	9.94	35.60	45.74	56.00	10.26	QP
9	2.790	0.22	9.94	29.99	40.15	46.00	5.85	Average
10	2.790	0.22	9.94	36.79	46.95	56.00	9.05	QP
11	4.640	0.25	9.95	26.49	36.69	46.00	9.31	Average
12	4.640	0.25	9.95	32.29	42.49	56.00	13.51	QP

Remarks: 1.Emission Level=LISN Factor+Cable Loss(Include 10dB pulse limit)+Reading.  
 2.If the average limit is met when using a quasi-peak detector, the EUT shall be deemed to meet both limits and measurement with average detector is unnecessary.

## 4. RADIATED EMISSION TEST

### 4.1. Test Equipment

Frequency rang: 30~1000MHz

Item	Equipment	Manufacturer	Model No.	Serial No.	Last Cal.	Cal. Interval
1	3#Chamber	AUDIX	N/A	N/A	Nov.28,11	1 Year
2	EMI Spectrum	Agilent	E4407B	MY41440292	May.08, 12	1 Year
3	Test Receiver	Rohde & Schwarz	ESVS10	834468/011	May.08, 12	1 Year
4	Amplifier	HP	8447D	2648A04738	May.08, 12	1 Year
5	Bilog Antenna	Schaffner	CBL6111C	2598	Oct.26, 10	2.0 Year
6	RF Cable	MIYAZAKI	CFD400-NL	3# Chamber No.1	May.08, 12	1 Year
7	Coaxial Switch	Anritsu	MP59B	M74389	May.08, 12	1 Year

Frequency rang: above 1GHz~18GHz

Item	Equipment	Manufacturer	Model No.	Serial No.	Last Cal.	Cal. Interval
1	Spectrum Analyzer	Agilent	E7405A	MY45116588	Oct.31, 11	1 Year
2	Horn Antenna	EMCO	3115	9510-4580	May.08, 12	1 Year
3	Amplifier	Agilent	8449B	3008A00863	May.08, 12	1 Year
4	RF Cable	Hubersuhner	SUCOFLEX106	77980/6	May.08, 12	1 Year
5	RF Cable	Hubersuhner	SUCOFLEX106	77977/6	May.08, 12	1 Year
6	Horn Antenna	EMCO	3116	00060089	May.08, 12	1.5Year

### 4.2. Block Diagram of Test Setup

For frequency range 30MHz-1000MHz

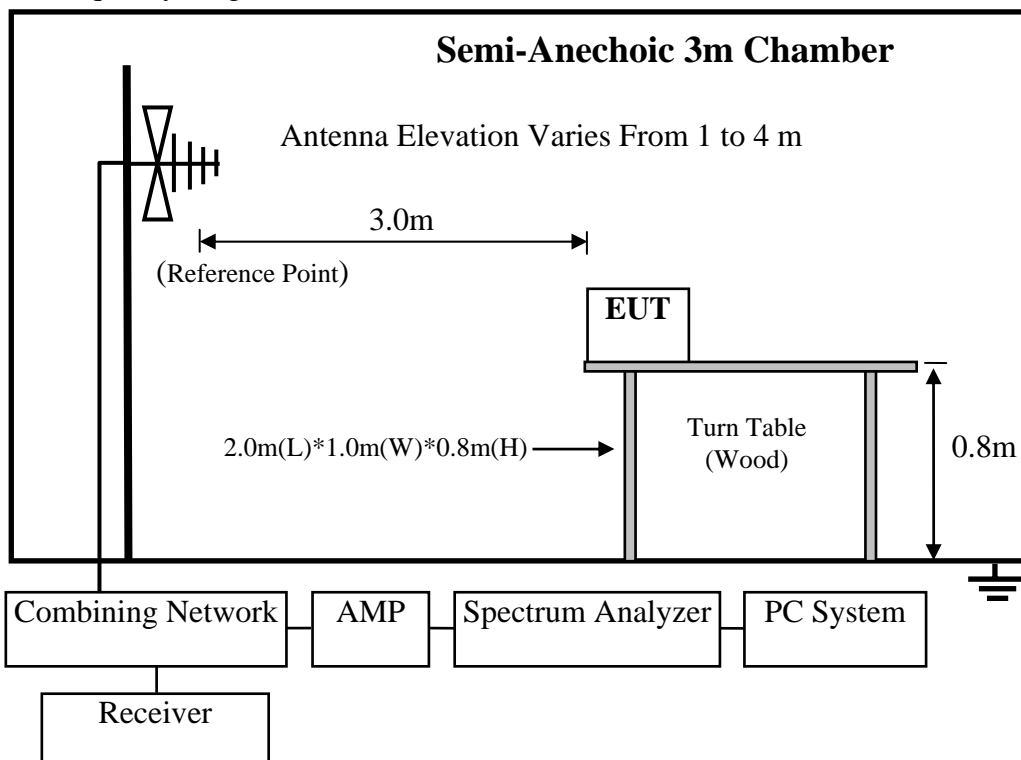



For frequency range above 1GHz~18GHz

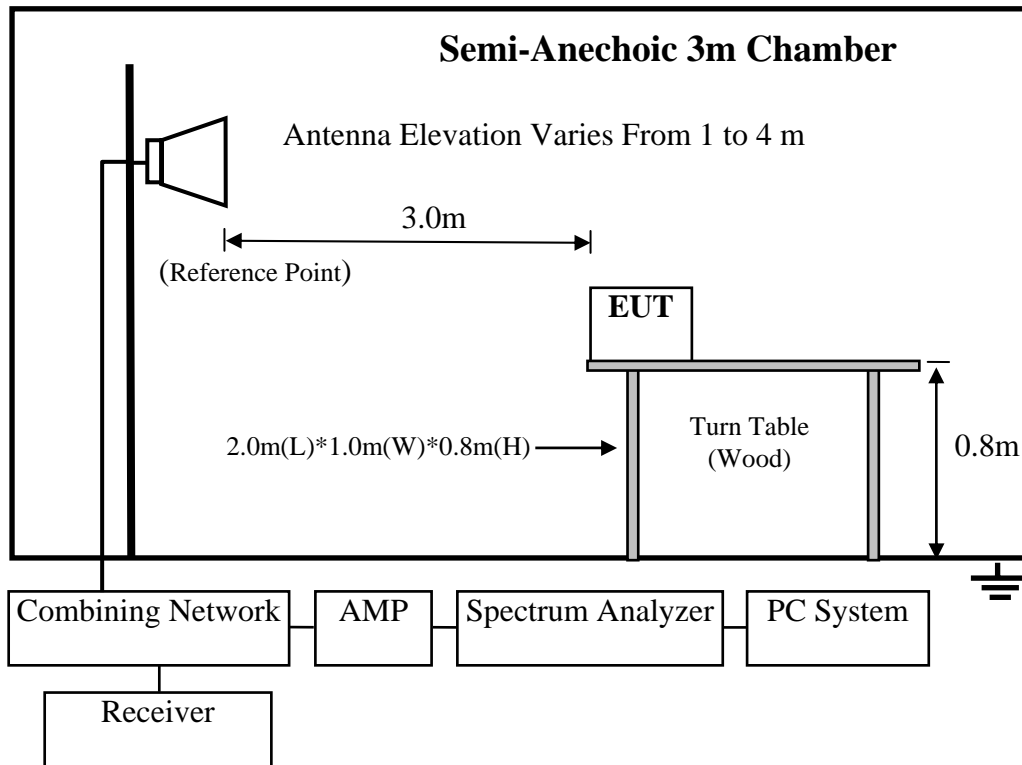

### 4.3. Radiated Emission Limit

#### 4.3.1.15.209 limits

FREQUENCY MHz	DISTANCE Meters	FIELD STRENGTHS LIMIT	
		$\mu\text{V}/\text{m}$	$\text{dB}(\mu\text{V})/\text{m}$
30 ~ 88	3	100	40.0
88 ~ 216	3	150	43.5
216 ~ 960	3	200	46.0
960 ~ 1000	3	500	54.0
Above 1000	3	74.0 $\text{dB}(\mu\text{V})/\text{m}$ (Peak) 54.0 $\text{dB}(\mu\text{V})/\text{m}$ (Average)	

Remark : (1) Emission level  $\text{dB}\mu\text{V} = 20 \log$  Emission level  $\mu\text{V}/\text{m}$

(2) The smaller limit shall apply at the cross point between two frequency bands.

(3) Distance is the distance in meters between the measuring instrument, antenna and the closest point of any part of the device or system.

4.3.2.15.205 Restricted bands of operation

MHz	MHz	MHz	GHz
0.090 - 0.110	16.42 - 16.423	399.9 - 410	4.5 - 5.15
<sup>1</sup> 0.495 - 0.505	16.69475 - 16.69525	608 - 614	5.35 - 5.46
2.1735 - 2.1905	16.80425 - 16.80475	960 - 1240	7.25 - 7.75
4.125 - 4.128	25.5 - 25.67	1300 - 1427	8.025 - 8.5
4.17725 - 4.17775	37.5 - 38.25	1435 - 1626.5	9.0 - 9.2
4.20725 - 4.20775	73 - 74.6	1645.5 - 1646.5	9.3 - 9.5
6.215 - 6.218	74.8 - 75.2	1660 - 1710	10.6 - 12.7
6.26775 - 6.26825	108 - 121.94	1718.8 - 1722.2	13.25 - 13.4
6.31175 - 6.31225	123 - 138	2200 - 2300	14.47 - 14.5
8.291 - 8.294	149.9 - 150.05	2310 - 2390	15.35 - 16.2
8.362 - 8.366	156.52475 - 156.52525	2483.5 - 2500	17.7 - 21.4
8.37625 - 8.38675	156.7 - 156.9	2690 - 2900	22.01 - 23.12
8.41425 - 8.41475	162.0125 - 167.17	3260 - 3267	23.6 - 24.0
12.29 - 12.293	167.72 - 173.2	3332 - 3339	31.2 - 31.8
12.51975 - 12.52025	240 - 285	3345.8 - 3358	36.43 - 36.5
12.57675 - 12.57725	322 - 335.4	3600 - 4400	( <sup>2</sup> )

All the emissions appearing within 15.205 restricted frequency bands shall not exceed the limits shown in 15.209, all the other emissions shall be at least 20dB below the fundamental emissions, or comply with 15.209 limits.

4.4.EUT Configuration on Test

The configurations of EUT are listed in Section 3.5.

4.5.Operating Condition of EUT

Same as Conducted Emission test that is listed in Section 3.6. except the test set up replaced by Section 4.2.

4.6.Test Procedure

EUT and its simulators are placed on a turn table, which is 0.8 meter high above ground. The turn table can rotate 360 degrees to determine the position of the maximum emission level. Power on the EUT and let it working in test mode, then test it. EUT is set 3 meters away from the receiving antenna, which is mounted on a antenna tower. The antenna can be moved up and down between 1 meter and 4 meters to find out the maximum emission level. Broadband antenna (calibrated bilog antenna) is used as receiving antenna. Both horizontal and vertical polarization of the antenna are set on test.

The bandwidth of the EMI test receiver (R&S ESVS10) is set at 120kHz for frequency range from 30MHz to 1000 MHz.

The bandwidth of the Spectrum's VBW is set at 3MHz and RBW is set at 1MHz for peak emissions measurement above 1GHz and 1MHz RBW, 10Hz VBW for average emissions measure above 1GHz

The frequency range from 30MHz to 10<sup>th</sup> harmonic (25GHz) are checked. and no any emissions were found from 18GHz to 25 GHz, So the radiated emissions from 18GHz to 25GHz were not record.

#### 4.7.Radiated Emission Test Results

**PASS.**

All the emissions from 30MHz to 25 GHz were comply with 15.209 limits.

Note: For emissions above 1GHz, if peak level comply with average limit, then the average level is deemed to comply with average limit.

**Frequency: 30MHz~1GHz**

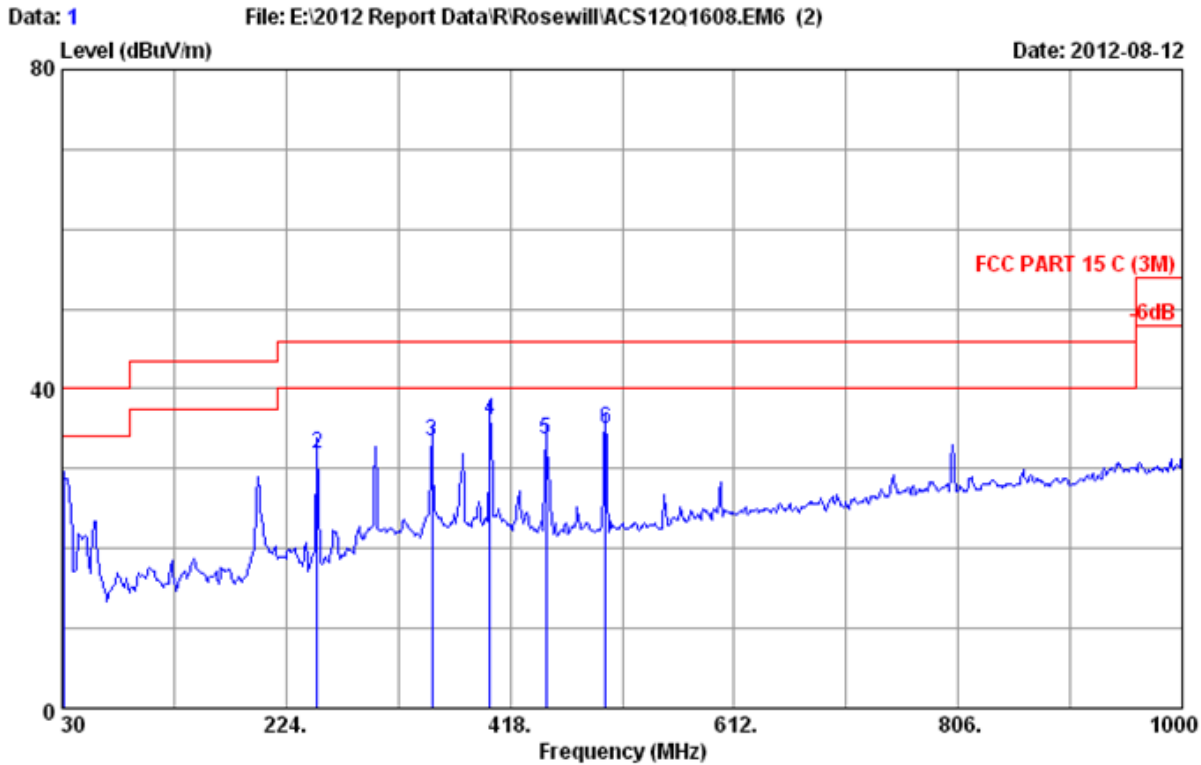

Site no. : 3m Chamber Data no. : 1  
 Dis. / Ant. : 3m 2012 CBL6111C 2598 Ant. pol. : HORIZONTAL  
 Limit : FCC PART 15 C (3M)  
 Env. / Ins. : 24°C/56% Engineer : Leo-Li  
 EUT : 300Mbps Wireless N Router  
 Power rating : DC 9V From Adapter Input AC 120V/60Hz  
 Test Mode : Tx Mode  
 : M/N:RNX-N360RT

No.	Freq. (MHz)	Ant. Factor (dB/m)	Cable Loss (dB)	Reading (dBUV)	Emission Level (dBUV/m)	Limits (dBUV/m)	Margin (dB)	Remark
1	31.940	17.61	0.45	8.93	26.99	40.00	13.01	QP
2	251.160	12.78	1.18	17.95	31.91	46.00	14.09	QP
3	350.100	15.37	1.42	16.74	33.53	46.00	12.47	QP
4	400.540	16.70	1.56	17.87	36.13	46.00	9.87	QP
5	449.040	17.69	1.69	14.18	33.56	46.00	12.44	QP
6	500.450	19.09	1.83	13.99	34.91	46.00	11.09	QP

Remarks: 1. Emission Level= Antenna Factor + Cable Loss + Reading.  
 2. The emission levels that are 20dB below the official limit are not reported.

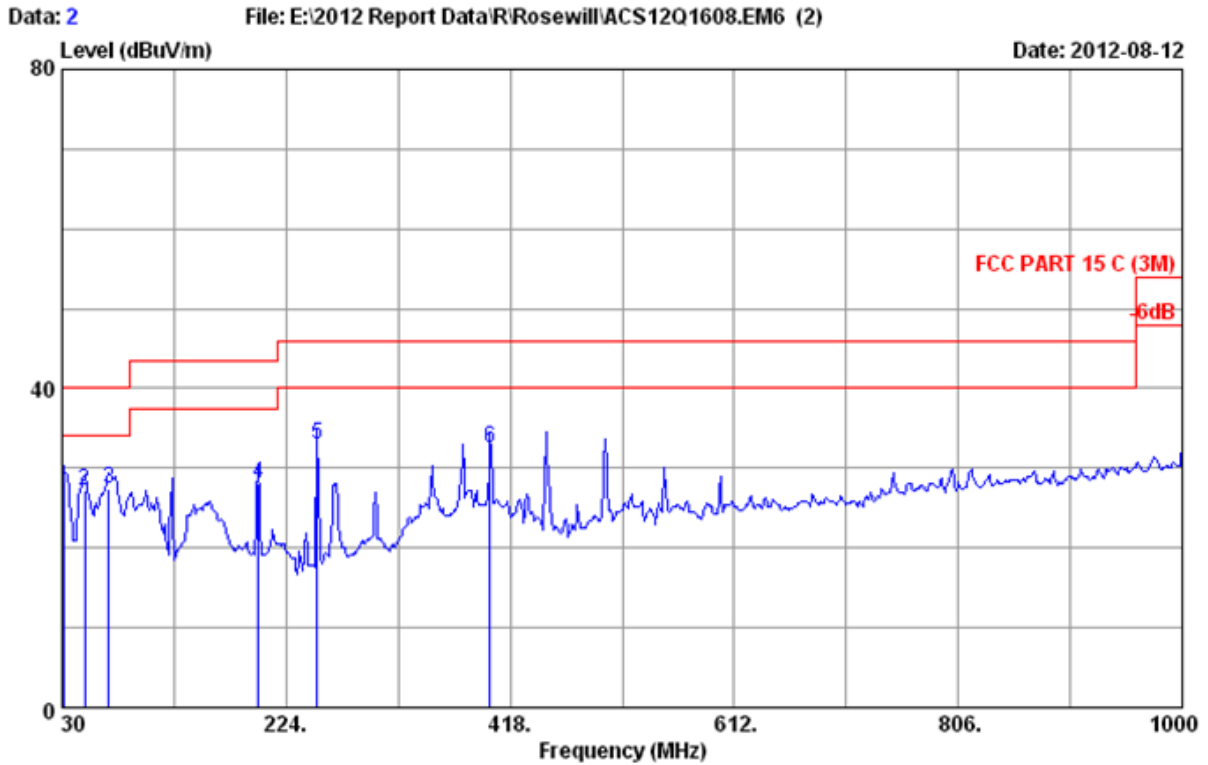

Site no. : 3m Chamber Data no. : 2  
 Dis. / Ant. : 3m 2012 CBL6111C 2598 Ant. pol. : VERTICAL  
 Limit : FCC PART 15 C (3M)  
 Env. / Ins. : 24°C/56% Engineer : Leo-Li  
 EUT : 300Mbps Wireless N Router  
 Power rating : DC 9V From Adapter Input AC 120V/60Hz  
 Test Mode : Tx Mode  
 : M/N:RNX-N360RT

No.	Freq. (MHz)	Ant. Factor (dB/m)	Cable Loss (dB)	Reading (dBuV)	Emission Level (dBuV/m)	Limits (dBuV/m)	Margin (dB)	Remark
1	31.940	17.61	0.45	9.52	27.58	40.00	12.42	QP
2	49.400	8.78	0.63	17.85	27.26	40.00	12.74	QP
3	70.740	6.00	0.72	20.67	27.39	40.00	12.61	QP
4	199.750	9.35	1.06	17.73	28.14	43.50	15.36	QP
5	251.160	12.78	1.18	19.05	33.01	46.00	12.99	QP
6	400.540	16.70	1.56	14.38	32.64	46.00	13.36	QP

Remarks: 1. Emission Level= Antenna Factor + Cable Loss + Reading.  
 2. The emission levels that are 20dB below the official limit are not reported.

## Frequency: 1GHz~18GHz

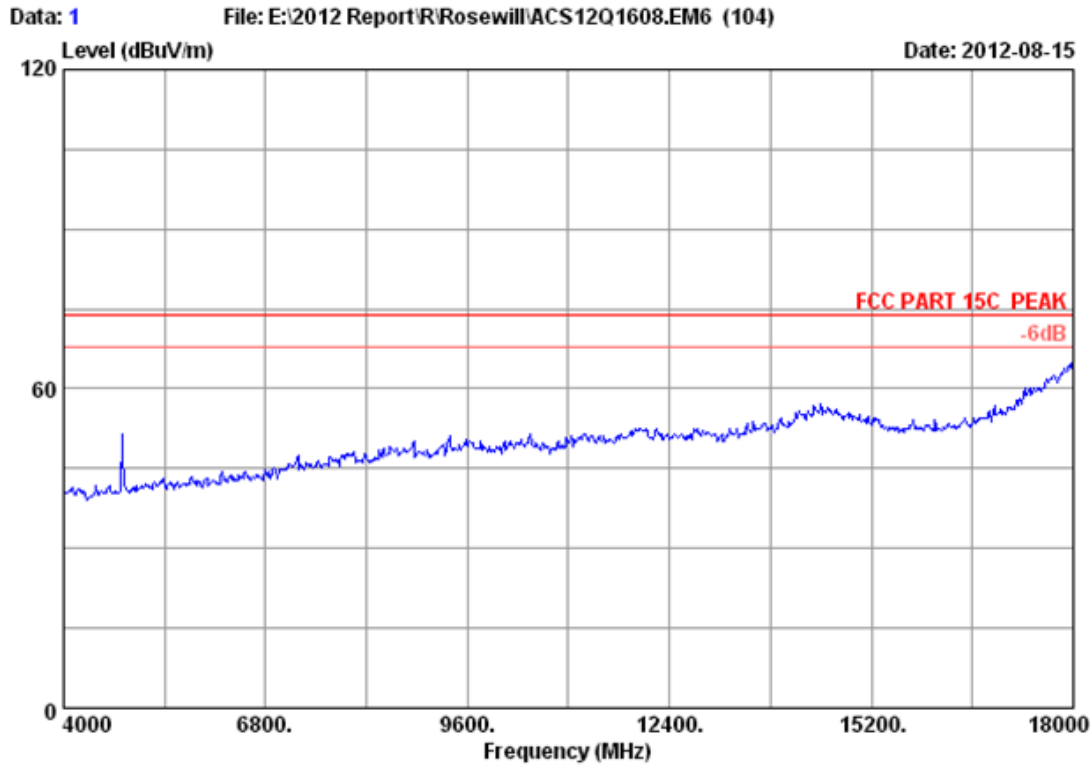

Site no. : 3m Chamber Data no. : 1  
Dis. / Ant. : 3m 2011 3115 4580 Ant. pol. : VERTICAL  
Limit : FCC PART 15C PEAK  
Env. / Ins. : 23°C/54% Engineer : Leo-Li  
EUT : 300Mbps Wireless N Router  
Power supply : DC 9V From Adapter Input AC 120V/60Hz  
Test mode : IEEE802.11b CH1 2412MHz Tx  
M/N : RNX-N360RT



Data: 2 File: E:\2012 Report\R\Rosewill\ACS12Q1608.EM6 (104) Date: 2012-08-15

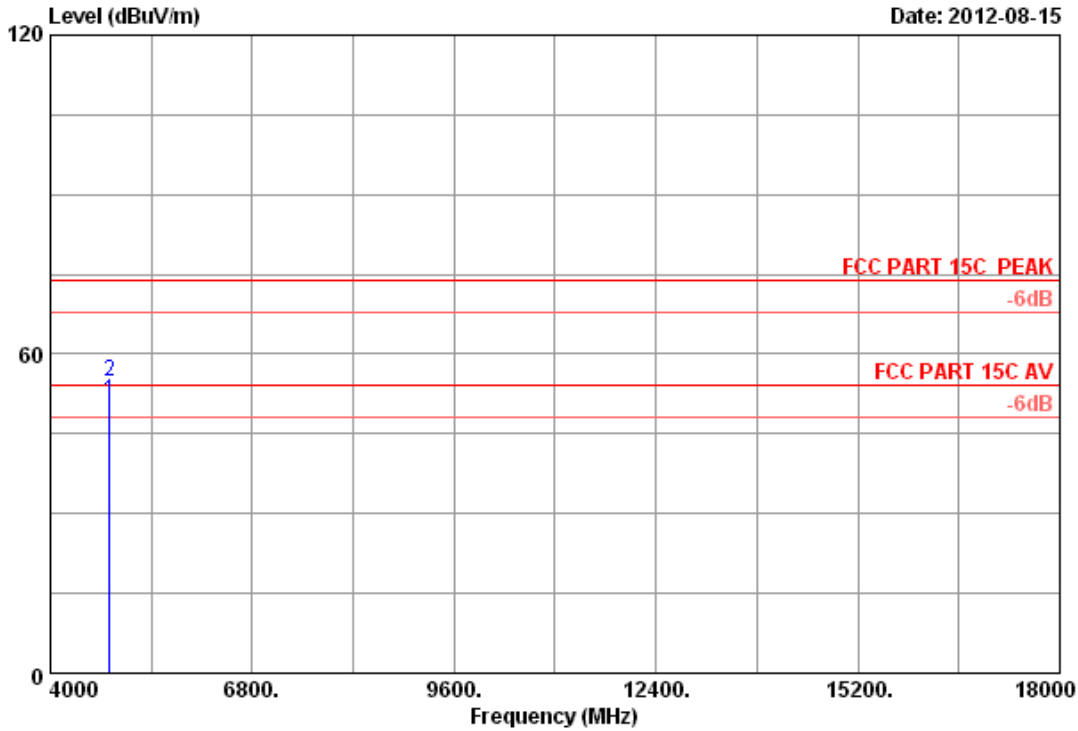

Site no. : 3m Chamber Data no. : 2  
 Dis. / Ant. : 3m 2011 3115 4580 Ant. pol. : VERTICAL  
 Limit : FCC PART 15C PEAK  
 Env. / Ins. : 23°C/54% Engineer : Leo-Li  
 EUT : 300Mbps Wireless N Router  
 Power supply : DC 9V From Adapter Input AC 120V/60Hz  
 Test mode : IEEE802.11b CH1 2412MHz Tx  
 M/N : RNX-N360RT

	Freq. (MHz)	Ant. Factor (dB/m)	Cable loss (dB)	Amp. Factor (dB)	Reading (dBuV)	Emission Level (dBuV/m)	Limits (dBuV/m)	Margin (dB)	Remark
1	4824.000	32.89	8.53	34.60	44.37	51.19	54.00	2.81	Average
2	4824.000	32.89	8.53	34.60	47.86	54.68	74.00	19.32	Peak

Remarks:

1. Emission Level= Antenna Factor + Cable Loss -Amp Factor + Reading.
2. The emission levels that are 20dB below the official limit are not reported.

Data: 3 File: E:\2012 Report\R\Rosewill\ACS12Q1608.EM6 (104) Date: 2012-08-15

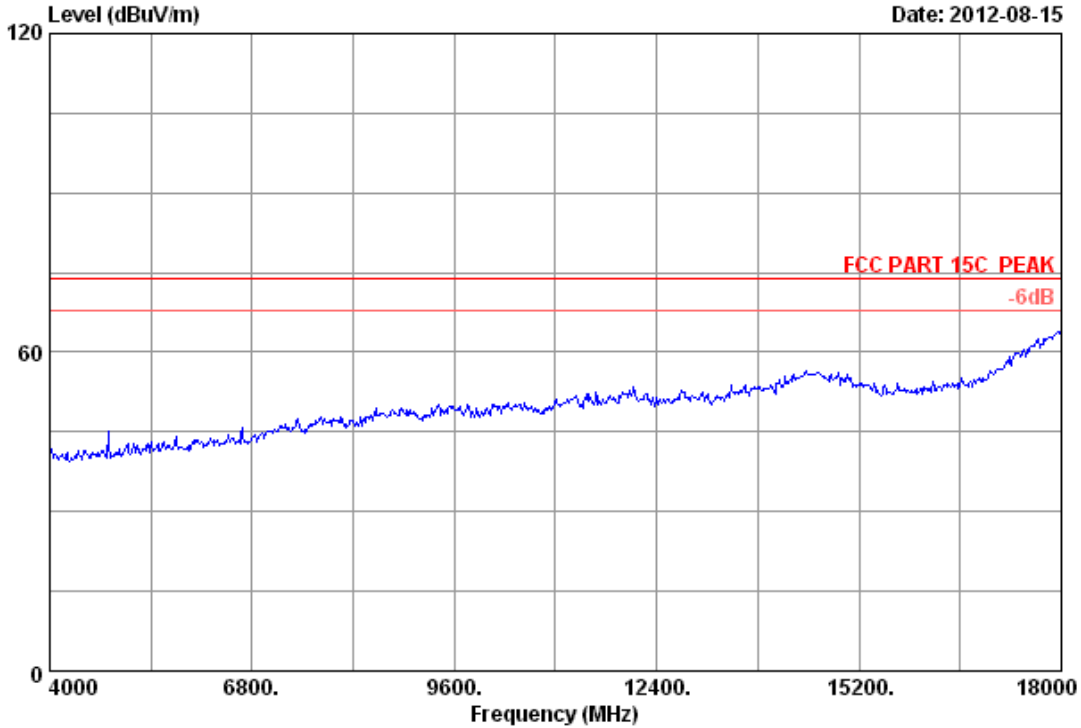

Site no. : 3m Chamber Data no. : 3  
Dis. / Ant. : 3m 2011 3115 4580 Ant. pol. : HORIZONTAL  
Limit : FCC PART 15C PEAK  
Env. / Ins. : 23°C/54% Engineer : Leo-Li  
EUT : 300Mbps Wireless N Router  
Power supply : DC 9V From Adapter Input AC 120V/60Hz  
Test mode : IEEE802.11b CH1 2412MHz Tx  
M/N : RNX-N360RT

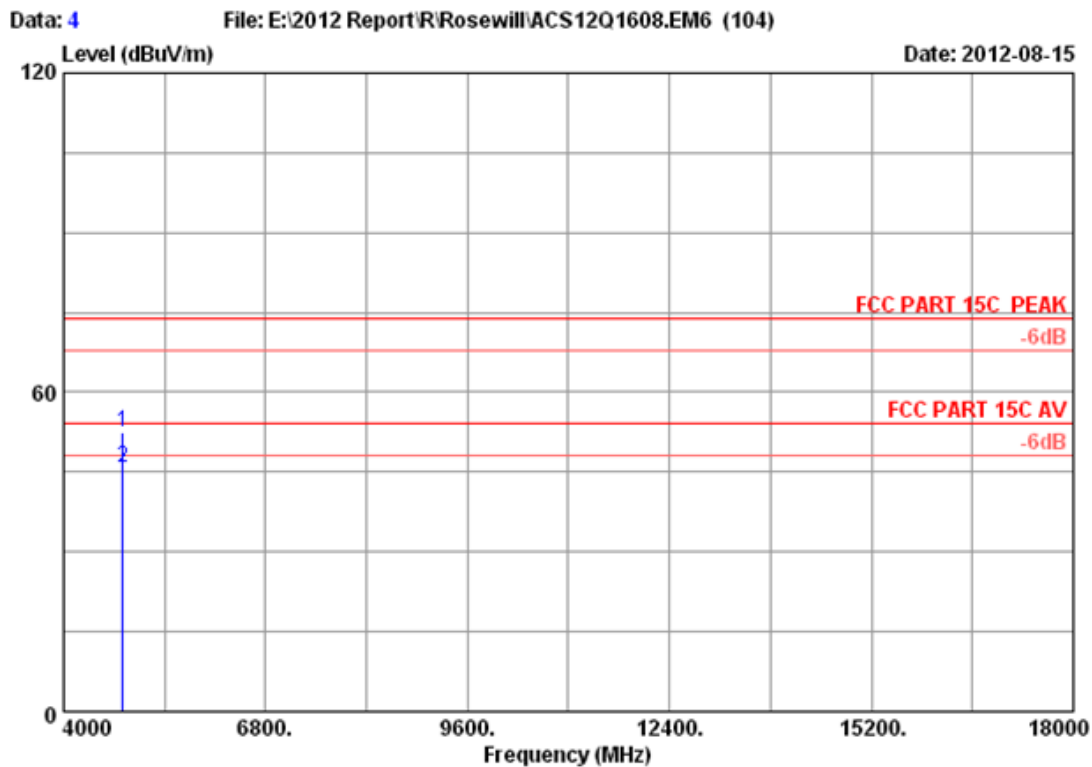

Site no. : 3m Chamber Data no. : 4  
 Dis. / Ant. : 3m 2011 3115 4580 Ant. pol. : HORIZONTAL  
 Limit : FCC PART 15C PEAK  
 Env. / Ins. : 23°C/54% Engineer : Leo-Li  
 EUT : 300Mbps Wireless N Router  
 Power supply : DC 9V From Adapter Input AC 120V/60Hz  
 Test mode : IEEE802.11b CH1 2412MHz Tx  
 M/N : RNX-N360RT

	Freq. (MHz)	Ant. Factor (dB/m)	Cable loss (dB)	Amp. Factor (dB)	Reading (dBuV)	Emission Level (dBuV/m)	Limits (dBuV/m)	Margin (dB)	Remark
1	4824.000	32.89	8.53	34.60	45.62	52.44	74.00	21.56	Peak
2	4824.000	32.89	8.53	34.60	39.07	45.89	54.00	8.11	Average

Remarks:

1. Emission Level= Antenna Factor + Cable Loss -amp Factor + Reading.
2. The emission levels that are 20dB below the official limit are not reported.

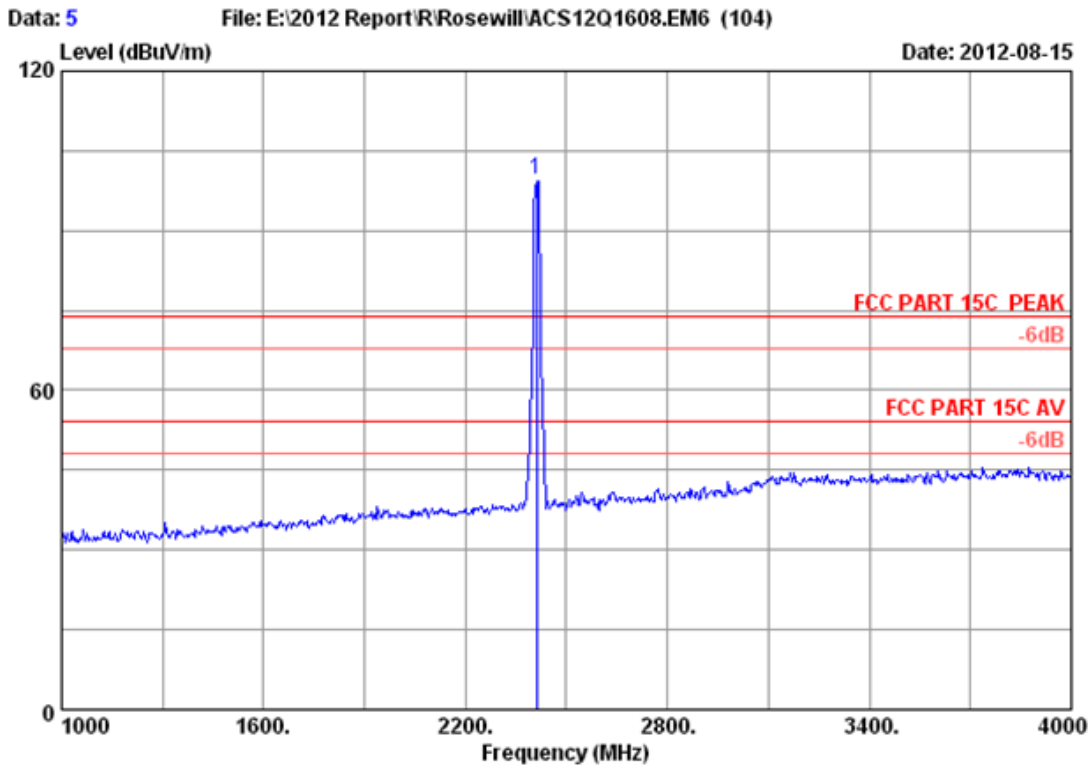

```

Site no.       : 3m Chamber           Data no.      : 5
Dis. / Ant.   : 3m 2011 3115 4580    Ant. pol.    : HORIZONTAL
Limit         : FCC PART 15C PEAK
Env. / Ins.   : 23*C/54%             Engineer     : Leo-Li
EUT           : 300Mbps Wireless N Router
Power supply  : DC 9V From Adapter Input AC 120V/60Hz
Test mode     : IEEE802.11b CH1 2412MHz Tx
M/N          : RNX-N360RT
    
```

	Freq. (MHz)	Ant. Factor (dB/m)	Cable loss (dB)	Amp. Factor (dB)	Reading (dBuV)	Emission Level (dBuV/m)	Limits (dBuV/m)	Margin (dB)	Remark
1	2412.000	27.98	6.03	34.44	99.89	99.46	74.00	-25.46	Peak

Remarks:

1. Emission Level= Antenna Factor + Cable Loss -Amp Factor + Reading.
2. The emission levels that are 20dB below the official limit are not reported.

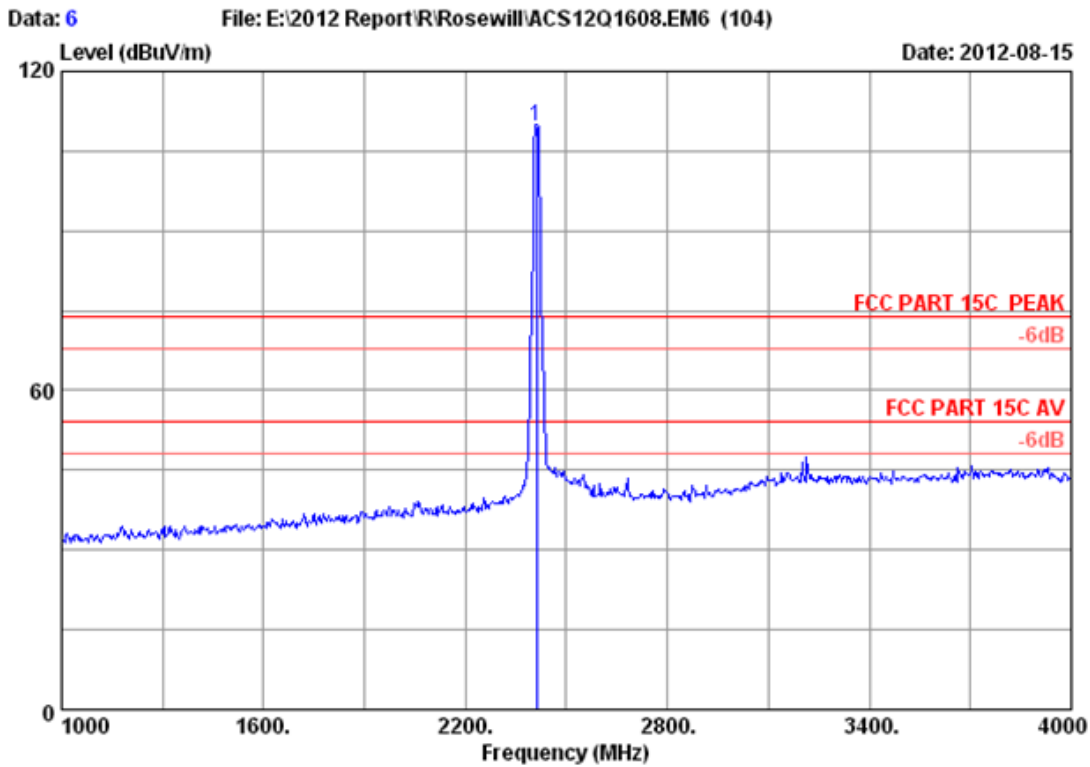

```

Site no.      : 3m Chamber           Data no.   : 6
Dis. / Ant.  : 3m 2011 3115 4580    Ant. pol.  : VERTICAL
Limit       : FCC PART 15C PEAK
Env. / Ins.  : 23*C/54%             Engineer   : Leo-Li
EUT        : 300Mbps Wireless N Router
Power supply : DC 9V From Adapter Input AC 120V/60Hz
Test mode   : IEEE802.11b CH1 2412MHz Tx
M/N        : RNX-N360RT
    
```

	Freq. (MHz)	Ant. Factor (dB/m)	Cable loss (dB)	Amp. Factor (dB)	Reading (dBuV)	Emission Level (dBuV/m)	Limits (dBuV/m)	Margin (dB)	Remark
1	2412.000	27.98	6.03	34.44	110.12	109.69	74.00	-35.69	Peak

Remarks:

1. Emission Level= Antenna Factor + Cable Loss -Amp Factor + Reading.
2. The emission levels that are 20dB below the official limit are not reported.

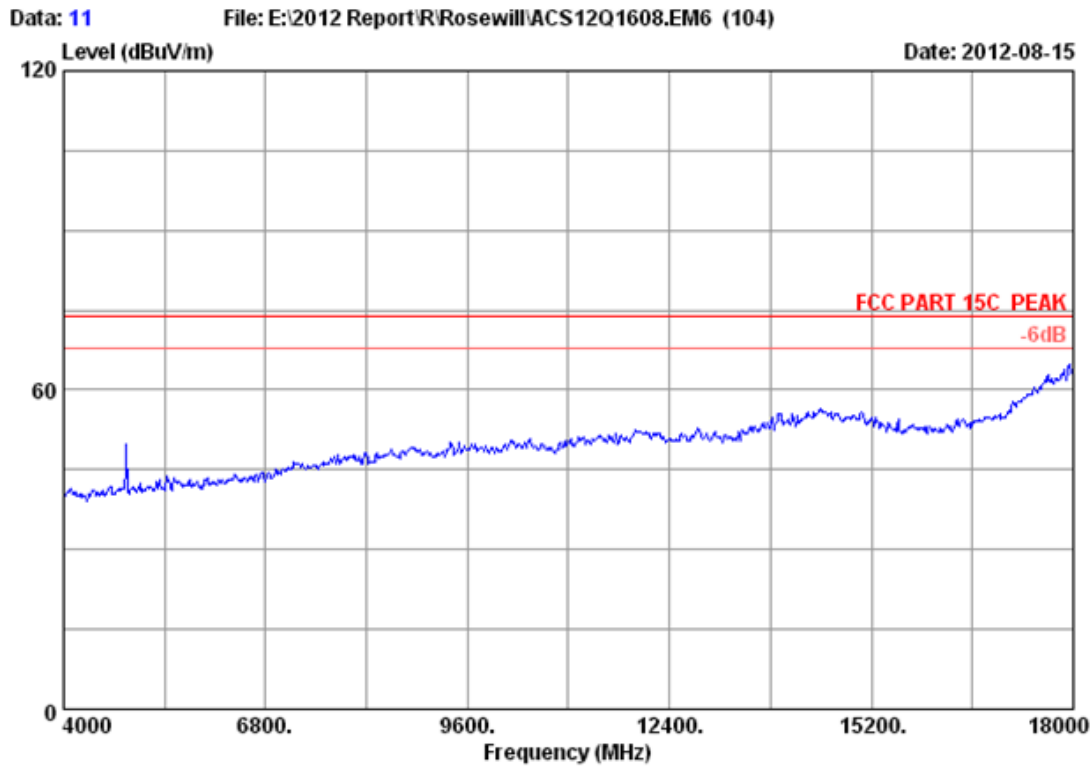

Site no. : 3m Chamber Data no. : 11  
Dis. / Ant. : 3m 2011 3115 4580 Ant. pol. : VERTICAL  
Limit : FCC PART 15C PEAK  
Env. / Ins. : 23°C/54% Engineer : Leo-Li  
EUT : 300Mbps Wireless N Router  
Power supply : DC 9V From Adapter Input AC 120V/60Hz  
Test mode : IEEE802.11b CH6 2437MHz Tx  
M/N : RNX-N360RT



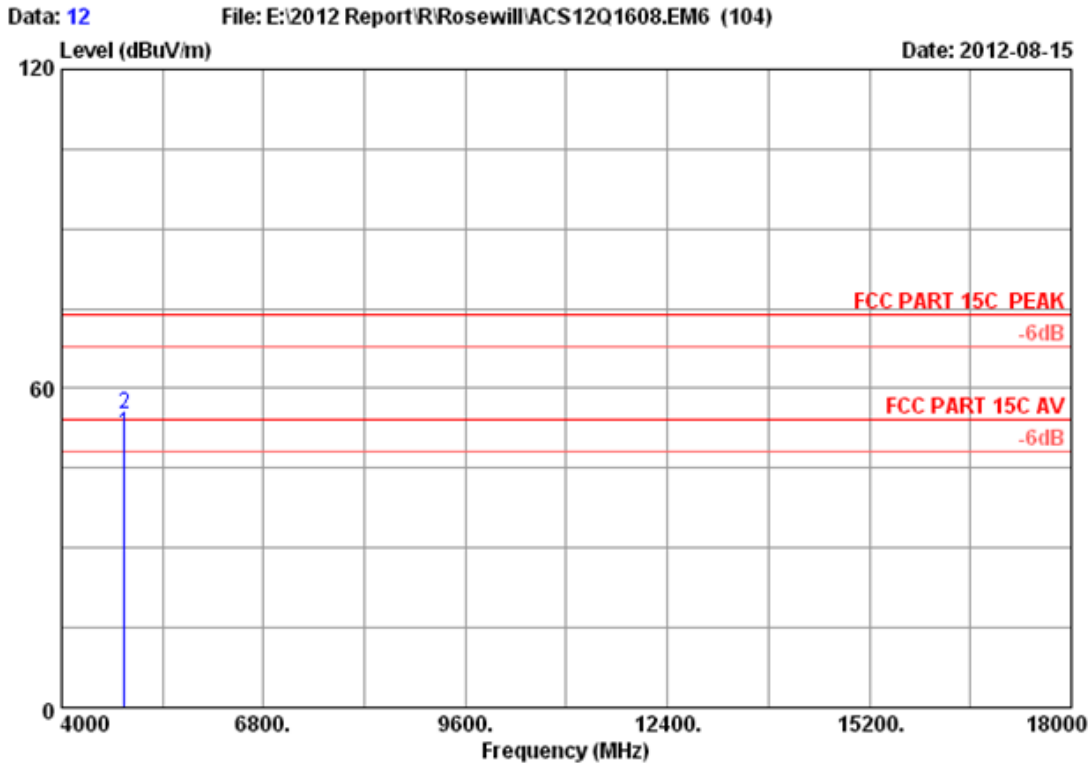

Site no. : 3m Chamber Data no. : 12  
 Dis. / Ant. : 3m 2011 3115 4580 Ant. pol. : VERTICAL  
 Limit : FCC PART 15C PEAK  
 Env. / Ins. : 23°C/54% Engineer : Leo-Li  
 EUT : 300Mbps Wireless N Router  
 Power supply : DC 9V From Adapter Input AC 120V/60Hz  
 Test mode : IEEE802.11b CH6 2437MHz Tx  
 M/N : RNX-N360RT

	Freq. (MHz)	Ant. Factor (dB/m)	Cable loss (dB)	Amp. Factor (dB)	Reading (dBUV)	Emission Level (dBUV/m)	Limits (dBUV/m)	Margin (dB)	Remark
1	4874.000	32.98	8.58	34.60	44.45	51.41	54.00	2.59	Average
2	4874.000	32.98	8.58	34.60	48.32	55.28	74.00	18.72	Peak

Remarks:

1. Emission Level= Antenna Factor + Cable Loss -Amp Factor + Reading.
2. The emission levels that are 20dB below the official limit are not reported.

Data: 13

File: E:\2012 Report\Rosewill\ACS12Q1608.EM6 (104)

Date: 2012-08-15

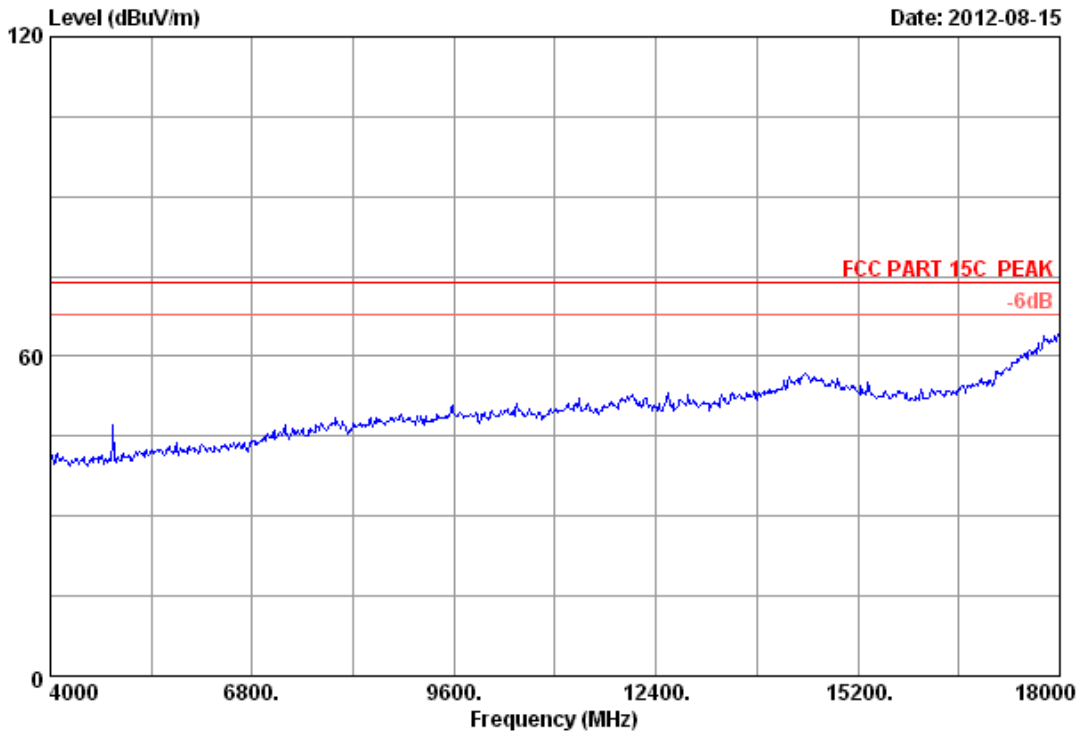

Site no. : 3m Chamber Data no. : 13  
Dis. / Ant. : 3m 2011 3115 4580 Ant. pol. : HORIZONTAL  
Limit : FCC PART 15C PEAK  
Env. / Ins. : 23°C/54% Engineer : Leo-Li  
EUT : 300Mbps Wireless N Router  
Power supply : DC 9V From Adapter Input AC 120V/60Hz  
Test mode : IEEE802.11b CH6 2437MHz Tx  
M/N : RNX-N360RT

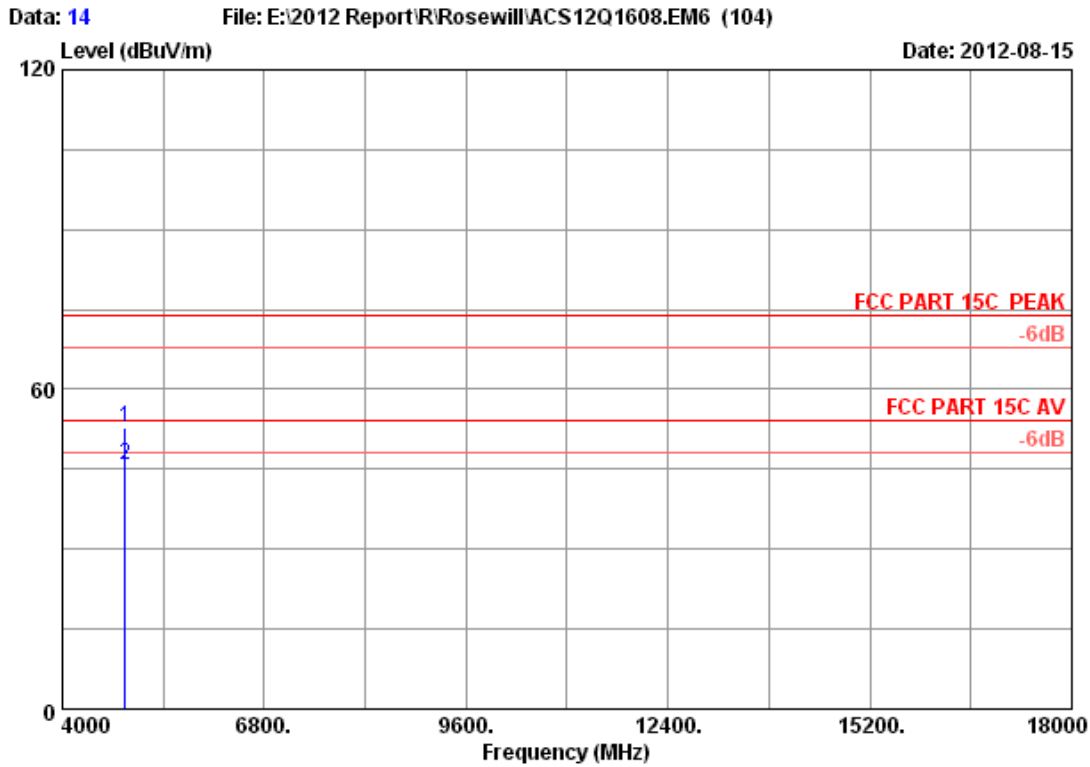

Site no. : 3m Chamber Data no. : 14  
 Dis. / Ant. : 3m 2011 3115 4580 Ant. pol. : HORIZONTAL  
 Limit : FCC PART 15C PEAK  
 Env. / Ins. : 23°C/54% Engineer : Leo-Li  
 EUT : 300Mbps Wireless N Router  
 Power supply : DC 9V From Adapter Input AC 120V/60Hz  
 Test mode : IEEE802.11b CH6 2437MHz Tx  
 M/N : RNX-N360RT

	Freq. (MHz)	Ant. Factor (dB/m)	Cable loss (dB)	Amp. Factor (dB)	Reading (dBuV)	Emission Level (dBuV/m)	Limits (dBuV/m)	Margin (dB)	Remark
1	4874.000	32.98	8.58	34.60	45.78	52.74	74.00	21.26	Peak
2	4874.000	32.98	8.58	34.60	38.69	45.65	54.00	8.35	Average

Remarks:

1. Emission Level= Antenna Factor + Cable Loss -Amp Factor + Reading.
2. The emission levels that are 20dB below the official limit are not reported.

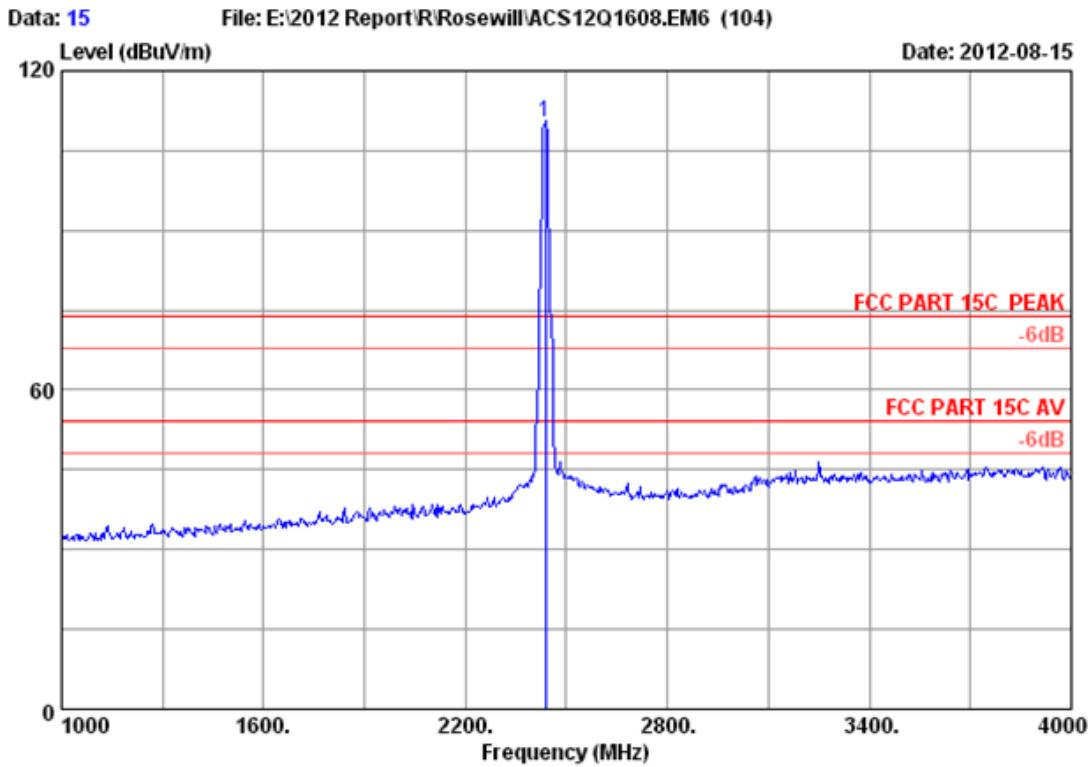

Site no. : 3m Chamber Data no. : 15  
 Dis. / Ant. : 3m 2011 3115 4580 Ant. pol. : VERTICAL  
 Limit : FCC PART 15C PEAK  
 Env. / Ins. : 23°C/54% Engineer : Leo-Li  
 EUT : 300Mbps Wireless N Router  
 Power supply : DC 9V From Adapter Input AC 120V/60Hz  
 Test mode : IEEE802.11b CH6 2437MHz Tx  
 M/N : RNX-N360RT

Freq. (MHz)	Ant. Factor (dB/m)	Cable loss (dB)	Amp. Factor (dB)	Reading (dBUV)	Emission			Remark
					Level (dBUV/m)	Limits (dBUV/m)	Margin (dB)	
1 2437.000	28.03	6.06	34.44	110.70	110.35	74.00	-36.35	Peak

Remarks:

1. Emission Level= Antenna Factor + Cable Loss -Amp Factor + Reading.
2. The emission levels that are 20dB below the official limit are not reported.

Data: 16 File: E:\2012 Report\R\Rosewill\ACS12Q1608.EM6 (104) Date: 2012-08-15

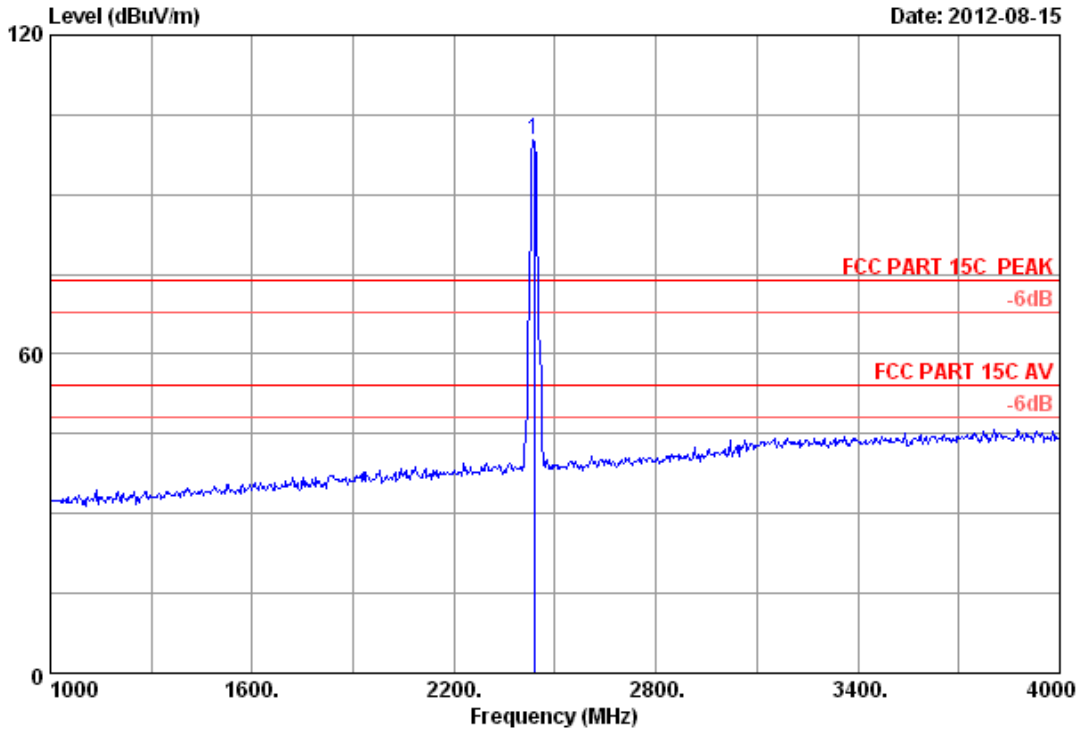

Site no. : 3m Chamber Data no. : 16  
 Dis. / Ant. : 3m 2011 3115 4580 Ant. pol. : HORIZONTAL  
 Limit : FCC PART 15C PEAK  
 Env. / Ins. : 23°C/54% Engineer : Leo-Li  
 EUT : 300Mbps Wireless N Router  
 Power supply : DC 9V From Adapter Input AC 120V/60Hz  
 Test mode : IEEE802.11b CH6 2437MHz Tx  
 M/N : RNX-N360RT

	Ant. Factor (dB/m)	Cable loss (dB)	Amp. Factor (dB)	Emission Reading (dBuV)	Emission Level (dBuV/m)	Limits (dBuV/m)	Margin (dB)	Remark
1	28.03	6.06	34.44	100.48	100.13	74.00	-26.13	Peak

Remarks:

1. Emission Level= Antenna Factor + Cable Loss -Amp Factor + Reading.
2. The emission levels that are 20dB below the official limit are not reported.

Data: 17

File: E:\2012 Report\R\Rosewill\ACS12Q1608.EM6 (104)

Date: 2012-08-15

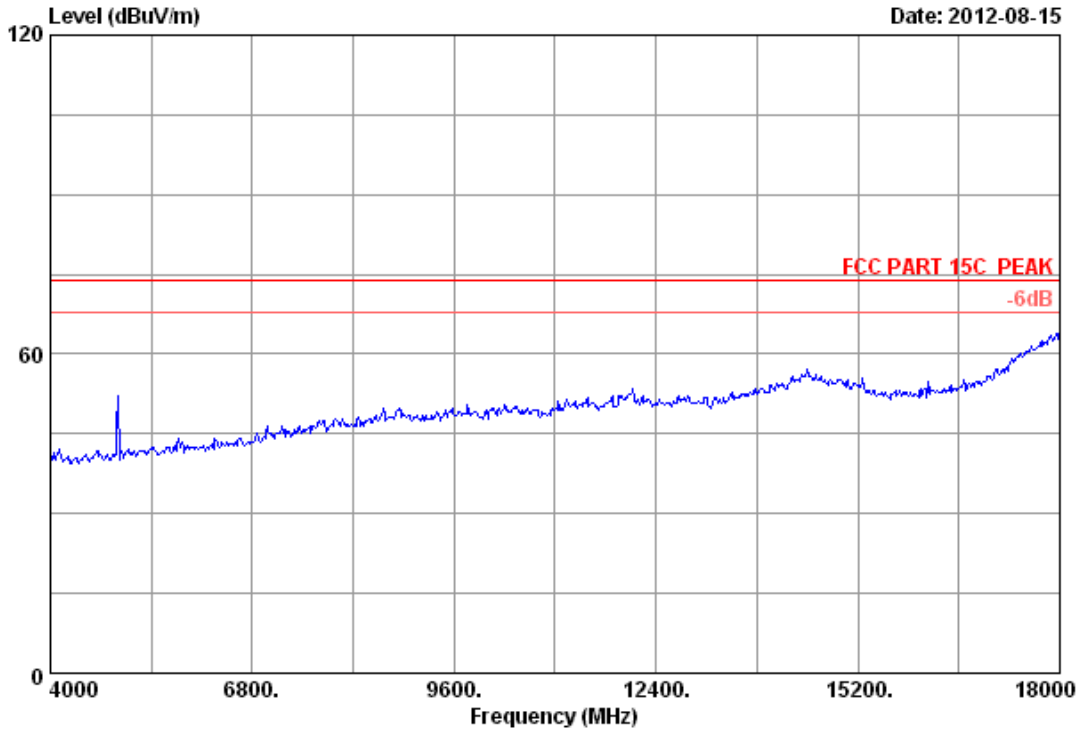

Site no. : 3m Chamber                      Data no. : 17  
Dis. / Ant. : 3m 2011 3115 4580            Ant. pol. : VERTICAL  
Limit : FCC PART 15C PEAK  
Env. / Ins. : 23\*C/54%                      Engineer : Leo-Li  
EUT : 300Mbps Wireless N Router  
Power supply : DC 9V From Adapter Input AC 120V/60Hz  
Test mode : IEEE802.11b CH11 2462MHz Tx  
M/N : RNX-N360RT



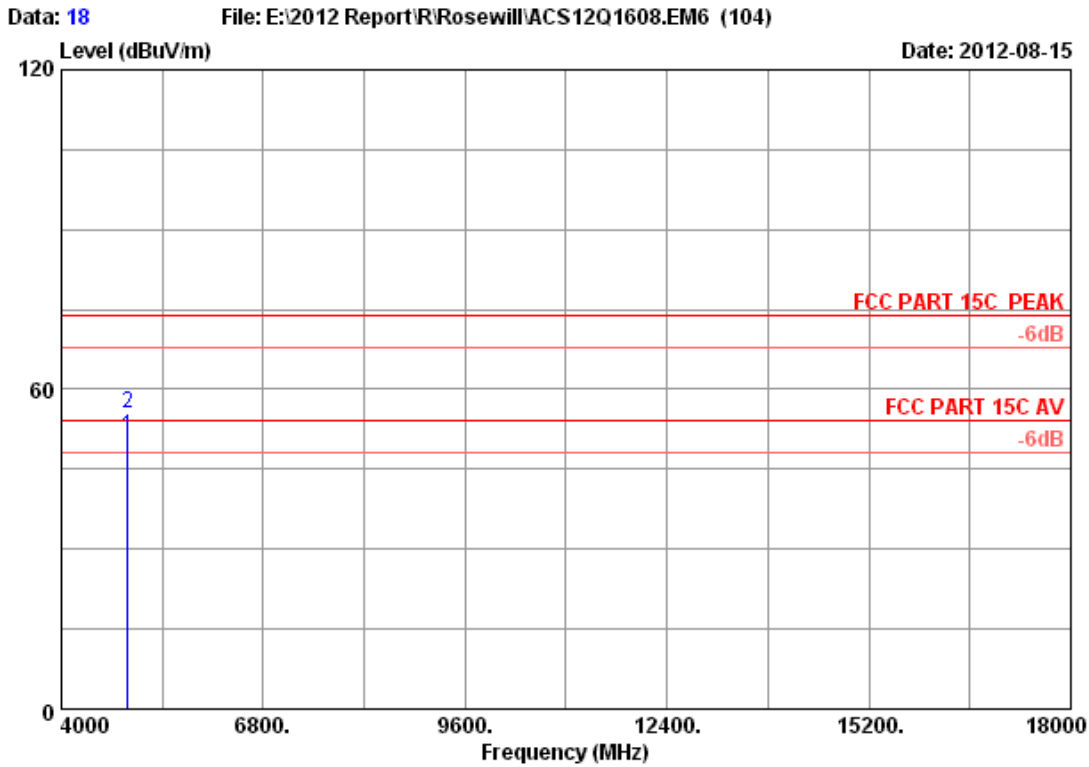

Site no. : 3m Chamber Data no. : 18  
 Dis. / Ant. : 3m 2011 3115 4580 Ant. pol. : VERTICAL  
 Limit : FCC PART 15C PEAK  
 Env. / Ins. : 23°C/54% Engineer : Leo-Li  
 EUT : 300Mbps Wireless N Router  
 Power supply : DC 9V From Adapter Input AC 120V/60Hz  
 Test mode : IEEE802.11b CH11 2462MHz Tx  
 M/N : RNX-N360RT

	Freq. (MHz)	Ant. Factor (dB/m)	Cable loss (dB)	Amp. Factor (dB)	Reading (dBuV)	Emission Level (dBuV/m)	Limits (dBuV/m)	Margin (dB)	Remark
1	4924.000	33.08	8.62	34.60	44.12	51.22	54.00	2.78	Average
2	4924.000	33.08	8.62	34.60	48.44	55.54	74.00	18.46	Peak

Remarks:

1. Emission Level= Antenna Factor + Cable Loss -Amp Factor + Reading.
2. The emission levels that are 20dB below the official limit are not reported.

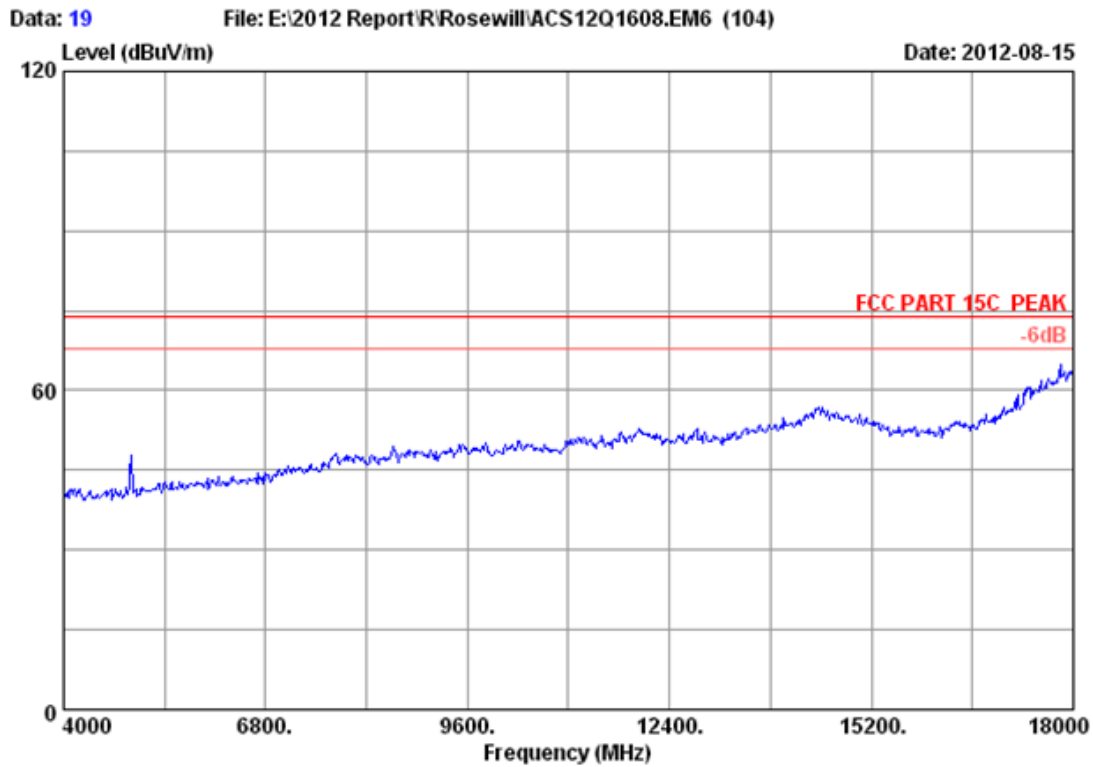

Site no. : 3m Chamber Data no. : 19  
Dis. / Ant. : 3m 2011 3115 4580 Ant. pol. : HORIZONTAL  
Limit : FCC PART 15C PEAK  
Env. / Ins. : 23°C/54% Engineer : Leo-Li  
EUT : 300Mbps Wireless N Router  
Power supply : DC 9V From Adapter Input AC 120V/60Hz  
Test mode : IEEE802.11b CH11 2462MHz Tx  
M/N : RNX-N360RT

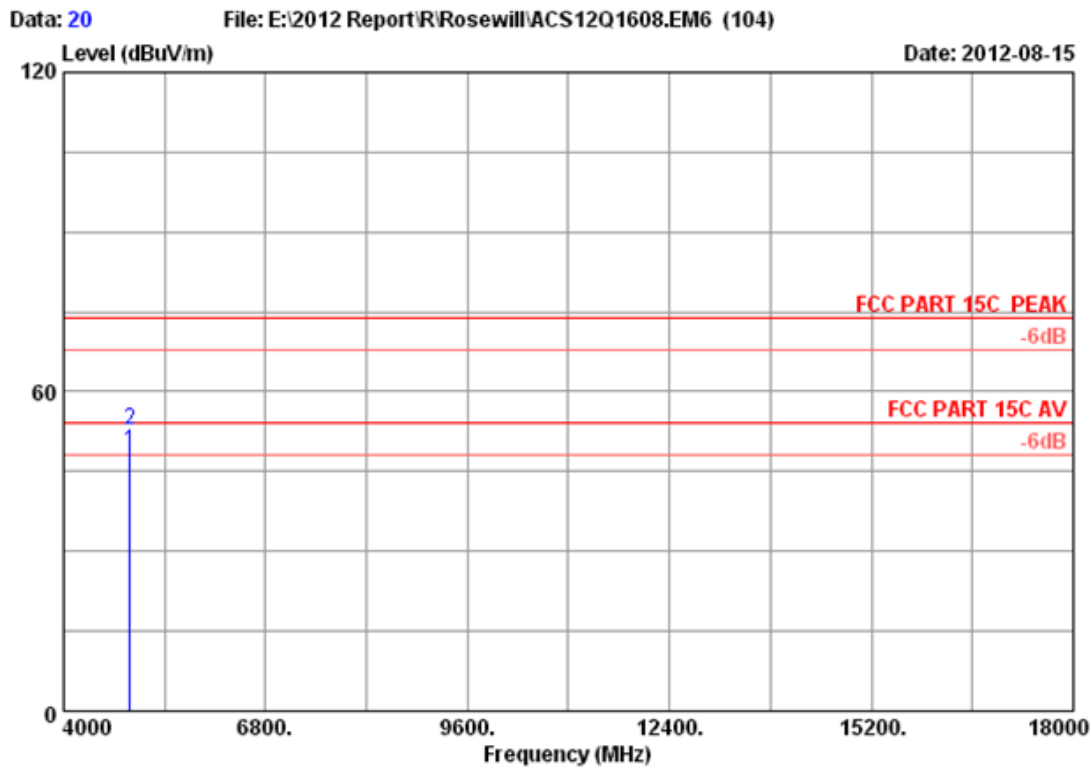

Site no. : 3m Chamber Data no. : 20  
 Dis. / Ant. : 3m 2011 3115 4580 Ant. pol. : HORIZONTAL  
 Limit : FCC PART 15C PEAK  
 Env. / Ins. : 23°C/54% Engineer : Leo-Li  
 EUT : 300Mbps Wireless N Router  
 Power supply : DC 9V From Adapter Input AC 120V/60Hz  
 Test mode : IEEE802.11b CH11 2462MHz Tx  
 M/N : RNX-N360RT

	Freq. (MHz)	Ant. Factor (dB/m)	Cable loss (dB)	Amp. Factor (dB)	Reading (dBuV)	Emission Level (dBuV/m)	Limits (dBuV/m)	Margin (dB)	Remark
1	4924.000	33.08	8.62	34.60	41.56	48.66	54.00	5.34	Average
2	4924.000	33.08	8.62	34.60	45.73	52.83	74.00	21.17	Peak

Remarks:

1. Emission Level= Antenna Factor + Cable Loss -Amp Factor + Reading.
2. The emission levels that are 20dB below the official limit are not reported.

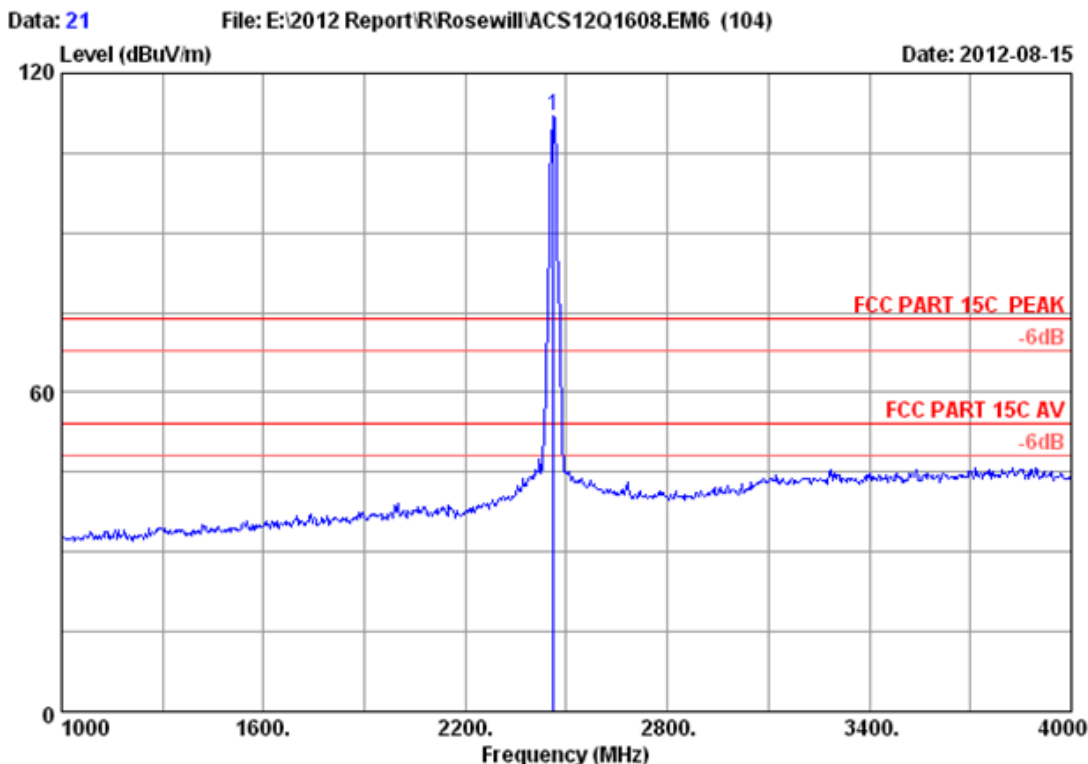

Site no. : 3m Chamber Data no. : 21  
 Dis. / Ant. : 3m 2011 3115 4580 Ant. pol. : VERTICAL  
 Limit : FCC PART 15C PEAK  
 Env. / Ins. : 23°C/54% Engineer : Leo-Li  
 EUT : 300Mbps Wireless N Router  
 Power supply : DC 9V From Adapter Input AC 120V/60Hz  
 Test mode : IEEE802.11b CH11 2462MHz Tx  
 M/N : RNX-N360RT

	Freq. (MHz)	Ant. Factor (dB/m)	Cable loss (dB)	Amp. Factor (dB)	Reading (dBUV)	Emission Level (dBUV/m)	Limits (dBUV/m)	Margin (dB)	Remark
1	2462.000	28.05	6.12	34.44	112.15	111.88	74.00	-37.88	Peak

Remarks:

1. Emission Level= Antenna Factor + Cable Loss -Amp Factor + Reading.
2. The emission levels that are 20dB below the official limit are not reported.

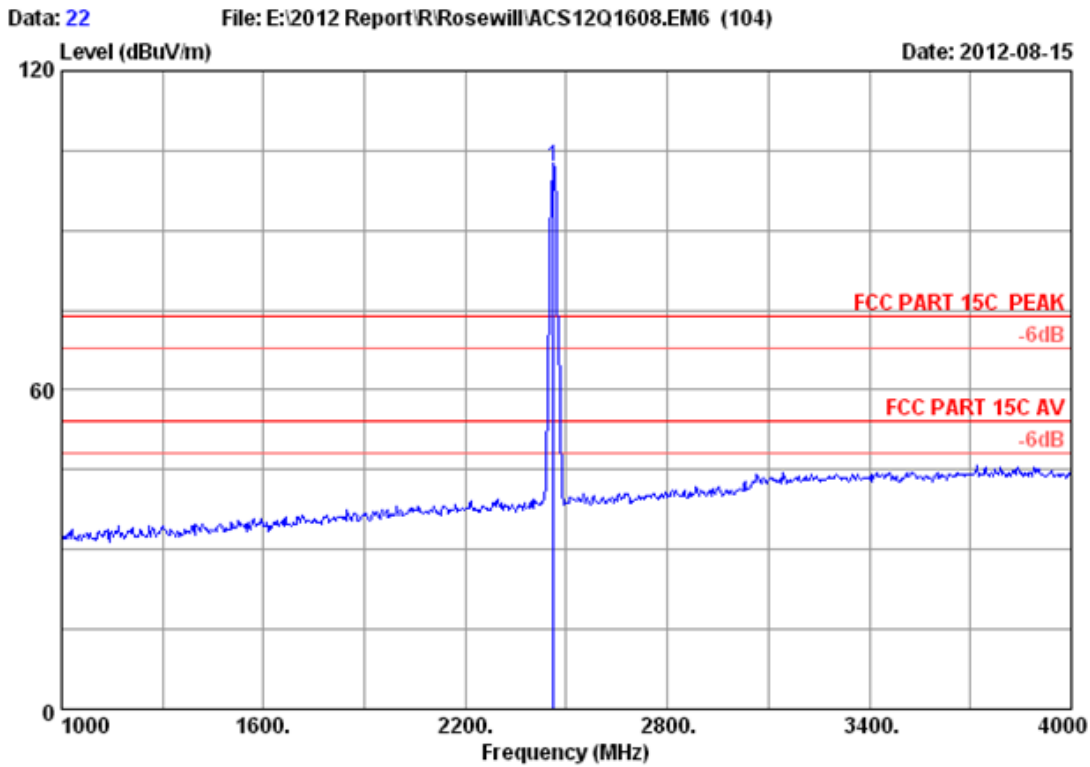

Site no. : 3m Chamber Data no. : 22  
 Dis. / Ant. : 3m 2011 3115 4580 Ant. pol. : HORIZONTAL  
 Limit : FCC PART 15C PEAK  
 Env. / Ins. : 23°C/54% Engineer : Leo-Li  
 EUT : 300Mbps Wireless N Router  
 Power supply : DC 9V From Adapter Input AC 120V/60Hz  
 Test mode : IEEE802.11b CH11 2462MHz Tx  
 M/N : RNX-N360RT

1	Freq. (MHz)	Ant. Factor (dB/m)	Cable loss (dB)	Amp. Factor (dB)	Reading (dBuV)	Emission			Remark
						Level (dBuV/m)	Limits (dBuV/m)	Margin (dB)	
	2462.000	28.05	6.12	34.44	102.31	102.04	74.00	-28.04	Peak

Remarks:

1. Emission Level= Antenna Factor + Cable Loss -Amp Factor + Reading.
2. The emission levels that are 20dB below the official limit are not reported.

Data: 31 File: E:\2012 Report\R\Rosewill\ACS12Q1608.EM6 (104) Date: 2012-08-15

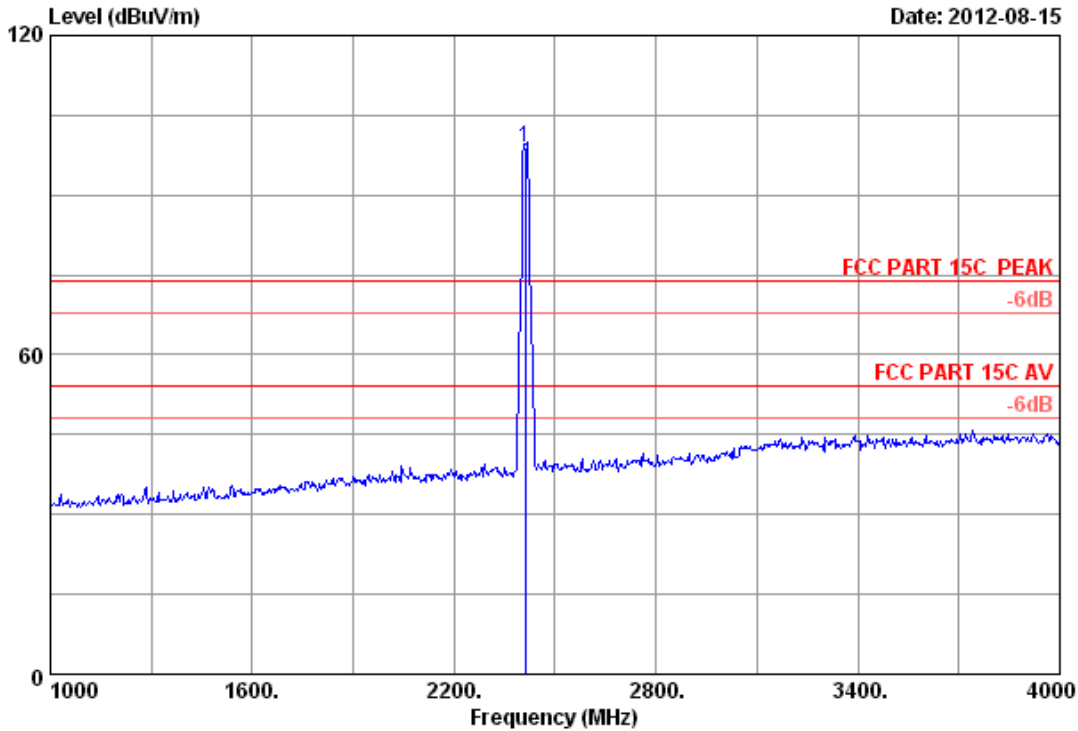

Site no. : 3m Chamber Data no. : 31  
 Dis. / Ant. : 3m 2011 3115 4580 Ant. pol. : HORIZONTAL  
 Limit : FCC PART 15C PEAK  
 Env. / Ins. : 23°C/54% Engineer : Leo-Li  
 EUT : 300Mbps Wireless N Router  
 Power supply : DC 9V From Adapter Input AC 120V/60Hz  
 Test mode : IEEE802.11g CH1 2412MHz Tx  
 M/N : RNX-N360RT

	Freq. (MHz)	Ant. Factor (dB/m)	Cable loss (dB)	Amp. Factor (dB)	Reading (dBuV)	Emission Level (dBuV/m)	Limits (dBuV/m)	Margin (dB)	Remark
1	2412.000	27.98	6.03	34.44	99.35	98.92	74.00	-24.92	Peak

Remarks:

1. Emission Level= Antenna Factor + Cable Loss -amp Factor + Reading.
2. The emission levels that are 20dB below the official limit are not reported.

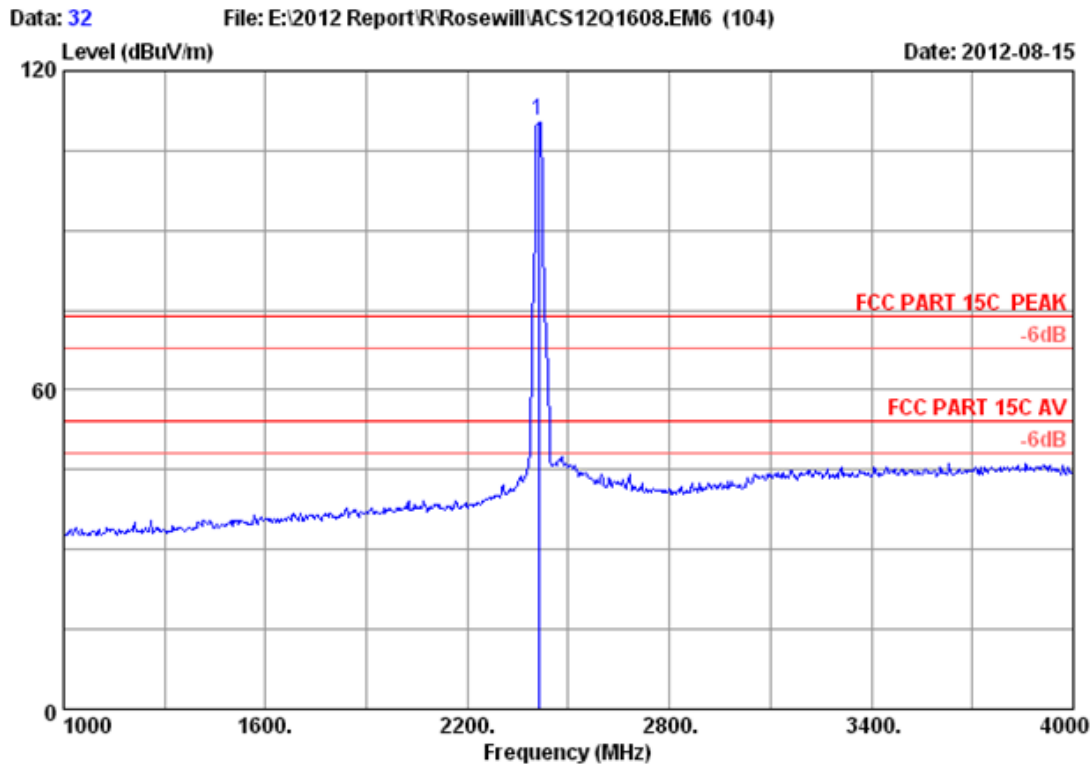

Site no. : 3m Chamber Data no. : 32  
 Dis. / Ant. : 3m 2011 3115 4580 Ant. pol. : VERTICAL  
 Limit : FCC PART 15C PEAK  
 Env. / Ins. : 23°C/54% Engineer : Leo-Li  
 EUT : 300Mbps Wireless N Router  
 Power supply : DC 9V From Adapter Input AC 120V/60Hz  
 Test mode : IEEE802.11g CH1 2412MHz Tx  
 M/N : RNX-N360RT

	Ant. Factor (dB/m)	Cable loss (dB)	Amp. Factor (dB)	Reading (dBuV)	Emission Level (dBuV/m)	Limits (dBuV/m)	Margin (dB)	Remark
1	27.98	6.03	34.44	110.94	110.51	74.00	-36.51	Peak

Remarks:

1. Emission Level= Antenna Factor + Cable Loss -Amp Factor + Reading.
2. The emission levels that are 20dB below the official limit are not reported.

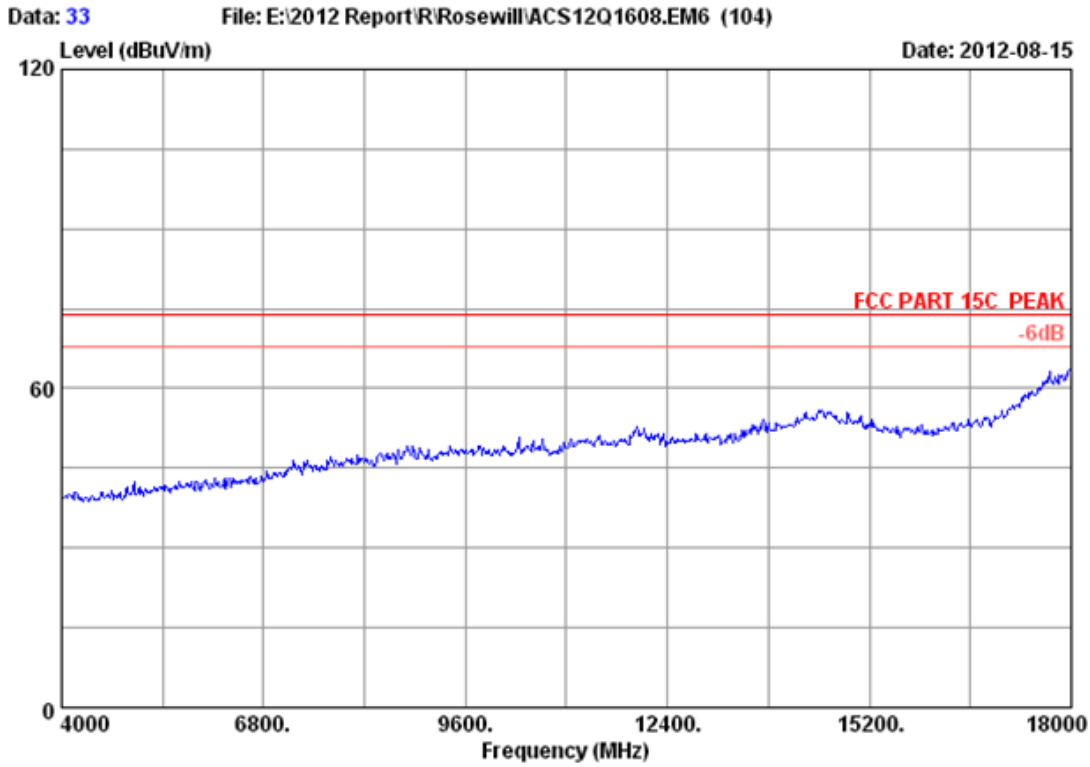

Site no. : 3m Chamber Data no. : 33  
Dis. / Ant. : 3m 2011 3115 4580 Ant. pol. : VERTICAL  
Limit : FCC PART 15C PEAK  
Env. / Ins. : 23\*C/54% Engineer : Leo-Li  
EUT : 300Mbps Wireless N Router  
Power supply : DC 9V From Adapter Input AC 120V/60Hz  
Test mode : IEEE802.11g CH1 2412MHz Tx  
M/N : RNX-N360RT



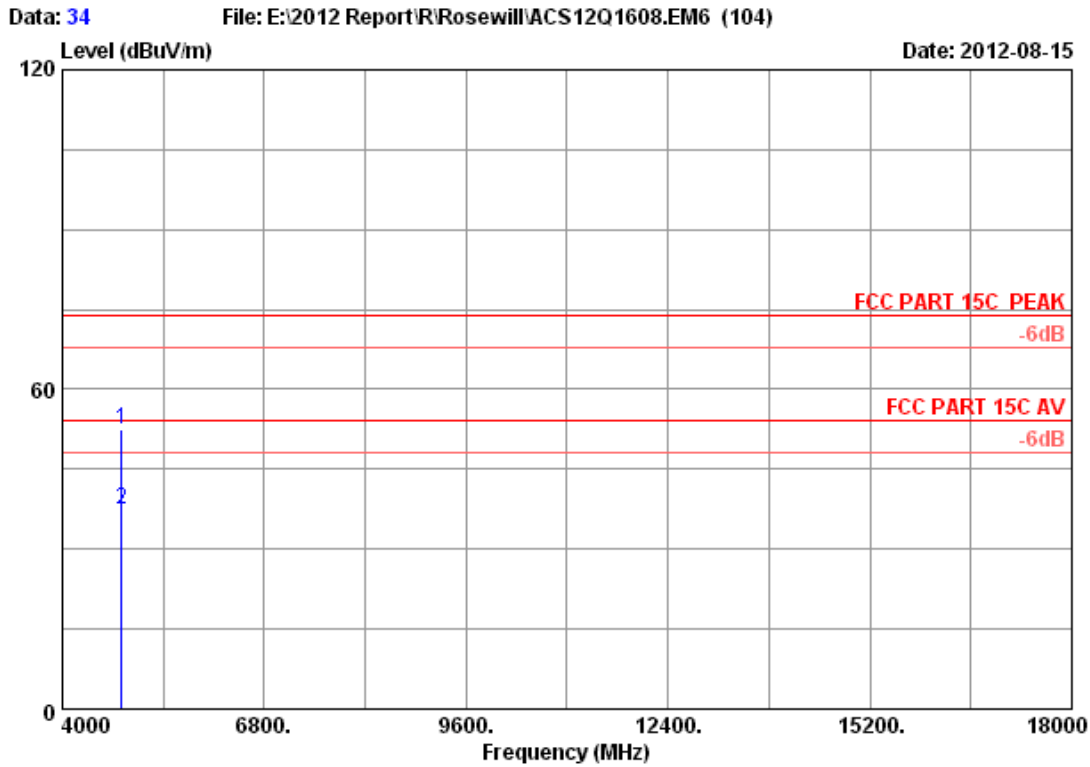

Site no. : 3m Chamber Data no. : 34  
 Dis. / Ant. : 3m 2011 3115 4580 Ant. pol. : VERTICAL  
 Limit : FCC PART 15C PEAK  
 Env. / Ins. : 23°C/54% Engineer : Leo-Li  
 EUT : 300Mbps Wireless N Router  
 Power supply : DC 9V From Adapter Input AC 120V/60Hz  
 Test mode : IEEE802.11g CH1 2412MHz Tx  
 M/N : RNX-N360RT

	Freq. (MHz)	Ant. Factor (dB/m)	Cable loss (dB)	Amp. Factor (dB)	Reading (dBuV)	Emission Level (dBuV/m)	Limits (dBuV/m)	Margin (dB)	Remark
1	4824.000	32.89	8.53	34.60	45.66	52.48	74.00	21.52	Peak
2	4824.000	32.89	8.53	34.60	30.78	37.60	54.00	16.40	Average

Remarks:

1. Emission Level= Antenna Factor + Cable Loss -Amp Factor + Reading.
2. The emission levels that are 20dB below the official limit are not reported.

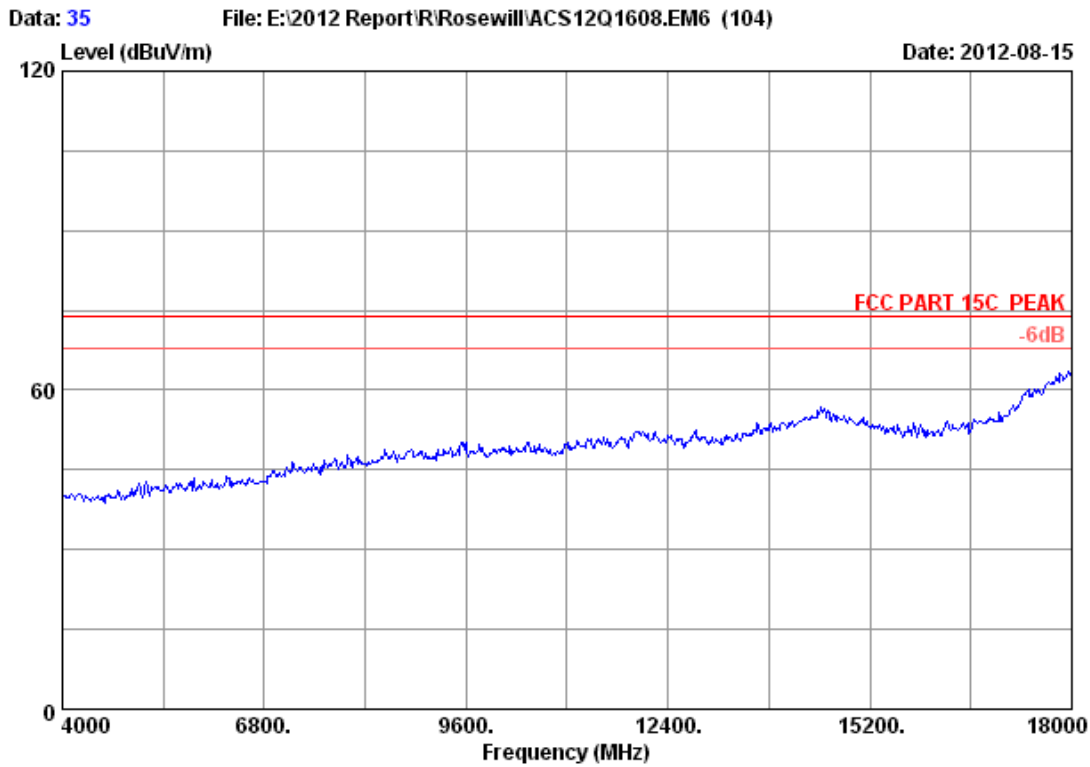

Site no. : 3m Chamber Data no. : 35  
Dis. / Ant. : 3m 2011 3115 4580 Ant. pol. : HORIZONTAL  
Limit : FCC PART 15C PEAK  
Env. / Ins. : 23°C/54% Engineer : Leo-Li  
EUT : 300Mbps Wireless N Router  
Power supply : DC 9V From Adapter Input AC 120V/60Hz  
Test mode : IEEE802.11g CH1 2412MHz Tx  
M/N : RNX-N360RT

Data: 36 File: E:\2012 Report\R\Rosewill\ACS12Q1608.EM6 (104) Date: 2012-08-15

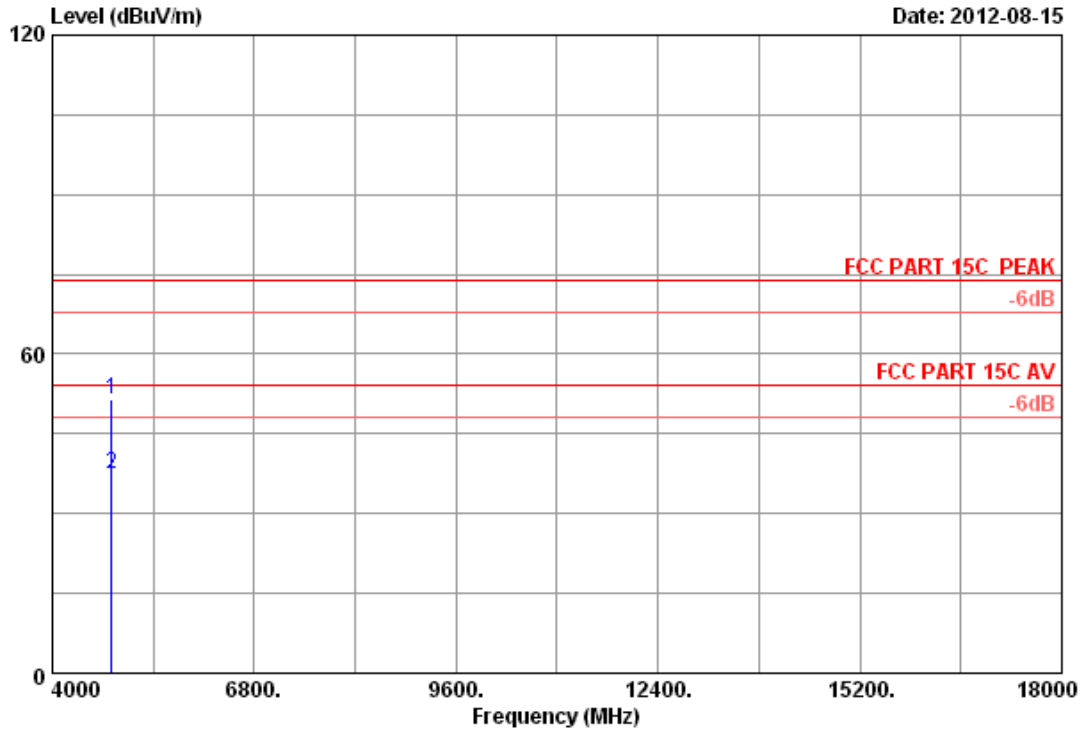

Site no. : 3m Chamber Data no. : 36  
 Dis. / Ant. : 3m 2011 3115 4580 Ant. pol. : HORIZONTAL  
 Limit : FCC PART 15C PEAK  
 Env. / Ins. : 23°C/54% Engineer : Leo-Li  
 EUT : 300Mbps Wireless N Router  
 Power supply : DC 9V From Adapter Input AC 120V/60Hz  
 Test mode : IEEE802.11g CH1 2412MHz Tx  
 M/N : RNX-N360RT

	Freq. (MHz)	Ant. Factor (dB/m)	Cable loss (dB)	Amp. Factor (dB)	Reading (dBUV)	Emission Level (dBUV/m)	Limits (dBUV/m)	Margin (dB)	Remark
1	4824.000	32.89	8.53	34.60	44.57	51.39	74.00	22.61	Peak
2	4824.000	32.89	8.53	34.60	30.52	37.34	54.00	16.66	Average

Remarks:

1. Emission Level= Antenna Factor + Cable Loss -Amp Factor + Reading.
2. The emission levels that are 20dB below the official limit are not reported.

Data: 37 File: E:\2012 Report\Rosewill\ACS12Q1608.EM6 (104) Date: 2012-08-15

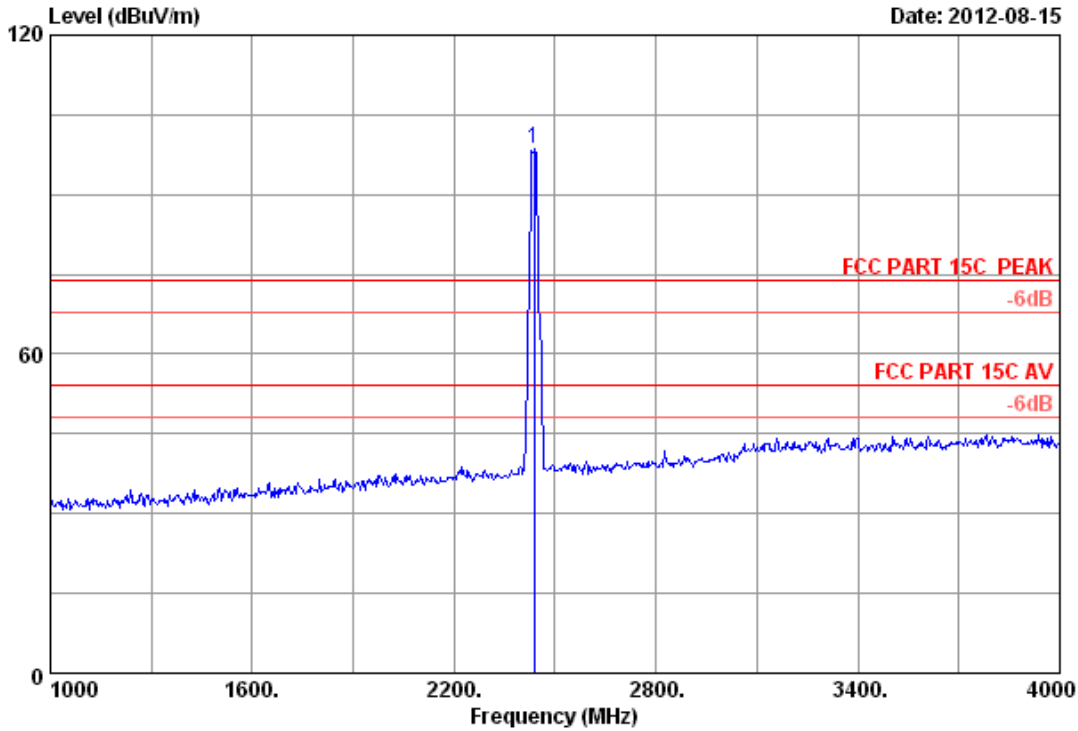

Site no. : 3m Chamber Data no. : 37  
 Dis. / Ant. : 3m 2011 3115 4580 Ant. pol. : HORIZONTAL  
 Limit : FCC PART 15C PEAK  
 Env. / Ins. : 23°C/54% Engineer : Leo-Li  
 EUT : 300Mbps Wireless N Router  
 Power supply : DC 9V From Adapter Input AC 120V/60Hz  
 Test mode : IEEE802.11g CH6 2437MHz Tx  
 M/N : RNX-N360RT

	Ant. Factor (dB/m)	Cable loss (dB)	Amp. Factor (dB)	Emission Reading (dBuV)	Emission Level (dBuV/m)	Limits (dBuV/m)	Margin (dB)	Remark
1	28.03	6.06	34.44	98.94	98.59	74.00	-24.59	Peak

Remarks:

1. Emission Level= Antenna Factor + Cable Loss -Amp Factor + Reading.
2. The emission levels that are 20dB below the official limit are not reported.

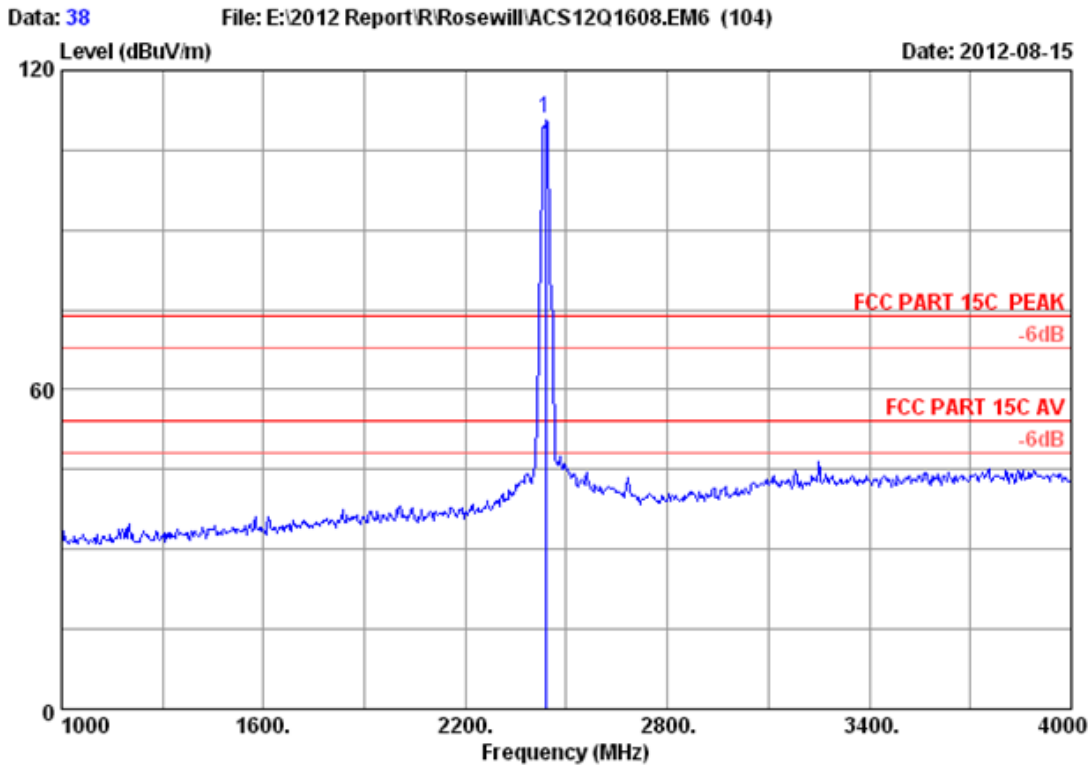

Site no. : 3m Chamber Data no. : 38  
 Dis. / Ant. : 3m 2011 3115 4580 Ant. pol. : VERTICAL  
 Limit : FCC PART 15C PEAK  
 Env. / Ins. : 23°C/54% Engineer : Leo-Li  
 EUT : 300Mbps Wireless N Router  
 Power supply : DC 9V From Adapter Input AC 120V/60Hz  
 Test mode : IEEE802.11g CH6 2437MHz Tx  
 M/N : RNX-N360RT

	Freq. (MHz)	Ant. Factor (dB/m)	Cable loss (dB)	Amp. Factor (dB)	Reading (dBuV)	Emission Level (dBuV/m)	Limits (dBuV/m)	Margin (dB)	Remark
1	2437.000	28.03	6.06	34.44	111.25	110.90	74.00	-36.90	Peak

Remarks:

1. Emission Level= Antenna Factor + Cable Loss -Amp Factor + Reading.
2. The emission levels that are 20dB below the official limit are not reported.

Data: 39 File: E:\2012 Report\R\Rosewill\ACS12Q1608.EM6 (104) Date: 2012-08-15

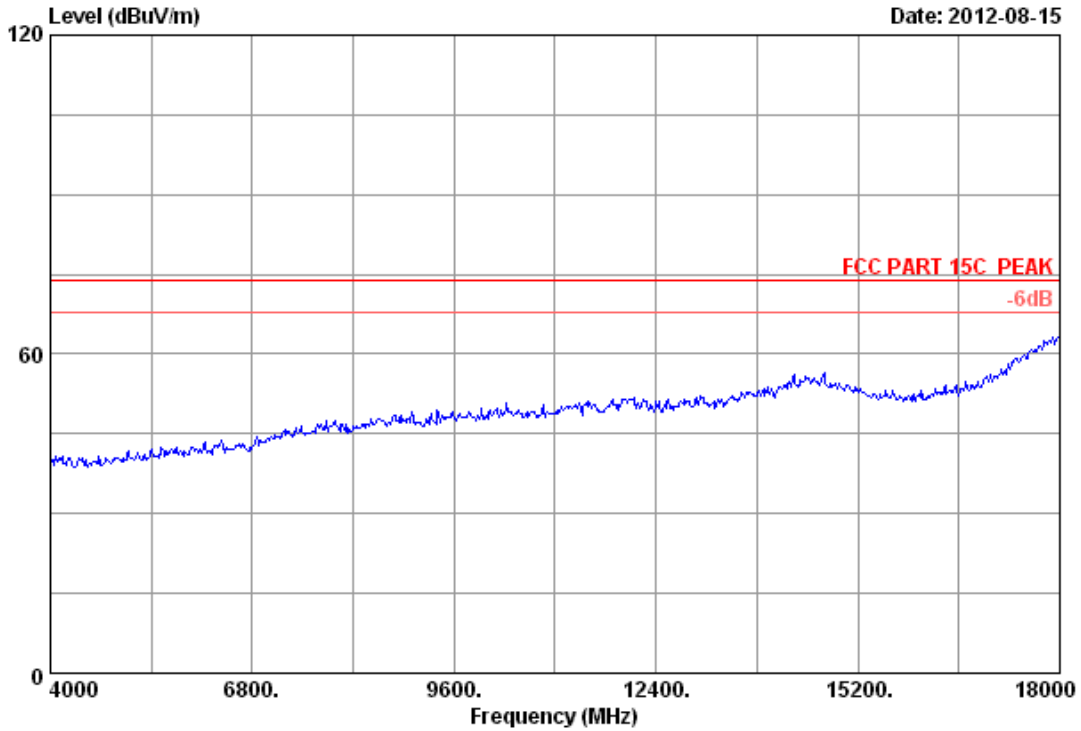

Site no. : 3m Chamber Data no. : 39  
Dis. / Ant. : 3m 2011 3115 4580 Ant. pol. : HORIZONTAL  
Limit : FCC PART 15C PEAK  
Env. / Ins. : 23\*C/54% Engineer : Leo-Li  
EUT : 300Mbps Wireless N Router  
Power supply : DC 9V From Adapter Input AC 120V/60Hz  
Test mode : IEEE802.11g CH6 2437MHz Tx  
M/N : RNX-N360RT

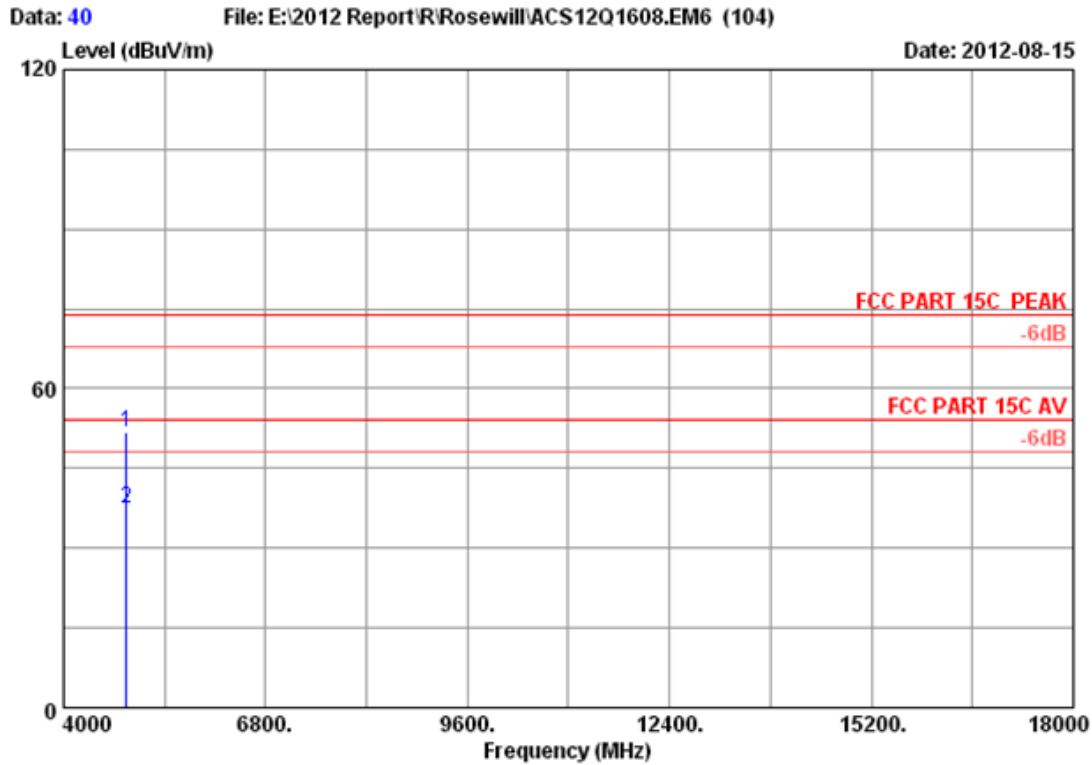

Site no. : 3m Chamber Data no. : 40  
 Dis. / Ant. : 3m 2011 3115 4580 Ant. pol. : HORIZONTAL  
 Limit : FCC PART 15C PEAK  
 Env. / Ins. : 23°C/54% Engineer : Leo-Li  
 EUT : 300Mbps Wireless N Router  
 Power supply : DC 9V From Adapter Input AC 120V/60Hz  
 Test mode : IEEE802.11g CH6 2437MHz Tx  
 M/N : RNX-N360RT

	Freq. (MHz)	Ant. Factor (dB/m)	Cable loss (dB)	Amp. Factor (dB)	Reading (dBuV)	Emission Level (dBuV/m)	Limits (dBuV/m)	Margin (dB)	Remark
1	4874.000	32.98	8.58	34.60	44.95	51.91	74.00	22.09	Peak
2	4874.000	32.98	8.58	34.60	30.56	37.52	54.00	16.48	Average

Remarks:

1. Emission Level= Antenna Factor + Cable Loss -Amp Factor + Reading.
2. The emission levels that are 20dB below the official limit are not reported.

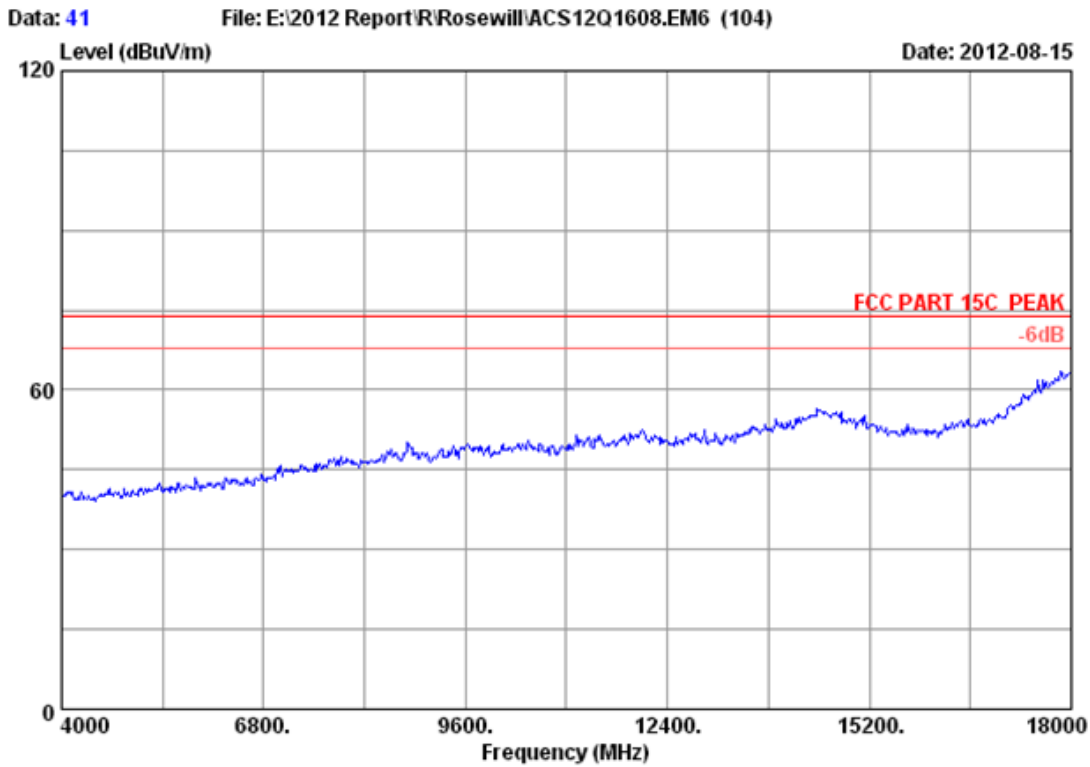

Site no. : 3m Chamber Data no. : 41  
Dis. / Ant. : 3m 2011 3115 4580 Ant. pol. : VERTICAL  
Limit : FCC PART 15C PEAK  
Env. / Ins. : 23°C/54% Engineer : Leo-Li  
EUT : 300Mbps Wireless N Router  
Power supply : DC 9V From Adapter Input AC 120V/60Hz  
Test mode : IEEE802.11g CH6 2437MHz Tx  
M/N : RNX-N360RT



Data: 42 File: E:\2012 Report\R\Rosewill\ACS12Q1608.EM6 (104) Date: 2012-08-15

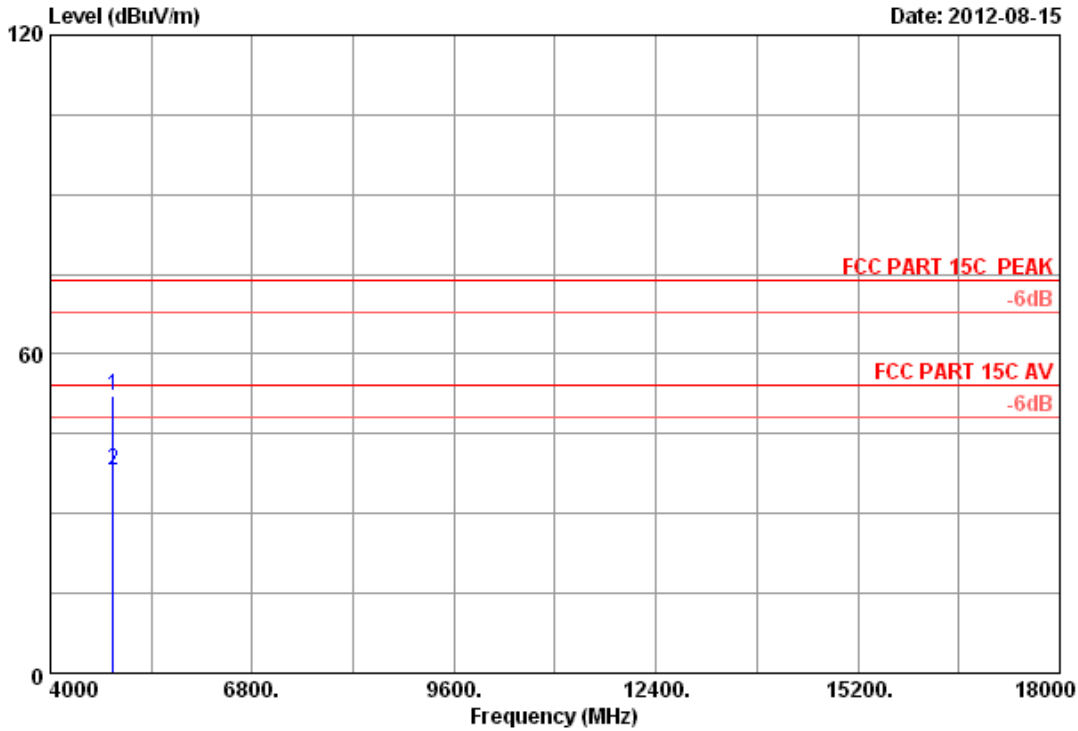

Site no. : 3m Chamber Data no. : 42  
 Dis. / Ant. : 3m 2011 3115 4580 Ant. pol. : VERTICAL  
 Limit : FCC PART 15C PEAK  
 Env. / Ins. : 23°C/54% Engineer : Leo-Li  
 EUT : 300Mbps Wireless N Router  
 Power supply : DC 9V From Adapter Input AC 120V/60Hz  
 Test mode : IEEE802.11g CH6 2437MHz Tx  
 M/N : RNX-N360RT

	Freq. (MHz)	Ant. Factor (dB/m)	Cable loss (dB)	Amp. Factor (dB)	Reading (dBuV)	Emission Level (dBuV/m)	Limits (dBuV/m)	Margin (dB)	Remark
1	4874.000	32.98	8.58	34.60	45.28	52.24	74.00	21.76	Peak
2	4874.000	32.98	8.58	34.60	31.24	38.20	54.00	15.80	Average

Remarks:

1. Emission Level= Antenna Factor + Cable Loss -Amp Factor + Reading.
2. The emission levels that are 20dB below the official limit are not reported.

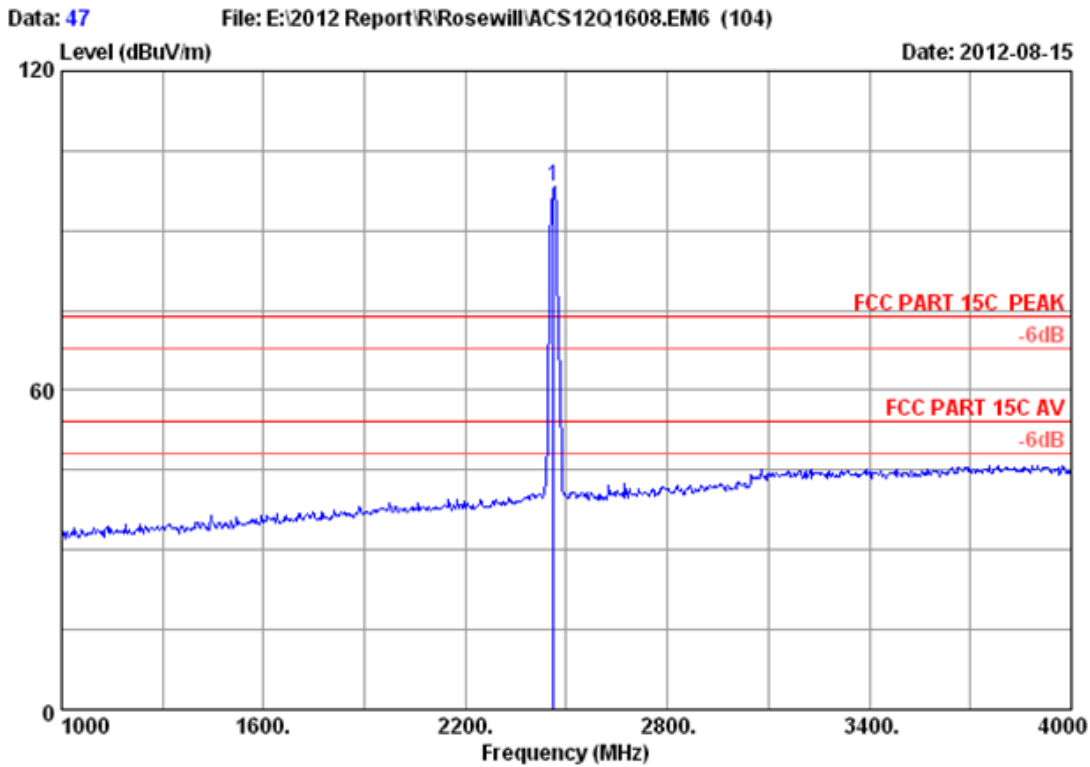

Site no. : 3m Chamber Data no. : 47  
 Dis. / Ant. : 3m 2011 3115 4580 Ant. pol. : HORIZONTAL  
 Limit : FCC PART 15C PEAK  
 Env. / Ins. : 23°C/54% Engineer : Leo-Li  
 EUT : 300Mbps Wireless N Router  
 Power supply : DC 9V From Adapter Input AC 120V/60Hz  
 Test mode : IEEE802.11g CH11 2462MHz Tx  
 M/N : RNX-N360RT

	Freq. (MHz)	Ant. Factor (dB/m)	Cable loss (dB)	Amp. Factor (dB)	Reading (dBuV)	Emission Level (dBuV/m)	Limits (dBuV/m)	Margin (dB)	Remark
1	2462.000	28.05	6.12	34.44	98.45	98.18	74.00	-24.18	Peak

Remarks:

1. Emission Level= Antenna Factor + Cable Loss -Amp Factor + Reading.
2. The emission levels that are 20dB below the official limit are not reported.

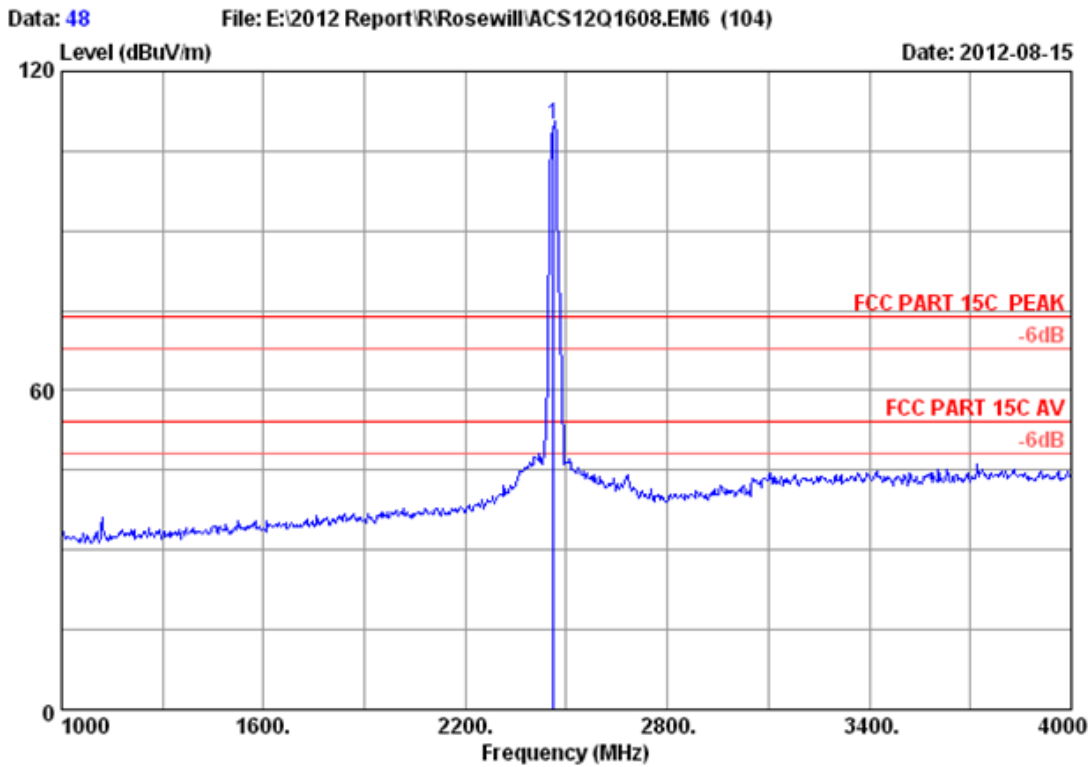

Site no. : 3m Chamber Data no. : 48  
 Dis. / Ant. : 3m 2011 3115 4580 Ant. pol. : VERTICAL  
 Limit : FCC PART 15C PEAK  
 Env. / Ins. : 23°C/54% Engineer : Leo-Li  
 EUT : 300Mbps Wireless N Router  
 Power supply : DC 9V From Adapter Input AC 120V/60Hz  
 Test mode : IEEE802.11g CH11 2462MHz Tx  
 M/N : RNX-N360RT

	Ant.	Cable	Amp.	Emission				
Freq.	Factor	loss	Factor	Reading	Level	Limits	Margin	Remark
(MHz)	(dB/m)	(dB)	(dB)	(dBuV)	(dBuV/m)	(dBuV/m)	(dB)	
1 2462.000	28.05	6.12	34.44	110.23	109.96	74.00	-35.96	Peak

Remarks:

1. Emission Level= Antenna Factor + Cable Loss - Amp Factor + Reading.
2. The emission levels that are 20dB below the official limit are not reported.

Data: 49 File: E:\2012 Report\R\Rosewill\ACS12Q1608.EM6 (104) Date: 2012-08-15

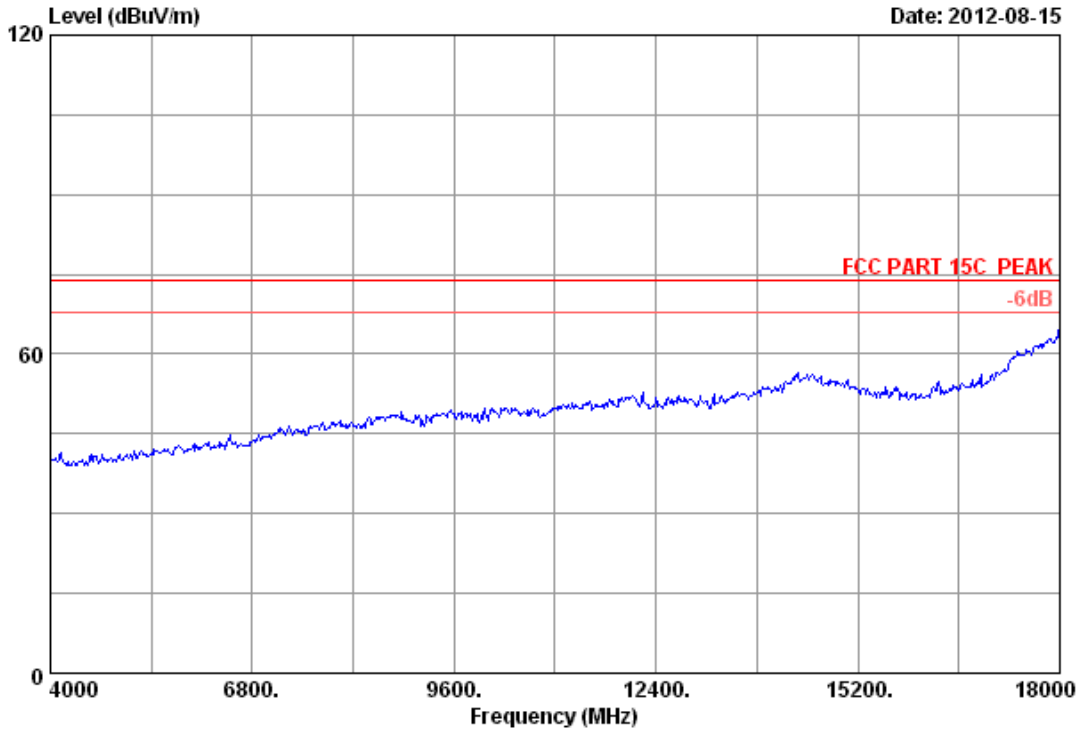

Site no. : 3m Chamber Data no. : 49  
Dis. / Ant. : 3m 2011 3115 4580 Ant. pol. : VERTICAL  
Limit : FCC PART 15C PEAK  
Env. / Ins. : 23\*C/54% Engineer : Leo-Li  
EUT : 300Mbps Wireless N Router  
Power supply : DC 9V From Adapter Input AC 120V/60Hz  
Test mode : IEEE802.11g CH11 2462MHz Tx  
M/N : RNX-N360RT

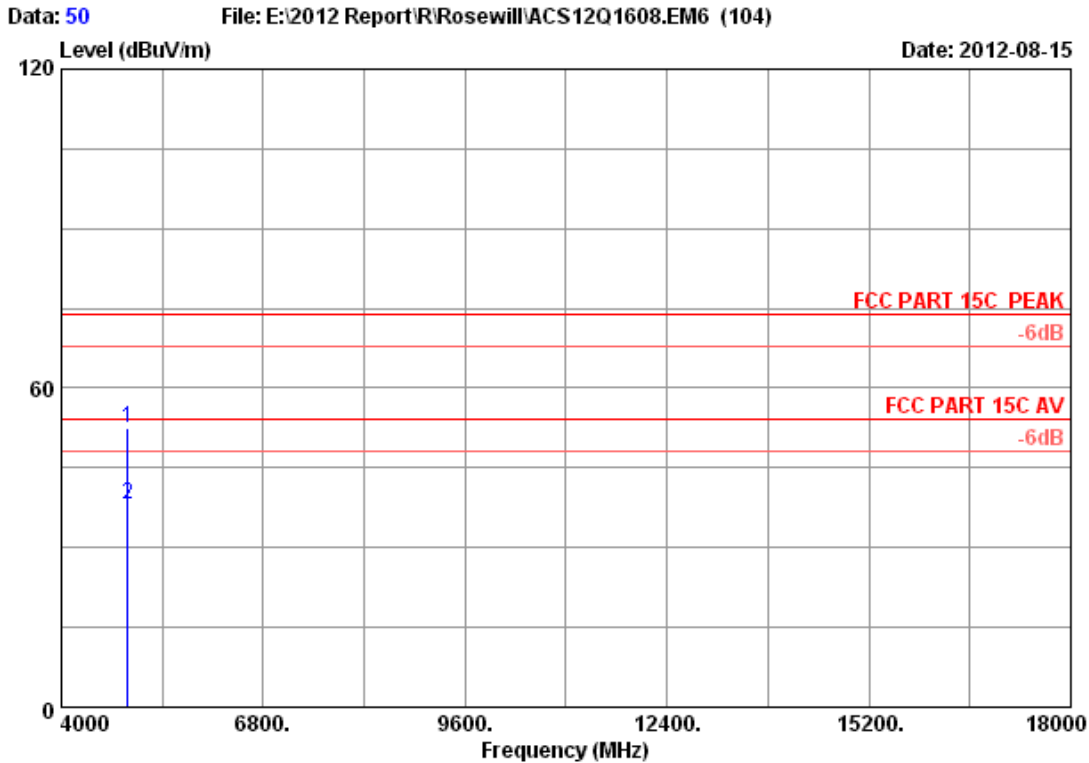

Site no. : 3m Chamber Data no. : 50  
 Dis. / Ant. : 3m 2011 3115 4580 Ant. pol. : VERTICAL  
 Limit : FCC PART 15C PEAK  
 Env. / Ins. : 23°C/54% Engineer : Leo-Li  
 EUT : 300Mbps Wireless N Router  
 Power supply : DC 9V From Adapter Input AC 120V/60Hz  
 Test mode : IEEE802.11g CH11 2462MHz Tx  
 M/N : RNX-N360RT

	Freq. (MHz)	Ant. Factor (dB/m)	Cable loss (dB)	Amp. Factor (dB)	Reading (dBUV)	Emission Level (dBUV/m)	Limits (dBUV/m)	Margin (dB)	Remark
1	4924.000	33.08	8.62	34.60	45.23	52.33	74.00	21.67	Peak
2	4924.000	33.08	8.62	34.60	31.02	38.12	54.00	15.88	Average

Remarks:

1. Emission Level= Antenna Factor + Cable Loss -Amp Factor + Reading.
2. The emission levels that are 20dB below the official limit are not reported.

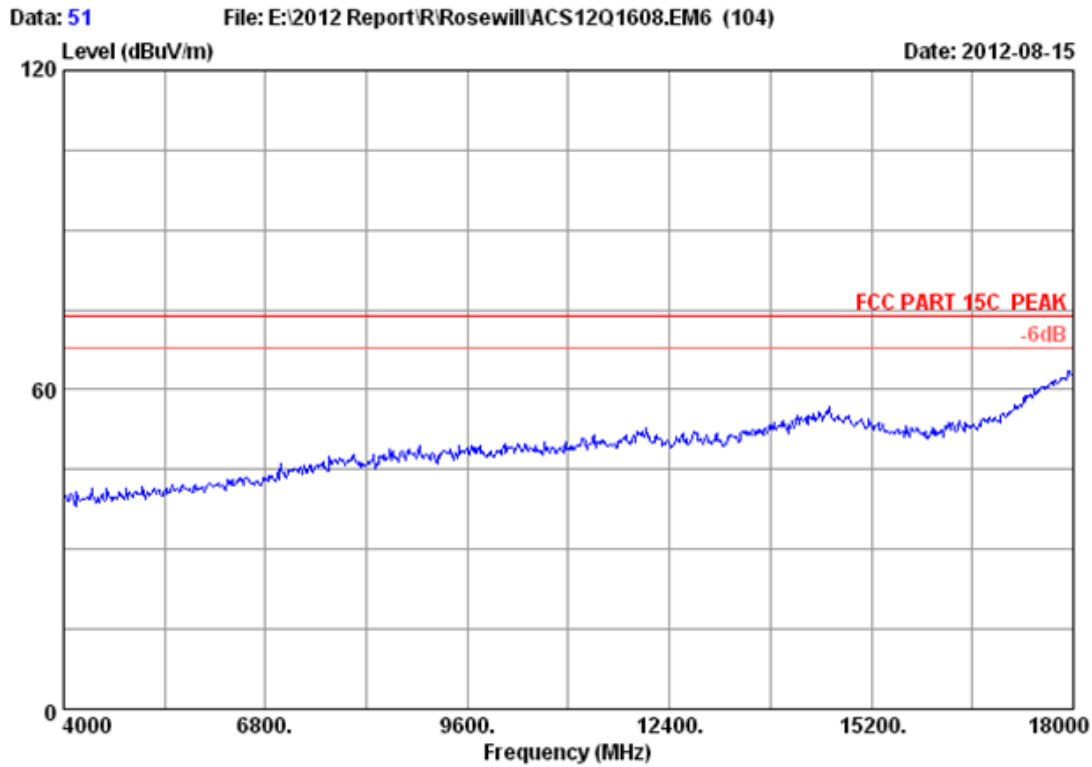

Site no. : 3m Chamber Data no. : 51  
Dis. / Ant. : 3m 2011 3115 4580 Ant. pol. : HORIZONTAL  
Limit : FCC PART 15C PEAK  
Env. / Ins. : 23°C/54% Engineer : Leo-Li  
EUT : 300Mbps Wireless N Router  
Power supply : DC 9V From Adapter Input AC 120V/60Hz  
Test mode : IEEE802.11g CH11 2462MHz Tx  
M/N : RNX-N360RT

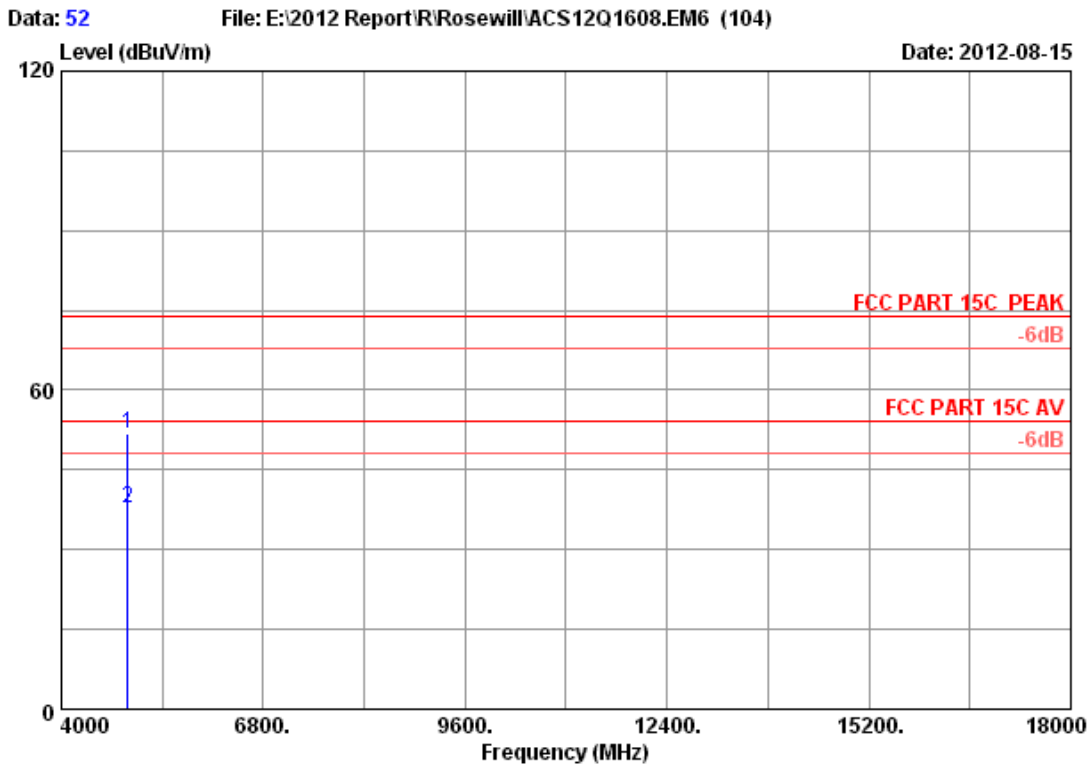

Site no. : 3m Chamber Data no. : 52  
 Dis. / Ant. : 3m 2011 3115 4580 Ant. pol. : HORIZONTAL  
 Limit : FCC PART 15C PEAK  
 Env. / Ins. : 23°C/54% Engineer : Leo-Li  
 EUT : 300Mbps Wireless N Router  
 Power supply : DC 9V From Adapter Input AC 120V/60Hz  
 Test mode : IEEE802.11g CH11 2462MHz Tx  
 M/N : RNX-N360RT

	Freq. (MHz)	Ant. Factor (dB/m)	Cable loss (dB)	Amp. Factor (dB)	Reading (dBUV)	Emission Level (dBUV/m)	Limits (dBUV/m)	Margin (dB)	Remark
1	4924.000	33.08	8.62	34.60	44.59	51.69	74.00	22.31	Peak
2	4924.000	33.08	8.62	34.60	30.71	37.81	54.00	16.19	Average

Remarks:

1. Emission Level= Antenna Factor + Cable Loss -Amp Factor + Reading.
2. The emission levels that are 20dB below the official limit are not reported.

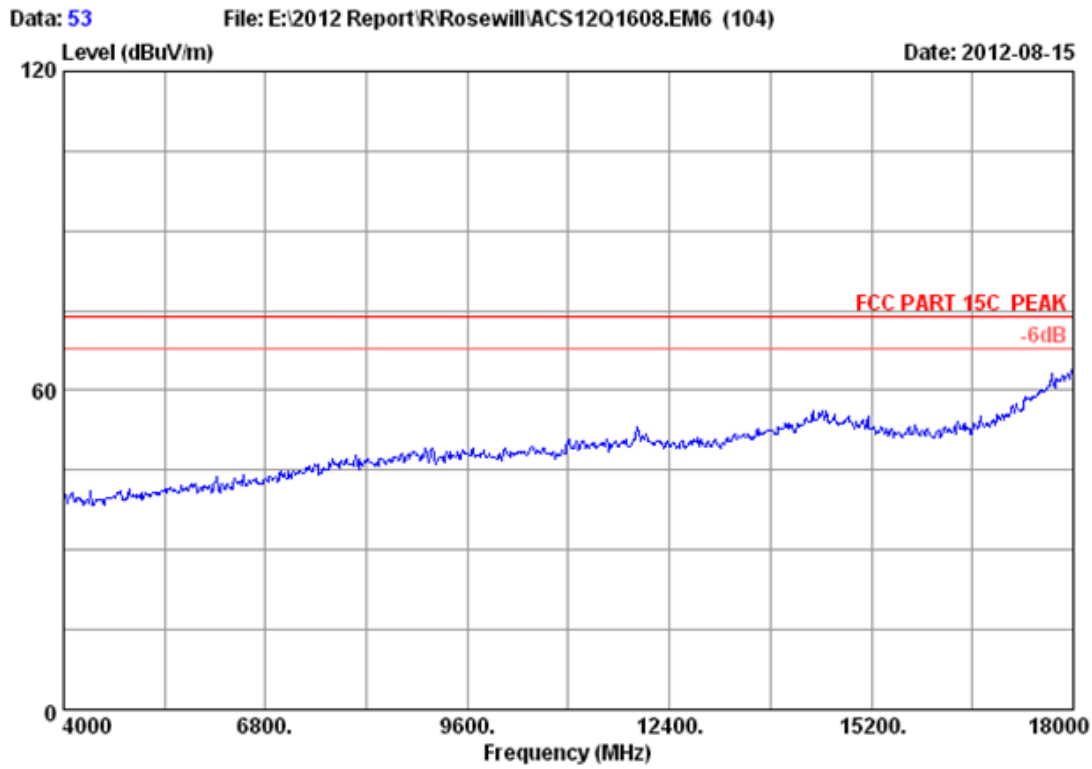

Site no. : 3m Chamber Data no. : 53  
Dis. / Ant. : 3m 2011 3115 4580 Ant. pol. : HORIZONTAL  
Limit : FCC PART 15C PEAK  
Env. / Ins. : 23°C/54% Engineer : Leo-Li  
EUT : 300Mbps Wireless N Router  
Power supply : DC 9V From Adapter Input AC 120V/60Hz  
Test mode : IEEE802.11nHT20 CH1 2412MHz Tx  
M/N : RNX-N360RT



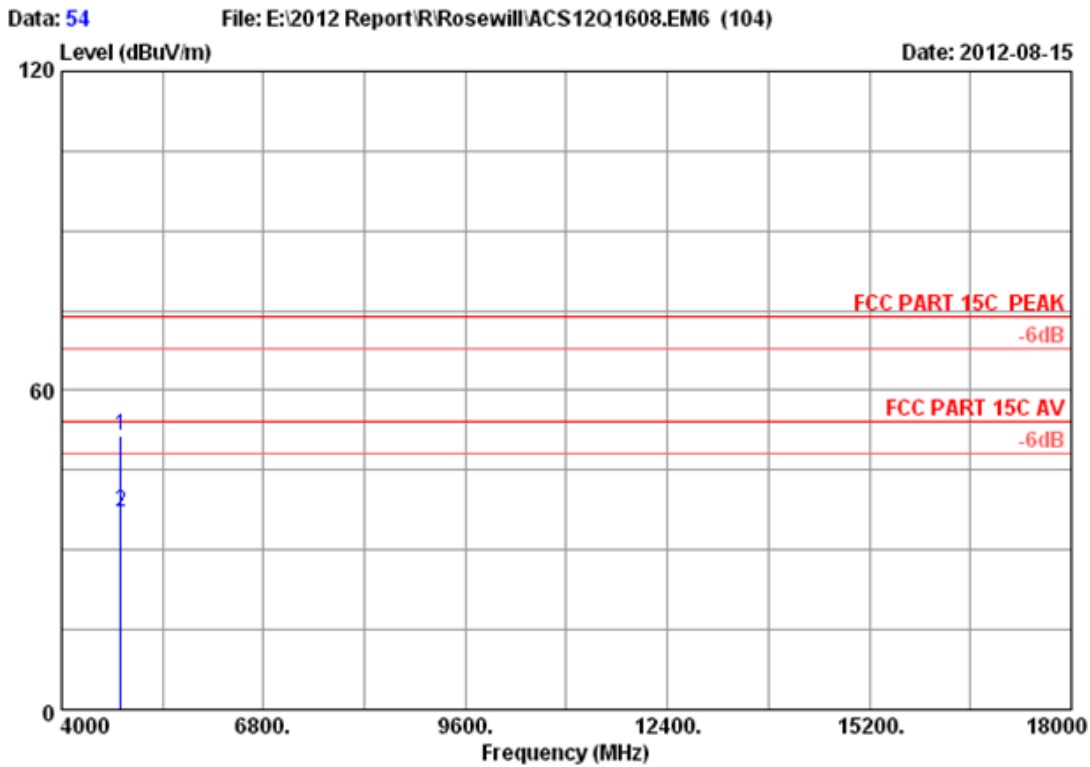

Site no. : 3m Chamber Data no. : 54  
 Dis. / Ant. : 3m 2011 3115 4580 Ant. pol. : HORIZONTAL  
 Limit : FCC PART 15C PEAK  
 Env. / Ins. : 23°C/54% Engineer : Leo-Li  
 EUT : 300Mbps Wireless N Router  
 Power supply : DC 9V From Adapter Input AC 120V/60Hz  
 Test mode : IEEE802.11nHT20 CH1 2412MHz Tx  
 M/N : RNX-N360RT

	Freq. (MHz)	Ant. Factor (dB/m)	Cable loss (dB)	Amp. Factor (dB)	Reading (dBUV)	Emission Level (dBUV/m)	Limits (dBUV/m)	Margin (dB)	Remark
1	4824.000	32.89	8.53	34.60	44.73	51.55	74.00	22.45	Peak
2	4824.000	32.89	8.53	34.60	30.41	37.23	54.00	16.77	Average

Remarks:

1. Emission Level= Antenna Factor + Cable Loss -Amp Factor + Reading.
2. The emission levels that are 20dB below the official limit are not reported.

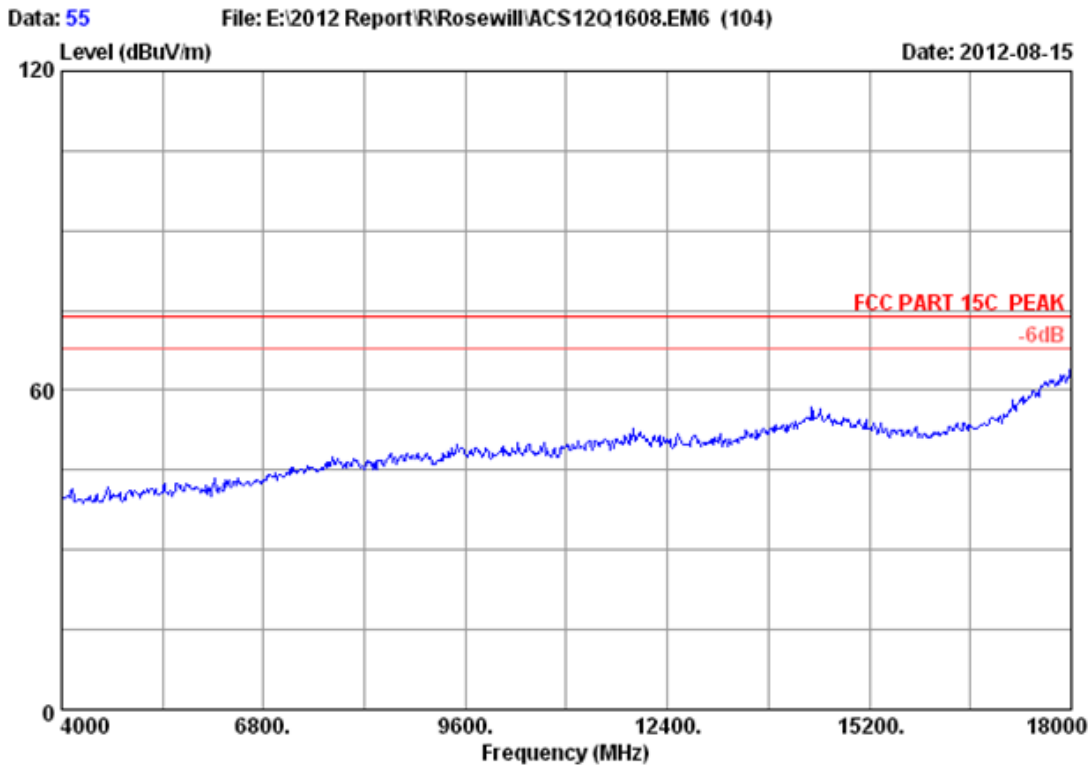

Site no. : 3m Chamber Data no. : 55  
Dis. / Ant. : 3m 2011 3115 4580 Ant. pol. : VERTICAL  
Limit : FCC PART 15C PEAK  
Env. / Ins. : 23°C/54% Engineer : Leo-Li  
EUT : 300Mbps Wireless N Router  
Power supply : DC 9V From Adapter Input AC 120V/60Hz  
Test mode : IEEE802.11nHT20 CH1 2412MHz Tx  
M/N : RNX-N360RT

Data: 56

File: E:\2012 Report\R\Rosewill\ACS12Q1608.EM6 (104)

Date: 2012-08-15

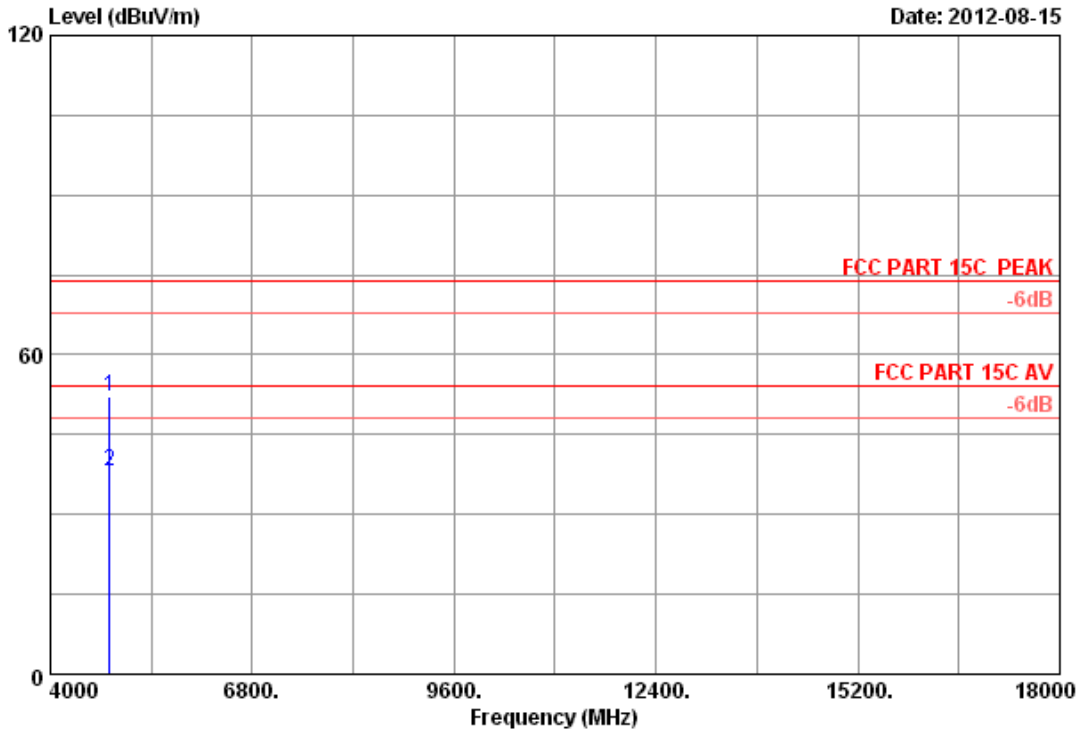

Site no. : 3m Chamber Data no. : 56  
 Dis. / Ant. : 3m 2011 3115 4580 Ant. pol. : VERTICAL  
 Limit : FCC PART 15C PEAK  
 Env. / Ins. : 23°C/54% Engineer : Leo-Li  
 EUT : 300Mbps Wireless N Router  
 Power supply : DC 9V From Adapter Input AC 120V/60Hz  
 Test mode : IEEE802.11nHT20 CH1 2412MHz Tx  
 M/N : RNX-N360RT

	Freq. (MHz)	Ant. Factor (dB/m)	Cable loss (dB)	Amp. Factor (dB)	Reading (dBuV)	Emission Level (dBuV/m)	Limits (dBuV/m)	Margin (dB)	Remark
1	4824.000	32.89	8.53	34.60	45.33	52.15	74.00	21.85	Peak
2	4824.000	32.89	8.53	34.60	31.12	37.94	54.00	16.06	Average

Remarks:

1. Emission Level= Antenna Factor + Cable Loss -Amp Factor + Reading.
2. The emission levels that are 20dB below the official limit are not reported.

Data: 61 File: E:\2012 Report\R\Rosewill\ACS12Q1608.EM6 (104) Date: 2012-08-15

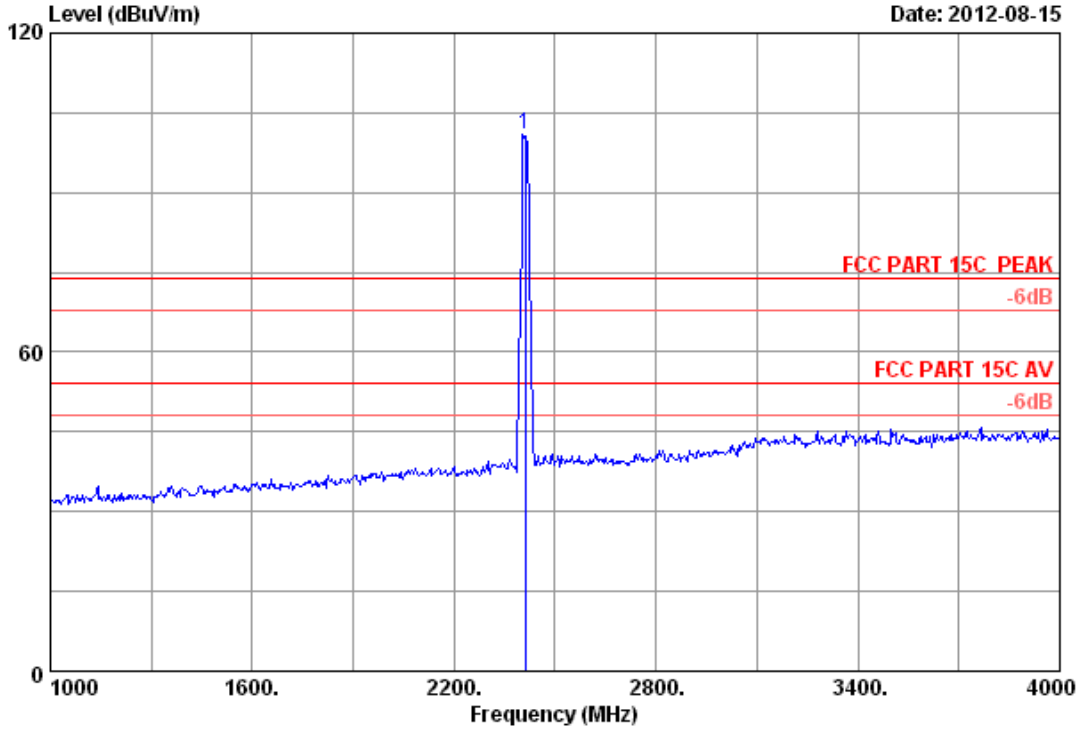

Site no. : 3m Chamber Data no. : 61  
 Dis. / Ant. : 3m 2011 3115 4580 Ant. pol. : HORIZONTAL  
 Limit : FCC PART 15C PEAK  
 Env. / Ins. : 23°C/54% Engineer : Leo-Li  
 EUT : 300Mbps Wireless N Router  
 Power supply : DC 9V From Adapter Input AC 120V/60Hz  
 Test mode : IEEE802.11nHT20 CH1 2412MHz Tx  
 M/N : RNX-N360RT

	Ant. Factor (dB/m)	Cable loss (dB)	Amp. Factor (dB)	Reading (dBUV)	Emission Level (dBUV/m)	Limits (dBUV/m)	Margin (dB)	Remark
1	27.98	6.03	34.44	101.48	101.05	74.00	-27.05	Peak

Remarks:

- Emission Level= Antenna Factor + Cable Loss -Amp Factor + Reading.
- The emission levels that are 20dB below the official limit are not reported.

Data: 62 File: E:\2012 Report\R\Rosewill\ACS12Q1608.EM6 (104) Date: 2012-08-15

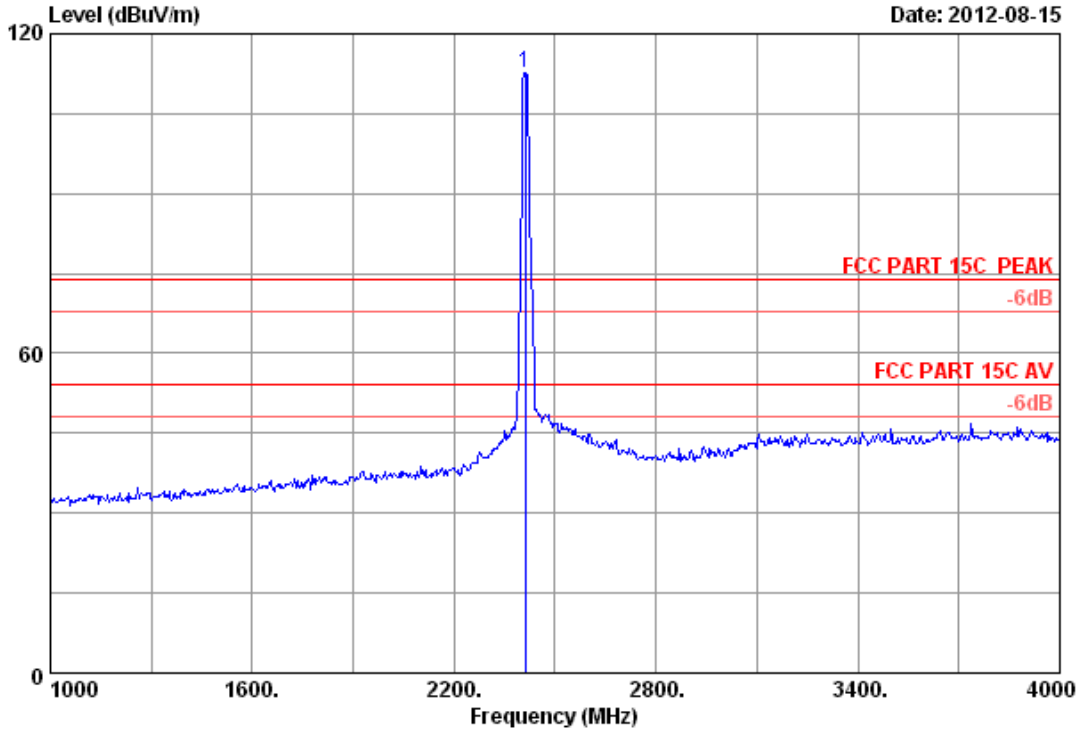

Site no. : 3m Chamber Data no. : 62  
 Dis. / Ant. : 3m 2011 3115 4580 Ant. pol. : VERTICAL  
 Limit : FCC PART 15C PEAK  
 Env. / Ins. : 23°C/54% Engineer : Leo-Li  
 EUT : 300Mbps Wireless N Router  
 Power supply : DC 9V From Adapter Input AC 120V/60Hz  
 Test mode : IEEE802.11nHT20 CH1 2412MHz Tx  
 M/N : RNX-N360RT

	Ant. Factor (dB/m)	Cable loss (dB)	Amp. Factor (dB)	Reading (dBuV)	Emission Level (dBuV/m)	Limits (dBuV/m)	Margin (dB)	Remark
1	27.98	6.03	34.44	112.98	112.55	74.00	-38.55	Peak

Remarks:

- Emission Level= Antenna Factor + Cable Loss -amp Factor + Reading.
- The emission levels that are 20dB below the official limit are not reported.

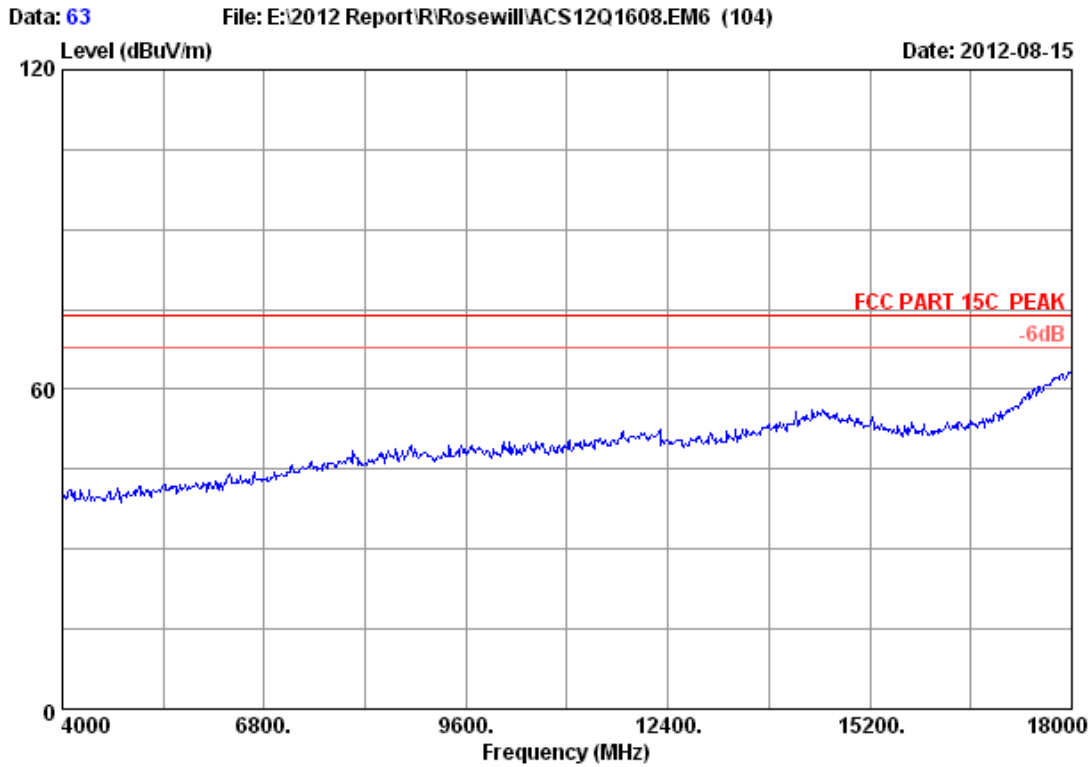

Site no. : 3m Chamber Data no. : 63  
Dis. / Ant. : 3m 2011 3115 4580 Ant. pol. : VERTICAL  
Limit : FCC PART 15C PEAK  
Env. / Ins. : 23°C/54% Engineer : Leo-Li  
EUT : 300Mbps Wireless N Router  
Power supply : DC 9V From Adapter Input AC 120V/60Hz  
Test mode : IEEE802.11nHT20 CH6 2437MHz Tx  
M/N : RNX-N360RT

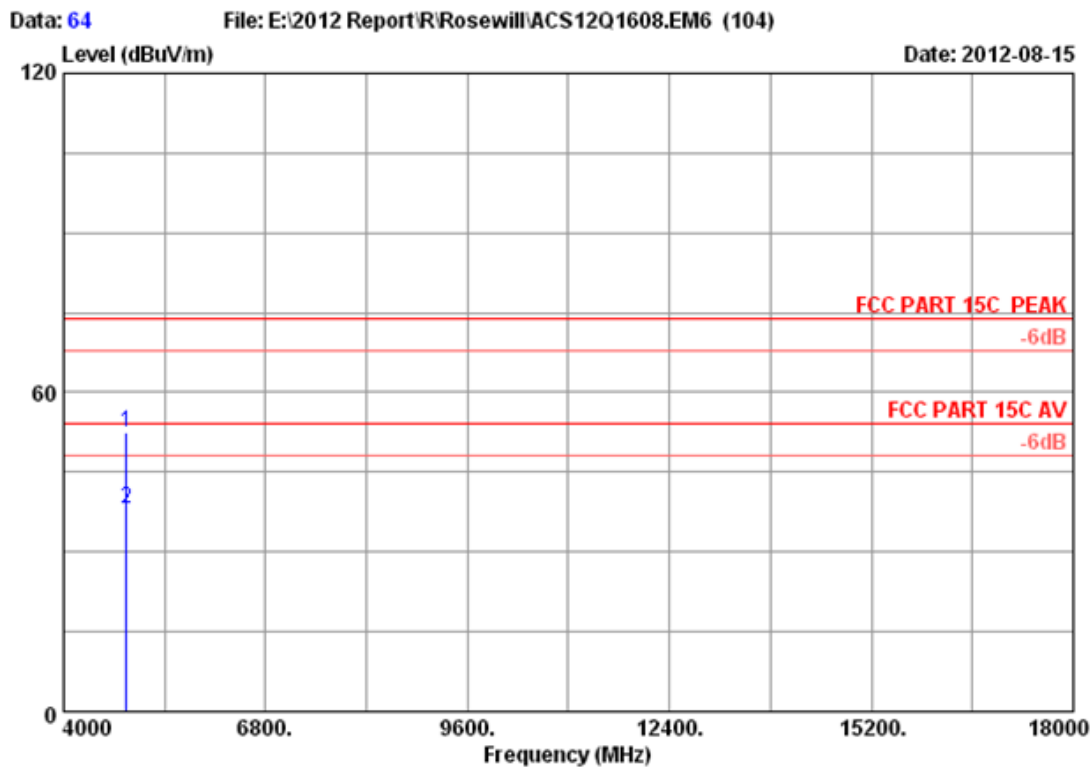

Site no. : 3m Chamber Data no. : 64  
 Dis. / Ant. : 3m 2011 3115 4580 Ant. pol. : VERTICAL  
 Limit : FCC PART 15C PEAK  
 Env. / Ins. : 23°C/54% Engineer : Leo-Li  
 EUT : 300Mbps Wireless N Router  
 Power supply : DC 9V From Adapter Input AC 120V/60Hz  
 Test mode : IEEE802.11nHT20 CH6 2437MHz Tx  
 M/N : RNX-N360RT

	Freq. (MHz)	Ant. Factor (dB/m)	Cable loss (dB)	Amp. Factor (dB)	Reading (dBUV)	Emission Level (dBUV/m)	Limits (dBUV/m)	Margin (dB)	Remark
1	4874.000	32.98	8.58	34.60	45.48	52.44	74.00	21.56	Peak
2	4874.000	32.98	8.58	34.60	31.09	38.05	54.00	15.95	Average

Remarks:

1. Emission Level= Antenna Factor + Cable Loss -Amp Factor + Reading.
2. The emission levels that are 20dB below the official limit are not reported.

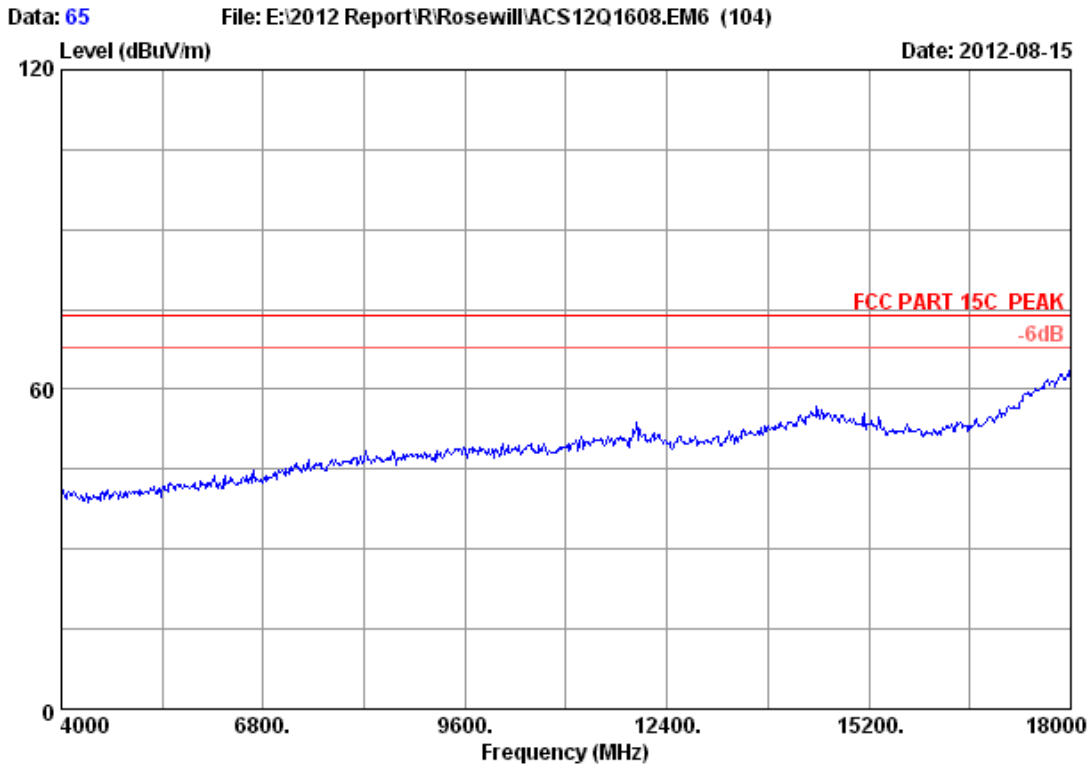

Site no. : 3m Chamber Data no. : 65  
Dis. / Ant. : 3m 2011 3115 4580 Ant. pol. : HORIZONTAL  
Limit : FCC PART 15C PEAK  
Env. / Ins. : 23°C/54% Engineer : Leo-Li  
EUT : 300Mbps Wireless N Router  
Power supply : DC 9V From Adapter Input AC 120V/60Hz  
Test mode : IEEE802.11nHT20 CH6 2437MHz Tx  
M/N : RNX-N360RT



Data: 66 File: E:\2012 Report\R\Rosewill\ACS12Q1608.EM6 (104) Date: 2012-08-15

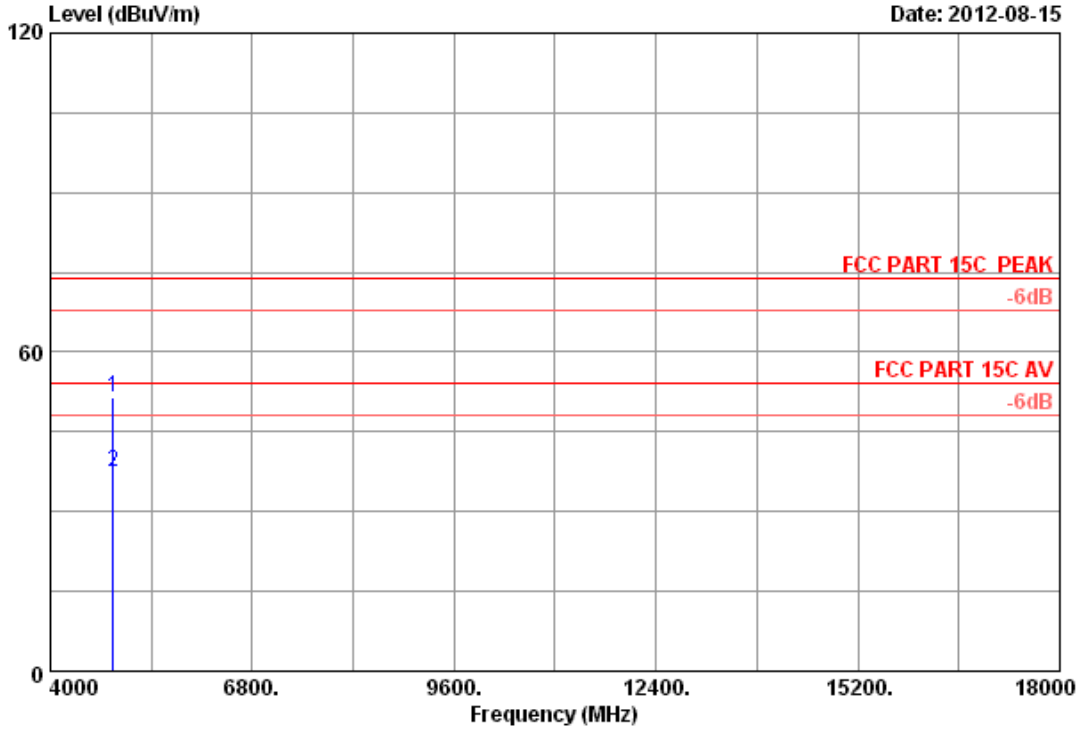

Site no. : 3m Chamber Data no. : 66  
 Dis. / Ant. : 3m 2011 3115 4580 Ant. pol. : HORIZONTAL  
 Limit : FCC PART 15C PEAK  
 Env. / Ins. : 23°C/54% Engineer : Leo-Li  
 EUT : 300Mbps Wireless N Router  
 Power supply : DC 9V From Adapter Input AC 120V/60Hz  
 Test mode : IEEE802.11nHT20 CH6 2437MHz Tx  
 M/N : RNX-N360RT

	Freq. (MHz)	Ant. Factor (dB/m)	Cable loss (dB)	Amp. Factor (dB)	Reading (dBuV)	Emission Level (dBuV/m)	Limits (dBuV/m)	Margin (dB)	Remark
1	4874.000	32.98	8.58	34.60	44.68	51.64	74.00	22.36	Peak
2	4874.000	32.98	8.58	34.60	30.47	37.43	54.00	16.57	Average

Remarks:

1. Emission Level= Antenna Factor + Cable Loss -Amp Factor + Reading.
2. The emission levels that are 20dB below the official limit are not reported.

Data: 67 File: E:\2012 Report\R\Rosewill\ACS12Q1608.EM6 (104) Date: 2012-08-15

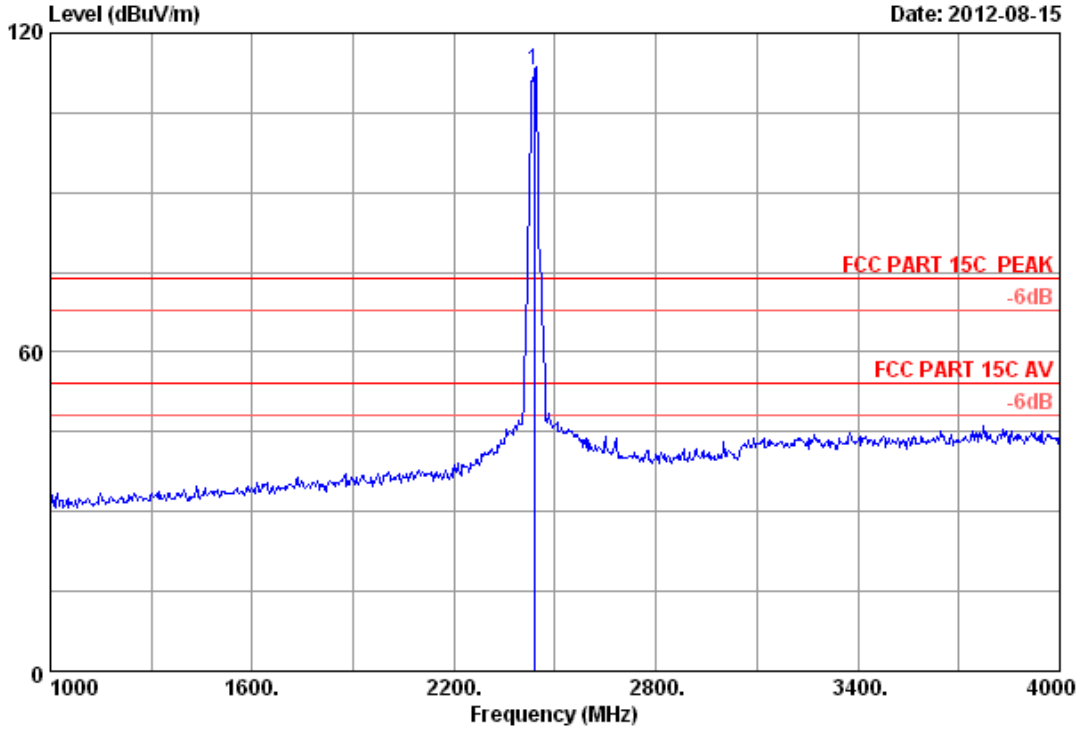

Site no. : 3m Chamber Data no. : 67  
 Dis. / Ant. : 3m 2011 3115 4580 Ant. pol. : VERTICAL  
 Limit : FCC PART 15C PEAK  
 Env. / Ins. : 23°C/54% Engineer : Leo-Li  
 EUT : 300Mbps Wireless N Router  
 Power supply : DC 9V From Adapter Input AC 120V/60Hz  
 Test mode : IEEE802.11nHT20 CH6 2437MHz Tx  
 M/N : RNX-N360RT

	Ant. Factor (dB/m)	Cable loss (dB)	Amp. Factor (dB)	Emission Reading (dBuV)	Emission Level (dBuV/m)	Limits (dBuV/m)	Margin (dB)	Remark
1	28.03	6.06	34.44	113.40	113.05	74.00	-39.05	Peak

Remarks:

1. Emission Level= Antenna Factor + Cable Loss -Amp Factor + Reading.
2. The emission levels that are 20dB below the official limit are not reported.

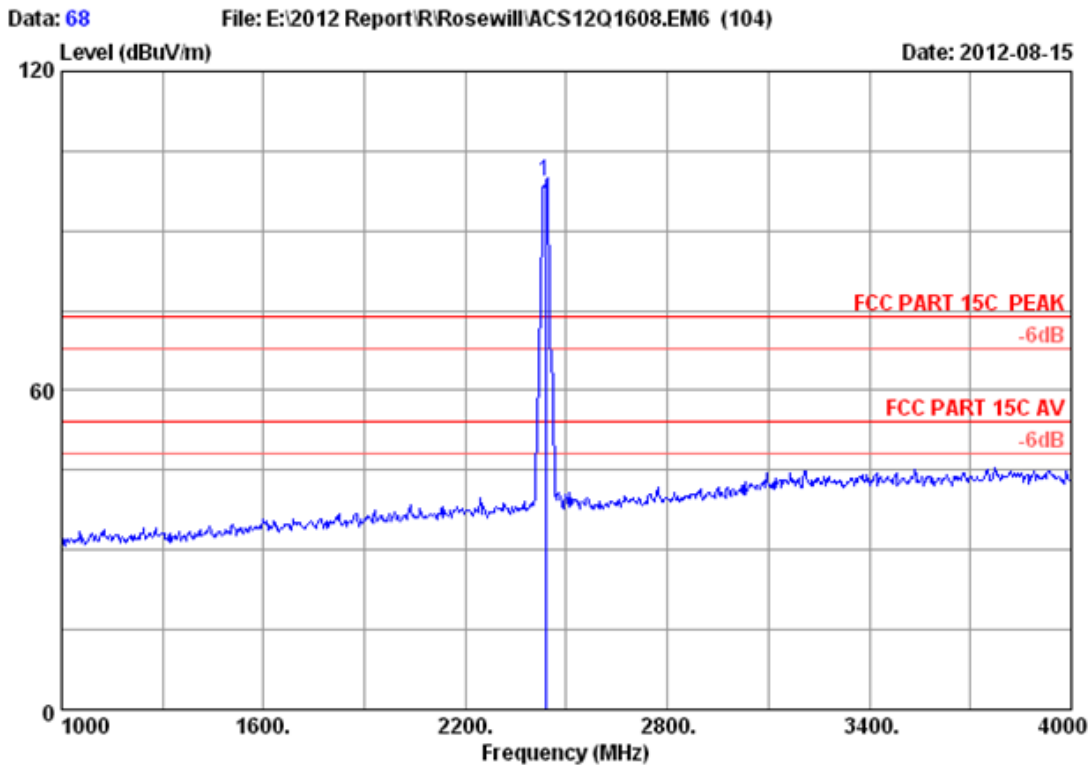

Site no. : 3m Chamber Data no. : 68  
 Dis. / Ant. : 3m 2011 3115 4580 Ant. pol. : HORIZONTAL  
 Limit : FCC PART 15C PEAK  
 Env. / Ins. : 23°C/54% Engineer : Leo-Li  
 EUT : 300Mbps Wireless N Router  
 Power supply : DC 9V From Adapter Input AC 120V/60Hz  
 Test mode : IEEE802.11nHT20 CH6 2437MHz Tx  
 M/N : RNX-N360RT

	Freq. (MHz)	Ant. Factor (dB/m)	Cable loss (dB)	Amp. Factor (dB)	Reading (dBUV)	Emission Level (dBUV/m)	Limits (dBUV/m)	Margin (dB)	Remark
1	2437.000	28.03	6.06	34.44	99.53	99.18	74.00	-25.18	Peak

Remarks:

1. Emission Level= Antenna Factor + Cable Loss -Amp Factor + Reading.
2. The emission levels that are 20dB below the official limit are not reported.

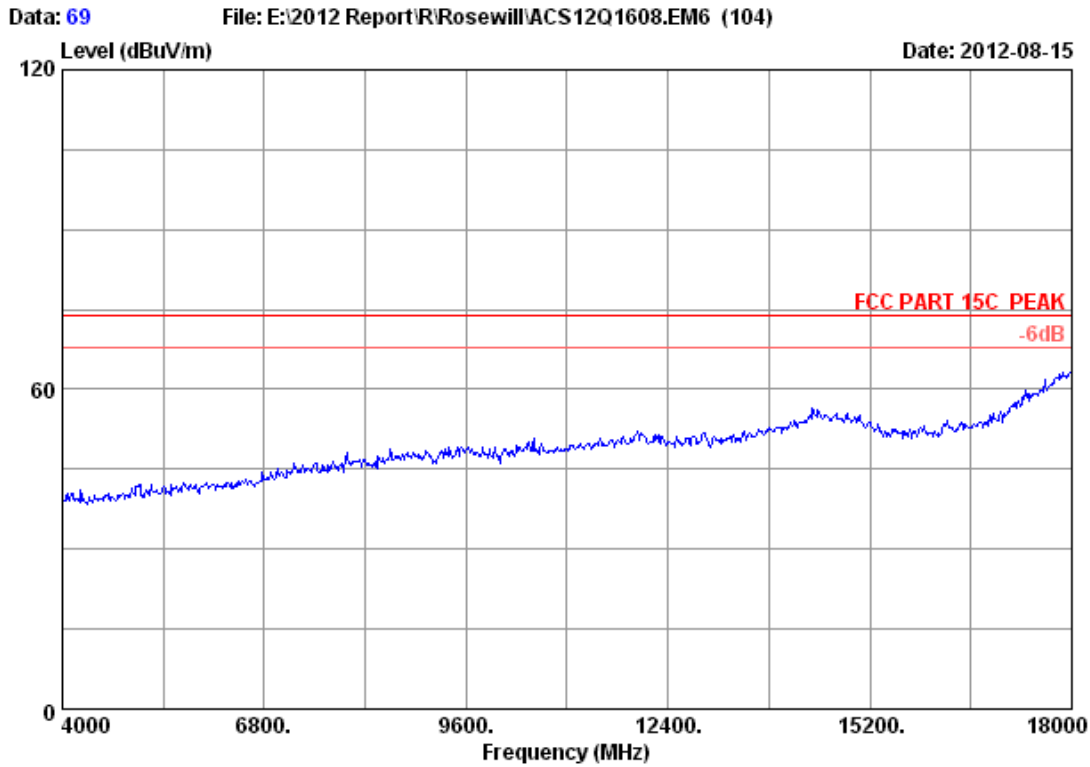

Site no. : 3m Chamber Data no. : 69  
Dis. / Ant. : 3m 2011 3115 4580 Ant. pol. : HORIZONTAL  
Limit : FCC PART 15C PEAK  
Env. / Ins. : 23°C/54% Engineer : Leo-Li  
EUT : 300Mbps Wireless N Router  
Power supply : DC 9V From Adapter Input AC 120V/60Hz  
Test mode : IEEE802.11nHT20 CH11 2462MHz Tx  
M/N : RNX-N360RT

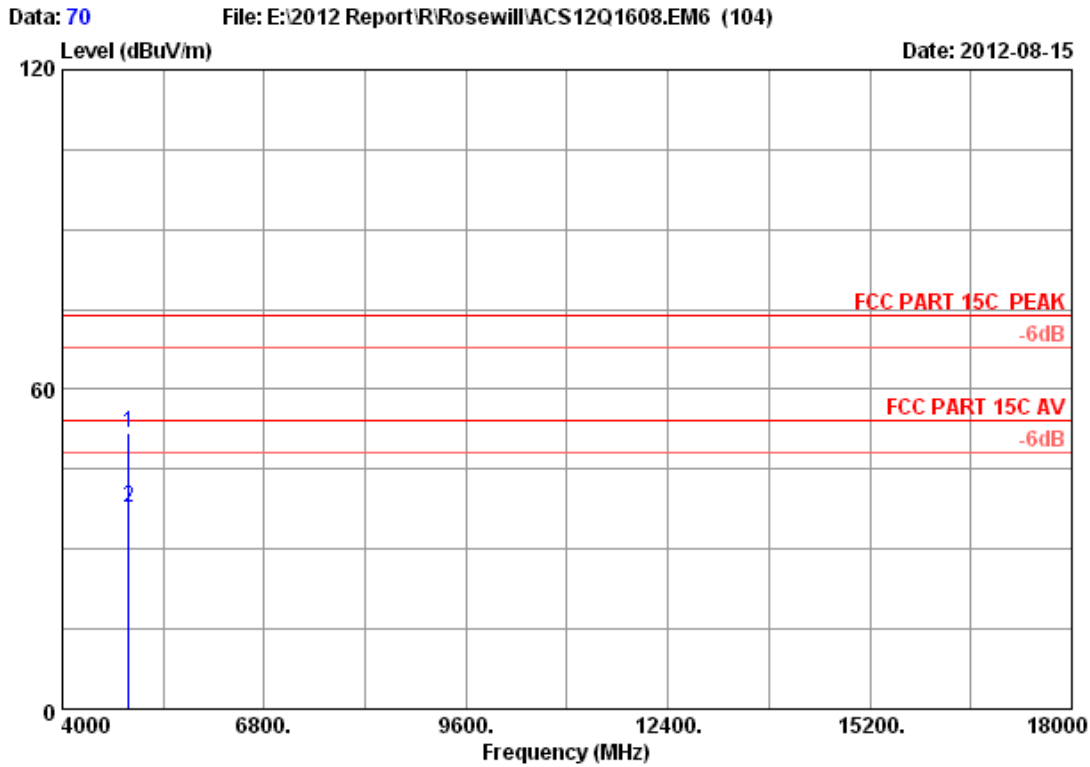

Site no. : 3m Chamber Data no. : 70  
 Dis. / Ant. : 3m 2011 3115 4580 Ant. pol. : HORIZONTAL  
 Limit : FCC PART 15C PEAK  
 Env. / Ins. : 23°C/54% Engineer : Leo-Li  
 EUT : 300Mbps Wireless N Router  
 Power supply : DC 9V From Adapter Input AC 120V/60Hz  
 Test mode : IEEE802.11nHT20 CH11 2462MHz Tx  
 M/N : RNX-N360RT

	Freq. (MHz)	Ant. Factor (dB/m)	Cable loss (dB)	Amp. Factor (dB)	Reading (dBuV)	Emission Level (dBuV/m)	Limits (dBuV/m)	Margin (dB)	Remark
1	4924.000	33.08	8.62	34.60	44.81	51.91	74.00	22.09	Peak
2	4924.000	33.08	8.62	34.60	30.55	37.65	54.00	16.35	Average

Remarks:

1. Emission Level= Antenna Factor + Cable Loss -Amp Factor + Reading.
2. The emission levels that are 20dB below the official limit are not reported.

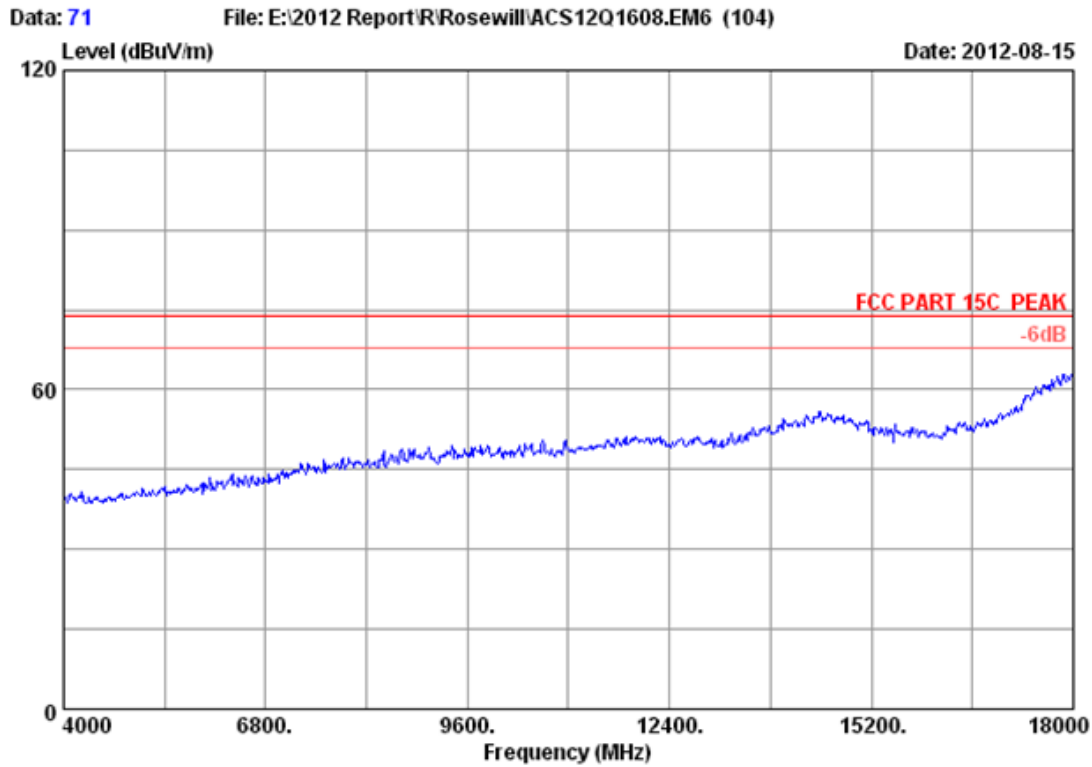

Site no. : 3m Chamber Data no. : 71  
Dis. / Ant. : 3m 2011 3115 4580 Ant. pol. : VERTICAL  
Limit : FCC PART 15C PEAK  
Env. / Ins. : 23°C/54% Engineer : Leo-Li  
EUT : 300Mbps Wireless N Router  
Power supply : DC 9V From Adapter Input AC 120V/60Hz  
Test mode : IEEE802.11nHT20 CH11 2462MHz Tx  
M/N : RNX-N360RT

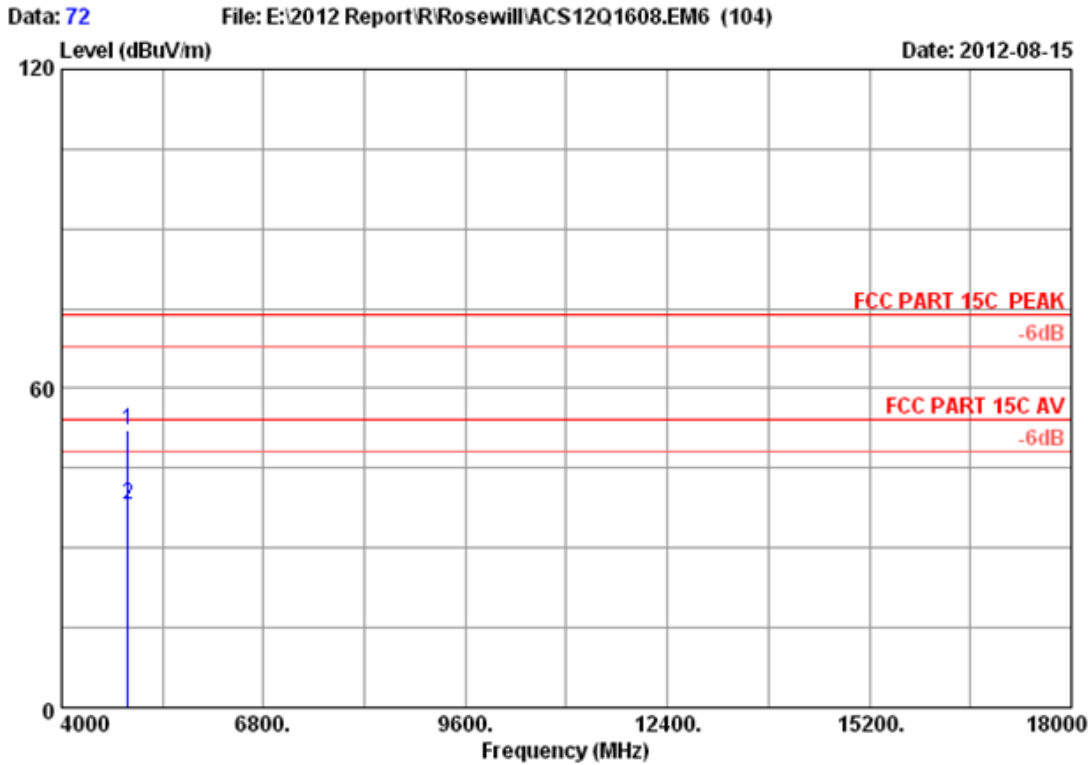

Site no. : 3m Chamber Data no. : 72  
 Dis. / Ant. : 3m 2011 3115 4580 Ant. pol. : VERTICAL  
 Limit : FCC PART 15C PEAK  
 Env. / Ins. : 23°C/54% Engineer : Leo-Li  
 EUT : 300Mbps Wireless N Router  
 Power supply : DC 9V From Adapter Input AC 120V/60Hz  
 Test mode : IEEE802.11nHT20 CH11 2462MHz Tx  
 M/N : RNX-N360RT

	Freq. (MHz)	Ant. Factor (dB/m)	Cable loss (dB)	Amp. Factor (dB)	Reading (dBUV)	Emission Level (dBUV/m)	Limits (dBUV/m)	Margin (dB)	Remark
1	4924.000	33.08	8.62	34.60	45.13	52.23	74.00	21.77	Peak
2	4924.000	33.08	8.62	34.60	30.98	38.08	54.00	15.92	Average

Remarks:

1. Emission Level= Antenna Factor + Cable Loss -Amp Factor + Reading.
2. The emission levels that are 20dB below the official limit are not reported.

Data: 77 File: E:\2012 Report\R\Rosewill\ACS12Q1608.EM6 (104) Date: 2012-08-15

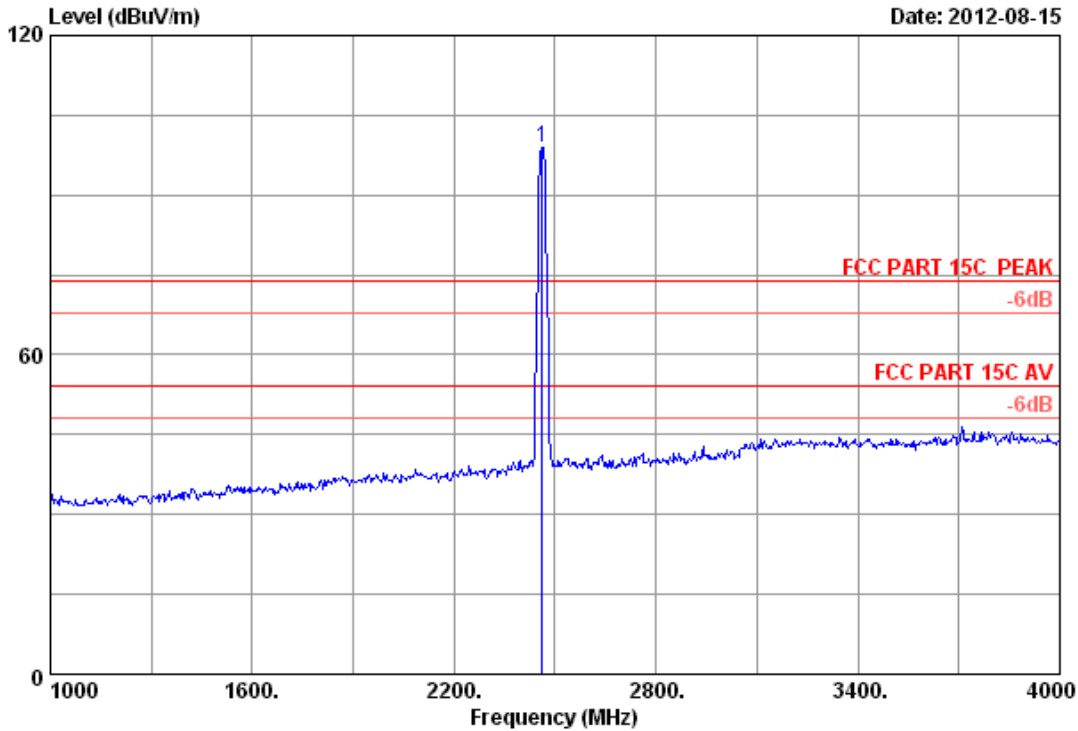

Site no. : 3m Chamber Data no. : 77  
 Dis. / Ant. : 3m 2011 3115 4580 Ant. pol. : HORIZONTAL  
 Limit : FCC PART 15C PEAK  
 Env. / Ins. : 23°C/54% Engineer : Leo-Li  
 EUT : 300Mbps Wireless N Router  
 Power supply : DC 9V From Adapter Input AC 120V/60Hz  
 Test mode : IEEE802.11nHT20 CH11 2462MHz Tx  
 M/N : RNX-N360RT

	Ant. Factor (dB/m)	Cable loss (dB)	Amp. Factor (dB)	Reading (dBuV)	Emission Level (dBuV/m)	Limits (dBuV/m)	Margin (dB)	Remark
1	28.05	6.12	34.44	99.08	98.81	74.00	-24.81	Peak

Remarks:

- Emission Level= Antenna Factor + Cable Loss -amp Factor + Reading.
- The emission levels that are 20dB below the official limit are not reported.



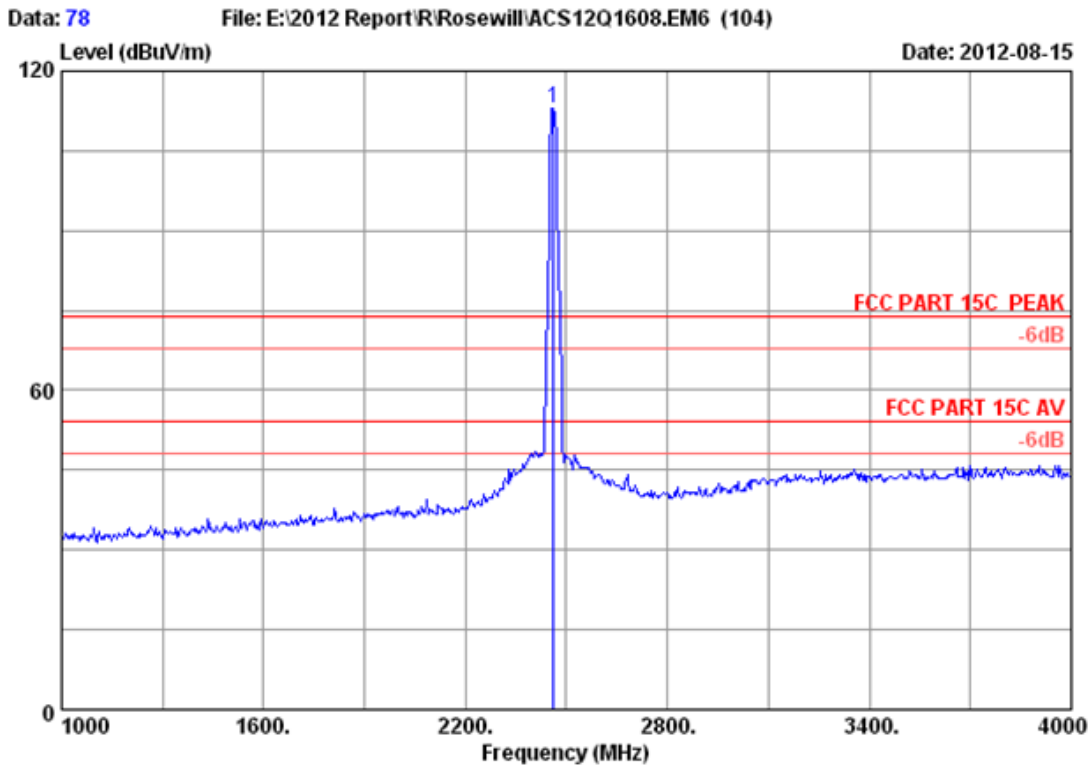

Site no. : 3m Chamber Data no. : 78  
 Dis. / Ant. : 3m 2011 3115 4580 Ant. pol. : VERTICAL  
 Limit : FCC PART 15C PEAK  
 Env. / Ins. : 23°C/54% Engineer : Leo-Li  
 EUT : 300Mbps Wireless N Router  
 Power supply : DC 9V From Adapter Input AC 120V/60Hz  
 Test mode : IEEE802.11nHT20 CH11 2462MHz Tx  
 M/N : RNX-N360RT

	Freq. (MHz)	Ant. Factor (dB/m)	Cable loss (dB)	Amp. Factor (dB)	Reading (dBuV)	Emission Level (dBuV/m)	Limits (dBuV/m)	Margin (dB)	Remark
1	2462.000	28.05	6.12	34.44	113.15	112.88	74.00	-38.88	Peak

Remarks:

1. Emission Level= Antenna Factor + Cable Loss -Amp Factor + Reading.
2. The emission levels that are 20dB below the official limit are not reported.

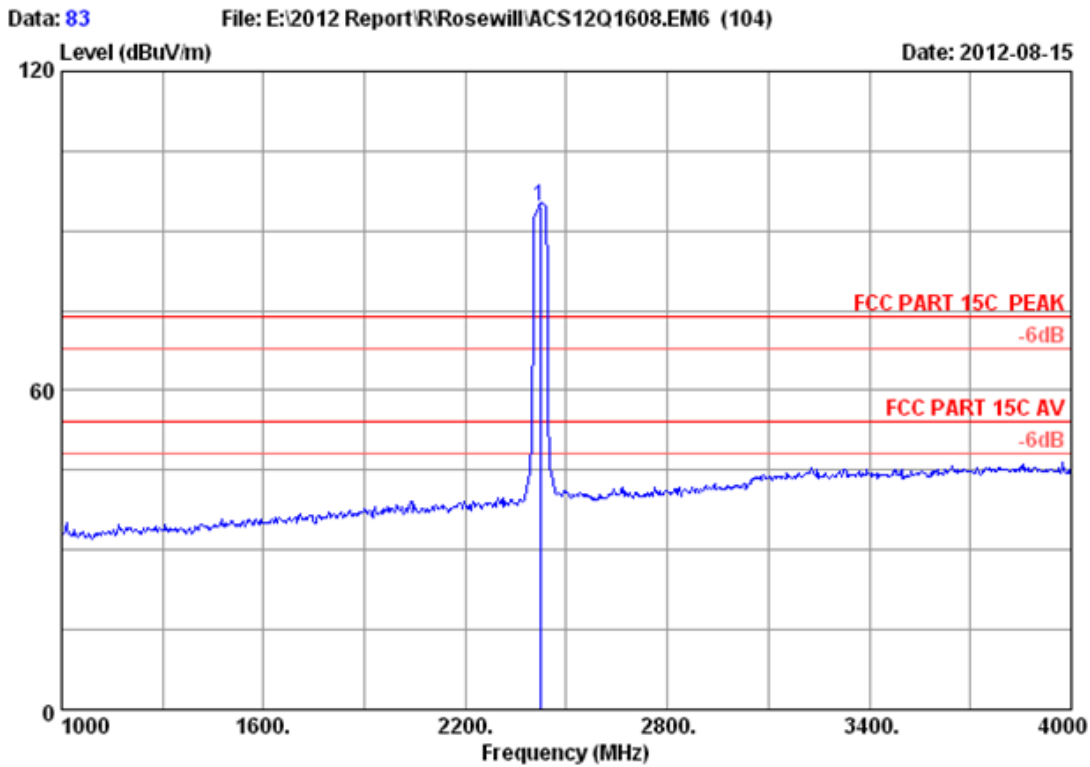

```

Site no.      : 3m Chamber           Data no.   : 83
Dis. / Ant.   : 3m 2011 3115 4580    Ant. pol.  : HORIZONTAL
Limit        : FCC PART 15C PEAK
Env. / Ins.   : 23*C/54%             Engineer   : Leo-Li
EUT          : 300Mbps Wireless N Router
Power supply  : DC 9V From Adapter Input AC 120V/60Hz
Test mode    : IEEE802.11nHT40 CH1 2422MHz Tx
M/N          : RNX-N360RT
    
```

	Freq. (MHz)	Ant. Factor (dB/m)	Cable loss (dB)	Amp. Factor (dB)	Reading (dBuV)	Emission Level (dBuV/m)	Limits (dBuV/m)	Margin (dB)	Remark
1	2422.000	28.00	6.06	34.44	95.13	94.75	74.00	-20.75	Peak

Remarks:

1. Emission Level= Antenna Factor + Cable Loss -Amp Factor + Reading.
2. The emission levels that are 20dB below the official limit are not reported.

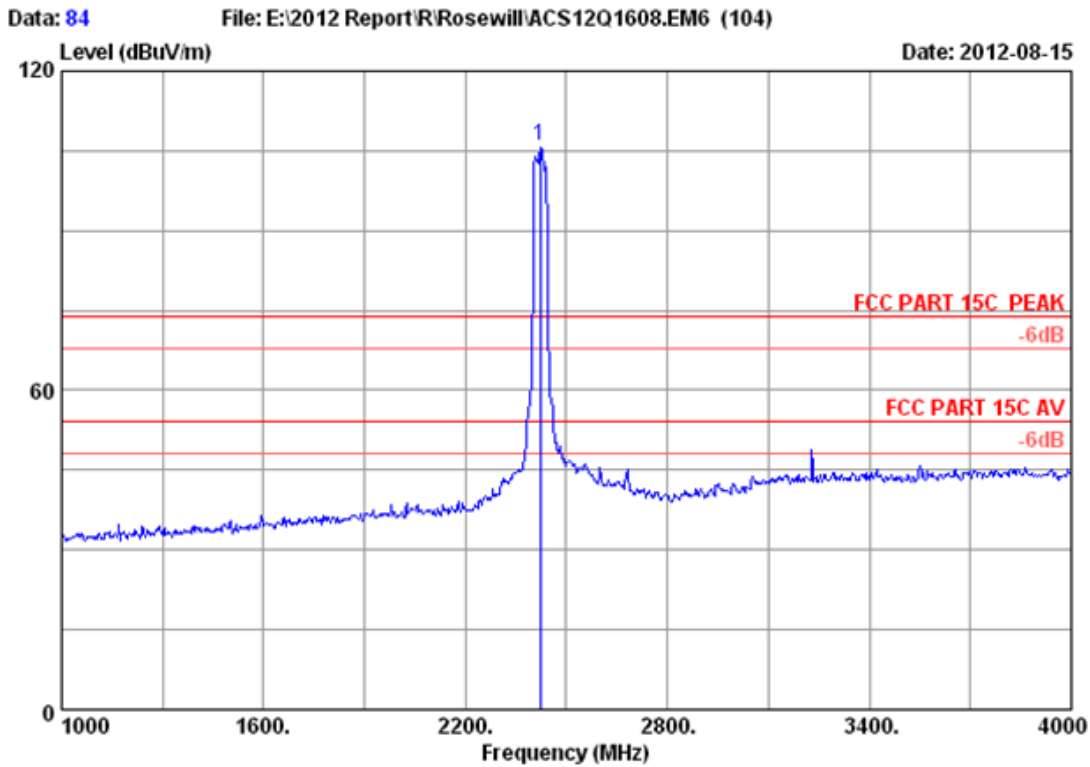

Site no. : 3m Chamber Data no. : 84  
 Dis. / Ant. : 3m 2011 3115 4580 Ant. pol. : VERTICAL  
 Limit : FCC PART 15C PEAK  
 Env. / Ins. : 23°C/54% Engineer : Leo-Li  
 EUT : 300Mbps Wireless N Router  
 Power supply : DC 9V From Adapter Input AC 120V/60Hz  
 Test mode : IEEE802.11nHT40 CH1 2422MHz Tx  
 M/N : RNX-N360RT

Freq. (MHz)	Ant. Factor (dB/m)	Cable loss (dB)	Amp. Factor (dB)	Reading (dBuV)	Emission			Remark
					Level (dBuV/m)	Limits (dBuV/m)	Margin (dB)	
1 2422.000	28.00	6.06	34.44	106.33	105.95	74.00	-31.95	Peak

Remarks:

1. Emission Level= Antenna Factor + Cable Loss -Amp Factor + Reading.
2. The emission levels that are 20dB below the official limit are not reported.

Data: 85 File: E:\2012 Report\Rosewill\ACS12Q1608.EM6 (104) Date: 2012-08-15

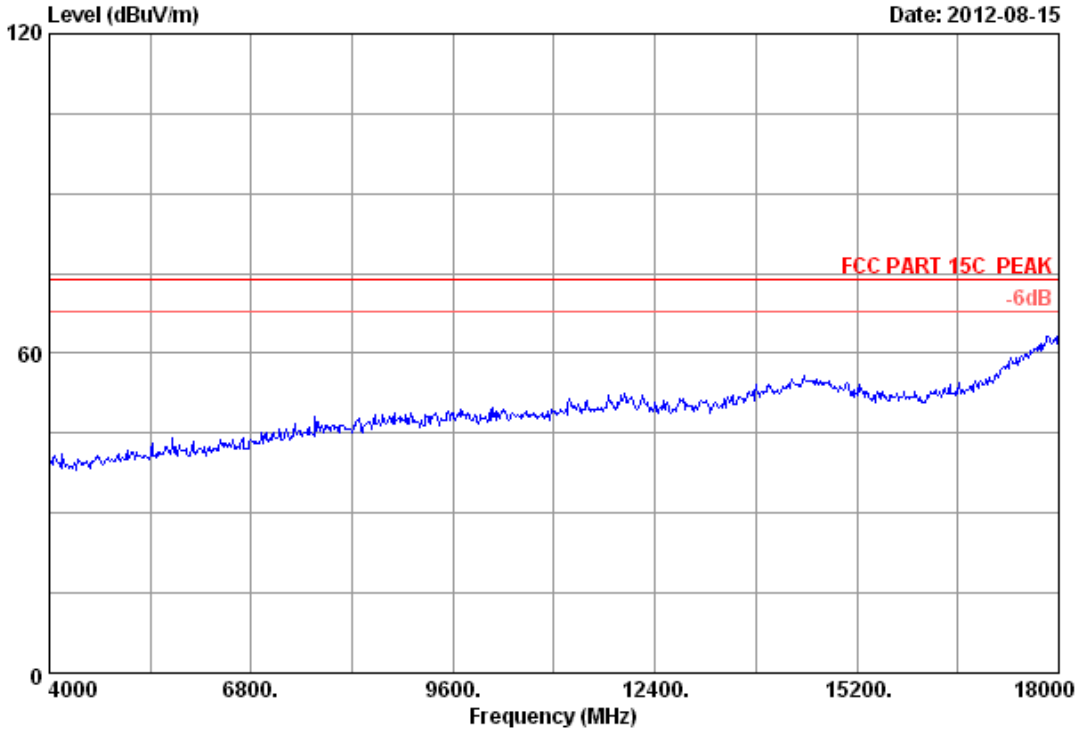

Site no. : 3m Chamber Data no. : 85  
Dis. / Ant. : 3m 2011 3115 4580 Ant. pol. : VERTICAL  
Limit : FCC PART 15C PEAK  
Env. / Ins. : 23°C/54% Engineer : Leo-Li  
EUT : 300Mbps Wireless N Router  
Power supply : DC 9V From Adapter Input AC 120V/60Hz  
Test mode : IEEE802.11nHT40 CH1 2422MHz Tx  
M/N : RNX-N360RT

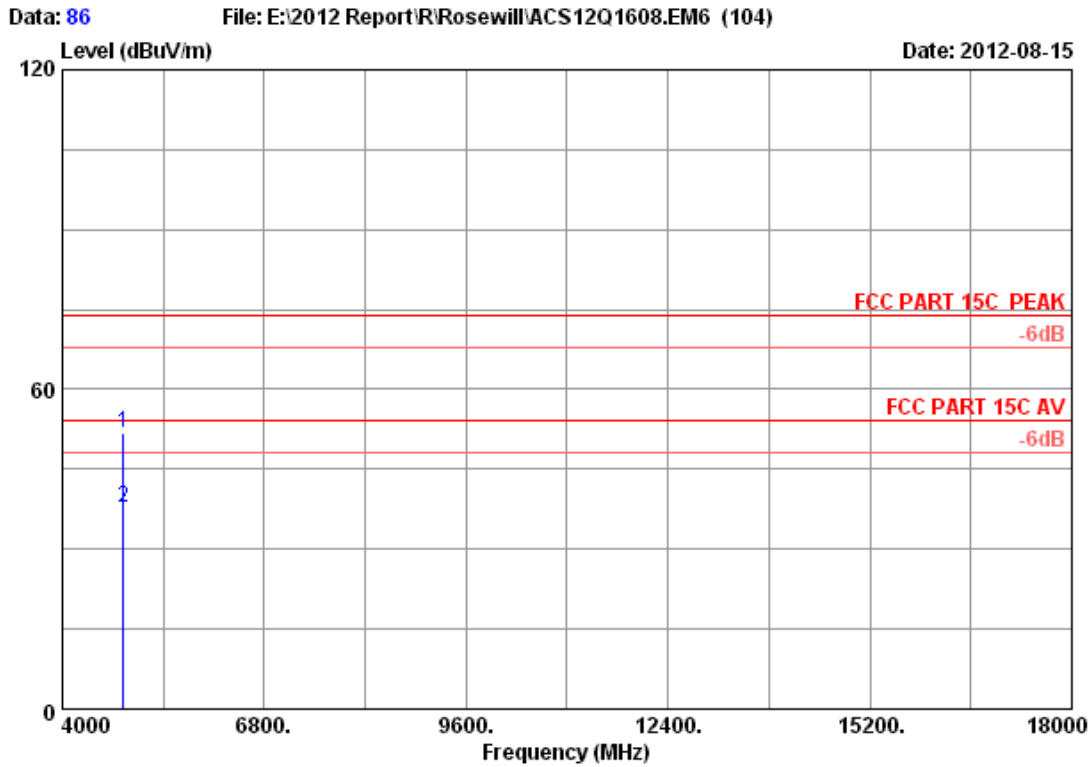

Site no. : 3m Chamber Data no. : 86  
 Dis. / Ant. : 3m 2011 3115 4580 Ant. pol. : VERTICAL  
 Limit : FCC PART 15C PEAK  
 Env. / Ins. : 23°C/54% Engineer : Leo-Li  
 EUT : 300Mbps Wireless N Router  
 Power supply : DC 9V From Adapter Input AC 120V/60Hz  
 Test mode : IEEE802.11nHT40 CH1 2422MHz Tx  
 M/N : RNX-N360RT

	Freq. (MHz)	Ant. Factor (dB/m)	Cable loss (dB)	Amp. Factor (dB)	Reading (dBuV)	Emission Level (dBuV/m)	Limits (dBuV/m)	Margin (dB)	Remark
1	4844.000	32.92	8.55	34.60	44.83	51.70	74.00	22.30	Peak
2	4844.000	32.92	8.55	34.60	30.75	37.62	54.00	16.38	Average

Remarks:

1. Emission Level= Antenna Factor + Cable Loss -Amp Factor + Reading.
2. The emission levels that are 20dB below the official limit are not reported.

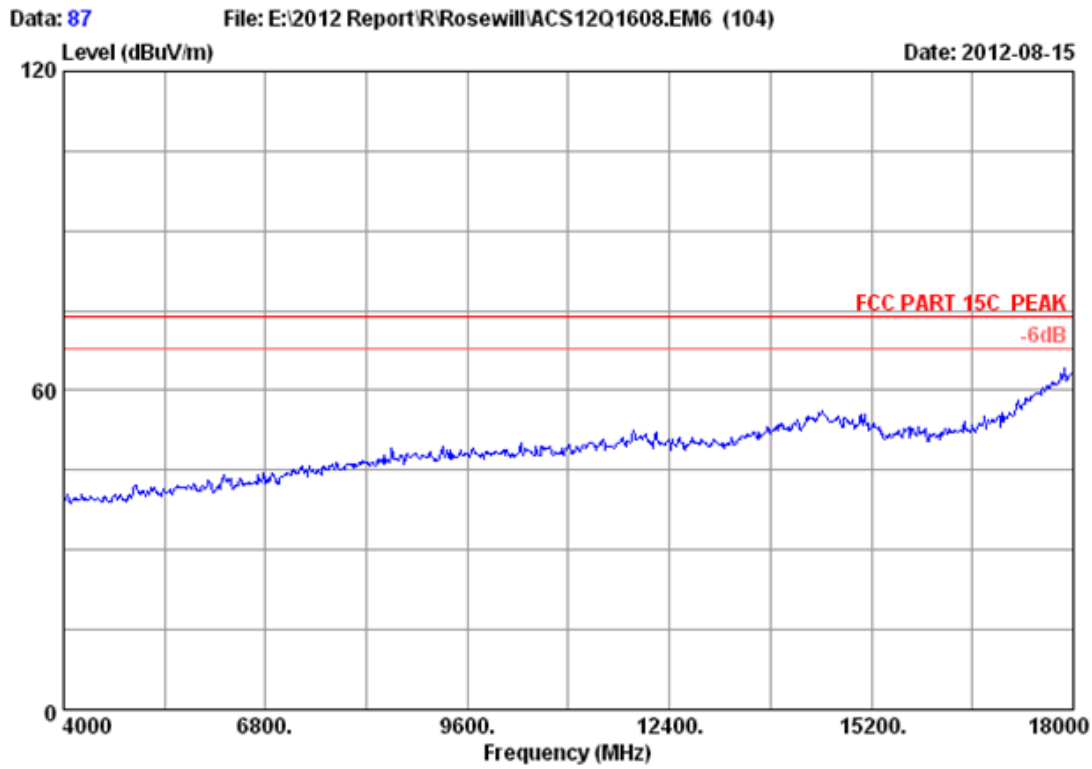

Site no. : 3m Chamber Data no. : 87  
Dis. / Ant. : 3m 2011 3115 4580 Ant. pol. : HORIZONTAL  
Limit : FCC PART 15C PEAK  
Env. / Ins. : 23°C/54% Engineer : Leo-Li  
EUT : 300Mbps Wireless N Router  
Power supply : DC 9V From Adapter Input AC 120V/60Hz  
Test mode : IEEE802.11nHT40 CH1 2422MHz Tx  
M/N : RNX-N360RT

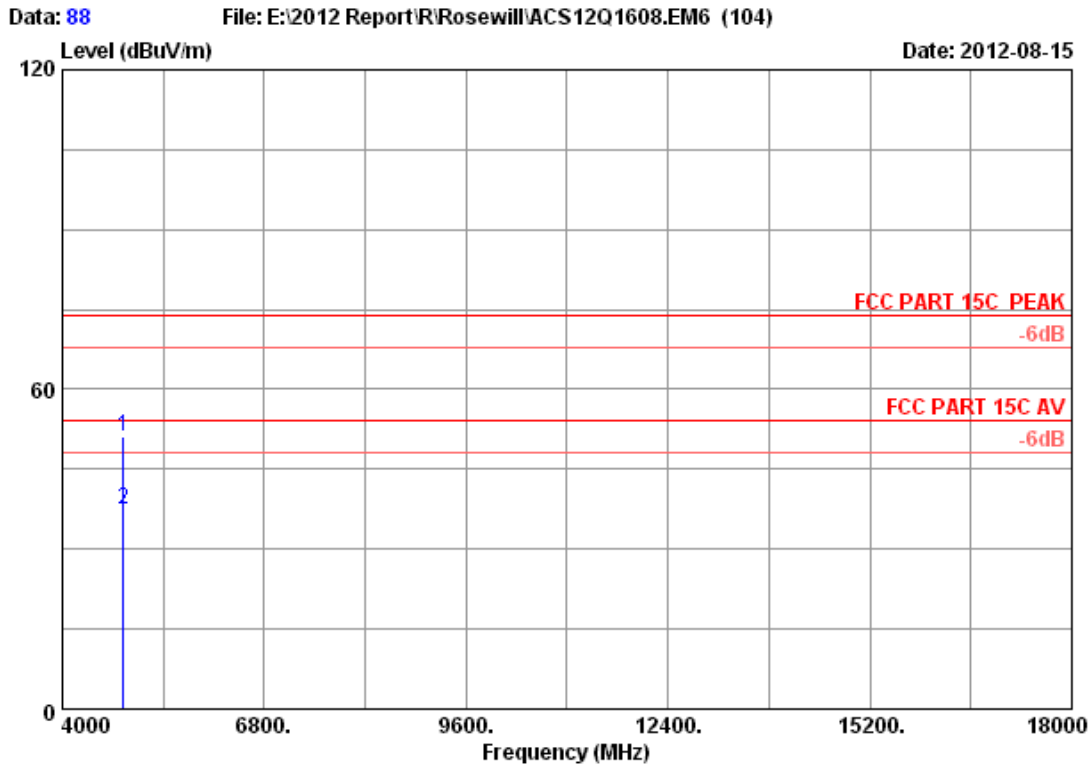

Site no. : 3m Chamber Data no. : 88  
 Dis. / Ant. : 3m 2011 3115 4580 Ant. pol. : HORIZONTAL  
 Limit : FCC PART 15C PEAK  
 Env. / Ins. : 23°C/54% Engineer : Leo-Li  
 EUT : 300Mbps Wireless N Router  
 Power supply : DC 9V From Adapter Input AC 120V/60Hz  
 Test mode : IEEE802.11nHT40 CH1 2422MHz Tx  
 M/N : RNX-N360RT

	Freq. (MHz)	Ant. Factor (dB/m)	Cable loss (dB)	Amp. Factor (dB)	Reading (dBuV)	Emission Level (dBuV/m)	Limits (dBuV/m)	Margin (dB)	Remark
1	4844.000	32.92	8.55	34.60	44.38	51.25	74.00	22.75	Peak
2	4844.000	32.92	8.55	34.60	30.51	37.38	54.00	16.62	Average

Remarks:

1. Emission Level= Antenna Factor + Cable Loss -Amp Factor + Reading.
2. The emission levels that are 20dB below the official limit are not reported.

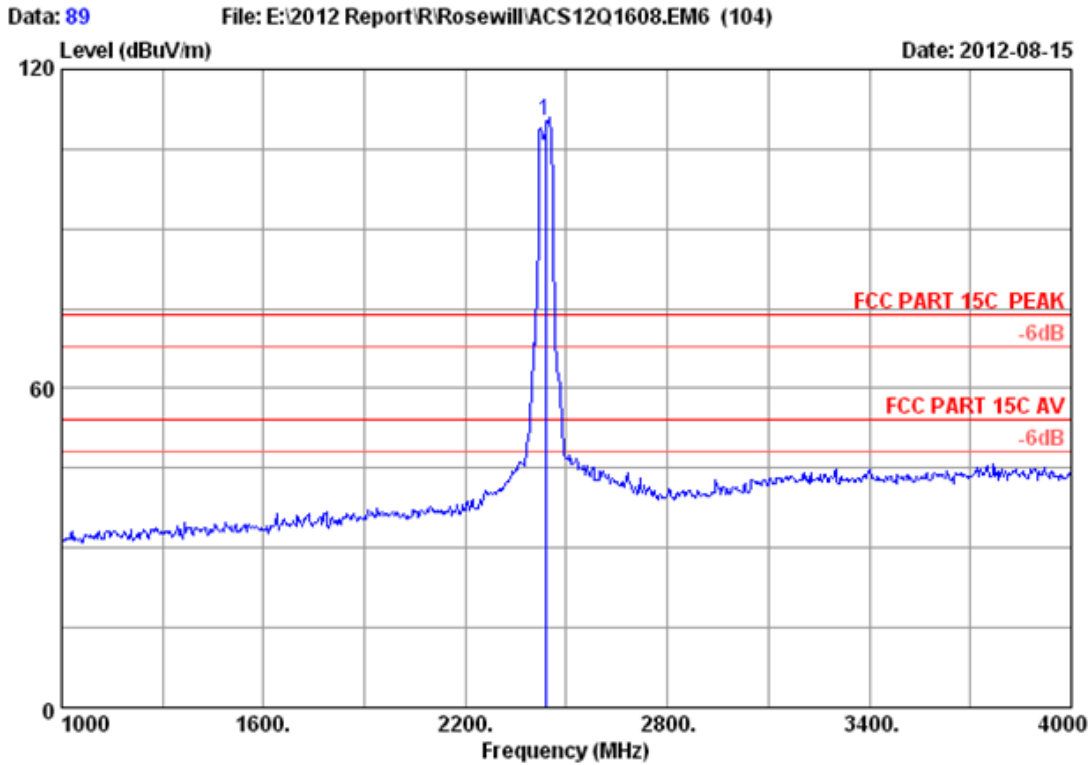

Site no. : 3m Chamber Data no. : 89  
 Dis. / Ant. : 3m 2011 3115 4580 Ant. pol. : VERTICAL  
 Limit : FCC PART 15C PEAK  
 Env. / Ins. : 23°C/54% Engineer : Leo-Li  
 EUT : 300Mbps Wireless N Router  
 Power supply : DC 9V From Adapter Input AC 120V/60Hz  
 Test mode : IEEE802.11nHT40 CH4 2437MHz Tx  
 M/N : RNX-N360RT

	Freq. (MHz)	Ant. Factor (dB/m)	Cable loss (dB)	Amp. Factor (dB)	Reading (dBuV)	Emission Level (dBuV/m)	Limits (dBuV/m)	Margin (dB)	Remark
1	2437.000	28.03	6.06	34.44	110.50	110.15	74.00	-36.15	Peak

Remarks:

1. Emission Level= Antenna Factor + Cable Loss -Amp Factor + Reading.
2. The emission levels that are 20dB below the official limit are not reported.



Data: 90 File: E:\2012 Report\R\Rosewill\ACS12Q1608.EM6 (104) Date: 2012-08-15

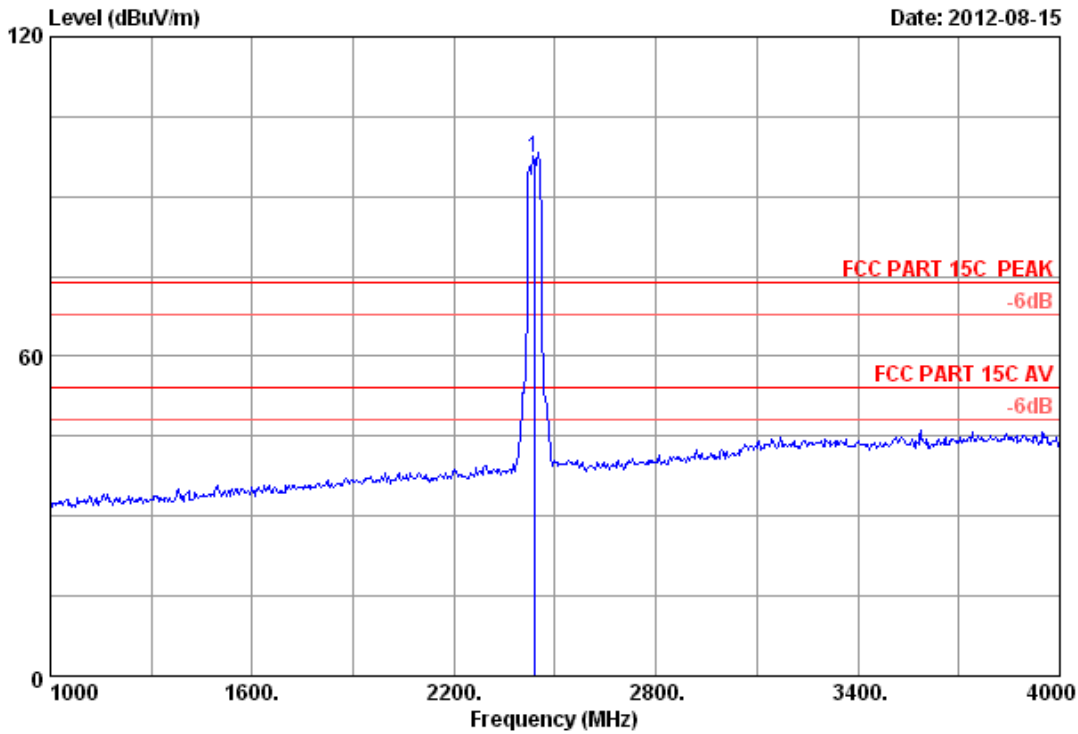

Site no. : 3m Chamber Data no. : 90  
 Dis. / Ant. : 3m 2011 3115 4580 Ant. pol. : HORIZONTAL  
 Limit : FCC PART 15C PEAK  
 Env. / Ins. : 23°C/54% Engineer : Leo-Li  
 EUT : 300Mbps Wireless N Router  
 Power supply : DC 9V From Adapter Input AC 120V/60Hz  
 Test mode : IEEE802.11nHT40 CH4 2437MHz Tx  
 M/N : RNX-N360RT

	Freq. (MHz)	Ant. Factor (dB/m)	Cable loss (dB)	Amp. Factor (dB)	Reading (dBuV)	Emission Level (dBuV/m)	Limits (dBuV/m)	Margin (dB)	Remark
1	2437.000	28.03	6.06	34.44	97.59	97.24	74.00	-23.24	Peak

Remarks:

1. Emission Level= Antenna Factor + Cable Loss -amp Factor + Reading.
2. The emission levels that are 20dB below the official limit are not reported.

Data: 91 File: E:\2012 Report\R\Rosewill\ACS12Q1608.EM6 (104) Date: 2012-08-15

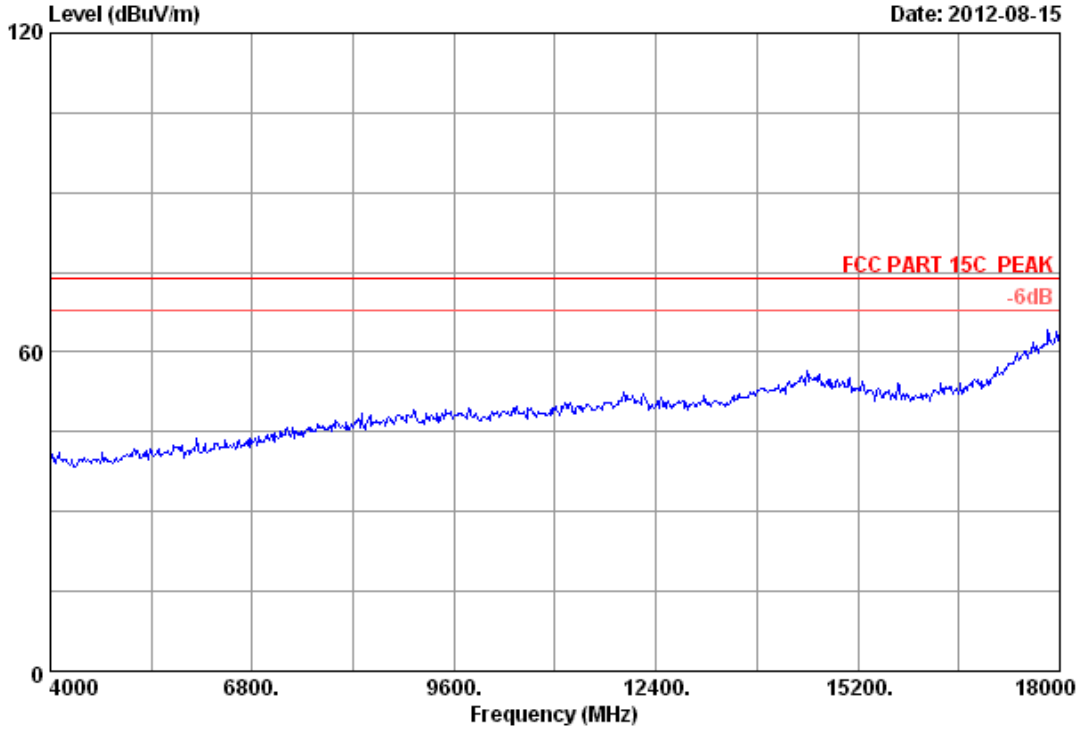

Site no. : 3m Chamber Data no. : 91  
Dis. / Ant. : 3m 2011 3115 4580 Ant. pol. : HORIZONTAL  
Limit : FCC PART 15C PEAK  
Env. / Ins. : 23\*C/54% Engineer : Leo-Li  
EUT : 300Mbps Wireless N Router  
Power supply : DC 9V From Adapter Input AC 120V/60Hz  
Test mode : IEEE802.11nHT40 CH4 2437MHz Tx  
M/N : RNX-N360RT

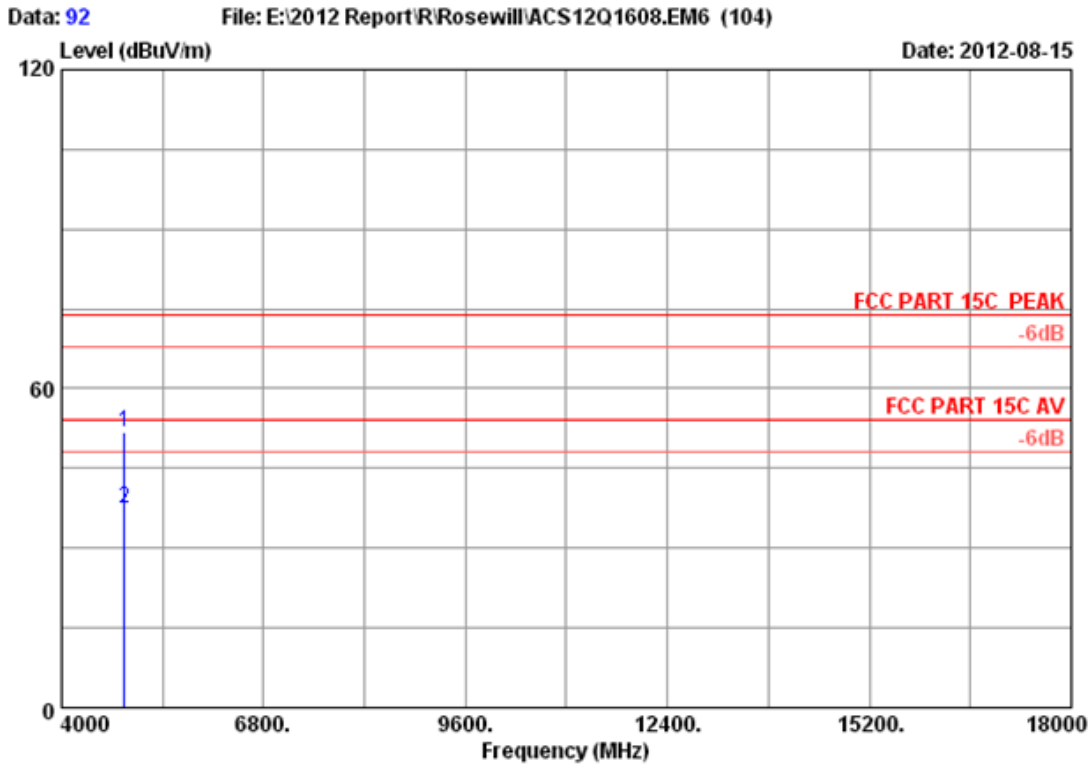

Site no. : 3m Chamber Data no. : 92  
 Dis. / Ant. : 3m 2011 3115 4580 Ant. pol. : HORIZONTAL  
 Limit : FCC PART 15C PEAK  
 Env. / Ins. : 23°C/54% Engineer : Leo-Li  
 EUT : 300Mbps Wireless N Router  
 Power supply : DC 9V From Adapter Input AC 120V/60Hz  
 Test mode : IEEE802.11nHT40 CH4 2437MHz Tx  
 M/N : RNX-N360RT

	Freq. (MHz)	Ant. Factor (dB/m)	Cable loss (dB)	Amp. Factor (dB)	Reading (dBuV)	Emission Level (dBuV/m)	Limits (dBuV/m)	Margin (dB)	Remark
1	4874.000	32.98	8.58	34.60	44.78	51.74	74.00	22.26	Peak
2	4874.000	32.98	8.58	34.60	30.59	37.55	54.00	16.45	Average

Remarks:

1. Emission Level= Antenna Factor + Cable Loss -Amp Factor + Reading.
2. The emission levels that are 20dB below the official limit are not reported.

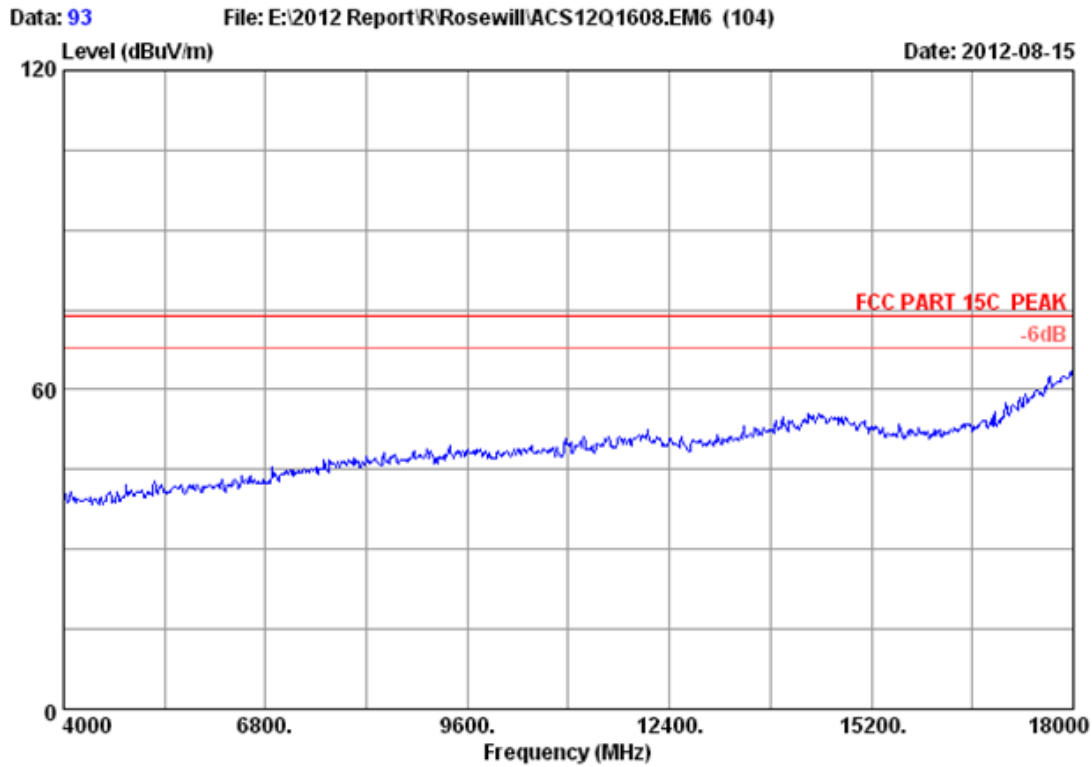

Site no. : 3m Chamber Data no. : 93  
Dis. / Ant. : 3m 2011 3115 4580 Ant. pol. : VERTICAL  
Limit : FCC PART 15C PEAK  
Env. / Ins. : 23°C/54% Engineer : Leo-Li  
EUT : 300Mbps Wireless N Router  
Power supply : DC 9V From Adapter Input AC 120V/60Hz  
Test mode : IEEE802.11nHT40 CH4 2437MHz Tx  
M/N : RNX-N360RT

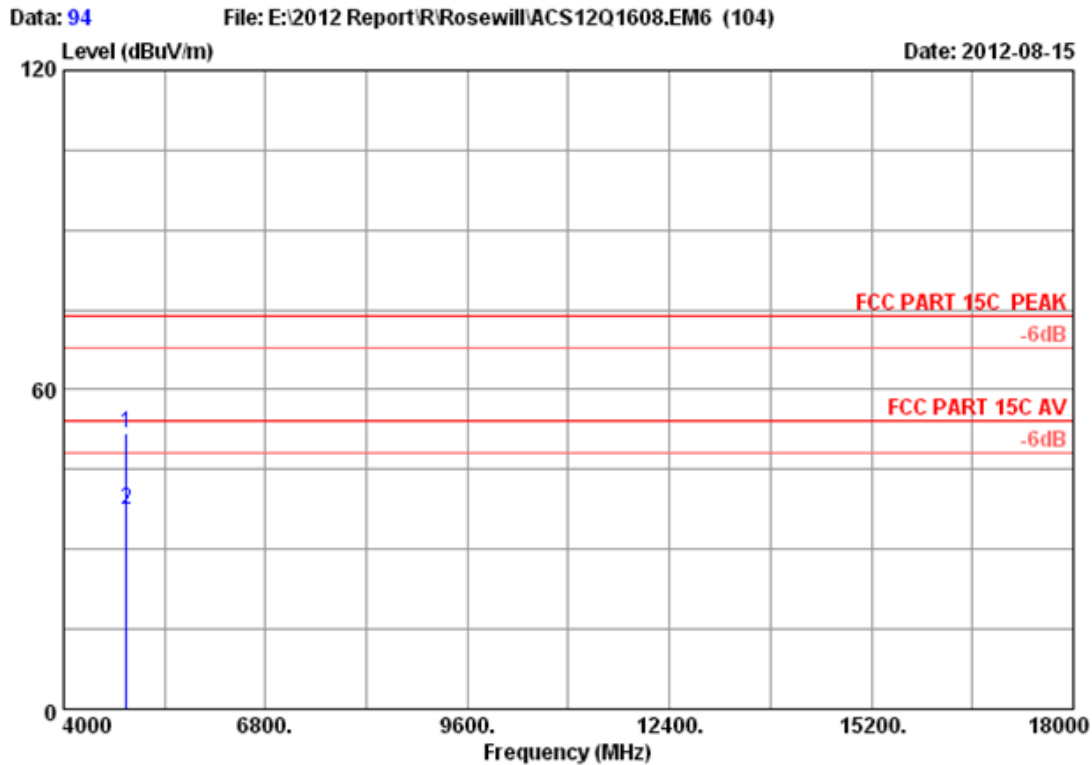

Site no. : 3m Chamber Data no. : 94  
 Dis. / Ant. : 3m 2011 3115 4580 Ant. pol. : VERTICAL  
 Limit : FCC PART 15C PEAK  
 Env. / Ins. : 23°C/54% Engineer : Leo-Li  
 EUT : 300Mbps Wireless N Router  
 Power supply : DC 9V From Adapter Input AC 120V/60Hz  
 Test mode : IEEE802.11nHT40 CH4 2437MHz Tx  
 M/N : RNX-N360RT

	Freq. (MHz)	Ant. Factor (dB/m)	Cable loss (dB)	Amp. Factor (dB)	Reading (dBuV)	Emission Level (dBuV/m)	Limits (dBuV/m)	Margin (dB)	Remark
1	4874.000	32.98	8.58	34.60	44.69	51.65	74.00	22.35	Peak
2	4874.000	32.98	8.58	34.60	30.51	37.47	54.00	16.53	Average

Remarks:

1. Emission Level= Antenna Factor + Cable Loss -Amp Factor + Reading.
2. The emission levels that are 20dB below the official limit are not reported.

Data: 99 File: E:\2012 Report\R\Rosewill\ACS12Q1608.EM6 (104) Date: 2012-08-15

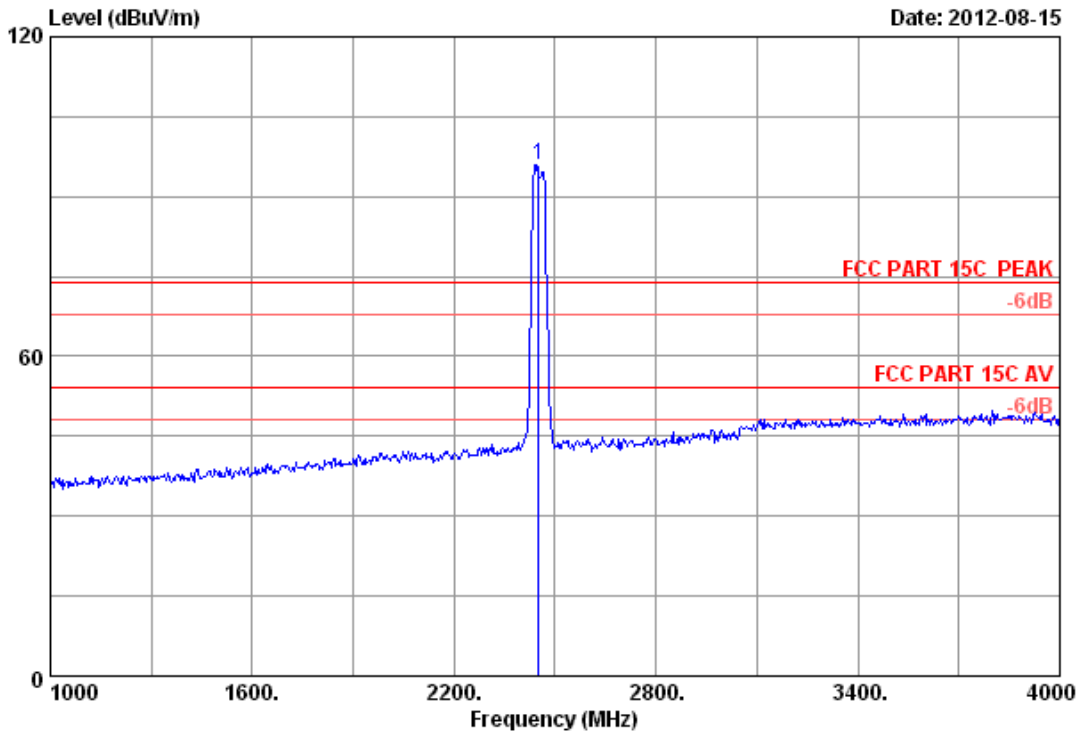

Site no. : 3m Chamber Data no. : 99  
 Dis. / Ant. : 3m 2011 3115 4580 Ant. pol. : HORIZONTAL  
 Limit : FCC PART 15C PEAK  
 Env. / Ins. : 23°C/54% Engineer : Leo-Li  
 EUT : 300Mbps Wireless N Router  
 Power supply : DC 9V From Adapter Input AC 120V/60Hz  
 Test mode : IEEE802.11nHT40 CH7 2452MHz Tx  
 M/N : RNX-N360RT

	Ant. Factor (dB/m)	Cable loss (dB)	Amp. Factor (dB)	Reading (dBUV)	Emission Level (dBUV/m)	Limits (dBUV/m)	Margin (dB)	Remark
1	28.03	6.09	34.44	96.41	96.09	74.00	-22.09	Peak

Remarks:

1. Emission Level= Antenna Factor + Cable Loss -amp Factor + Reading.
2. The emission levels that are 20dB below the official limit are not reported.

Data: 100 File: E:\2012 Report\R\Rosewill\ACS12Q1608.EM6 (104) Date: 2012-08-15

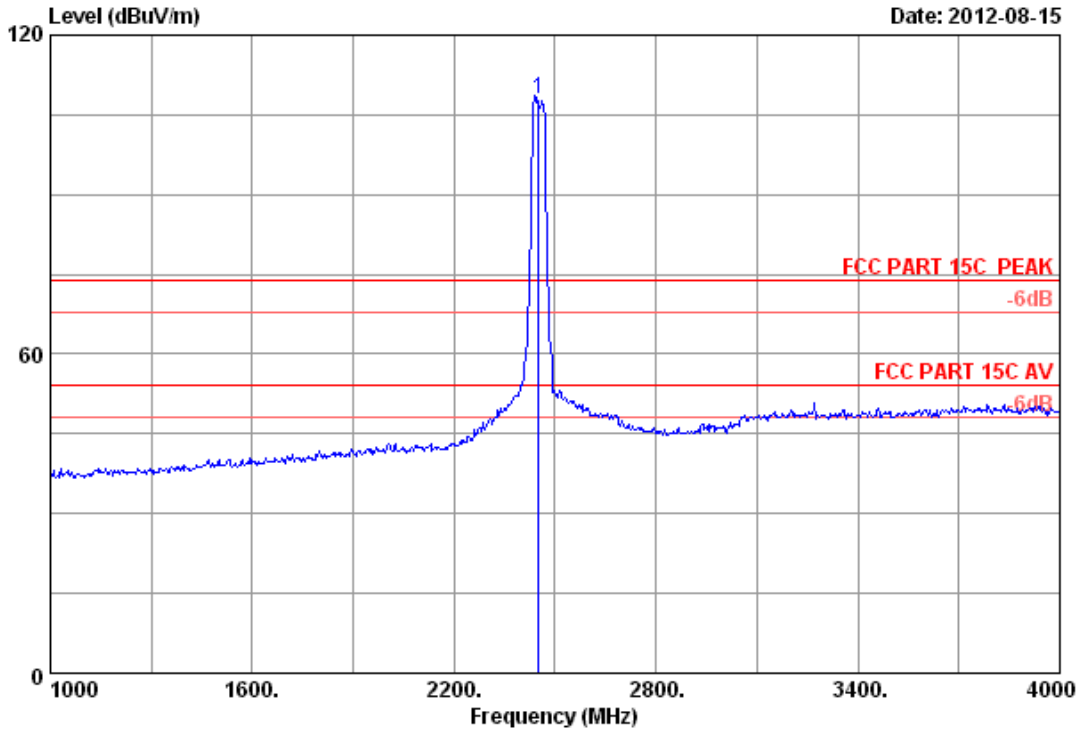

Site no. : 3m Chamber Data no. : 100  
 Dis. / Ant. : 3m 2011 3115 4580 Ant. pol. : VERTICAL  
 Limit : FCC PART 15C PEAK  
 Env. / Ins. : 23°C/54% Engineer : Leo-Li  
 EUT : 300Mbps Wireless N Router  
 Power supply : DC 9V From Adapter Input AC 120V/60Hz  
 Test mode : IEEE802.11nHT40 CH7 2452MHz Tx  
 M/N : RNX-N360RT

Freq. (MHz)	Ant. Factor (dB/m)	Cable loss (dB)	Amp. Factor (dB)	Reading (dBuV)	Emission			Remark
					Level (dBuV/m)	Limits (dBuV/m)	Margin (dB)	
1 2452.000	28.03	6.09	34.44	108.36	108.04	74.00	-34.04	Peak

Remarks:

1. Emission Level= Antenna Factor + Cable Loss -Amp Factor + Reading.
2. The emission levels that are 20dB below the official limit are not reported.

Data: 101 File: E:\2012 Report\R\Rosewill\ACS12Q1608.EM6 (104) Date: 2012-08-15

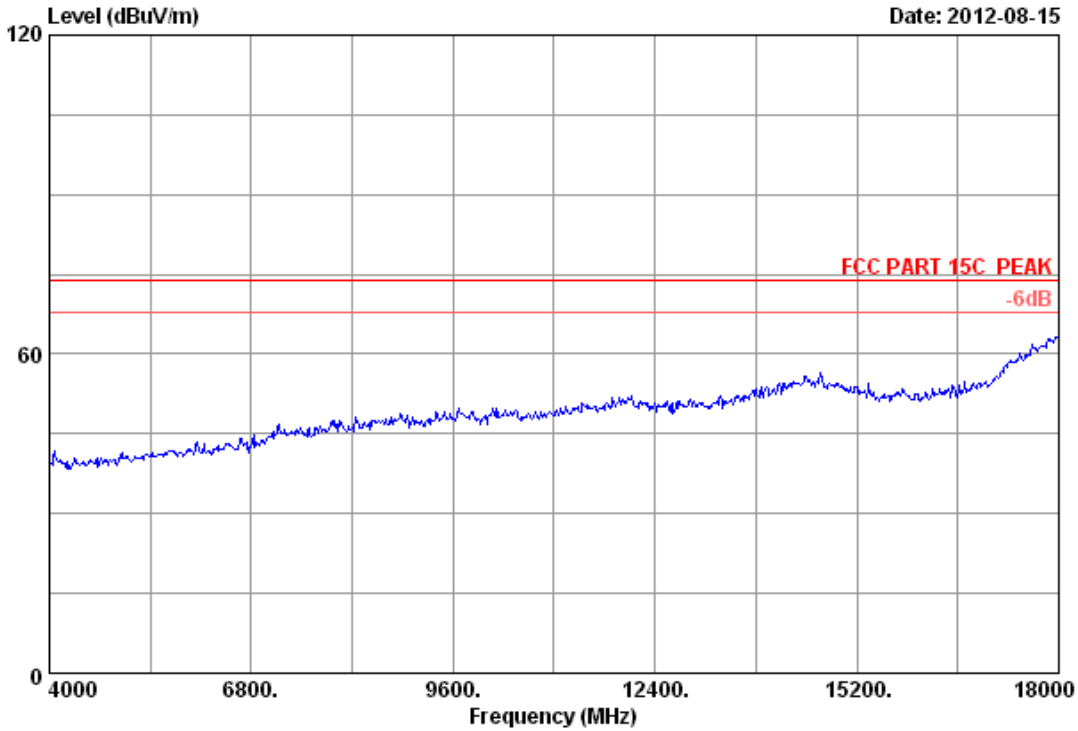

Site no. : 3m Chamber Data no. : 101  
Dis. / Ant. : 3m 2011 3115 4580 Ant. pol. : VERTICAL  
Limit : FCC PART 15C PEAK  
Env. / Ins. : 23\*C/54% Engineer : Leo-Li  
EUT : 300Mbps Wireless N Router  
Power supply : DC 9V From Adapter Input AC 120V/60Hz  
Test mode : IEEE802.11nHT40 CH7 2452MHz Tx  
M/N : RNX-N360RT



Data: 102 File: E:\2012 Report\R\Rosewill\ACS12Q1608.EM6 (104) Date: 2012-08-15

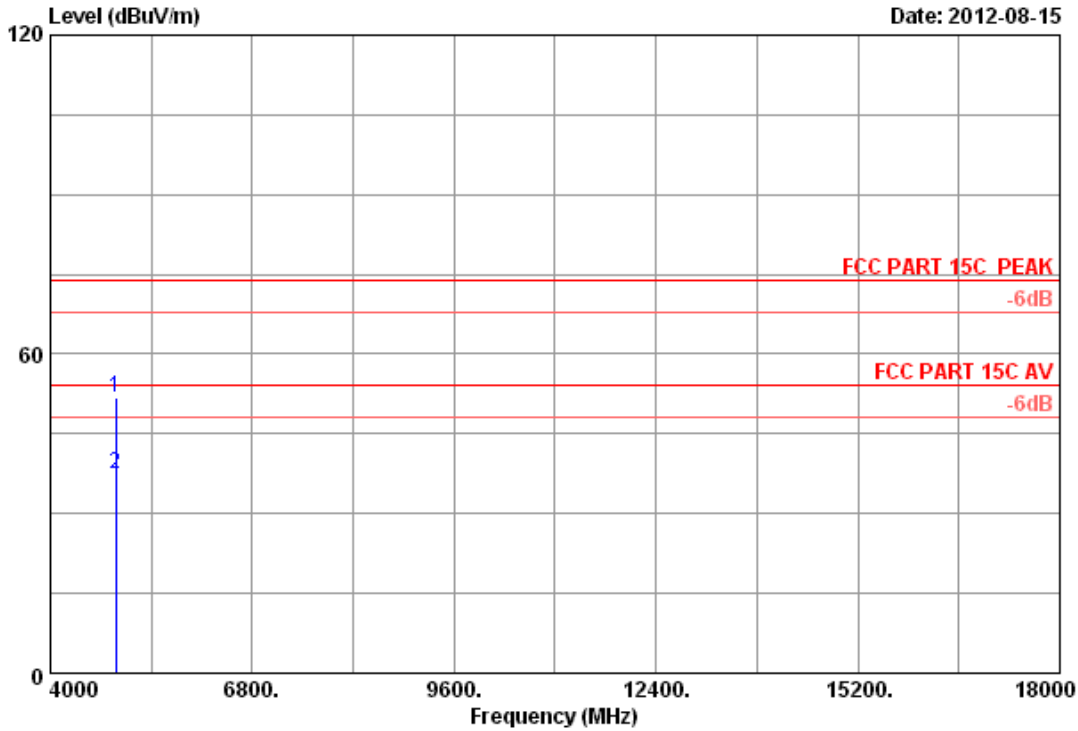

Site no. : 3m Chamber Data no. : 102  
 Dis. / Ant. : 3m 2011 3115 4580 Ant. pol. : VERTICAL  
 Limit : FCC PART 15C PEAK  
 Env. / Ins. : 23°C/54% Engineer : Leo-Li  
 EUT : 300Mbps Wireless N Router  
 Power supply : DC 9V From Adapter Input AC 120V/60Hz  
 Test mode : IEEE802.11nHT40 CH7 2452MHz Tx  
 M/N : RNX-N360RT

	Freq. (MHz)	Ant. Factor (dB/m)	Cable loss (dB)	Amp. Factor (dB)	Reading (dBuV)	Emission Level (dBuV/m)	Limits (dBuV/m)	Margin (dB)	Remark
1	4904.000	33.04	8.61	34.60	44.73	51.78	74.00	22.22	Peak
2	4904.000	33.04	8.61	34.60	30.37	37.42	54.00	16.58	Average

Remarks:

1. Emission Level= Antenna Factor + Cable Loss -Amp Factor + Reading.
2. The emission levels that are 20dB below the official limit are not reported.

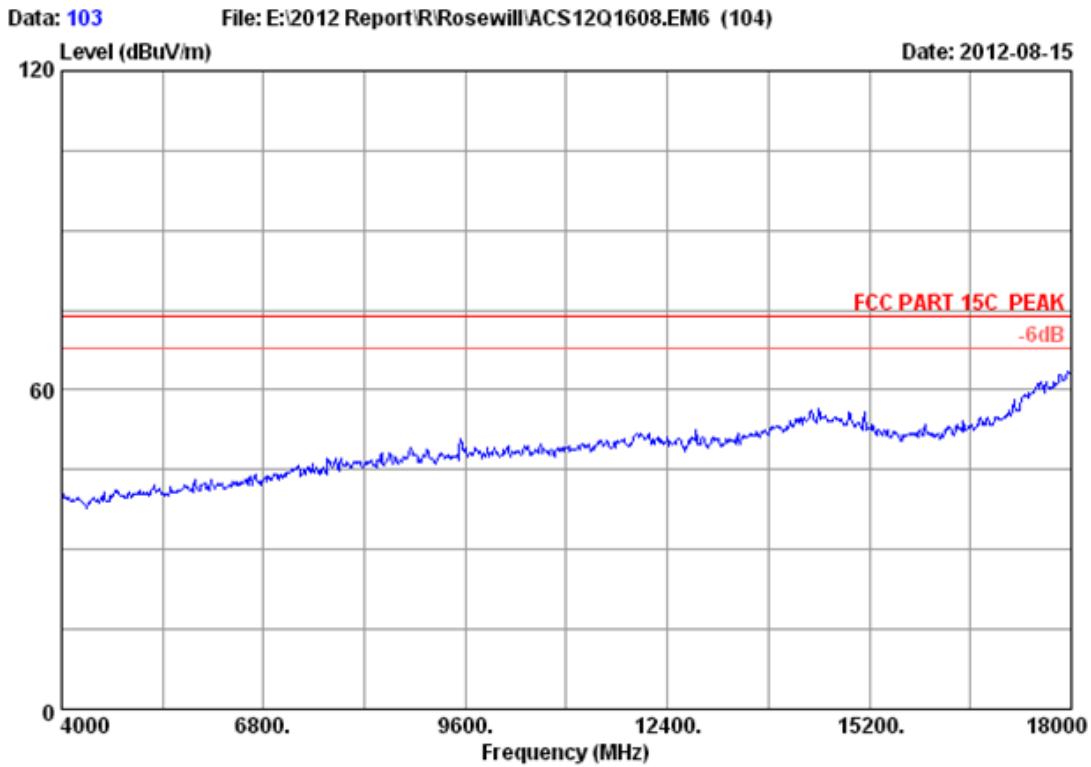

Site no. : 3m Chamber Data no. : 103  
Dis. / Ant. : 3m 2011 3115 4580 Ant. pol. : HORIZONTAL  
Limit : FCC PART 15C PEAK  
Env. / Ins. : 23°C/54% Engineer : Leo-Li  
EUT : 300Mbps Wireless N Router  
Power supply : DC 9V From Adapter Input AC 120V/60Hz  
Test mode : IEEE802.11nHT40 CH7 2452MHz Tx  
M/N : RNX-N360RT

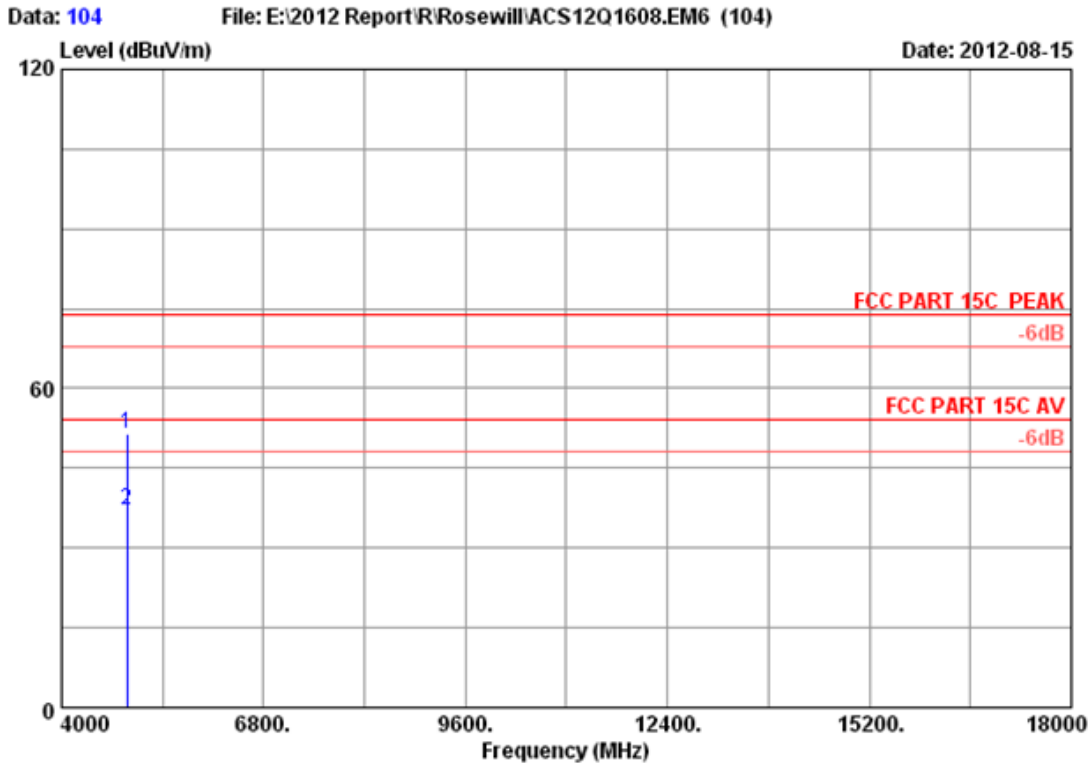

Site no. : 3m Chamber Data no. : 104  
 Dis. / Ant. : 3m 2011 3115 4580 Ant. pol. : HORIZONTAL  
 Limit : FCC PART 15C PEAK  
 Env. / Ins. : 23°C/54% Engineer : Leo-Li  
 EUT : 300Mbps Wireless N Router  
 Power supply : DC 9V From Adapter Input AC 120V/60Hz  
 Test mode : IEEE802.11nHT40 CH7 2452MHz Tx  
 M/N : RNX-N360RT

	Freq. (MHz)	Ant. Factor (dB/m)	Cable loss (dB)	Amp. Factor (dB)	Reading (dBUV)	Emission Level (dBUV/m)	Limits (dBUV/m)	Margin (dB)	Remark
1	4904.000	33.04	8.61	34.60	44.36	51.41	74.00	22.59	Peak
2	4904.000	33.04	8.61	34.60	30.19	37.24	54.00	16.76	Average

Remarks:

1. Emission Level= Antenna Factor + Cable Loss -Amp Factor + Reading.
2. The emission levels that are 20dB below the official limit are not reported.

## 5. CONDUCTED SPURIOUS EMISSIONS

### 5.1. Test Equipment

Item	Equipment	Manufacturer	Model No.	Serial No.	Last Cal.	Cal. Interval
1.	Spectrum Analyzer	Agilent	E7403A	MY42000106	May.08, 12	1 Year
2.	Matching Transformer	Anritsu	MP614A	NO.2	NCR	NCR
3.	TV SG	Philip	PM5418	LO625020	May.08, 12	1 Year

### 5.2.Limit

In any 100kHz bandwidth outside the frequency bands in which the spread spectrum intentional radiator is operating, the radio frequency power that is produced by the intentional radiator shall be at least 20dB below that in the 100kHz bandwidth within the band that contains the highest level of the desired power.

### 5.3.Test Procedure

The transmitter output was connected to a spectrum analyzer, The resolution bandwidth is set to 100 kHz, The video bandwidth is set to 300 kHz and measure all the emissions detected.

**Conducted emission test data:**

**Chain 0:**

Test Mode: IEEE 802.11b TX

Test CH1: 2412MHz

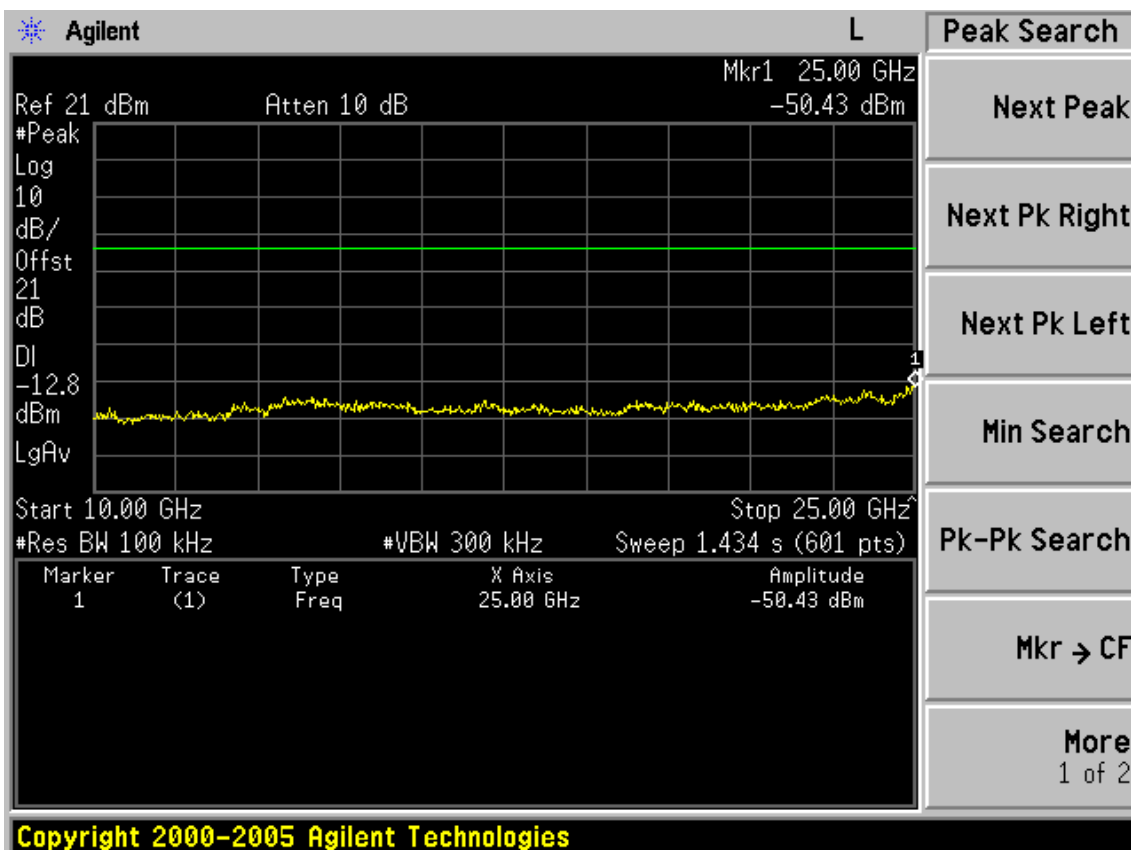
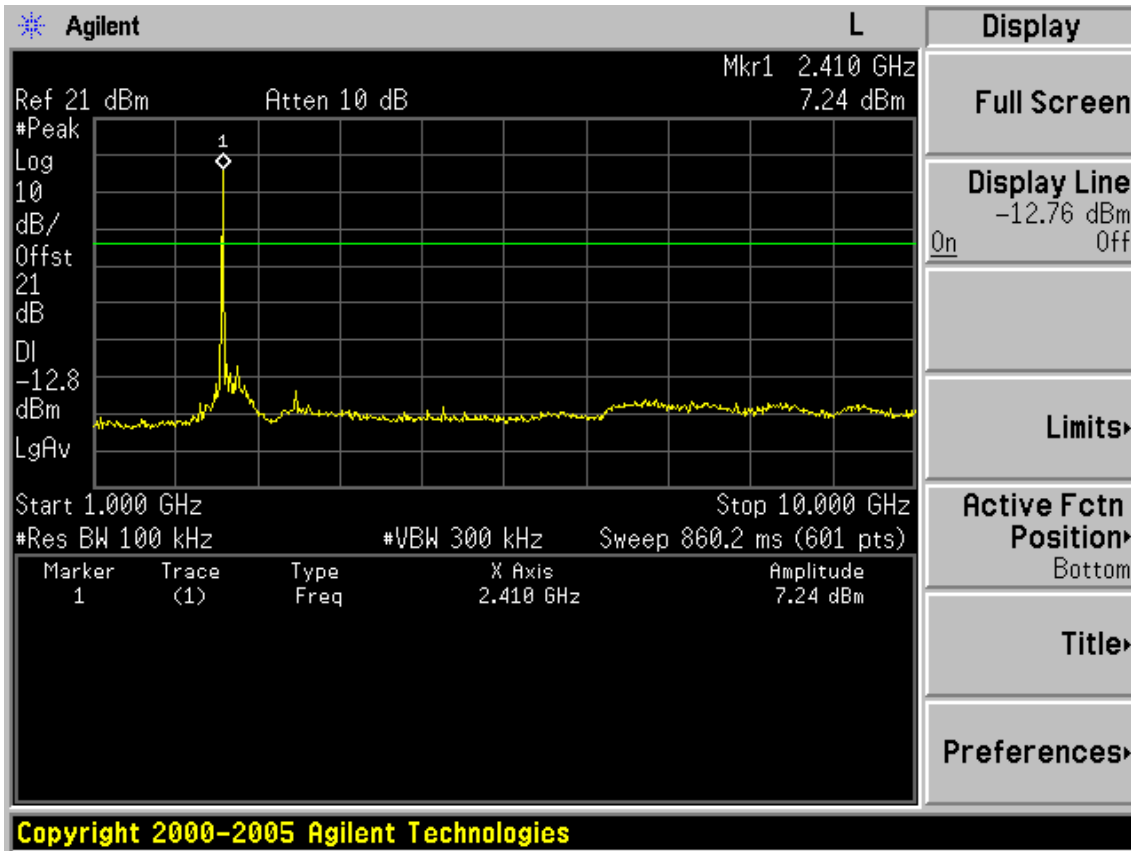

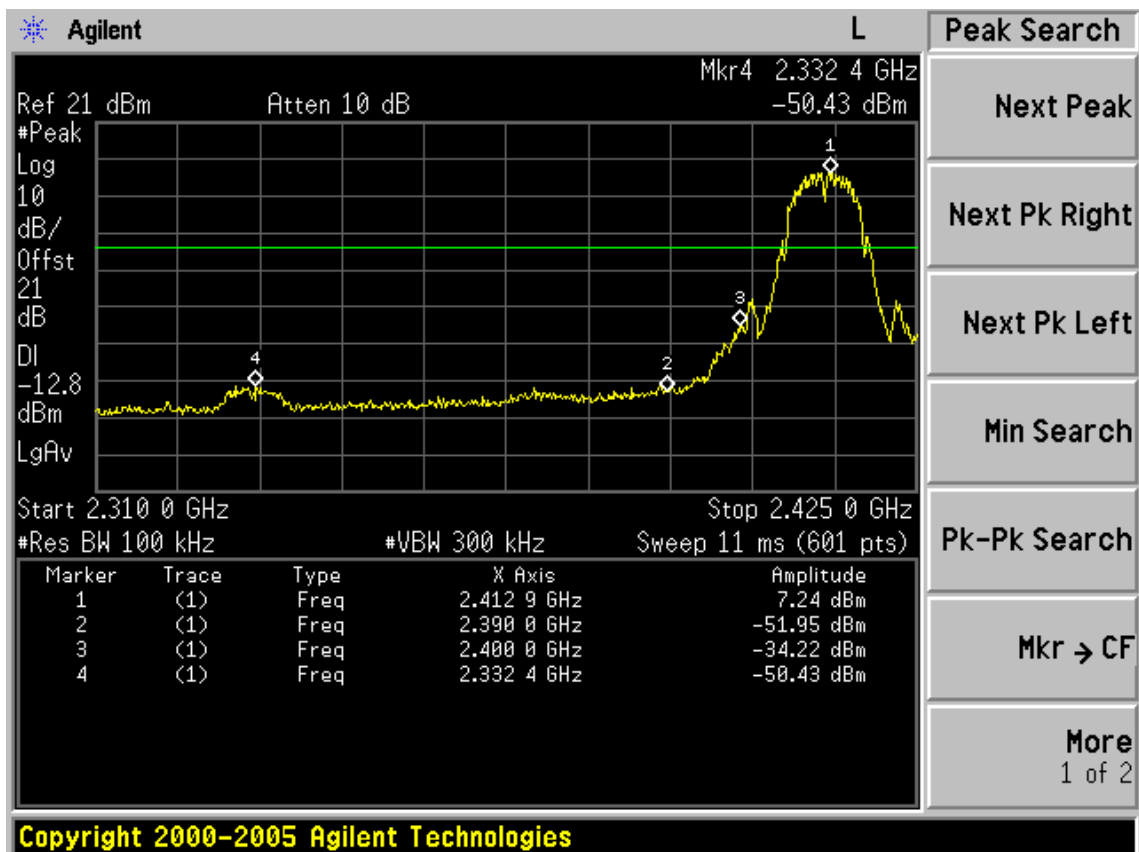
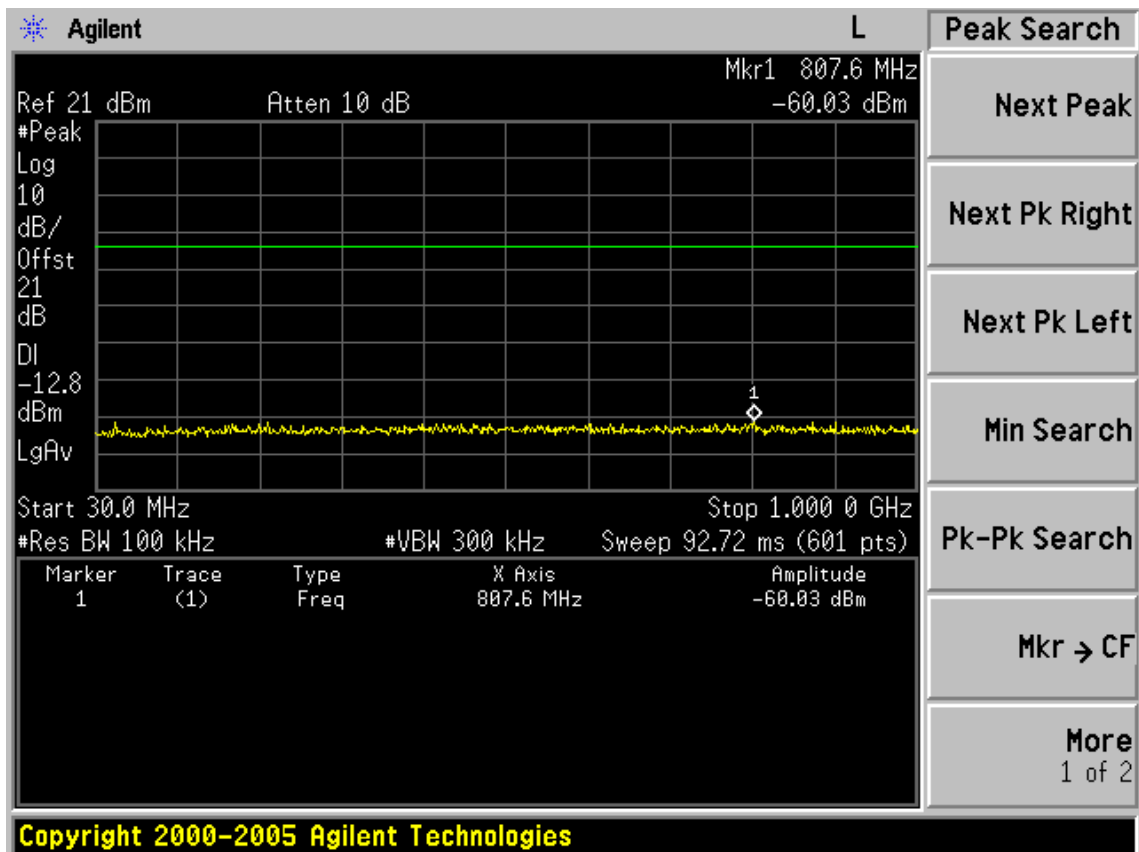

Test CH6: 2437MHz

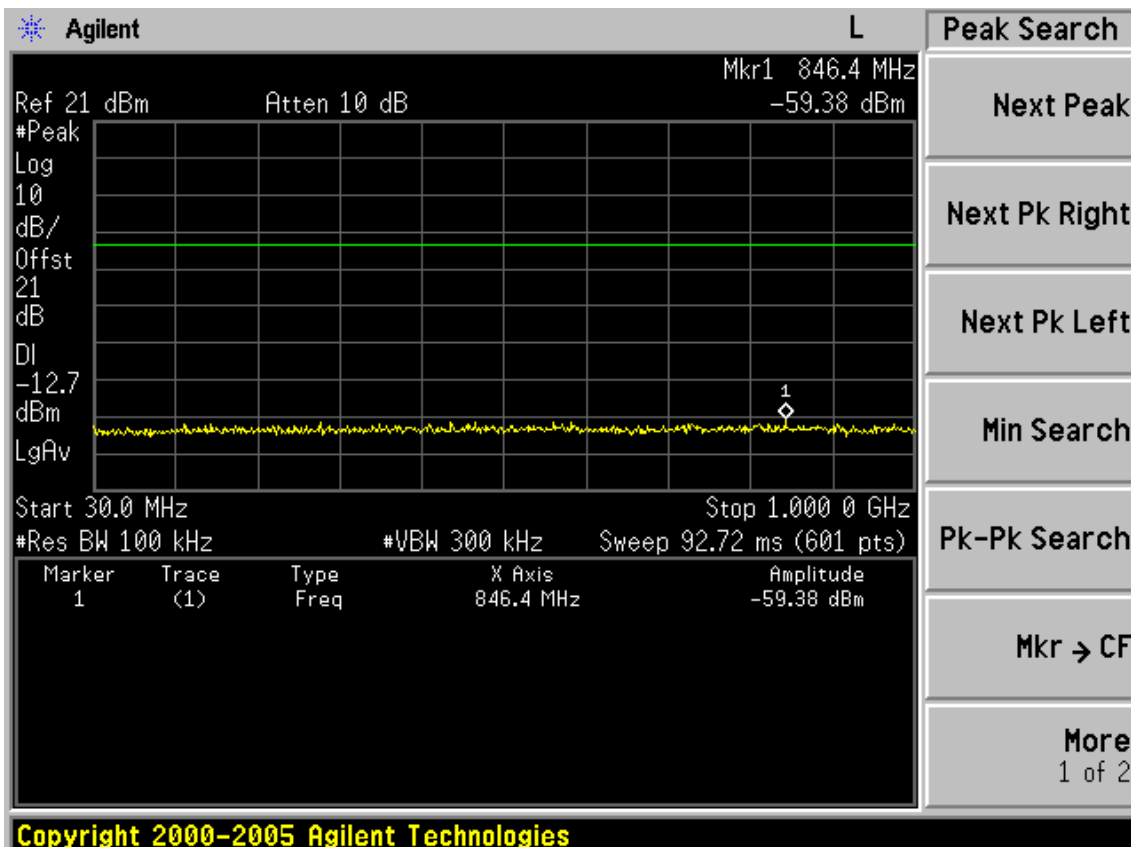
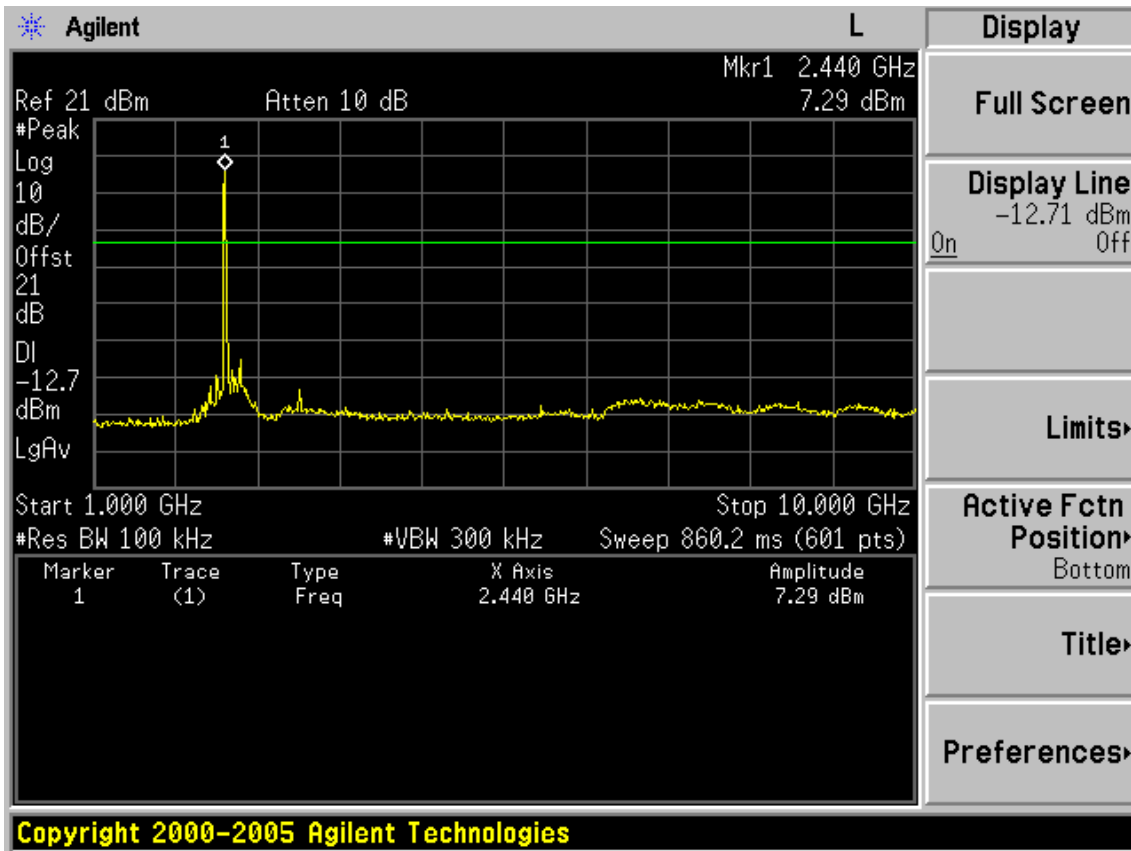

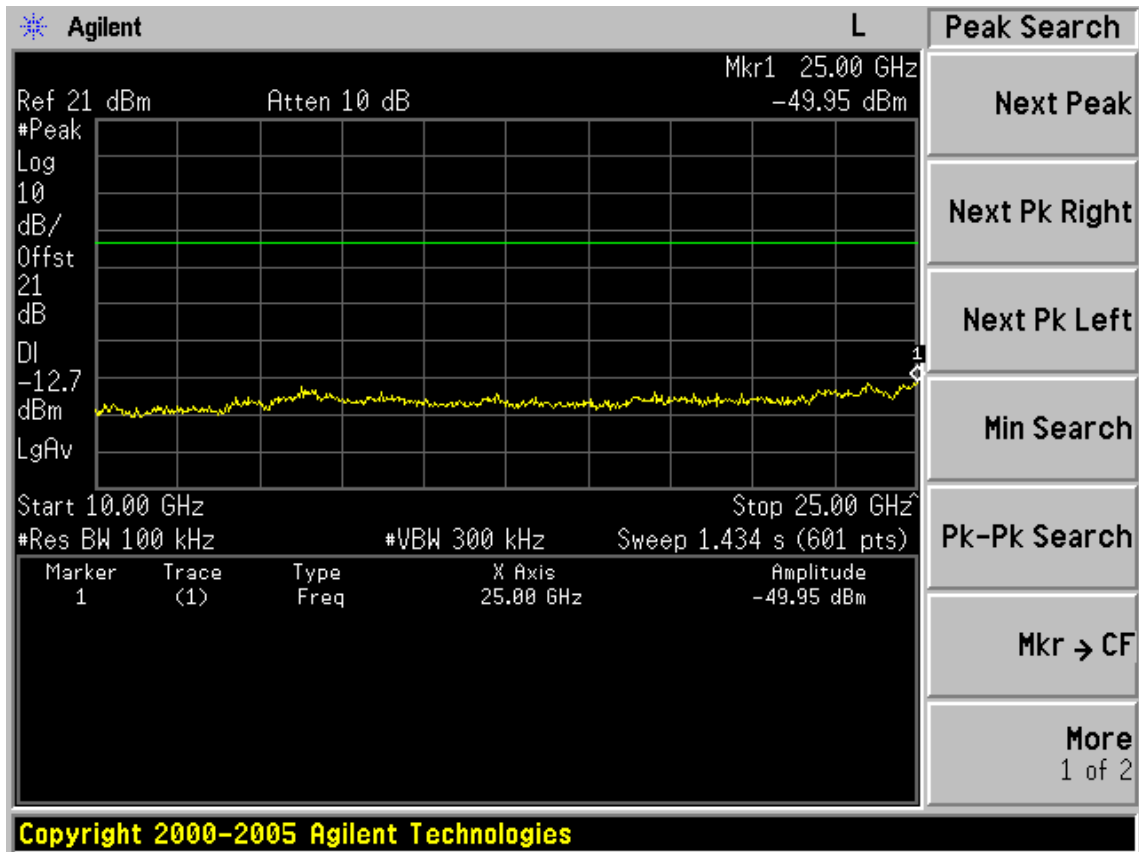

Test CH11: 2462MHz

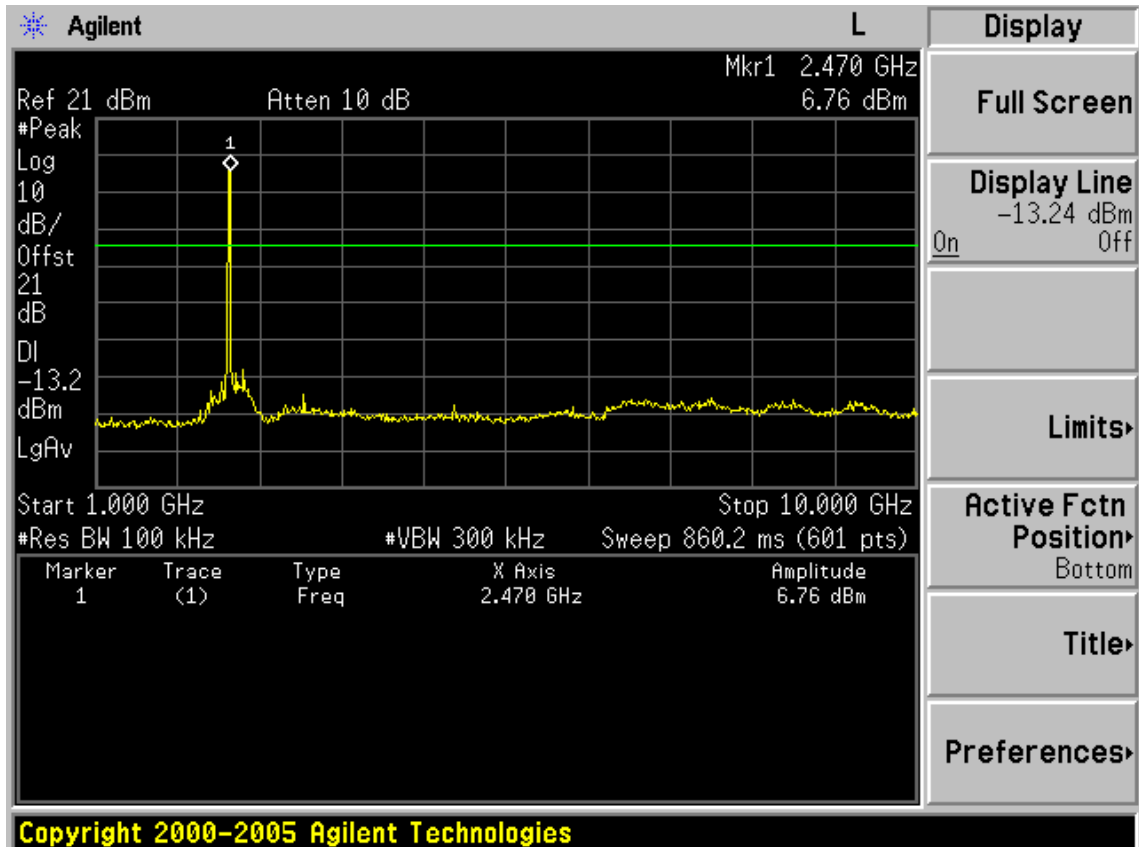



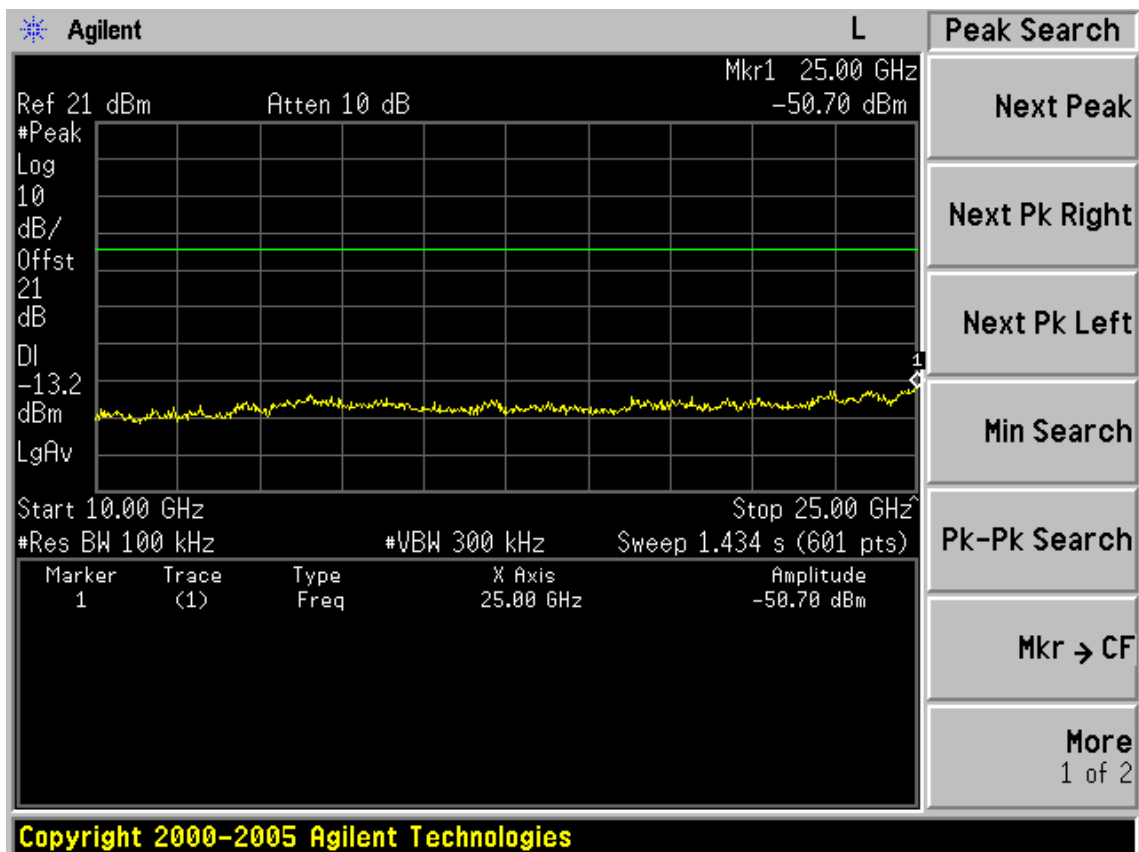
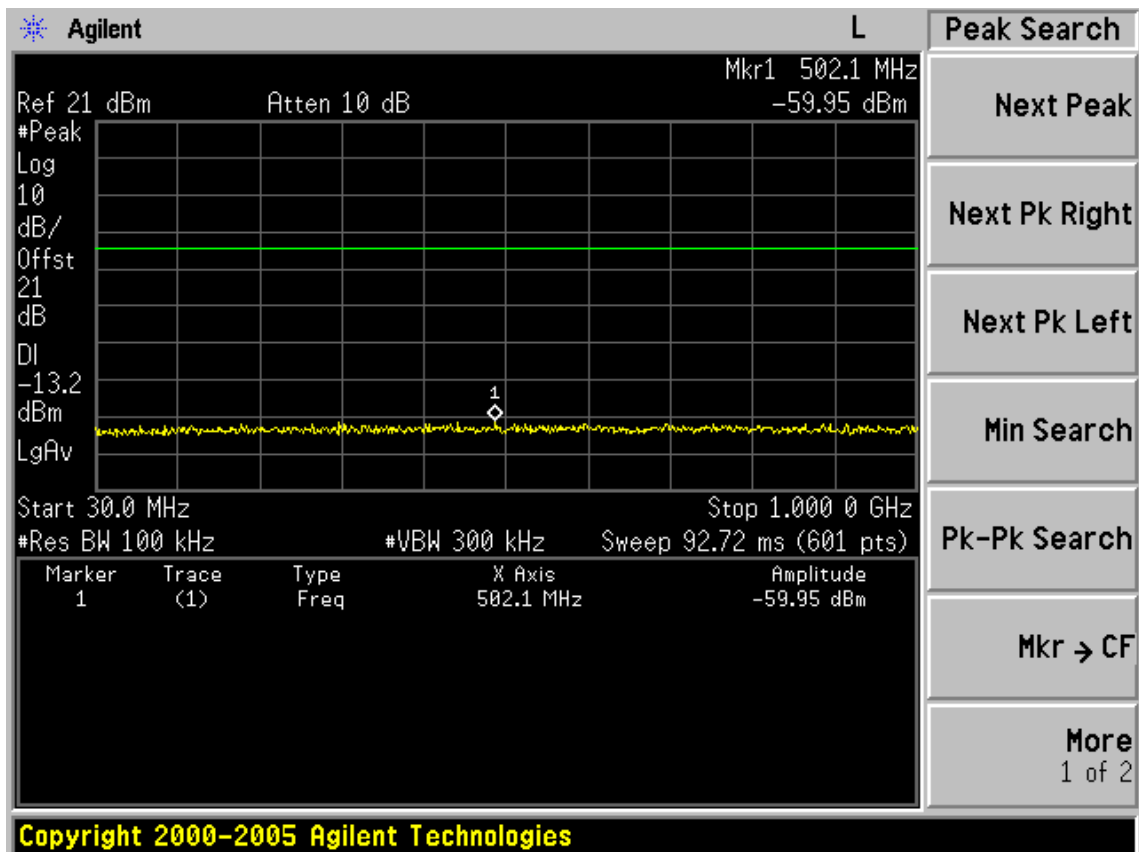

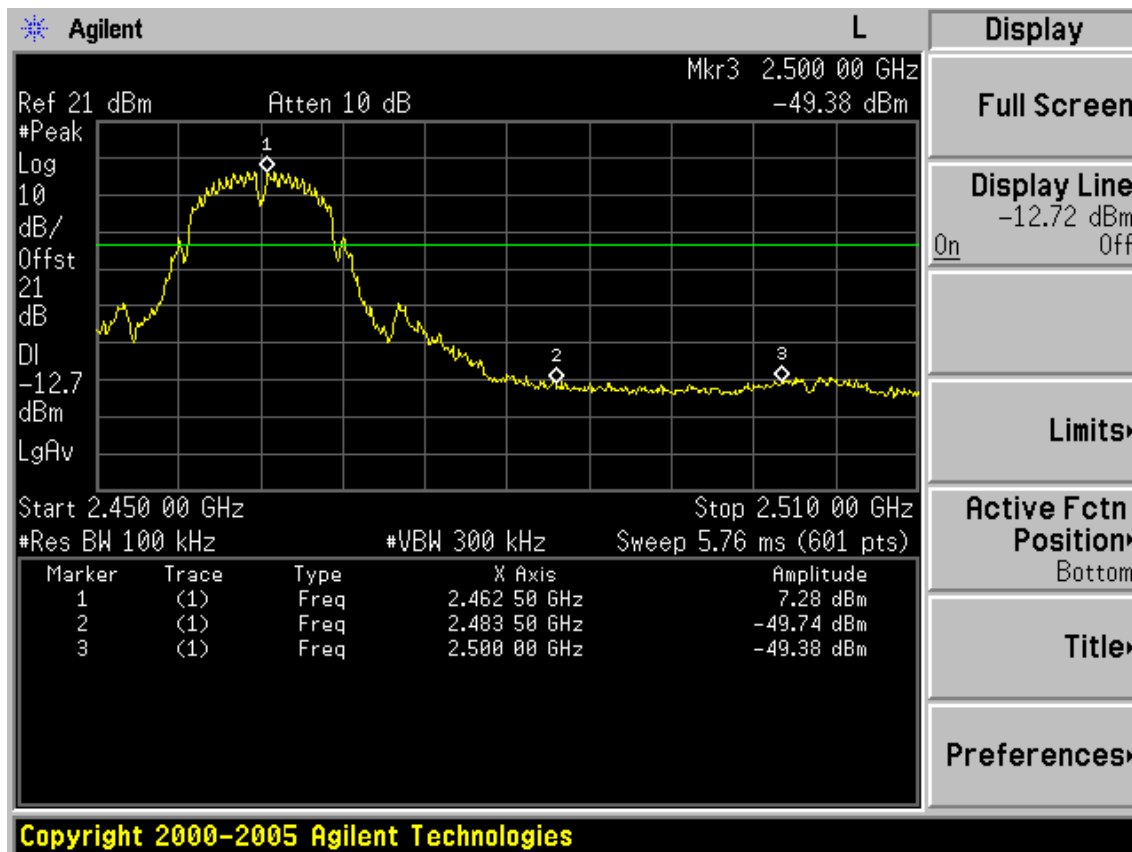

Test Mode: IEEE 802.11g TX  
Test CH1: 2412MHz

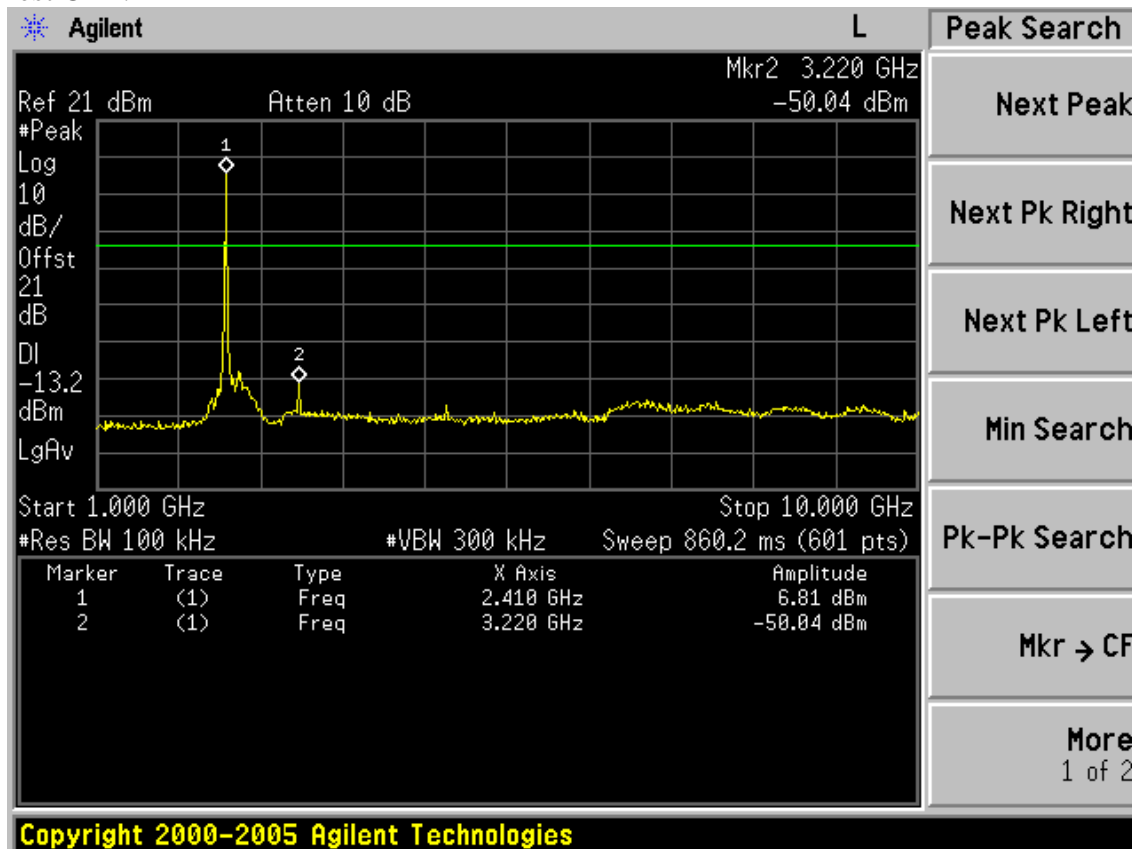

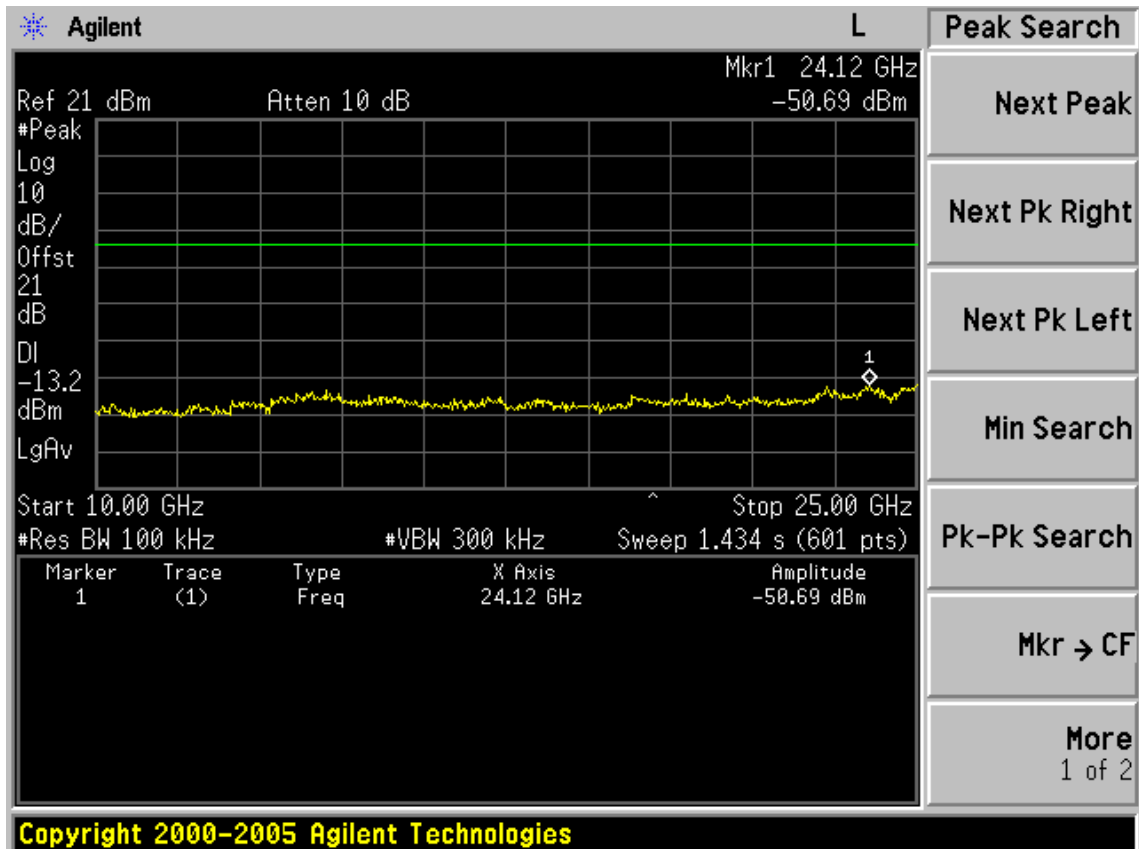
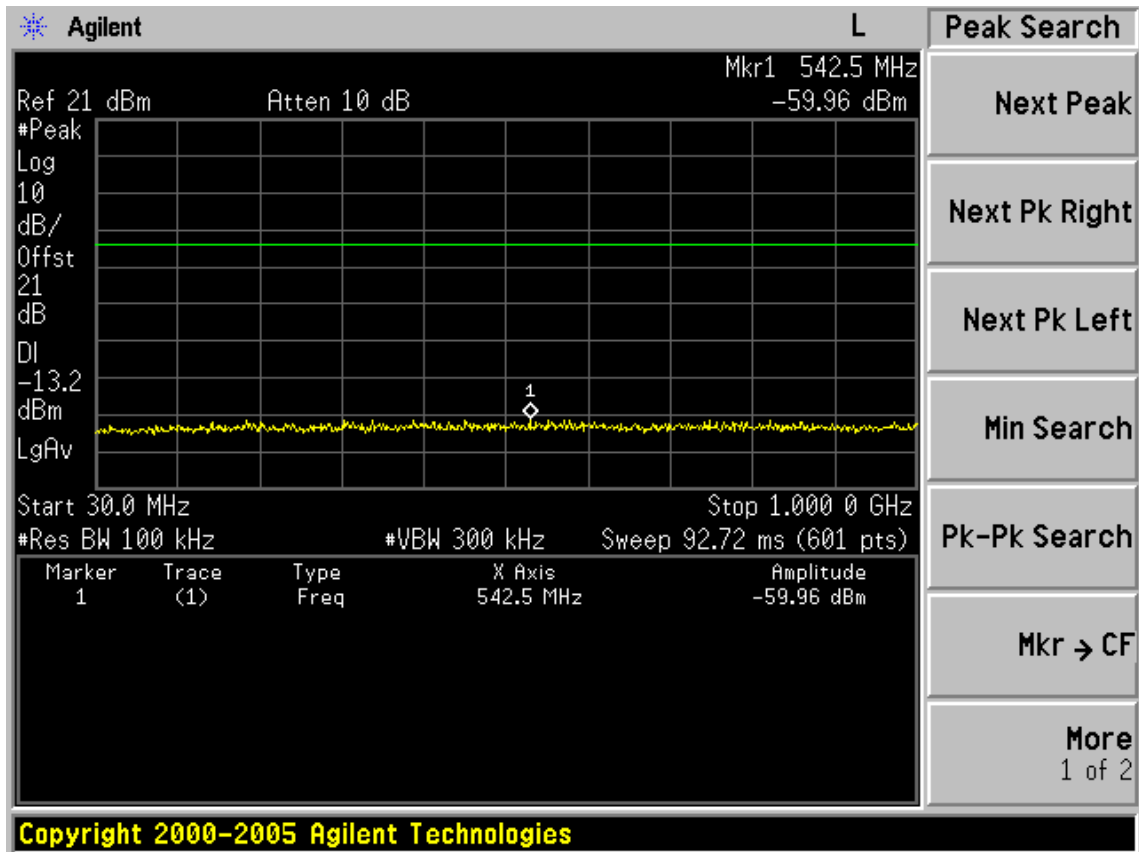

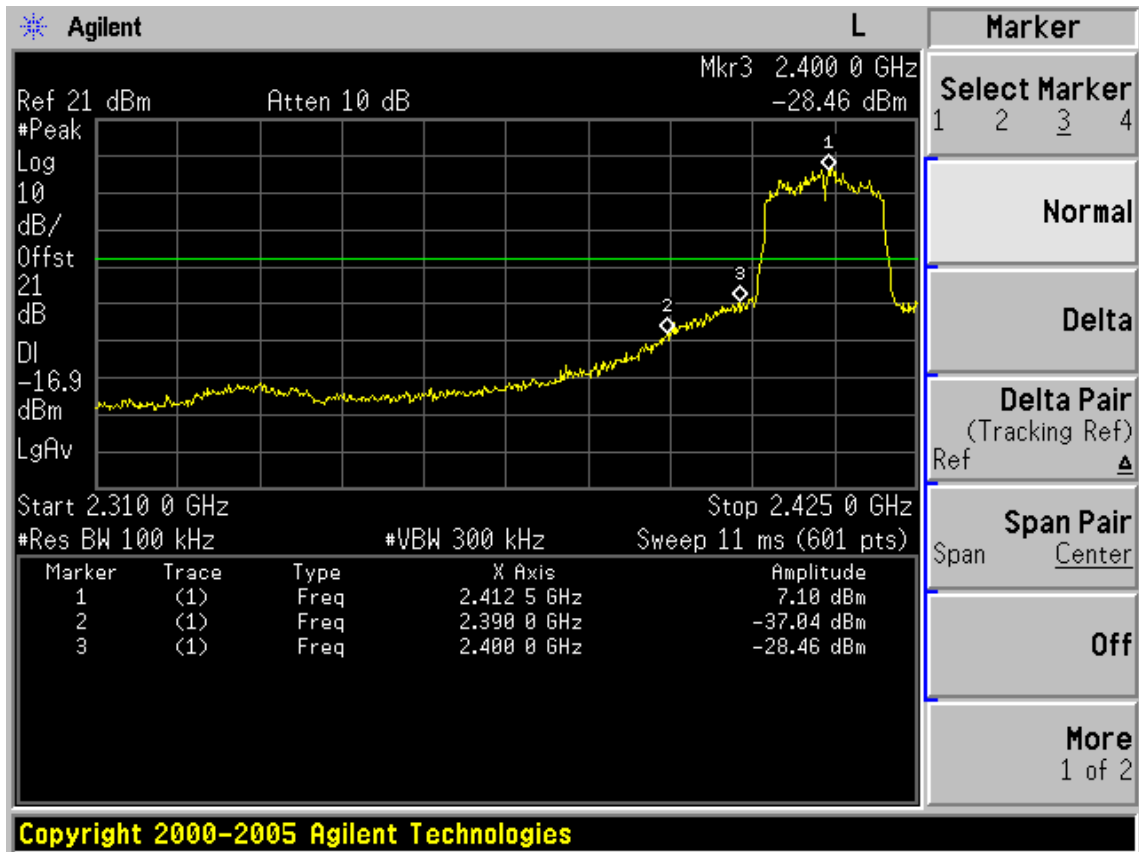

Test CH6: 2437MHz

