



FCC Part 15C Test Report

FCC ID:W6RRNX-AC1200UBV2

Product Name:	AC1200 wifi USB lan card
Trademark:	N/A
Model Name :	RNX-AC1200UBv2
Prepared For :	Rosewill Inc.
Address :	17708 Rowland St. City of Industry, CA 91748
Prepared By :	Shenzhen BCTC Technology Co., Ltd.
Address :	No.101,Yousong Road,Longhua New District, Shenzhen,China
Test Date:	Jun. 23 – Jul. 10, 2017
Date of Report :	Jul. 10, 2017
Report No.:	BCTC-FY170604116-2E



VERIFICATION OF COMPLIANCE

Applicant's name **Rosewill Inc.**

Address..... 17708 Rowland St. City of Industry, CA 91748

Manufacture's Name **Rosewill Inc.**

Address..... 17708 Rowland St. City of Industry, CA 91748

Product description

Product name.....: AC1200 wifi USB lan card

Trademark.....: N/A

Model Name.....: RNX-AC1200UBv2

Test procedure.....: FCC Part15.407

ANSI C63.10-2013

Standards

KDB789033 D02 General UNII Test Procedures New Rules v01r02

This device described above has been tested by BCTC, and the test results show that the equipment under test (EUT) is in compliance with the FCC requirements. And it is applicable only to the tested sample identified in the report.

This report shall not be reproduced except in full, without the written approval of BCTC, this document may be altered or revised by BCTC, personal only, and shall be noted in the revision of the document.

Test Result

Pass

Testing Engineer :

Eric Yang

Reviewer (Supervisor) :

Simon Wang

Approved & Authorized Signer(Manager) :



TABLE OF CONTENTS



Test Report Declaration	Page
1. TEST SUMMARY	5
2. GENERAL PRODUCT INFORMATION	6
2.1. Product Function.....	6
2.2. Description of Device (EUT)	6
2.3. Test Supporting System.....	7
2.4. Independent Operation Modes	7
2.5. Test Sites	8
2.6. List of Test and Measurement Instruments.....	9
3. TEST SET-UP AND OPERATION MODES.....	10
3.1. Principle of Configuration Selection	10
3.2. Block Diagram of Test Set-up	10
3.3. Auxiliary Equipment.....	11
3.4. Countermeasures to Achieve EMC Compliance.....	11
4. EMISSION TEST RESULTS	12
4.1. Conducted Emission Measurement	12
4.2. Radiated Emission Measurement	16
5. BAND EDGE COMPLIANCE TEST	37
5.1. Limits.....	37
5.2. TEST PROCEDURE	37
5.3. Test Data.....	37
6. 26DB AND 99% BANDWIDTH TEST	46
6.1. Measurement Procedure	46
7. MINIMUM 6 DB BANDWIDTH	54
7.1. Applied procedures / limit.....	54
7.2. TEST PROCEDURE	54
7.3 Test result	54
8. OUTPUT POWER TEST	61
8.1. Limits.....	61
8.2. Test setup.....	61
8.3. Test result.....	62
9. PEAK POWER SPECTRAL DENSITY TEST	63
9.1. Limits.....	63
9.2. Test setup.....	63
9.3. Test data	64
10. DUTY CYCLE TEST SIGNAL	77
11. FREQUENCY STABILITY	81
11.1. Limits.....	81
11.2. Test Procedures	81
11.3. Test Setup Layout	81
11.4. EUT Operation during Test.....	81
11.5. Test Results	82
12. TRANSMISSION IN THE ABSENCE OF DATA.....	94
12.1. Limits.....	94
12.2. Test result.....	94
13. ANTENNA REQUIREMENT	95
13.1. STANDARD REQUIREMENT.....	95



13.2.	EUT ANTENNA	95
14.	PHOTOGRAPHS OF TEST SET-UP	96
15.	PHOTOGRAPHS OF THE EUT	98



1.TEST SUMMARY

Test Items	Test Requirement	Result
Conducted Emissions	RSS-GEN 15.207	PASS
Radiated Emissions	RSS-GEN 15.407(b), 15.209	PASS
26dB bandwidth and 99%dB Bandwidth	RSS-247 15.403(i) 15.407(e)	PASS
Minimum 6 dB bandwidth	15.407(e)	PASS
Power density	RSS-247 15.407 (a)	PASS
Maximum Peak Output Power	RSS-247 15.407 (a)	PASS
Emissions from out of band	RSS-247 15.407 (b)	PASS
Transmission in case of Absence of Information	RSS-247 15.407(c)	PASS
Frequency Stability	RSS-247 15.407(g)	PASS
Antenna Requirement	15.203	PASS

Note: N/A means not applicable.



2.GENERAL PRODUCT INFORMATION

2.1. Product Function

Refer to Technical Construction Form and User Manual.

2.2. Description of Device (EUT)

Product Name:	AC1200 wifi USB lan card
Model No.:	RNX-AC1200UBv2
Trade Name:	N/A
Operation Frequency:	5180-5240, 5745-5825MHz(802.11a/n(HT20))
Channel numbers:	See channel list
Modulation technology:	64QAM, 16QAM, QPSK, BPSK for OFDM
Data speed (IEEE 802.11a):	6Mbps, 9Mbps, 12Mbps, 18Mbps, 24Mbps, 36Mbps, 48Mbps,54Mbps
Data speed (IEEE 802.11n):	Up to 300Mbps
Antenna Type:	PCB antenna*2
Antenna gain:	2.0dBi
Power supply:	DC 5V

Channel List for 802.11a/n(20)			
Channel	Frequency (MHz)	Channel	Frequency (MHz)
36	5180	44	5220
40	5200	48	5240

Channel List for 802.11a/n(20)			
Channel	Frequency (MHz)	Channel	Frequency (MHz)
149	5745	161	5805
153	5765	165	5825
157	5785		

Ant.	Brand	Model Name	Antenna Type	Connector	Gain (dBi)	NOTE
1	N/A	N/A	PCB antenna1	N/A	2.0	
2	N/A	N/A	PCB antenna2	N/A	2.0	

Note1: Directional Gain=2.0dBi+10log(2)=5dBi

Note2: The EUT 802.11n(20) is support MIMO mode, 802.11a is support SISO mode.

Note3: Pre-test Ant1 and Ant2, find that Ant1 is worst mode,so only show ant1 test data as below.

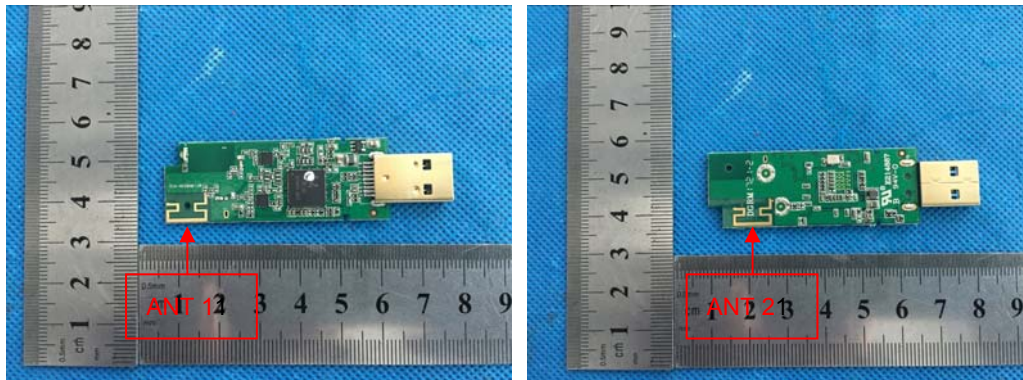

2.3. Test Supporting System

None.

2.4. Independent Operation Modes

The basic operation modes are:

These is Digital Transmission system (DTS) and have modulation OFDM, DSSS, DBPSK, DQPSK, CCK, 16QAM, 64QAM. According exploratory test, EUT will have maximum output power in those data rate (802.11a/n20: 6Mbps.), so those data rate were used for all test. The equipment enables high-speed access without wires to network assets. This adapter uses the IEEE 802.11 protocol to enable wireless communications between the host and Wireless router.



802.11a/n(20)

Frequency	Band 1	Band 4
Low	5180MHz	5745MHz
Middle	5200MHz	5785MHz
High	5240MHz	5825MHz

Note: for conducted emission test, we pretest all mode, the worst mode was 802.11a channel 36.

for radiated emissions test, we pretest all mode, the worst mode was 802.11a/n20

The worst mode's data was recording and show in the test report.

Software power setting

Channel	Frequency	Setting
802.11a	5180MHz	14
	5200MHz	14
	5240MHz	14
	5745MHz	15
	5785MHz	15
	5825MHz	15
802.11n20	5180MHz	13
	5200MHz	13
	5240MHz	13
	5745MHz	14
	5785MHz	14
	5825MHz	14

2.5. Test Sites

2.5.1. Test Facilities

Lab Qualifications : FCC Registration No.:187086
IC Registered No.:12655A



2.6. List of Test and Measurement Instruments

Conduction test equipment

Item	Kind of Equipment	Manufacturer	Type No.	Serial No.	Last calibration	Calibrated until	Calibration period
1	Test Receiver 9KHz-3GHz	R&S	ESCI	1166.5950K03-10 1165-ha	2017.07.06	2018.07.05	1 year
2	LISN	R&S	NSLK8126	8126466	2016.08.24	2017.08.23	1 year
3	LISN	R&S	NSLK8126	8126487	2016.08.24	2017.08.23	1 year
4	50Ω Coaxial Switch	Anritsu	MP59B	6200264417	2017.07.06	2018.07.05	1 year
5	RF cables	R&S	R204	R20X	2017.07.06	2018.07.05	1 year

Radiation test, Band-edge test and 6db bandwidth test equipment

Item	Kind of equipment	Manufacturer	Type No.	Serial No.	Last calibration	Calibrated until	Calibration period
1	Spectrum Analyzer 9kHz-26.5GHz	Agilent	E4407B	MY45108040	2017.07.06	2018.07.05	1 year
2	Test Receiver 9kHz-7GHz	R&S	ESPI	101318	2017.07.06	2018.07.05	1 year
3	Bilog Antenna 30MHz-1GMz	R&S	VULB 9168	VULB91 68-438	2017.07.06	2018.07.05	1 year
4	50Ω Coaxial Switch	Anritsu	MP59B	6200264416	2017.07.06	2018.07.05	1 year
5	Spectrum Analyzer 9KHz-3GHz	ADVANTEST	R3132	150900201	2017.07.06	2018.07.05	1 year
6	Horn Antenna 1GHz-18GHz	SCHWARZBECK	BBHA9120D	1201	2017.07.06	2018.07.05	1 year
7	Horn Antenna 14GHz-40GHz	SCHWARZBECK	BBHA 9170	9170-181	2017.07.06	2018.07.05	1 year
8	Amplifier 9KHz-6GHz	SCHWARZBECK	BBV9744	9744-0037	2016.08.24	2017.08.23	1 year
9	Amplifier 1GHz-18GHz	SCHWARZBECK	BBV9718	9718-309	2016.08.24	2017.08.23	1 year
10	Amplifier 18GHz-40GHz	SCHWARZBECK	BBV 9721	9721-205	2016.08.24	2017.08.23	1 year
11	Loop Antenna 9KHz-30MHz	SCHWARZBECK	FMZB1519B	00014	2017.07.06	2018.07.05	1 year
12	RF cables1 9kHz-1GHz	R&S	R203	R20X	2017.07.06	2018.07.05	1 year
13	RF cables2 1GHz-40GHz	R&S	R204	R21X	2017.07.06	2018.07.05	1 year
14	Antenna connector	Florida RFLabs	Lab-Fle	RF 01#	2017.07.06	2018.07.05	1 year
15	Power Metter	ANRITSU	ML2487A	6K00001568	2017.07.06	2018.07.05	1 year
16	Power Sensor (AV)	ANRITSU	ML2491A	030989	2017.07.06	2018.07.05	1 year
17	Signal Analyzer 9kHz-26.5GHz	Agilent	N9010A	MY48030494	2017.07.06	2018.07.05	1 year
18	Test Receiver 20kHz-40GHz	R&S	ESU 40	100376	2017.07.06	2018.07.05	1 year

3. TEST SET-UP AND OPERATION MODES

3.1. Principle of Configuration Selection

Emission: The equipment under test (EUT) was configured to measure its highest possible radiation level. The test modes were adapted accordingly in reference to the Operating Instructions.

3.2. Block Diagram of Test Set-up

Radiated Spurious Emission Test

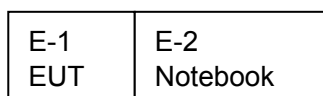

RF Test Set-up

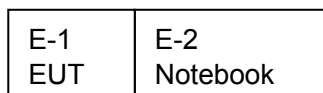

Conducted Emission Test

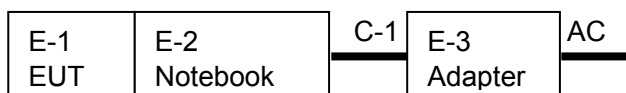

(EUT: AC1200 wifi USB lan card)



3.3. Auxiliary Equipment

Item	Equipment	Mfr/Brand	Model/Type No.	Series No.	Note
E-1	AC1200 wifi USB lan card	N/A	RNX-AC1200UBv2	N/A	EUT
E-2	Notebook	ASUS	X401A	X16-96072	Lab Provide
E-3	Adapter	ASUS	EXA0703YH	N/A	Lab Provide

Item	Shielded Type	Ferrite Core	Length	Note
C1	No	No	1.2m	DC cable unshielded

3.4. Countermeasures to Achieve EMC Compliance

None.



4. EMISSION TEST RESULTS

4.1. Conducted Emission Measurement

POWER LINE CONDUCTED EMISSION Limits (Frequency Range 150KHz-30MHz)

FREQUENCY (MHz)	Limit (dBuV)		Standard
	Quasi -peak	Average	
0.15 -0.5	66 - 56 *	56 - 46 *	FCC
0.50 -5.0	56.00	46.00	FCC
5.0 -30.0	60.00	50.00	FCC

Note:

- (1) The tighter limit applies at the band edges.
- (2) The limit of " * " marked band means the limitation decreases linearly with the logarithm of the frequency in the range.

The following table is the setting of the receiver

Receiver Parameters	Setting
Attenuation	10 dB
Start Frequency	0.15 MHz
Stop Frequency	30 MHz
IF Bandwidth	9 kHz

4.1.1. TEST PROCEDURE

- a. The EUT was placed 0.8 meters from the horizontal ground plane with EUT being connected to the power mains through a line impedance stabilization network (LISN). All other support equipments powered from additional LISN(s). The LISN provide 50 Ohm/ 50uH of coupling impedance for the measuring instrument.
- b. Interconnecting cables that hang closer than 40 cm to the ground plane shall be folded back and forth in the center forming a bundle 30 to 40 cm long.
- c. I/O cables that are not connected to a peripheral shall be bundled in the center. The end of the cable may be terminated, if required, using the correct terminating impedance. The overall length shall not exceed 1 m.
- d. LISN at least 80 cm from nearest part of EUT chassis.
- e. For the actual test configuration, please refer to the related Item –EUT Test Photos.

4.1.2. DEVIATION FROM TEST STANDARD

No deviation

4.1.3. TEST SETUP

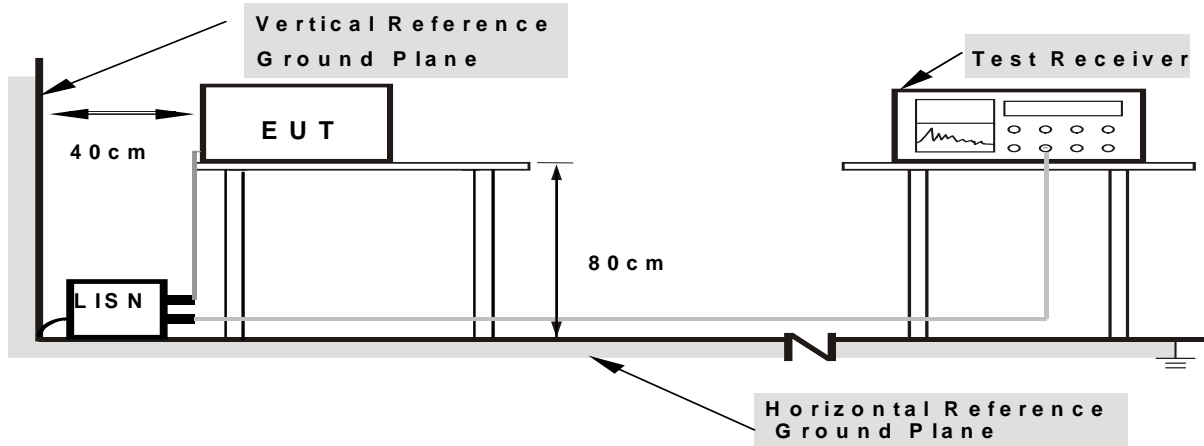

- Note: 1.Support units were connected to second LISN.
2.Both of LISNs (AMN) are 80 cm from EUT and at least 80 cm from other units and other metal planes

4.1.4. EUT OPERATING CONDITIONS

The EUT was configured for testing in a typical fashion (as a customer would normally use it). The EUT has been programmed to continuously transmit during test. This operating condition was tested and used to collect the included data.

We pretest all adapter's emission, only the adapter 1's data was worst and the data was recording in the report.

The data only show the worst mode.

If peak level comply with Quasi-Peak limit, then the Quasi-Peak level is deemed to comply with Quasi-Peak limit.

We pretest AC 120V and AC 240V, the worst voltage was AC 120V and the data recording in the report

4.1.5. TEST RESULTS



Temperature :	25 °C	Relative Humidity :	54%
Pressure :	1010hPa	Phase :	L
Test Voltage :	AC 120V/60Hz	Test Mode :	Link

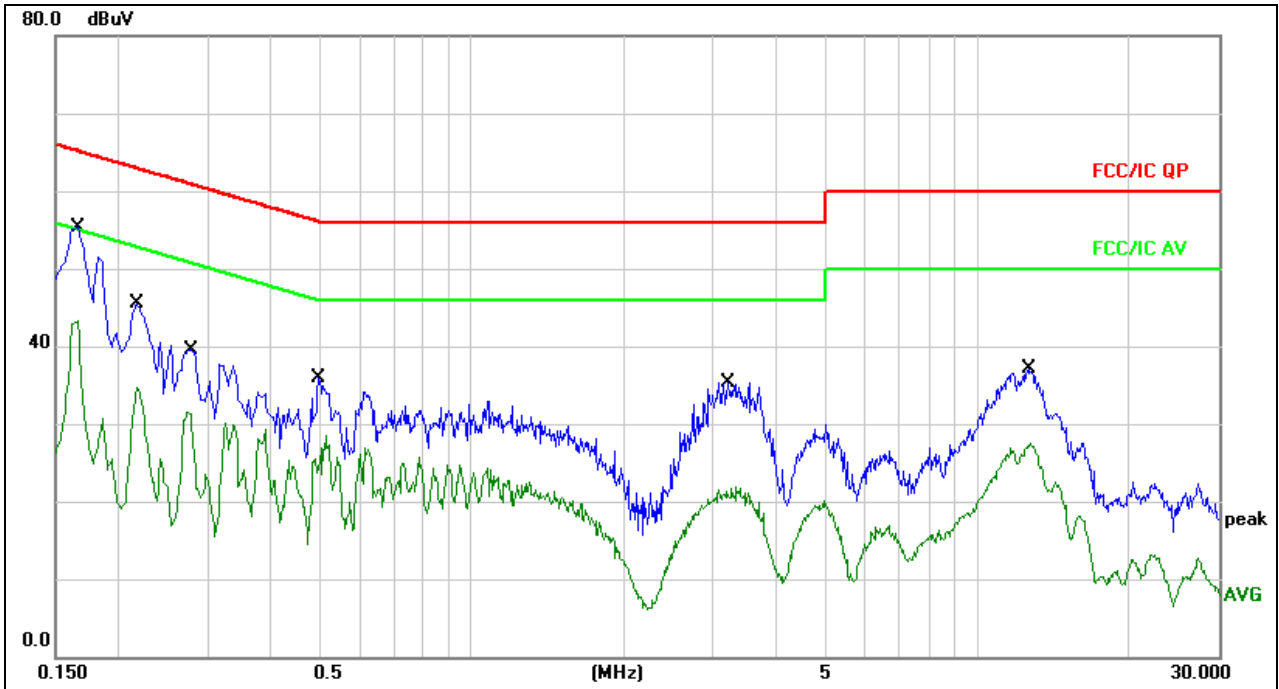

Remark:

1. All readings are Quasi-Peak and Average values.
2. Factor = Insertion Loss + Cable Loss.

No. Mk.	Freq. MHz	Reading Level dBuV	Correct Factor dB	Measurement dBuV	Limit dBuV	Over dB	Detector	Comment
1 *	0.1660	45.16	10.06	55.22	65.15	-9.93	QP	
2	0.1660	33.24	10.06	43.30	55.15	-11.85	AVG	
3	0.2180	35.37	10.07	45.44	62.89	-17.45	QP	
4	0.2180	24.64	10.07	34.71	52.89	-18.18	AVG	
5	0.2740	29.58	10.09	39.67	60.99	-21.32	QP	
6	0.2740	21.39	10.09	31.48	50.99	-19.51	AVG	
7	0.4980	25.83	10.11	35.94	56.03	-20.09	QP	
8	0.4980	18.32	10.11	28.43	46.03	-17.60	AVG	
9	3.2180	25.07	10.18	35.25	56.00	-20.75	QP	
10	3.2180	11.75	10.18	21.93	46.00	-24.07	AVG	
11	12.6059	27.03	10.14	37.17	60.00	-22.83	QP	
12	12.6059	17.42	10.14	27.56	50.00	-22.44	AVG	



Temperature :	25 °C	Relative Humidity :	54%
Pressure :	1010hPa	Phase :	N
Test Voltage :	AC 120V/60Hz	Test Mode :	Link

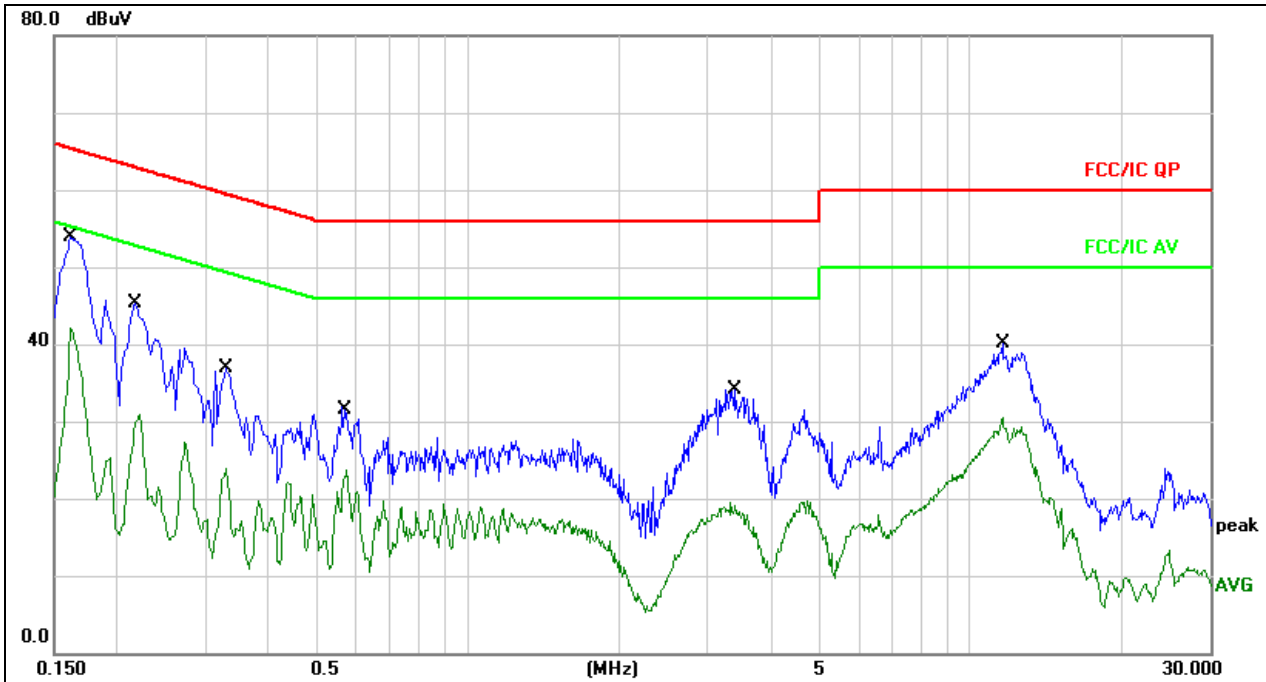

Remark:

1. All readings are Quasi-Peak and Average values.
2. Factor = Insertion Loss + Cable Loss.

No.	Mk.	Freq. MHz	Reading Level dBuV	Correct Factor dB	Measure- ment dBuV	Limit dBuV	Over dB	Detector	Comment
1	*	0.1620	43.77	10.05	53.82	65.36	-11.54	QP	
2		0.1620	32.14	10.05	42.19	55.36	-13.17	AVG	
3		0.2180	35.21	10.07	45.28	62.89	-17.61	QP	
4		0.2180	20.79	10.07	30.86	52.89	-22.03	AVG	
5		0.3300	26.83	10.10	36.93	59.45	-22.52	QP	
6		0.3300	13.77	10.10	23.87	49.45	-25.58	AVG	
7		0.5740	21.78	10.12	31.90	56.00	-24.10	QP	
8		0.5740	13.53	10.12	23.65	46.00	-22.35	AVG	
9		3.3820	24.01	10.18	34.19	56.00	-21.81	QP	
10		3.3820	9.29	10.18	19.47	46.00	-26.53	AVG	
11		11.5900	29.92	10.13	40.05	60.00	-19.95	QP	
12		11.5900	20.33	10.13	30.46	50.00	-19.54	AVG	



4.2. Radiated Emission Measurement

4.2.1. Radiated Emission Limits (Frequency Range 9kHz-1000MHz)

20dBc in any 100 kHz bandwidth outside the operating frequency band. In case the emission fall within the restricted band specified on 15.205(a), then the 15.209(a) limit in the table below has to be followed.

Frequencies (MHz)	Field Strength (micorvolts/meter)	Measurement Distance (meters)
0.009~0.490	2400/F(KHz)	300
0.490~1.705	24000/F(KHz)	30
1.705~30.0	30	30
30~88	100	3
88~216	150	3
216~960	200	3
Above 960	500	3

LIMITS OF RADIATED EMISSION MEASUREMENT (Above 1000MHz)

FREQUENCY (MHz)	Limit (dBuV/m) (at 3M)	
	PEAK	AVERAGE
Above 1000	74	54

Notes:

- (1) The limit for radiated test was performed according to FCC PART 15C.
- (2) The tighter limit applies at the band edges.
- (3) Emission level (dBuV/m)=20log Emission level (uV/m).

FREQUENCY RANGE OF RADIATED MEASUREMENT (For unintentional radiators)

Highest frequency generated or Upper frequency of measurement used in the device or on which the device operates or tunes (MHz)	Range (MHz)
Below 1.705	30
1.705 – 108	1000
108 – 500	2000
500 – 1000	5000
Above 1000	5th harmonic of the highest frequency or 40 GHz, whichever is lower



Spectrum Parameter	Setting
Attenuation	Auto
Start Frequency	1000 MHz
Stop Frequency	10th carrier harmonic
RB / VB (emission in restricted band)	1 MHz / 1 MHz for Peak, 1 MHz / 10Hz for Average

Receiver Parameter	Setting
Attenuation	Auto
Start ~ Stop Frequency	9kHz~150kHz / RB 200Hz for QP
Start ~ Stop Frequency	150kHz~30MHz / RB 9kHz for QP
Start ~ Stop Frequency	30MHz~1000MHz / RB 120kHz for QP

4.2.2. TEST PROCEDURE

- The EUT was placed on the top of a rotating table 0.8 meters above the ground at a 3 meter semi-anechoic chamber. The table was rotated 360 degrees to determine the position of the highest radiation.
- The EUT was set 3 meters away from the interference-receiving antenna, which was mounted on the top of a variable-height antenna tower.
- The antenna height is varied from one meter to four meters above the ground to determine the maximum value of the field strength. Both horizontal and vertical polarizations of the antenna are set to make the measurement.
- For each suspected emission, the EUT was arranged to its worst case and then the antenna was tuned to heights from 1 meter to 4 meters (for the test frequency of below 30MHz, the antenna was tuned to heights 1 meter) and the rotatable table was turned from 0 degrees to 360 degrees to find the maximum reading.
- The test-receiver system was set to Peak Detect Function and Specified Bandwidth with Maximum Hold Mode.
- If the emission level of the EUT in peak mode was 10dB lower than the limit specified, then testing could be stopped and the peak values of the EUT would be reported. Otherwise the emissions that did not have 10dB margin would be re-tested one by one using peak, quasi-peak or average method as specified and then reported in a data sheet.

Above 1GHz test procedure as below:

- Different between above is the test site, change from Semi- Anechoic Chamber to fully Anechoic Chamber and change form table 0.8 meter to 1.5 meter.
- Test the EUT in the lowest channel ,the middle channel ,the Highest channel

Note:

Both horizontal and vertical antenna polarities were tested and performed pretest to three orthogonal axis. The worst case emissions were reported

4.2.3. DEVIATION FROM TEST STANDARD

No deviation

4.2.4. TEST SETUP

(A) Radiated Emission Test-Up Frequency Below 30MHz

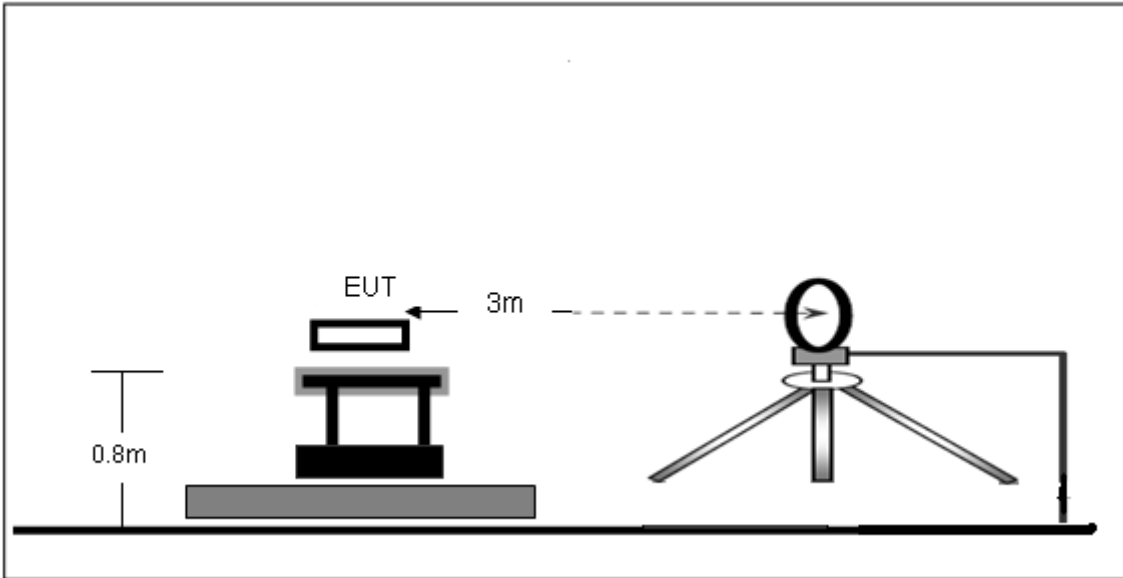

(B) Radiated Emission Test-Up Frequency 30MHz~1GHz

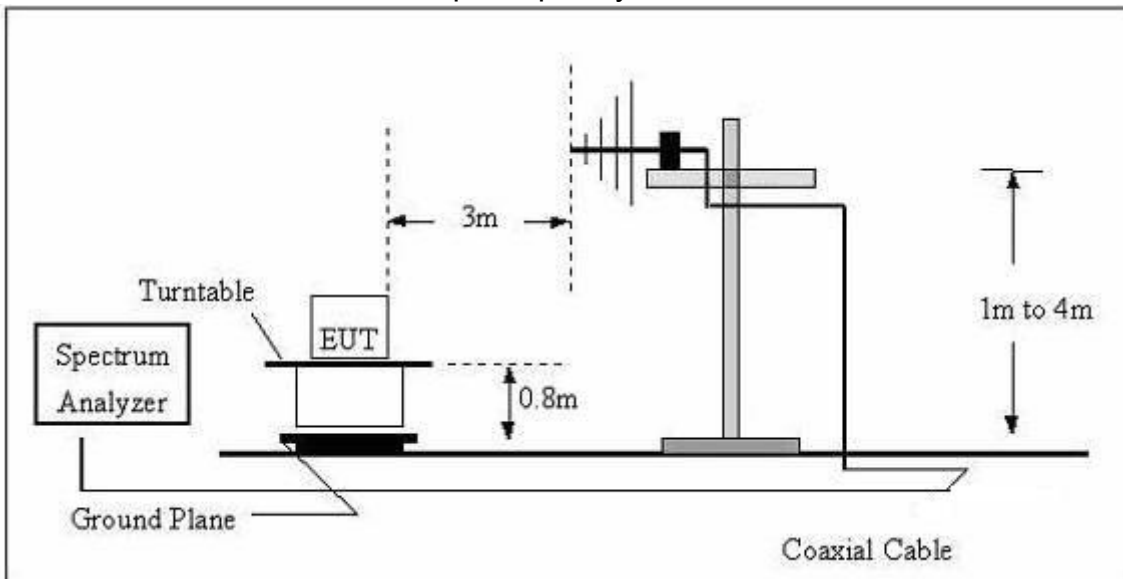

(C) Radiated Emission Test-Up Frequency Above 1GHz

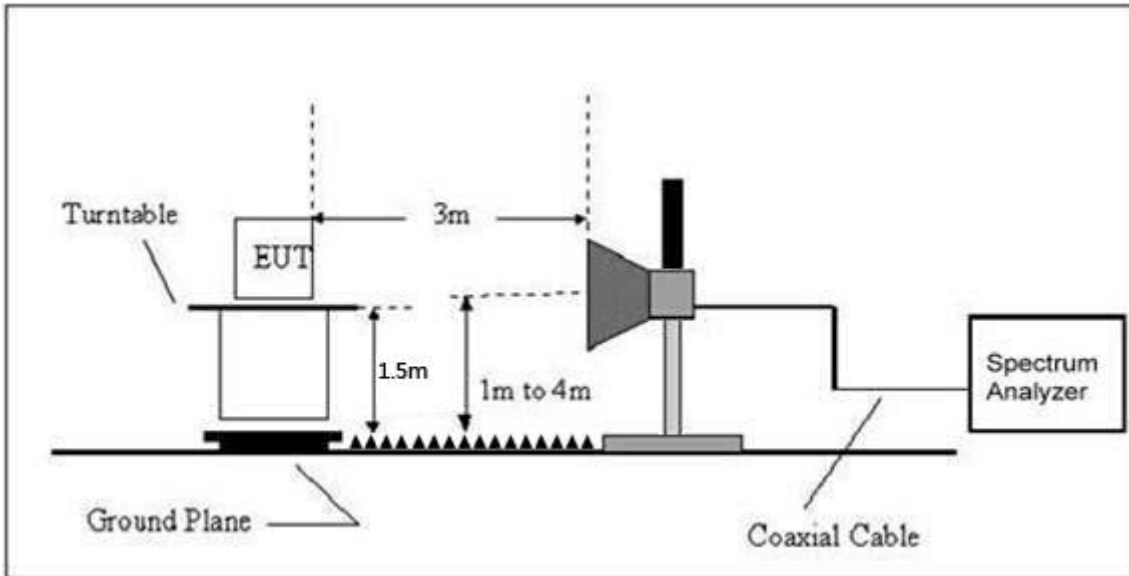

4.2.5. EUT OPERATING CONDITIONS

The EUT tested system was configured as the statements of 2.4 Unless otherwise a special operating condition is specified in the follows during the testing.

We pretest all adapter's emission, only the adapter 1's data was worst and the data was recording in the report.

The data only show the worst mode.



Radiated Spurious Emission (Below 30MHz)

EUT :	AC1200 wifi USB lan card	Model Name :	RNX-AC1200UBv2
Temperature :	20 °C	Relative Humidity :	48%
Pressure :	1010 hPa	Polarization :	---
Test Voltage :	DC 5V		
Test Mode :	TX		

Freq. (MHz)	Reading (dBuV/m)	Limit (dBuV/m)	Margin (dB)	State P/F
--	--	--	--	PASS
--	--	--	--	PASS

Note:

The amplitude of spurious emissions which are attenuated by more than 20dB below the permissible value has no need to be reported.

Distance extrapolation factor = $40 \log (\text{specific distance}/\text{test distance})$ (dB);

Limit line = specific limits(dBuv) + distance extrapolation factor.



Radiated Spurious Emission (Between 30MHz – 1GHz)

Temperature :	26 °C	Relative Humidity :	54%
Pressure :	1010 hPa	Polarization :	Horizontal
Test Voltage :	DC 5V		
Test Mode : (Worst)	Link Mode		

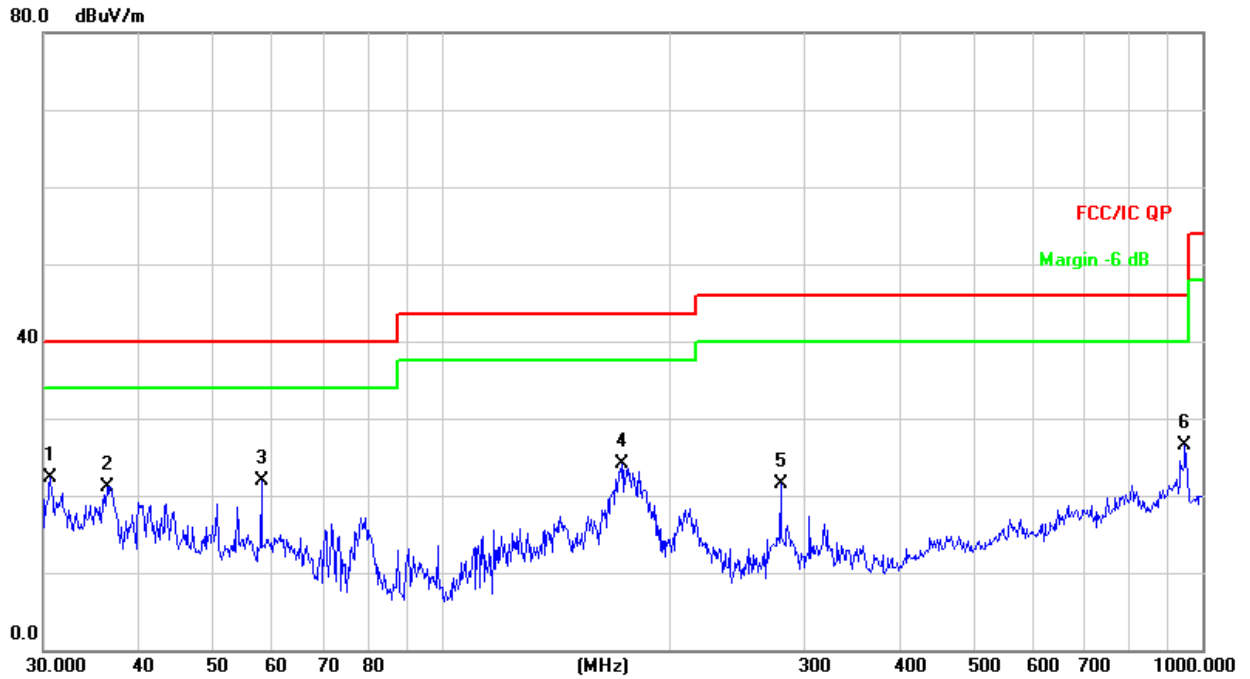

No.	Mk.	Freq. MHz	Reading Level dBuV	Correct Factor dB/m	Measure- ment dBuV/m	Limit dBuV/m	Over dB	Detector
1	*	30.6379	30.33	-8.11	22.22	40.00	-17.78	QP
2		36.3814	29.80	-8.62	21.18	40.00	-18.82	QP
3		57.9993	33.28	-11.36	21.92	40.00	-18.08	QP
4		172.5988	37.82	-13.68	24.14	43.50	-19.36	QP
5		279.0436	34.72	-13.13	21.59	46.00	-24.41	QP
6		948.7610	26.95	-0.48	26.47	46.00	-19.53	QP



Temperature :	26 °C	Relative Humidity :	54%
Pressure :	1010 hPa	Polarization :	Vertical
Test Voltage :	DC 5V		
Test Mode : (Worst)	Link Mode		

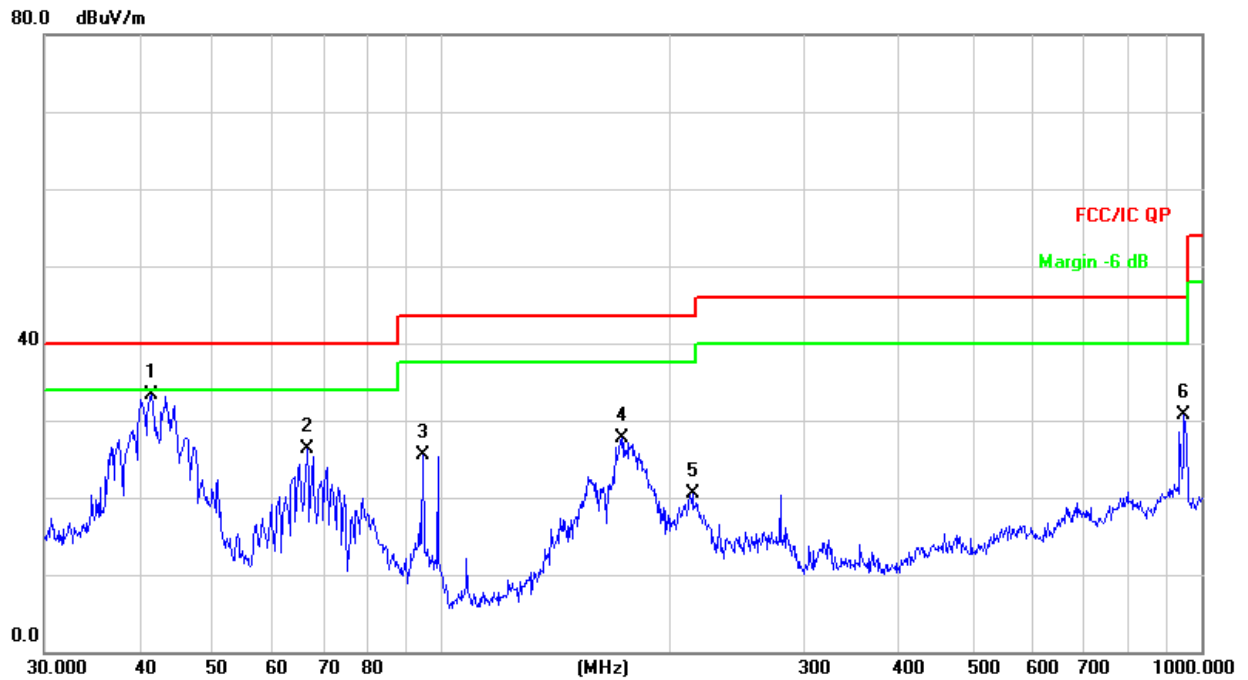

No.	Mk.	Freq. MHz	Reading Level dBuV	Correct Factor dB/m	Measure- ment dBuV/m	Limit dBuV/m	Over dB	Detector
1	*	41.4215	42.38	-9.03	33.35	40.00	-6.65	QP
2		66.4989	39.39	-13.12	26.27	40.00	-13.73	QP
3		94.4284	42.66	-17.08	25.58	43.50	-17.92	QP
4		172.5988	41.31	-13.68	27.63	43.50	-15.87	QP
5		213.7634	36.22	-15.80	20.42	43.50	-23.08	QP
6		948.7610	31.23	-0.48	30.75	46.00	-15.25	QP



Radiated Spurious Emission (Above 1GHz)

802.11a band 1

	Freq.	Receiver Reading	Detector	Polar	Pre-amplifier	Cable Loss	Antenna Factor	Emission Level	Limit	Result
	(MHz)	(dBμV)	(PK/QP/Ave)	(H/V)	(dB)	(dB)	(dB)	(dBμV/m)	(dBμV/m)	
Lower Channel 5180MHz	10360.00	47.96	PK	H	33.36	6.20	29.10	49.90	74.00	Pass
	10360.00	37.95	Ave	H	33.36	6.20	29.10	39.89	54.00	Pass
	15540.00	49.63	PK	H	34.40	6.55	26.50	48.28	74.00	Pass
	15540.00	38.92	Ave	H	34.40	6.55	26.50	37.57	54.00	Pass
	10360.00	47.83	PK	V	33.36	6.20	29.10	49.77	74.00	Pass
	10360.00	38.77	Ave	V	33.45	6.20	29.10	40.62	54.00	Pass
	15540.00	49.95	PK	V	34.40	6.55	26.50	48.60	74.00	Pass
	15540.00	39.13	Ave	V	34.40	6.55	26.50	37.78	54.00	Pass
	Middle Channel 5200MHz	10400.00	46.68	PK	H	33.65	6.45	29.36	48.84	74.00
10400.00		37.69	Ave	H	33.65	6.45	29.36	39.85	54.00	Pass
15600.00		49.19	PK	H	34.72	6.84	26.68	47.99	74.00	Pass
15600.00		37.70	Ave	H	34.72	6.84	26.68	36.50	54.00	Pass
10400.00		47.48	PK	V	33.65	6.45	29.36	49.64	74.00	Pass
10400.00		38.67	Ave	V	33.65	6.45	29.36	40.83	54.00	Pass
15600.00		48.44	PK	V	34.72	6.84	26.68	47.24	74.00	Pass
15600.00		37.99	Ave	V	34.72	6.84	26.38	36.49	54.00	Pass
Upper Channel 5240MHz	10480.00	46.86	PK	H	33.89	6.82	30.55	50.34	74.00	Pass
	10480.00	36.51	Ave	H	33.89	6.82	30.55	39.99	54.00	Pass
	15720.00	49.18	PK	H	35.12	6.95	27.85	48.86	74.00	Pass
	15720.00	38.00	Ave	H	35.12	6.95	27.85	37.68	54.00	Pass
	10480.00	47.87	PK	V	33.89	6.82	30.55	51.35	74.00	Pass
	10480.00	37.32	Ave	V	33.89	6.82	30.55	40.80	54.00	Pass
	15720.00	49.22	PK	V	35.12	6.95	27.85	48.90	74.00	Pass
	15720.00	38.13	Ave	V	35.12	6.95	27.85	37.81	54.00	Pass

Remark:

Emission Level = Receiver Reading + Antenna Factor + Cable Loss – Pre-amplifier.

Margin = Emission Level - Limit

Other harmonics emissions are lower than 20dB below the allowable limit.



802.11a band 4

	Freq.	Receiver Reading	Detector	Polar	Pre-amplifier	Cable Loss	Antenna Factor	Emission Level	Limit	Result
	(MHz)	(dBμV)	(PK/QP/Ave)	(H/V)	(dB)	(dB)	(dB)	(dBμV/m)	(dBμV/m)	
Lower Channel 5745MHz	11490.00	41.62	PK	H	34.25	6.48	29.46	43.31	74.00	Pass
	11490.00	32.63	Ave	H	33.25	6.48	29.46	35.32	54.00	Pass
	17235.00	43.34	PK	H	34.83	6.96	26.88	42.35	74.00	Pass
	17235.00	32.67	Ave	H	34.83	6.96	26.88	31.68	54.00	Pass
	11490.00	41.32	PK	V	34.25	6.48	29.46	43.01	74.00	Pass
	11490.00	32.46	Ave	V	33.25	6.48	29.46	35.15	54.00	Pass
	17235.00	43.59	PK	V	34.83	6.96	26.88	42.60	74.00	Pass
	17235.00	32.47	Ave	V	34.83	6.96	26.88	31.48	54.00	Pass
	Middle Channel 5785MHz	11570.00	42.33	PK	H	33.95	6.89	29.36	44.63	74.00
11570.00		32.87	Ave	H	33.95	6.89	29.36	35.17	54.00	Pass
17355.00		42.94	PK	H	35.25	7.10	27.22	42.01	74.00	Pass
17355.00		33.34	Ave	H	35.25	7.10	27.22	32.41	54.00	Pass
11570.00		42.26	PK	V	33.95	6.89	29.36	44.56	74.00	Pass
11570.00		32.65	Ave	V	33.95	6.89	29.36	34.95	54.00	Pass
17355.00		43.83	PK	V	35.25	7.10	27.22	42.90	74.00	Pass
17355.00		32.39	Ave	V	35.25	7.10	27.22	31.46	54.00	Pass
Upper Channel 5825MHz	11650.00	41.94	PK	H	34.35	7.15	30.15	44.89	74.00	Pass
	11650.00	30.86	Ave	H	34.35	7.15	30.15	33.81	54.00	Pass
	17475.00	44.57	PK	H	35.75	7.45	28.54	44.81	74.00	Pass
	17475.00	32.94	Ave	H	35.75	7.45	28.54	33.18	54.00	Pass
	11650.00	43.25	PK	V	34.35	7.15	30.15	46.20	74.00	Pass
	11650.00	31.93	Ave	V	34.35	7.15	30.15	34.88	54.00	Pass
	17475.00	44.03	PK	V	35.75	7.45	28.54	44.27	74.00	Pass
	17475.00	33.06	Ave	V	35.75	7.45	28.54	33.30	54.00	Pass

Remark:

Emission Level = Receiver Reading + Antenna Factor + Cable Loss – Pre-amplifier.

Margin = Emission Level - Limit

Other harmonics emissions are lower than 20dB below the allowable limit.



802.11n20 band 1

	Freq.	Receiver Reading	Detector	Polar	Pre-amplifier	Cable Loss	Antenna Factor	Emission Level	Limit	Result
	(MHz)	(dBμV)	(PK/QP/Ave)	(H/V)	(dB)	(dB)	(dB)	(dBμV/m)	(dBμV/m)	
Lower Channel 5180MHz	10360.00	47.68	PK	H	33.36	6.20	29.10	49.62	74.00	Pass
	10360.00	37.64	Ave	H	33.36	6.20	29.10	39.58	54.00	Pass
	15540.00	49.33	PK	H	34.40	6.55	26.50	47.98	74.00	Pass
	15540.00	36.62	Ave	H	34.40	6.55	26.50	35.27	54.00	Pass
	10360.00	47.52	PK	V	33.36	6.20	29.10	49.46	74.00	Pass
	10360.00	37.97	Ave	V	33.45	6.20	29.10	39.82	54.00	Pass
	15540.00	48.74	PK	V	34.40	6.55	26.50	47.39	74.00	Pass
	15540.00	36.83	Ave	V	34.40	6.55	26.50	35.48	54.00	Pass
	Middle Channel 5200MHz	10400.00	46.57	PK	H	33.65	6.45	29.36	48.73	74.00
10400.00		37.39	Ave	H	33.65	6.45	29.36	39.55	54.00	Pass
15600.00		48.88	PK	H	34.72	6.84	26.68	47.68	74.00	Pass
15600.00		37.40	Ave	H	34.72	6.84	26.68	36.20	54.00	Pass
10400.00		47.68	PK	V	33.65	6.45	29.36	49.84	74.00	Pass
10400.00		37.63	Ave	V	33.65	6.45	29.36	39.79	54.00	Pass
15600.00		48.64	PK	V	34.72	6.84	26.68	47.44	74.00	Pass
15600.00		37.69	Ave	V	34.72	6.84	26.38	36.19	54.00	Pass
Upper Channel 5240MHz	10480.00	46.56	PK	H	33.89	6.82	30.55	50.04	74.00	Pass
	10480.00	36.81	Ave	H	33.89	6.82	30.55	40.29	54.00	Pass
	15720.00	48.87	PK	H	35.12	6.95	27.85	48.55	74.00	Pass
	15720.00	37.74	Ave	H	35.12	6.95	27.85	37.42	54.00	Pass
	10480.00	47.56	PK	V	33.89	6.82	30.55	51.04	74.00	Pass
	10480.00	35.75	Ave	V	33.89	6.82	30.55	39.23	54.00	Pass
	15720.00	48.92	PK	V	35.12	6.95	27.85	48.60	74.00	Pass
	15720.00	37.85	Ave	V	35.12	6.95	27.85	37.53	54.00	Pass

Remark:

Emission Level = Receiver Reading+ Antenna Factor + Cable Loss – Pre-amplifier.

Margin = Emission Level - Limit

Other harmonics emissions are lower than 20dB below the allowable limit.



802.11n20 band 4

	Freq.	Receiver Reading	Detector	Polar	Pre-amplifier	Cable Loss	Antenna Factor	Emission Level	Limit	Result
	(MHz)	(dBμV)	(PK/QP/Ave)	(H/V)	(dB)	(dB)	(dB)	(dBμV/m)	(dBμV/m)	
Lower Channel 5745MHz	11490.00	46.70	PK	H	34.26	6.45	29.23	48.12	74.00	Pass
	11490.00	37.20	Ave	H	33.26	6.45	29.23	39.62	54.00	Pass
	17235.00	48.41	PK	H	34.83	6.96	26.88	47.42	74.00	Pass
	17235.00	37.71	Ave	H	34.83	6.96	26.88	36.72	54.00	Pass
	11490.00	46.38	PK	V	34.25	6.48	29.46	48.07	74.00	Pass
	11490.00	36.08	Ave	V	33.25	6.48	29.46	38.77	54.00	Pass
	17235.00	48.65	PK	V	34.83	6.96	26.88	47.66	74.00	Pass
	17235.00	37.80	Ave	V	34.83	6.96	26.88	36.81	54.00	Pass
Middle Channel 5785MHz	11570.00	47.40	PK	H	33.95	6.89	29.36	49.70	74.00	Pass
	11570.00	36.64	Ave	H	33.95	6.89	29.36	38.94	54.00	Pass
	17355.00	48.01	PK	H	35.25	7.10	27.22	47.08	74.00	Pass
	17355.00	38.38	Ave	H	35.25	7.10	27.22	37.45	54.00	Pass
	11570.00	47.33	PK	V	33.95	6.89	29.36	49.63	74.00	Pass
	11570.00	37.19	Ave	V	33.95	6.89	29.36	39.49	54.00	Pass
	17355.00	48.93	PK	V	35.25	7.10	27.22	48.00	74.00	Pass
	17355.00	37.45	Ave	V	35.25	7.10	27.22	36.52	54.00	Pass
Upper Channel 5825MHz	11650.00	47.99	PK	H	34.35	7.15	30.15	50.94	74.00	Pass
	11650.00	36.57	Ave	H	34.35	7.15	30.15	39.52	54.00	Pass
	17475.00	49.06	PK	H	35.75	7.45	28.54	49.30	74.00	Pass
	17475.00	37.85	Ave	H	35.75	7.45	28.54	38.09	54.00	Pass
	11650.00	48.29	PK	V	34.35	7.15	30.15	51.24	74.00	Pass
	11650.00	36.76	Ave	V	34.35	7.15	30.15	39.71	54.00	Pass
	17475.00	49.16	PK	V	35.75	7.45	28.54	49.40	74.00	Pass
	17475.00	38.18	Ave	V	35.75	7.45	28.54	38.42	54.00	Pass

Remark:

Emission Level = Receiver Reading + Antenna Factor + Cable Loss – Pre-amplifier.

Margin = Emission Level - Limit

Other harmonics emissions are lower than 20dB below the allowable limit.



18G~40GHz

802.11a band 1

	Freq.	Receiver Reading	Detector	Polar	Pre-amplifier	Cable Loss	Antenna Factor	Emission Level	Limit	Result
	(MHz)	(dBμV)	(PK/QP/Ave)	(H/V)	(dB)	(dB)	(dB)	(dBμV/m)	(dBμV/m)	
Lower Channel 5180MHz	20720.00	45.74	PK	H	36.36	10.20	27.10	46.68	74.00	Pass
	25900.00	46.27	PK	H	36.50	10.55	27.50	47.82	74.00	Pass
	31080.00	49.43	PK	H	37.65	11.15	28.75	51.68	74.00	Pass
	20720.00	48.34	PK	V	36.36	10.20	27.10	49.28	74.00	Pass
	25900.00	46.66	PK	V	36.50	10.55	27.50	48.21	74.00	Pass
	31080.00	47.23	PK	V	37.65	11.15	28.75	49.48	74.00	Pass
	Middle Channel 5200MHz	20800.00	48.59	PK	H	36.36	10.20	27.10	49.53	74.00
26000.00		46.45	PK	H	36.50	10.55	27.50	48.00	74.00	Pass
31200.00		47.04	PK	H	37.65	11.15	28.75	49.29	74.00	Pass
20800.00		48.28	PK	V	36.36	10.20	27.10	49.22	74.00	Pass
26000.00		47.57	PK	V	36.50	10.55	27.50	49.12	74.00	Pass
31200.00		46.51	PK	V	37.65	11.15	28.75	48.76	74.00	Pass
Upper Channel 5240MHz	20960.00	48.52	PK	H	36.37	10.22	27.12	49.49	74.00	Pass
	26200.00	49.43	PK	H	36.57	10.57	27.51	50.94	74.00	Pass
	31440.00	47.48	PK	H	37.66	11.16	28.76	49.74	74.00	Pass
	20960.00	48.27	PK	V	36.37	10.22	27.12	49.24	74.00	Pass
	26200.00	49.76	PK	V	36.57	10.57	27.51	51.27	74.00	Pass
	31440.00	48.37	PK	V	37.66	11.16	28.76	50.63	74.00	Pass

Remark:

Emission Level = Receiver Reading + Antenna Factor + Cable Loss – Pre-amplifier.

Margin = Emission Level - Limit

Other harmonics emissions are lower than 20dB below the allowable limit.

If the PK measured levels comply with average limit, then the average level were deemed to comply with average limit.



802.11a band 4

	Freq.	Receiver Reading	Detector	Polar	Pre-amplifier	Cable Loss	Antenna Factor	Emission Level	Limit	Result
	(MHz)	(dBμV)	(PK/QP/Ave)	(H/V)	(dB)	(dB)	(dB)	(dBμV/m)	(dBμV/m)	
Lower Channel 5745MHz	22980.00	50.89	PK	H	37.15	10.55	28.12	52.41	74.00	Pass
	28725.00	50.05	PK	H	37.15	10.82	28.42	52.14	74.00	Pass
	34470.00	49.11	PK	H	37.68	11.18	28.78	51.39	74.00	Pass
	22980.00	50.88	PK	V	37.15	10.55	28.12	52.40	74.00	Pass
	28725.00	49.99	PK	V	37.15	10.82	28.42	52.08	74.00	Pass
	34470.00	49.77	PK	V	37.68	11.18	28.78	52.05	74.00	Pass
	Middle Channel 5785MHz	23140.00	50.95	PK	H	37.15	10.55	28.12	52.47	74.00
28925.00		47.99	PK	H	37.15	10.82	28.42	50.08	74.00	Pass
34710.00		50.75	PK	H	37.68	11.18	28.78	53.03	74.00	Pass
23140.00		47.88	PK	V	37.15	10.55	28.12	49.40	74.00	Pass
28925.00		49.94	PK	V	37.15	10.82	28.42	52.03	74.00	Pass
34710.00		48.90	PK	V	37.68	11.18	28.78	51.18	74.00	Pass
Upper Channel 5825MHz	23300.00	49.46	PK	H	37.15	10.55	28.12	50.98	74.00	Pass
	29125.00	48.30	PK	H	37.15	10.82	28.42	50.39	74.00	Pass
	34950.00	47.41	PK	H	37.68	11.18	28.78	49.69	74.00	Pass
	23300.00	49.02	PK	V	37.15	10.55	28.12	50.54	74.00	Pass
	29125.00	47.68	PK	V	37.15	10.82	28.42	49.77	74.00	Pass
	34950.00	49.89	PK	V	37.68	11.18	28.78	52.17	74.00	Pass

Remark:

Emission Level = Receiver Reading + Antenna Factor + Cable Loss – Pre-amplifier.

Margin = Emission Level - Limit

Other harmonics emissions are lower than 20dB below the allowable limit.

If the PK measured levels comply with average limit, then the average level were deemed to comply with average limit.



802.11n20 band 1

	Freq.	Receiver Reading	Detector	Polar	Pre-amplifier	Cable Loss	Antenna Factor	Emission Level	Limit	Result
	(MHz)	(dBμV)	(PK/QP/Ave)	(H/V)	(dB)	(dB)	(dB)	(dBμV/m)	(dBμV/m)	
Lower Channel 5180MHz	20720.00	47.73	PK	H	36.36	10.20	27.10	48.67	74.00	Pass
	25900.00	48.80	PK	H	36.50	10.55	27.50	50.35	74.00	Pass
	31080.00	47.56	PK	H	37.65	11.15	28.75	49.81	74.00	Pass
	20720.00	49.53	PK	V	36.36	10.20	27.10	50.47	74.00	Pass
	25900.00	48.71	PK	V	36.50	10.55	27.50	50.26	74.00	Pass
	31080.00	48.79	PK	V	37.65	11.15	28.75	51.04	74.00	Pass
	Middle Channel 5200MHz	20800.00	47.14	PK	H	36.36	10.20	27.10	48.08	74.00
26000.00		48.43	PK	H	36.50	10.55	27.50	49.98	74.00	Pass
31200.00		49.62	PK	H	37.65	11.15	28.75	51.87	74.00	Pass
20800.00		47.25	PK	V	36.36	10.20	27.10	48.19	74.00	Pass
26000.00		48.43	PK	V	36.50	10.55	27.50	49.98	74.00	Pass
31200.00		48.15	PK	V	37.65	11.15	28.75	50.40	74.00	Pass
Upper Channel 5240MHz	20960.00	47.43	PK	H	36.37	10.22	27.12	48.40	74.00	Pass
	26200.00	49.57	PK	H	36.57	10.57	27.51	51.08	74.00	Pass
	31440.00	48.52	PK	H	37.66	11.16	28.76	50.78	74.00	Pass
	20960.00	49.12	PK	V	36.37	10.22	27.12	50.09	74.00	Pass
	26200.00	48.56	PK	V	36.57	10.57	27.51	50.07	74.00	Pass
	31440.00	47.61	PK	V	37.66	11.16	28.76	49.87	74.00	Pass

Remark:

Emission Level = Receiver Reading + Antenna Factor + Cable Loss – Pre-amplifier.

Margin = Emission Level - Limit

Other harmonics emissions are lower than 20dB below the allowable limit.

If the PK measured levels comply with average limit, then the average level were deemed to comply with average limit.



802.11n20 band 4

	Freq.	Receiver Reading	Detector	Polar	Pre-amplifier	Cable Loss	Antenna Factor	Emission Level	Limit	Result
	(MHz)	(dBμV)	(PK/QP/Ave)	(H/V)	(dB)	(dB)	(dB)	(dBμV/m)	(dBμV/m)	
Lower Channel 5745MHz	22980.00	41.97	PK	H	37.15	10.55	28.12	43.49	74.00	Pass
	28725.00	41.62	PK	H	37.15	10.82	28.42	43.71	74.00	Pass
	34470.00	41.99	PK	H	37.68	11.18	28.78	44.27	74.00	Pass
	22980.00	42.95	PK	V	37.15	10.55	28.12	44.47	74.00	Pass
	28725.00	42.84	PK	V	37.15	10.82	28.42	44.93	74.00	Pass
	34470.00	42.09	PK	V	37.68	11.18	28.78	44.37	74.00	Pass
	Middle Channel 5785MHz	23140.00	42.72	PK	H	37.15	10.55	28.12	44.24	74.00
28925.00		43.07	PK	H	37.15	10.82	28.42	45.16	74.00	Pass
34710.00		42.53	PK	H	37.68	11.18	28.78	44.81	74.00	Pass
23140.00		42.61	PK	V	37.15	10.55	28.12	44.13	74.00	Pass
28925.00		42.52	PK	V	37.15	10.82	28.42	44.61	74.00	Pass
34710.00		42.40	PK	V	37.68	11.18	28.78	44.68	74.00	Pass
Upper Channel 5825MHz	23300.00	43.07	PK	H	37.15	10.55	28.12	44.59	74.00	Pass
	29125.00	43.01	PK	H	37.15	10.82	28.42	45.10	74.00	Pass
	34950.00	42.06	PK	H	37.68	11.18	28.78	44.34	74.00	Pass
	23300.00	43.47	PK	V	37.15	10.55	28.12	44.99	74.00	Pass
	29125.00	42.80	PK	V	37.15	10.82	28.42	44.89	74.00	Pass
	34950.00	42.75	PK	V	37.68	11.18	28.78	45.03	74.00	Pass

Remark:

Emission Level = Receiver Reading + Antenna Factor + Cable Loss – Pre-amplifier.

Margin = Emission Level - Limit

Other harmonics emissions are lower than 20dB below the allowable limit.

If the PK measured levels comply with average limit, then the average level were deemed to comply with average limit.



802.11a band 1 5180MHz Horizontal

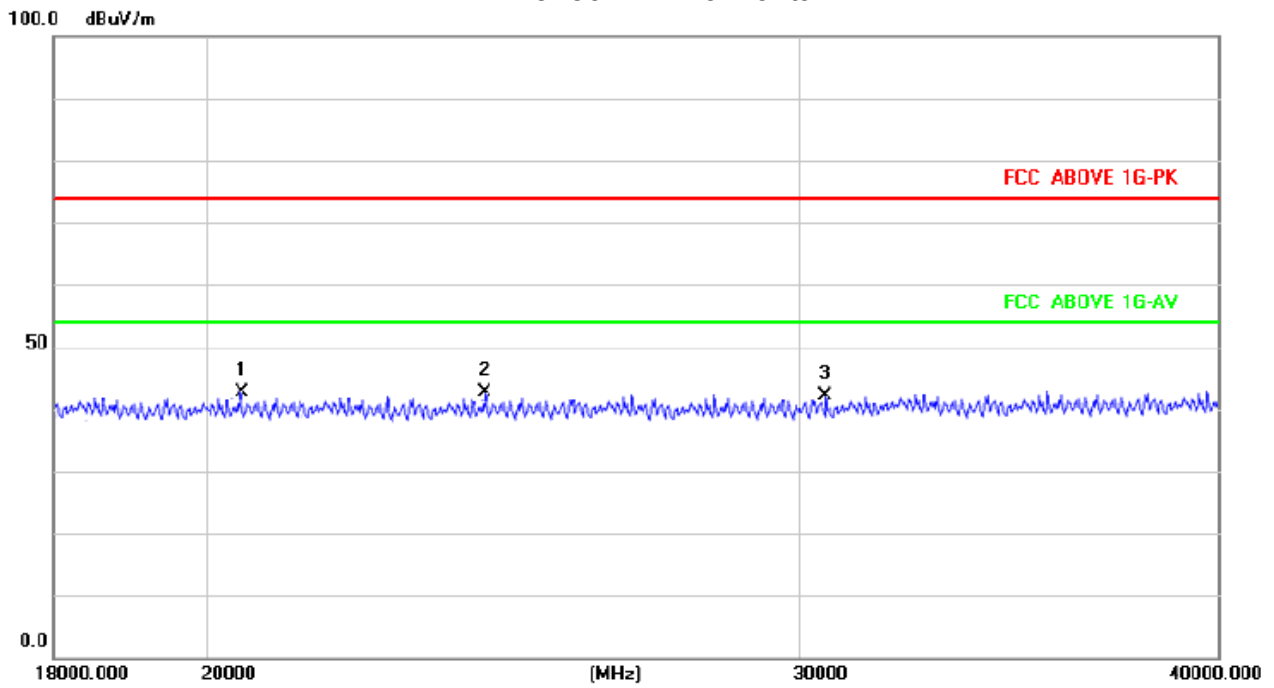

5180MHz Vertical

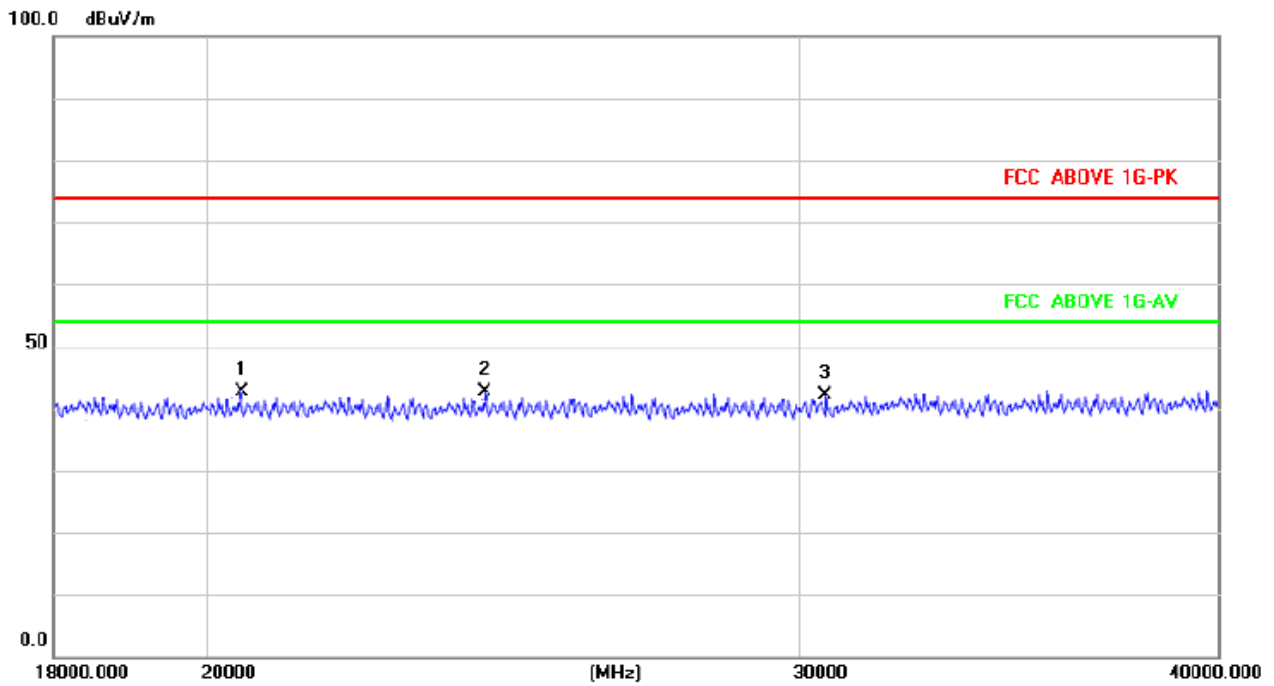



5200MHz Horizontal

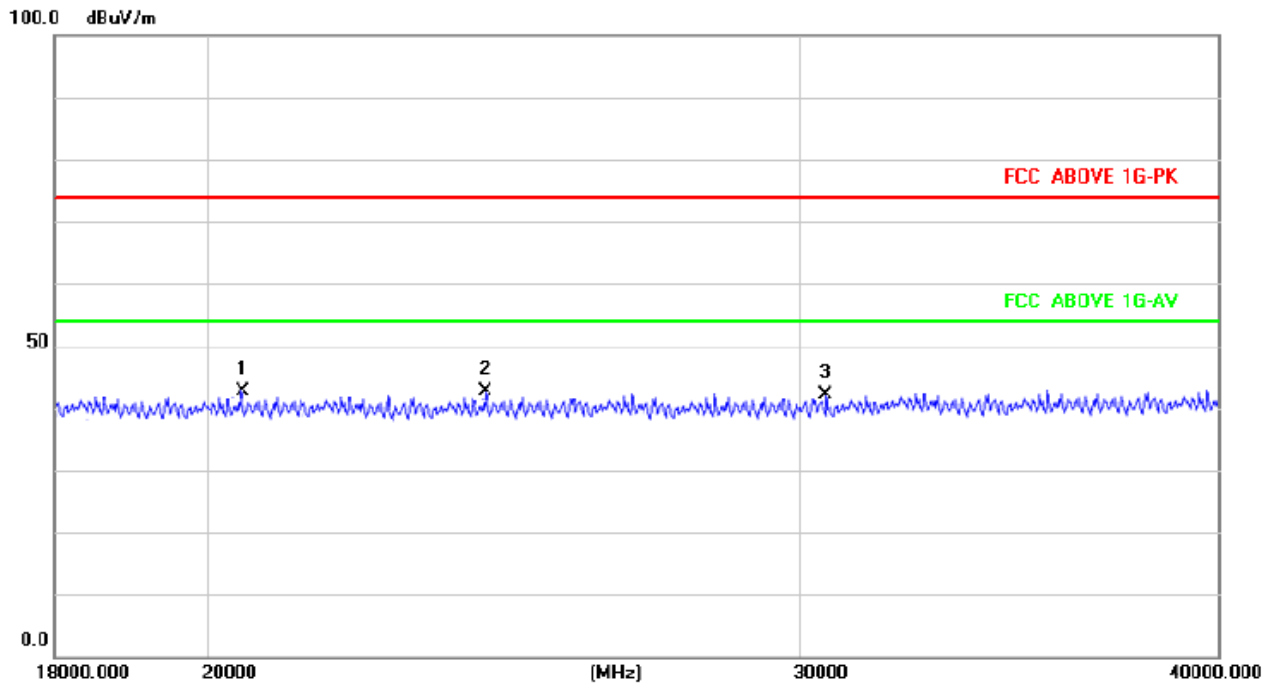

5200MHz Vertical

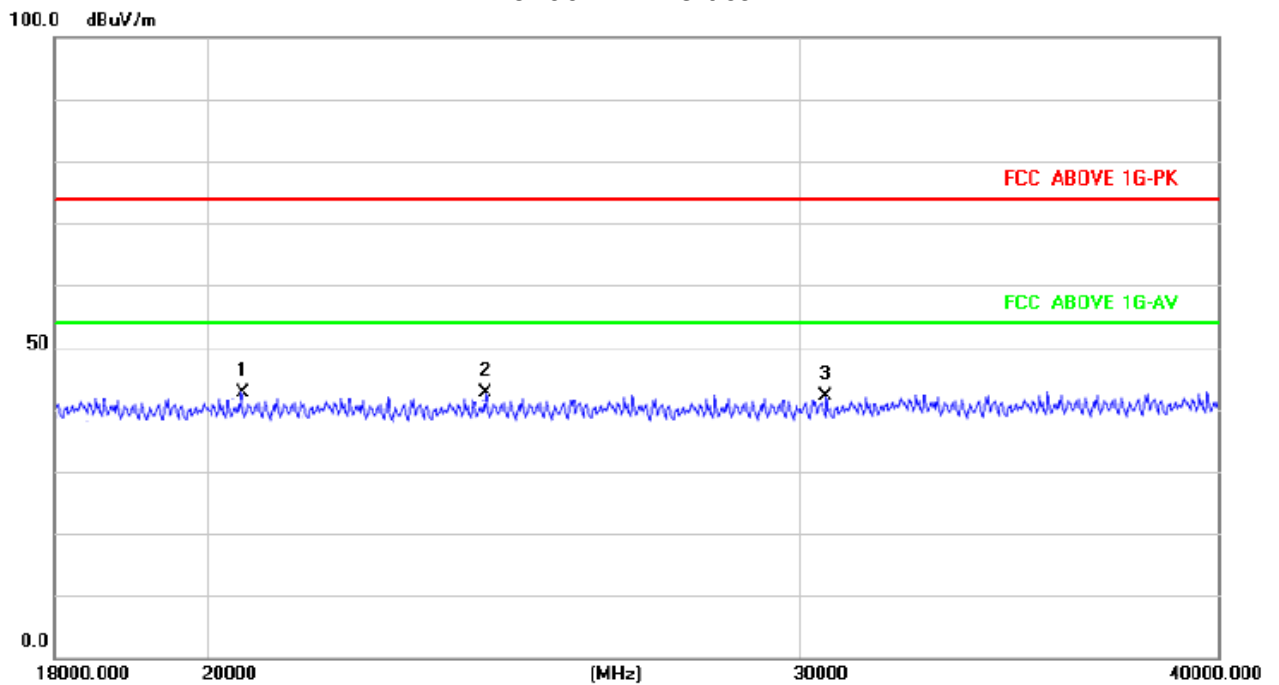



5240MHz Horizontal

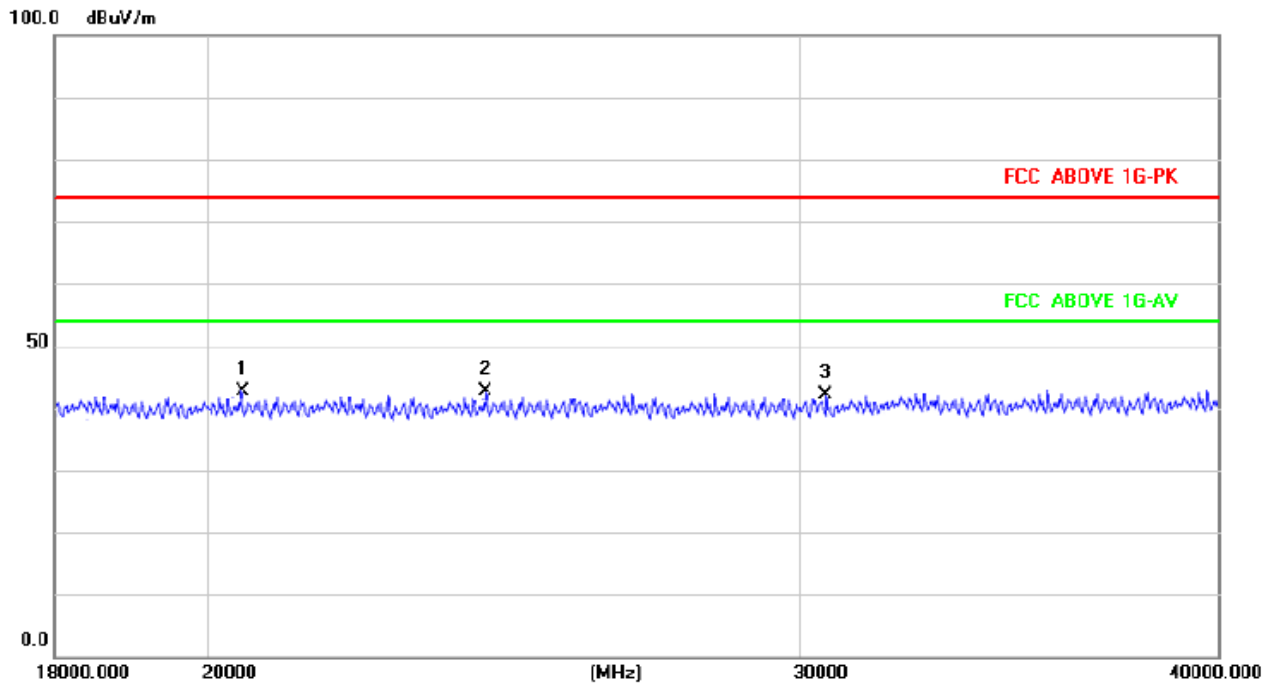

5240MHz Vertical

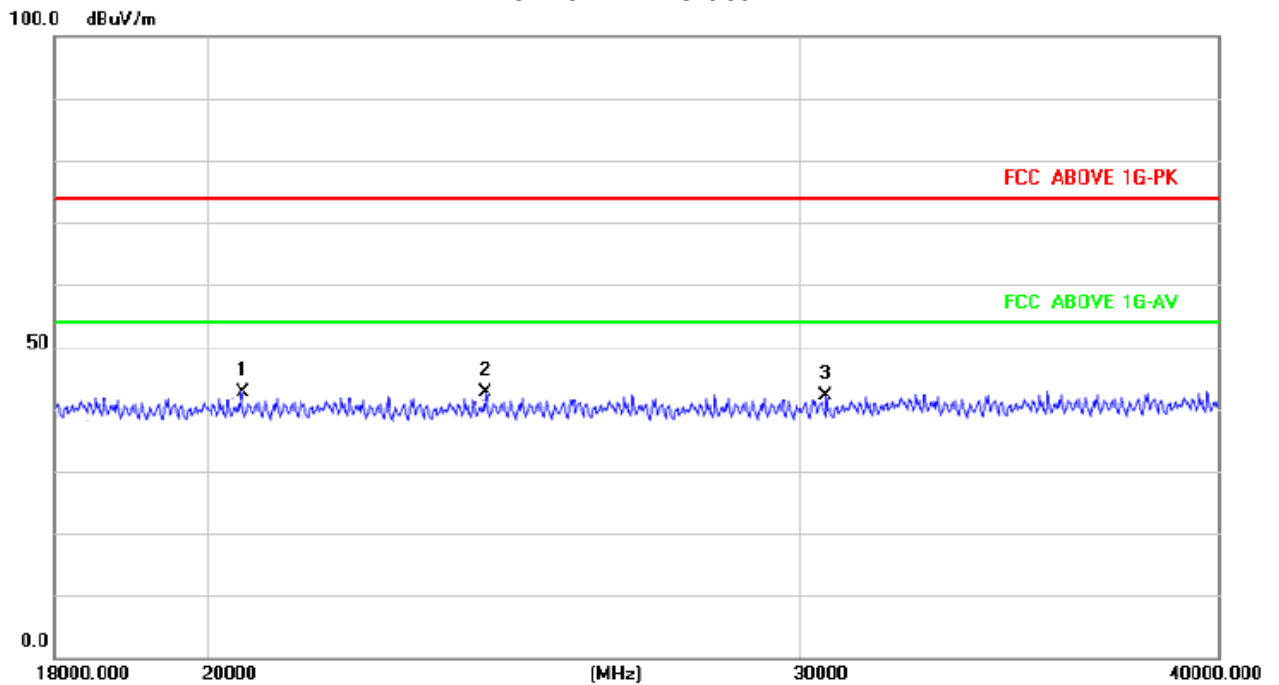



802.11n20 band 4 5745MHz Horizontal

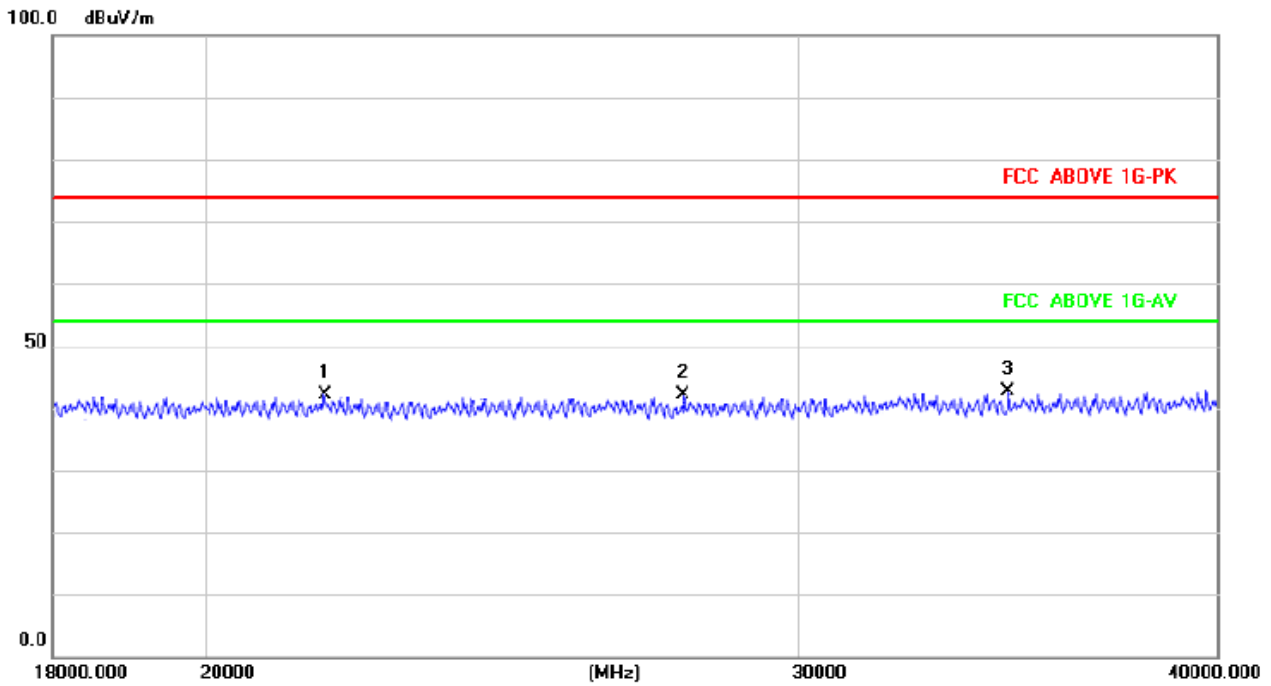

5745MHz Vertical

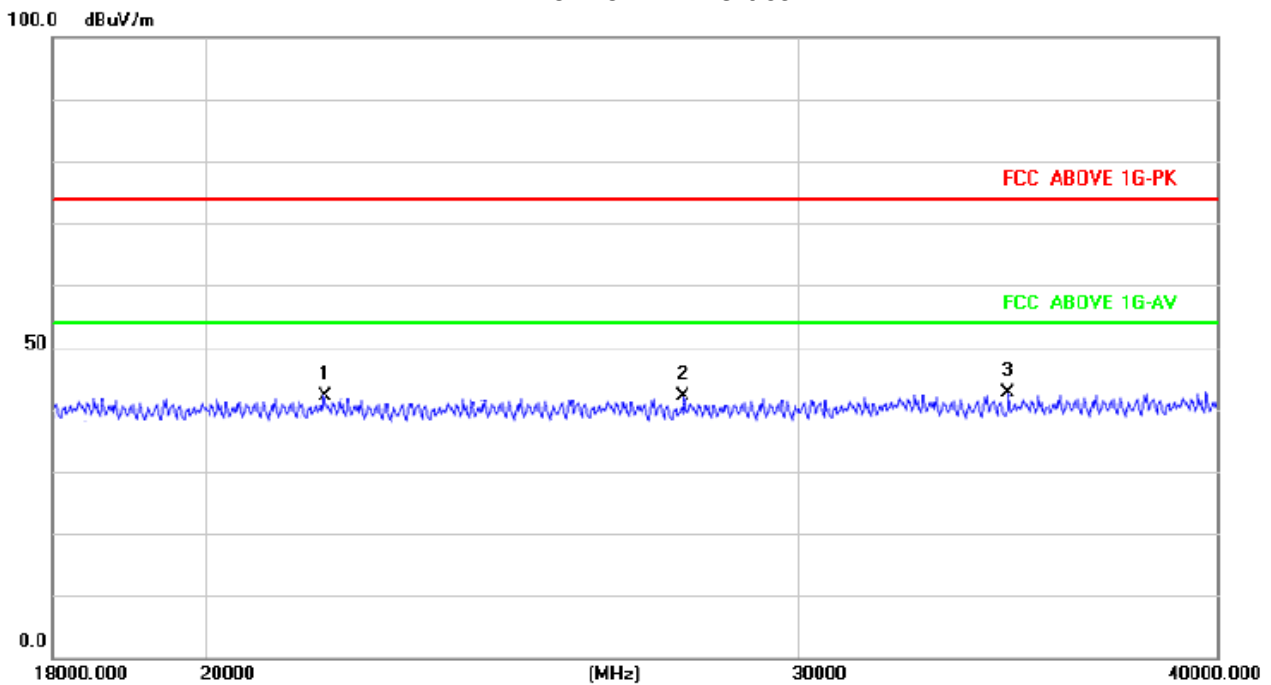



5785MHz Horizontal

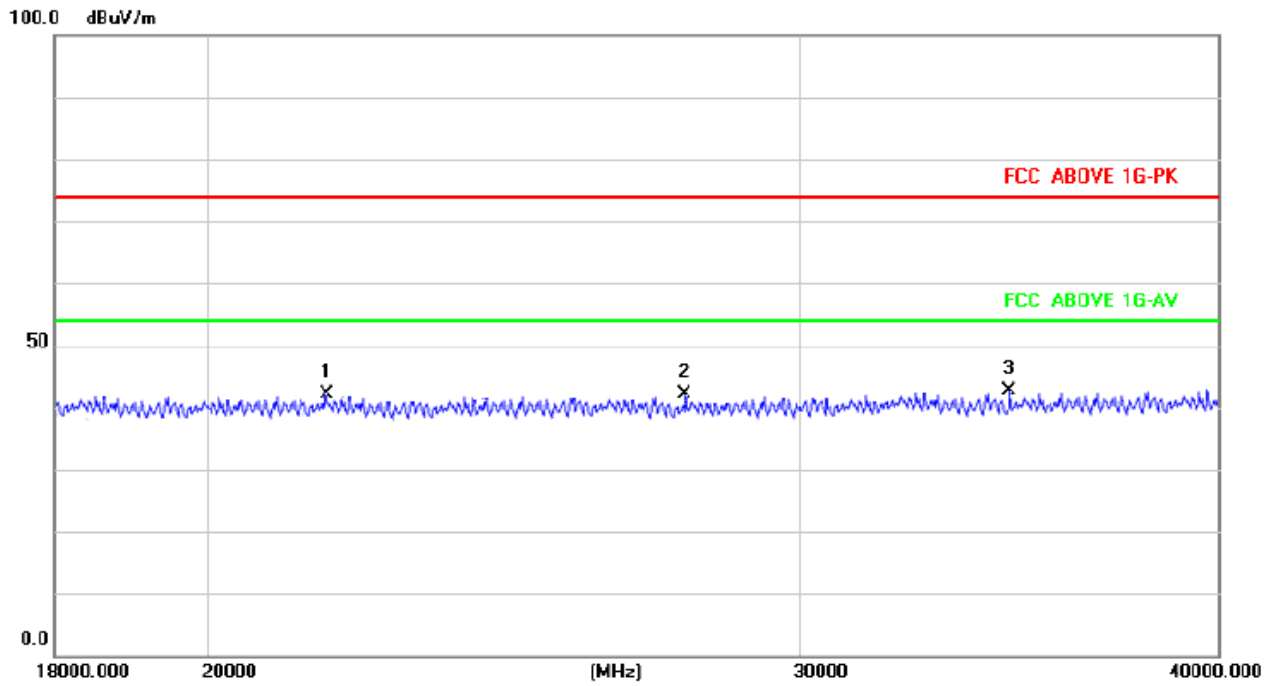

5785MHz Vertical

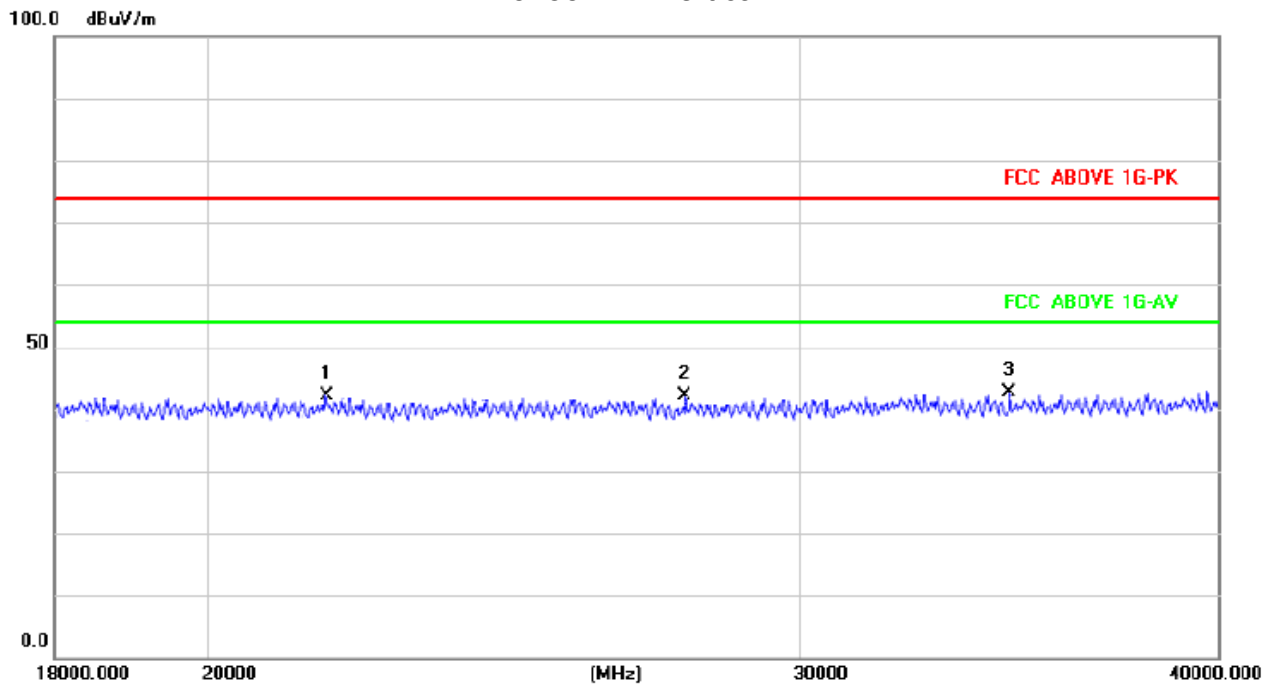



5825MHz Horizontal

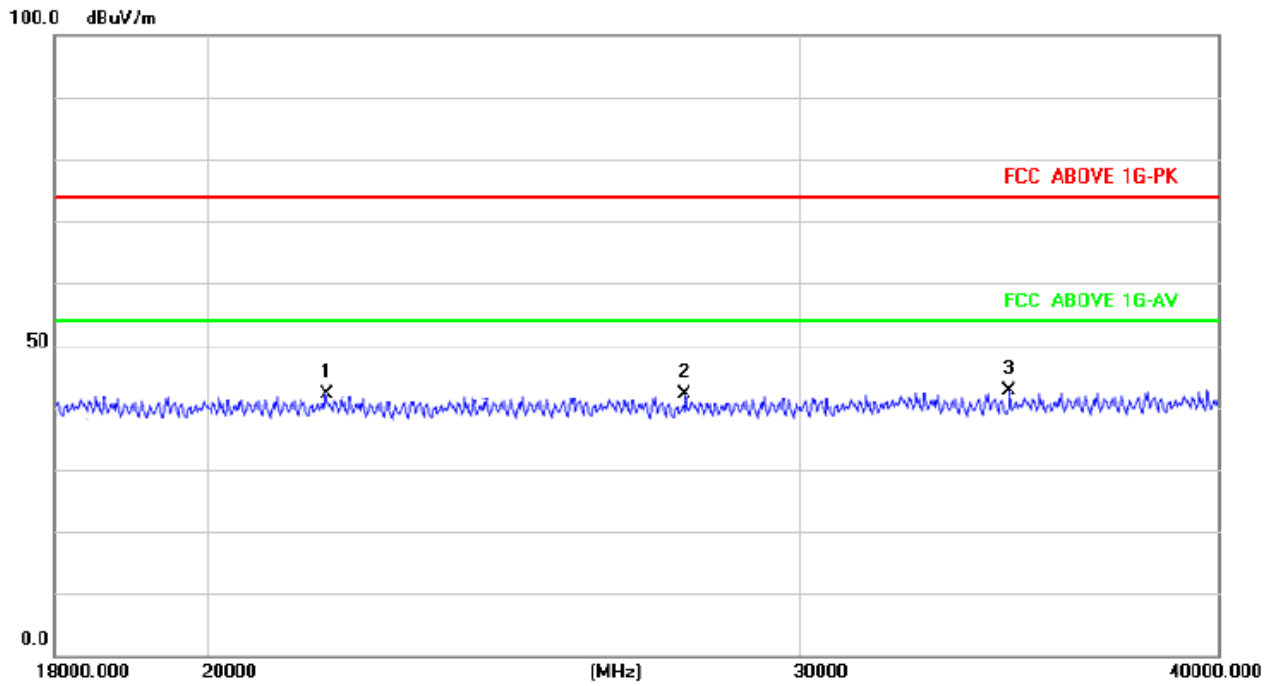

5825MHz Vertical

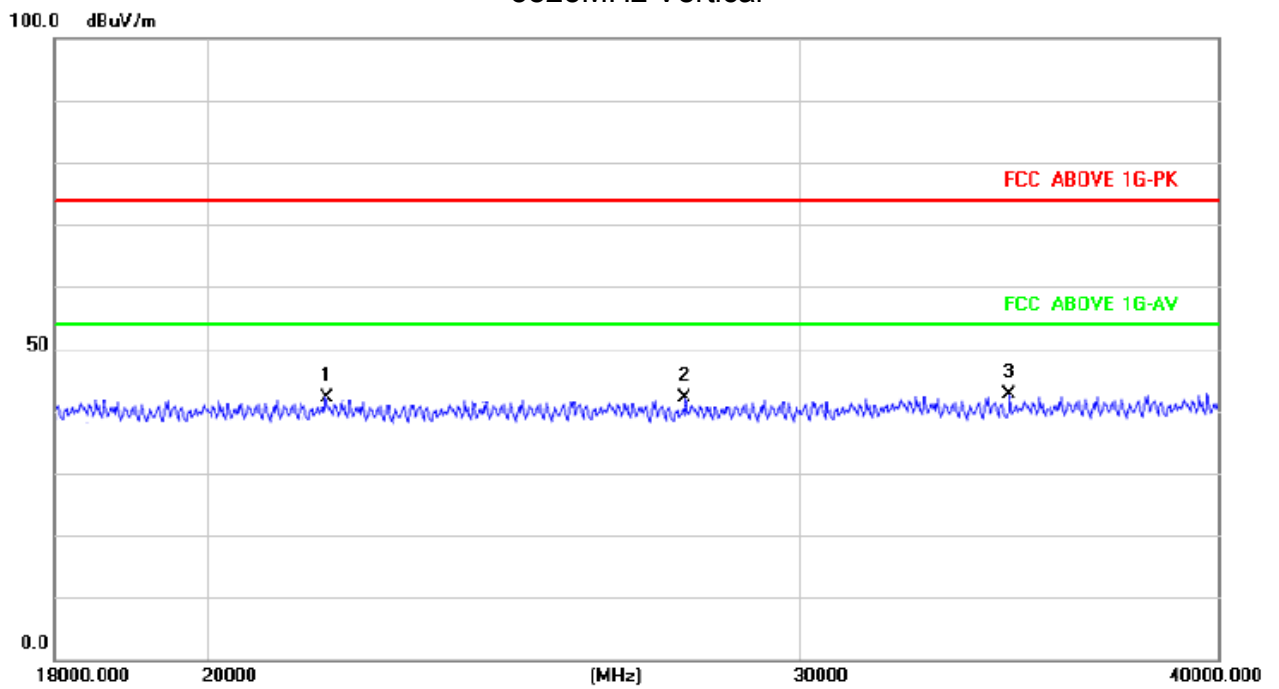

NOTE: We pretest All the modulation modes, the worst data recording in the report.



5. BAND EDGE COMPLIANCE TEST

5.1. Limits

(1) For transmitters operating in the 5.15-5.25 GHz band: All emissions outside of the 5.15-5.35 GHz band shall not exceed an e.i.r.p. of -27 dBm/MHz.

(4) For transmitters operating in the 5.725-5.85 GHz band: All emissions shall be limited to a level of -27 dBm/MHz at 75 MHz or more above or below the band edge increasing linearly to 10 dBm/MHz at 25 MHz above or below the band edge, and from 25 MHz above or below the band edge increasing linearly to a level of 15.6 dBm/MHz at 5 MHz above or below the band edge, and from 5 MHz above or below the band edge increasing linearly to a level of 27 dBm/MHz at the band edge.

5.2. TEST PROCEDURE

1. Check the calibration of the measuring instrument using either an internal calibrator or a known signal from an external generator.
2. Position the EUT without connection to measurement instrument. Turn on the EUT and connect its antenna terminal to measurement instrument via a low loss cable. Then set it to any one measured frequency within its operating range, and make sure the instrument is operated in its linear range.
3. Set RBW of spectrum analyzer to 1 MHz with a convenient frequency span.
4. Measure the highest amplitude appearing on spectral display and set it as a reference level. Plot the graph with marking the highest point and edge frequency.
5. Repeat above procedures until all measured frequencies were complete.

5.3. Test Data

Please see data as below:



Ant1 Band 1
802.11a

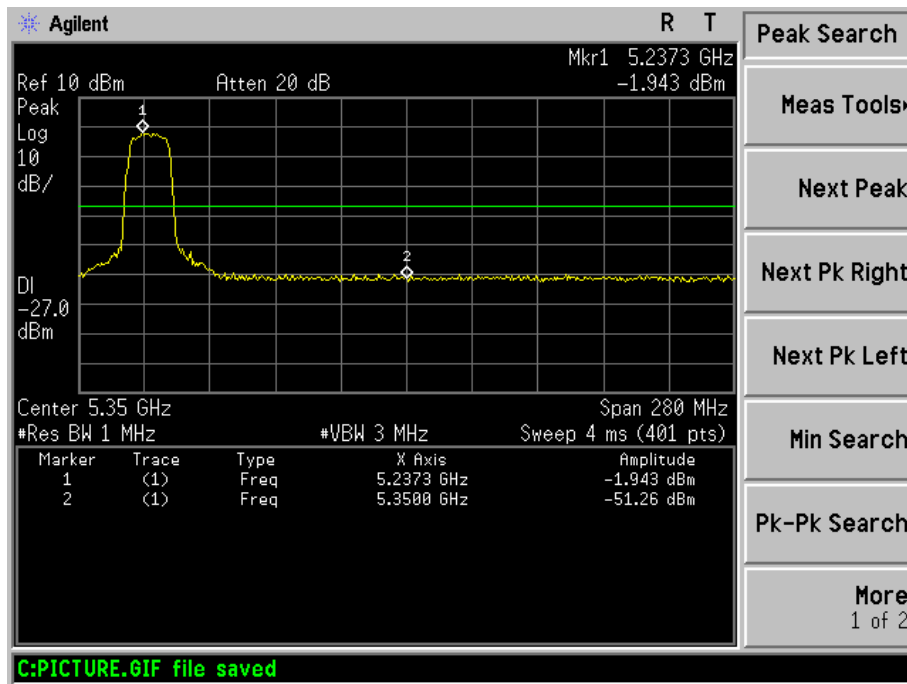
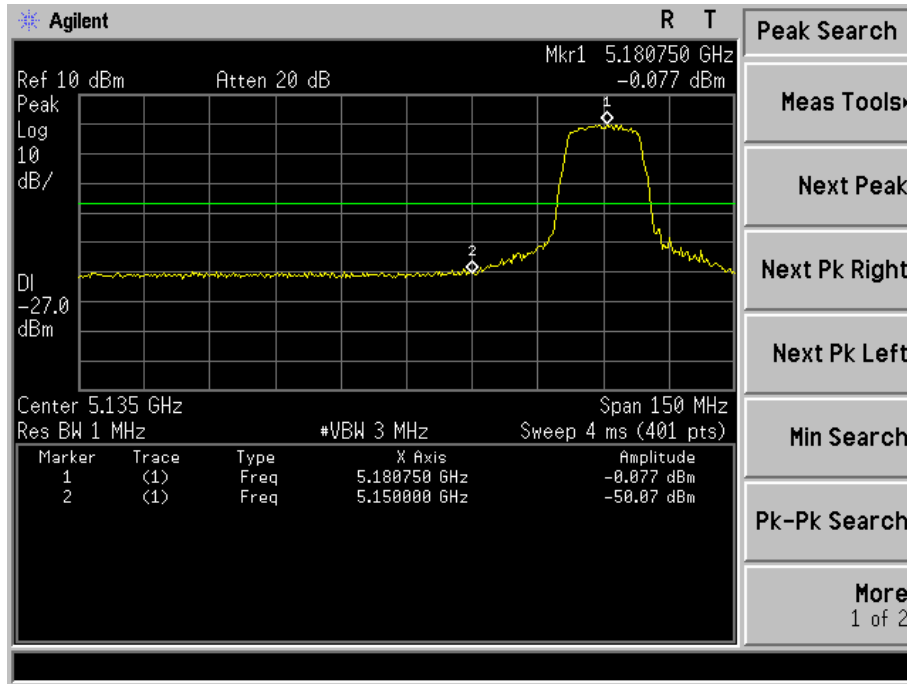



802.11n20

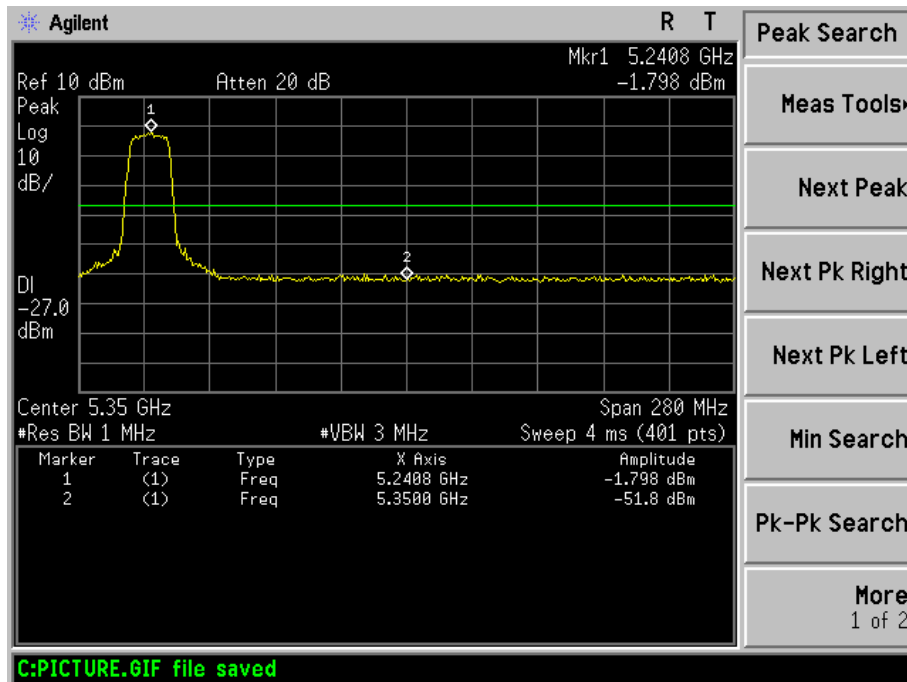
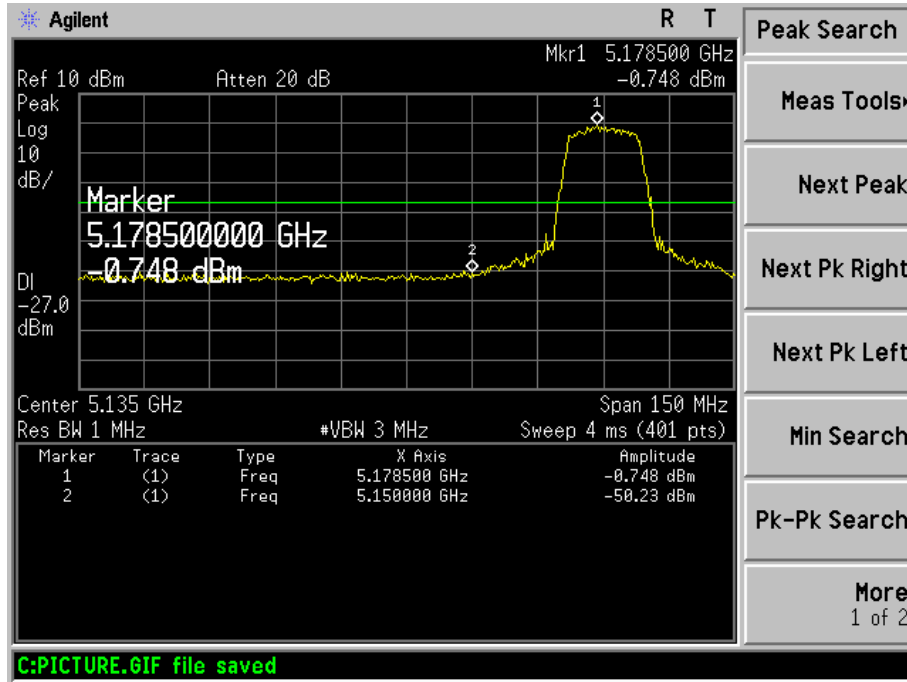



Ant1 Band 4
802.11a

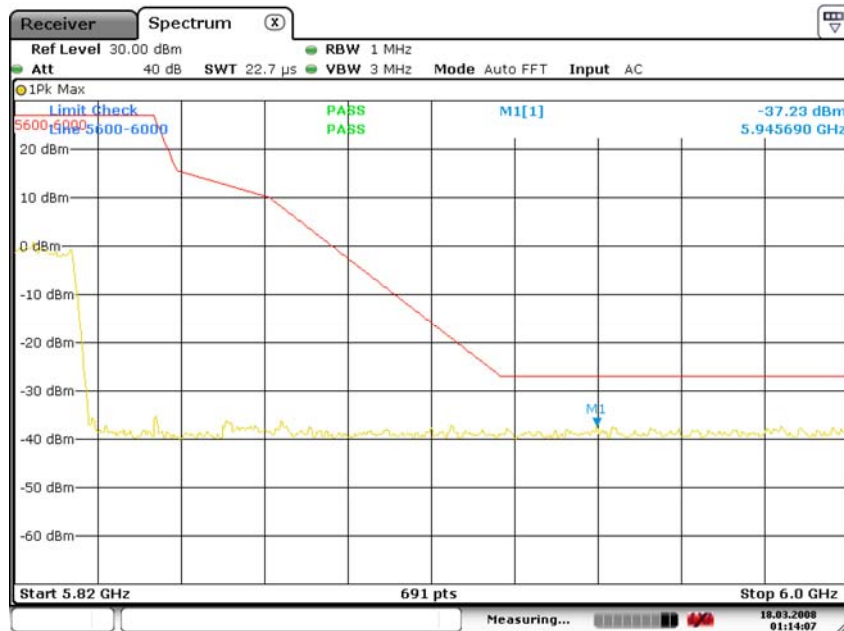
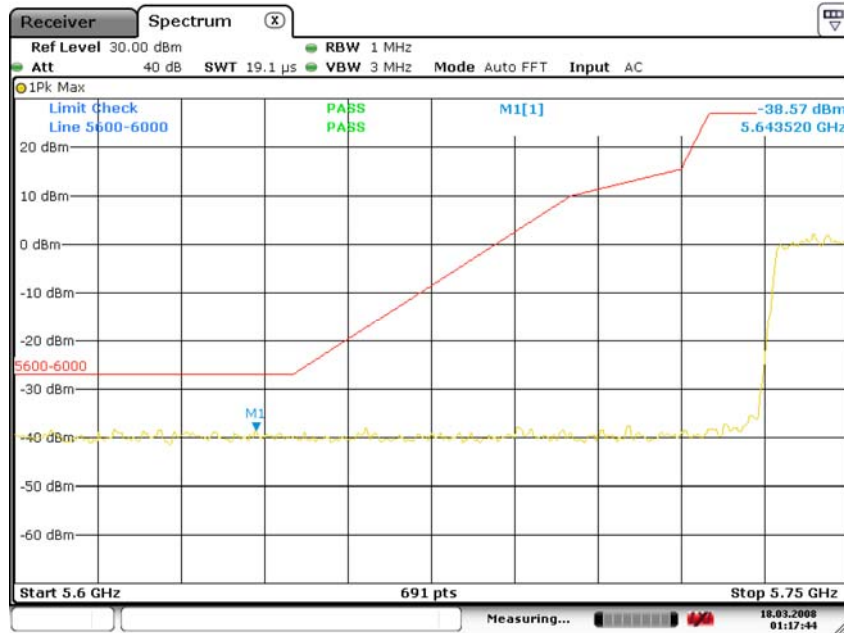



802.11n20

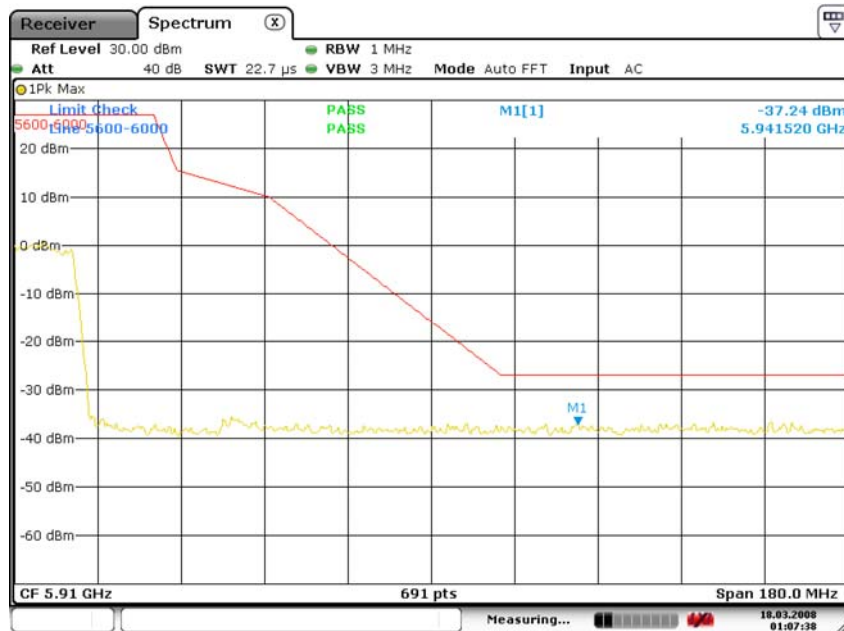
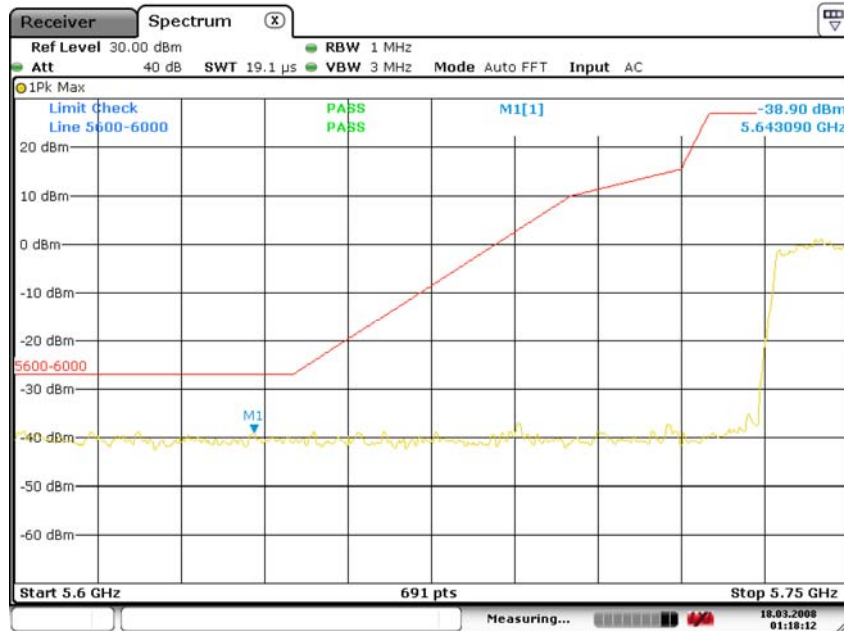



Ant2 Band 1
802.11a

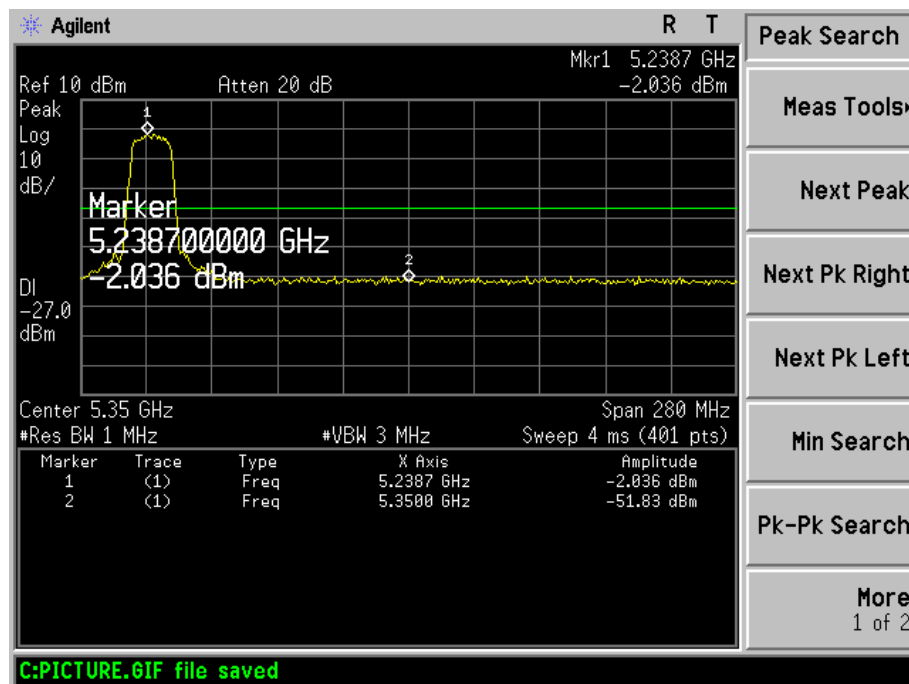
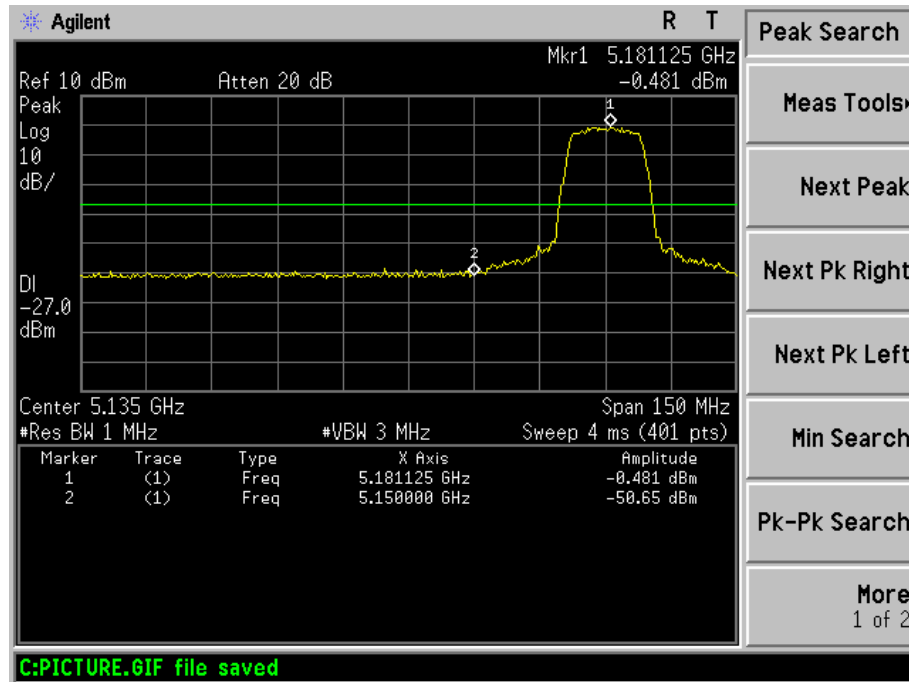



802.11n20

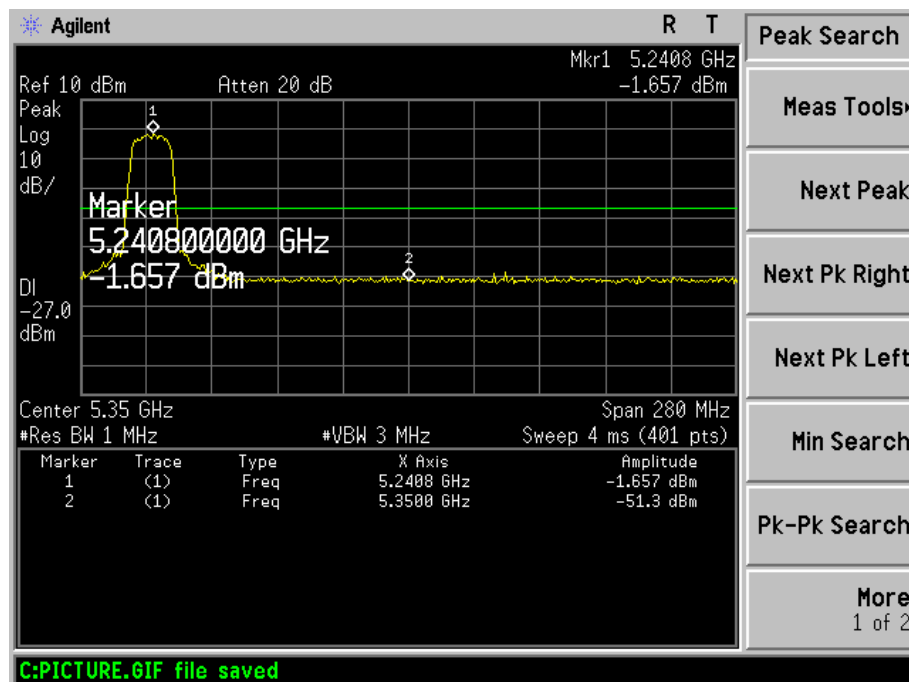
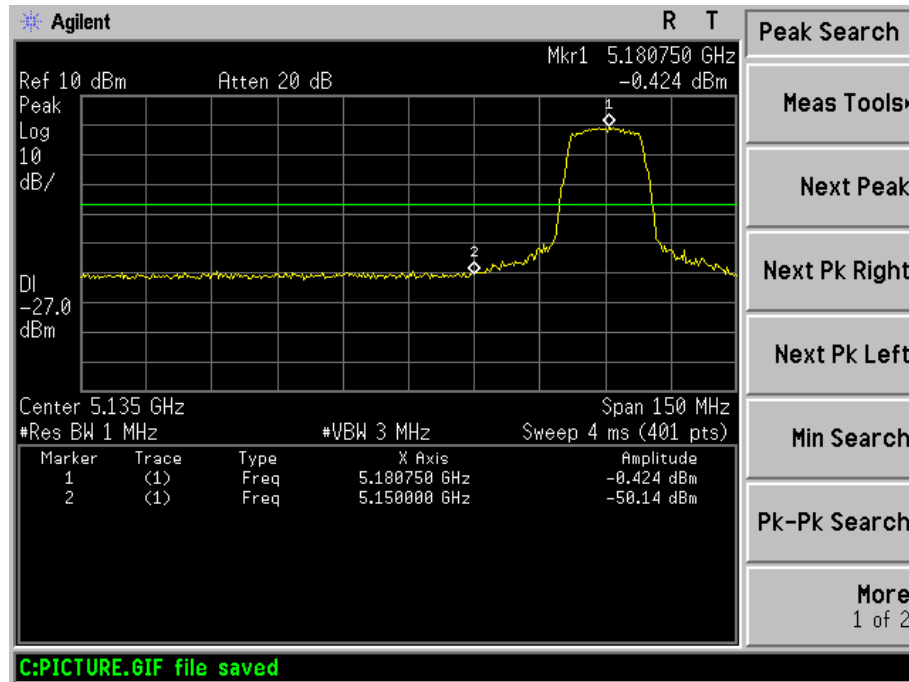



Ant2 Band 4
802.11a

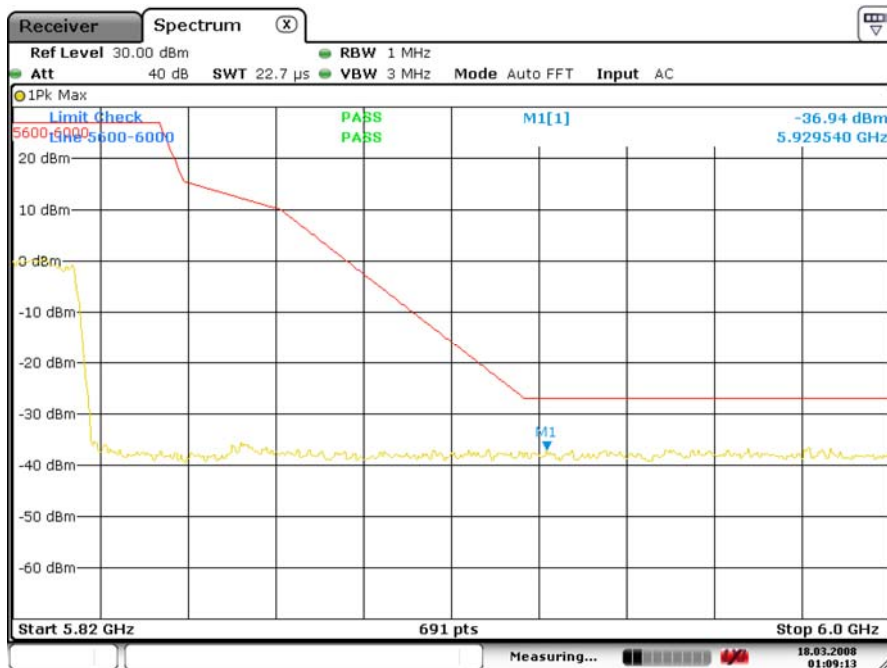
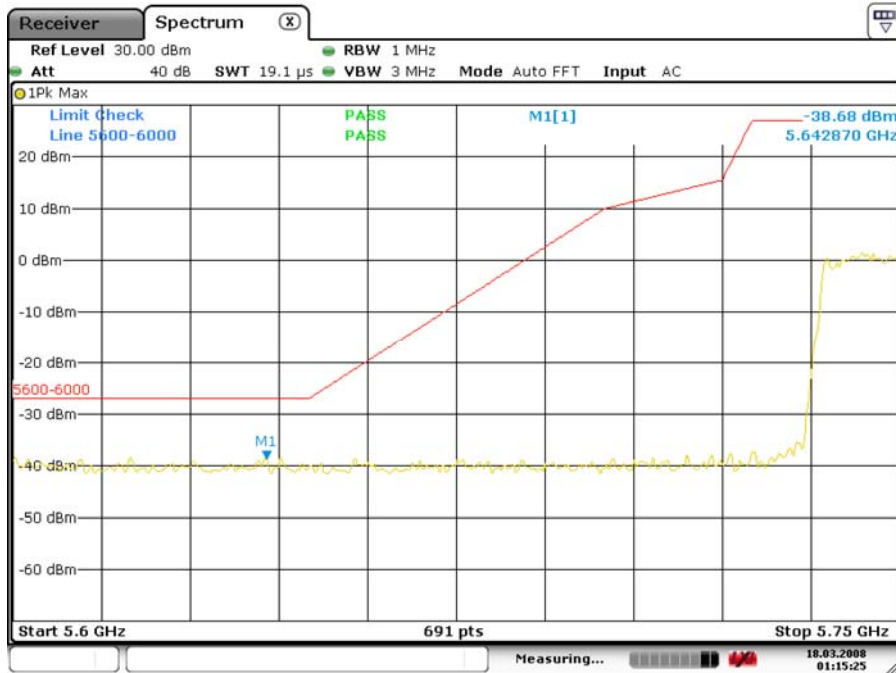



802.11n20

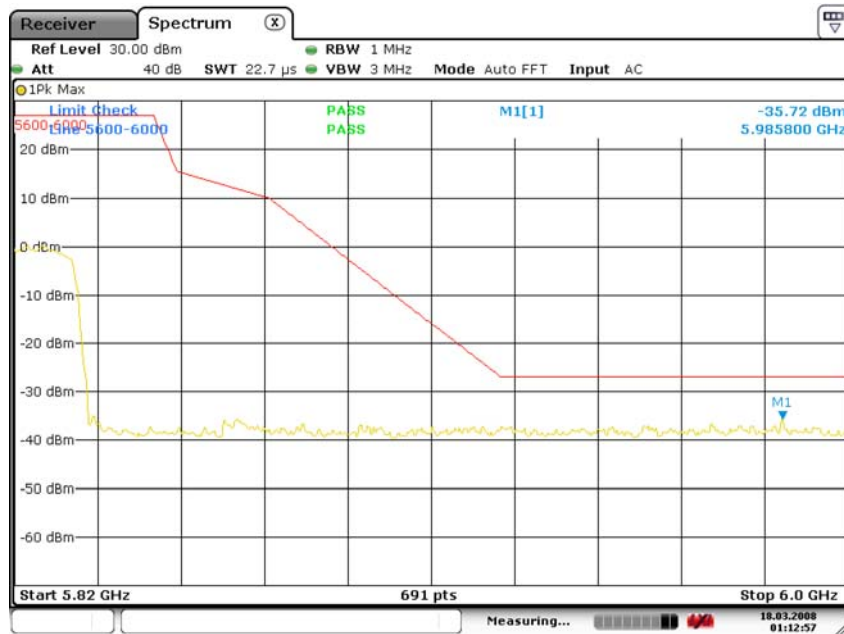
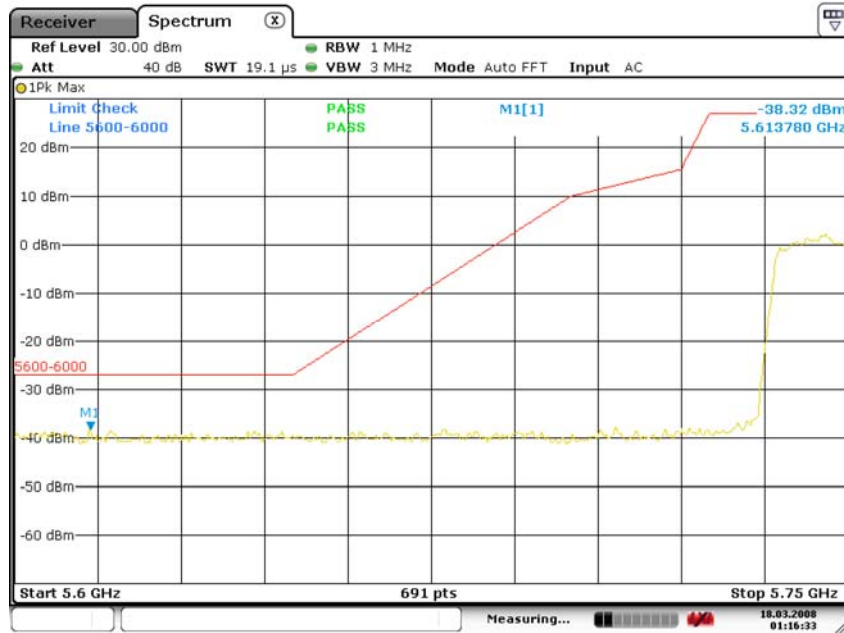



6. 26DB AND 99% BANDWIDTH TEST

6.1. Measurement Procedure

The bandwidth at 26 dB down from the highest in-band spectral density is measured with a spectrum analyzer connected to the antenna terminal while the EUT is operating at its maximum power control level, as defined in KDB 789033, at the appropriate frequencies. The spectrum analyzer's bandwidth measurement function is configured to measure the 26 dB bandwidth.

The 26 dB bandwidth is used to determine the conducted power limits.

There is no limit bandwidth for U-NII-1, U-NII-2-A and U-NII-2-C.

The minimum of 6dB Bandwidth measurement is 0.5 MHz for U-NII-3



26dB bandwidth

	Frequency (MHz)	26dB Bandwidth (MHz)		99% Bandwidth (MHz)	
		Ant 1	Ant 2	Ant 1	Ant 2
802.11a	5180	19.661	19.381	16.5081	16.5023
	5200	19.567	19.697	16.5181	16.4835
	5240	19.501	19.255	16.5366	16.4268
802.11n (HT20)	5180	19.905	20.042	17.4935	17.5111
	5200	19.861	20.128	17.4935	17.5343
	5240	19.847	19.771	17.5085	17.4889



Antenna1-802.11a 5180MHz

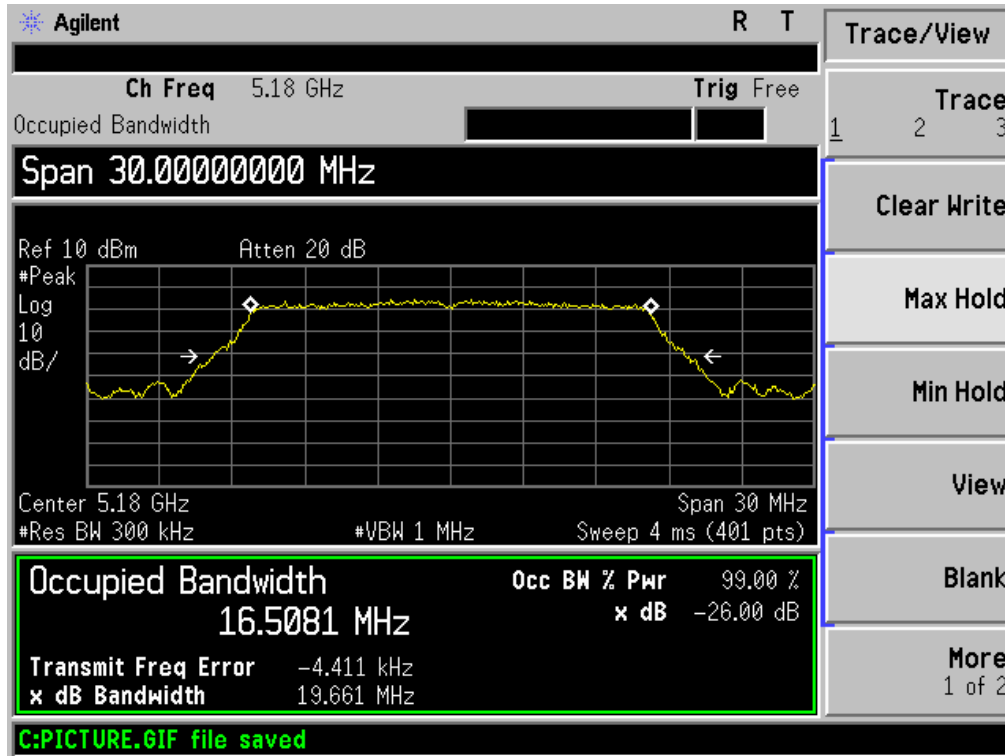

Antenna1-802.11a 5200MHz

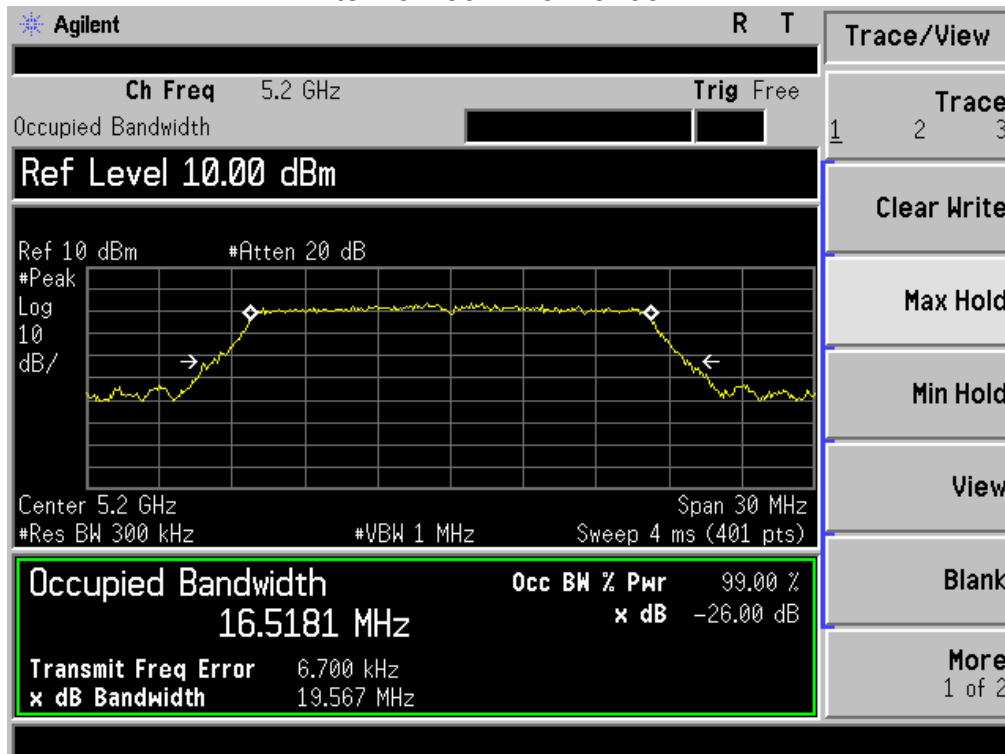



Antenna1-802.11a 5240MHz

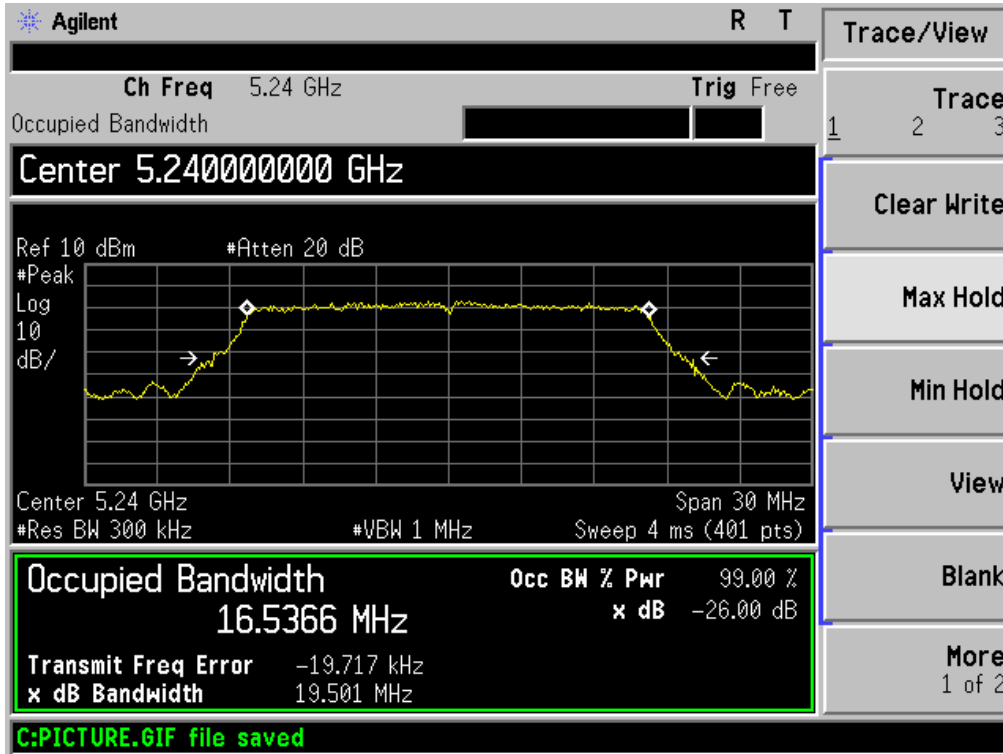

Antenna1-802.11n(HT20) 5180MHz

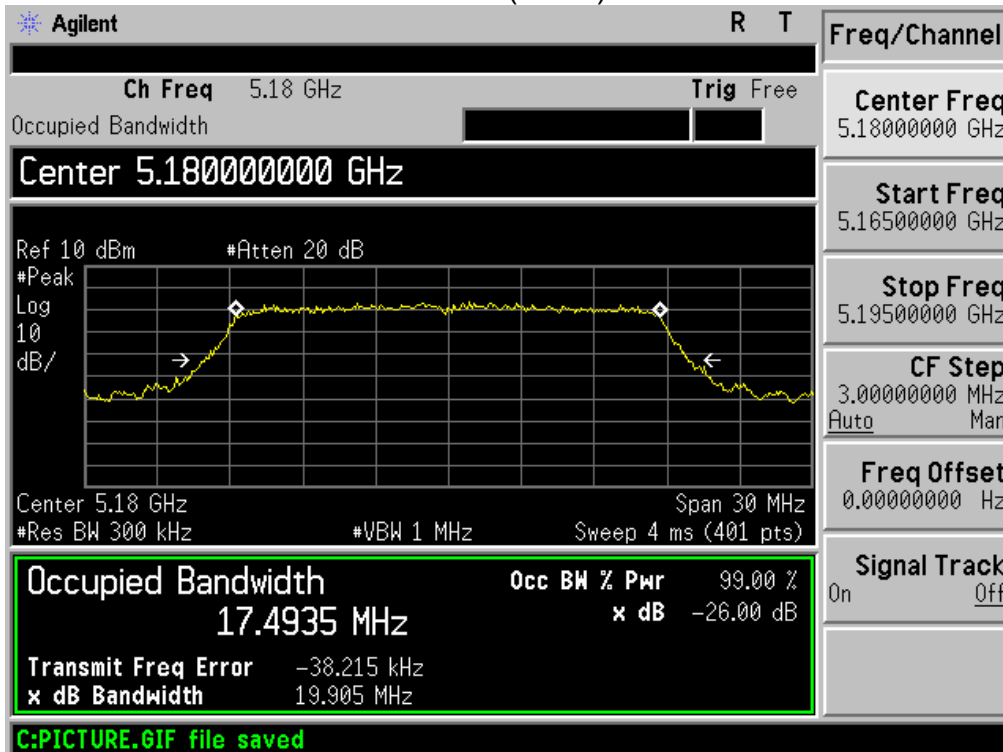



Antenna1-802.11n(HT20) 5200MHz

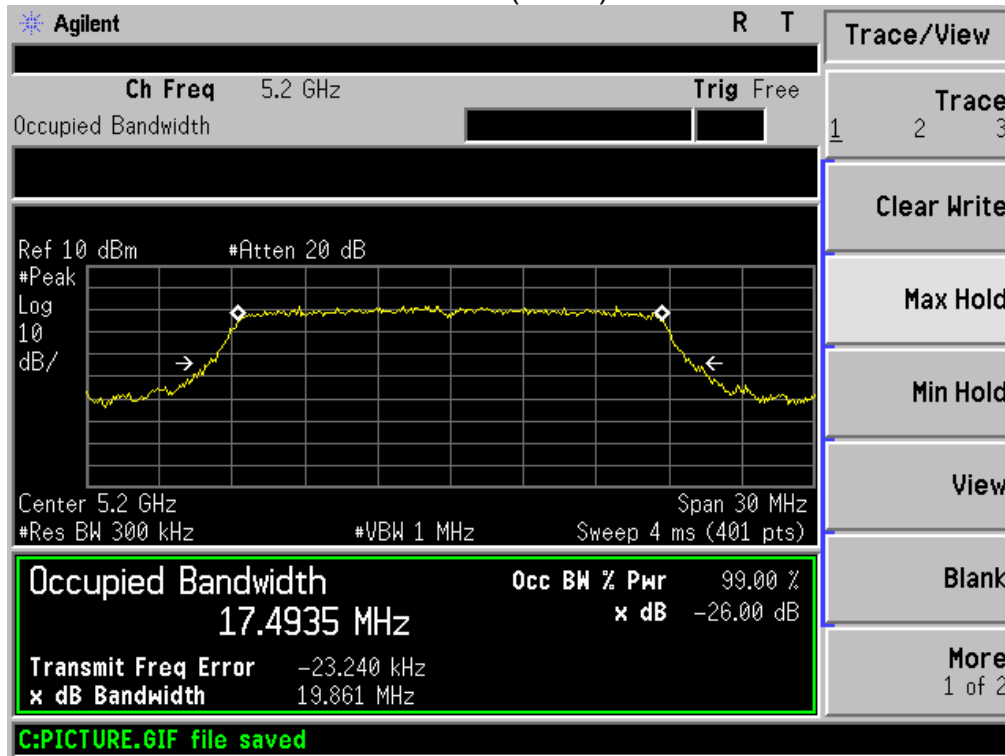

Antenna1-802.11n(HT20) 5240MHz

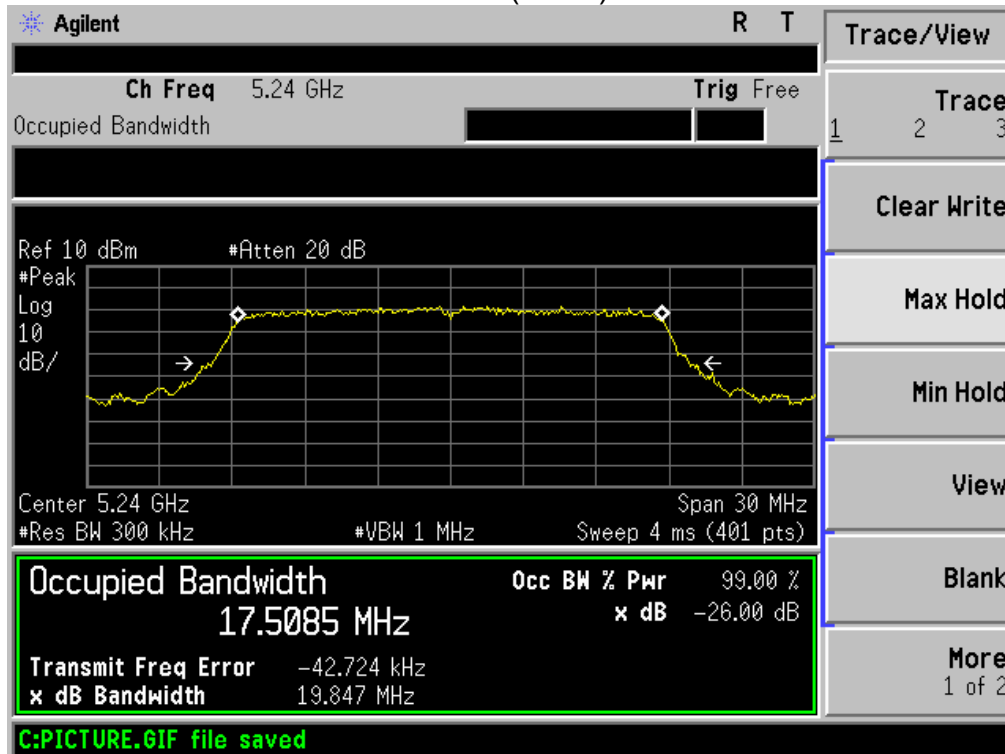



Antenna2-802.11a 5180MHz

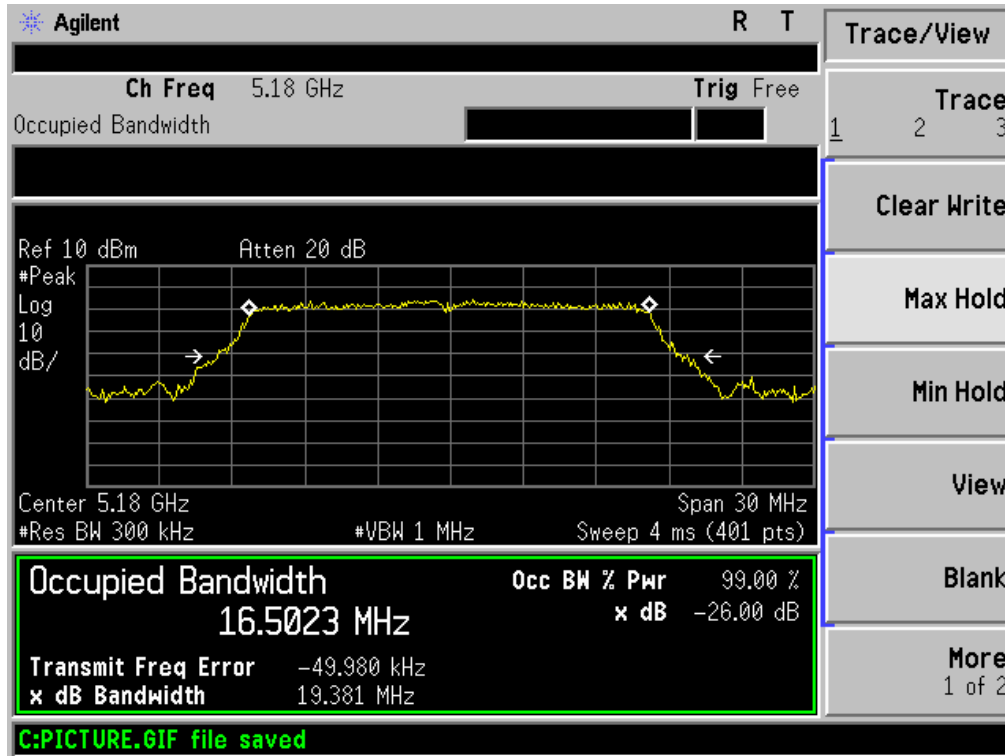

Antenna2-802.11a 5200MHz

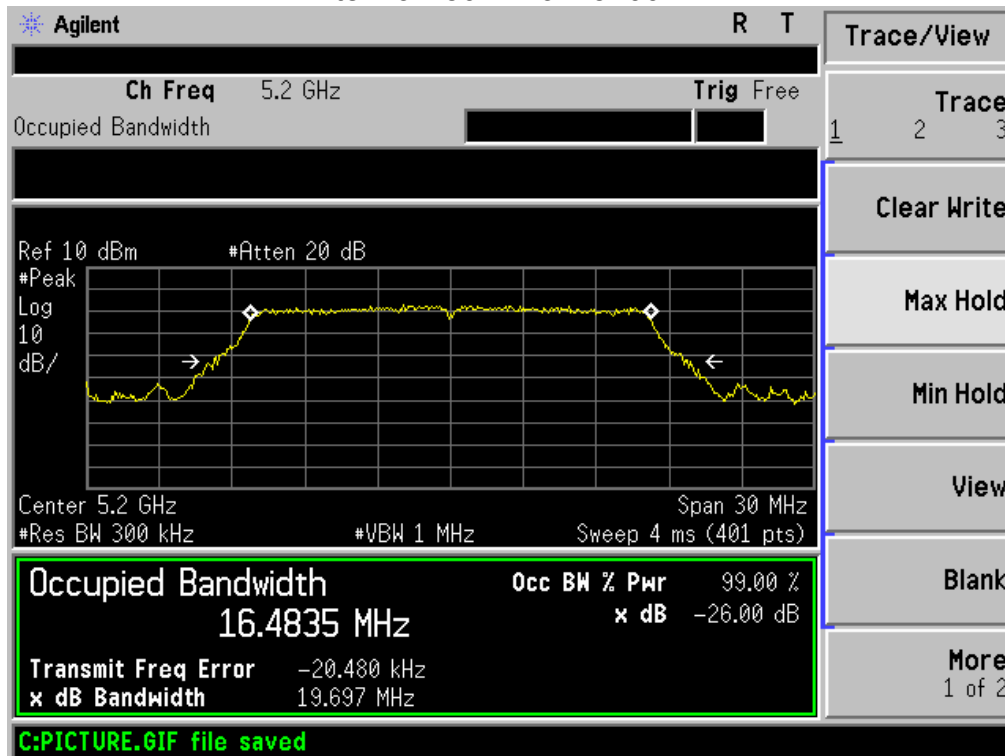



Antenna2-802.11a 5240MHz

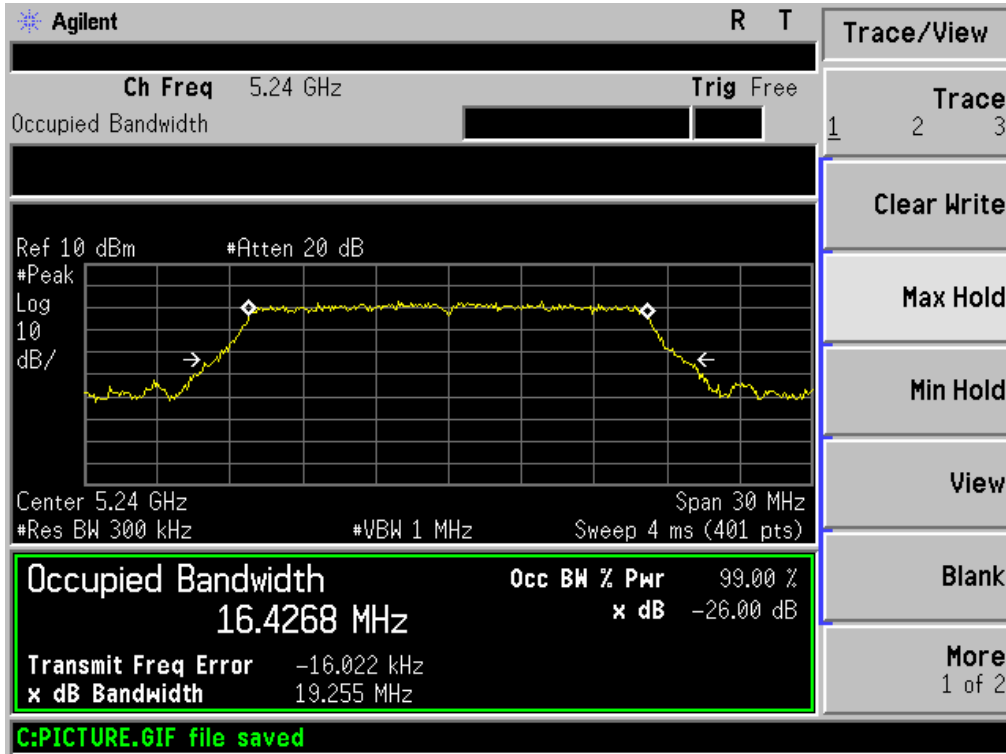

Antenna2-802.11n(HT20) 5180MHz

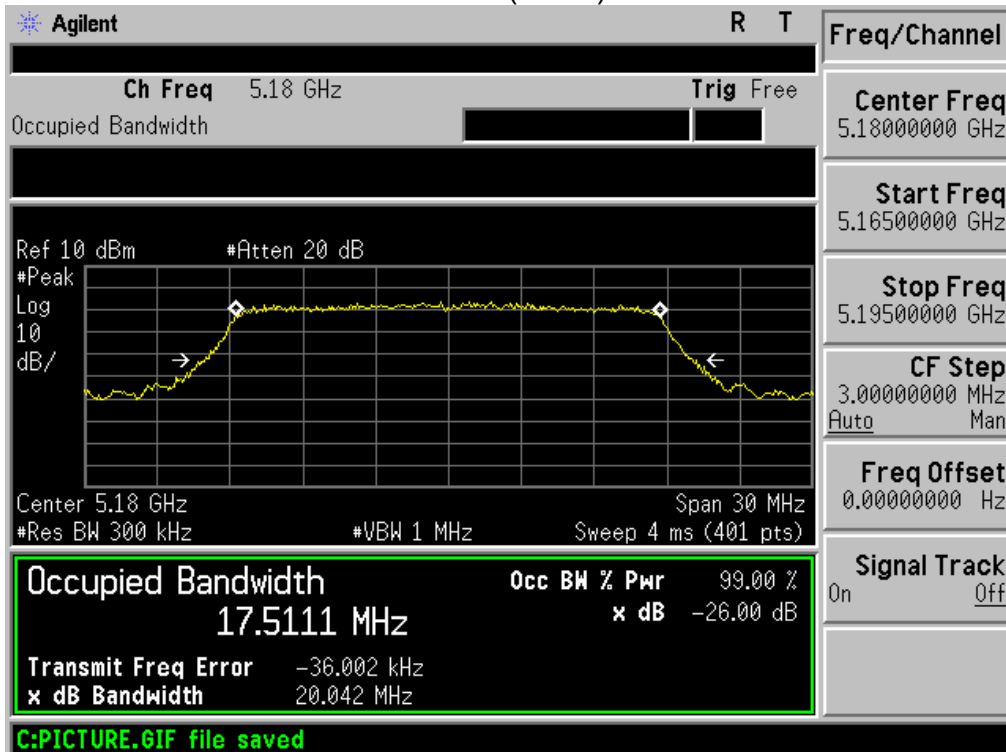



Antenna2-802.11n(HT20) 5200MHz

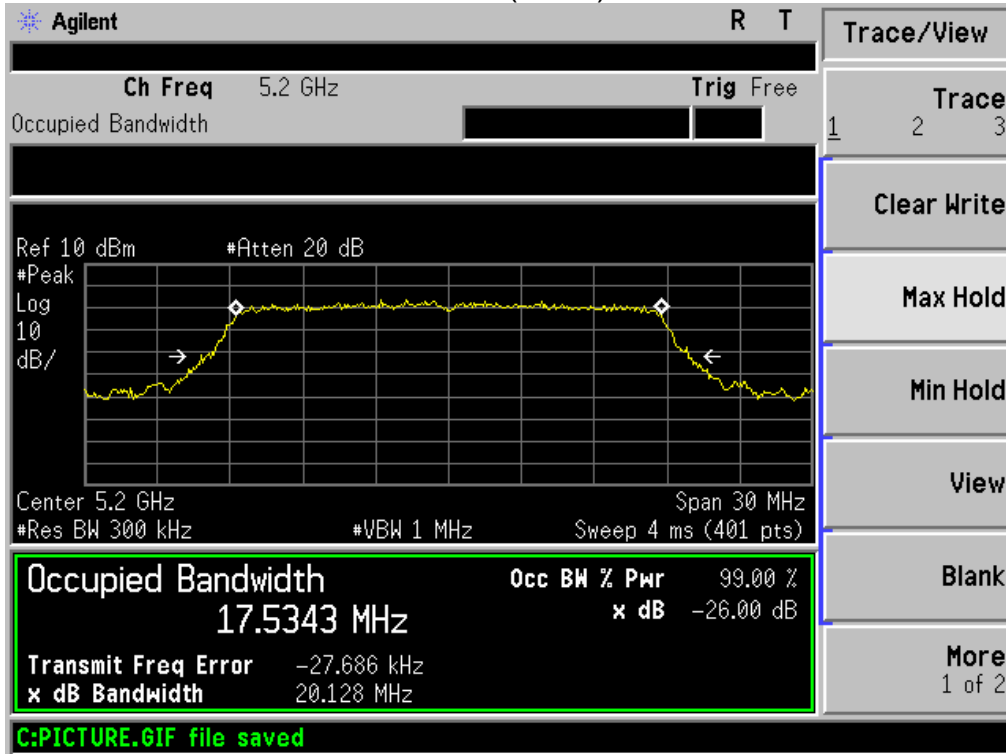

Antenna2-802.11n(HT20) 5240MHz

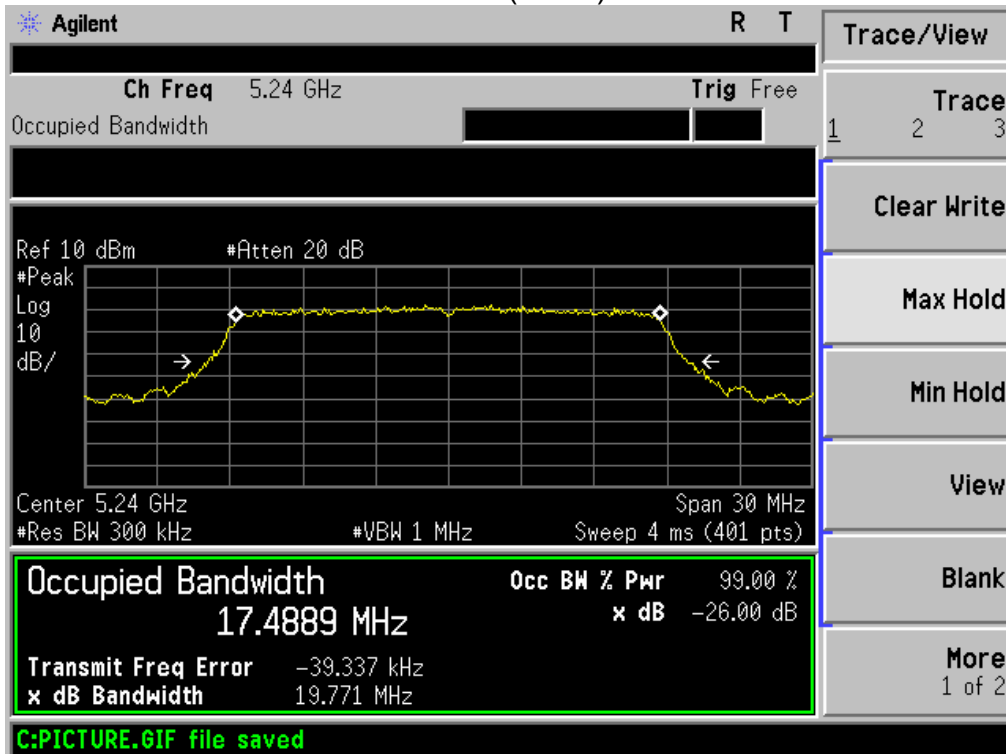

7. MINIMUM 6 DB BANDWIDTH

7.1. Applied procedures / limit

According to FCC §15.407(e)

(e) Within the 5.725-5.85 GHz band, the minimum 6 dB bandwidth of U-NII devices shall be at least 500 kHz.

7.2. TEST PROCEDURE

Section 15.407(e) specifies the minimum 6 dB emission bandwidth of at least 500 KHz for the band 5.715-5.85 GHz. The following procedure shall be used for measuring this bandwidth:

- a) Set RBW = 100 kHz.
- b) Set the video bandwidth (VBW) $\geq 3 \times$ RBW.
- c) Detector = Peak.
- d) Trace mode = max hold.
- e) Sweep = auto couple.
- f) Allow the trace to stabilize.
- g) Measure the maximum width of the emission that is constrained by the frequencies associated with the two outermost amplitude points (upper and lower frequencies) that are attenuated by 6 dB relative to the maximum level measured in the fundamental emission.

we test all antennas, the antenna 1 was worst mode and the data recording in the report.

7.3 Test result

	Frequency (MHz)	-6dB Bandwidth (MHz)		99% Bandwidth (MHz)		Limit (MHz)
		Ant 1	Ant 2	Ant 1	Ant 2	
802.11a	5745	16.356	16.328	16.321	16.3093	>0.5
	5785	15.977	16.114	16.301	16.322	>0.5
	5825	16.058	16.044	16.3181	16.3043	>0.5
802.11n (HT20)	5745	16.84	16.289	17.4531	17.4053	>0.5
	5785	16.642	15.761	17.3595	17.4247	>0.5
	5825	16.401	16.483	17.393	17.4332	>0.5



Antenna1-802.11a 5745MHz

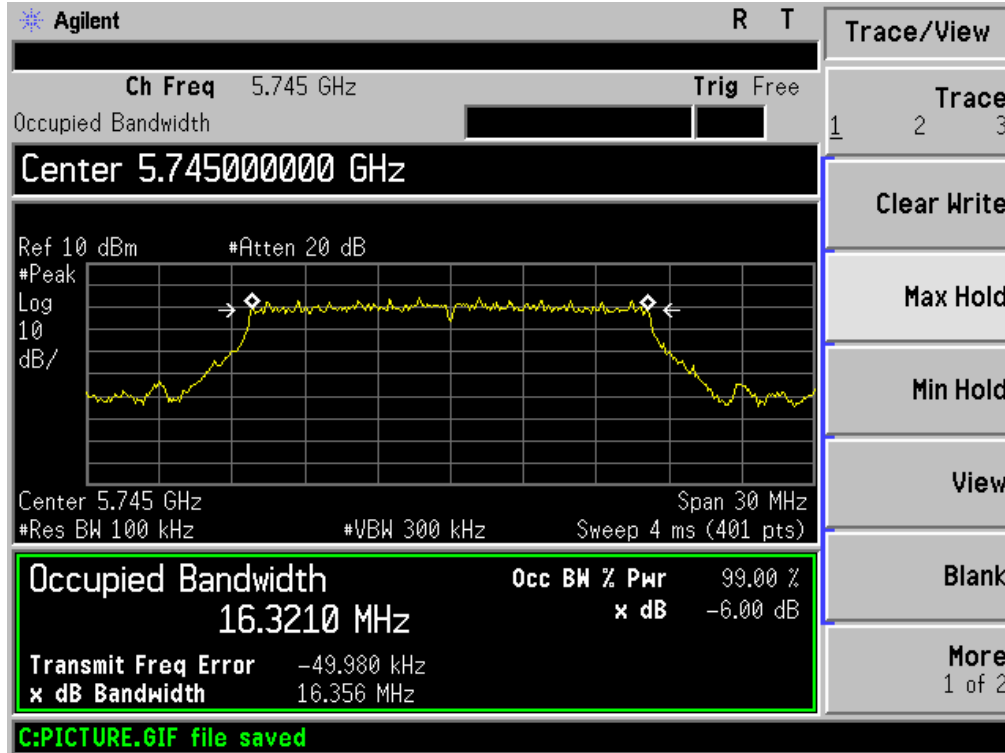

Antenna1-802.11a 5785MHz

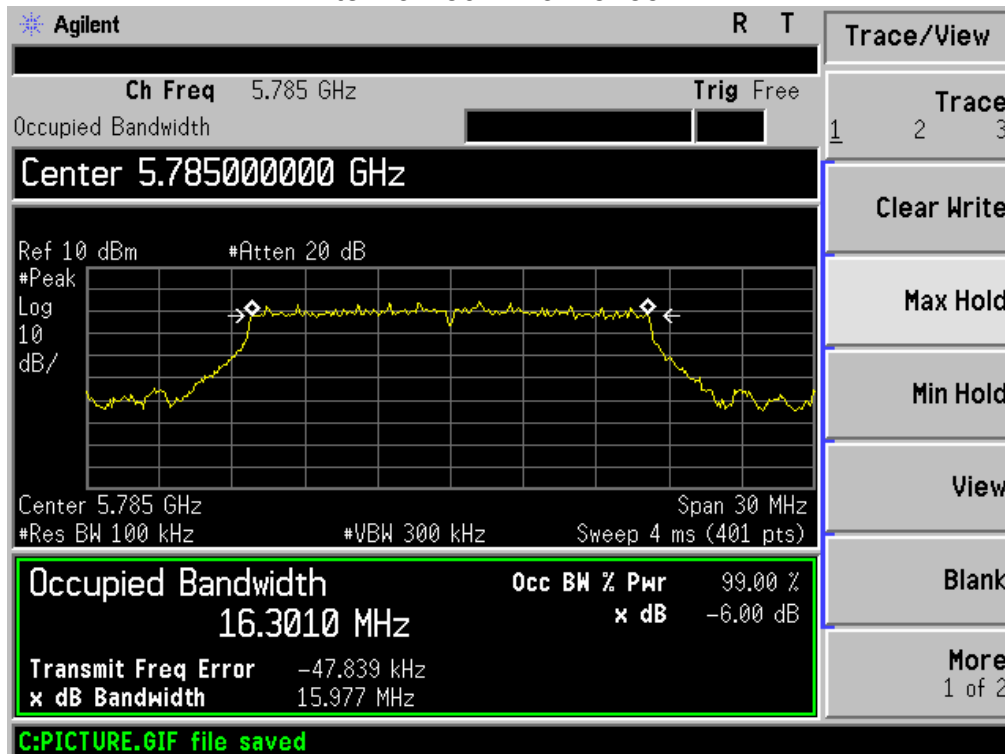



Antenna1-802.11a 5825MHz

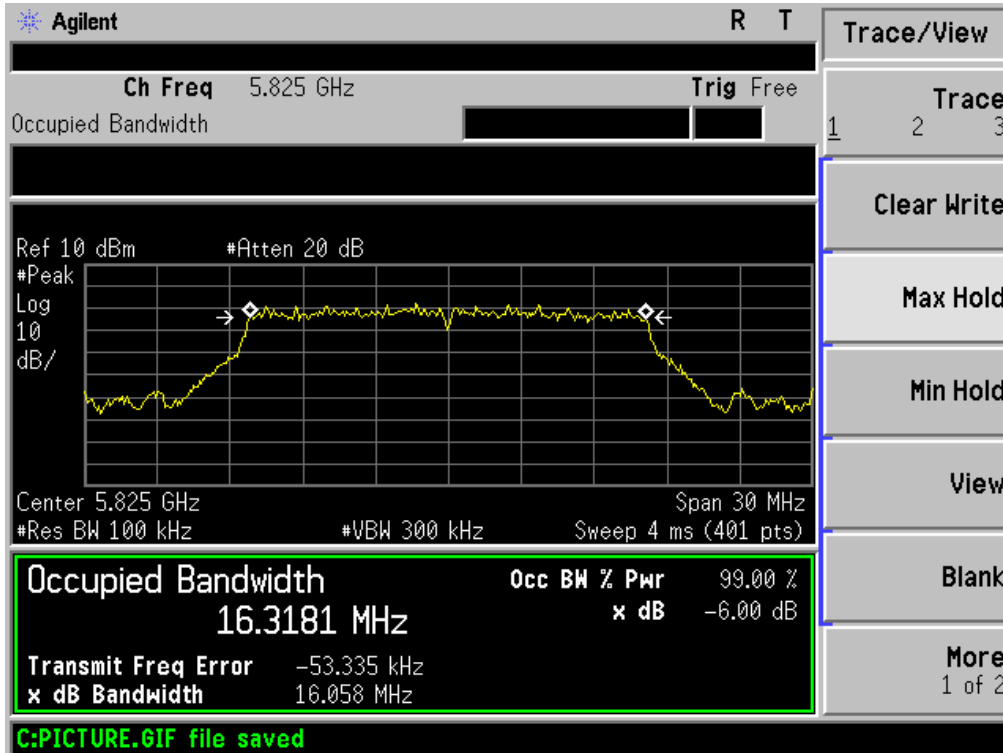

Antenna1-802.11n(HT20) 5745MHz

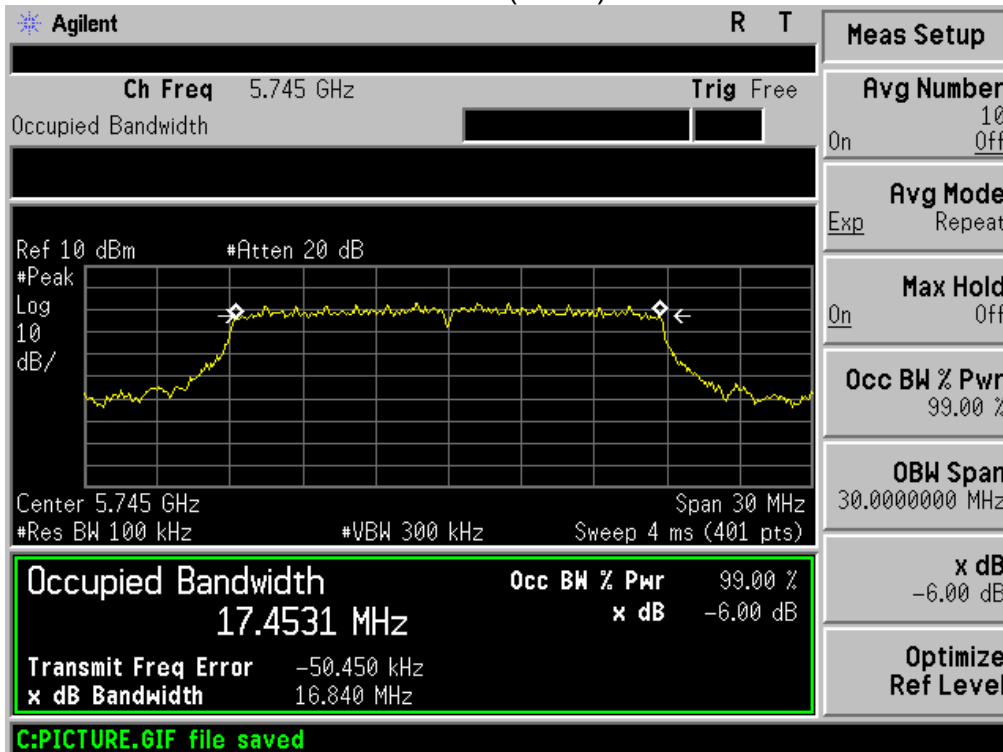



Antenna1-802.11n(HT20) 5785MHz

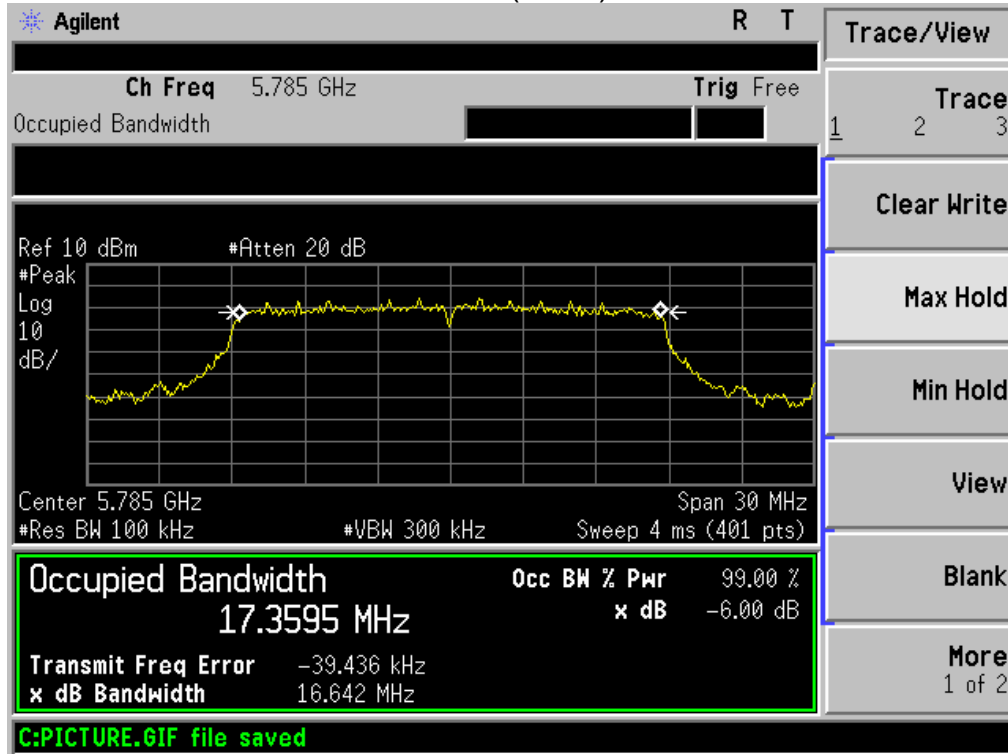

Antenna1-802.11n(HT20) 5825MHz

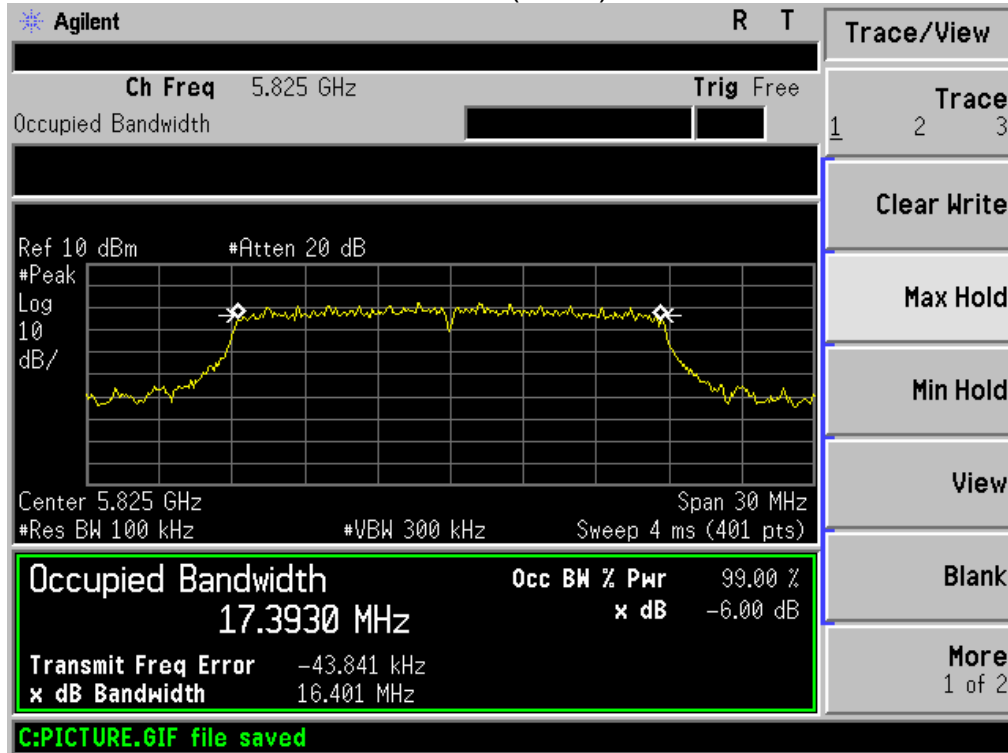



Antenna2-802.11a 5745MHz

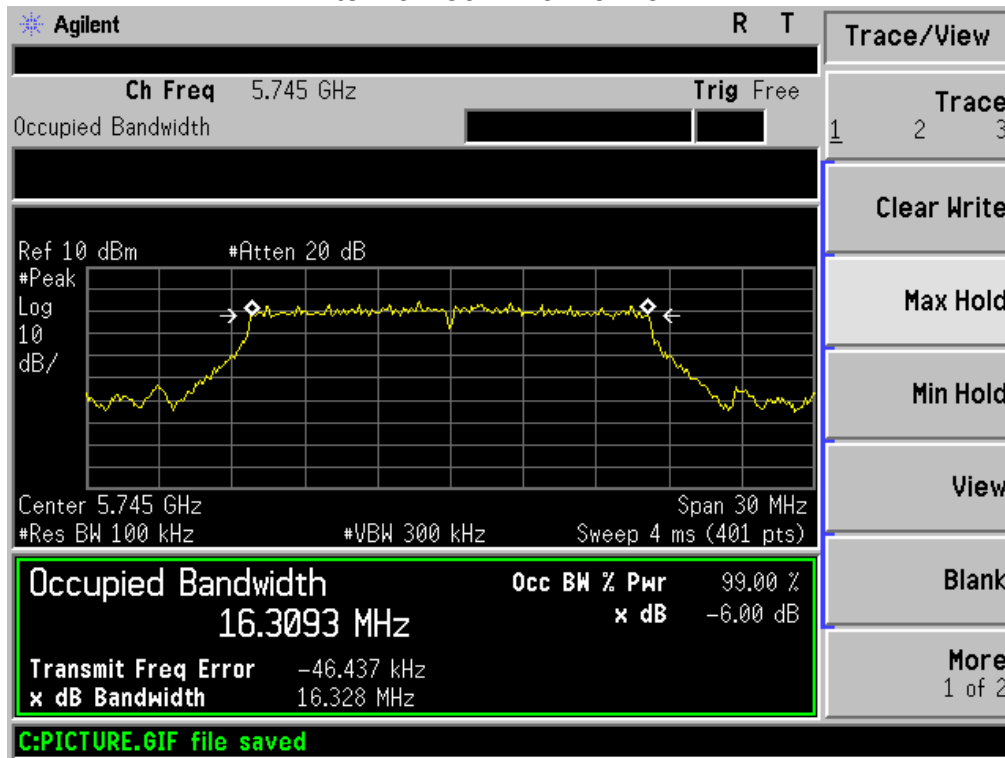

Antenna2-802.11a 5785MHz

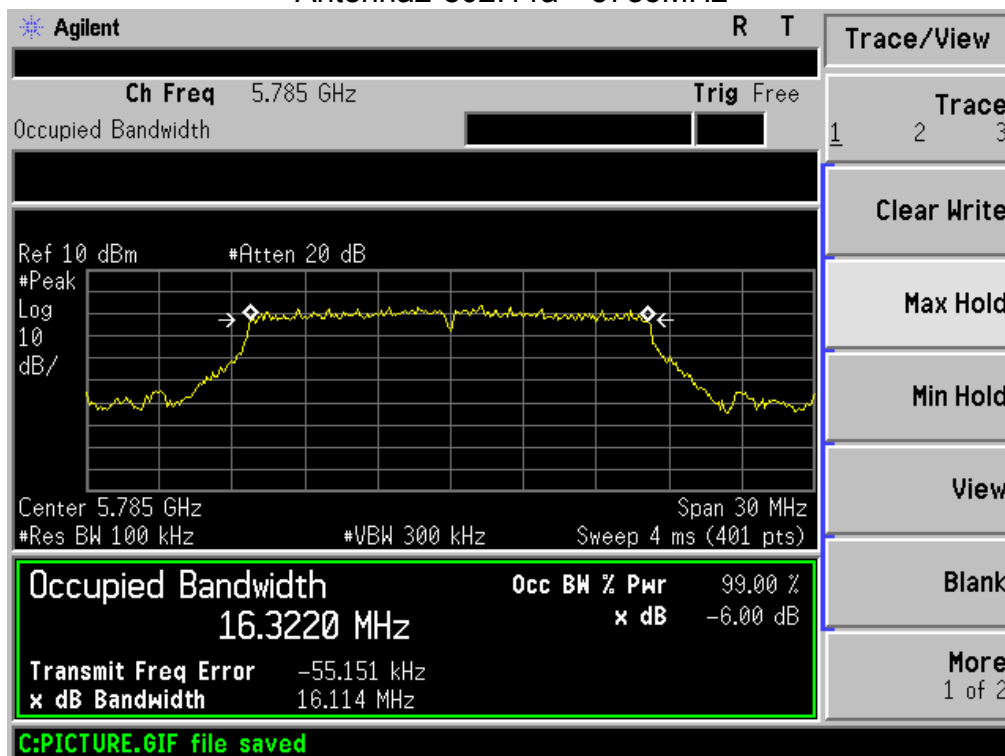



Antenna2-802.11a 5825MHz

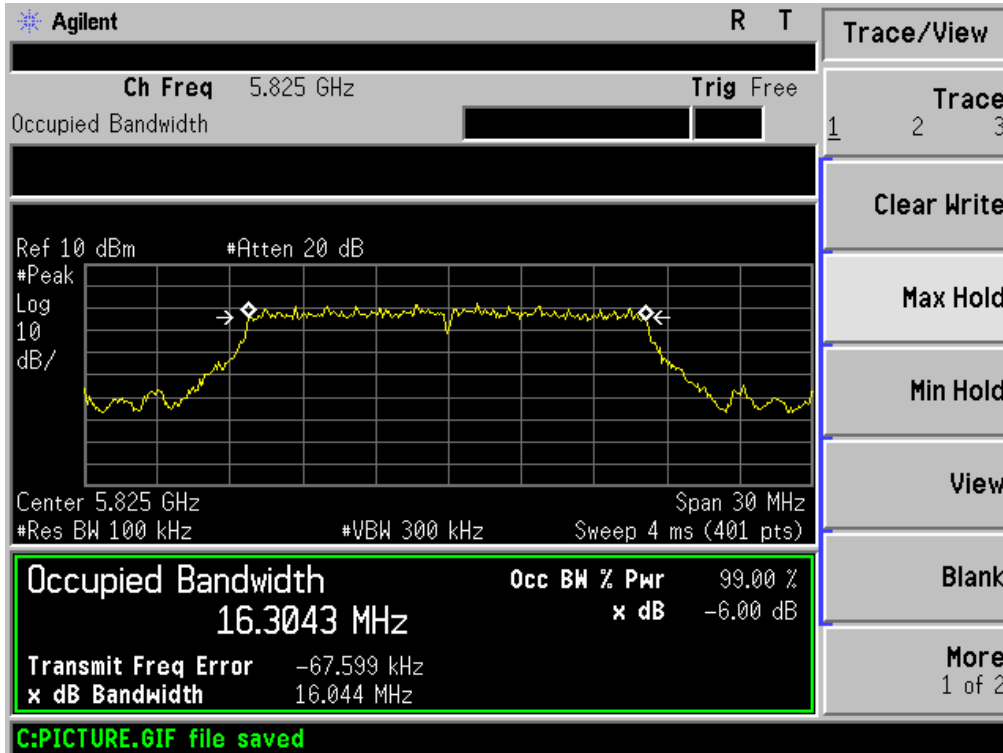

Antenna2-802.11n(HT20) 5745MHz

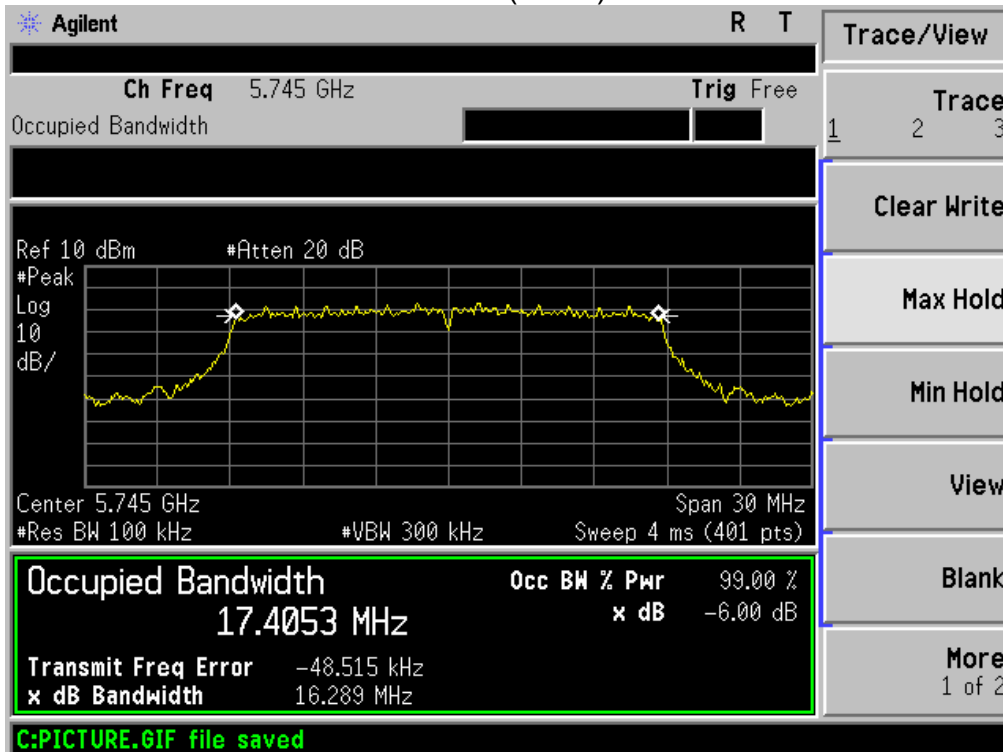



Antenna2-802.11n(HT20) 5785MHz

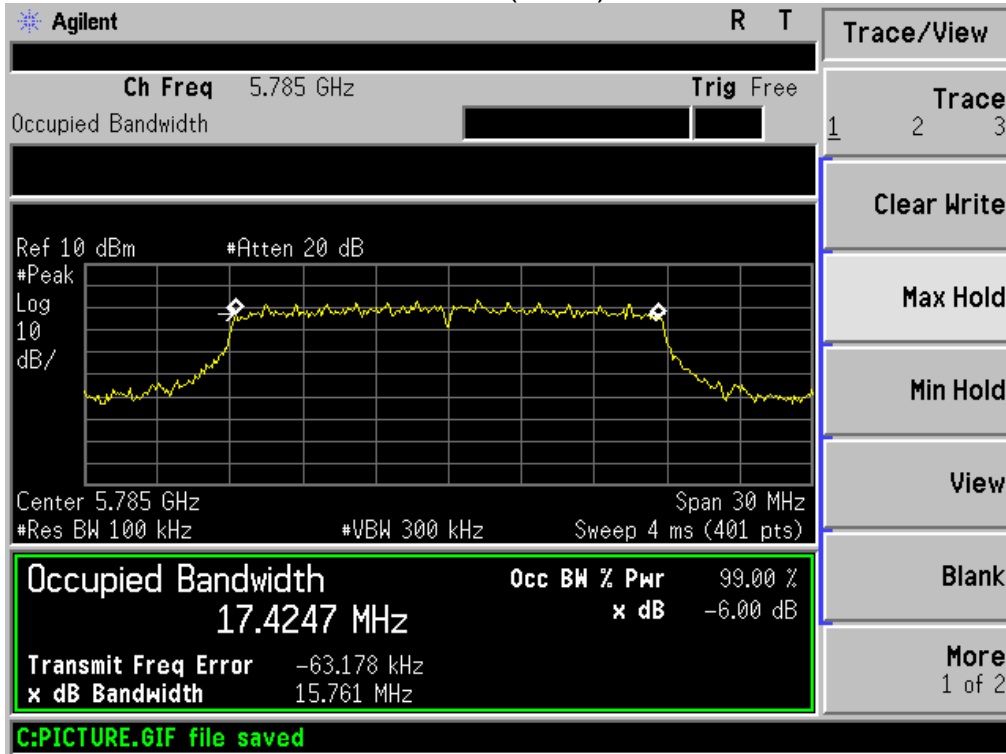

Antenna2-802.11n(HT20) 5825MHz

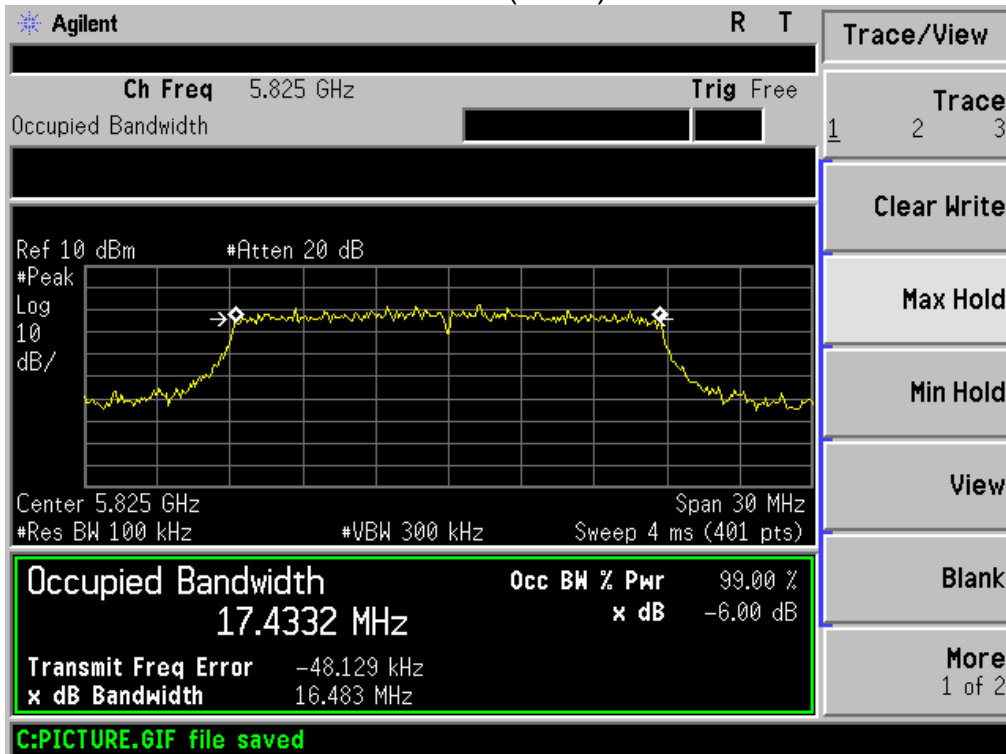

8. OUTPUT POWER TEST

8.1. Limits

For mobile and portable client devices in the 5.15-5.25 GHz band, the maximum conducted output power over the frequency band of operation shall not exceed 250 mW provided the maximum antenna gain does not exceed 6 dBi.

For the band 5.725-5.85 GHz, the maximum conducted output power over the frequency band of operation shall not exceed 1 W.

8.2. Test setup

1. The maximum average conducted output power can be measured using Method PM-G (Measurement using a gated RF average power meter):
2. Measurements may be performed using a wideband gated RF power meter provided that the gate parameters are adjusted such that the power is measured only when the EUT is transmitting at its maximum power control level. Since the measurement is made only during the ON time of the transmitter, no duty cycle correction factor is required.
 - a. The Transmitter output (antenna port) was connected to the power meter.
 - b. Turn on the EUT and power meter and then record the power value.
 - c. Repeat above procedures on all channels needed to be tested.
3. Note: the Directional Gain= $2\text{dBi}+10\log(2)=5\text{dBi}$, so the final limit=requirement limit





8.3. Test result

	Frequency	Antenna port	Maximum Conducted Output Power(PK)	Maximum Conducted Output Power(PK)	Total Conducted Output Power(PK)	Total Conducted Output Power(PK)	LIMIT
	(MHz)		(dBm)	(mW)	(mW)	(dBm)	dBm
802.11a	5180	Ant.1	-5.75	0.27	N/A	N/A	23.98
		Ant.2	-5.27	0.30			
	5200	Ant.1	-5.69	0.27	N/A	N/A	23.98
		Ant.2	-5.12	0.31			
	5240	Ant.1	-5.35	0.29	N/A	N/A	23.98
		Ant.2	-5.18	0.30			
	5745	Ant.1	-5.15	0.31	N/A	N/A	30
		Ant.2	-5.36	0.29			
	5785	Ant.1	-5.29	0.30	N/A	N/A	30
		Ant.2	-5.11	0.31			
	5825	Ant.1	-5.38	0.29	N/A	N/A	30
		Ant.2	-5.37	0.29			
802.11n20	5180	Ant.1	-5.57	0.28	0.58	-2.37	23.98
		Ant.2	-5.28	0.30			
	5200	Ant.1	-5.76	0.27	0.57	-2.44	23.98
		Ant.2	-5.17	0.30			
	5240	Ant.1	-5.08	0.31	0.62	-2.08	23.98
		Ant.2	-5.07	0.31			
	5745	Ant.1	-5.31	0.29	0.60	-2.22	30
		Ant.2	-5.13	0.31			
	5785	Ant.1	-5.37	0.29	0.59	-2.29	30
		Ant.2	-5.23	0.30			
	5825	Ant.1	-5.22	0.30	0.59	-2.29	30
		Ant.2	-5.44	0.29			



9. PEAK POWER SPECTRAL DENSITY TEST

9.1. Limits

In addition, the maximum power spectral density shall not exceed 11 dBm in any 1 megahertz band.

In addition, the maximum power spectral density shall not exceed 30 dBm in any 500 kHz band.

9.2. Test setup

1. Place the EUT on the table and set it in transmitting mode.
2. The testing follows FCC KDB 789033 D02.
3. Remove the antenna from the EUT and then connect a low loss RF cable from the antenna port to

Spectrum.

4. For U-NII1, U-NII-2A, U-NII-2C Band:

Set RBW=1MHz, VBW=3MHz, where span is enough to capture the entire bandwidth, Sweep time = Auto (601 pts), detector = sample, traces 100 sweeps of video averaging. (SA-2 with the omission of procedure x, the integration with 26dB EBW bandwidth)

For U-NII-3 Band:

Set RBW=510 kHz, VBW=3*RBW, where span is enough to capture the entire bandwidth, Sweep time = Auto (601 pts), detector = sample, traces 100 sweeps of video averaging. (SA-2 with the omission of procedure x, the integration with 26dB EBW bandwidth)

5. Use the cursor on spectrum to peak search the highest level of trace
6. Record the max. reading and add $10 \log(1/\text{duty cycle})$.
7. the Directional Gain= $2\text{dBi}+10\log(2)=5\text{dBi}$, so the final limit=requirement limit

we test all antennas, the antenna 1 was worst mode and the data recording in the report.



9.3. Test data

Test data as below

	Frequency	Antenna port	Maximum Conducted Output Power(PK)	Duty factor	Duty factor 10 log (1MHz/RBW)	Total PPSD	LIMIT
	(MHz)		(dBm)	(dB)		(dBm)	dBm
802.11a	5180	Ant.1	0.726	0.0	0.0	N/A	11
		Ant.2	0.763	0.0	0.0		
	5200	Ant.1	0.418	0.0	0.0	N/A	11
		Ant.2	-0.308	0.0	0.0		
	5240	Ant.1	-0.21	0.0	0.0	N/A	11
		Ant.2	0.172	0.0	0.0		
	5745	Ant.1	3.642	0.0	0.0	N/A	30
		Ant.2	2.339	0.0	0.0		
	5785	Ant.1	3.546	0.0	0.0	N/A	30
		Ant.2	2.757	0.0	0.0		
	5825	Ant.1	1.205	0.0	0.0	N/A	30
		Ant.2	1.636	0.0	0.0		
802.11n20	5180	Ant.1	-2.734	0.0	0.0	0.38	11
		Ant.2	-2.536	0.0	0.0		
	5200	Ant.1	-2.906	0.0	0.0	0.34	11
		Ant.2	-2.452	0.0	0.0		
	5240	Ant.1	-2.683	0.0	0.0	0.69	11
		Ant.2	-1.992	0.0	0.0		
	5745	Ant.1	1.6	0.0	0.0	4.66	30
		Ant.2	1.698	0.0	0.0		
	5785	Ant.1	1.315	0.0	0.0	4.76	30
		Ant.2	2.146	0.0	0.0		
	5825	Ant.1	0.915	0.0	0.0	3.99	30
		Ant.2	1.042	0.0	0.0		

Ant1

802.11a 5180MHz

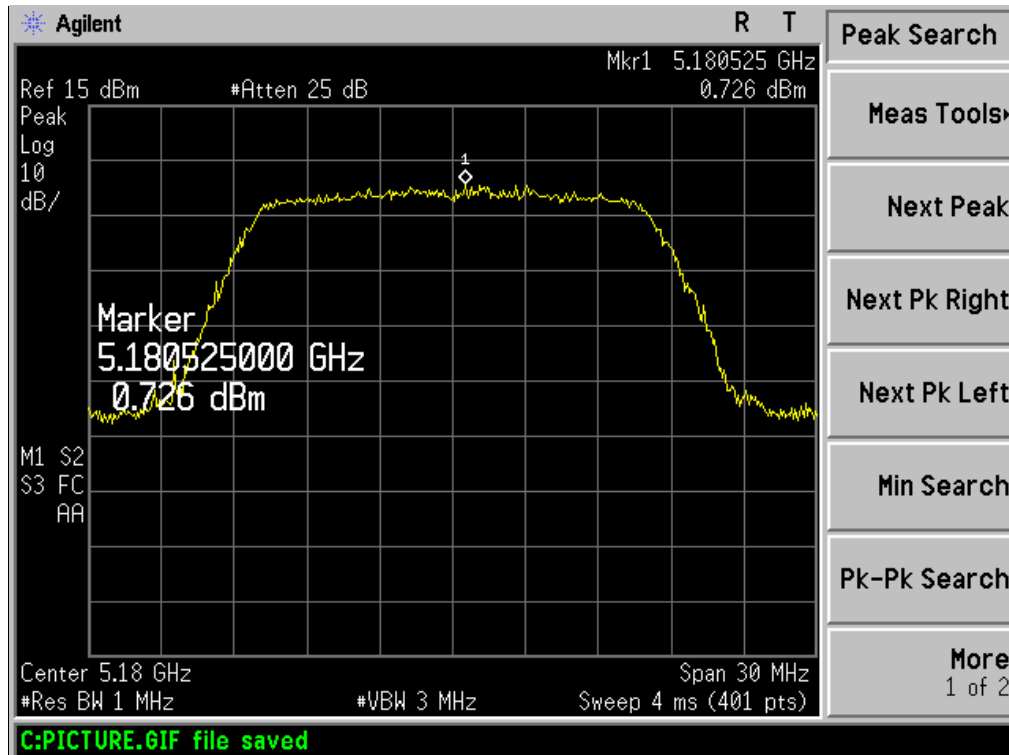

Ant1

802.11a 5200MHz

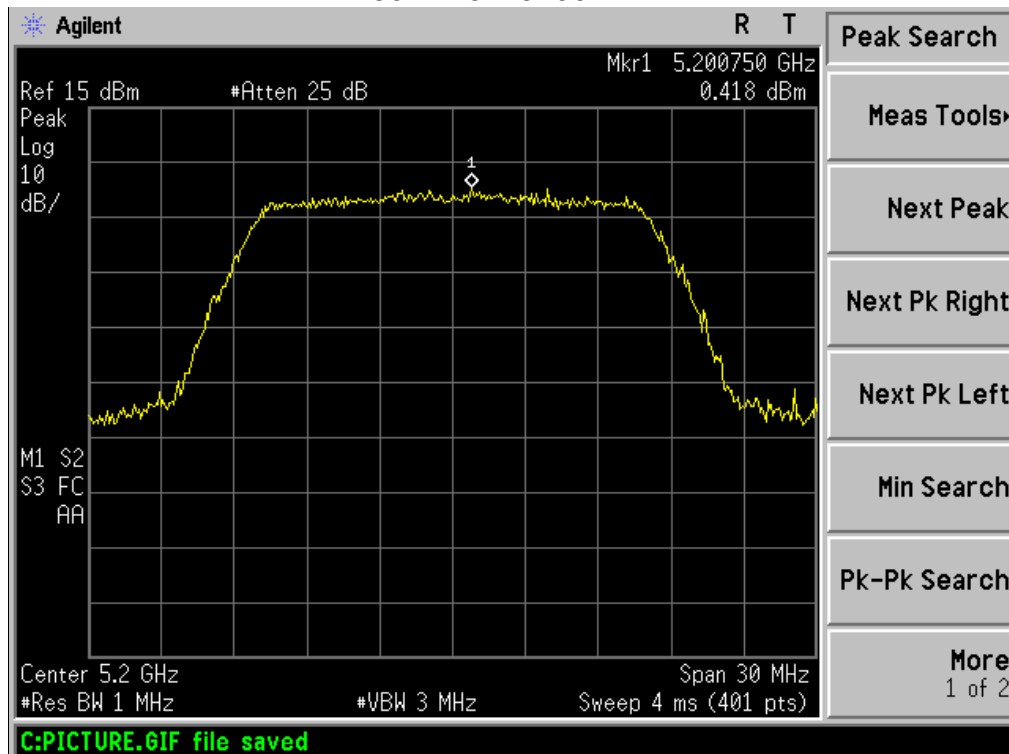

Ant1

802.11a 5240MHz

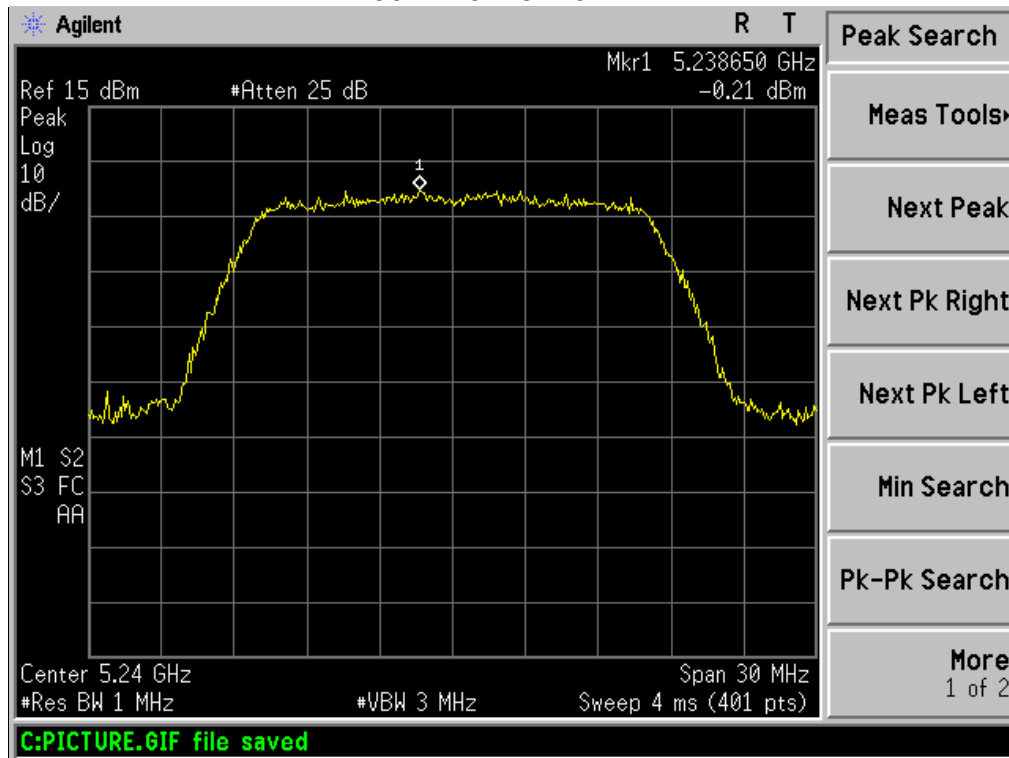

Ant1

802.11a 5745MHz

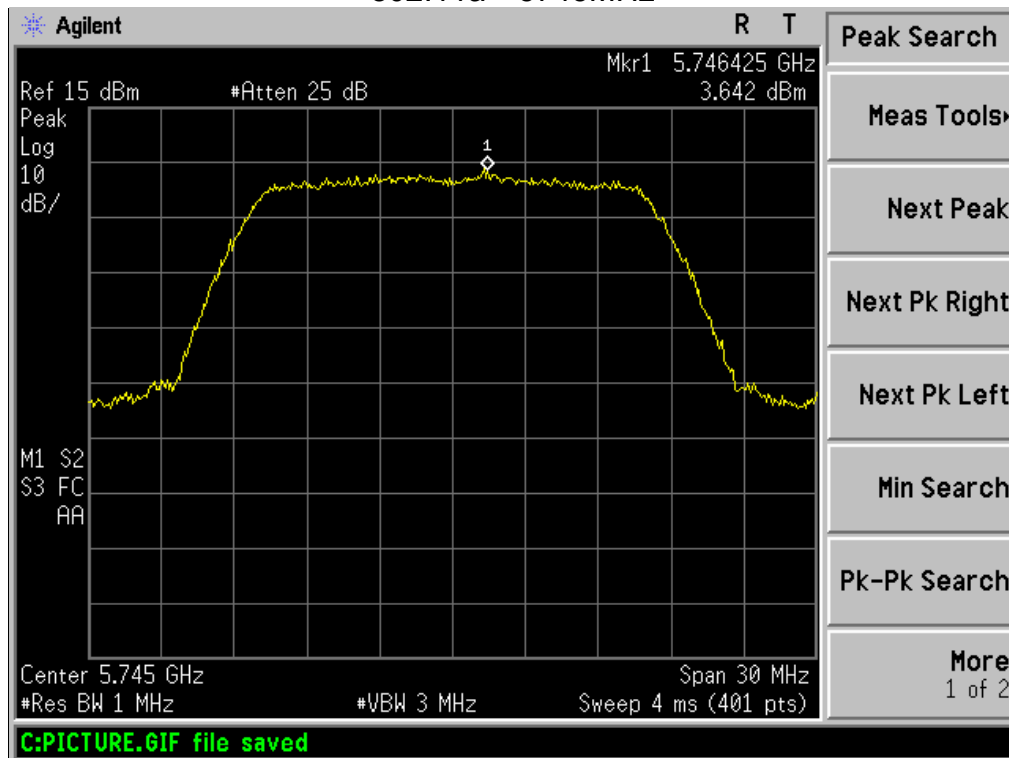

Ant1

802.11a 5785MHz

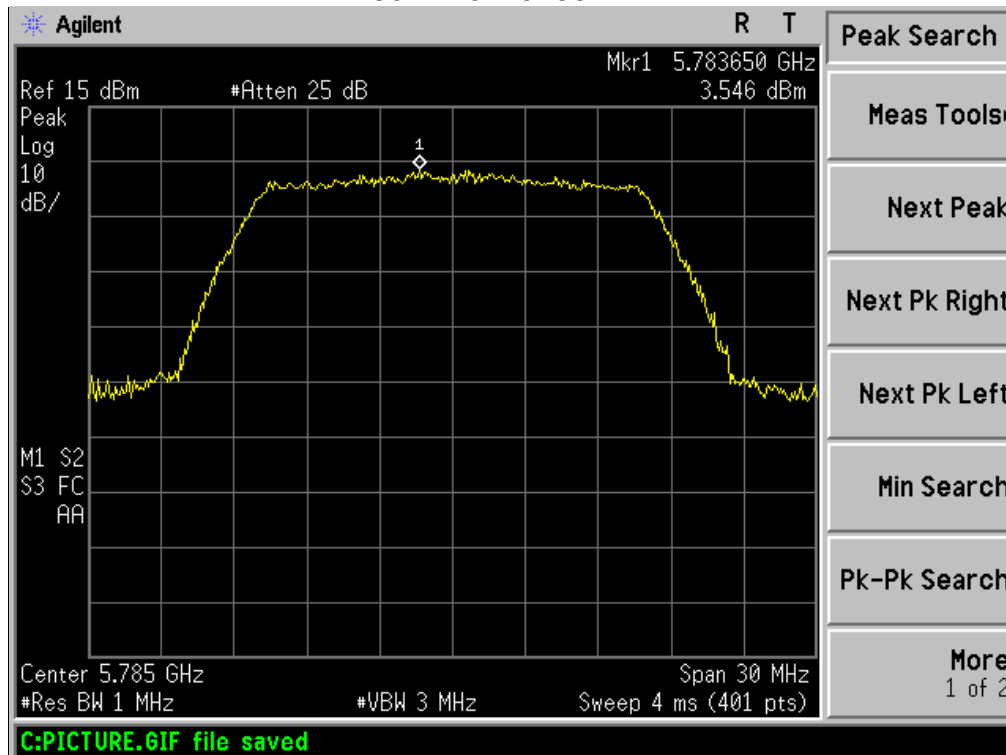

Ant1

802.11a 5825MHz

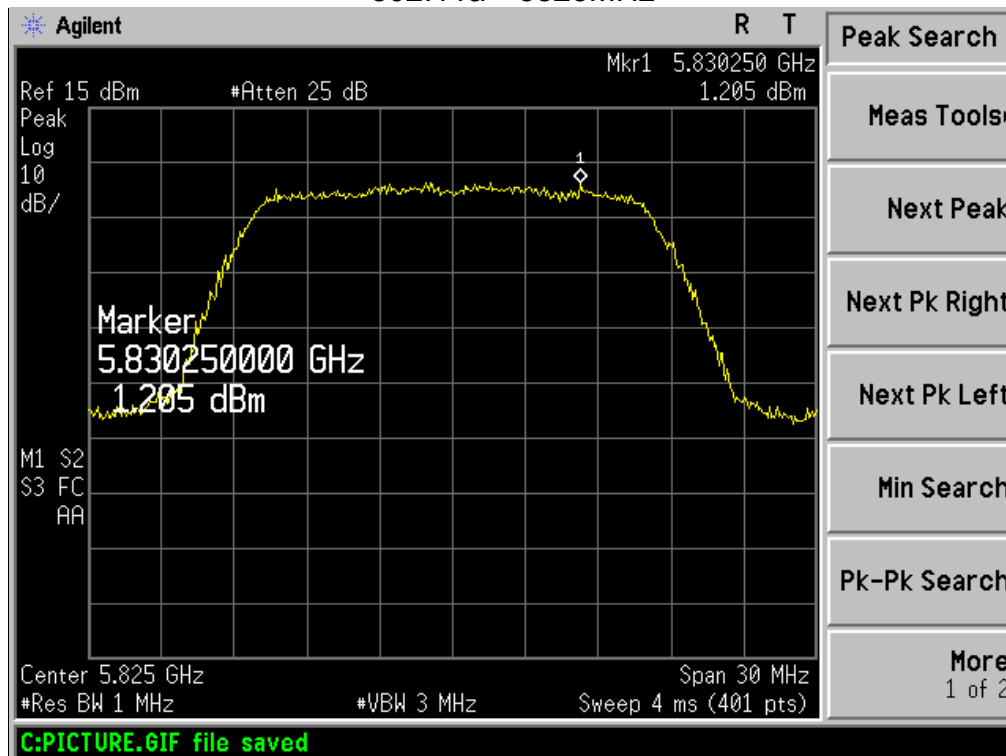

Ant1

802.11n(HT20) 5180MHz

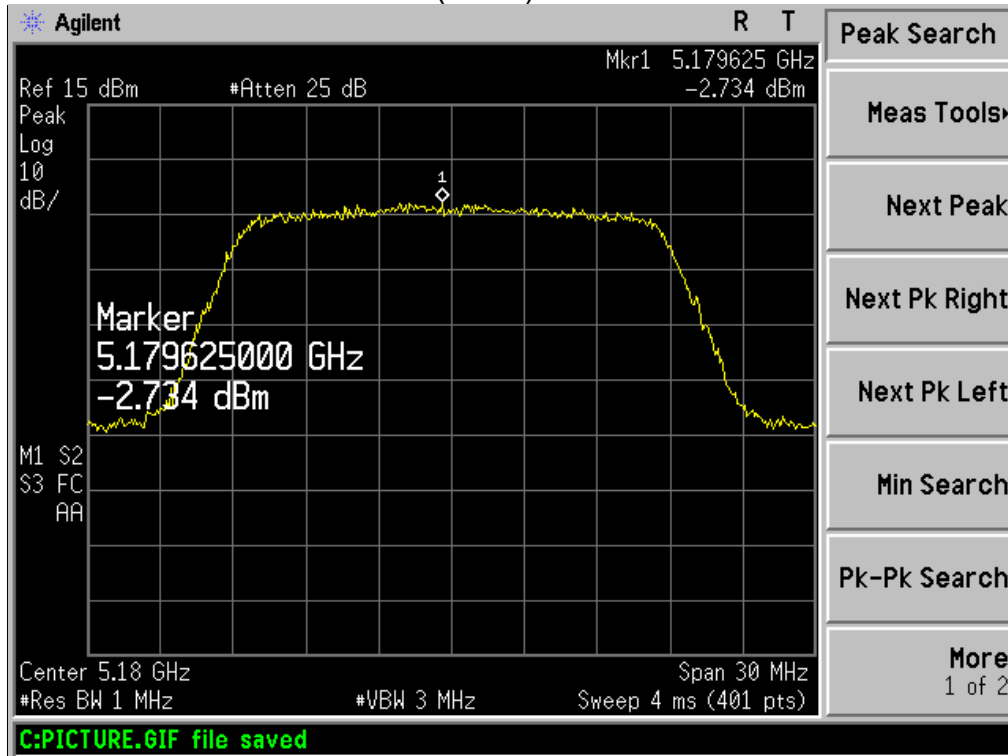

Ant1

802.11n(HT20) 5200MHz

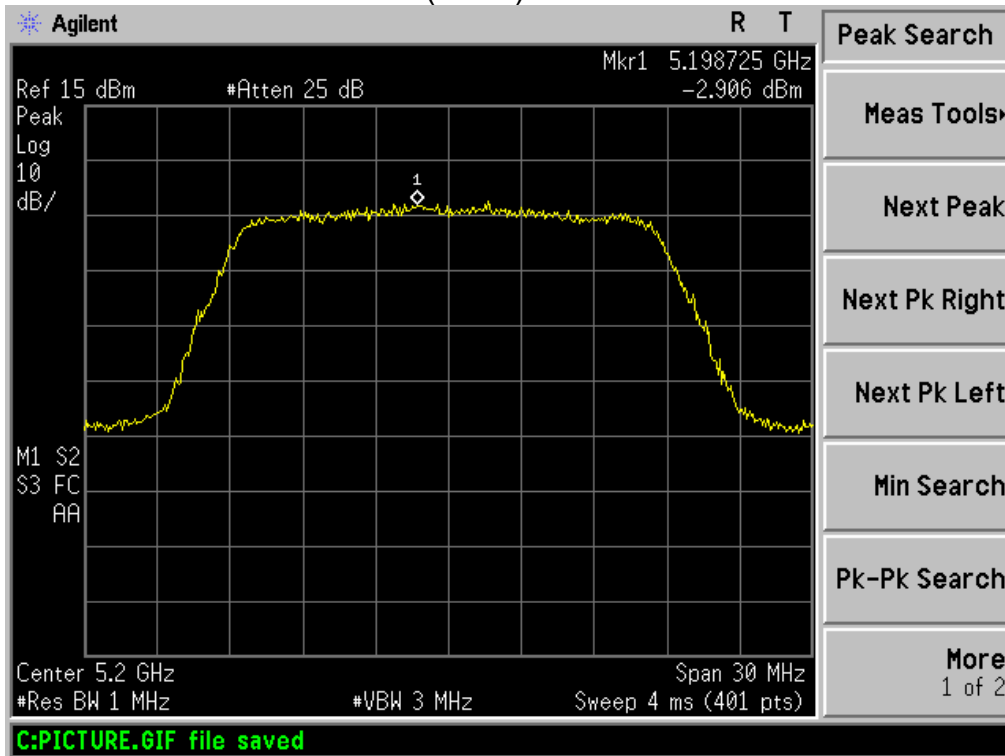

Ant1

802.11n(HT20) 5240MHz

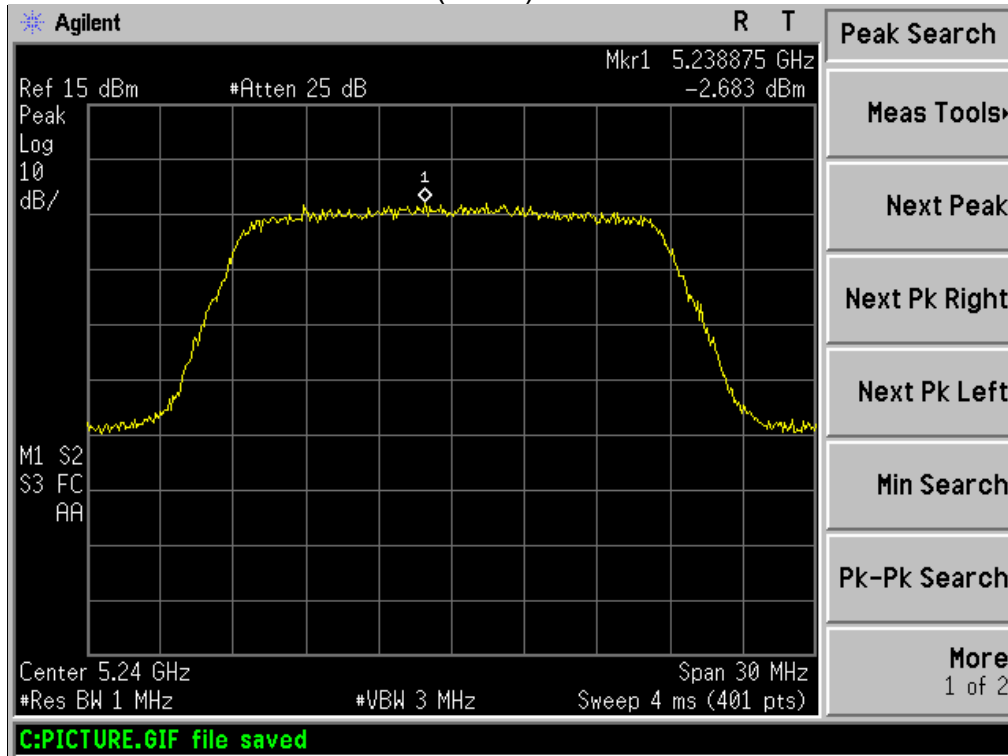

Ant1

802.11n(HT20) 5745MHz

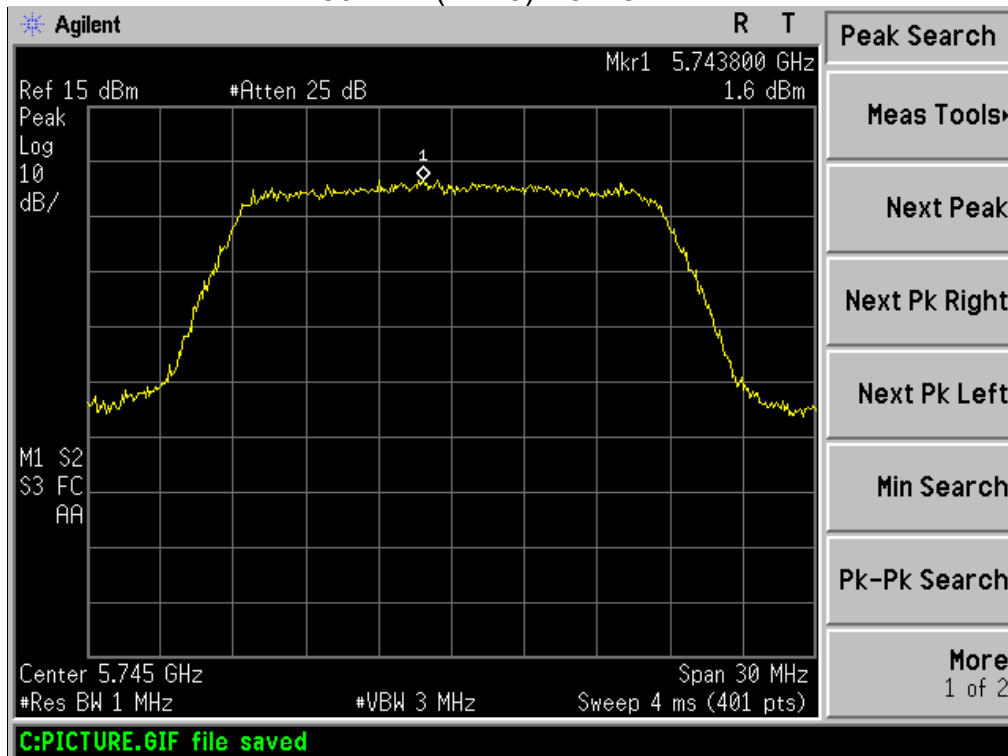

Ant1

802.11n(HT20) 5785MHz

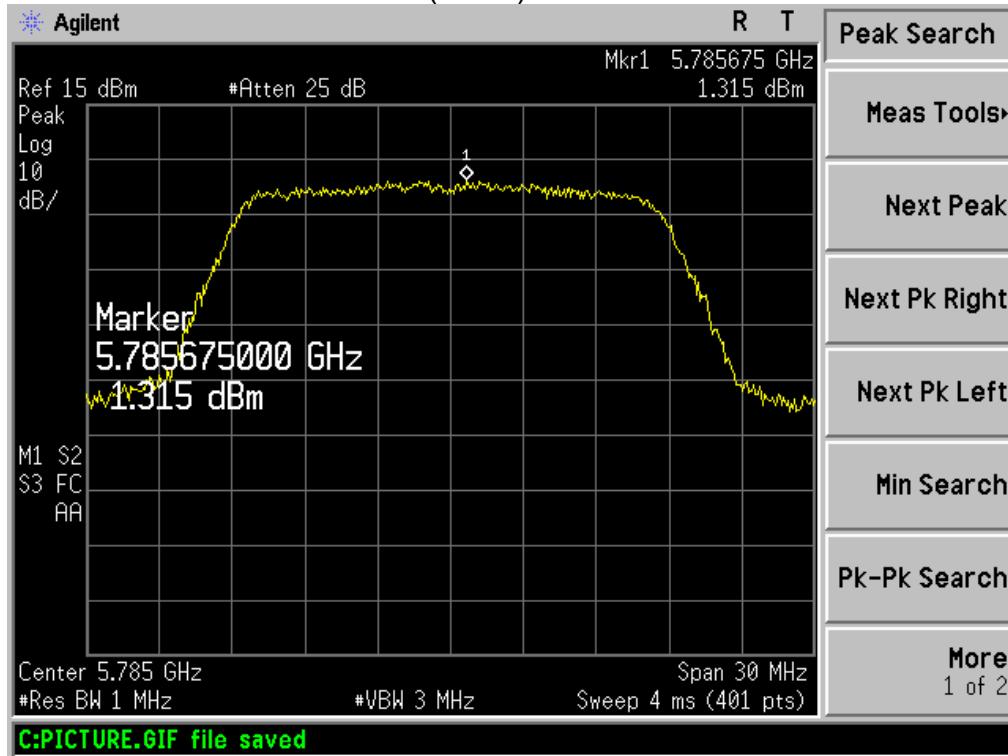

Ant1

802.11n(HT20) 5825MHz

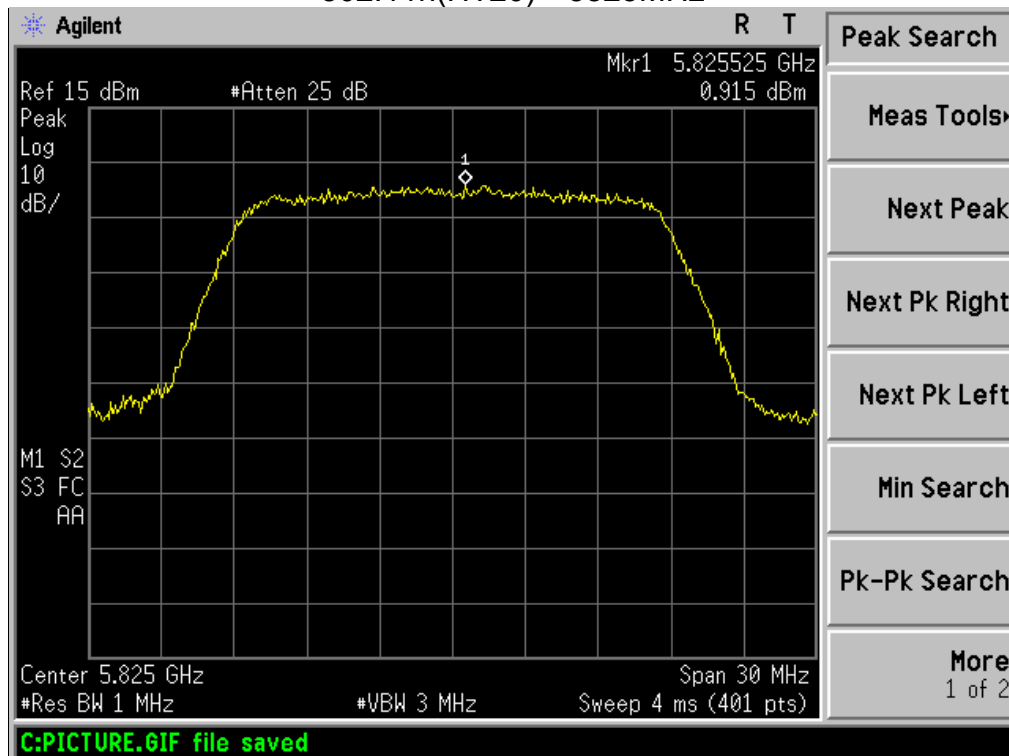

Ant2

802.11a 5180MHz

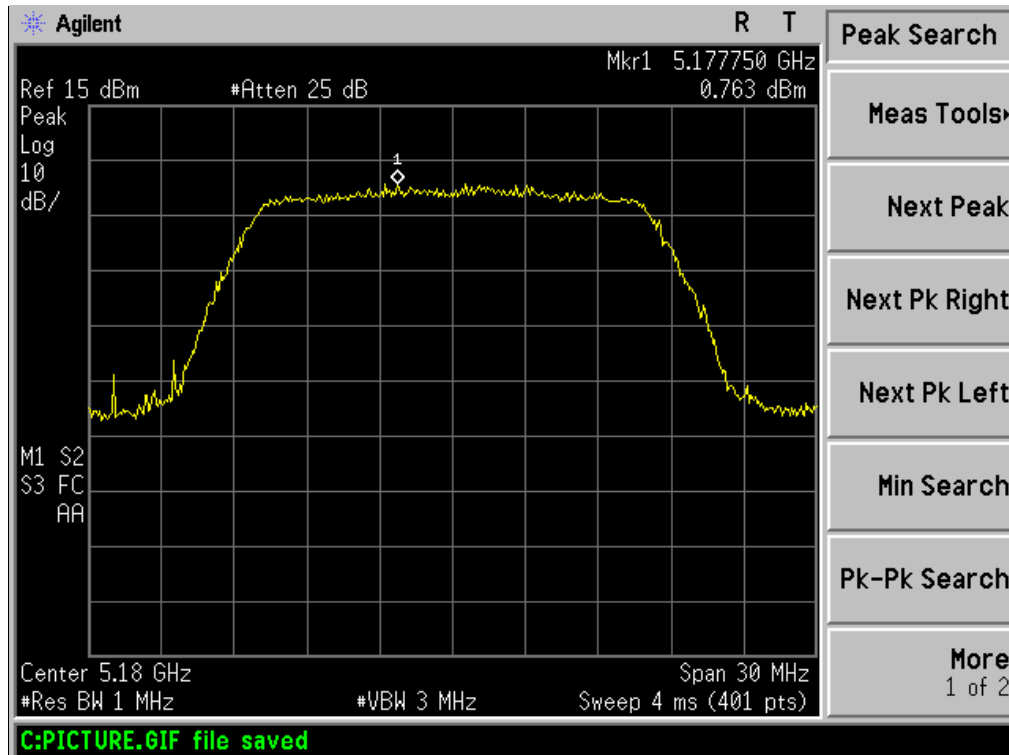

Ant2

802.11a 5200MHz

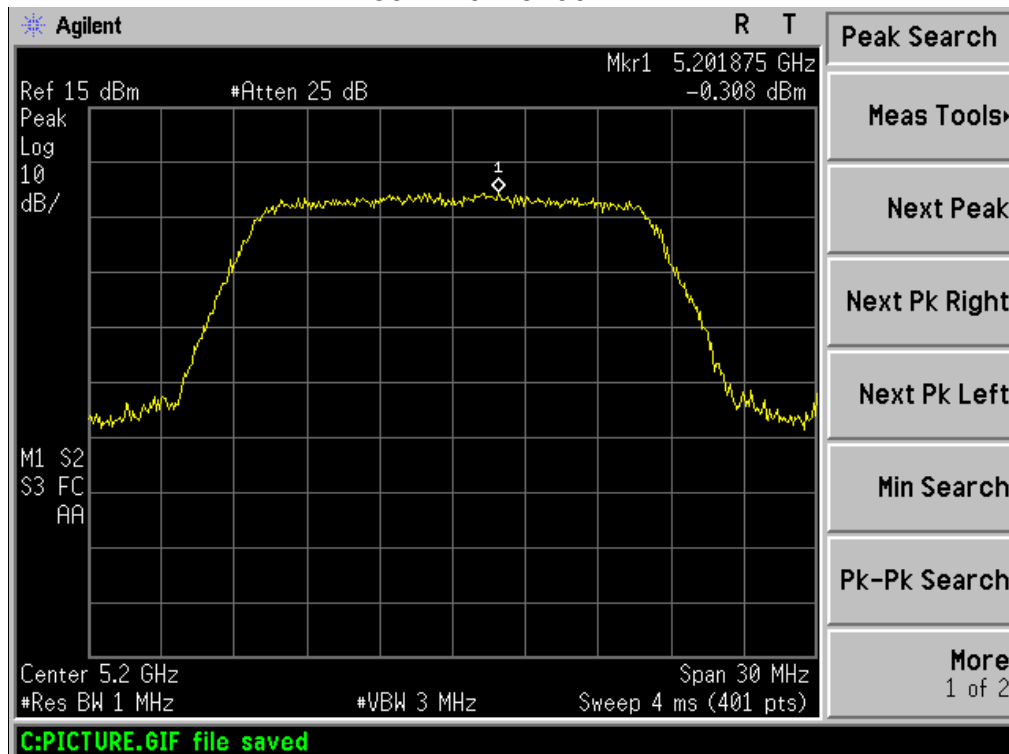

Ant2

802.11a 5240MHz

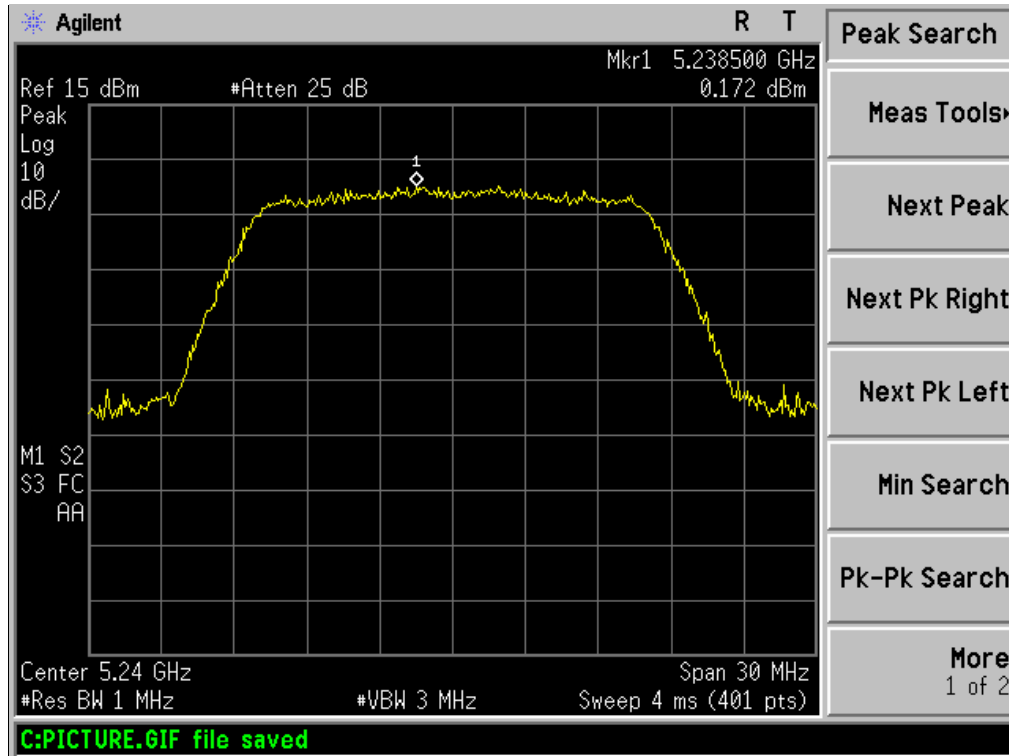

Ant2

802.11a 5745MHz

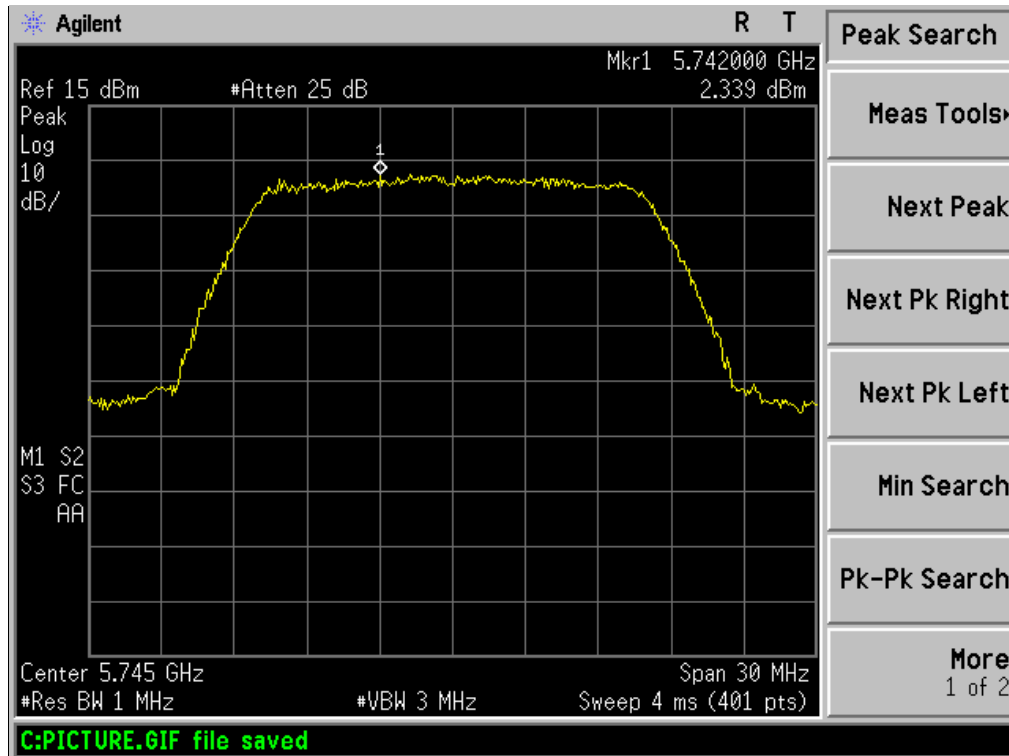

Ant2

802.11a 5785MHz

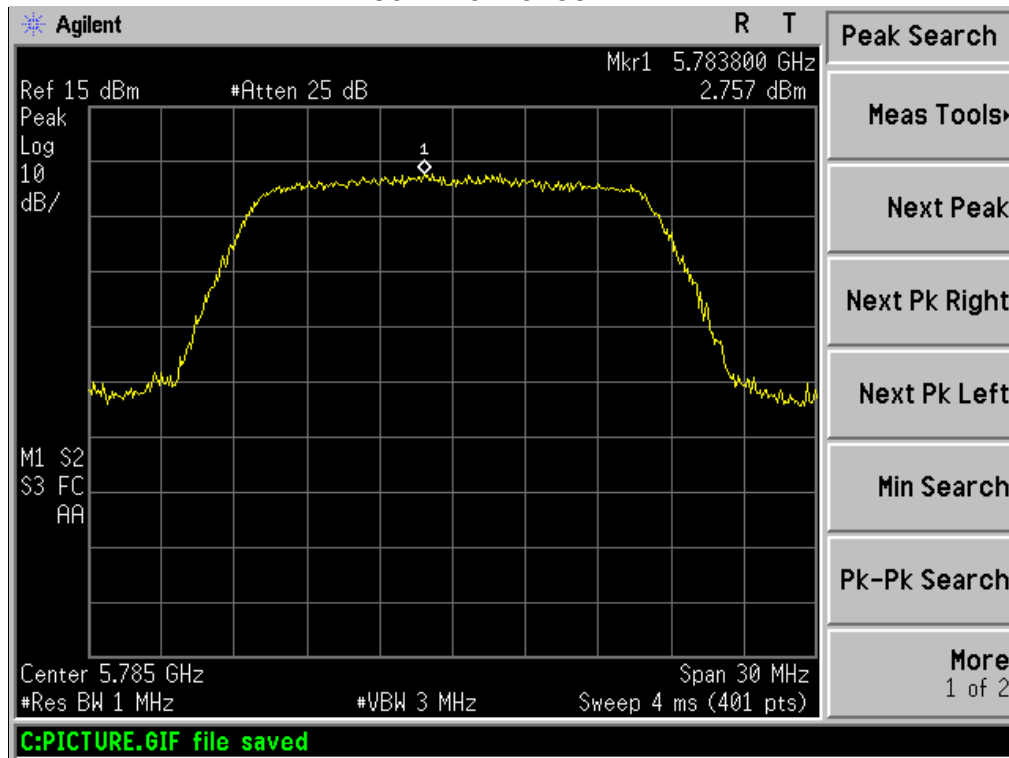

Ant2

802.11a 5825MHz

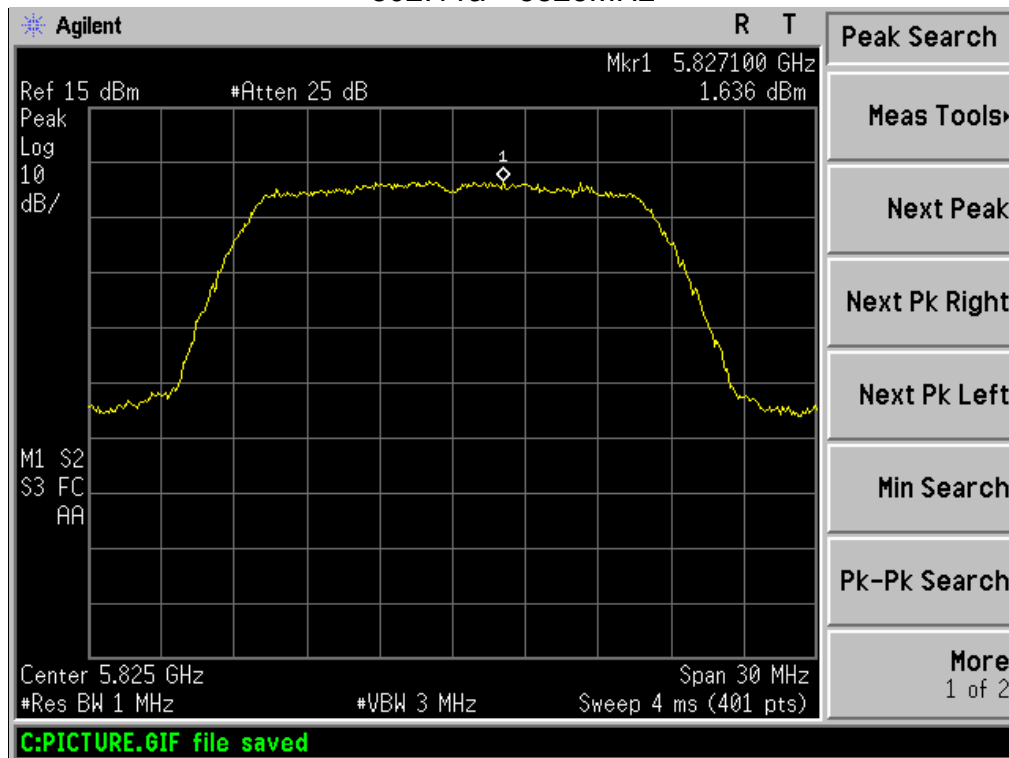

Ant2

802.11n(HT20) 5180MHz

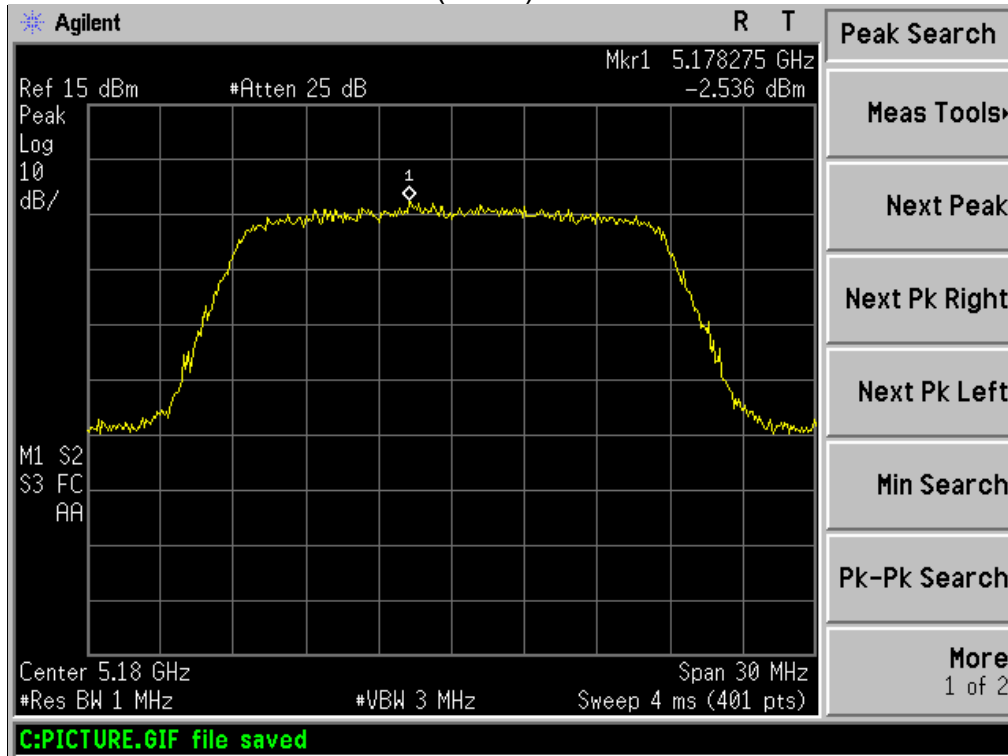

Ant2

802.11n(HT20) 5200MHz

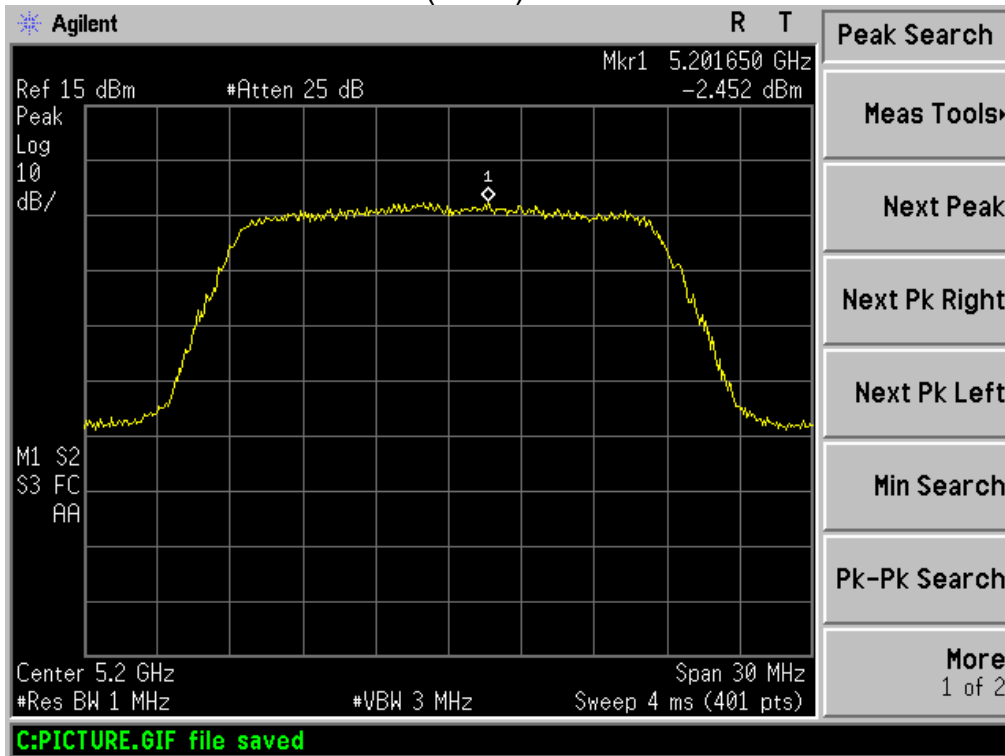

Ant2

802.11n(HT20) 5240MHz

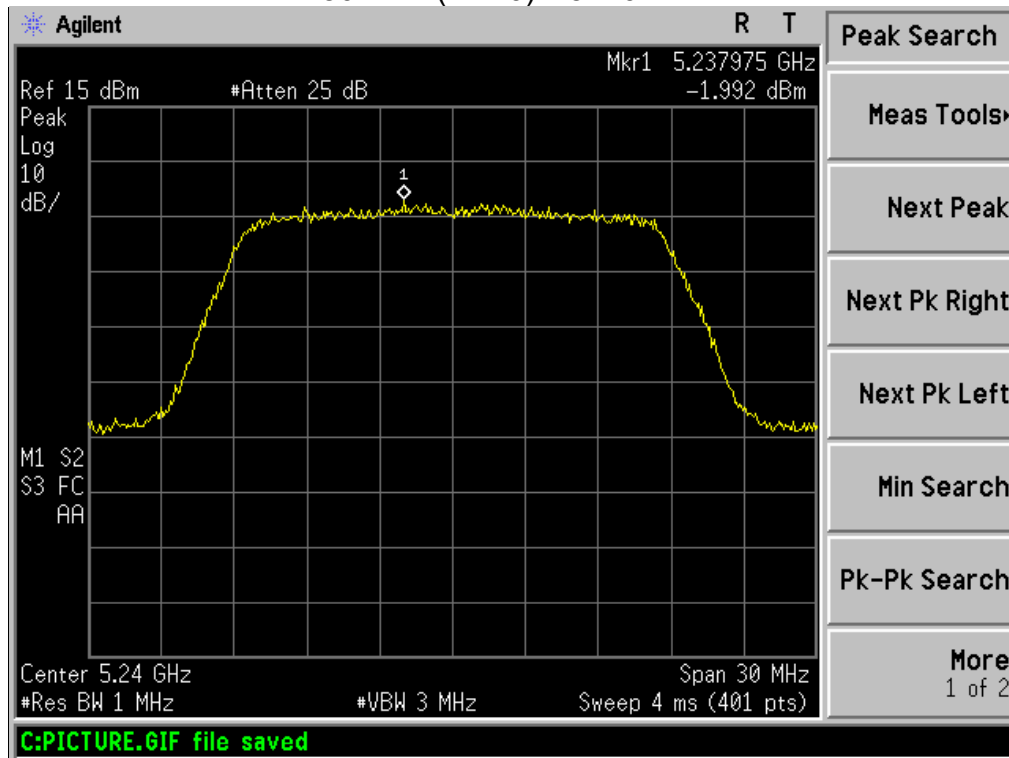

Ant2

802.11n(HT20) 5745MHz

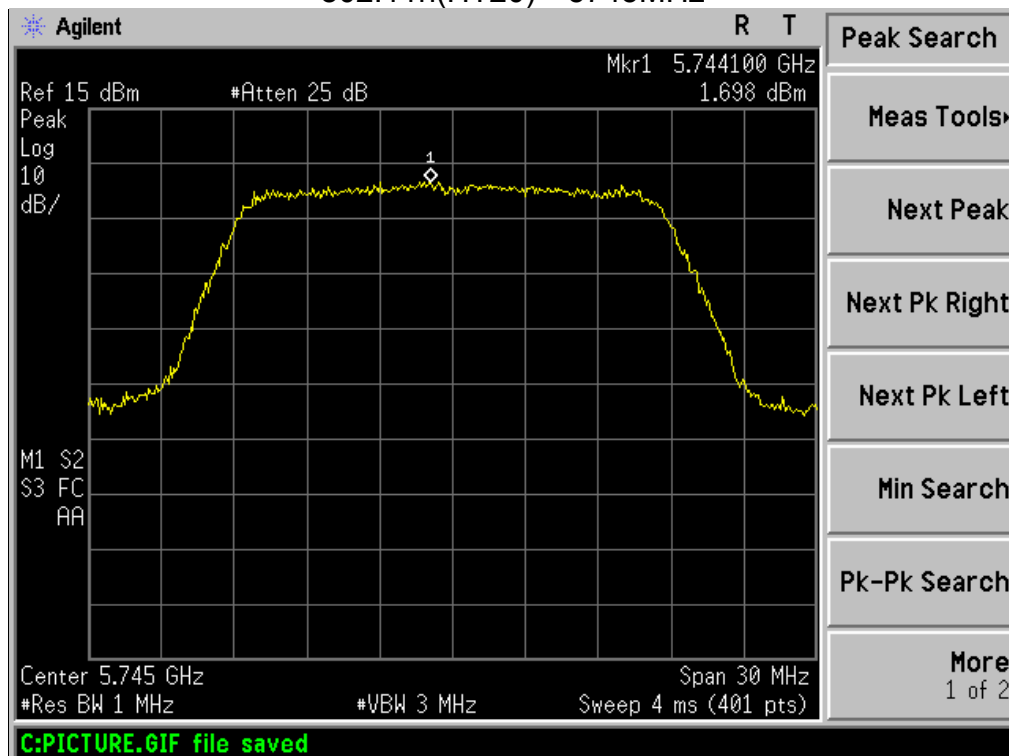

Ant2

802.11n(HT20) 5785MHz

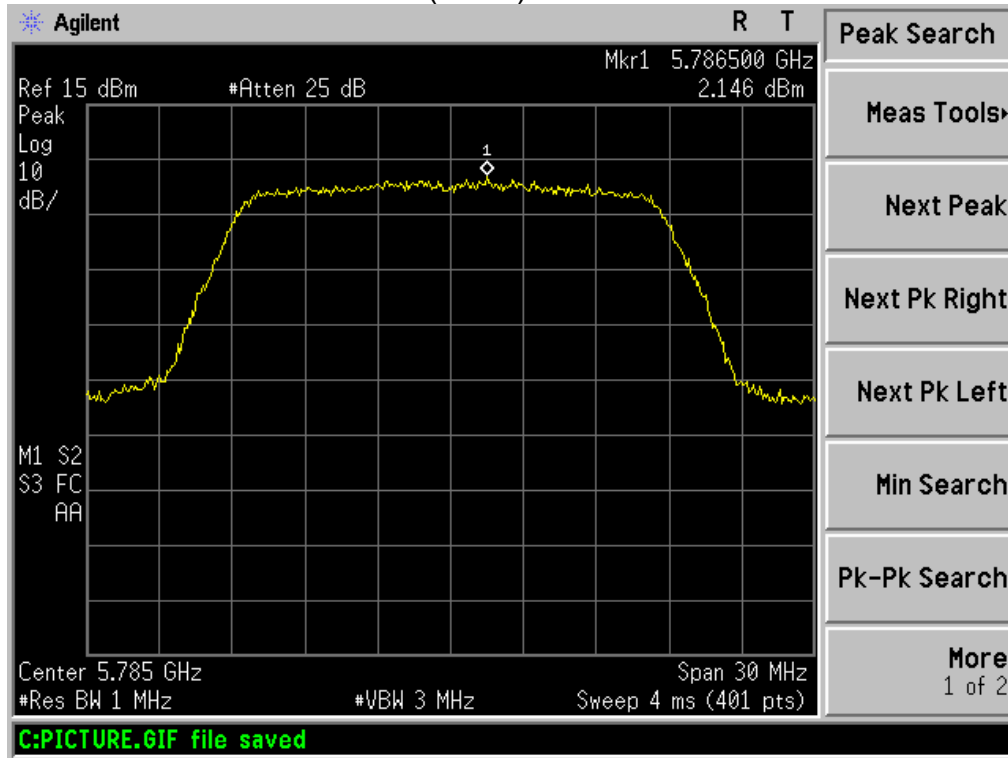

Ant2

802.11n(HT20) 5825MHz

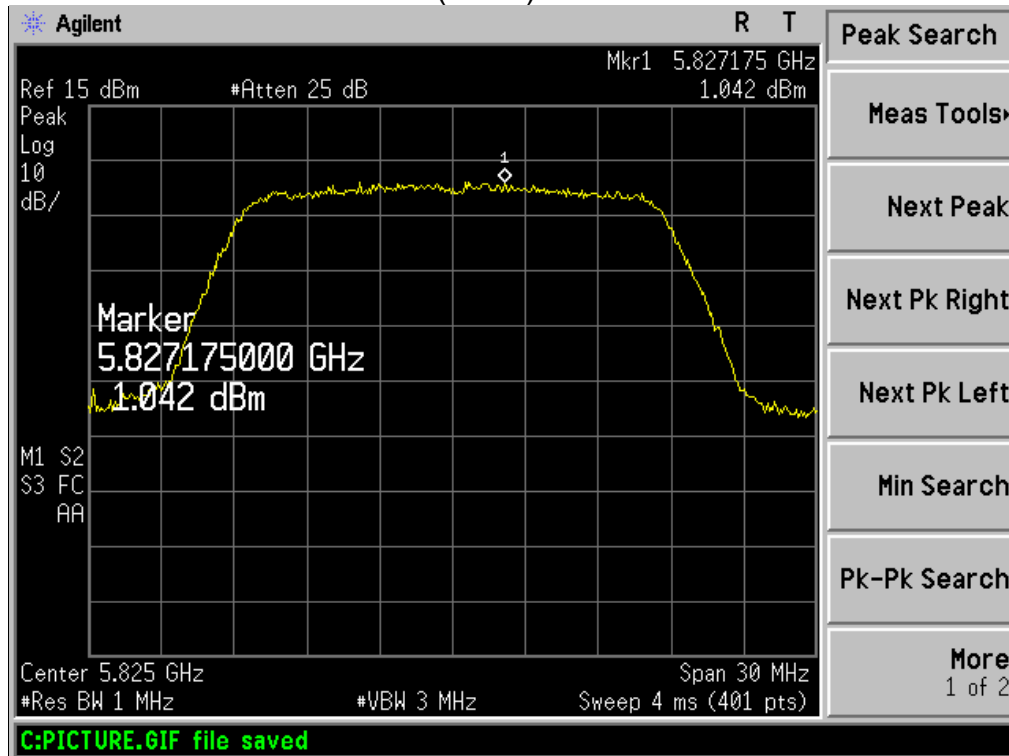



10. DUTY CYCLE TEST SIGNAL

Pre-analysis Check: While conducting average power measurement, duty cycle of each mode shall be checked to ensure its duty cycle in order to compensate for the loss due to insufficient ratio of duty cycle.

All duty cycle is pre-scanned, and result as obtained below shows only the most representative ones where duty cycle is conducted as the given transmission with given virtual operation that expresses the percentage.

Formula:

$$\text{Duty Cycle} = \text{Ton} / (\text{Ton} + \text{Toff})$$

Measurement Procedure:

1. Set span = Zero
2. RBW = 8MHz
3. VBW = 8MHz,
4. Detector = Peak

Duty Cycle:

Operation Mode	Duty Cycle	Duty Fator (dB) $10 * \log (1/ \text{Duty cycle})$
802.11a	100%	0
802.11n(HT20)	100%	0



802.11a

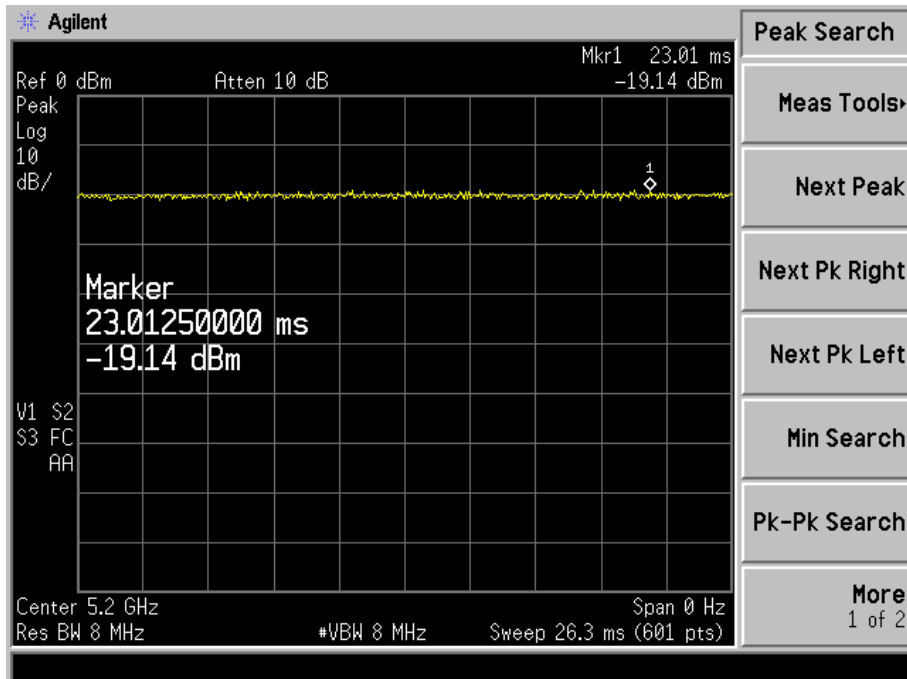
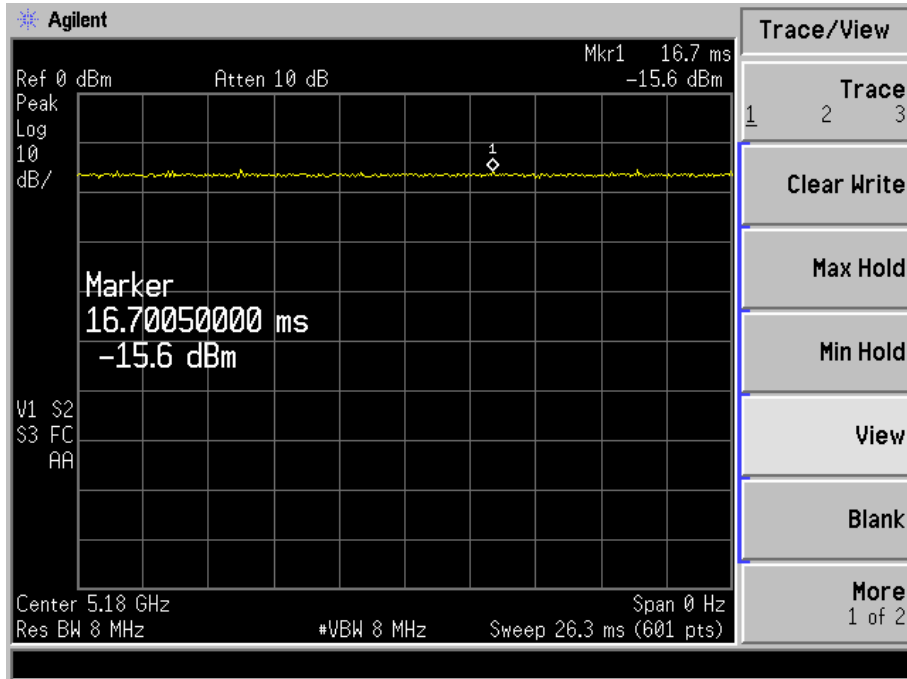

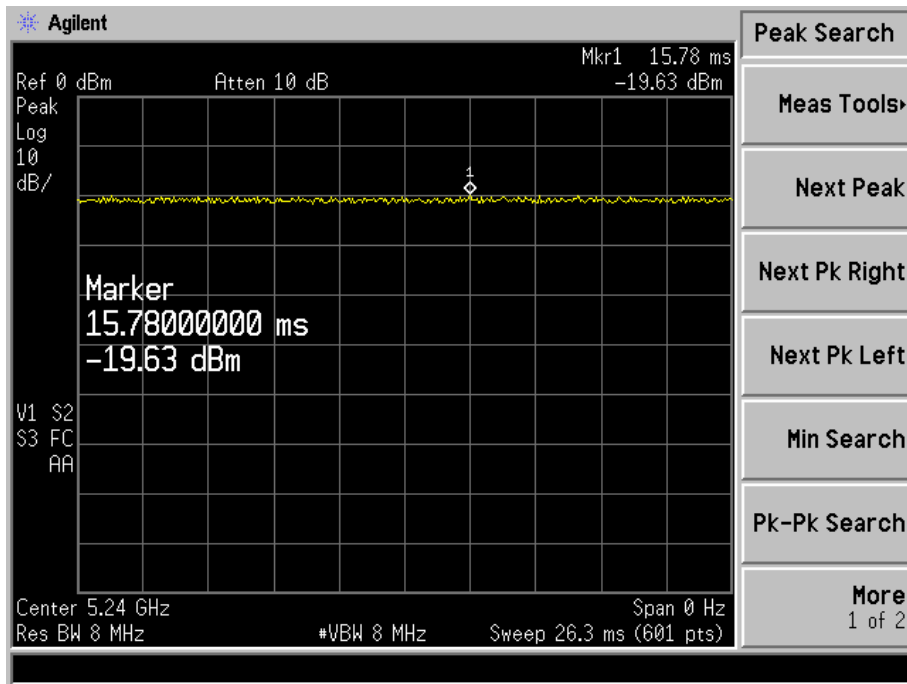

802.11n20

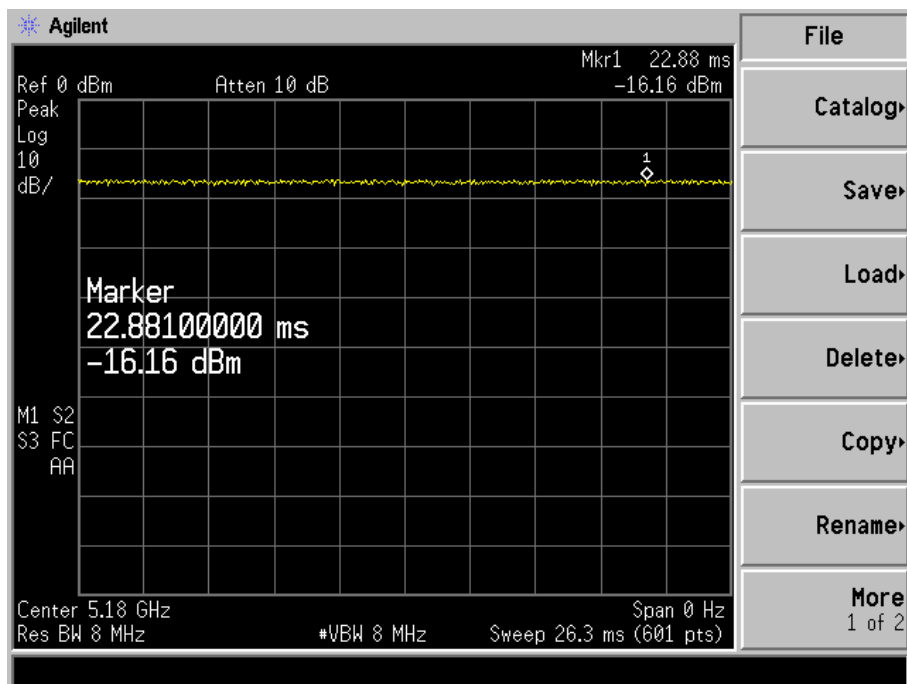

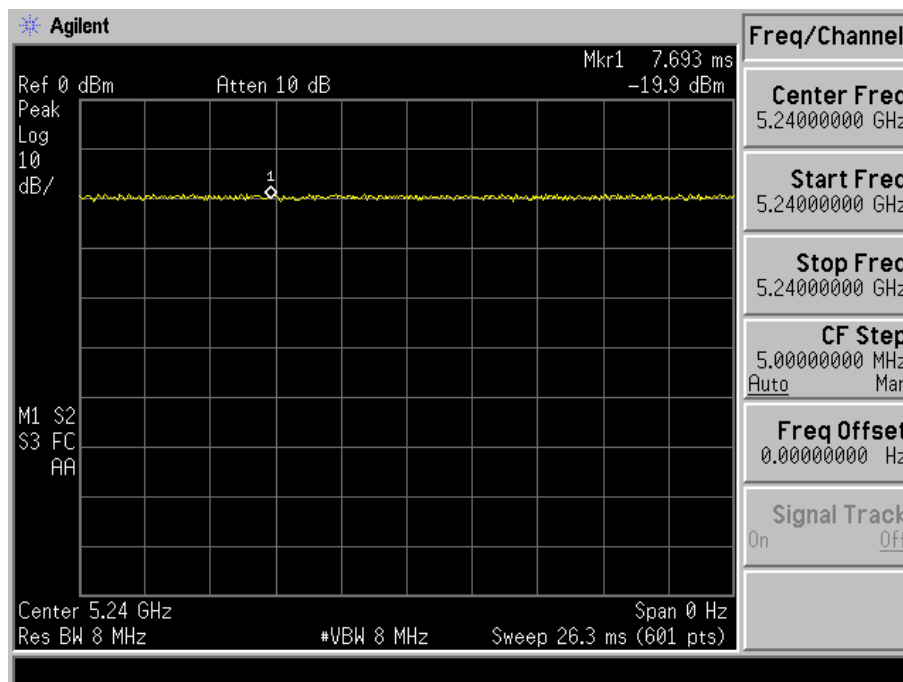
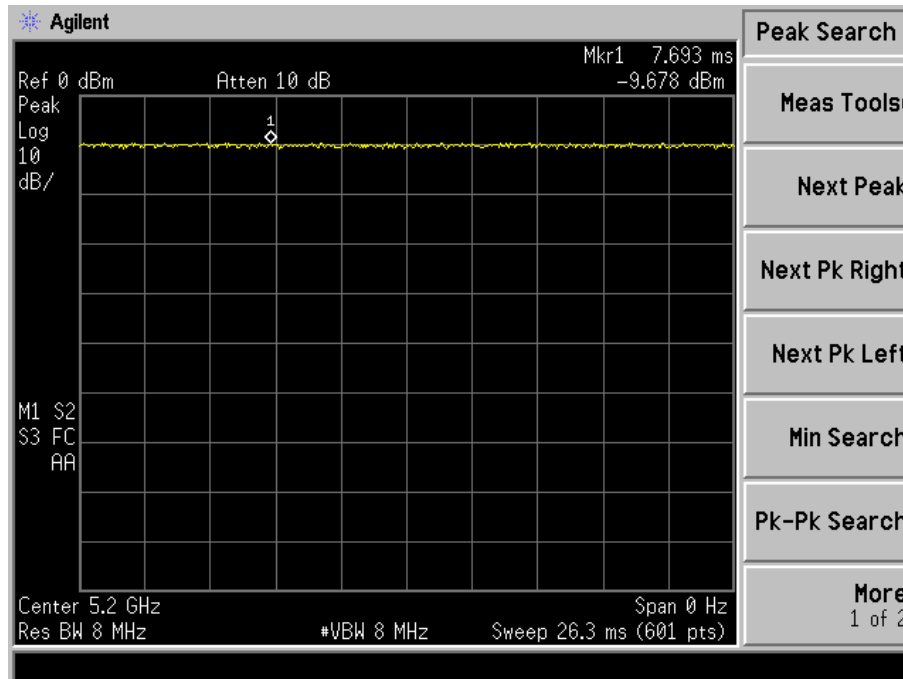

11. FREQUENCY STABILITY

11.1. Limits

Manufacturers of U-NII devices are responsible for ensuring frequency stability such that an emission is maintained within the band of operation under all conditions of normal operation as specified in the user's manual.

The transmitter center frequency tolerance shall be ± 20 ppm maximum for the 5 GHz band (IEEE802.11n specification).

11.2. Test Procedures

1. The transmitter output (antenna port) was connected to the spectrum analyzer.
2. EUT have transmitted absence of modulation signal and fixed channelize.
3. Set the spectrum analyzer span to view the entire absence of modulation emissions bandwidth.
4. Set RBW = 10 kHz, VBW = 10 kHz with peak detector and maxhold settings.
5. f_c is declaring of channel frequency. Then the frequency error formula is $(f_c - f) / f_c \times 10^6$ ppm and the limit is less than ± 20 ppm (IEEE 802.11n specification).
6. The test extreme voltage is to change the primary supply voltage from 85 to 115 percent of the nominal value
7. Extreme temperature is $-20^\circ\text{C} \sim 70^\circ\text{C}$.

11.3. Test Setup Layout

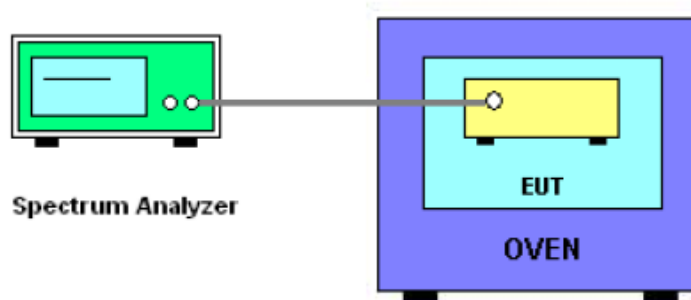

11.4. EUT Operation during Test

The EUT was programmed to be in continuously un-modulation transmitting mode.



11.5. Test Results

Temperature:	25 °C	Relative Humidity:	56%
Pressure:	1015 hPa	Test Voltage :	DC 5V
Test Mode :	Ant.1 TX		

Voltage vs. Frequency Stability

TEST CONDITIONS				Reference Frequency: 5180MHz			
				f	fc	Max. Deviation (MHz)	Max. Deviation (ppm)
T nom (°C)	20	V nom (V)	5.00	5180.01165	5180	0.01165	-2.2490
		V max (V)	5.75	5180.00981	5180	0.00981	-1.8938
		V min (V)	4.25	5180.01171	5180	0.01171	-2.2606
Limits				± 20 ppm			
Result				Complies			

Temperature vs. Frequency Stability

TEST CONDITIONS				Reference Frequency: 5180MHz			
				f	fc	Max. Deviation (MHz)	Max. Deviation (ppm)
V nom (V)	5	T (°C)	-20	5180.00268	5180	0.00268	-0.5174
		T (°C)	-10	5180.00165	5180	0.00165	-0.3185
		T (°C)	0	5180.01682	5180	0.01682	-3.2471
		T (°C)	10	5180.01195	5180	0.01195	-2.3069
		T (°C)	20	5180.01172	5180	0.01172	-2.2625
		T (°C)	30	5180.01271	5180	0.01271	-2.4537
		T (°C)	40	5180.01216	5180	0.01216	-2.3475
		T (°C)	50	5180.01224	5180	0.01224	-2.3629
		T (°C)	60	5180.01319	5180	0.01319	-2.5463
		T (°C)	70	5180.01481	5180	0.01481	-2.8591
Limits				± 20 ppm			
Result				Complies			



Voltage vs. Frequency Stability

TEST CONDITIONS				Reference Frequency: 5200MHz			
				f	fc	Max. Deviation (MHz)	Max. Deviation (ppm)
T nom (°C)	20	V nom (V)	5.00	5200.02264	5200	0.02264	-4.3538
		V max (V)	5.75	5200.02165	5200	0.02165	-4.1635
		V min (V)	4.25	5200.02259	5200	0.02259	-4.3442
Limits				± 20 ppm			
Result				Complies			

Temperature vs. Frequency Stability

TEST CONDITIONS				Reference Frequency: 5200MHz			
				f	fc	Max. Deviation (MHz)	Max. Deviation (ppm)
V nom (V)	5	T (°C)	-20	5200.00218	5200	0.00218	-0.4192
		T (°C)	-10	5200.00619	5200	0.00619	-1.1904
		T (°C)	0	5200.01658	5200	0.01658	-3.1885
		T (°C)	10	5200.01195	5200	0.01195	-2.2981
		T (°C)	20	5200.01752	5200	0.01752	-3.3692
		T (°C)	30	5200.02116	5200	0.02116	-4.0692
		T (°C)	40	5200.02058	5200	0.02058	-3.9577
		T (°C)	50	5200.02568	5200	0.02568	-4.9385
		T (°C)	60	5200.02273	5200	0.02273	-4.3712
		T (°C)	70	5200.02259	5200	0.02259	-4.3442
Limits				± 20 ppm			
Result				Complies			



Voltage vs. Frequency Stability

TEST CONDITIONS				Reference Frequency: 5240MHz			
				f	fc	Max. Deviation (MHz)	Max. Deviation (ppm)
T nom (°C)	20	V nom (V)	5.00	5240.00165	5240	0.00165	-0.3149
		V max (V)	5.75	5240.00118	5240	0.00118	-0.2252
		V min (V)	4.25	5240.00681	5240	0.00681	-1.2996
Limits				± 20 ppm			
Result				Complies			

Temperature vs. Frequency Stability

TEST CONDITIONS				Reference Frequency: 5240MHz			
				f	fc	Max. Deviation (MHz)	Max. Deviation (ppm)
V nom (V)	5	T (°C)	-20	5240.01182	5240	0.01182	-2.2557
		T (°C)	-10	5240.00367	5240	0.00367	-0.7004
		T (°C)	0	5240.01182	5240	0.01182	-2.2557
		T (°C)	10	5240.01219	5240	0.01219	-2.3263
		T (°C)	20	5240.01167	5240	0.01167	-2.2271
		T (°C)	30	5240.01362	5240	0.01362	-2.5992
		T (°C)	40	5240.01229	5240	0.01229	-2.3454
		T (°C)	50	5240.01215	5240	0.01215	-2.3187
		T (°C)	60	5240.00336	5240	0.00336	-0.6412
		T (°C)	70	5240.01216	5240	0.01216	-2.3206
Limits				± 20 ppm			
Result				Complies			



Voltage vs. Frequency Stability

TEST CONDITIONS				Reference Frequency: 5745MHz			
				f	fc	Max. Deviation (MHz)	Max. Deviation (ppm)
T nom (°C)	20	V nom (V)	5.00	5745.01125	5745	0.01125	-1.9582
		V max (V)	5.75	5745.00943	5745	0.00943	-1.6414
		V min (V)	4.25	5745.01152	5745	0.01152	-2.0052
Limits				± 20 ppm			
Result				Complies			

Temperature vs. Frequency Stability

TEST CONDITIONS				Reference Frequency: 5745MHz			
				f	fc	Max. Deviation (MHz)	Max. Deviation (ppm)
V nom (V)	5	T (°C)	-20	5745.00236	5745	0.00236	-0.4108
		T (°C)	-10	5745.00145	5745	0.00145	-0.2524
		T (°C)	0	5745.01361	5745	0.01361	-2.3690
		T (°C)	10	5745.01025	5745	0.01025	-1.7842
		T (°C)	20	5745.01163	5745	0.01163	-2.0244
		T (°C)	30	5745.01264	5745	0.01264	-2.2002
		T (°C)	40	5745.01312	5745	0.01312	-2.2837
		T (°C)	50	5745.01247	5745	0.01247	-2.1706
		T (°C)	60	5745.01318	5745	0.01318	-2.2942
		T (°C)	70	5745.01451	5745	0.01451	-2.5257
Limits				± 20 ppm			
Result				Complies			



Voltage vs. Frequency Stability

TEST CONDITIONS				Reference Frequency: 5785MHz			
				f	fc	Max. Deviation (MHz)	Max. Deviation (ppm)
T nom (°C)	20	V nom (V)	5.00	5785.02264	5785	0.02264	-3.9136
		V max (V)	5.75	5785.02165	5785	0.02165	-3.7424
		V min (V)	4.25	5785.02259	5785	0.02259	-3.9049
Limits				± 20 ppm			
Result				Complies			

Temperature vs. Frequency Stability

TEST CONDITIONS				Reference Frequency: 5785MHz			
				f	fc	Max. Deviation (MHz)	Max. Deviation (ppm)
V nom (V)	5	T (°C)	-20	5785.00169	5785	0.00169	-0.2921
		T (°C)	-10	5785.00412	5785	0.00412	-0.7122
		T (°C)	0	5785.01357	5785	0.01357	-2.3457
		T (°C)	10	5785.01136	5785	0.01136	-1.9637
		T (°C)	20	5785.01157	5785	0.01157	-2.0000
		T (°C)	30	5785.02145	5785	0.02145	-3.7079
		T (°C)	40	5785.02074	5785	0.02074	-3.5851
		T (°C)	50	5785.01568	5785	0.01568	-2.7105
		T (°C)	60	5785.02562	5785	0.02562	-4.4287
		T (°C)	70	5785.02154	5785	0.02154	-3.7234
Limits				± 20 ppm			
Result				Complies			



Voltage vs. Frequency Stability

TEST CONDITIONS				Reference Frequency: 5825MHz			
				f	fc	Max. Deviation (MHz)	Max. Deviation (ppm)
T nom (°C)	20	V nom (V)	5.00	5825.00234	5825	0.00234	-0.4017
		V max (V)	5.75	5825.00188	5825	0.00188	-0.3227
		V min (V)	4.25	5825.00696	5825	0.00696	-1.1948
Limits				± 20 ppm			
Result				Complies			

Temperature vs. Frequency Stability

TEST CONDITIONS				Reference Frequency: 5825MHz			
				f	fc	Max. Deviation (MHz)	Max. Deviation (ppm)
V nom (V)	5	T (°C)	-20	5825.01145	5825	0.01145	-1.9657
		T (°C)	-10	5825.00336	5825	0.00336	-0.5768
		T (°C)	0	5825.01171	5825	0.01171	-2.0103
		T (°C)	10	5825.01226	5825	0.01226	-2.1047
		T (°C)	20	5825.01146	5825	0.01146	-1.9674
		T (°C)	30	5825.01325	5825	0.01325	-2.2747
		T (°C)	40	5825.01236	5825	0.01236	-2.1219
		T (°C)	50	5825.01342	5825	0.01342	-2.3039
		T (°C)	60	5825.00334	5825	0.00334	-0.5734
		T (°C)	70	5825.01314	5825	0.01314	-2.2558
Limits				± 20 ppm			
Result				Complies			



Temperature:	25 °C	Relative Humidity:	56%
Pressure:	1015 hPa	Test Voltage :	DC 5V
Test Mode :	Ant.2 TX		

Voltage vs. Frequency Stability

TEST CONDITIONS				Reference Frequency: 5180MHz			
				f	fc	Max. Deviation (MHz)	Max. Deviation (ppm)
T nom (°C)	20	V nom (V)	5.00	5180.01234	5180	0.01234	-2.3822
		V max (V)	5.75	5180.00756	5180	0.00756	-1.4595
		V min (V)	4.25	5180.01134	5180	0.01134	-2.1892
Limits				± 20 ppm			
Result				Complies			

Temperature vs. Frequency Stability

TEST CONDITIONS				Reference Frequency: 5180MHz			
				f	fc	Max. Deviation (MHz)	Max. Deviation (ppm)
V nom (V)	5	T (°C)	-20	5180.00154	5180	0.00154	-0.2973
		T (°C)	-10	5180.00178	5180	0.00178	-0.3436
		T (°C)	0	5180.01563	5180	0.01563	-3.0174
		T (°C)	10	5180.01142	5180	0.01142	-2.2046
		T (°C)	20	5180.01162	5180	0.01162	-2.2432
		T (°C)	30	5180.01258	5180	0.01258	-2.4286
		T (°C)	40	5180.01212	5180	0.01212	-2.3398
		T (°C)	50	5180.01243	5180	0.01243	-2.3996
		T (°C)	60	5180.01319	5180	0.01319	-2.5463
		T (°C)	70	5180.01424	5180	0.01424	-2.7490
Limits				± 20 ppm			
Result				Complies			



Voltage vs. Frequency Stability

TEST CONDITIONS				Reference Frequency: 5200MHz			
				f	fc	Max. Deviation (MHz)	Max. Deviation (ppm)
T nom (°C)	20	V nom (V)	5.00	5200.02152	5200	0.02152	-4.1385
		V max (V)	5.75	5200.02144	5200	0.02144	-4.1231
		V min (V)	4.25	5200.02251	5200	0.02251	-4.3288
Limits				± 20 ppm			
Result				Complies			

Temperature vs. Frequency Stability

TEST CONDITIONS				Reference Frequency: 5200MHz			
				f	fc	Max. Deviation (MHz)	Max. Deviation (ppm)
V nom (V)	5	T (°C)	-20	5200.00205	5200	0.00205	-0.3942
		T (°C)	-10	5200.00536	5200	0.00536	-1.0308
		T (°C)	0	5200.01652	5200	0.01652	-3.1769
		T (°C)	10	5200.01207	5200	0.01207	-2.3212
		T (°C)	20	5200.01742	5200	0.01742	-3.3500
		T (°C)	30	5200.02311	5200	0.02311	-4.4442
		T (°C)	40	5200.02157	5200	0.02157	-4.1481
		T (°C)	50	5200.02458	5200	0.02458	-4.7269
		T (°C)	60	5200.02233	5200	0.02233	-4.2942
		T (°C)	70	5200.02235	5200	0.02235	-4.2981
Limits				± 20 ppm			
Result				Complies			



Voltage vs. Frequency Stability

TEST CONDITIONS				Reference Frequency: 5240MHz			
				f	fc	Max. Deviation (MHz)	Max. Deviation (ppm)
T nom (°C)	20	V nom (V)	5.00	5240.00142	5240	0.00142	-0.2710
		V max (V)	5.75	5240.00127	5240	0.00127	-0.2424
		V min (V)	4.25	5240.00493	5240	0.00493	-0.9408
Limits				± 20 ppm			
Result				Complies			

Temperature vs. Frequency Stability

TEST CONDITIONS				Reference Frequency: 5240MHz			
				f	fc	Max. Deviation (MHz)	Max. Deviation (ppm)
V nom (V)	5	T (°C)	-20	5240.01234	5240	0.01234	-2.3550
		T (°C)	-10	5240.00349	5240	0.00349	-0.6660
		T (°C)	0	5240.01154	5240	0.01154	-2.2023
		T (°C)	10	5240.01247	5240	0.01247	-2.3798
		T (°C)	20	5240.01136	5240	0.01136	-2.1679
		T (°C)	30	5240.01324	5240	0.01324	-2.5267
		T (°C)	40	5240.01234	5240	0.01234	-2.3550
		T (°C)	50	5240.01147	5240	0.01147	-2.1889
		T (°C)	60	5240.00317	5240	0.00317	-0.6044
		T (°C)	70	5240.01132	5240	0.01132	-2.1603
Limits				± 20 ppm			
Result				Complies			



Voltage vs. Frequency Stability

TEST CONDITIONS				Reference Frequency: 5745MHz			
				f	fc	Max. Deviation (MHz)	Max. Deviation (ppm)
T nom (°C)	20	V nom (V)	5.00	5745.01131	5745	0.01131	-1.9687
		V max (V)	5.75	5745.00463	5745	0.00463	-0.8059
		V min (V)	4.25	5745.01290	5745	0.01290	-2.2454
Limits				± 20 ppm			
Result				Complies			

Temperature vs. Frequency Stability

TEST CONDITIONS				Reference Frequency: 5745MHz			
				f	fc	Max. Deviation (MHz)	Max. Deviation (ppm)
V nom (V)	5	T (°C)	-20	5745.00129	5745	0.00129	-0.2245
		T (°C)	-10	5745.00142	5745	0.00142	-0.2472
		T (°C)	0	5745.01344	5745	0.01344	-2.3394
		T (°C)	10	5745.01016	5745	0.01016	-1.7685
		T (°C)	20	5745.01213	5745	0.01213	-2.1114
		T (°C)	30	5745.01306	5745	0.01306	-2.2733
		T (°C)	40	5745.01271	5745	0.01271	-2.2124
		T (°C)	50	5745.01134	5745	0.01134	-1.9739
		T (°C)	60	5745.01463	5745	0.01463	-2.5466
		T (°C)	70	5745.01542	5745	0.01542	-2.6841
Limits				± 20 ppm			
Result				Complies			



Voltage vs. Frequency Stability

TEST CONDITIONS				Reference Frequency: 5785MHz			
				f	fc	Max. Deviation (MHz)	Max. Deviation (ppm)
T nom (°C)	20	V nom (V)	5.00	5785.01286	5785	0.01286	-2.2230
		V max (V)	5.75	5785.02123	5785	0.02123	-3.6698
		V min (V)	4.25	5785.02054	5785	0.02054	-3.5506
Limits				± 20 ppm			
Result				Complies			

Temperature vs. Frequency Stability

TEST CONDITIONS				Reference Frequency: 5785MHz			
				f	fc	Max. Deviation (MHz)	Max. Deviation (ppm)
V nom (V)	5	T (°C)	-20	5785.01075	5785	0.01075	-1.8583
		T (°C)	-10	5785.00648	5785	0.00648	-1.1201
		T (°C)	0	5785.01432	5785	0.01432	-2.4754
		T (°C)	10	5785.01035	5785	0.01035	-1.7891
		T (°C)	20	5785.01141	5785	0.01141	-1.9723
		T (°C)	30	5785.02170	5785	0.02170	-3.7511
		T (°C)	40	5785.01986	5785	0.01986	-3.4330
		T (°C)	50	5785.01736	5785	0.01736	-3.0009
		T (°C)	60	5785.02232	5785	0.02232	-3.8583
		T (°C)	70	5785.02166	5785	0.02166	-3.7442
Limits				± 20 ppm			
Result				Complies			



Voltage vs. Frequency Stability

TEST CONDITIONS				Reference Frequency: 5825MHz			
				f	fc	Max. Deviation (MHz)	Max. Deviation (ppm)
T nom (°C)	20	V nom (V)	5.00	5825.00197	5825	0.00197	-0.3382
		V max (V)	5.75	5825.00139	5825	0.00139	-0.2386
		V min (V)	4.25	5825.00724	5825	0.00724	-1.2429
Limits				± 20 ppm			
Result				Complies			

Temperature vs. Frequency Stability

TEST CONDITIONS				Reference Frequency: 5825MHz			
				f	fc	Max. Deviation (MHz)	Max. Deviation (ppm)
V nom (V)	5	T (°C)	-20	5825.02011	5825	0.02011	-3.4524
		T (°C)	-10	5825.00451	5825	0.00451	-0.7742
		T (°C)	0	5825.01085	5825	0.01085	-1.8627
		T (°C)	10	5825.01120	5825	0.01120	-1.9227
		T (°C)	20	5825.02076	5825	0.02076	-3.5639
		T (°C)	30	5825.01527	5825	0.01527	-2.6215
		T (°C)	40	5825.01530	5825	0.01530	-2.6266
		T (°C)	50	5825.01169	5825	0.01169	-2.0069
		T (°C)	60	5825.00427	5825	0.00427	-0.7330
		T (°C)	70	5825.01094	5825	0.01094	-1.8781
Limits				± 20 ppm			
Result				Complies			



12. TRANSMISSION IN THE ABSENCE OF DATA

12.1. Limits

According to §15.407(c)

The device shall automatically discontinue transmission in case of either absence of information to transmit or operational failure. These provisions are not intended to preclude the transmission of control or signaling information or the use of repetitive codes used by certain digital technologies to complete frame or burst intervals. Applicants shall include in their application for equipment authorization a description of how this requirement is met.

12.2. Test result

No non-compliance noted:

Refer to the theory of operation.



13. ANTENNA REQUIREMENT

13.1. STANDARD REQUIREMENT

15.203 requirement: For intentional device, according to 15.203: an intentional radiator shall be designed to ensure that no antenna other than that furnished by the responsible party shall be used with the device.

13.2. EUT ANTENNA

The EUT antenna is PCB antenna, It comply with the standard requirement.

14. PHOTOGRAPHS OF TEST SET-UP

Conducted Emission Photos



Radiated Emission Test

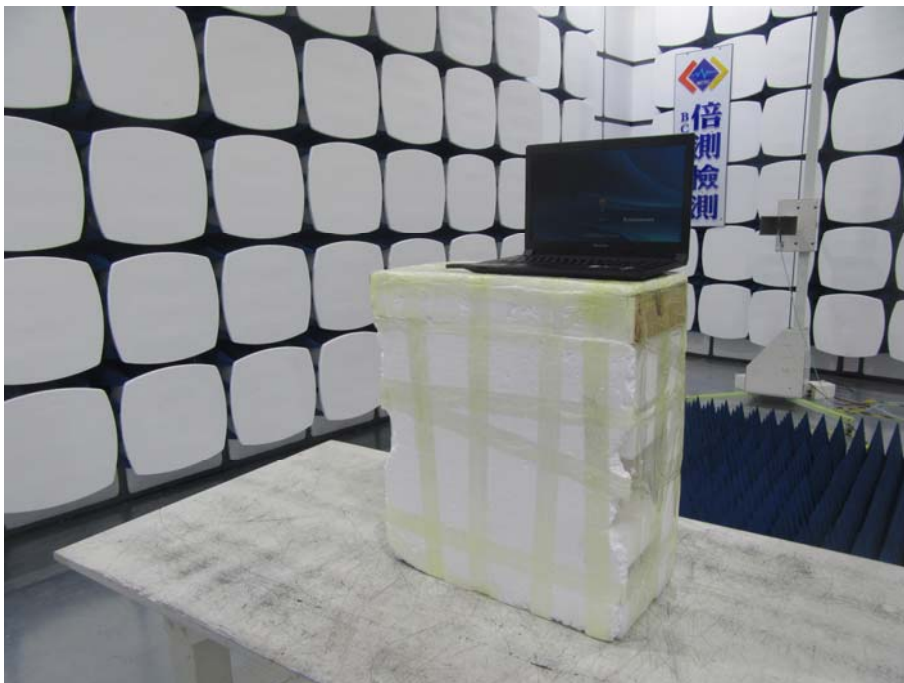

15. PHOTOGRAPHS OF THE EUT



-----END-----