



FCC TEST REPORT (15.407)

REPORT NO.: RF130924C01B-1

MODEL NO.: RNX-AC1200UB

FCC ID: W6RRNX-AC1200UB

RECEIVED: Sep. 24, 2013

TESTED: Oct. 17 ~ Nov. 22, 2013

ISSUED: Mar. 31, 2015

APPLICANT: Rosewill Inc.

ADDRESS: 17708 Rowland Street, City of Industry, CA
91748, USA

ISSUED BY: Bureau Veritas Consumer Products Services
(H.K.) Ltd., Taoyuan Branch

LAB ADDRESS: No. 47-2, 14th Ling, Chia Pau Vil., Lin Kou Dist.,
New Taipei City, Taiwan, R.O.C.

TEST LOCATION: No. 19, Hwa Ya 2nd Rd., Wen Hwa Vil., Kwei
Shan Dist., Taoyuan City 33383, Taiwan, R.O.C.

This report should not be used by the client to claim product certification, approval, or endorsement by TAF or any government agencies.



This report is for your exclusive use. Any copying or replication of this report to or for any other person or entity, or use of our name or trademark, is permitted only with our prior written permission. This report sets forth our findings solely with respect to the test samples identified herein. The results set forth in this report are not indicative or representative of the quality or characteristics of the lot from which a test sample was taken or any similar or identical product unless specifically and expressly noted. Our report includes all of the tests requested by you and the results thereof based upon the information that you provided to us. You have 60 days from date of issuance of this report to notify us of any material error or omission caused by our negligence, provided, however, that such notice shall be in writing and shall specifically address the issue you wish to raise. A failure to raise such issue within the prescribed time shall constitute your unqualified acceptance of the completeness of this report, the tests conducted and the correctness of the report contents. Unless specific mention, the uncertainty of measurement has been explicitly taken into account to declare the compliance or non-compliance to the specification.



TABLE OF CONTENTS

RELEASE CONTROL RECORD	4
1. CERTIFICATION	5
2. SUMMARY OF TEST RESULTS	6
2.1 MEASUREMENT UNCERTAINTY	6
3. GENERAL INFORMATION	7
3.1 GENERAL DESCRIPTION OF EUT	7
3.2 DESCRIPTION OF TEST MODES	9
3.2.1 TEST MODE APPLICABILITY AND TESTED CHANNEL DETAIL	11
3.3 DUTY CYCLE OF TEST SIGNAL	13
3.4 DESCRIPTION OF SUPPORT UNITS	17
3.4.1 CONFIGURATION OF SYSTEM UNDER TEST	17
3.5 GENERAL DESCRIPTION OF APPLIED STANDARDS	18
4. TEST TYPES AND RESULTS	19
4.1 RADIATED EMISSION AND BANDEDGE MEASUREMENT	19
4.1.1 LIMITS OF RADIATED EMISSION AND BANDEDGE MEASUREMENT	19
4.1.2 LIMITS OF UNWANTED EMISSION OUT OF THE RESTRICTED BANDS	19
4.1.3 TEST INSTRUMENTS	20
4.1.4 TEST PROCEDURES	21
4.1.5 DEVIATION FROM TEST STANDARD	21
4.1.6 TEST SETUP	22
4.1.7 EUT OPERATING CONDITION	23
4.1.8 TEST RESULTS	24
4.2 CONDUCTED EMISSION MEASUREMENT	53
4.2.1 LIMITS OF CONDUCTED EMISSION MEASUREMENT	53
4.2.2 TEST INSTRUMENTS	53
4.2.3 TEST PROCEDURES	54
4.2.4 DEVIATION FROM TEST STANDARD	54
4.2.5 TEST SETUP	54
4.2.6 EUT OPERATING CONDITIONS	54
4.2.7 TEST RESULTS	55
4.3 PEAK TRANSMIT POWER MEASUREMENT	57
4.3.1 LIMITS OF PEAK TRANSMIT POWER MEASUREMENT	57
4.3.2 TEST SETUP	57
4.3.3 TEST INSTRUMENTS	58
4.3.4 TEST PROCEDURE	58
4.3.5 DEVIATION FROM TEST STANDARD	59
4.3.6 EUT OPERATING CONDITIONS	59
4.3.7 TEST RESULTS	60
4.4 PEAK POWER SPECTRAL DENSITY MEASUREMENT	68
4.4.1 LIMITS OF PEAK POWER SPECTRAL DENSITY MEASUREMENT	68
4.4.2 TEST SETUP	68
4.4.3 TEST INSTRUMENTS	68
4.4.4 TEST PROCEDURES	68
4.4.5 DEVIATION FROM TEST STANDARD	68
4.4.6 EUT OPERATING CONDITIONS	68
4.4.7 TEST RESULTS	69
4.5 PEAK POWER EXCURSION MEASUREMENT	73
4.5.1 LIMITS OF PEAK POWER EXCURSION MEASUREMENT	73
4.5.2 TEST SETUP	73
4.5.3 TEST INSTRUMENTS	73



A D T

4.5.4	TEST PROCEDURE.....	73
4.5.5	DEVIATION FROM TEST STANDARD	73
4.5.6	EUT OPERATING CONDITIONS	73
4.5.7	TEST RESULTS	74
4.6	FREQUENCY STABILITY.....	75
4.6.1	LIMITS OF FREQUENCY STABILITY MEASUREMENT	75
4.6.2	TEST SETUP	75
4.6.3	TEST INSTRUMENTS.....	75
4.6.4	TEST PROCEDURE.....	76
4.6.5	DEVIATION FROM TEST STANDARD	76
4.6.6	EUT OPERATING CONDITION.....	76
4.6.7	TEST RESULTS	77
4.7	20dBC BANDWIDTH MEASUREMENT	78
4.7.1	LIMITS OF PEAK TRANSMIT POWER MEASUREMENT	78
4.7.2	TEST SETUP	78
4.7.3	TEST INSTRUMENTS.....	78
4.7.4	TEST PROCEDURE.....	78
4.7.5	TEST RESULTS	79
5.	PHOTOGRAPHS OF THE TEST CONFIGURATION.....	87
6.	INFORMATION ON THE TESTING LABORATORIES	88
7.	APPENDIX A – MODIFICATIONS RECORDERS FOR ENGINEERING CHANGES TO THE EUT BY THE LAB.....	89



A D T

RELEASE CONTROL RECORD

ISSUE NO.	REASON FOR CHANGE	DATE ISSUED
RF130924C01B-1	Original release	Mar. 31, 2015



1. CERTIFICATION

PRODUCT: AC1200 Wireless Dual Band Adapter

MODEL: RNX-AC1200UB

BRAND: Newegg

APPLICANT: Rosewill Inc.

TESTED: Oct. 17 ~ Nov. 22, 2013

TEST SAMPLE: PRODUCTION SAMPLE

STANDARDS: FCC Part 15, Subpart E (Section 15.407)

ANSI C63.10-2009

The above equipment (model: RNX-AC1200UB) has been tested by **Bureau Veritas Consumer Products Services (H.K.) Ltd., Taoyuan Branch**, and found compliance with the requirement of the above standards. The test record, data evaluation & Equipment Under Test (EUT) configurations represented herein are true and accurate accounts of the measurements of the sample's EMC characteristics under the conditions specified in this report.

PREPARED BY : Celine Chou , **DATE :** Mar. 31, 2015
Celine Chou / Specialist

APPROVED BY : Ken Liu , **DATE :** Mar. 31, 2015
Ken Liu / Senior Manager

2. SUMMARY OF TEST RESULTS

The EUT has been tested according to the following specifications:

APPLIED STANDARD: FCC PART 15, SUBPART E (SECTION 15.407 UNDER OLD RULE)			
STANDARD SECTION	TEST TYPE	RESULT	REMARK
15.407(b)(6)	AC Power Conducted Emission	PASS	Meet the requirement of limit. Minimum passing margin is -11.22dB at 20.75179MHz.
15.407(b/1/2/3) (b)(6)	Radiated Emissions	PASS	Meet the requirement of limit. Minimum passing margin is -1.2dB at 5350.00MHz.
15.407(a/1/2)	Max Average Transmit Power	PASS	Meet the requirement of limit.
15.407(a)(6)	Peak Power Excursion	PASS	Meet the requirement of limit.
15.407(a/1/2)	Peak Power Spectral Density	PASS	Meet the requirement of limit.
15.407(g)	Frequency Stability	PASS	Meet the requirement of limit.
15.203	Antenna Requirement	PASS	No antenna connector is used.

2.1 MEASUREMENT UNCERTAINTY

Where relevant, the following measurement uncertainty levels have been estimated for tests performed on the EUT as specified in CISPR 16-4-2:

MEASUREMENT	FREQUENCY	UNCERTAINTY
Conducted emissions	9kHz~30MHz	2.44 dB
Radiated emissions	30MHz ~ 200MHz	3.19 dB
	200MHz ~1000MHz	3.21 dB
	1GHz ~ 18GHz	2.26 dB
	18GHz ~ 40GHz	1.94 dB

This uncertainty represents an expanded uncertainty expressed at approximately the 95% confidence level using a coverage factor of $k = 2$.

3. GENERAL INFORMATION

3.1 GENERAL DESCRIPTION OF EUT

EUT	AC1200 Wireless Dual Band Adapter
MODEL NO.	RNX-AC1200UB
POWER SUPPLY	5Vdc (host equipment)
MODULATION TYPE	256QAM, 64QAM, 16QAM, QPSK, BPSK
MODULATION TECHNOLOGY	OFDM
TRANSFER RATE	802.11a: 54.0/ 48.0/ 36.0/ 24.0/ 18.0/ 12.0/ 9.0/ 6.0Mbps 802.11n: up to 300Mbps 802.11ac: up to 867Mbps
OPERATING FREQUENCY	5180 ~ 5240MHz, 5260 ~ 5320MHz & 5500 ~ 5700MHz
NUMBER OF CHANNEL	5180 ~ 5240MHz: 4 for 802.11a, 802.11n (20MHz) 2 for 802.11n (40MHz) 1 for 802.11ac (80MHz) 5260 ~ 5320MHz: 4 for 802.11a, 802.11n (20MHz) 2 for 802.11n (40MHz) 1 for 802.11ac (80MHz) 5500 ~ 5700MHz: 8 for 802.11a, 802.11n (20MHz) 3 for 802.11n (40MHz) 1 for 802.11ac (80MHz)
OUTPUT POWER	48.542mW for 5180 ~ 5240MHz 77.030mW for 5260 ~ 5320MHz 77.541mW for 5500 ~ 5700MHz
ANTENNA TYPE	Refer to Note as below
ANTENNA CONNECTOR	Refer to Note as below
DATA CABLE	N/A
I/O PORTS	Refer to user's manual
ACCESSORY DEVICES	N/A

NOTE:

- The EUT incorporates a MIMO function. Physically, the EUT provides two completed transmitters and two receivers.

MODULATION MODE	TX FUNCTION
802.11b	1TX
802.11g	1TX
802.11a	1TX
802.11n (20MHz)	2TX
802.11n (40MHz)	2TX
802.11ac (80MHz)	2TX



2. The EUT uses following antennas.

Frequency (GHz)	Antenna Type	Gain (dBi)		Antenna Connector
		Ant. 1	Ant. 2	
2.4~2.4835	PCB	1.41	-0.03	NA
5.15~5.25	PCB	3.27	3.45	NA
5.25~5.35	PCB	3.15	3.59	NA
5.47~5.725	PCB	3.29	4.24	NA
5.725~5.85	PCB	3.49	4.13	NA

3. The above EUT information is declared by manufacturer and for more detailed features description, please refer to the manufacturer's specifications or user's manual.

3.2 DESCRIPTION OF TEST MODES

FOR 5180 ~ 5240MHz

4 channels are provided for 802.11a, 802.11n (20MHz):

CHANNEL	FREQUENCY	CHANNEL	FREQUENCY
36	5180 MHz	44	5220 MHz
40	5200 MHz	48	5240 MHz

2 channels are provided for 802.11n (40MHz):

CHANNEL	FREQUENCY	CHANNEL	FREQUENCY
38	5190 MHz	46	5230 MHz

1 channel is provided for 802.11ac (80MHz):

CHANNEL	FREQUENCY
42	5210MHz

FOR 5260 ~ 5320MHz

4 channels are provided for 802.11a, 802.11n (20MHz):

CHANNEL	FREQUENCY	CHANNEL	FREQUENCY
52	5260 MHz	60	5300 MHz
56	5280 MHz	64	5320 MHz

2 channels are provided for 802.11n (40MHz):

CHANNEL	FREQUENCY	CHANNEL	FREQUENCY
54	5270 MHz	62	5310 MHz

1 channel is provided for 802.11ac (80MHz):

CHANNEL	FREQUENCY
58	5290MHz



A D T

FOR 5500 ~ 5700MHz

8 channels are provided for 802.11a, 802.11n (20MHz):

CHANNEL	FREQUENCY	CHANNEL	FREQUENCY
100	5500 MHz	116	5580 MHz
104	5520 MHz	132	5660 MHz
108	5540 MHz	136	5680 MHz
112	5560 MHz	140	5700 MHz

3 channels are provided for 802.11n (40MHz):

CHANNEL	FREQUENCY	CHANNEL	FREQUENCY
102	5510 MHz	134	5670 MHz
110	5550 MHz		

1 channel is provided for 802.11ac (80MHz):

CHANNEL	FREQUENCY
106	5530MHz

3.2.1 TEST MODE APPLICABILITY AND TESTED CHANNEL DETAIL

EUT CONFIGURE MODE	APPLICABLE TO				DESCRIPTION
	RE≥1G	RE<1G	PLC	APCM	
-	√	√	√	√	-

Where **RE≥1G**: Radiated Emission above 1GHz **RE<1G**: Radiated Emission below 1GHz
PLC: Power Line Conducted Emission **APCM**: Antenna Port Conducted Measurement

NOTE:

1. 802.11a:

The EUT had been pre-tested on the positioned of each 3 axis. The worst case was found when positioned on **Y-plane**.

2. 802.11n (20MHz), 802.11n (40MHz), 802.11ac (80MHz):

The EUT had been pre-tested on the positioned of each 3 axis. The worst case was found when positioned on **X-plane**.

RADIATED EMISSION TEST (ABOVE 1GHz):

- Pre-Scan has been conducted to determine the worst-case mode from all possible combinations between available modulations, data rates and antenna ports (if EUT with antenna diversity architecture).
- Following channel(s) was (were) selected for the final test as listed below.

EUT CONFIGURE MODE	MODE	FREQ. BAND (MHz)	AVAILABLE CHANNEL	TESTED CHANNEL	MODULATION TECHNOLOGY	MODULATION TYPE	DATA RATE (Mbps)
-	802.11a	5180-5240	36 to 48	36, 40, 48	OFDM	BPSK	6.0
-	802.11n (20MHz)		36 to 48	36, 40, 48	OFDM	BPSK	7.2
-	802.11n (40MHz)		38 to 46	38, 46	OFDM	BPSK	15.0
-	802.11ac (80MHz)		42	42	OFDM	BPSK	65.0
-	802.11a	5260-5320	52 to 64	52, 60, 64	OFDM	BPSK	6.0
-	802.11n (20MHz)		52 to 64	52, 60, 64	OFDM	BPSK	7.2
-	802.11n (40MHz)		54 to 62	54, 62	OFDM	BPSK	15.0
-	802.11ac (80MHz)		58	58	OFDM	BPSK	65.0
-	802.11a	5500-5700	100 to 140	100, 116, 140	OFDM	BPSK	6.0
-	802.11n (20MHz)		100 to 140	100, 116, 140	OFDM	BPSK	7.2
-	802.11n (40MHz)		102 to 134	102, 110, 134	OFDM	BPSK	15.0
-	802.11ac (80MHz)		106	106	OFDM	BPSK	65.0

RADIATED EMISSION TEST (BELOW 1GHz):

- Pre-Scan has been conducted to determine the worst-case mode from all possible combinations between available modulations, data rates and antenna ports (if EUT with antenna diversity architecture).
- Following channel(s) was (were) selected for the final test as listed below.

EUT CONFIGURE MODE	MODE	FREQ. BAND (MHz)	AVAILABLE CHANNEL	TESTED CHANNEL	MODULATION TECHNOLOGY	MODULATION TYPE	DATA RATE (Mbps)
-	802.11n (20MHz)	5500-5700	100 to 140	140	OFDM	BPSK	7.2

POWER LINE CONDUCTED EMISSION TEST:

- Pre-Scan has been conducted to determine the worst-case mode from all possible combinations between available modulations, data rates and antenna ports (if EUT with antenna diversity architecture).
- Following channel(s) was (were) selected for the final test as listed below.

EUT CONFIGURE MODE	MODE	FREQ. BAND (MHz)	AVAILABLE CHANNEL	TESTED CHANNEL	MODULATION TECHNOLOGY	MODULATION TYPE	DATA RATE (Mbps)
-	802.11n (20MHz)	5500-5700	100 to 140	140	OFDM	BPSK	7.2

ANTENNA PORT CONDUCTED MEASUREMENT:

- This item includes all test value of each mode, but only includes spectrum plot of worst value of each mode.
- Pre-Scan has been conducted to determine the worst-case mode from all possible combinations between available modulations, data rates and antenna ports (if EUT with antenna diversity architecture).
- Following channel(s) was (were) selected for the final test as listed below.

EUT CONFIGURE MODE	MODE	FREQ. BAND (MHz)	AVAILABLE CHANNEL	TESTED CHANNEL	MODULATION TECHNOLOGY	MODULATION TYPE	DATA RATE (Mbps)
-	802.11a	5180-5240	36 to 48	36, 40, 48	OFDM	BPSK	6.0
-	802.11n (20MHz)		36 to 48	36, 40, 48	OFDM	BPSK	7.2
-	802.11n (40MHz)		38 to 46	38, 46	OFDM	BPSK	15.0
-	802.11ac (80MHz)		42	42	OFDM	BPSK	65.0
-	802.11a	5260-5320	52 to 64	52, 60, 64	OFDM	BPSK	6.0
-	802.11n (20MHz)		52 to 64	52, 60, 64	OFDM	BPSK	7.2
-	802.11n (40MHz)		54 to 62	54, 62	OFDM	BPSK	15.0
-	802.11ac (80MHz)		58	58	OFDM	BPSK	65.0
-	802.11a	5500-5700	100 to 140	100, 116, 140	OFDM	BPSK	6.0
-	802.11n (20MHz)		100 to 140	100, 116, 140	OFDM	BPSK	7.2
-	802.11n (40MHz)		102 to 134	102, 110, 134	OFDM	BPSK	15.0
-	802.11ac (80MHz)		106	106	OFDM	BPSK	65.0

TEST CONDITION:

APPLICABLE TO	ENVIRONMENTAL CONDITIONS	INPUT POWER	TESTED BY
RE≥1G	24deg. C, 67%RH	120Vac, 60Hz	Alan Wu
RE<1G	25deg. C, 68%RH	120Vac, 60Hz	Brad Tung
PLC	21deg. C, 68%RH	120Vac, 60Hz	Brad Tung
APCM	25deg. C, 60%RH	120Vac, 60Hz	Cedric Wu



A D T

3.3 DUTY CYCLE OF TEST SIGNAL

MODULATION TYPE: BPSK

Duty cycle of test signal is > 98 %, duty factor is not required.

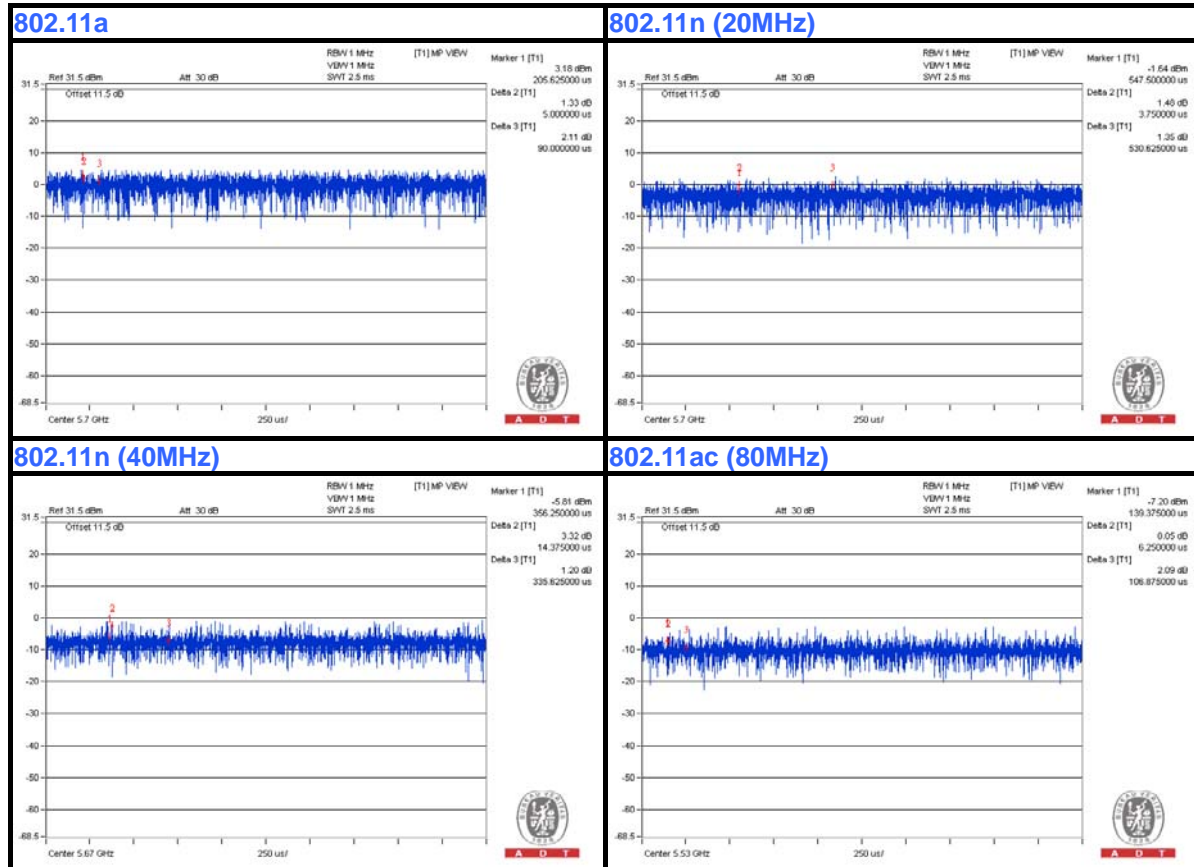



A D T

MODULATION TYPE: QPSK

Duty cycle of test signal is > 98 %, duty factor is not required.

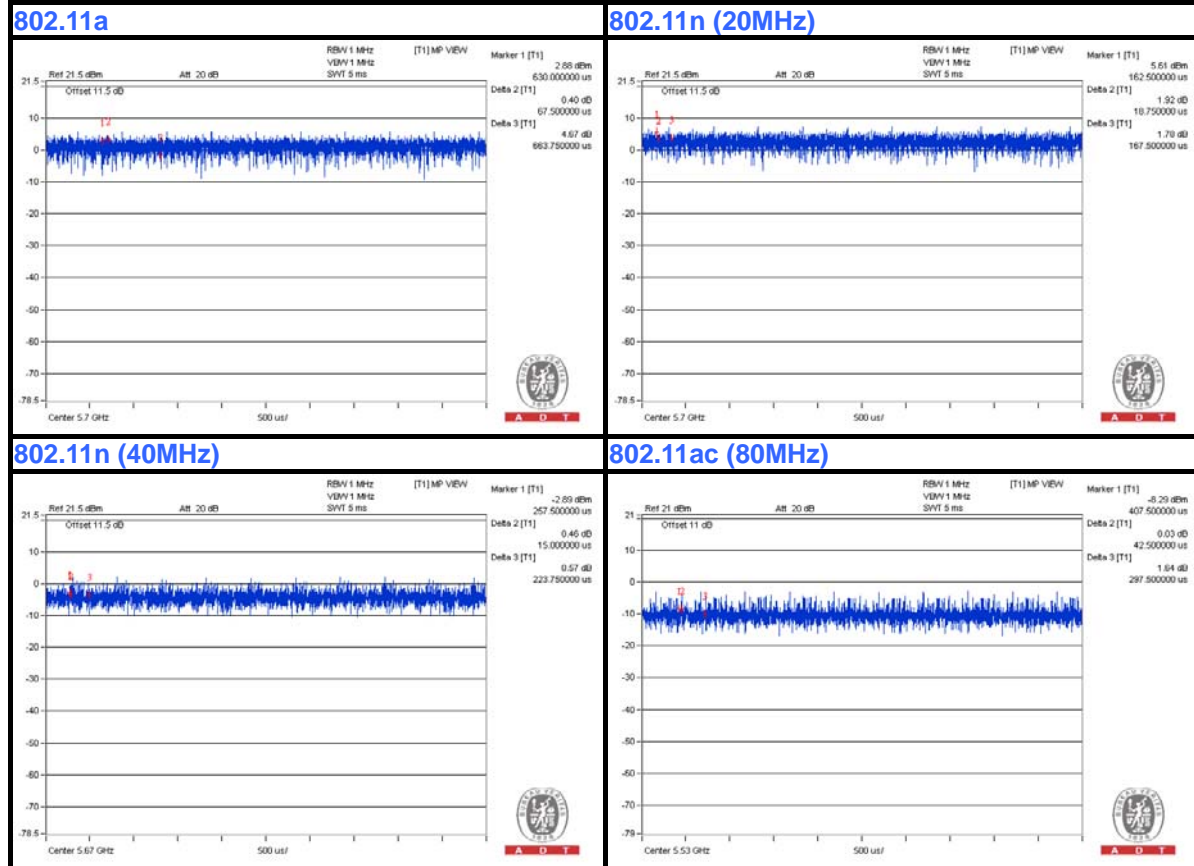



A D T

MODULATION TYPE: 16QAM

Duty cycle of test signal is > 98 %, duty factor is not required.

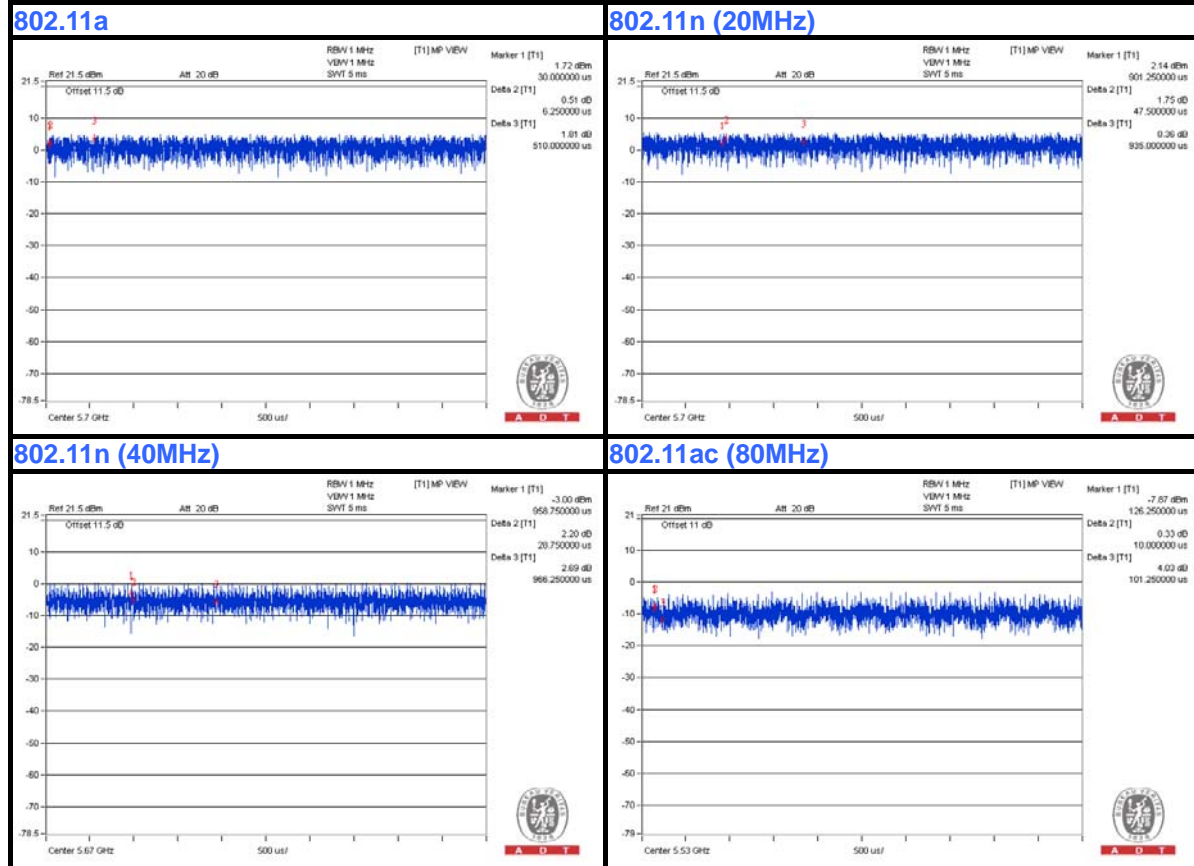



A D T

MODULATION TYPE: 64QAM

Duty cycle of test signal is > 98 %, duty factor is not required.

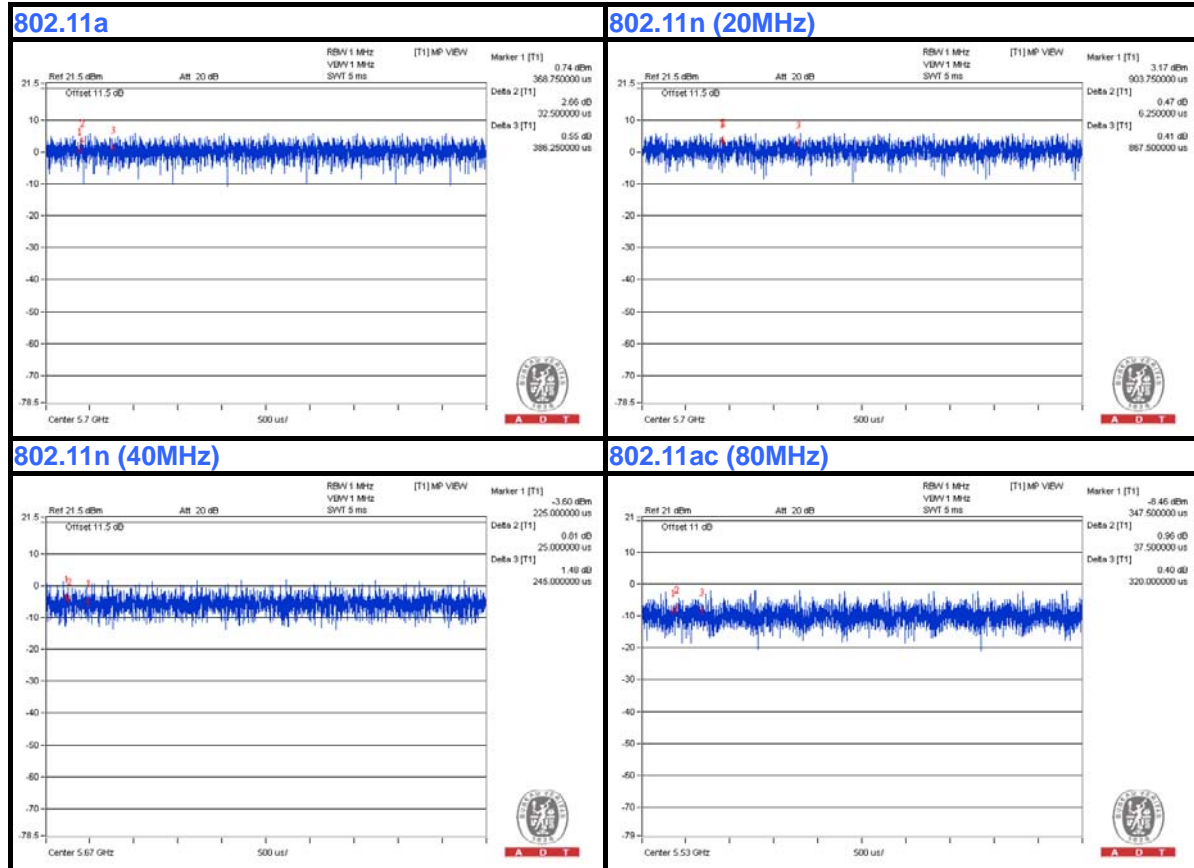

MODULATION TYPE: 256QAM

Duty cycle of test signal is > 98 %, duty factor is not required.

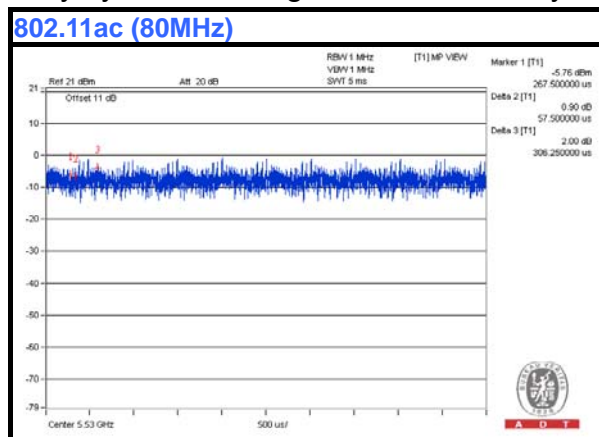

3.4 DESCRIPTION OF SUPPORT UNITS

The EUT has been tested as an independent unit together with other necessary accessories or support units. The following support units or accessories were used to form a representative test configuration during the tests.

NO.	PRODUCT	BRAND	MODEL NO.	SERIAL NO.	FCC ID
1	Notebook	DELL	E5420	BPQ7MQ1	FCC DoC Approved

NO.	SIGNAL CABLE DESCRIPTION OF THE ABOVE SUPPORT UNITS
1	0.5m USB cable

NOTE: All power cords of the above support units are non-shielded (1.8m).

3.4.1 CONFIGURATION OF SYSTEM UNDER TEST

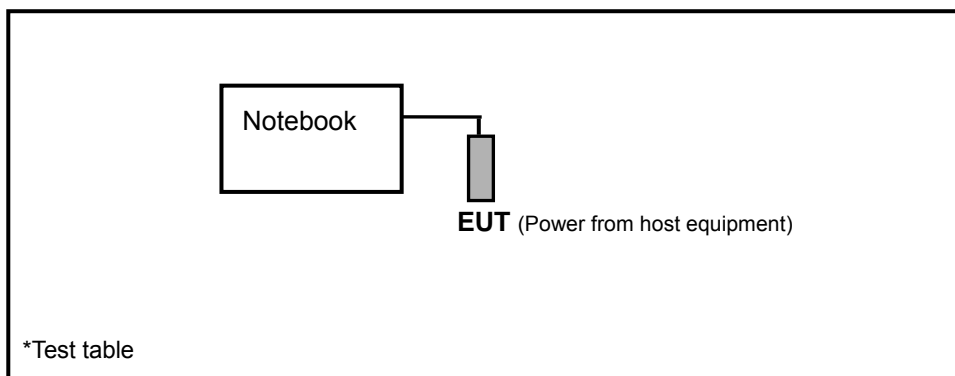

3.5 GENERAL DESCRIPTION OF APPLIED STANDARDS

The EUT is a RF Product. According to the specifications of the manufacturer, it must comply with the requirements of the following standards:

FCC Part 15, Subpart E (15.407)

789033 D01 General UNII Test Procedures Old Rules v01r04

662911 D01 Multiple Transmitter Output v02r01

ANSI C63.10-2009

All test items have been performed and recorded as per the above standards.

NOTE: The EUT is also considered as a kind of computer peripheral, because the connection to computer is necessary for typical use. It has been verified to comply with the requirements of FCC Part 15, Subpart B, Class B (DoC). The test report has been issued separately.

4. TEST TYPES AND RESULTS

4.1 RADIATED EMISSION AND BANDEDGE MEASUREMENT

4.1.1 LIMITS OF RADIATED EMISSION AND BANDEDGE MEASUREMENT

Radiated emissions which fall in the restricted bands must comply with the radiated emission limits specified as below table:

FREQUENCIES (MHz)	FIELD STRENGTH (microvolts/meter)	MEASUREMENT DISTANCE (meters)
0.009 ~ 0.490	2400/F(kHz)	300
0.490 ~ 1.705	24000/F(kHz)	30
1.705 ~ 30.0	30	30
30 ~ 88	100	3
88 ~ 216	150	3
216 ~ 960	200	3
Above 960	500	3

NOTE:

1. The lower limit shall apply at the transition frequencies.
2. Emission level (dBuV/m) = 20 log Emission level (uV/m).
3. For frequencies above 1000MHz, the field strength limits are based on average detector, however, the peak field strength of any emission shall not exceed the maximum permitted average limits, specified above by more than 20dB under any condition of modulation.

4.1.2 LIMITS OF UNWANTED EMISSION OUT OF THE RESTRICTED BANDS

APPLICABLE TO	LIMIT	
√	FIELD STRENGTH AT 3m (dBμV/m)	
	PK	AV
	74	54
	EIRP LIMIT (dBm)	EQUIVALENT FIELD STRENGTH AT 3m (dBμV/m)
	PK	PK
	-27	68.3

NOTE: The following formula is used to convert the equipment isotropic radiated power (eirp) to field strength:

$$E = \frac{1000000\sqrt{30P}}{3} \mu\text{V/m, where P is the eirp (Watts).}$$



4.1.3 TEST INSTRUMENTS

DESCRIPTION & MANUFACTURER	MODEL NO.	SERIAL NO.	DATE OF CALIBRATION	DUE DATE OF CALIBRATION
Test Receiver ROHDE & SCHWARZ	ESCI	100424	Sep. 09, 2013	Sep. 08, 2014
Spectrum Analyzer ROHDE & SCHWARZ	FSU 43	100115	Oct. 24, 2012	Oct. 23, 2013
			Oct. 24, 2013	Oct. 23, 2014
BILOG Antenna SCHWARZBECK	VULB9168	9168-155	Mar. 25, 2013	Mar. 24, 2014
HORN Antenna SCHWARZBECK	BBHA 9120D	9120D-404	Dec. 22, 2012	Dec. 21, 2013
HORN Antenna SCHWARZBECK	BBHA 9170	148	Jul. 15, 2013	Jul. 14, 2014
Pre-amplifier Agilent	8449B	3008A01961	Oct. 28, 2012	Oct. 27, 2013
			Oct. 28, 2013	Oct. 27, 2014
Pre-amplifier Agilent	8447D	2944A10738	Oct. 18, 2012	Oct. 17, 2013
			Oct. 18, 2013	Oct. 17, 2014
RF signal cable HUBER+SUHNNER	SUCOFLEX 104	309220/4	Aug. 26, 2013	Aug. 25, 2014
RF signal cable HUBER+SUHNNER	SUCOFLEX 104	250724/4	Aug. 26, 2013	Aug. 25, 2014
RF signal cable HUBER+SUHNNER	SUCOFLEX 104	295012/4	Aug. 26, 2013	Aug. 25, 2014
Software BV ADT	ADT_Radiated_ V7.6.15.9.4	NA	NA	NA
Antenna Tower inn-co GmbH	MA 4000	010303	NA	NA
Antenna Tower Controller inn-co GmbH	CO2000	019303	NA	NA
Turn Table BV ADT	TT100.	TT93021704	NA	NA
Turn Table Controller BV ADT	SC100.	SC93021704	NA	NA
26GHz ~ 40GHz Amplifier	EM26400	815221	Oct. 18, 2012	Oct. 17, 2013
			Oct. 18, 2013	Oct. 17, 2014
High Speed Peak Power Meter	ML2495A	0824011	Jul. 30, 2013	Jul. 29, 2014
Power Sensor	MA2411B	0738171	Jul. 30, 2013	Jul. 29, 2014
WIT Standard Temperature And Humidity Chamber	TH-4S-C	W981030	Jun. 13, 2013	Jun. 12, 2014

- NOTE:**
1. The calibration interval of the above test instruments is 12 months and the calibrations are traceable to NML/ROC and NIST/USA.
 2. The test was performed in HwaYa Chamber 4.
 3. The horn antenna and HP pre-amplifier (model: 8449B) are used only for the measurement of emission frequency above 1GHz if tested.
 4. The FCC Site Registration No. is 460141.
 5. The IC Site Registration No. is IC7450F-4.

4.1.4 TEST PROCEDURES

- a. The EUT was placed on the top of a rotating table 0.8 meters above the ground at a 3 meter semi-anechoic chamber. The table was rotated 360 degrees to determine the position of the highest radiation.
- b. The EUT was set 3 meters away from the interference-receiving antenna, which was mounted on the top of a variable-height antenna tower.
- c. The antenna is a broadband antenna, and its height is varied from one meter to four meters above the ground to determine the maximum value of the field strength. Both horizontal and vertical polarizations of the antenna are set to make the measurement.
- d. For each suspected emission, the EUT was arranged to its worst case and then the antenna was tuned to heights from 1 meter to 4 meters and the rotatable table was turned from 0 degrees to 360 degrees to find the maximum reading.
- e. The test-receiver system was set to Peak Detect Function and Specified Bandwidth with Maximum Hold Mode.
- f. If the emission level of the EUT in peak mode was 10dB lower than the limit specified, then testing could be stopped and the peak values of the EUT would be reported. Otherwise the emissions that did not have 10dB margin would be re-tested one by one using peak, quasi-peak or average method as specified and then reported in a data sheet.

NOTE:

1. The resolution bandwidth and video bandwidth of test receiver/spectrum analyzer is 120kHz for Quasi-peak detection at frequency below 1GHz.
2. The resolution bandwidth of test receiver/spectrum analyzer is 1MHz and video bandwidth is 3MHz for Peak detection at frequency above 1GHz.
3. The resolution bandwidth of test receiver/spectrum analyzer is 1MHz and the video bandwidth is $\geq 1/T$ (Duty cycle < 98%) or 10Hz (Duty cycle > 98%) for Average detection (AV) at frequency above 1GHz.
4. All modes of operation were investigated and the worst-case emissions are reported.

4.1.5 DEVIATION FROM TEST STANDARD

No deviation.

4.1.6 TEST SETUP

Frequency range 30MHz~1GHz

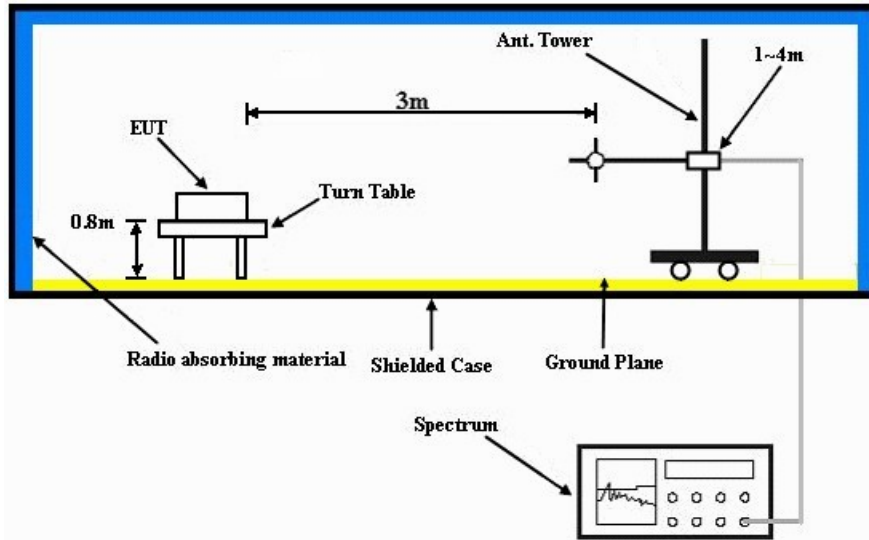

Frequency range above 1GHz

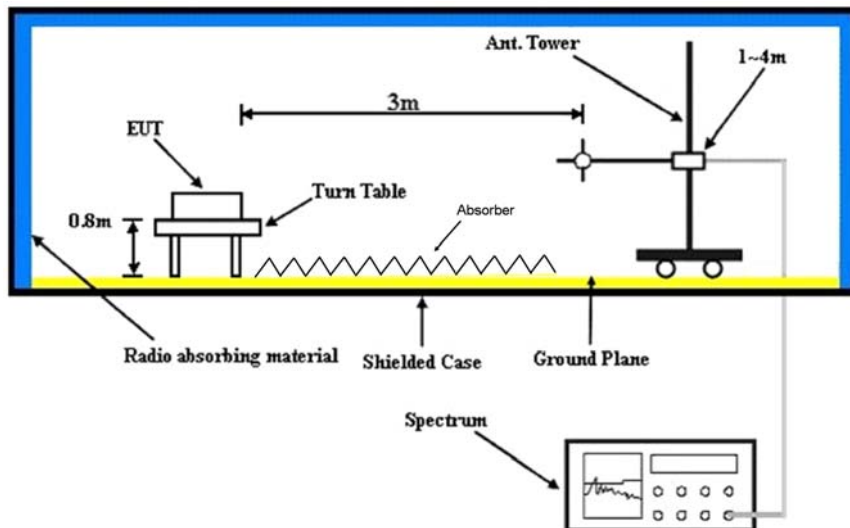

For the actual test configuration, please refer to the attached file (Test Setup Photo).

4.1.7 EUT OPERATING CONDITION

- a. The EUT was connected to the notebook with USB cable
- b. The notebook ran a test program (provided by manufacturer) to enable EUT under transmission condition continuously at specific channel frequency.

4.1.8 TEST RESULTS

ABOVE 1GHz DATA :

802.11a

EUT TEST CONDITION		MEASUREMENT DETAIL	
CHANNEL	Channel 36	FREQUENCY RANGE	1 ~ 40GHz
INPUT POWER (SYSTEM)	120Vac, 60Hz	DETECTOR FUNCTION	Peak (PK) Average (AV)
ENVIRONMENTAL CONDITIONS	24deg. C, 67%RH	TESTED BY	Alan Wu

ANTENNA POLARITY & TEST DISTANCE: HORIZONTAL AT 3 M								
NO.	FREQ. (MHz)	EMISSION LEVEL (dBuV/m)	LIMIT (dBuV/m)	MARGIN (dB)	ANTENNA HEIGHT (m)	TABLE ANGLE (Degree)	RAW VALUE (dBuV)	CORRECTION FACTOR (dB/m)
1	5150.00	58.2 PK	74.0	-15.8	1.00 H	183	52.80	5.40
2	5150.00	44.3 AV	54.0	-9.7	1.00 H	183	38.90	5.40
3	*5180.00	102.9 PK			1.00 H	181	63.60	39.30
4	*5180.00	94.2 AV			1.00 H	181	54.90	39.30
5	#10360.00	57.5 PK	74.0	-16.5	1.00 H	173	41.50	16.00
6	#10360.00	44.8 AV	54.0	-9.2	1.00 H	173	28.80	16.00
ANTENNA POLARITY & TEST DISTANCE: VERTICAL AT 3 M								
NO.	FREQ. (MHz)	EMISSION LEVEL (dBuV/m)	LIMIT (dBuV/m)	MARGIN (dB)	ANTENNA HEIGHT (m)	TABLE ANGLE (Degree)	RAW VALUE (dBuV)	CORRECTION FACTOR (dB/m)
1	5150.00	58.4 PK	74.0	-15.6	1.01 V	184	53.00	5.40
2	5150.00	44.9 AV	54.0	-9.1	1.01 V	184	39.50	5.40
3	*5180.00	106.6 PK			1.08 V	188	67.30	39.30
4	*5180.00	97.1 AV			1.08 V	188	57.80	39.30
5	#10360.00	58.0 PK	74.0	-16.0	1.00 V	190	42.00	16.00
6	#10360.00	45.3 AV	54.0	-8.7	1.00 V	190	29.30	16.00

REMARKS:

1. Emission Level(dBuV/m) = Raw Value(dBuV) + Correction Factor(dB/m)
2. Correction Factor(dB/m) = Antenna Factor(dB/m) + Cable Factor(dB) – Pre-Amplifier Factor(dB)
3. The other emission levels were very low against the limit.
4. Margin value = Emission Level – Limit value
5. “ * “: Fundamental frequency.
6. “#”:The radiated frequency is out the restricted band.



A D T

EUT TEST CONDITION		MEASUREMENT DETAIL	
CHANNEL	Channel 40	FREQUENCY RANGE	1 ~ 40GHz
INPUT POWER (SYSTEM)	120Vac, 60Hz	DETECTOR FUNCTION	Peak (PK) Average (AV)
ENVIRONMENTAL CONDITIONS	24deg. C, 67%RH	TESTED BY	Alan Wu

ANTENNA POLARITY & TEST DISTANCE: HORIZONTAL AT 3 M								
NO.	FREQ. (MHz)	EMISSION LEVEL (dBuV/m)	LIMIT (dBuV/m)	MARGIN (dB)	ANTENNA HEIGHT (m)	TABLE ANGLE (Degree)	RAW VALUE (dBuV)	CORRECTION FACTOR (dB/m)
1	*5200.00	103.7 PK			1.00 H	191	64.40	39.30
2	*5200.00	94.2 AV			1.00 H	191	54.90	39.30
3	#10400.00	57.7 PK	74.0	-16.3	1.00 H	220	41.50	16.20
4	#10400.00	46.2 AV	54.0	-7.8	1.00 H	220	30.00	16.20
ANTENNA POLARITY & TEST DISTANCE: VERTICAL AT 3 M								
NO.	FREQ. (MHz)	EMISSION LEVEL (dBuV/m)	LIMIT (dBuV/m)	MARGIN (dB)	ANTENNA HEIGHT (m)	TABLE ANGLE (Degree)	RAW VALUE (dBuV)	CORRECTION FACTOR (dB/m)
1	*5200.00	104.4 PK			1.60 V	283	65.10	39.30
2	*5200.00	94.2 AV			1.60 V	283	54.90	39.30
3	#10400.00	57.3 PK	74.0	-16.7	1.00 V	21	41.10	16.20
4	#10400.00	46.2 AV	54.0	-7.8	1.00 V	21	30.00	16.20

REMARKS:

1. Emission Level(dBuV/m) = Raw Value(dBuV) + Correction Factor(dB/m)
2. Correction Factor(dB/m) = Antenna Factor(dB/m) + Cable Factor(dB) – Pre-Amplifier Factor(dB)
3. The other emission levels were very low against the limit.
4. Margin value = Emission Level – Limit value
5. “ * “: Fundamental frequency.
6. “#“:The radiated frequency is out the restricted band.



A D T

EUT TEST CONDITION		MEASUREMENT DETAIL	
CHANNEL	Channel 48	FREQUENCY RANGE	1 ~ 40GHz
INPUT POWER (SYSTEM)	120Vac, 60Hz	DETECTOR FUNCTION	Peak (PK) Average (AV)
ENVIRONMENTAL CONDITIONS	24deg. C, 67%RH	TESTED BY	Alan Wu

ANTENNA POLARITY & TEST DISTANCE: HORIZONTAL AT 3 M								
NO.	FREQ. (MHz)	EMISSION LEVEL (dBuV/m)	LIMIT (dBuV/m)	MARGIN (dB)	ANTENNA HEIGHT (m)	TABLE ANGLE (Degree)	RAW VALUE (dBuV)	CORRECTION FACTOR (dB/m)
1	*5240.00	101.7 PK			1.00 H	175	62.40	39.30
2	*5240.00	92.1 AV			1.00 H	175	52.80	39.30
3	5350.00	54.2 PK	74.0	-19.8	1.00 H	175	48.70	5.50
4	5350.00	43.9 AV	54.0	-10.1	1.00 H	175	38.40	5.50
5	#10480.00	58.2 PK	74.0	-15.8	1.02 H	11	41.40	16.80
6	#10480.00	46.6 AV	54.0	-7.4	1.02 H	11	29.80	16.80
ANTENNA POLARITY & TEST DISTANCE: VERTICAL AT 3 M								
NO.	FREQ. (MHz)	EMISSION LEVEL (dBuV/m)	LIMIT (dBuV/m)	MARGIN (dB)	ANTENNA HEIGHT (m)	TABLE ANGLE (Degree)	RAW VALUE (dBuV)	CORRECTION FACTOR (dB/m)
1	*5240.00	105.0 PK			1.61 V	275	65.70	39.30
2	*5240.00	94.3 AV			1.61 V	275	55.00	39.30
3	5350.00	54.8 PK	74.0	-19.2	1.61 V	275	49.30	5.50
4	5350.00	45.2 AV	54.0	-8.8	1.61 V	275	39.70	5.50
5	#10480.00	58.8 PK	74.0	-15.2	1.22 V	311	42.00	16.80
6	#10480.00	47.0 AV	54.0	-7.0	1.22 V	311	30.20	16.80

REMARKS:

1. Emission Level(dBuV/m) = Raw Value(dBuV) + Correction Factor(dB/m)
2. Correction Factor(dB/m) = Antenna Factor(dB/m) + Cable Factor(dB)
– Pre-Amplifier Factor(dB)
3. The other emission levels were very low against the limit.
4. Margin value = Emission Level – Limit value
5. “ * “: Fundamental frequency.
6. “#”:The radiated frequency is out the restricted band.



A D T

EUT TEST CONDITION		MEASUREMENT DETAIL	
CHANNEL	Channel 52	FREQUENCY RANGE	1 ~ 40GHz
INPUT POWER (SYSTEM)	120Vac, 60Hz	DETECTOR FUNCTION	Peak (PK) Average (AV)
ENVIRONMENTAL CONDITIONS	24deg. C, 67%RH	TESTED BY	Alan Wu

ANTENNA POLARITY & TEST DISTANCE: HORIZONTAL AT 3 M								
NO.	FREQ. (MHz)	EMISSION LEVEL (dBuV/m)	LIMIT (dBuV/m)	MARGIN (dB)	ANTENNA HEIGHT (m)	TABLE ANGLE (Degree)	RAW VALUE (dBuV)	CORRECTION FACTOR (dB/m)
1	5150.00	55.4 PK	74.0	-18.6	1.00 H	192	50.00	5.40
2	5150.00	43.6 AV	54.0	-10.4	1.00 H	192	38.20	5.40
3	*5260.00	103.6 PK			1.00 H	192	64.30	39.30
4	*5260.00	93.2 AV			1.00 H	192	53.90	39.30
5	#10520.00	58.3 PK	74.0	-15.7	1.00 H	102	41.50	16.80
6	#10520.00	46.7 AV	54.0	-7.3	1.00 H	102	29.90	16.80
ANTENNA POLARITY & TEST DISTANCE: VERTICAL AT 3 M								
NO.	FREQ. (MHz)	EMISSION LEVEL (dBuV/m)	LIMIT (dBuV/m)	MARGIN (dB)	ANTENNA HEIGHT (m)	TABLE ANGLE (Degree)	RAW VALUE (dBuV)	CORRECTION FACTOR (dB/m)
1	5150.00	55.7 PK	74.0	-18.3	1.58 V	276	50.30	5.40
2	5150.00	44.0 AV	54.0	-10.0	1.58 V	276	38.60	5.40
3	*5260.00	104.4 PK			1.58 V	276	65.10	39.30
4	*5260.00	94.2 AV			1.58 V	276	54.90	39.30
5	#10520.00	57.0 PK	74.0	-17.0	1.00 V	302	40.20	16.80
6	#10520.00	46.9 AV	54.0	-7.1	1.00 V	302	30.10	16.80

REMARKS:

1. Emission Level(dBuV/m) = Raw Value(dBuV) + Correction Factor(dB/m)
2. Correction Factor(dB/m) = Antenna Factor(dB/m) + Cable Factor(dB) – Pre-Amplifier Factor(dB)
3. The other emission levels were very low against the limit.
4. Margin value = Emission Level – Limit value
5. “ * “: Fundamental frequency.
6. “#”:The radiated frequency is out the restricted band.



A D T

EUT TEST CONDITION		MEASUREMENT DETAIL	
CHANNEL	Channel 60	FREQUENCY RANGE	1 ~ 40GHz
INPUT POWER (SYSTEM)	120Vac, 60Hz	DETECTOR FUNCTION	Peak (PK) Average (AV)
ENVIRONMENTAL CONDITIONS	24deg. C, 67%RH	TESTED BY	Alan Wu

ANTENNA POLARITY & TEST DISTANCE: HORIZONTAL AT 3 M								
NO.	FREQ. (MHz)	EMISSION LEVEL (dBuV/m)	LIMIT (dBuV/m)	MARGIN (dB)	ANTENNA HEIGHT (m)	TABLE ANGLE (Degree)	RAW VALUE (dBuV)	CORRECTION FACTOR (dB/m)
1	*5300.00	102.4 PK			1.00 H	173	63.00	39.40
2	*5300.00	92.4 AV			1.00 H	173	53.00	39.40
3	10600.00	57.1 PK	74.0	-16.9	1.00 H	106	40.60	16.50
4	10600.00	47.2 AV	54.0	-6.8	1.00 H	106	30.70	16.50
ANTENNA POLARITY & TEST DISTANCE: VERTICAL AT 3 M								
NO.	FREQ. (MHz)	EMISSION LEVEL (dBuV/m)	LIMIT (dBuV/m)	MARGIN (dB)	ANTENNA HEIGHT (m)	TABLE ANGLE (Degree)	RAW VALUE (dBuV)	CORRECTION FACTOR (dB/m)
1	*5300.00	106.0 PK			1.60 V	274	66.60	39.40
2	*5300.00	94.4 AV			1.60 V	274	55.00	39.40
3	10600.00	57.8 PK	74.0	-16.2	1.50 V	196	41.30	16.50
4	10600.00	46.7 AV	54.0	-7.3	1.50 V	196	30.20	16.50

REMARKS:

1. Emission Level(dBuV/m) = Raw Value(dBuV) + Correction Factor(dB/m)
2. Correction Factor(dB/m) = Antenna Factor(dB/m) + Cable Factor(dB)
– Pre-Amplifier Factor(dB)
3. The other emission levels were very low against the limit.
4. Margin value = Emission Level – Limit value
5. “ * “: Fundamental frequency.



A D T

EUT TEST CONDITION		MEASUREMENT DETAIL	
CHANNEL	Channel 64	FREQUENCY RANGE	1 ~ 40GHz
INPUT POWER (SYSTEM)	120Vac, 60Hz	DETECTOR FUNCTION	Peak (PK) Average (AV)
ENVIRONMENTAL CONDITIONS	24deg. C, 67%RH	TESTED BY	Alan Wu

ANTENNA POLARITY & TEST DISTANCE: HORIZONTAL AT 3 M								
NO.	FREQ. (MHz)	EMISSION LEVEL (dBuV/m)	LIMIT (dBuV/m)	MARGIN (dB)	ANTENNA HEIGHT (m)	TABLE ANGLE (Degree)	RAW VALUE (dBuV)	CORRECTION FACTOR (dB/m)
1	*5320.00	104.8 PK			1.09 H	185	65.40	39.40
2	*5320.00	95.3 AV			1.09 H	185	55.90	39.40
3	5350.00	59.1 PK	74.0	-14.9	1.09 H	185	53.60	5.50
4	5350.00	45.2 AV	54.0	-8.8	1.09 H	185	39.70	5.50
5	10640.00	58.0 PK	74.0	-16.0	1.00 H	174	41.20	16.80
6	10640.00	45.8 AV	54.0	-8.2	1.00 H	174	29.00	16.80
ANTENNA POLARITY & TEST DISTANCE: VERTICAL AT 3 M								
NO.	FREQ. (MHz)	EMISSION LEVEL (dBuV/m)	LIMIT (dBuV/m)	MARGIN (dB)	ANTENNA HEIGHT (m)	TABLE ANGLE (Degree)	RAW VALUE (dBuV)	CORRECTION FACTOR (dB/m)
1	*5320.00	107.8 PK			1.00 V	185	68.40	39.40
2	*5320.00	98.4 AV			1.00 V	185	59.00	39.40
3	5350.00	59.2 PK	74.0	-14.8	1.00 V	184	53.70	5.50
4	5350.00	45.7 AV	54.0	-8.3	1.00 V	184	40.20	5.50
5	10640.00	58.2 PK	74.0	-15.8	1.00 V	191	41.40	16.80
6	10640.00	46.2 AV	54.0	-7.8	1.00 V	191	29.40	16.80

REMARKS:

1. Emission Level(dBuV/m) = Raw Value(dBuV) + Correction Factor(dB/m)
2. Correction Factor(dB/m) = Antenna Factor(dB/m) + Cable Factor(dB) – Pre-Amplifier Factor(dB)
3. The other emission levels were very low against the limit.
4. Margin value = Emission Level – Limit value
5. “ * “: Fundamental frequency.



EUT TEST CONDITION		MEASUREMENT DETAIL	
CHANNEL	Channel 100	FREQUENCY RANGE	1 ~ 40GHz
INPUT POWER (SYSTEM)	120Vac, 60Hz	DETECTOR FUNCTION	Peak (PK) Average (AV)
ENVIRONMENTAL CONDITIONS	24deg. C, 67%RH	TESTED BY	Alan Wu

ANTENNA POLARITY & TEST DISTANCE: HORIZONTAL AT 3 M

NO.	FREQ. (MHz)	EMISSION LEVEL (dBuV/m)	LIMIT (dBuV/m)	MARGIN (dB)	ANTENNA HEIGHT (m)	TABLE ANGLE (Degree)	RAW VALUE (dBuV)	CORRECTION FACTOR (dB/m)
1	5460.00	58.2 PK	74.0	-15.8	1.04 H	185	52.60	5.60
2	5460.00	44.1 AV	54.0	-9.9	1.04 H	185	38.50	5.60
3	#5470.00	60.5 PK	74.0	-13.5	1.04 H	185	54.90	5.60
4	#5470.00	46.9 AV	54.0	-7.1	1.04 H	185	41.30	5.60
5	*5500.00	104.9 PK			1.04 H	185	65.30	39.60
6	*5500.00	95.7 AV			1.04 H	185	56.10	39.60
7	11000.00	57.2 PK	74.0	-16.8	1.00 H	179	38.70	18.50
8	11000.00	44.7 AV	54.0	-9.3	1.00 H	179	26.20	18.50

ANTENNA POLARITY & TEST DISTANCE: VERTICAL AT 3 M

NO.	FREQ. (MHz)	EMISSION LEVEL (dBuV/m)	LIMIT (dBuV/m)	MARGIN (dB)	ANTENNA HEIGHT (m)	TABLE ANGLE (Degree)	RAW VALUE (dBuV)	CORRECTION FACTOR (dB/m)
1	5460.00	58.4 PK	74.0	-15.6	1.00 V	184	52.80	5.60
2	5460.00	44.7 AV	54.0	-9.3	1.00 V	184	39.10	5.60
3	#5470.00	61.4 PK	74.0	-12.6	1.00 V	184	55.80	5.60
4	#5470.00	47.2 AV	54.0	-6.8	1.00 V	184	41.60	5.60
5	*5500.00	107.7 PK			1.00 V	186	68.10	39.60
6	*5500.00	98.4 AV			1.00 V	186	58.80	39.60
7	11000.00	57.5 PK	74.0	-16.5	1.00 V	195	39.00	18.50
8	11000.00	45.2 AV	54.0	-8.8	1.00 V	195	26.70	18.50

REMARKS:

1. Emission Level(dBuV/m) = Raw Value(dBuV) + Correction Factor(dB/m)
2. Correction Factor(dB/m) = Antenna Factor(dB/m) + Cable Factor(dB)
– Pre-Amplifier Factor(dB)
3. The other emission levels were very low against the limit.
4. Margin value = Emission Level – Limit value
5. “ * “: Fundamental frequency.
6. “#“:The radiated frequency is out the restricted band.



A D T

EUT TEST CONDITION		MEASUREMENT DETAIL	
CHANNEL	Channel 116	FREQUENCY RANGE	1 ~ 40GHz
INPUT POWER (SYSTEM)	120Vac, 60Hz	DETECTOR FUNCTION	Peak (PK) Average (AV)
ENVIRONMENTAL CONDITIONS	24deg. C, 67%RH	TESTED BY	Alan Wu

ANTENNA POLARITY & TEST DISTANCE: HORIZONTAL AT 3 M								
NO.	FREQ. (MHz)	EMISSION LEVEL (dBuV/m)	LIMIT (dBuV/m)	MARGIN (dB)	ANTENNA HEIGHT (m)	TABLE ANGLE (Degree)	RAW VALUE (dBuV)	CORRECTION FACTOR (dB/m)
1	*5580.00	103.8 PK			1.00 H	190	64.00	39.80
2	*5580.00	94.0 AV			1.00 H	190	54.20	39.80
3	11160.00	57.4 PK	74.0	-16.6	1.00 H	175	39.00	18.40
4	11160.00	45.3 AV	54.0	-8.7	1.00 H	175	26.90	18.40
ANTENNA POLARITY & TEST DISTANCE: VERTICAL AT 3 M								
NO.	FREQ. (MHz)	EMISSION LEVEL (dBuV/m)	LIMIT (dBuV/m)	MARGIN (dB)	ANTENNA HEIGHT (m)	TABLE ANGLE (Degree)	RAW VALUE (dBuV)	CORRECTION FACTOR (dB/m)
1	*5580.00	106.8 PK			1.00 V	177	67.00	39.80
2	*5580.00	97.7 AV			1.00 V	177	57.90	39.80
3	11160.00	57.2 PK	74.0	-16.8	1.02 V	205	38.80	18.40
4	11160.00	45.0 AV	54.0	-9.0	1.02 V	205	26.60	18.40

REMARKS:

1. Emission Level(dBuV/m) = Raw Value(dBuV) + Correction Factor(dB/m)
2. Correction Factor(dB/m) = Antenna Factor(dB/m) + Cable Factor(dB)
– Pre-Amplifier Factor(dB)
3. The other emission levels were very low against the limit.
4. Margin value = Emission Level – Limit value
5. “ * “: Fundamental frequency.
6. “#”:The radiated frequency is out the restricted band.



A D T

EUT TEST CONDITION		MEASUREMENT DETAIL	
CHANNEL	Channel 140	FREQUENCY RANGE	1 ~ 40GHz
INPUT POWER (SYSTEM)	120Vac, 60Hz	DETECTOR FUNCTION	Peak (PK) Average (AV)
ENVIRONMENTAL CONDITIONS	24deg. C, 67%RH	TESTED BY	Alan Wu

ANTENNA POLARITY & TEST DISTANCE: HORIZONTAL AT 3 M								
NO.	FREQ. (MHz)	EMISSION LEVEL (dBuV/m)	LIMIT (dBuV/m)	MARGIN (dB)	ANTENNA HEIGHT (m)	TABLE ANGLE (Degree)	RAW VALUE (dBuV)	CORRECTION FACTOR (dB/m)
1	*5700.00	104.6 PK			1.00 H	188	64.50	40.10
2	*5700.00	95.2 AV			1.00 H	188	55.10	40.10
3	#5725.00	60.2 PK	74.0	-13.8	1.00 H	188	53.90	6.30
4	#5725.00	45.4 AV	54.0	-8.6	1.00 H	188	39.10	6.30
5	11400.00	56.5 PK	74.0	-17.5	1.00 H	171	38.30	18.20
6	11400.00	43.5 AV	54.0	-10.5	1.00 H	171	25.30	18.20
ANTENNA POLARITY & TEST DISTANCE: VERTICAL AT 3 M								
NO.	FREQ. (MHz)	EMISSION LEVEL (dBuV/m)	LIMIT (dBuV/m)	MARGIN (dB)	ANTENNA HEIGHT (m)	TABLE ANGLE (Degree)	RAW VALUE (dBuV)	CORRECTION FACTOR (dB/m)
1	*5700.00	106.4 PK			1.00 V	183	66.30	40.10
2	*5700.00	97.2 AV			1.00 V	183	57.10	40.10
3	#5725.00	61.1 PK	74.0	-12.9	1.00 V	180	54.80	6.30
4	#5725.00	45.9 AV	54.0	-8.1	1.00 V	180	39.60	6.30
5	11400.00	56.9 PK	74.0	-17.1	1.00 V	190	38.70	18.20
6	11400.00	44.1 AV	54.0	-9.9	1.00 V	190	25.90	18.20

REMARKS:

1. Emission Level(dBuV/m) = Raw Value(dBuV) + Correction Factor(dB/m)
2. Correction Factor(dB/m) = Antenna Factor(dB/m) + Cable Factor(dB) – Pre-Amplifier Factor(dB)
3. The other emission levels were very low against the limit.
4. Margin value = Emission Level – Limit value
5. “ * “: Fundamental frequency.
6. “#”:The radiated frequency is out the restricted band.

802.11n (20MHz)

EUT TEST CONDITION		MEASUREMENT DETAIL	
CHANNEL	Channel 36	FREQUENCY RANGE	1 ~ 40GHz
INPUT POWER (SYSTEM)	120Vac, 60Hz	DETECTOR FUNCTION	Peak (PK) Average (AV)
ENVIRONMENTAL CONDITIONS	24deg. C, 67%RH	TESTED BY	Alan Wu

ANTENNA POLARITY & TEST DISTANCE: HORIZONTAL AT 3 M								
NO.	FREQ. (MHz)	EMISSION LEVEL (dBuV/m)	LIMIT (dBuV/m)	MARGIN (dB)	ANTENNA HEIGHT (m)	TABLE ANGLE (Degree)	RAW VALUE (dBuV)	CORRECTION FACTOR (dB/m)
1	5150.00	58.0 PK	74.0	-16.0	1.00 H	186	52.60	5.40
2	5150.00	44.7 AV	54.0	-9.3	1.00 H	186	39.30	5.40
3	*5180.00	104.5 PK			1.00 H	181	65.20	39.30
4	*5180.00	94.2 AV			1.00 H	181	54.90	39.30
5	#10360.00	57.4 PK	74.0	-16.6	1.00 H	175	41.40	16.00
6	#10360.00	44.6 AV	54.0	-9.4	1.00 H	175	28.60	16.00

ANTENNA POLARITY & TEST DISTANCE: VERTICAL AT 3 M								
NO.	FREQ. (MHz)	EMISSION LEVEL (dBuV/m)	LIMIT (dBuV/m)	MARGIN (dB)	ANTENNA HEIGHT (m)	TABLE ANGLE (Degree)	RAW VALUE (dBuV)	CORRECTION FACTOR (dB/m)
1	5150.00	57.5 PK	74.0	-16.5	1.00 V	194	52.10	5.40
2	5150.00	44.1 AV	54.0	-9.9	1.00 V	194	38.70	5.40
3	*5180.00	98.4 PK			1.00 V	192	59.10	39.30
4	*5180.00	87.3 AV			1.00 V	192	48.00	39.30
5	#10360.00	57.1 PK	74.0	-16.9	1.00 V	195	41.10	16.00
6	#10360.00	44.0 AV	54.0	-10.0	1.00 V	195	28.00	16.00

REMARKS:

1. Emission Level(dBuV/m) = Raw Value(dBuV) + Correction Factor(dB/m)
2. Correction Factor(dB/m) = Antenna Factor(dB/m) + Cable Factor(dB)
– Pre-Amplifier Factor(dB)
3. The other emission levels were very low against the limit.
4. Margin value = Emission Level – Limit value
5. “ * “: Fundamental frequency.
6. “#”:The radiated frequency is out the restricted band.



A D T

EUT TEST CONDITION		MEASUREMENT DETAIL	
CHANNEL	Channel 40	FREQUENCY RANGE	1 ~ 40GHz
INPUT POWER (SYSTEM)	120Vac, 60Hz	DETECTOR FUNCTION	Peak (PK) Average (AV)
ENVIRONMENTAL CONDITIONS	24deg. C, 67%RH	TESTED BY	Alan Wu

ANTENNA POLARITY & TEST DISTANCE: HORIZONTAL AT 3 M								
NO.	FREQ. (MHz)	EMISSION LEVEL (dBuV/m)	LIMIT (dBuV/m)	MARGIN (dB)	ANTENNA HEIGHT (m)	TABLE ANGLE (Degree)	RAW VALUE (dBuV)	CORRECTION FACTOR (dB/m)
1	*5200.00	104.1 PK			1.00 H	188	64.80	39.30
2	*5200.00	94.0 AV			1.00 H	188	54.70	39.30
3	#10400.00	57.3 PK	74.0	-16.7	1.00 H	166	41.10	16.20
4	#10400.00	44.4 AV	54.0	-9.6	1.00 H	166	28.20	16.20
ANTENNA POLARITY & TEST DISTANCE: VERTICAL AT 3 M								
NO.	FREQ. (MHz)	EMISSION LEVEL (dBuV/m)	LIMIT (dBuV/m)	MARGIN (dB)	ANTENNA HEIGHT (m)	TABLE ANGLE (Degree)	RAW VALUE (dBuV)	CORRECTION FACTOR (dB/m)
1	*5200.00	98.1 PK			1.00 V	192	58.80	39.30
2	*5200.00	87.4 AV			1.00 V	192	48.10	39.30
3	#10400.00	57.0 PK	74.0	-17.0	1.00 V	183	40.80	16.20
4	#10400.00	44.1 AV	54.0	-9.9	1.00 V	183	27.90	16.20

REMARKS:

1. Emission Level(dBuV/m) = Raw Value(dBuV) + Correction Factor(dB/m)
2. Correction Factor(dB/m) = Antenna Factor(dB/m) + Cable Factor(dB)
– Pre-Amplifier Factor(dB)
3. The other emission levels were very low against the limit.
4. Margin value = Emission Level – Limit value
5. “ * “: Fundamental frequency.
6. “#”:The radiated frequency is out the restricted band.



A D T

EUT TEST CONDITION		MEASUREMENT DETAIL	
CHANNEL	Channel 48	FREQUENCY RANGE	1 ~ 40GHz
INPUT POWER (SYSTEM)	120Vac, 60Hz	DETECTOR FUNCTION	Peak (PK) Average (AV)
ENVIRONMENTAL CONDITIONS	24deg. C, 67%RH	TESTED BY	Alan Wu

ANTENNA POLARITY & TEST DISTANCE: HORIZONTAL AT 3 M								
NO.	FREQ. (MHz)	EMISSION LEVEL (dBuV/m)	LIMIT (dBuV/m)	MARGIN (dB)	ANTENNA HEIGHT (m)	TABLE ANGLE (Degree)	RAW VALUE (dBuV)	CORRECTION FACTOR (dB/m)
1	*5240.00	104.3 PK			1.00 H	180	65.00	39.30
2	*5240.00	93.5 AV			1.00 H	180	54.20	39.30
3	#10480.00	57.3 PK	74.0	-16.7	1.00 H	170	40.50	16.80
4	#10480.00	44.5 AV	54.0	-9.5	1.00 H	170	27.70	16.80
ANTENNA POLARITY & TEST DISTANCE: VERTICAL AT 3 M								
NO.	FREQ. (MHz)	EMISSION LEVEL (dBuV/m)	LIMIT (dBuV/m)	MARGIN (dB)	ANTENNA HEIGHT (m)	TABLE ANGLE (Degree)	RAW VALUE (dBuV)	CORRECTION FACTOR (dB/m)
1	*5240.00	98.3 PK			1.00 V	190	59.00	39.30
2	*5240.00	87.5 AV			1.00 V	190	48.20	39.30
3	#10480.00	57.1 PK	74.0	-16.9	1.00 V	196	40.30	16.80
4	#10480.00	44.3 AV	54.0	-9.7	1.00 V	196	27.50	16.80

REMARKS:

1. Emission Level(dBuV/m) = Raw Value(dBuV) + Correction Factor(dB/m)
2. Correction Factor(dB/m) = Antenna Factor(dB/m) + Cable Factor(dB)
– Pre-Amplifier Factor(dB)
3. The other emission levels were very low against the limit.
4. Margin value = Emission Level – Limit value
5. “ * “: Fundamental frequency.
6. “#”:The radiated frequency is out the restricted band.



A D T

EUT TEST CONDITION		MEASUREMENT DETAIL	
CHANNEL	Channel 52	FREQUENCY RANGE	1 ~ 40GHz
INPUT POWER (SYSTEM)	120Vac, 60Hz	DETECTOR FUNCTION	Peak (PK) Average (AV)
ENVIRONMENTAL CONDITIONS	24deg. C, 67%RH	TESTED BY	Alan Wu

ANTENNA POLARITY & TEST DISTANCE: HORIZONTAL AT 3 M								
NO.	FREQ. (MHz)	EMISSION LEVEL (dBuV/m)	LIMIT (dBuV/m)	MARGIN (dB)	ANTENNA HEIGHT (m)	TABLE ANGLE (Degree)	RAW VALUE (dBuV)	CORRECTION FACTOR (dB/m)
1	*5260.00	105.3 PK			1.00 H	177	66.00	39.30
2	*5260.00	94.9 AV			1.00 H	177	55.60	39.30
3	#10520.00	57.6 PK	74.0	-16.4	1.00 H	165	40.80	16.80
4	#10520.00	44.8 AV	54.0	-9.2	1.00 H	165	28.00	16.80
ANTENNA POLARITY & TEST DISTANCE: VERTICAL AT 3 M								
NO.	FREQ. (MHz)	EMISSION LEVEL (dBuV/m)	LIMIT (dBuV/m)	MARGIN (dB)	ANTENNA HEIGHT (m)	TABLE ANGLE (Degree)	RAW VALUE (dBuV)	CORRECTION FACTOR (dB/m)
1	*5260.00	100.3 PK			1.00 V	202	61.00	39.30
2	*5260.00	89.9 AV			1.00 V	202	50.60	39.30
3	#10520.00	57.4 PK	74.0	-16.6	1.00 V	186	40.60	16.80
4	#10520.00	44.8 AV	54.0	-9.2	1.00 V	186	28.00	16.80

REMARKS:

1. Emission Level(dBuV/m) = Raw Value(dBuV) + Correction Factor(dB/m)
2. Correction Factor(dB/m) = Antenna Factor(dB/m) + Cable Factor(dB)
– Pre-Amplifier Factor(dB)
3. The other emission levels were very low against the limit.
4. Margin value = Emission Level – Limit value
5. “ * “: Fundamental frequency.
6. “#”:The radiated frequency is out the restricted band.



A D T

EUT TEST CONDITION		MEASUREMENT DETAIL	
CHANNEL	Channel 60	FREQUENCY RANGE	1 ~ 40GHz
INPUT POWER (SYSTEM)	120Vac, 60Hz	DETECTOR FUNCTION	Peak (PK) Average (AV)
ENVIRONMENTAL CONDITIONS	24deg. C, 67%RH	TESTED BY	Alan Wu

ANTENNA POLARITY & TEST DISTANCE: HORIZONTAL AT 3 M								
NO.	FREQ. (MHz)	EMISSION LEVEL (dBuV/m)	LIMIT (dBuV/m)	MARGIN (dB)	ANTENNA HEIGHT (m)	TABLE ANGLE (Degree)	RAW VALUE (dBuV)	CORRECTION FACTOR (dB/m)
1	*5300.00	106.0 PK			1.00 H	222	66.60	39.40
2	*5300.00	95.7 AV			1.00 H	222	56.30	39.40
3	10600.00	57.7 PK	74.0	-16.3	1.00 H	179	41.20	16.50
4	10600.00	45.0 AV	54.0	-9.0	1.00 H	179	28.50	16.50
ANTENNA POLARITY & TEST DISTANCE: VERTICAL AT 3 M								
NO.	FREQ. (MHz)	EMISSION LEVEL (dBuV/m)	LIMIT (dBuV/m)	MARGIN (dB)	ANTENNA HEIGHT (m)	TABLE ANGLE (Degree)	RAW VALUE (dBuV)	CORRECTION FACTOR (dB/m)
1	*5300.00	100.3 PK			1.00 V	199	60.90	39.40
2	*5300.00	89.9 AV			1.00 V	199	50.50	39.40
3	10600.00	57.4 PK	74.0	-16.6	1.00 V	188	40.90	16.50
4	10600.00	44.8 AV	54.0	-9.2	1.00 V	188	28.30	16.50

REMARKS:

1. Emission Level(dBuV/m) = Raw Value(dBuV) + Correction Factor(dB/m)
2. Correction Factor(dB/m) = Antenna Factor(dB/m) + Cable Factor(dB)
– Pre-Amplifier Factor(dB)
3. The other emission levels were very low against the limit.
4. Margin value = Emission Level – Limit value
5. “ * “: Fundamental frequency.



A D T

EUT TEST CONDITION		MEASUREMENT DETAIL	
CHANNEL	Channel 64	FREQUENCY RANGE	1 ~ 40GHz
INPUT POWER (SYSTEM)	120Vac, 60Hz	DETECTOR FUNCTION	Peak (PK) Average (AV)
ENVIRONMENTAL CONDITIONS	24deg. C, 67%RH	TESTED BY	Alan Wu

ANTENNA POLARITY & TEST DISTANCE: HORIZONTAL AT 3 M								
NO.	FREQ. (MHz)	EMISSION LEVEL (dBuV/m)	LIMIT (dBuV/m)	MARGIN (dB)	ANTENNA HEIGHT (m)	TABLE ANGLE (Degree)	RAW VALUE (dBuV)	CORRECTION FACTOR (dB/m)
1	*5320.00	105.9 PK			1.00 H	181	66.50	39.40
2	*5320.00	95.6 AV			1.00 H	181	56.20	39.40
3	5350.00	58.3 PK	74.0	-15.7	1.00 H	183	52.80	5.50
4	5350.00	45.5 AV	54.0	-8.5	1.00 H	183	40.00	5.50
5	10640.00	57.8 PK	74.0	-16.2	1.00 H	172	41.00	16.80
6	10640.00	45.5 AV	54.0	-8.5	1.00 H	172	28.70	16.80

ANTENNA POLARITY & TEST DISTANCE: VERTICAL AT 3 M								
NO.	FREQ. (MHz)	EMISSION LEVEL (dBuV/m)	LIMIT (dBuV/m)	MARGIN (dB)	ANTENNA HEIGHT (m)	TABLE ANGLE (Degree)	RAW VALUE (dBuV)	CORRECTION FACTOR (dB/m)
1	*5320.00	100.7 PK			1.00 V	192	61.30	39.40
2	*5320.00	89.8 AV			1.00 V	192	50.40	39.40
3	5350.00	58.1 PK	74.0	-15.9	1.00 V	197	52.60	5.50
4	5350.00	45.0 AV	54.0	-9.0	1.00 V	197	39.50	5.50
5	10640.00	57.5 PK	74.0	-16.5	1.00 V	197	40.70	16.80
6	10640.00	45.1 AV	54.0	-8.9	1.00 V	197	28.30	16.80

REMARKS:

1. Emission Level(dBuV/m) = Raw Value(dBuV) + Correction Factor(dB/m)
2. Correction Factor(dB/m) = Antenna Factor(dB/m) + Cable Factor(dB)
– Pre-Amplifier Factor(dB)
3. The other emission levels were very low against the limit.
4. Margin value = Emission Level – Limit value
5. “ * “: Fundamental frequency.



EUT TEST CONDITION		MEASUREMENT DETAIL	
CHANNEL	Channel 100	FREQUENCY RANGE	1 ~ 40GHz
INPUT POWER (SYSTEM)	120Vac, 60Hz	DETECTOR FUNCTION	Peak (PK) Average (AV)
ENVIRONMENTAL CONDITIONS	24deg. C, 67%RH	TESTED BY	Alan Wu

ANTENNA POLARITY & TEST DISTANCE: HORIZONTAL AT 3 M								
NO.	FREQ. (MHz)	EMISSION LEVEL (dBuV/m)	LIMIT (dBuV/m)	MARGIN (dB)	ANTENNA HEIGHT (m)	TABLE ANGLE (Degree)	RAW VALUE (dBuV)	CORRECTION FACTOR (dB/m)
1	5460.00	58.0 PK	74.0	-16.0	1.00 H	180	52.40	5.60
2	5460.00	44.5 AV	54.0	-9.5	1.00 H	180	38.90	5.60
3	#5470.00	61.3 PK	74.0	-12.7	1.00 H	180	55.70	5.60
4	#5470.00	46.5 AV	54.0	-7.5	1.00 H	180	40.90	5.60
5	*5500.00	104.7 PK			1.00 H	186	65.10	39.60
6	*5500.00	94.1 AV			1.00 H	186	54.50	39.60
7	11000.00	57.2 PK	74.0	-16.8	1.00 H	178	38.70	18.50
8	11000.00	44.6 AV	54.0	-9.4	1.00 H	178	26.10	18.50
ANTENNA POLARITY & TEST DISTANCE: VERTICAL AT 3 M								
NO.	FREQ. (MHz)	EMISSION LEVEL (dBuV/m)	LIMIT (dBuV/m)	MARGIN (dB)	ANTENNA HEIGHT (m)	TABLE ANGLE (Degree)	RAW VALUE (dBuV)	CORRECTION FACTOR (dB/m)
1	5460.00	57.5 PK	74.0	-16.5	1.21 V	198	51.90	5.60
2	5460.00	43.9 AV	54.0	-10.1	1.21 V	198	38.30	5.60
3	#5470.00	60.4 PK	74.0	-13.6	1.21 V	198	54.80	5.60
4	#5470.00	46.1 AV	54.0	-7.9	1.21 V	198	40.50	5.60
5	*5500.00	99.9 PK			1.29 V	192	60.30	39.60
6	*5500.00	89.5 AV			1.29 V	192	49.90	39.60
7	11000.00	56.9 PK	74.0	-17.1	1.00 V	199	38.40	18.50
8	11000.00	44.0 AV	54.0	-10.0	1.00 V	199	25.50	18.50

REMARKS:

1. Emission Level(dBuV/m) = Raw Value(dBuV) + Correction Factor(dB/m)
2. Correction Factor(dB/m) = Antenna Factor(dB/m) + Cable Factor(dB) – Pre-Amplifier Factor(dB)
3. The other emission levels were very low against the limit.
4. Margin value = Emission Level – Limit value
5. “ * “: Fundamental frequency.
6. "#":The radiated frequency is out the restricted band.



A D T

EUT TEST CONDITION		MEASUREMENT DETAIL	
CHANNEL	Channel 116	FREQUENCY RANGE	1 ~ 40GHz
INPUT POWER (SYSTEM)	120Vac, 60Hz	DETECTOR FUNCTION	Peak (PK) Average (AV)
ENVIRONMENTAL CONDITIONS	24deg. C, 67%RH	TESTED BY	Alan Wu

ANTENNA POLARITY & TEST DISTANCE: HORIZONTAL AT 3 M								
NO.	FREQ. (MHz)	EMISSION LEVEL (dBuV/m)	LIMIT (dBuV/m)	MARGIN (dB)	ANTENNA HEIGHT (m)	TABLE ANGLE (Degree)	RAW VALUE (dBuV)	CORRECTION FACTOR (dB/m)
1	*5580.00	105.5 PK			1.00 H	175	65.70	39.80
2	*5580.00	95.0 AV			1.00 H	175	55.20	39.80
3	11160.00	57.2 PK	74.0	-16.8	1.00 H	176	38.80	18.40
4	11160.00	44.7 AV	54.0	-9.3	1.00 H	176	26.30	18.40
ANTENNA POLARITY & TEST DISTANCE: VERTICAL AT 3 M								
NO.	FREQ. (MHz)	EMISSION LEVEL (dBuV/m)	LIMIT (dBuV/m)	MARGIN (dB)	ANTENNA HEIGHT (m)	TABLE ANGLE (Degree)	RAW VALUE (dBuV)	CORRECTION FACTOR (dB/m)
1	*5580.00	99.7 PK			1.22 V	190	59.90	39.80
2	*5580.00	89.2 AV			1.22 V	190	49.40	39.80
3	11160.00	56.8 PK	74.0	-17.2	1.00 V	2	38.40	18.40
4	11160.00	44.2 AV	54.0	-9.8	1.00 V	2	25.80	18.40

REMARKS:

1. Emission Level(dBuV/m) = Raw Value(dBuV) + Correction Factor(dB/m)
2. Correction Factor(dB/m) = Antenna Factor(dB/m) + Cable Factor(dB) – Pre-Amplifier Factor(dB)
3. The other emission levels were very low against the limit.
4. Margin value = Emission Level – Limit value
5. “ * “: Fundamental frequency.
6. “#”:The radiated frequency is out the restricted band.



EUT TEST CONDITION		MEASUREMENT DETAIL	
CHANNEL	Channel 140	FREQUENCY RANGE	1 ~ 40GHz
INPUT POWER (SYSTEM)	120Vac, 60Hz	DETECTOR FUNCTION	Peak (PK) Average (AV)
ENVIRONMENTAL CONDITIONS	24deg. C, 67%RH	TESTED BY	Alan Wu

ANTENNA POLARITY & TEST DISTANCE: HORIZONTAL AT 3 M								
NO.	FREQ. (MHz)	EMISSION LEVEL (dBuV/m)	LIMIT (dBuV/m)	MARGIN (dB)	ANTENNA HEIGHT (m)	TABLE ANGLE (Degree)	RAW VALUE (dBuV)	CORRECTION FACTOR (dB/m)
1	*5700.00	106.4 PK			1.04 H	179	66.30	40.10
2	*5700.00	95.2 AV			1.04 H	179	55.10	40.10
3	#5725.00	59.1 PK	74.0	-14.9	1.07 H	175	52.80	6.30
4	#5725.00	45.6 AV	54.0	-8.4	1.07 H	175	39.30	6.30
5	11400.00	57.5 PK	74.0	-16.5	1.00 H	172	39.30	18.20
6	11400.00	44.7 AV	54.0	-9.3	1.00 H	172	26.50	18.20
ANTENNA POLARITY & TEST DISTANCE: VERTICAL AT 3 M								
NO.	FREQ. (MHz)	EMISSION LEVEL (dBuV/m)	LIMIT (dBuV/m)	MARGIN (dB)	ANTENNA HEIGHT (m)	TABLE ANGLE (Degree)	RAW VALUE (dBuV)	CORRECTION FACTOR (dB/m)
1	*5700.00	100.9 PK			1.02 V	190	60.80	40.10
2	*5700.00	90.4 AV			1.02 V	190	50.30	40.10
3	#5725.00	59.0 PK	74.0	-15.0	1.02 V	189	52.70	6.30
4	#5725.00	45.1 AV	54.0	-8.9	1.02 V	189	38.80	6.30
5	11400.00	57.2 PK	74.0	-16.8	1.00 V	191	39.00	18.20
6	11400.00	44.1 AV	54.0	-9.9	1.00 V	191	25.90	18.20

REMARKS:

1. Emission Level(dBuV/m) = Raw Value(dBuV) + Correction Factor(dB/m)
2. Correction Factor(dB/m) = Antenna Factor(dB/m) + Cable Factor(dB) – Pre-Amplifier Factor(dB)
3. The other emission levels were very low against the limit.
4. Margin value = Emission Level – Limit value
5. “ * “: Fundamental frequency.
6. “#”:The radiated frequency is out the restricted band.

802.11n (40MHz)

EUT TEST CONDITION		MEASUREMENT DETAIL	
CHANNEL	Channel 38	FREQUENCY RANGE	1 ~ 40GHz
INPUT POWER (SYSTEM)	120Vac, 60Hz	DETECTOR FUNCTION	Peak (PK) Average (AV)
ENVIRONMENTAL CONDITIONS	24deg. C, 67%RH	TESTED BY	Alan Wu

ANTENNA POLARITY & TEST DISTANCE: HORIZONTAL AT 3 M								
NO.	FREQ. (MHz)	EMISSION LEVEL (dBuV/m)	LIMIT (dBuV/m)	MARGIN (dB)	ANTENNA HEIGHT (m)	TABLE ANGLE (Degree)	RAW VALUE (dBuV)	CORRECTION FACTOR (dB/m)
1	5150.00	59.4 PK	74.0	-14.6	1.00 H	209	54.00	5.40
2	5150.00	47.6 AV	54.0	-6.4	1.00 H	209	42.20	5.40
3	*5190.00	101.2 PK			1.00 H	202	61.90	39.30
4	*5190.00	90.1 AV			1.00 H	202	50.80	39.30
5	#10380.00	57.1 PK	74.0	-16.9	1.00 H	178	41.00	16.10
6	#10380.00	44.2 AV	54.0	-9.8	1.00 H	178	28.10	16.10

ANTENNA POLARITY & TEST DISTANCE: VERTICAL AT 3 M								
NO.	FREQ. (MHz)	EMISSION LEVEL (dBuV/m)	LIMIT (dBuV/m)	MARGIN (dB)	ANTENNA HEIGHT (m)	TABLE ANGLE (Degree)	RAW VALUE (dBuV)	CORRECTION FACTOR (dB/m)
1	5150.00	58.3 PK	74.0	-15.7	1.28 V	198	52.90	5.40
2	5150.00	46.3 AV	54.0	-7.7	1.28 V	198	40.90	5.40
3	*5190.00	96.2 PK			1.25 V	200	56.90	39.30
4	*5190.00	85.5 AV			1.25 V	200	46.20	39.30
5	#10380.00	56.8 PK	74.0	-17.2	1.00 V	196	40.70	16.10
6	#10380.00	43.6 AV	54.0	-10.4	1.00 V	196	27.50	16.10

REMARKS:

1. Emission Level(dBuV/m) = Raw Value(dBuV) + Correction Factor(dB/m)
2. Correction Factor(dB/m) = Antenna Factor(dB/m) + Cable Factor(dB) – Pre-Amplifier Factor(dB)
3. The other emission levels were very low against the limit.
4. Margin value = Emission Level – Limit value
5. “ * “: Fundamental frequency.
6. “#”:The radiated frequency is out the restricted band.



A D T

EUT TEST CONDITION		MEASUREMENT DETAIL	
CHANNEL	Channel 46	FREQUENCY RANGE	1 ~ 40GHz
INPUT POWER (SYSTEM)	120Vac, 60Hz	DETECTOR FUNCTION	Peak (PK) Average (AV)
ENVIRONMENTAL CONDITIONS	24deg. C, 67%RH	TESTED BY	Alan Wu

ANTENNA POLARITY & TEST DISTANCE: HORIZONTAL AT 3 M								
NO.	FREQ. (MHz)	EMISSION LEVEL (dBuV/m)	LIMIT (dBuV/m)	MARGIN (dB)	ANTENNA HEIGHT (m)	TABLE ANGLE (Degree)	RAW VALUE (dBuV)	CORRECTION FACTOR (dB/m)
1	*5230.00	101.1 PK			1.00 H	234	61.80	39.30
2	*5230.00	90.3 AV			1.00 H	234	51.00	39.30
3	#10460.00	57.2 PK	74.0	-16.8	1.00 H	175	40.60	16.60
4	#10460.00	45.0 AV	54.0	-9.0	1.00 H	175	28.40	16.60
ANTENNA POLARITY & TEST DISTANCE: VERTICAL AT 3 M								
NO.	FREQ. (MHz)	EMISSION LEVEL (dBuV/m)	LIMIT (dBuV/m)	MARGIN (dB)	ANTENNA HEIGHT (m)	TABLE ANGLE (Degree)	RAW VALUE (dBuV)	CORRECTION FACTOR (dB/m)
1	*5230.00	96.1 PK			1.18 V	200	56.80	39.30
2	*5230.00	85.3 AV			1.18 V	200	46.00	39.30
3	#10460.00	56.9 PK	74.0	-17.1	1.00 V	206	40.30	16.60
4	#10460.00	44.0 AV	54.0	-10.0	1.00 V	206	27.40	16.60

REMARKS:

1. Emission Level(dBuV/m) = Raw Value(dBuV) + Correction Factor(dB/m)
2. Correction Factor(dB/m) = Antenna Factor(dB/m) + Cable Factor(dB)
– Pre-Amplifier Factor(dB)
3. The other emission levels were very low against the limit.
4. Margin value = Emission Level – Limit value
5. “ * “: Fundamental frequency.
6. “#”:The radiated frequency is out the restricted band.



A D T

EUT TEST CONDITION		MEASUREMENT DETAIL	
CHANNEL	Channel 54	FREQUENCY RANGE	1 ~ 40GHz
INPUT POWER (SYSTEM)	120Vac, 60Hz	DETECTOR FUNCTION	Peak (PK) Average (AV)
ENVIRONMENTAL CONDITIONS	24deg. C, 67%RH	TESTED BY	Alan Wu

ANTENNA POLARITY & TEST DISTANCE: HORIZONTAL AT 3 M								
NO.	FREQ. (MHz)	EMISSION LEVEL (dBuV/m)	LIMIT (dBuV/m)	MARGIN (dB)	ANTENNA HEIGHT (m)	TABLE ANGLE (Degree)	RAW VALUE (dBuV)	CORRECTION FACTOR (dB/m)
1	*5270.00	102.5 PK			1.00 H	212	63.10	39.40
2	*5270.00	91.3 AV			1.00 H	212	51.90	39.40
3	#10540.00	57.5 PK	74.0	-16.5	1.00 H	182	40.80	16.70
4	#10540.00	45.2 AV	54.0	-8.8	1.00 H	182	28.50	16.70
ANTENNA POLARITY & TEST DISTANCE: VERTICAL AT 3 M								
NO.	FREQ. (MHz)	EMISSION LEVEL (dBuV/m)	LIMIT (dBuV/m)	MARGIN (dB)	ANTENNA HEIGHT (m)	TABLE ANGLE (Degree)	RAW VALUE (dBuV)	CORRECTION FACTOR (dB/m)
1	*5270.00	97.5 PK			1.28 V	195	58.10	39.40
2	*5270.00	86.3 AV			1.28 V	195	46.90	39.40
3	#10540.00	57.2 PK	74.0	-16.8	1.00 V	210	40.50	16.70
4	#10540.00	45.0 AV	54.0	-9.0	1.00 V	210	28.30	16.70

REMARKS:

1. Emission Level(dBuV/m) = Raw Value(dBuV) + Correction Factor(dB/m)
2. Correction Factor(dB/m) = Antenna Factor(dB/m) + Cable Factor(dB)
– Pre-Amplifier Factor(dB)
3. The other emission levels were very low against the limit.
4. Margin value = Emission Level – Limit value
5. “ * “: Fundamental frequency.
6. “#”:The radiated frequency is out the restricted band.



A D T

EUT TEST CONDITION		MEASUREMENT DETAIL	
CHANNEL	Channel 62	FREQUENCY RANGE	1 ~ 40GHz
INPUT POWER (SYSTEM)	120Vac, 60Hz	DETECTOR FUNCTION	Peak (PK) Average (AV)
ENVIRONMENTAL CONDITIONS	24deg. C, 67%RH	TESTED BY	Alan Wu

ANTENNA POLARITY & TEST DISTANCE: HORIZONTAL AT 3 M								
NO.	FREQ. (MHz)	EMISSION LEVEL (dBuV/m)	LIMIT (dBuV/m)	MARGIN (dB)	ANTENNA HEIGHT (m)	TABLE ANGLE (Degree)	RAW VALUE (dBuV)	CORRECTION FACTOR (dB/m)
1	*5310.00	102.9 PK			1.00 H	194	63.50	39.40
2	*5310.00	92.6 AV			1.00 H	194	53.20	39.40
3	5350.00	64.4 PK	74.0	-9.6	1.00 H	194	58.90	5.50
4	5350.00	51.0 AV	54.0	-3.0	1.00 H	194	45.50	5.50
5	10620.00	57.4 PK	74.0	-16.6	1.00 H	175	40.70	16.70
6	10620.00	44.9 AV	54.0	-9.1	1.00 H	175	28.20	16.70

ANTENNA POLARITY & TEST DISTANCE: VERTICAL AT 3 M								
NO.	FREQ. (MHz)	EMISSION LEVEL (dBuV/m)	LIMIT (dBuV/m)	MARGIN (dB)	ANTENNA HEIGHT (m)	TABLE ANGLE (Degree)	RAW VALUE (dBuV)	CORRECTION FACTOR (dB/m)
1	*5310.00	97.5 PK			1.34 V	194	58.10	39.40
2	*5310.00	86.4 AV			1.34 V	194	47.00	39.40
3	5350.00	60.7 PK	74.0	-13.3	1.34 V	198	55.20	5.50
4	5350.00	47.4 AV	54.0	-6.6	1.34 V	198	41.90	5.50
5	10620.00	57.1 PK	74.0	-16.9	1.00 V	194	40.40	16.70
6	10620.00	44.3 AV	54.0	-9.7	1.00 V	194	27.60	16.70

REMARKS:

1. Emission Level(dBuV/m) = Raw Value(dBuV) + Correction Factor(dB/m)
2. Correction Factor(dB/m) = Antenna Factor(dB/m) + Cable Factor(dB)
– Pre-Amplifier Factor(dB)
3. The other emission levels were very low against the limit.
4. Margin value = Emission Level – Limit value
5. “ * ”: Fundamental frequency.



A D T

EUT TEST CONDITION		MEASUREMENT DETAIL	
CHANNEL	Channel 102	FREQUENCY RANGE	1 ~ 40GHz
INPUT POWER (SYSTEM)	120Vac, 60Hz	DETECTOR FUNCTION	Peak (PK) Average (AV)
ENVIRONMENTAL CONDITIONS	24deg. C, 67%RH	TESTED BY	Alan Wu

ANTENNA POLARITY & TEST DISTANCE: HORIZONTAL AT 3 M								
NO.	FREQ. (MHz)	EMISSION LEVEL (dBuV/m)	LIMIT (dBuV/m)	MARGIN (dB)	ANTENNA HEIGHT (m)	TABLE ANGLE (Degree)	RAW VALUE (dBuV)	CORRECTION FACTOR (dB/m)
1	5460.00	60.9 PK	74.0	-13.1	1.00 H	172	55.30	5.60
2	5460.00	47.0 AV	54.0	-7.0	1.00 H	172	41.40	5.60
3	#5470.00	65.6 PK	74.0	-8.4	1.00 H	172	60.00	5.60
4	#5470.00	50.9 AV	54.0	-3.1	1.00 H	172	45.30	5.60
5	*5510.00	103.1 PK			1.00 H	170	63.50	39.60
6	*5510.00	92.5 AV			1.00 H	170	52.90	39.60
7	11020.00	56.8 PK	74.0	-17.2	1.00 H	177	38.20	18.60
8	11020.00	43.7 AV	54.0	-10.3	1.00 H	177	25.10	18.60
ANTENNA POLARITY & TEST DISTANCE: VERTICAL AT 3 M								
NO.	FREQ. (MHz)	EMISSION LEVEL (dBuV/m)	LIMIT (dBuV/m)	MARGIN (dB)	ANTENNA HEIGHT (m)	TABLE ANGLE (Degree)	RAW VALUE (dBuV)	CORRECTION FACTOR (dB/m)
1	5460.00	60.2 PK	74.0	-13.8	1.16 V	206	54.60	5.60
2	5460.00	46.7 AV	54.0	-7.3	1.16 V	206	41.10	5.60
3	#5470.00	61.1 PK	74.0	-12.9	1.16 V	206	55.50	5.60
4	#5470.00	48.9 AV	54.0	-5.1	1.16 V	206	43.30	5.60
5	*5510.00	97.7 PK			1.18 V	203	58.10	39.60
6	*5510.00	86.8 AV			1.18 V	203	47.20	39.60
7	11020.00	56.4 PK	74.0	-17.6	1.00 V	192	37.80	18.60
8	11020.00	43.5 AV	54.0	-10.5	1.00 V	192	24.90	18.60

REMARKS:

1. Emission Level(dBuV/m) = Raw Value(dBuV) + Correction Factor(dB/m)
2. Correction Factor(dB/m) = Antenna Factor(dB/m) + Cable Factor(dB)
– Pre-Amplifier Factor(dB)
3. The other emission levels were very low against the limit.
4. Margin value = Emission Level – Limit value
5. “ * “: Fundamental frequency.
6. "#":The radiated frequency is out the restricted band.



A D T

EUT TEST CONDITION		MEASUREMENT DETAIL	
CHANNEL	Channel 110	FREQUENCY RANGE	1 ~ 40GHz
INPUT POWER (SYSTEM)	120Vac, 60Hz	DETECTOR FUNCTION	Peak (PK) Average (AV)
ENVIRONMENTAL CONDITIONS	24deg. C, 67%RH	TESTED BY	Alan Wu

ANTENNA POLARITY & TEST DISTANCE: HORIZONTAL AT 3 M								
NO.	FREQ. (MHz)	EMISSION LEVEL (dBuV/m)	LIMIT (dBuV/m)	MARGIN (dB)	ANTENNA HEIGHT (m)	TABLE ANGLE (Degree)	RAW VALUE (dBuV)	CORRECTION FACTOR (dB/m)
1	*5550.00	103.0 PK			1.00 H	178	63.20	39.80
2	*5550.00	92.2 AV			1.00 H	178	52.40	39.80
3	11100.00	56.9 PK	74.0	-17.1	1.00 H	180	38.30	18.60
4	11100.00	43.8 AV	54.0	-10.2	1.00 H	180	25.20	18.60
ANTENNA POLARITY & TEST DISTANCE: VERTICAL AT 3 M								
NO.	FREQ. (MHz)	EMISSION LEVEL (dBuV/m)	LIMIT (dBuV/m)	MARGIN (dB)	ANTENNA HEIGHT (m)	TABLE ANGLE (Degree)	RAW VALUE (dBuV)	CORRECTION FACTOR (dB/m)
1	*5550.00	97.5 PK			1.10 V	183	57.70	39.80
2	*5550.00	86.6 AV			1.10 V	183	46.80	39.80
3	11100.00	56.3 PK	74.0	-17.7	1.00 V	196	37.70	18.60
4	11100.00	43.6 AV	54.0	-10.4	1.00 V	196	25.00	18.60

REMARKS:

1. Emission Level(dBuV/m) = Raw Value(dBuV) + Correction Factor(dB/m)
2. Correction Factor(dB/m) = Antenna Factor(dB/m) + Cable Factor(dB)
– Pre-Amplifier Factor(dB)
3. The other emission levels were very low against the limit.
4. Margin value = Emission Level – Limit value
5. “ * “: Fundamental frequency.
6. “#”:The radiated frequency is out the restricted band.



A D T

EUT TEST CONDITION		MEASUREMENT DETAIL	
CHANNEL	Channel 134	FREQUENCY RANGE	1 ~ 40GHz
INPUT POWER (SYSTEM)	120Vac, 60Hz	DETECTOR FUNCTION	Peak (PK) Average (AV)
ENVIRONMENTAL CONDITIONS	24deg. C, 67%RH	TESTED BY	Alan Wu

ANTENNA POLARITY & TEST DISTANCE: HORIZONTAL AT 3 M								
NO.	FREQ. (MHz)	EMISSION LEVEL (dBuV/m)	LIMIT (dBuV/m)	MARGIN (dB)	ANTENNA HEIGHT (m)	TABLE ANGLE (Degree)	RAW VALUE (dBuV)	CORRECTION FACTOR (dB/m)
1	*5670.00	104.0 PK			1.00 H	203	64.00	40.00
2	*5670.00	93.0 AV			1.00 H	203	53.00	40.00
3	#5725.00	58.4 PK	74.0	-15.6	1.00 H	209	52.10	6.30
4	#5725.00	45.4 AV	54.0	-8.6	1.00 H	209	39.10	6.30
5	11340.00	57.0 PK	74.0	-17.0	1.00 H	179	38.70	18.30
6	11340.00	43.8 AV	54.0	-10.2	1.00 H	179	25.50	18.30
ANTENNA POLARITY & TEST DISTANCE: VERTICAL AT 3 M								
NO.	FREQ. (MHz)	EMISSION LEVEL (dBuV/m)	LIMIT (dBuV/m)	MARGIN (dB)	ANTENNA HEIGHT (m)	TABLE ANGLE (Degree)	RAW VALUE (dBuV)	CORRECTION FACTOR (dB/m)
1	*5670.00	98.3 PK			1.24 V	188	58.30	40.00
2	*5670.00	87.5 AV			1.24 V	188	47.50	40.00
3	#5725.00	58.2 PK	74.0	-15.8	1.29 V	185	51.90	6.30
4	#5725.00	44.9 AV	54.0	-9.1	1.29 V	185	38.60	6.30
5	11340.00	56.5 PK	74.0	-17.5	1.00 V	194	38.20	18.30
6	11340.00	43.1 AV	54.0	-10.9	1.00 V	194	24.80	18.30

REMARKS:

1. Emission Level(dBuV/m) = Raw Value(dBuV) + Correction Factor(dB/m)
2. Correction Factor(dB/m) = Antenna Factor(dB/m) + Cable Factor(dB) – Pre-Amplifier Factor(dB)
3. The other emission levels were very low against the limit.
4. Margin value = Emission Level – Limit value
5. “ * “: Fundamental frequency.
6. “#”:The radiated frequency is out the restricted band.

802.11ac (80MHz)

EUT TEST CONDITION		MEASUREMENT DETAIL	
CHANNEL	Channel 42	FREQUENCY RANGE	1 ~ 40GHz
INPUT POWER (SYSTEM)	120Vac, 60Hz	DETECTOR FUNCTION	Peak (PK) Average (AV)
ENVIRONMENTAL CONDITIONS	24deg. C, 67%RH	TESTED BY	Alan Wu

ANTENNA POLARITY & TEST DISTANCE: HORIZONTAL AT 3 M								
NO.	FREQ. (MHz)	EMISSION LEVEL (dBuV/m)	LIMIT (dBuV/m)	MARGIN (dB)	ANTENNA HEIGHT (m)	TABLE ANGLE (Degree)	RAW VALUE (dBuV)	CORRECTION FACTOR (dB/m)
1	5150.00	64.1 PK	74.0	-9.9	1.00 H	198	58.70	5.40
2	5150.00	52.4 AV	54.0	-1.6	1.00 H	198	47.00	5.40
3	*5210.00	99.9 PK			1.00 H	195	60.60	39.30
4	*5210.00	89.8 AV			1.00 H	195	50.50	39.30
5	#10420.00	56.2 PK	74.0	-17.8	1.00 H	177	39.80	16.40
6	#10420.00	44.0 AV	54.0	-10.0	1.00 H	177	27.60	16.40

ANTENNA POLARITY & TEST DISTANCE: VERTICAL AT 3 M								
NO.	FREQ. (MHz)	EMISSION LEVEL (dBuV/m)	LIMIT (dBuV/m)	MARGIN (dB)	ANTENNA HEIGHT (m)	TABLE ANGLE (Degree)	RAW VALUE (dBuV)	CORRECTION FACTOR (dB/m)
1	5150.00	59.5 PK	74.0	-14.5	1.46 V	186	54.10	5.40
2	5150.00	47.6 AV	54.0	-6.4	1.46 V	186	42.20	5.40
3	*5210.00	94.9 PK			1.50 V	187	55.60	39.30
4	*5210.00	84.0 AV			1.50 V	187	44.70	39.30
5	#10420.00	55.9 PK	74.0	-18.1	1.00 V	192	39.50	16.40
6	#10420.00	43.5 AV	54.0	-10.5	1.00 V	192	27.10	16.40

REMARKS:

1. Emission Level(dBuV/m) = Raw Value(dBuV) + Correction Factor(dB/m)
2. Correction Factor(dB/m) = Antenna Factor(dB/m) + Cable Factor(dB) – Pre-Amplifier Factor(dB)
3. The other emission levels were very low against the limit.
4. Margin value = Emission Level – Limit value
5. “ * “: Fundamental frequency.
6. “#”:The radiated frequency is out the restricted band.

EUT TEST CONDITION		MEASUREMENT DETAIL	
CHANNEL	Channel 58	FREQUENCY RANGE	1 ~ 40GHz
INPUT POWER (SYSTEM)	120Vac, 60Hz	DETECTOR FUNCTION	Peak (PK) Average (AV)
ENVIRONMENTAL CONDITIONS	24deg. C, 67%RH	TESTED BY	Alan Wu

ANTENNA POLARITY & TEST DISTANCE: HORIZONTAL AT 3 M								
NO.	FREQ. (MHz)	EMISSION LEVEL (dBuV/m)	LIMIT (dBuV/m)	MARGIN (dB)	ANTENNA HEIGHT (m)	TABLE ANGLE (Degree)	RAW VALUE (dBuV)	CORRECTION FACTOR (dB/m)
1	*5290.00	101.8 PK			1.00 H	196	62.40	39.40
2	*5290.00	92.3 AV			1.00 H	196	52.90	39.40
3	5350.00	65.9 PK	74.0	-8.1	1.00 H	197	60.40	5.50
4	5350.00	52.8 AV	54.0	-1.2	1.00 H	197	47.30	5.50
5	#10580.00	57.3 PK	74.0	-16.7	1.00 H	176	40.70	16.60
6	#10580.00	44.7 AV	54.0	-9.3	1.00 H	176	28.10	16.60
ANTENNA POLARITY & TEST DISTANCE: VERTICAL AT 3 M								
NO.	FREQ. (MHz)	EMISSION LEVEL (dBuV/m)	LIMIT (dBuV/m)	MARGIN (dB)	ANTENNA HEIGHT (m)	TABLE ANGLE (Degree)	RAW VALUE (dBuV)	CORRECTION FACTOR (dB/m)
1	*5290.00	95.5 PK			1.49 V	186	56.10	39.40
2	*5290.00	85.0 AV			1.49 V	186	45.60	39.40
3	5350.00	61.4 PK	74.0	-12.6	1.46 V	184	55.90	5.50
4	5350.00	48.0 AV	54.0	-6.0	1.46 V	184	42.50	5.50
5	#10580.00	57.0 PK	74.0	-17.0	1.00 V	192	40.40	16.60
6	#10580.00	44.1 AV	54.0	-9.9	1.00 V	192	27.50	16.60

REMARKS:

1. Emission Level(dBuV/m) = Raw Value(dBuV) + Correction Factor(dB/m)
2. Correction Factor(dB/m) = Antenna Factor(dB/m) + Cable Factor(dB)
– Pre-Amplifier Factor(dB)
3. The other emission levels were very low against the limit.
4. Margin value = Emission Level – Limit value
5. “ * “: Fundamental frequency.
6. “#”:The radiated frequency is out the restricted band.



A D T

EUT TEST CONDITION		MEASUREMENT DETAIL	
CHANNEL	Channel 106	FREQUENCY RANGE	1 ~ 40GHz
INPUT POWER (SYSTEM)	120Vac, 60Hz	DETECTOR FUNCTION	Peak (PK) Average (AV)
ENVIRONMENTAL CONDITIONS	24deg. C, 67%RH	TESTED BY	Alan Wu

ANTENNA POLARITY & TEST DISTANCE: HORIZONTAL AT 3 M								
NO.	FREQ. (MHz)	EMISSION LEVEL (dBuV/m)	LIMIT (dBuV/m)	MARGIN (dB)	ANTENNA HEIGHT (m)	TABLE ANGLE (Degree)	RAW VALUE (dBuV)	CORRECTION FACTOR (dB/m)
1	5460.00	64.3 PK	74.0	-9.7	1.07 H	197	58.70	5.60
2	5460.00	51.0 AV	54.0	-3.0	1.07 H	197	45.40	5.60
3	#5470.00	64.7 PK	74.0	-9.3	1.07 H	197	59.10	5.60
4	#5470.00	52.7 AV	54.0	-1.3	1.07 H	197	47.10	5.60
5	*5530.00	100.8 PK			1.06 H	196	61.10	39.70
6	*5530.00	90.7 AV			1.06 H	196	51.00	39.70
7	11060.00	56.5 PK	74.0	-17.5	1.00 H	174	38.00	18.50
8	11060.00	43.5 AV	54.0	-10.5	1.00 H	174	25.00	18.50
ANTENNA POLARITY & TEST DISTANCE: VERTICAL AT 3 M								
NO.	FREQ. (MHz)	EMISSION LEVEL (dBuV/m)	LIMIT (dBuV/m)	MARGIN (dB)	ANTENNA HEIGHT (m)	TABLE ANGLE (Degree)	RAW VALUE (dBuV)	CORRECTION FACTOR (dB/m)
1	5460.00	61.7 PK	74.0	-12.3	1.58 V	196	56.10	5.60
2	5460.00	48.0 AV	54.0	-6.0	1.58 V	196	42.40	5.60
3	#5470.00	62.1 PK	74.0	-11.9	1.58 V	196	56.50	5.60
4	#5470.00	49.9 AV	54.0	-4.1	1.58 V	196	44.30	5.60
5	*5530.00	94.6 PK			1.53 V	191	54.90	39.70
6	*5530.00	84.6 AV			1.53 V	191	44.90	39.70
7	11060.00	56.1 PK	74.0	-17.9	1.00 V	194	37.60	18.50
8	11060.00	42.8 AV	54.0	-11.2	1.00 V	194	24.30	18.50

REMARKS:

1. Emission Level(dBuV/m) = Raw Value(dBuV) + Correction Factor(dB/m)
2. Correction Factor(dB/m) = Antenna Factor(dB/m) + Cable Factor(dB) – Pre-Amplifier Factor(dB)
3. The other emission levels were very low against the limit.
4. Margin value = Emission Level – Limit value
5. “ * “: Fundamental frequency.
6. “#”:The radiated frequency is out the restricted band.

BELOW 1GHz WORST-CASE DATA : 802.11n (20MHz)

EUT TEST CONDITION		MEASUREMENT DETAIL	
CHANNEL	Channel 140	FREQUENCY RANGE	Below 1000MHz
INPUT POWER (SYSTEM)	120Vac, 60Hz	DETECTOR FUNCTION	Quasi-Peak
ENVIRONMENTAL CONDITIONS	25deg. C, 68%RH	TESTED BY	Brad Tung

ANTENNA POLARITY & TEST DISTANCE: HORIZONTAL AT 3 M								
NO.	FREQ. (MHz)	EMISSION LEVEL (dBuV/m)	LIMIT (dBuV/m)	MARGIN (dB)	ANTENNA HEIGHT (m)	TABLE ANGLE (Degree)	RAW VALUE (dBuV)	CORRECTION FACTOR (dB/m)
1	175.43	31.0 QP	43.5	-12.5	1.50 H	278	45.80	-14.80
2	192.89	34.6 QP	43.5	-8.9	1.50 H	278	51.20	-16.60
3	239.46	39.7 QP	46.0	-6.3	2.00 H	262	54.60	-14.90
4	324.84	34.1 QP	46.0	-11.9	1.00 H	122	46.00	-11.90
5	355.89	31.9 QP	46.0	-14.1	1.25 H	245	43.60	-11.70
6	480.07	36.2 QP	46.0	-9.8	1.00 H	82	45.60	-9.40

ANTENNA POLARITY & TEST DISTANCE: VERTICAL AT 3 M								
NO.	FREQ. (MHz)	EMISSION LEVEL (dBuV/m)	LIMIT (dBuV/m)	MARGIN (dB)	ANTENNA HEIGHT (m)	TABLE ANGLE (Degree)	RAW VALUE (dBuV)	CORRECTION FACTOR (dB/m)
1	62.89	34.6 QP	40.0	-5.4	2.00 V	47	49.30	-14.70
2	142.44	33.0 QP	43.5	-10.5	1.00 V	254	47.20	-14.20
3	239.46	39.4 QP	46.0	-6.6	1.00 V	302	54.30	-14.90
4	357.83	30.5 QP	46.0	-15.5	1.50 V	338	42.10	-11.60
5	480.07	40.7 QP	46.0	-5.3	1.25 V	219	50.10	-9.40
6	961.29	35.0 QP	54.0	-19.0	1.25 V	121	35.50	-0.50

REMARKS:

1. Emission Level(dBuV/m) = Raw Value(dBuV) + Correction Factor(dB/m)
2. Correction Factor(dB/m) = Antenna Factor(dB/m) + Cable Factor(dB) – Pre-Amplifier Factor (dB)
3. The other emission levels were very low against the limit.
4. Margin value = Emission Level – Limit value

4.2 CONDUCTED EMISSION MEASUREMENT

4.2.1 LIMITS OF CONDUCTED EMISSION MEASUREMENT

FREQUENCY OF EMISSION (MHz)	CONDUCTED LIMIT (dB μ V)	
	Quasi-peak	Average
0.15 ~ 0.5	66 to 56	56 to 46
0.5 ~ 5	56	46
5 ~ 30	60	50

- NOTE:**
1. The lower limit shall apply at the transition frequencies.
 2. The limit decreases in line with the logarithm of the frequency in the range of 0.15 to 0.50MHz.
 3. All emanations from a class A/B digital device or system, including any network of conductors and apparatus connected thereto, shall not exceed the level of field strengths specified above.

4.2.2 TEST INSTRUMENTS

DESCRIPTION & MANUFACTURER	MODEL NO.	SERIAL NO.	DATE OF CALIBRATION	DUE DATE OF CALIBRATION
Test Receiver ROHDE & SCHWARZ	ESCS30	100289	Nov. 29, 2013	Nov. 28, 2014
RF signal cable Woken	5D-FB	Cable-HYC01-01	Dec. 28, 2012	Dec. 27, 2013
LISN ROHDE & SCHWARZ (Peripheral)	ESH3-Z5	100311	Jul. 17, 2013	Jul. 16, 2014
LISN ROHDE & SCHWARZ (EUT)	ESH3-Z5	835239/001	Feb. 04, 2013	Feb. 03, 2014
Software ADT	BV ADT_Cond_ V7.3.7.3	NA	NA	NA

- NOTE:**
1. The calibration interval of the above test instruments is 12 months and the calibrations are traceable to NML/ROC and NIST/USA.
 2. The test was performed in HwaYa Shielded Room 1.
 3. The VCCI Site Registration No. is C-2040.

4.2.3 TEST PROCEDURES

- a. The EUT was placed 0.4 meters from the conducting wall of the shielded room with EUT being connected to the power mains through a line impedance stabilization network (LISN). Other support units were connected to the power mains through another LISN. The two LISNs provide 50 ohm/ 50uH of coupling impedance for the measuring instrument.
- b. Both lines of the power mains connected to the EUT were checked for maximum conducted interference.
- c. The frequency range from 150kHz to 30MHz was searched. Emission levels under (Limit - 20dB) was not recorded.

NOTE: All modes of operation were investigated and the worst-case emissions are reported.

4.2.4 DEVIATION FROM TEST STANDARD

No deviation.

4.2.5 TEST SETUP

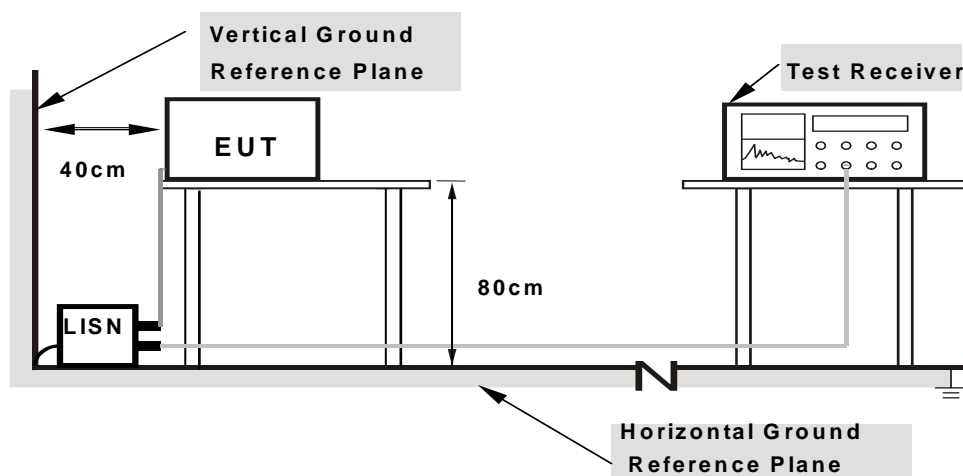

- Note:**
1. Support units were connected to second LISN.
 2. Both of LISNs (AMN) are 80 cm from EUT and at least 80 from other units and other metal planes

For the actual test configuration, please refer to the attached file (Test Setup Photo).

4.2.6 EUT OPERATING CONDITIONS

Same as 4.1.6.

4.2.7 TEST RESULTS

CONDUCTED WORST-CASE DATA : 802.11n (20MHz)

PHASE	Line 1	6dB BANDWIDTH	9kHz
CHANNEL	Channel 140		

No	Freq. [MHz]	Corr. Factor (dB)	Reading Value		Emission Level		Limit		Margin	
			[dB (uV)]		[dB (uV)]		[dB (uV)]		(dB)	
			Q.P.	AV.	Q.P.	AV.	Q.P.	AV.	Q.P.	AV.
1	0.19301	0.16	47.36	31.74	47.52	31.90	63.91	53.91	-16.39	-22.01
2	0.22972	0.17	42.16	29.91	42.33	30.08	62.46	52.46	-20.13	-22.38
3	0.51312	0.23	38.19	32.67	38.42	32.90	56.00	46.00	-17.58	-13.10
4	0.86553	0.25	33.66	22.23	33.91	22.48	56.00	46.00	-22.09	-23.52
5	1.31909	0.26	33.68	24.32	33.94	24.58	56.00	46.00	-22.06	-21.42
6	20.75961	1.27	29.45	24.07	30.72	25.34	60.00	50.00	-29.28	-24.66

REMARKS:

1. Q.P. and AV. are abbreviations of quasi-peak and average individually.
2. The emission levels of other frequencies were very low against the limit.
3. Margin value = Emission level - Limit value
4. Correction factor = Insertion loss + Cable loss
5. Emission Level = Correction Factor + Reading Value

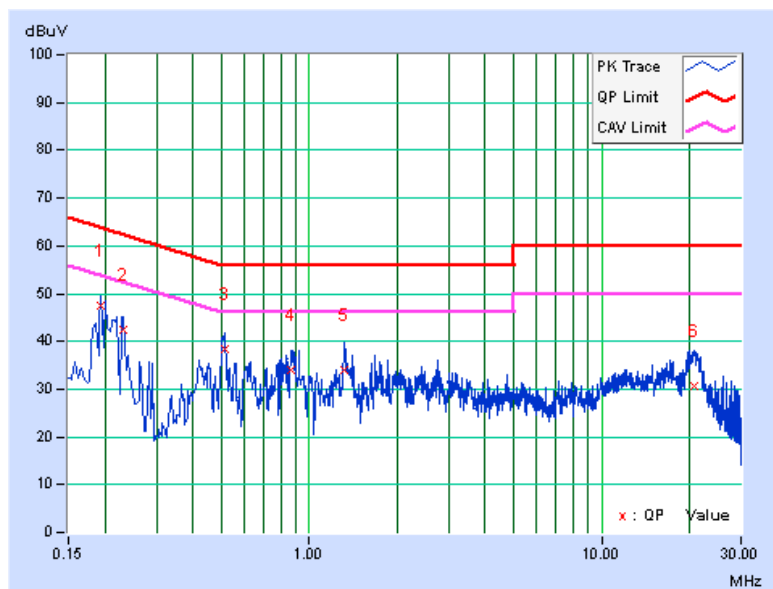



A D T

PHASE	Line 2	6dB BANDWIDTH	9kHz
CHANNEL	Channel 140		

No	Freq. [MHz]	Corr. Factor (dB)	Reading Value		Emission Level		Limit		Margin	
			[dB (uV)]		[dB (uV)]		[dB (uV)]		(dB)	
			Q.P.	AV.	Q.P.	AV.	Q.P.	AV.	Q.P.	AV.
1	0.16173	0.17	47.31	28.14	47.48	28.31	65.37	55.37	-17.90	-27.07
2	0.19717	0.17	47.83	33.96	48.00	34.13	63.73	53.73	-15.73	-19.60
3	0.50000	0.24	38.18	32.12	38.42	32.36	56.00	46.00	-17.58	-13.64
4	0.90895	0.25	33.50	24.00	33.75	24.25	56.00	46.00	-22.25	-21.75
5	1.42075	0.26	32.40	20.89	32.66	21.15	56.00	46.00	-23.34	-24.85
6	20.75179	0.96	43.47	37.82	44.43	38.78	60.00	50.00	-15.57	-11.22

REMARKS:

1. Q.P. and AV. are abbreviations of quasi-peak and average individually.
2. The emission levels of other frequencies were very low against the limit.
3. Margin value = Emission level - Limit value
4. Correction factor = Insertion loss + Cable loss
5. Emission Level = Correction Factor + Reading Value

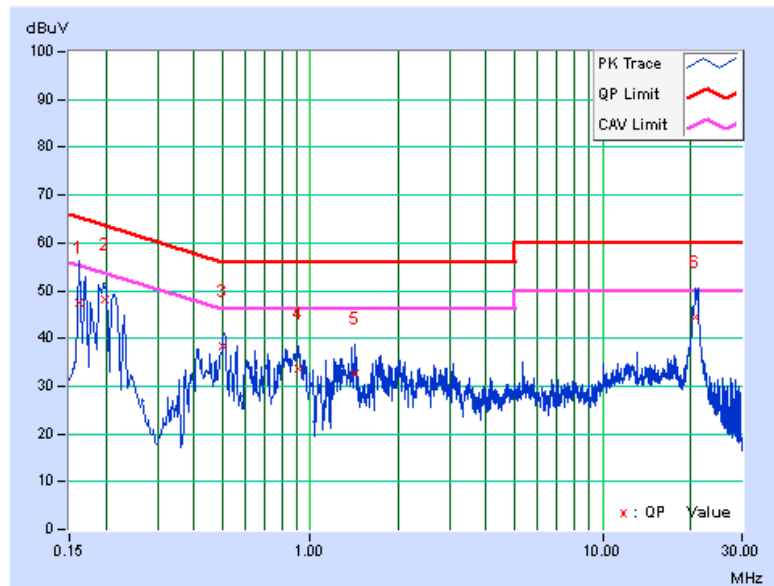

4.3 PEAK TRANSMIT POWER MEASUREMENT

4.3.1 LIMITS OF PEAK TRANSMIT POWER MEASUREMENT

FREQUENCY BAND	LIMIT
5.150 ~ 5.250GHz	The lesser of 50mW (17dBm) or 4dBm + 10logB
5.250 ~ 5.350GHz	The lesser of 250mW (24dBm) or 11dBm + 10logB
5.470 ~ 5.725GHz	The lesser of 250mW (24dBm) or 11dBm + 10logB

NOTE: Where B is the 26dB emission bandwidth in MHz.

Per KDB 662911 D01 Multiple Transmitter Output v02 Method of conducted output power measurement on IEEE 802.11 devices,

Array Gain = 0 dB (i.e., no array gain) for NANT ≤ 4;

Array Gain = 0 dB (i.e., no array gain) for channel widths ≥ 40 MHz for any NANT;

Array Gain = 5 log(NANT/NSS) dB or 3 dB, whichever is less for 20-MHz channel widths with NANT ≥ 5.

For power measurements on all other devices: Array Gain = 10 log(NANT/NSS) dB.

4.3.2 TEST SETUP

FOR POWER OUTPUT MEASUREMENT

For 802.11a, 802.11n (20MHz), 802.11n (40MHz)

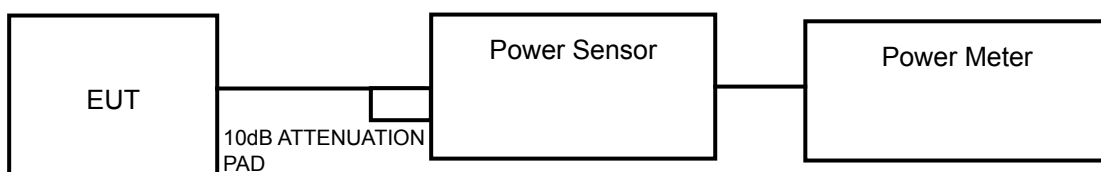

For 802.11ac (80MHz)

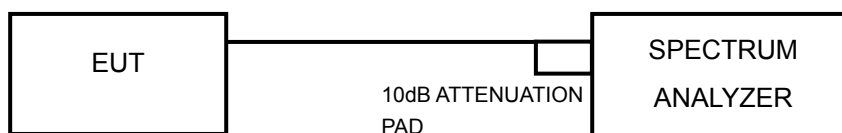

FOR 26dB BANDWIDTH

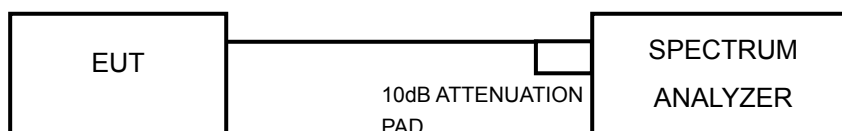

4.3.3 TEST INSTRUMENTS

Refer to section 4.1.3 to get information of above instrument.

4.3.4 TEST PROCEDURE

FOR AVERAGE POWER MEASUREMENT

For 802.11a, 802.11n (20MHz), 802.11n (40MHz)

789033 D01 General UNII Test Procedures Old Rules v01r04 (E/3/b)

Method PM is used to perform output power measurement, trigger and gating function of wide band power meter is enabled to measure max output power of TX on burst. Duty factor is not added to measured value.

For 802.11ac (80MHz)

789033 D01 General UNII Test Procedures Old Rules v01r04 (E/2/b)

- 1) Set span to encompass the entire emission bandwidth (EBW) of the signal.
- 2) Set RBW = 1 MHz.
- 3) Set VBW \geq 3 MHz.
- 4) Number of points in sweep \geq 2 Span / RBW.
- 5) Sweep time = auto.
- 6) Set trigger to free run (duty cycle \geq 98 percent); Set video trigger (duty cycle $<$ 98 percent)
- 7) Detector = RMS.
- 8) Trace average at least 100 traces in power averaging mode
- 9) Compute power by integrating the spectrum across the 26 dB EBW of the signal.

FOR 26dB BANDWIDTH

- 1) Set RBW = approximately 1% of the emission bandwidth.
- 2) Set the VBW $>$ RBW.
- 3) Detector = Peak.
- 4) Trace mode = max hold.
- 5) Measure the maximum width of the emission that is 26 dB down from the peak of the emission. Compare this with the RBW setting of the analyzer. Readjust RBW and repeat measurement as needed until the RBW/EBW ratio is approximately 1%.

4.3.5 DEVIATION FROM TEST STANDARD

No deviation.

4.3.6 EUT OPERATING CONDITIONS

The software provided by client to enable the EUT under transmission condition continuously at specific channel frequencies individually.

4.3.7 TEST RESULTS

POWER OUTPUT:

802.11a

CHANNEL	CHANNEL FREQUENCY (MHz)	AVERAGE POWER (mW)	AVERAGE POWER (dBm)	POWER LIMIT (dBm)	PASS/FAIL
36	5180	39.174	15.93	17	PASS
40	5200	42.267	16.26	17	PASS
48	5240	37.670	15.76	17	PASS
52	5260	38.194	15.82	24	PASS
60	5300	41.115	16.14	24	PASS
64	5320	38.726	15.88	24	PASS
100	5500	40.365	16.06	24	PASS
116	5580	38.371	15.84	24	PASS
140	5700	38.815	15.89	24	PASS

NOTE:

For 5180~5240MHz:

1. $4\text{dBm} + 10\log(20.36) = 17.09\text{dBm} > 17\text{dBm}$.
2. $4\text{dBm} + 10\log(20.42) = 17.10\text{dBm} > 17\text{dBm}$.
3. $4\text{dBm} + 10\log(20.42) = 17.10\text{dBm} > 17\text{dBm}$.

For 5260~5700MHz:

1. $11\text{dBm} + 10\log(20.37) = 24.09\text{dBm} > 24\text{dBm}$.
2. $11\text{dBm} + 10\log(20.36) = 24.09\text{dBm} > 24\text{dBm}$.
3. $11\text{dBm} + 10\log(20.42) = 24.10\text{dBm} > 24\text{dBm}$.
4. $11\text{dBm} + 10\log(20.39) = 24.09\text{dBm} > 24\text{dBm}$.
5. $11\text{dBm} + 10\log(20.37) = 24.09\text{dBm} > 24\text{dBm}$.
6. $11\text{dBm} + 10\log(20.38) = 24.09\text{dBm} > 24\text{dBm}$.

**802.11n (20MHz)**

CHAN.	CHAN. FREQ. (MHz)	AVERAGE POWER (dBm)		TOTAL POWER (mW)	TOTAL POWER (dBm)	POWER LIMIT (dBm)	PASS / FAIL
		CHAIN 0	CHAIN 1				
36	5180	13.71	13.58	46.299	16.66	17	PASS
40	5200	13.93	13.67	47.998	16.81	17	PASS
48	5240	13.94	13.76	48.542	16.86	17	PASS
52	5260	15.99	15.69	76.787	18.85	24	PASS
60	5300	15.96	15.75	77.030	18.87	24	PASS
64	5320	15.84	15.87	77.008	18.87	24	PASS
100	5500	15.95	15.76	77.025	18.87	24	PASS
116	5580	15.76	15.85	76.129	18.82	24	PASS
140	5700	15.88	15.89	77.541	18.90	24	PASS

NOTE:**For 5180~5240MHz:****CHAIN 0**

1. $4\text{dBm} + 10\log(20.70) = 17.16\text{dBm} > 17\text{dBm}$.
2. $4\text{dBm} + 10\log(20.70) = 17.16\text{dBm} > 17\text{dBm}$.
3. $4\text{dBm} + 10\log(20.84) = 17.19\text{dBm} > 17\text{dBm}$.

CHAIN 1

1. $4\text{dBm} + 10\log(20.73) = 17.17\text{dBm} > 17\text{dBm}$.
2. $4\text{dBm} + 10\log(20.49) = 17.12\text{dBm} > 17\text{dBm}$.
3. $4\text{dBm} + 10\log(20.60) = 17.14\text{dBm} > 17\text{dBm}$.

For 5260~5700MHz:**CHAIN 0**

1. $11\text{dBm} + 10\log(20.71) = 24.16\text{dBm} > 24\text{dBm}$.
2. $11\text{dBm} + 10\log(20.65) = 24.15\text{dBm} > 24\text{dBm}$.
3. $11\text{dBm} + 10\log(20.81) = 24.18\text{dBm} > 24\text{dBm}$.
4. $11\text{dBm} + 10\log(21.11) = 24.24\text{dBm} > 24\text{dBm}$.
5. $11\text{dBm} + 10\log(20.99) = 24.22\text{dBm} > 24\text{dBm}$.
6. $11\text{dBm} + 10\log(21.08) = 24.24\text{dBm} > 24\text{dBm}$.

CHAIN 1

1. $11\text{dBm} + 10\log(20.59) = 24.14\text{dBm} > 24\text{dBm}$.
2. $11\text{dBm} + 10\log(20.45) = 24.11\text{dBm} > 24\text{dBm}$.
3. $11\text{dBm} + 10\log(20.61) = 24.14\text{dBm} > 24\text{dBm}$.
4. $11\text{dBm} + 10\log(20.81) = 24.18\text{dBm} > 24\text{dBm}$.
5. $11\text{dBm} + 10\log(20.99) = 24.22\text{dBm} > 24\text{dBm}$.
6. $11\text{dBm} + 10\log(20.67) = 24.15\text{dBm} > 24\text{dBm}$.

**802.11n (40MHz)**

CHAN.	CHAN. FREQ. (MHz)	AVERAGE POWER (dBm)		TOTAL POWER (mW)	TOTAL POWER (dBm)	POWER LIMIT (dBm)	PASS / FAIL
		CHAIN 0	CHAIN 1				
38	5190	13.86	13.80	48.310	16.84	17	PASS
46	5230	13.95	13.62	47.845	16.80	17	PASS
54	5270	15.79	15.77	75.688	18.79	24	PASS
62	5310	15.73	15.70	74.565	18.73	24	PASS
102	5510	16.02	15.53	75.721	18.79	24	PASS
110	5550	15.89	15.71	76.054	18.81	24	PASS
134	5670	15.96	15.73	76.857	18.86	24	PASS

NOTE:**For 5180~5240MHz:****CHAIN 0**

1. $4\text{dBm} + 10\log(43.65) = 20.40\text{dBm} > 17\text{dBm}$.
2. $4\text{dBm} + 10\log(43.98) = 20.43\text{dBm} > 17\text{dBm}$.

CHAIN 1

1. $4\text{dBm} + 10\log(43.37) = 20.37\text{dBm} > 17\text{dBm}$.
2. $4\text{dBm} + 10\log(43.39) = 20.34\text{dBm} > 17\text{dBm}$.

For 5260~5700MHz:**CHAIN 0**

1. $11\text{dBm} + 10\log(44.11) = 27.45\text{dBm} > 24\text{dBm}$.
2. $11\text{dBm} + 10\log(43.80) = 27.41\text{dBm} > 24\text{dBm}$.
3. $11\text{dBm} + 10\log(44.09) = 27.44\text{dBm} > 24\text{dBm}$.
4. $11\text{dBm} + 10\log(44.12) = 27.45\text{dBm} > 24\text{dBm}$.
5. $11\text{dBm} + 10\log(44.03) = 27.44\text{dBm} > 24\text{dBm}$.

CHAIN 1

1. $11\text{dBm} + 10\log(43.46) = 27.38\text{dBm} > 24\text{dBm}$.
2. $11\text{dBm} + 10\log(43.62) = 27.40\text{dBm} > 24\text{dBm}$.
3. $11\text{dBm} + 10\log(43.19) = 27.35\text{dBm} > 24\text{dBm}$.
4. $11\text{dBm} + 10\log(43.04) = 27.34\text{dBm} > 24\text{dBm}$.
5. $11\text{dBm} + 10\log(43.29) = 27.36\text{dBm} > 24\text{dBm}$.



802.11ac (80MHz)

CHAN.	CHAN. FREQ. (MHz)	AVERAGE POWER (dBm)		TOTAL POWER (mW)	TOTAL POWER (dBm)	POWER LIMIT (dBm)	PASS / FAIL
		CHAIN 0	CHAIN 1				
42	5210	13.58	13.67	46.084	16.64	17	PASS
58	5290	16.00	15.69	76.879	18.86	24	PASS
106	5530	15.67	15.87	75.535	18.78	24	PASS

NOTE:

For 5180~5240MHz:

CHAIN 0

1. $4\text{dBm} + 10\log(84.94) = 23.29\text{dBm} > 17\text{dBm}$.

CHAIN 1

1. $4\text{dBm} + 10\log(84.06) = 23.25\text{dBm} > 17\text{dBm}$.

For 5260~5700MHz:

CHAIN 0

1. $11\text{dBm} + 10\log(84.64) = 30.28\text{dBm} > 24\text{dBm}$.

2. $11\text{dBm} + 10\log(84.74) = 30.28\text{dBm} > 24\text{dBm}$.

CHAIN 1

1. $11\text{dBm} + 10\log(84.25) = 30.26\text{dBm} > 24\text{dBm}$.

2. $11\text{dBm} + 10\log(85.36) = 30.31\text{dBm} > 24\text{dBm}$.



26dB BANDWIDTH:

802.11a

CHANNEL	CHANNEL FREQUENCY (MHz)	26dBc BANDWIDTH (MHz)	PASS / FAIL
36	5180	20.36	PASS
40	5200	20.42	PASS
48	5240	20.42	PASS
52	5260	20.37	PASS
60	5300	20.36	PASS
64	5320	20.42	PASS
100	5500	20.39	PASS
116	5580	20.37	PASS
140	5700	20.38	PASS

802.11n (20MHz)

CHANNEL	CHANNEL FREQUENCY (MHz)	26dBc BANDWIDTH (MHz)		PASS / FAIL
		CHAIN 0	CHAIN 1	
36	5180	20.70	20.73	PASS
40	5200	20.70	20.49	PASS
48	5240	20.84	20.60	PASS
52	5260	20.71	20.59	PASS
60	5300	20.65	20.45	PASS
64	5320	20.81	20.61	PASS
100	5500	21.11	20.81	PASS
116	5580	20.99	20.99	PASS
140	5700	21.08	20.67	PASS



802.11n (40MHz)

CHANNEL	CHANNEL FREQUENCY (MHz)	26dBc BANDWIDTH (MHz)		PASS / FAIL
		CHAIN 0	CHAIN 1	
38	5190	43.65	43.37	PASS
46	5230	43.98	43.09	PASS
54	5270	44.11	43.46	PASS
62	5310	43.80	43.62	PASS
102	5510	44.09	43.19	PASS
110	5550	44.12	43.04	PASS
134	5670	44.03	43.29	PASS

802.11ac (80MHz)

CHANNEL	CHANNEL FREQUENCY (MHz)	26dBc BANDWIDTH (MHz)		PASS / FAIL
		CHAIN 0	CHAIN 1	
42	5210	84.94	84.06	PASS
58	5290	84.64	84.25	PASS
106	5530	84.74	85.36	PASS



A D T

SPECTRUM PLOT OF WORST VALUE

802.11a

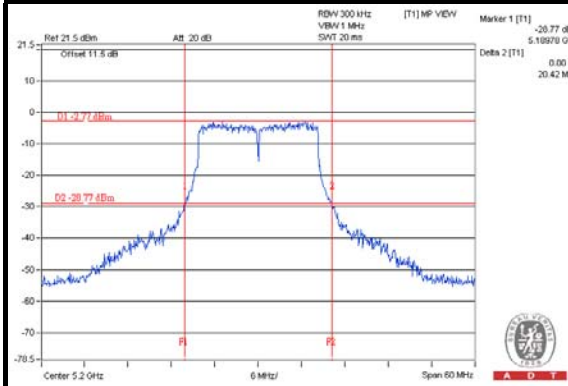

802.11n (20MHz)

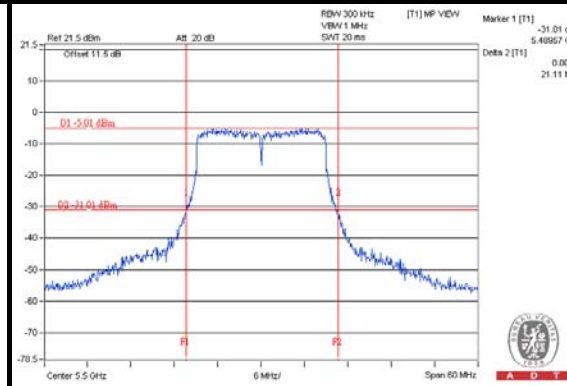

802.11n (40MHz)

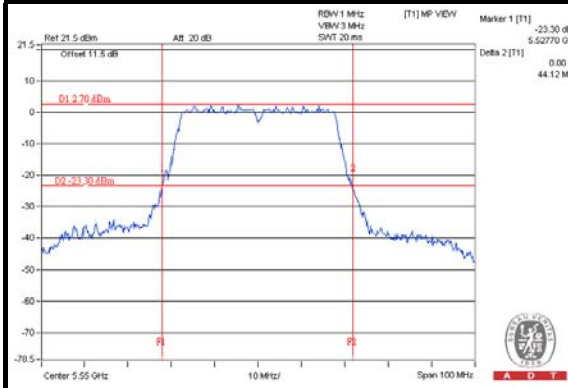

802.11ac (80MHz)

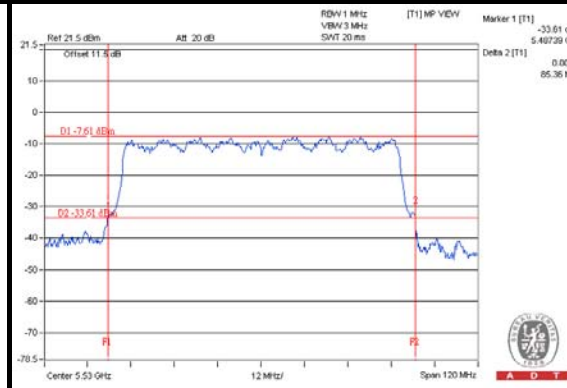

EUT MAXIMUM CONDUCTED POWER

802.11a

FREQUENCY BAND (MHz)	MAX. POWER	
	OUTPUT POWER (mW)	OUTPUT POWER (dBm)
5250~5350	41.115	16.14
5470~5725	40.365	16.06

NOTE: Manufacturer provides Transmit Power Control description to meet this requirement.

802.11n (20MHz)

FREQUENCY BAND (MHz)	MAX. POWER	
	OUTPUT POWER (mW)	OUTPUT POWER (dBm)
5250~5350	77.030	18.87
5470~5725	77.541	18.90

NOTE: Manufacturer provides Transmit Power Control description to meet this requirement.

802.11n (40MHz)

FREQUENCY BAND (MHz)	MAX. POWER	
	OUTPUT POWER (mW)	OUTPUT POWER (dBm)
5250~5350	75.688	18.79
5470~5725	76.857	18.86

NOTE: Manufacturer provides Transmit Power Control description to meet this requirement.

802.11ac (80MHz)

FREQUENCY BAND (MHz)	MAX. POWER	
	OUTPUT POWER (mW)	OUTPUT POWER (dBm)
5250~5350	76.879	18.86
5470~5725	75.535	18.78

NOTE: Manufacturer provides Transmit Power Control description to meet this requirement.

4.4 PEAK POWER SPECTRAL DENSITY MEASUREMENT

4.4.1 LIMITS OF PEAK POWER SPECTRAL DENSITY MEASUREMENT

FREQUENCY BAND	LIMIT
5.150 ~ 5.250GHz	4dBm
5.250 ~ 5.350GHz	11dBm
5.470 ~ 5.725GHz	11dBm

4.4.2 TEST SETUP

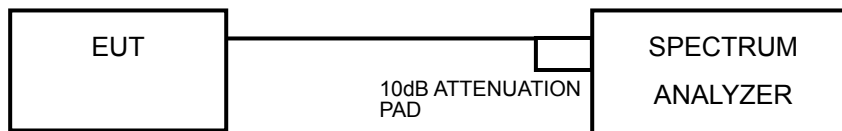

4.4.3 TEST INSTRUMENTS

Refer to section 4.1.3 to get information of above instrument.

4.4.4 TEST PROCEDURES

789033 D01 General UNII Test Procedures Old Rules v01r04 (F)

- 1) Set span to encompass the entire emission bandwidth (EBW) of the signal.
- 2) Set RBW = 30 KHz, Set VBW \geq 1 MHz, Detector = RMS
- 3) Set Channel power measure = 1MHz
- 4) Sweep time = 30ms.
- 5) Perform a single sweep.
- 6) Record the max value

4.4.5 DEVIATION FROM TEST STANDARD

No deviation.

4.4.6 EUT OPERATING CONDITIONS

Same as 4.3.6.

4.4.7 TEST RESULTS

802.11a

CHANNEL	FREQUENCY (MHz)	PSD (dBm)	MAXIMUM LIMIT (dBm)	PASS/FAIL
36	5180	-0.70	4	PASS
40	5200	-0.52	4	PASS
48	5240	-0.47	4	PASS
52	5260	-0.17	11	PASS
60	5300	0.30	11	PASS
64	5320	0.43	11	PASS
100	5500	0.04	11	PASS
116	5580	0.26	11	PASS
140	5700	-0.64	11	PASS

802.11n (20MHz)

CHAN.	CHAN. FREQ. (MHz)	PSD (dBm)		TOTAL POWER DENSITY (dBm)	MAX. LIMIT (dBm)	PASS / FAIL
		CHAIN 0	CHAIN 1			
36	5180	-5.49	-5.28	-2.37	3.64	PASS
40	5200	-4.89	-3.89	-1.35	3.64	PASS
48	5240	-4.05	-3.07	-0.52	3.64	PASS
52	5260	-2.33	-1.92	0.89	10.62	PASS
60	5300	-2.86	-1.86	0.68	10.62	PASS
64	5320	-3.11	-1.93	0.53	10.62	PASS
100	5500	-2.65	-0.80	1.38	10.21	PASS
116	5580	-2.21	-1.00	1.45	10.21	PASS
140	5700	-3.90	-0.86	0.89	10.21	PASS

NOTE: 1. Method 1 of power density measurement of KDB 662911 is using for calculating total power density. Total power density is summing entire spectra across corresponding frequency bins on the various outputs by computer.

2. For 5180~5240MHz:

Directional gain = $10 \log[(10^{G1/20} + 10^{G2/20} + \dots + 10^{GN/20})^2 / N_{ANT}] = 6.36 > 6\text{dBi}$, so the power density limit shall be reduced to $4 - (6.36 - 6) = 3.64\text{dBm}$.

For 5260~5320MHz:

Directional gain = $10 \log[(10^{G1/20} + 10^{G2/20} + \dots + 10^{GN/20})^2 / N_{ANT}] = 6.38 > 6\text{dBi}$, so the power density limit shall be reduced to $11 - (6.38 - 6) = 10.62\text{dBm}$.

For 5500~5700MHz:

Directional gain = $10 \log[(10^{G1/20} + 10^{G2/20} + \dots + 10^{GN/20})^2 / N_{ANT}] = 6.79 > 6\text{dBi}$, so the power density limit shall be reduced to $11 - (6.79 - 6) = 10.21\text{dBm}$.

**802.11n (40MHz)**

CHAN.	CHAN. FREQ. (MHz)	PSD (dBm)		TOTAL POWER DENSITY (dBm)	MAX. LIMIT (dBm)	PASS / FAIL
		CHAIN 0	CHAIN 1			
38	5190	-8.45	-7.61	-5.00	3.64	PASS
46	5230	-7.51	-6.92	-4.20	3.64	PASS
54	5270	-6.69	-4.88	-2.68	10.62	PASS
62	5310	-6.49	-4.15	-2.15	10.62	PASS
102	5510	-6.15	-3.63	-1.70	10.21	PASS
110	5550	-5.89	-3.95	-1.80	10.21	PASS
134	5670	-5.80	-5.02	-2.38	10.21	PASS

NOTE: 1. Method 1 of power density measurement of KDB 662911 is using for calculating total power density. Total power density is summing entire spectra across corresponding frequency bins on the various outputs by computer.

2. For 5190~5230MHz:

Directional gain = $10 \log[(10^{G^1/20} + 10^{G^2/20} + \dots + 10^{G^N/20})^2 / N_{ANT}] = 6.36 > 6\text{dBi}$, so the power density limit shall be reduced to $4 - (6.36 - 6) = 3.64\text{dBm}$.

For 5270~5310MHz:

Directional gain = $10 \log[(10^{G^1/20} + 10^{G^2/20} + \dots + 10^{G^N/20})^2 / N_{ANT}] = 6.38 > 6\text{dBi}$, so the power density limit shall be reduced to $11 - (6.38 - 6) = 10.62\text{dBm}$.

For 5510~5670MHz:

Directional gain = $10 \log[(10^{G^1/20} + 10^{G^2/20} + \dots + 10^{G^N/20})^2 / N_{ANT}] = 6.79 > 6\text{dBi}$, so the power density limit shall be reduced to $11 - (6.79 - 6) = 10.21\text{dBm}$.



802.11ac (80MHz)

CHAN.	CHAN. FREQ. (MHz)	PSD (dBm)		TOTAL POWER DENSITY (dBm)	MAX. LIMIT (dBm)	PASS / FAIL
		CHAIN 0	CHAIN 1			
42	5210	-11.46	-20.27	-10.93	3.64	PASS
58	5290	-9.05	-17.33	-8.45	10.62	PASS
106	5530	-8.14	-16.31	-7.52	10.21	PASS

NOTE: 1. Method 1 of power density measurement of KDB 662911 is using for calculating total power density. Total power density is summing entire spectra across corresponding frequency bins on the various outputs by computer.

2. For 5210MHz:

Directional gain = $10 \log[(10^{G^1/20} + 10^{G^2/20} + \dots + 10^{G^N/20})^2 / N_{ANT}] = 6.36 > 6\text{dBi}$, so the power density limit shall be reduced to $4 - (6.36 - 6) = 3.64\text{dBm}$.

For 5290MHz:

Directional gain = $10 \log[(10^{G^1/20} + 10^{G^2/20} + \dots + 10^{G^N/20})^2 / N_{ANT}] = 6.38 > 6\text{dBi}$, so the power density limit shall be reduced to $11 - (6.38 - 6) = 10.62\text{dBm}$.

For 5530MHz:

Directional gain = $10 \log[(10^{G^1/20} + 10^{G^2/20} + \dots + 10^{G^N/20})^2 / N_{ANT}] = 6.79 > 6\text{dBi}$, so the power density limit shall be reduced to $11 - (6.79 - 6) = 10.21\text{dBm}$.



A D T

SPECTRUM PLOT OF WORST VALUE

802.11a

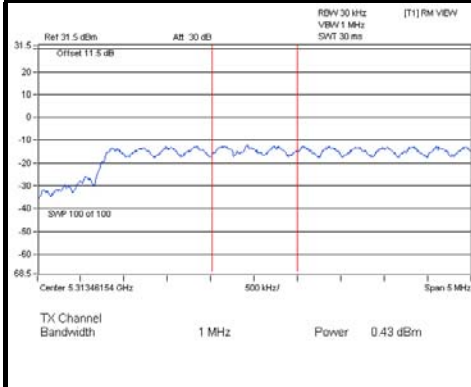

802.11n (20MHz)

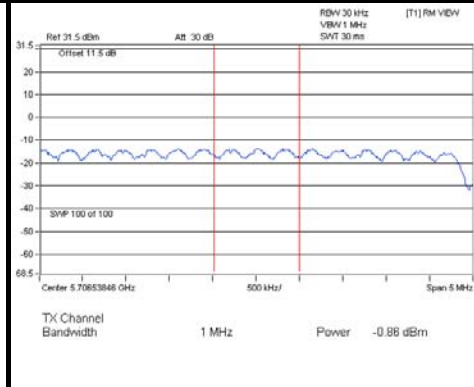

802.11n (40MHz)

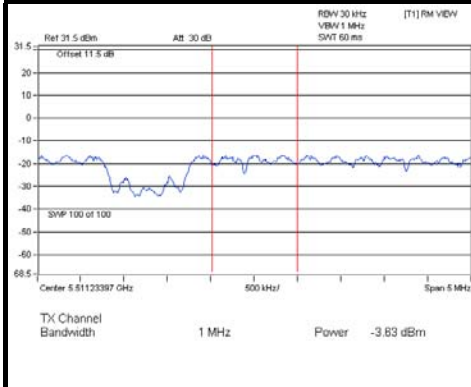

802.11ac (80MHz)

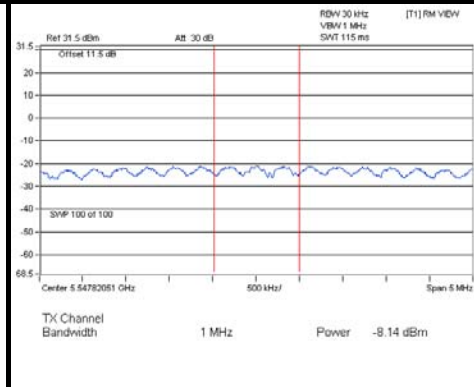

4.5 PEAK POWER EXCURSION MEASUREMENT

4.5.1 LIMITS OF PEAK POWER EXCURSION MEASUREMENT

Shall not exceed 13 dB.

4.5.2 TEST SETUP

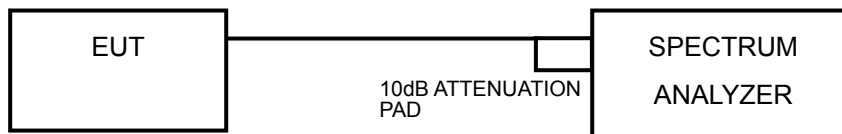

4.5.3 TEST INSTRUMENTS

Refer to section 4.1.3 to get information of above instrument.

4.5.4 TEST PROCEDURE

789033 D01 General UNII Test Procedures Old Rules v01r04 (G)

- 1) Set RBW = 1 MHz, VBW \geq 3 MHz, Detector = peak.
- 2) Trace mode = max-hold. Allow the sweeps to continue until the trace stabilizes.
- 3) Use the peak search function to find the peak of the spectrum.
- 4) Measure the PPSD.
- 5) Compute the ratio of the maximum of the peak-max-hold spectrum to the PPSD.
Find the worst channel and modulation mode as above test procedure, and follow KDB 789033 D01 General UNII Test Procedures v01r03 and repeat step 1 to 5 for final testing of each modulation mode on a single channel (all modulation types) in a single operating band to compliance with the peak excursion requirement.

4.5.5 DEVIATION FROM TEST STANDARD

No deviation.

4.5.6 EUT OPERATING CONDITIONS

Same as 4.2.6



A D T

4.5.7 TEST RESULTS

MODULATION MODE	MODULATION TYPE	CHANNEL FREQUENCY (MHz)	PEAK VALUE (dBm)	PPSD (dBm)	PEAK EXCURSION (dB)	LIMIT (dB)	PASS/ FAIL
802.11a	BPSK	5700	6.73	-0.64	7.37	13	PASS
	QPSK		7.98	-1.10	9.08	13	PASS
	16QAM		7.20	-1.11	8.31	13	PASS
	64QAM		8.22	-1.08	9.30	13	PASS
802.11n (20MHz)	BPSK	5700	3.62	-3.90	7.52	13	PASS
	QPSK		7.28	-0.58	7.86	13	PASS
	16QAM		7.77	-1.05	8.82	13	PASS
	64QAM		7.71	-1.50	9.21	13	PASS
802.11n (40MHz)	BPSK	5670	2.85	-5.80	8.65	13	PASS
	QPSK		3.75	-4.81	8.56	13	PASS
	16QAM		3.67	-5.39	9.06	13	PASS
	64QAM		2.82	-5.09	7.91	13	PASS
802.11ac (80MHz)	BPSK	5530	-0.28	-8.14	7.86	13	PASS
	QPSK		-0.85	-9.76	8.91	13	PASS
	16QAM		-1.04	-9.18	8.14	13	PASS
	64QAM		-0.33	-9.27	8.94	13	PASS
	256QAM		-0.95	-9.02	8.07	13	PASS

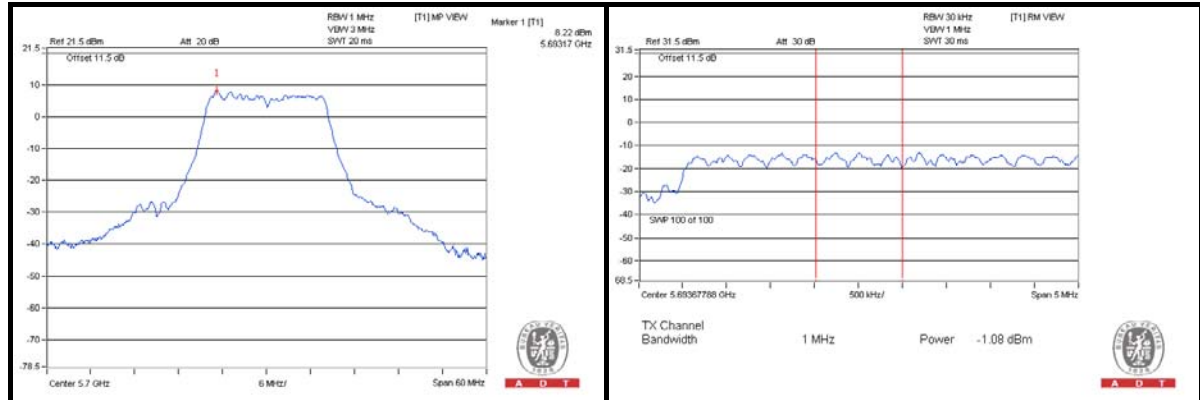

4.6 FREQUENCY STABILITY

4.6.1 LIMITS OF FREQUENCY STABILITY MEASUREMENT

The frequency of the carrier signal shall be maintained within band of operation

4.6.2 TEST SETUP

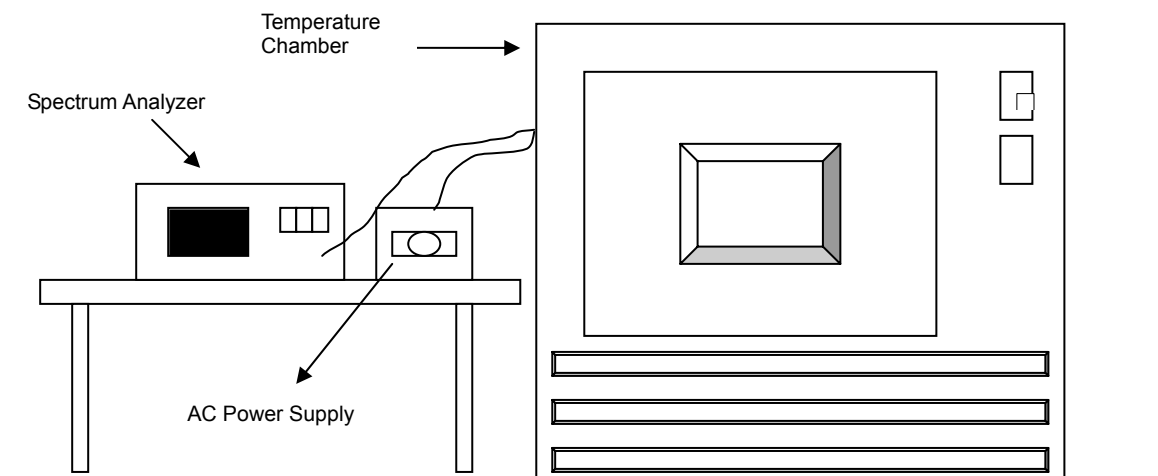

4.6.3 TEST INSTRUMENTS

Refer to section 4.1.3 to get information of above instrument.

4.6.4 TEST PROCEDURE

- a. The EUT was placed inside the environmental test chamber and powered by nominal AC voltage.
- b. Turn the EUT on and couple its output to a spectrum analyzer.
- c. Turn the EUT off and set the chamber to the highest temperature specified.
- d. Allow sufficient time (approximately 30 min) for the temperature of the chamber to stabilize, turn the EUT on and measure the operating frequency after 2, 5, and 10 minutes.
- e. Repeat step 2 and 3 with the temperature chamber set to the lowest temperature.
- f. The test chamber was allowed to stabilize at +20 degree C for a minimum of 30 minutes. The supply voltage was then adjusted on the EUT from 85% to 115% and the frequency record.

4.6.5 DEVIATION FROM TEST STANDARD

No deviation.

4.6.6 EUT OPERATING CONDITION

Set the EUT transmit at un-modulation mode to test frequency stability.

4.6.7 TEST RESULTS

FREQUENCY STABILITY VERSUS TEMP.									
OPERATING FREQUENCY: 5320MHz									
TEMP. (°C)	POWER SUPPLY (Vac)	0 MINUTE		2 MINUTE		5 MINUTE		10 MINUTE	
		Measured Frequency (MHz)	Frequency Drift (%)	Measured Frequency (MHz)	Frequency Drift (%)	Measured Frequency (MHz)	Frequency Drift (%)	Measured Frequency (MHz)	Frequency Drift (%)
50	120	5320.0024	0.00005	5320.0079	0.00015	5320.0051	0.00010	5320.0071	0.00013
40	120	5319.994	-0.00011	5319.9961	-0.00007	5319.9877	-0.00023	5319.9886	-0.00021
30	120	5320.0242	0.00045	5320.0255	0.00048	5320.0275	0.00052	5320.0281	0.00053
20	120	5320.0077	0.00014	5320.0084	0.00016	5320.0045	0.00008	5320.0084	0.00016
10	120	5319.9867	-0.00025	5319.9851	-0.00028	5319.9946	-0.00010	5319.9862	-0.00026
0	120	5319.9923	-0.00014	5319.9939	-0.00011	5319.9885	-0.00022	5319.9959	-0.00008
-10	120	5320.0167	0.00031	5320.0192	0.00036	5320.014	0.00026	5320.0089	0.00017
-20	120	5319.9762	-0.00045	5319.9833	-0.00031	5319.9769	-0.00043	5319.9835	-0.00031
-30	120	5319.988	-0.00023	5319.9935	-0.00012	5319.9962	-0.00007	5319.9875	-0.00023

FREQUENCY STABILITY VERSUS VOLTAGE									
OPERATING FREQUENCY: 5320MHz									
TEMP. (°C)	POWER SUPPLY (Vac)	0 MINUTE		2 MINUTE		5 MINUTE		10 MINUTE	
		Measured Frequency (MHz)	Frequency Drift (%)	Measured Frequency (MHz)	Frequency Drift (%)	Measured Frequency (MHz)	Frequency Drift (%)	Measured Frequency (MHz)	Frequency Drift (%)
20	138	5320.0084	0.00016	5320.0082	0.00015	5320.0049	0.00009	5320.0081	0.00015
	120	5320.0077	0.00014	5320.0084	0.00016	5320.0045	0.00008	5320.0084	0.00016
	102	5320.0069	0.00013	5320.0087	0.00016	5320.0045	0.00008	5320.0089	0.00017

4.7 20dBc BANDWIDTH MEASUREMENT

4.7.1 LIMITS OF PEAK TRANSMIT POWER MEASUREMENT

20dBc point shall not overlap in 5150~5700MHz.

4.7.2 TEST SETUP



4.7.3 TEST INSTRUMENTS

Refer to section 4.1.3 to get information of above instrument.

4.7.4 TEST PROCEDURE

789033 D01 General UNII Test Procedures v01r03

Emission bandwidth

- 1) Set RBW = approximately 1% of the emission bandwidth.
- 2) Set the VBW > RBW.
- 3) Detector = Peak.
- 4) Trace mode = max hold.
- 5) Measure the maximum width of the emission that is 20 dB down from the peak of the emission. Compare this with the RBW setting of the analyzer. Readjust RBW and repeat measurement as needed until the RBW/EBW ratio is approximately 1%.



A D T

4.7.5 TEST RESULTS

802.11a

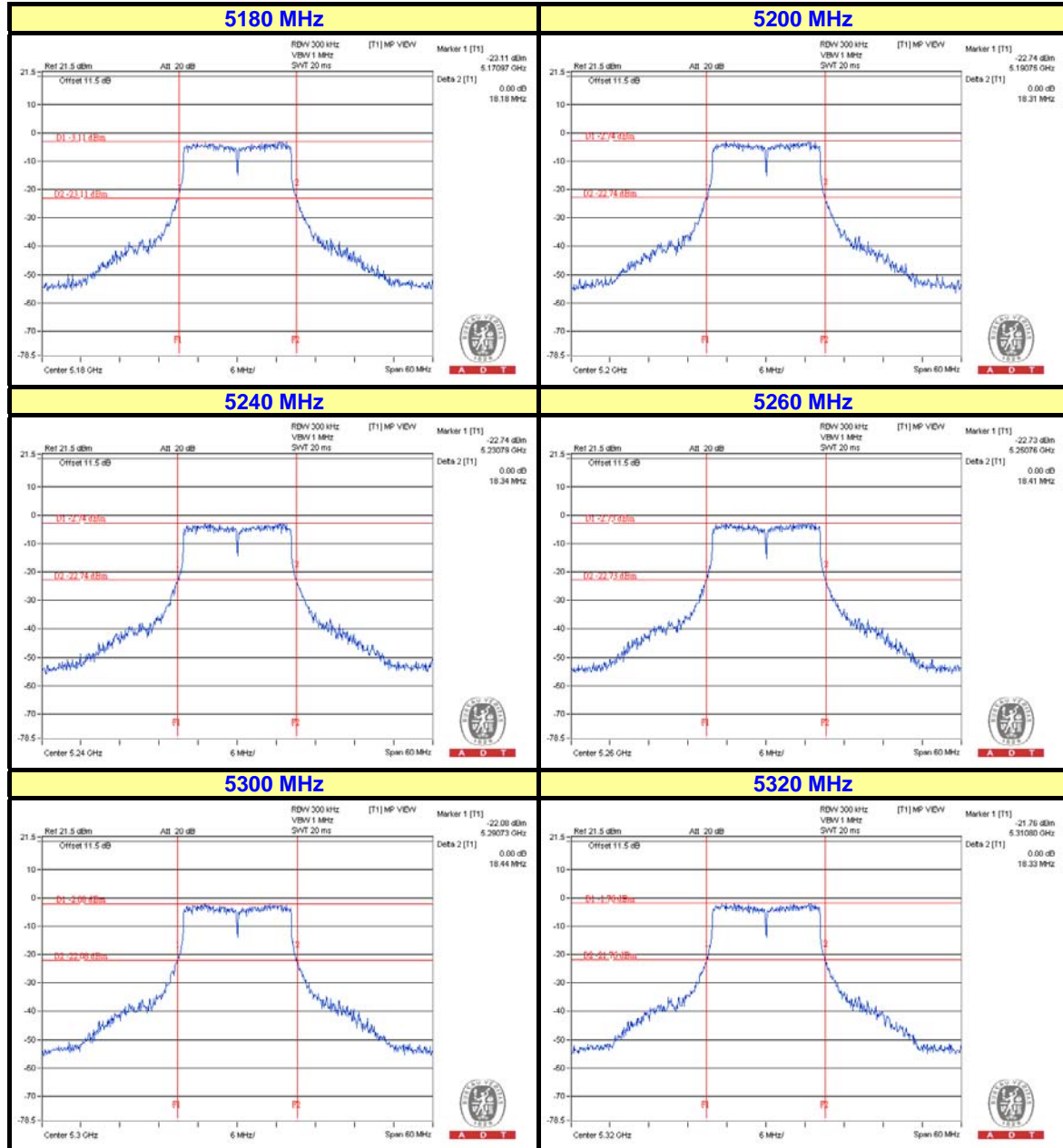



A D T

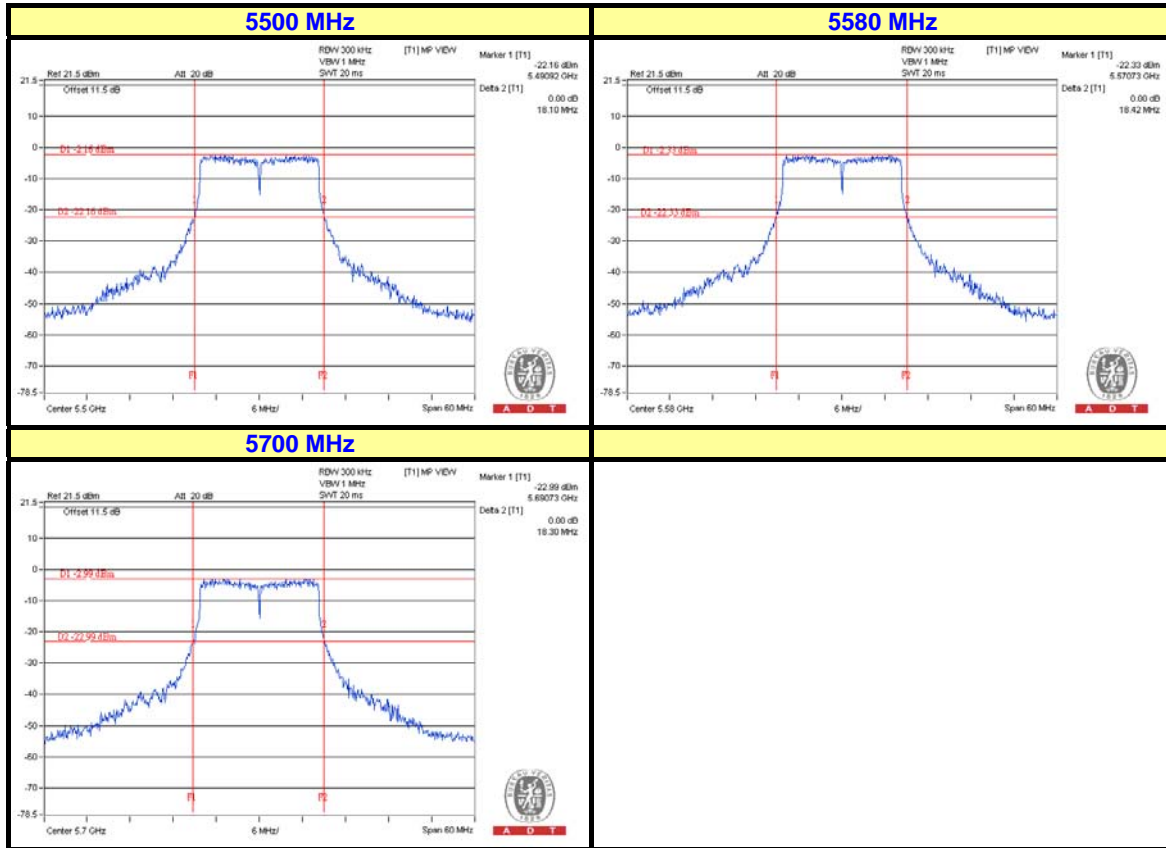



A D T

802.11n (20MHz)

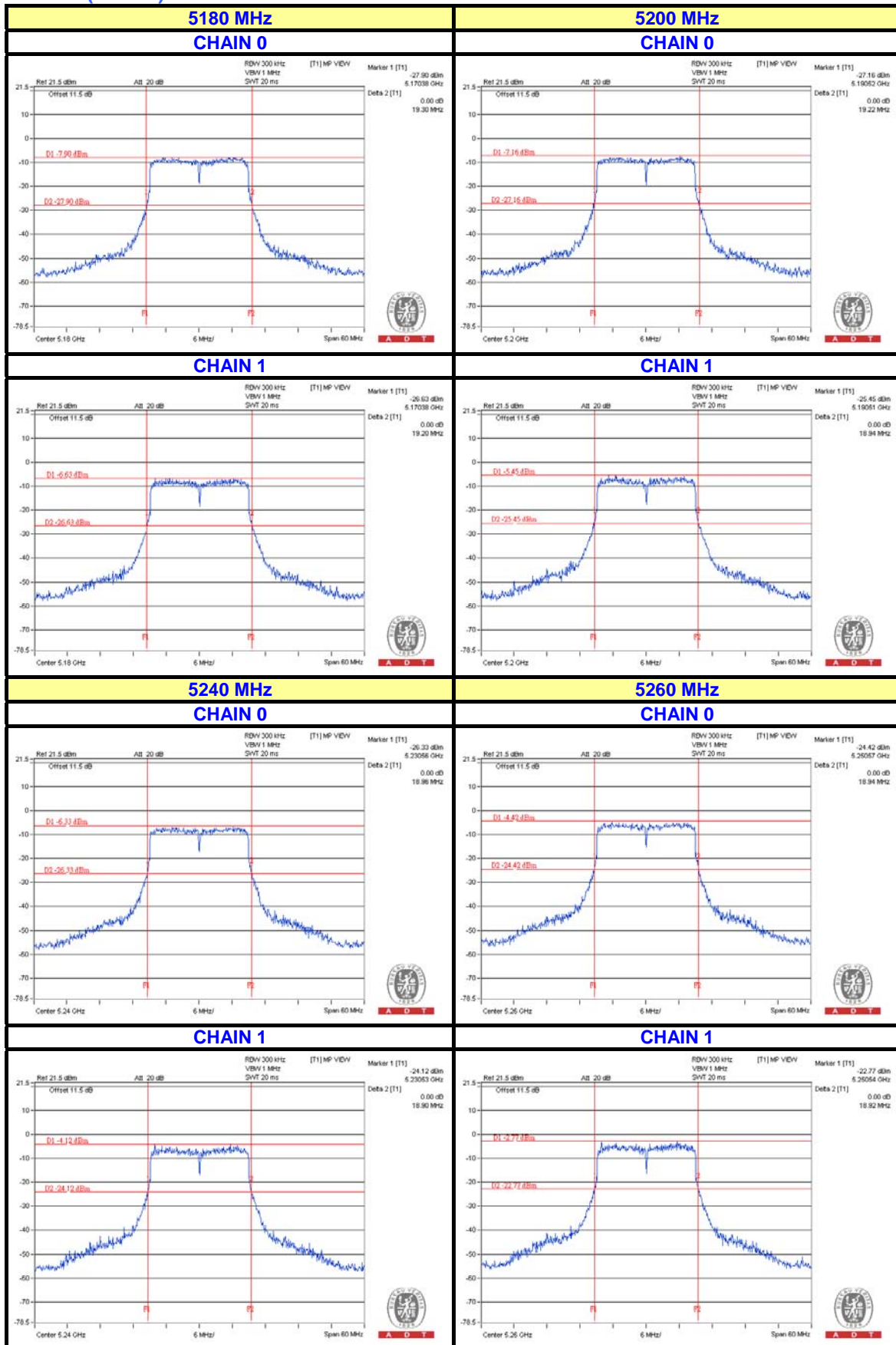



A D T

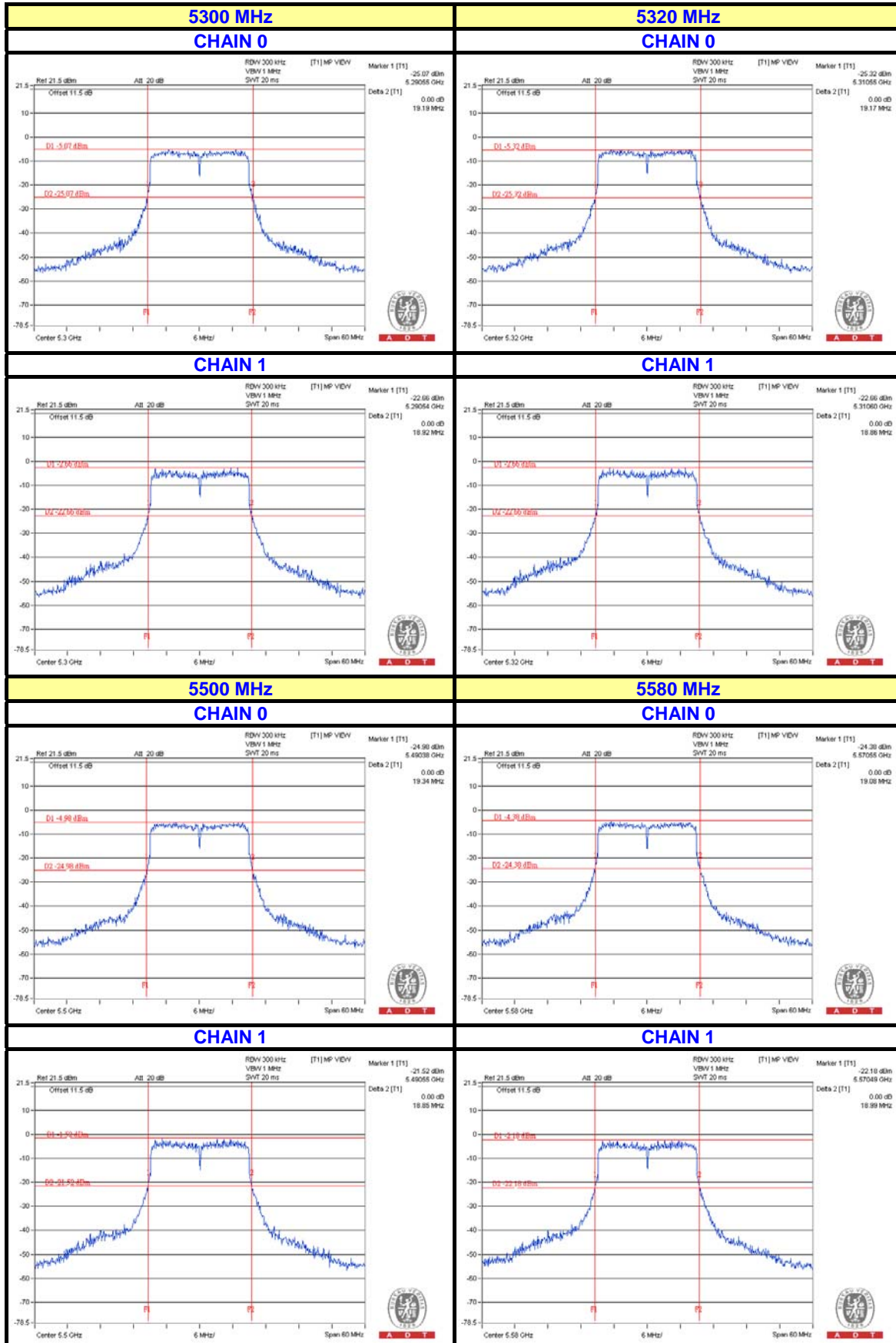



A D T

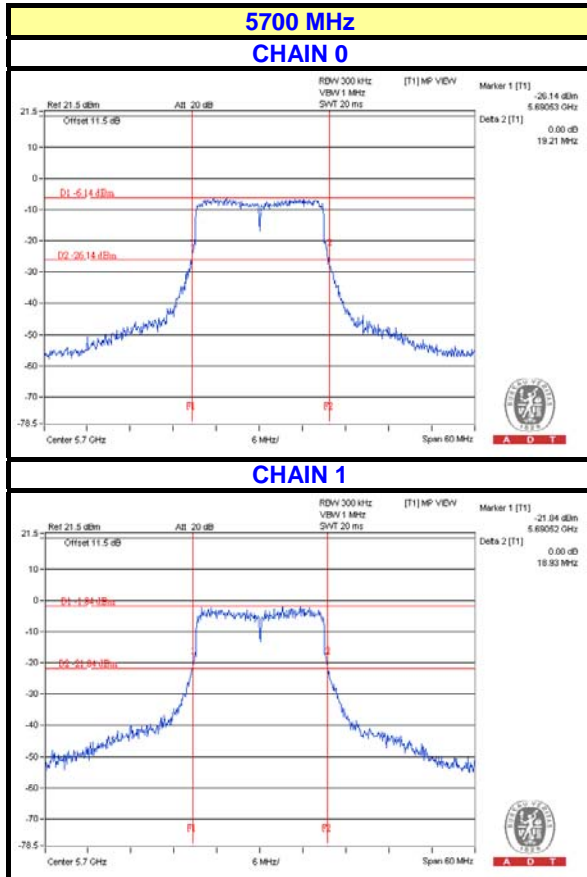



A D T

802.11n (40MHz)

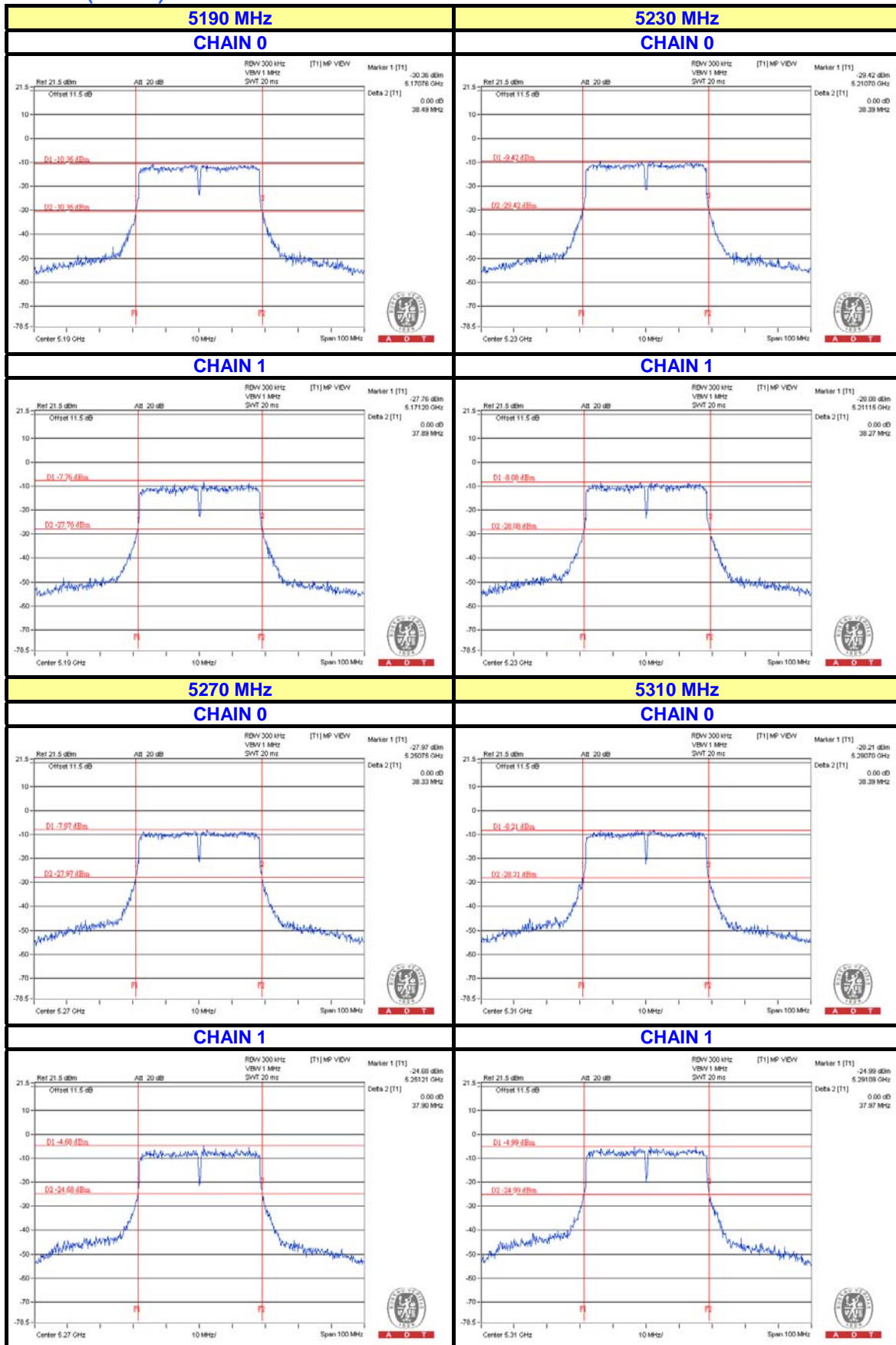



A D T

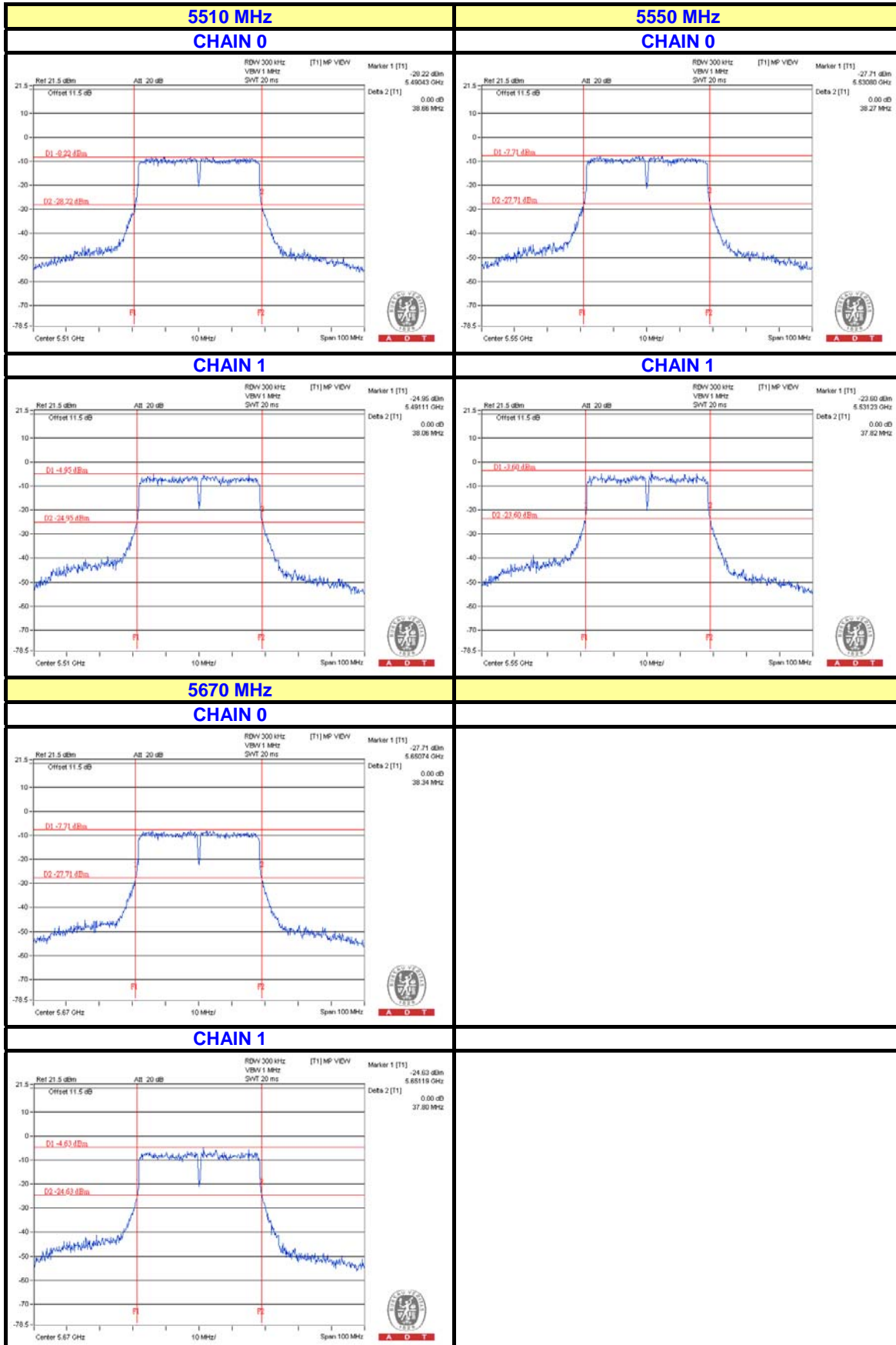



A D T

802.11ac (80MHz)

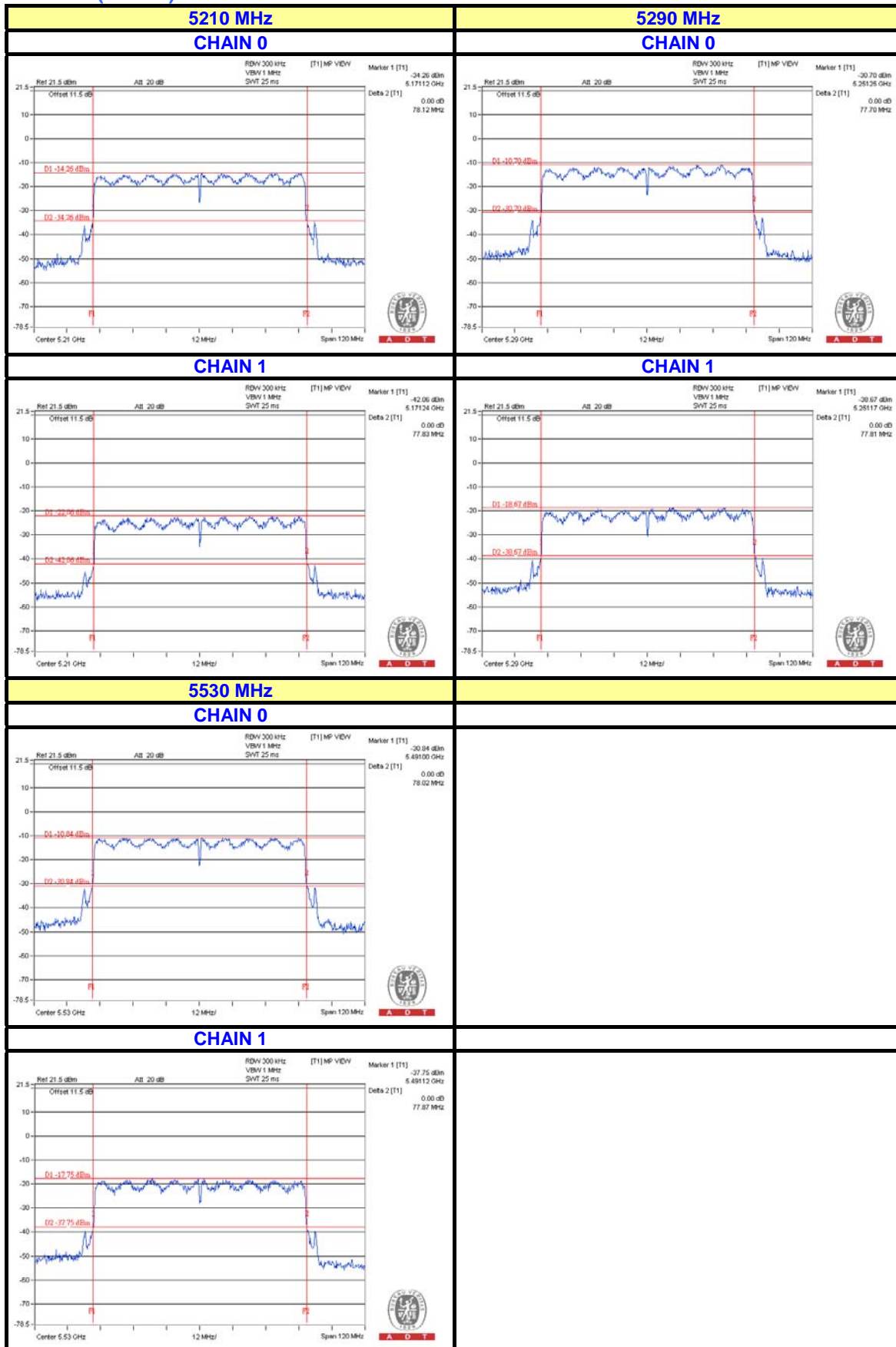

5. PHOTOGRAPHS OF THE TEST CONFIGURATION

Please refer to the attached file (Test Setup Photo).



6. INFORMATION ON THE TESTING LABORATORIES

We, Bureau Veritas Consumer Products Services (H.K.) Ltd., Taoyuan Branch, were founded in 1988 to provide our best service in EMC, Radio, Telecom and Safety consultation. Our laboratories are accredited and approved according to ISO/IEC 17025.

If you have any comments, please feel free to contact us at the following:

Linko EMC/RF Lab:
Tel: 886-2-26052180
Fax: 886-2-26051924

Hsin Chu EMC/RF/Telecom Lab:
Tel: 886-3-5935343
Fax: 886-3-5935342

Hwa Ya EMC/RF/Safety Lab:
Tel: 886-3-3183232
Fax: 886-3-3270892

Email: service.adt@tw.bureauveritas.com
Web Site: www.bureauveritas-adt.com

The address and road map of all our labs can be found in our web site also.

7. APPENDIX A – MODIFICATIONS RECORDERS FOR ENGINEERING CHANGES TO THE EUT BY THE LAB

No modifications were made to the EUT by the lab during the test.

---END---