

RADIO TEST REPORT

FCC 47 CFR PART 15 SUBPART C

INDUSTRY CANADA RSS-247

Test Standard	FCC Part 15.247 RSS-247 issue 2 and RSS-GEN issue 5
Product name	GUARDIAN SYSTEM LTE
Brand Name	GUARDIAN
FCC Model No.	G2-SY-CON2
IC Model No.	G2-SY-CON2-1002244
Test Result	Pass
Statements of Conformity	Determination of compliance is based on the results of the compliance measurement, not taking into account measurement instrumentation uncertainty.

The test Result was tested by Compliance Certification Services Inc. The test data, data evaluation, test procedures, and equipment configurations shown in this report were given in ANSI C63.10: 2013 and compliance standards.

The test results of this report relate only to the tested sample (EUT) identified in this report.

The test Report of full or partial shall not copy. Without written approval of Compliance Certification Services Inc. (Wugu Laboratory)

Approved by:



Kevin Tsai
Deputy Manager

Unless otherwise stated the results shown in this test report refer only to the sample(s) tested and such sample(s) are retained for 90 days only.
除非另有說明，此報告結果僅對測試之樣品負責，同時此樣品僅保留90天。本報告未經本公司書面許可，不可部份複製。

This document is issued by the Company subject to its General Conditions of Service printed overleaf, available on request or accessible at <http://www.sgs.com.tw/Terms-and-Conditions> and, for electronic format documents, subject to Terms and Conditions for Electronic Documents at <http://www.sgs.com.tw/Terms-and-Conditions>. Attention is drawn to the limitation of liability, indemnification and jurisdiction issues defined therein. Any holder of this document is advised that information contained hereon reflects the Company's findings at the time of its intervention only and within the limits of client's instruction, if any. The Company's sole responsibility is to its Client and this document does not exonerate parties to a transaction from exercising all their rights and obligations under the transaction documents. This document cannot be reproduced, except in full, without prior written approval of the Company. Any unauthorized alteration, forgery or falsification of the content or appearance of this document is unlawful and offenders may be prosecuted to the fullest extent of the law.

Revision History

Rev.	Issue Date	Revisions	Effect Page	Revised By
00	January 22, 2020	Initial Issue	ALL	Doris Chu
01	April 22, 2020	See the following Note Rev. (01)	P.15, P.30	Doris Chu
02	April 28, 2020	See the following Note Rev. (02)	P.24	Doris Chu
03	May 29, 2020	See the following Note Rev. (03)	P.4	May Lin
04	June 20, 2020	See the following Note Rev. (04)	P.1, P.4	Allison Chen

Rev (01):

1. Revised section 4.2.2 Test Procedure.
2. Revised section 4.7.4 Test Result.

Rev (02):

1. Revised test data to clearly.

Rev (03):

1. Revised section 2 power supply and Emission Designator.

Rev (04):

1. Modify IC Model No.: G2-SY-CON2-1002244.

Table of contents

1. GENERAL INFORMATION	4
1.1 EUT INFORMATION	4
1.2 INFORMATION ABOUT THE FHSS CHARACTERISTICS.....	5
1.3 EUT CHANNEL INFORMATION	6
1.4 ANTENNA INFORMATION	6
1.5 MEASUREMENT UNCERTAINTY	7
1.6 FACILITIES AND TEST LOCATION.....	7
1.7 INSTRUMENT CALIBRATION.....	8
1.8 SUPPORT AND EUT ACCESSORIES EQUIPMENT.....	9
1.9 TEST METHODOLOGY AND APPLIED STANDARDS	9
2. TEST SUMMERY	10
3. DESCRIPTION OF TEST MODES	11
3.1 THE WORST MODE OF OPERATING CONDITION.....	11
3.2 THE WORST MODE OF MEASUREMENT	12
3.3 EUT DUTY CYCLE	13
4. TEST RESULT	14
4.1 AC POWER LINE CONDUCTED EMISSION.....	14
4.2 20dB BANDWIDTH AND OCCUPIED BANDWIDTH (99%)	15
4.3 OUTPUT POWER MEASUREMENT.....	18
4.4 FREQUENCY SEPARATION.....	20
4.5 NUMBER OF HOPPING	23
4.6 CONDUCTED BANDEDGE AND SPURIOUS EMISSION	25
4.7 TIME OF OCCUPANCY (DWELL TIME).....	30
4.8 RADIATION BANDEDGE AND SPURIOUS EMISSION	32
APPENDIX 1 - PHOTOGRAPHS OF EUT	

1. GENERAL INFORMATION

1.1 EUT INFORMATION

FCC Applicant	Seeing Machines Pty Ltd 80 Mildura Street, Fyshwick, ACT , Canberra 2609 Australia
IC Applicant	Seeing Machines Ltd. 80 Mildura Street Fyshwick ACT 2609 Australia
Manufacturer	ADLINK TECHNOLOGY INC. 9F, No. 166, Jian Yi Rd., Zhonghe Dist., New Taipei City, 235 Taiwan
Equipment	GUARDIAN SYSTEM LTE
FCC Model No.	G2-SY-CON2
IC Model No.	G2-SY-CON2-1002244
Model Discrepancy	N/A
Trade Name	GUARDIAN
Received Date	November 20, 2019
Date of Test	December 4, 2019 ~ January 7, 2020
Output Power (W)	GFSK : 0.0052 (EIRP: 0.0095) 8DPSK : 0.0033 (EIRP: 0.0059)
Power Operation	Powered from DC supply: DC 12V.
HW Version	V1
SW Version	V9

1.2 INFORMATION ABOUT THE FHSS CHARACTERISTICS

1.2.1 Pseudorandom Frequency Hopping Sequence

The channel is represented by a pseudo-random hopping sequence hopping through the 79 RF channels. The hopping sequence is unique for the piconet and is determined by the Bluetooth device address of the master; the phase in the hopping sequence is determined by the Bluetooth clock of the master. The channel is divided into time slots where each slot corresponds to an RF hop frequency. Consecutive hops correspond to different RF hop frequencies. The nominal hop rate is 1 600 hops/s.

1.2.2 Equal Hopping Frequency Use

The channels of this system will be used equally over the long-term distribution of the hopsets.

1.2.3 Example of a 79 hopping sequence in data mode:

02, 05, 31, 24, 20, 10, 43, 36, 30, 23, 40, 06, 21, 50, 44, 09, 71, 78, 01, 13, 73, 07, 70, 72, 35, 62, 42, 11, 41, 08, 16, 29, 60, 15, 34, 61, 58, 04, 67, 12, 22, 53, 57, 18, 27, 76, 39, 32, 17, 77, 52, 33, 56, 46, 37, 47, 64, 49, 45, 38, 69, 14, 51, 26, 79, 19, 28, 65, 75, 54, 48, 03, 25, 66, 05, 16, 68, 74, 59, 63, 55

1.2.4 System Receiver Input Bandwidth

Each channel bandwidth is 1MHz.

The system receivers have input bandwidths that match the hopping channel bandwidths of their corresponding transmitters and shift frequencies in synchronization with the transmitted signals.

1.2.5 Equipment Description

15.247(a)(1) that the Rx input bandwidths shift frequencies in synchronization with the transmitted signals.

15.247(g): In accordance with the Bluetooth Industry Standard, the system is designed to comply with all of the regulations in Section 15.247 when the transmitter is presented with a continuous data (or information) system.

15.247(h): In accordance with the Bluetooth Industry Standard, the system does not coordinate its channels selection/ hopping sequence with other frequency hopping systems for the express purpose of avoiding the simultaneous occupancy of individual hopping frequencies by multiple transmitters.

RSS-247, 5.1 (a): The system shall hop to channel frequencies that are selected at the system hopping rate from a pseudo randomly ordered list of hopping frequencies. The system receivers shall have input bandwidths that match the hopping channel bandwidths of their corresponding transmitters and shall shift frequencies in synchronization with the transmitted signals.

Report No.: T191120D05-RP1

1.3 EUT CHANNEL INFORMATION

Frequency Range	2402MHz-2480MHz
Modulation Type	1. GFSK for BDR-1Mbps 2. $\pi/4$ -DQPSK for EDR-2Mbps 3. 8DPSK for EDR-3Mbps
Number of channel	79 Channels

Remark:

Refer as ANSI C63.10: 2013 clause 5.6.1 Table 4 and RSS-GEN Table 1 for test channels

Number of frequencies to be tested		
Frequency range in which device operates	Number of frequencies	Location in frequency range of operation
<input type="checkbox"/> 1 MHz or less	1	Middle
<input type="checkbox"/> 1 MHz to 10 MHz	2	1 near top and 1 near bottom
<input checked="" type="checkbox"/> More than 10 MHz	3	1 near top, 1 near middle, and 1 near bottom

1.4 ANTENNA INFORMATION

Antenna Type	<input type="checkbox"/> PIFA <input type="checkbox"/> PCB <input type="checkbox"/> Dipole <input type="checkbox"/> Coils <input checked="" type="checkbox"/> FPC
Antenna Gain	Gain: 2.56 dBi
Antenna Connector	i-pex

Report No.: T191120D05-RP1

1.5 MEASUREMENT UNCERTAINTY

PARAMETER	UNCERTAINTY
AC Powerline Conducted Emission	+/- 1.2575
Emission bandwidth, 20dB bandwidth	+/- 0.0014
RF output power, conducted	+/- 1.14
Power density, conducted	+/- 1.40
3M Semi Anechoic Chamber / 30M~200M	+/- 4.12
3M Semi Anechoic Chamber / 200M~1000M	+/- 4.68
3M Semi Anechoic Chamber / 1G~8G	+/- 5.18
3M Semi Anechoic Chamber / 8G~18G	+/- 5.47
3M Semi Anechoic Chamber / 18G~26G	+/- 3.81
3M Semi Anechoic Chamber / 26G~40G	+/- 3.87

Remark:

1. This uncertainty represents an expanded uncertainty expressed at approximately the 95% confidence level using a coverage factor of $k=2$
2. ISO/IEC 17025 requires that an estimate of the measurement uncertainties associated with the emissions test results be included in the report.

1.6 FACILITIES AND TEST LOCATION

All measurement facilities used to collect the measurement data are located at No.11, Wugong 6th Rd., Wugu Dist., New Taipei City 24891, Taiwan. (R.O.C.)

Test site	Test Engineer	Remark
AC Conduction Room	-	Not applicable, because EUT not connect to AC Main Source direct.
Radiation	Jerry Chang	-
RF Conducted	Dally Hong	-

Remark: The sites are constructed in conformance with the requirements of ANSI C63.7, ANSI C63.4 and CISPR Publication 22.

Report No.: T191120D05-RP1

1.7 INSTRUMENT CALIBRATION

RF Conducted Test Site					
Equipment	Manufacturer	Model	S/N	Cal Date	Cal Due
Coaxial Cable	Woken	WC12	CC001	06/28/2019	06/27/2020
Coaxial Cable	Woken	WC12	CC003	06/28/2019	06/27/2020
EXA Signal Analyzer	KEYSIGHT	N9010B	MY55460167	07/31/2019	07/30/2020
Power Meter	Anritsu	ML2495A	1149001	02/12/2019	02/11/2020
Power Seneor	Anritsu	MA2491A	030982	02/12/2019	02/11/2020
Wideband Radio Communication Tester	R&S	CMW 500	116875	07/29/2019	07/28/2020
DC Power Supplies	GW Instek	SPS-3610	GPE880163	01/14/2019	1/13/2020
Software	N/A				

3M 966 Chamber Test Site					
Equipment	Manufacturer	Model	S/N	Cal Date	Cal Due
Band Reject Filters	MICRO TRONICS	BRM 50702	120	02/26/2019	02/25/2020
Bilog Antenna	Sunol Sciences	JB3	A030105	07/26/2019	07/25/2020
Coaxial Cable	HUBER SUHNER	SUCOFLEX 104PEA	20995	02/26/2019	02/25/2020
Coaxial Cable	EMCI	EMC105	190914+25111	09/20/2019	09/19/2020
Digital Thermo-Hygro Meter	WISEWIND	1206	D07	01/30/2019	01/29/2020
double Ridged Guide Horn Antenna	ETC	MCTD 1209	DRH13M02003	10/04/2019	10/03/2020
Loop Ant	COM-POWER	AL-130	121051	03/22/2019	03/21/2020
Pre-Amplifier	EMEC	EM330	060609	02/26/2019	02/25/2020
Pre-Amplifier	HP	8449B	3008A00965	02/26/2019	02/25/2020
PSA Series Spectrum Analyzer	Agilent	E4446A	MY46180323	05/29/2019	05/28/2020
Antenna Tower	CCS	CC-A-1F	N/A	N.C.R	N.C.R
Controller	CCS	CC-C-1F	N/A	N.C.R	N.C.R
Turn Table	CCS	CC-T-1F	N/A	N.C.R	N.C.R
Software	e3 6.11-20180413				

AC line Conduction Test Room					
Equipment	Manufacturer	Model	S/N	Cal Date	Cal Due
N/A					

Note:

1. The calibration interval of the above test instruments is 12 months and the calibrations are traceable to NML/ROC and NIST/USA.
2. N.C.R. = No Calibration Required

1.8 SUPPORT AND EUT ACCESSORIES EQUIPMENT

EUT Accessories Equipment						
No.	Equipment	Brand	Model	Series No.	FCC ID	IC ID
	N/A					

Support Equipment						
No.	Equipment	Brand	Model	Series No.	FCC ID	IC ID
1	NB(J)	TOSHIBA	PT345T-00L002	N/A	PD97260H	1000M-7260H

1.9 TEST METHODOLOGY AND APPLIED STANDARDS

The test methodology, setups and results comply with all requirements in accordance with ANSI C63.10:2013, FCC Part 2, FCC Part 15.247, RSS-247 Issue 2 and RSS-GEN Issue 5.

Report No.: T191120D05-RP1

2. TEST SUMMERY

FCC Standard Section	IC Standard Section	Report Section	Test Item	Result
15.203	-	1.3	Antenna Requirement	Pass
15.207(a)	RSS-GEN 8.8	4.1	AC Conducted Emission	N/A
15.247(a)(1)	RSS-247(5.1)(a)	4.2	20 dB Bandwidth	Pass
-	RSS-GEN 6.7	4.2	Occupied Bandwidth (99%)	Pass
15.247(b)(1)	RSS-247(5.4)(b)	4.3	Output Power Measurement	Pass
15.247(a)(1)	RSS-247(5.1)(b)	4.4	Frequency Separation	Pass
15.247(a)(1)(iii)	RSS-247(5.1)(d)	4.5	Number of Hopping	Pass
15.247(d)	RSS-247(5.5)	4.6	Conducted Band Edge	Pass
15.247(d)	RSS-247(5.5)	4.6	Conducted Spurious Emission	Pass
15.247(a)(1)(iii)	RSS-247(5.1)(d)	4.7	Time of Occupancy	Pass
15.247(d)	RSS-GEN 8.9, 8.10	4.8	Radiation Band Edge	Pass
15.247(d)	RSS-GEN 8.9, 8.10	4.8	Radiation Spurious Emission	Pass

3. DESCRIPTION OF TEST MODES

3.1 THE WORST MODE OF OPERATING CONDITION

<p>Operation mode</p>	<p>GFSK for BDR-1Mbps (DH5) 8DPSK for EDR-3Mbps (3DH5)</p>
<p>Test Channel Frequencies</p>	<p>GFSK for BDR-1Mbps: 1.Lowest Channel: 2402MHz 2.Middle Channel: 2441MHz 3.Highest Channel: 2480MHz 8DPSK for EDR-3Mbps: 1.Lowest Channel: 2402MHz 2.Middle Channel: 2441MHz 3.Highest Channel: 2480MHz</p>

3.2 THE WORST MODE OF MEASUREMENT

Radiated Emission Measurement Above 1G	
Test Condition	Radiated Emission Above 1G
Power supply Mode	Mode 1: EUT power by Power supply
Worst Mode	<input checked="" type="checkbox"/> Mode 1 <input type="checkbox"/> Mode 2 <input type="checkbox"/> Mode 3 <input type="checkbox"/> Mode 4
Worst Position	<input type="checkbox"/> Placed in fixed position. <input checked="" type="checkbox"/> Placed in fixed position at X-Plane (E2-Plane) <input type="checkbox"/> Placed in fixed position at Y-Plane (E1-Plane) <input type="checkbox"/> Placed in fixed position at Z-Plane (H-Plane)

Radiated Emission Measurement Below 1G	
Test Condition	Radiated Emission Below 1G
Power supply Mode	Mode 1: EUT power by Power supply
Worst Mode	<input checked="" type="checkbox"/> Mode 1 <input type="checkbox"/> Mode 2 <input type="checkbox"/> Mode 3 <input type="checkbox"/> Mode 4

Remark:

1. The worst mode was record in this test report.
2. EUT pre-scanned in three axis ,X, Y, Z and two polarity, for radiated measurement. The worst case(X-Plane) were recorded in this report

Report No.: T191120D05-RP1

3.3 EUT DUTY CYCLE

Duty Cycle				
Configuration	Duty Cycle (%)	Duty Factor (dB) $=10 \cdot \log(1/\text{Duty Cycle})$	1/T (kHz)	VBW setting (kHz)
BDR-1Mbps	49.20	3.08	0.33	1.00
EDR-3Mbps	48.87	3.11	0.33	1.00

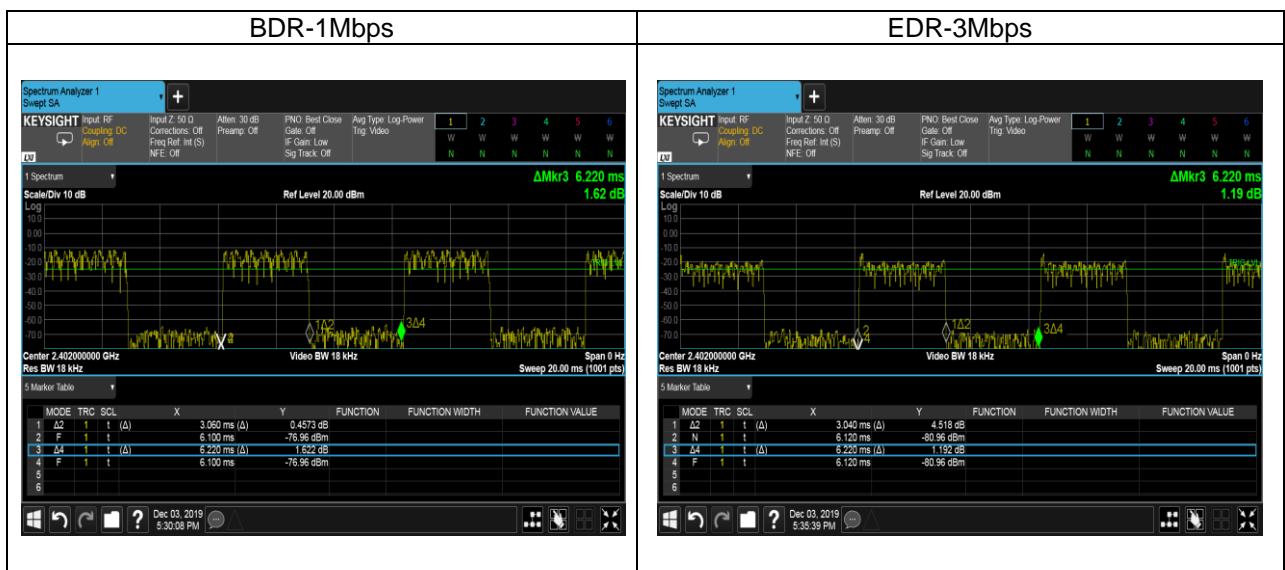

Report No.: T191120D05-RP1

4. TEST RESULT

4.1 AC POWER LINE CONDUCTED EMISSION

4.1.1 Test Limit

According to §15.207(a) and RSS-GEN section 8.8,

Frequency Range (MHz)	Limits(dBμV)	
	Quasi-peak	Average
0.15 to 0.50	66 to 56*	56 to 46*
0.50 to 5	56	46
5 to 30	60	50

* Decreases with the logarithm of the frequency.

4.1.2 Test Procedure

Test method Refer as ANSI C63.10: 2013 clause 6.2,

1. The EUT was placed on a non-conducted table, which is 0.8m above horizontal ground plane and 0.4m above vertical ground plane.
2. EUT connected to the line impedance stabilization network (LISN)
3. Receiver set RBW of 9kHz and Detector Peak, and note as quasi-peak and average.
4. Maximum procedure was performed on the six highest emissions to ensure EUT compliance.
5. Recorded Line for Neutral and Line.

4.1.3 Test Setup

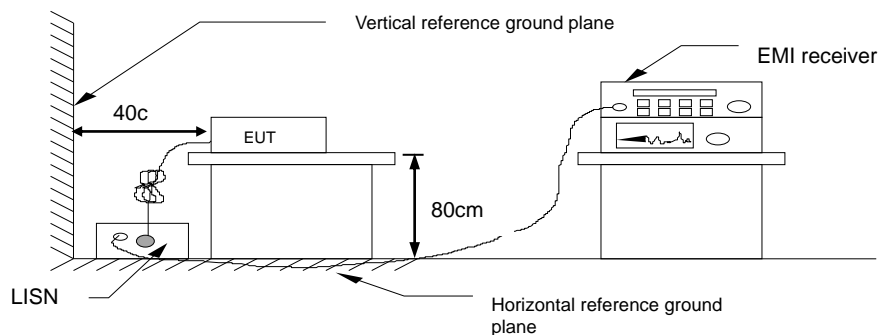

4.1.4 Test Result

Not applicable, because EUT not connect to AC Main Source direct.

Report No.: T191120D05-RP1

4.2 20dB BANDWIDTH AND OCCUPIED BANDWIDTH (99%)

4.2.1 Test Limit

According to §15.247(a) (1), RSS-247 section 5.1(a) and RSS-GEN 6.7,

20 dB Bandwidth : For reporting purposes only.

Occupied Bandwidth(99%) : For reporting purposes only.

4.2.2 Test Procedure

Test method Refer as Section 8.1 and ANSI C63.10: 2013 clause 7.8.7,

1. The EUT RF output connected to the spectrum analyzer by RF cable.
2. Setting maximum power transmit of EUT
3. SA set RBW = 1% ~ 5% OBW, VBW = three times the RBW and Detector = Peak, to measurement 20 dB Bandwidth and 99% Bandwidth.
4. Measure and record the result of 20 dB Bandwidth and 99% Bandwidth. in the test report.

4.2.3 Test Setup

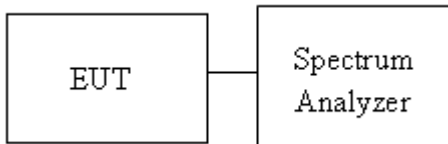

4.2.4 Test Result

Test mode: GFSK_BDR-1Mbps mode / 2402-2480 MHz			
Channel	Frequency (MHz)	OBW(99%) (MHz)	20dB BW (MHz)
Low	2402	0.9859	1.0260
Mid	2441	0.9874	1.0270
High	2480	0.9877	1.0270

Test mode: 8DPSK_EDR-3Mbps mode / 2402-2480 MHz			
Channel	Frequency (MHz)	OBW(99%) (MHz)	20dB BW (MHz)
Low	2402	1.1983	1.2970
Mid	2441	1.1983	1.2950
High	2480	1.1948	1.2990

Report No.: T191120D05-RP1

Test Data

20 dB Bandwidth & 99% Bandwidth

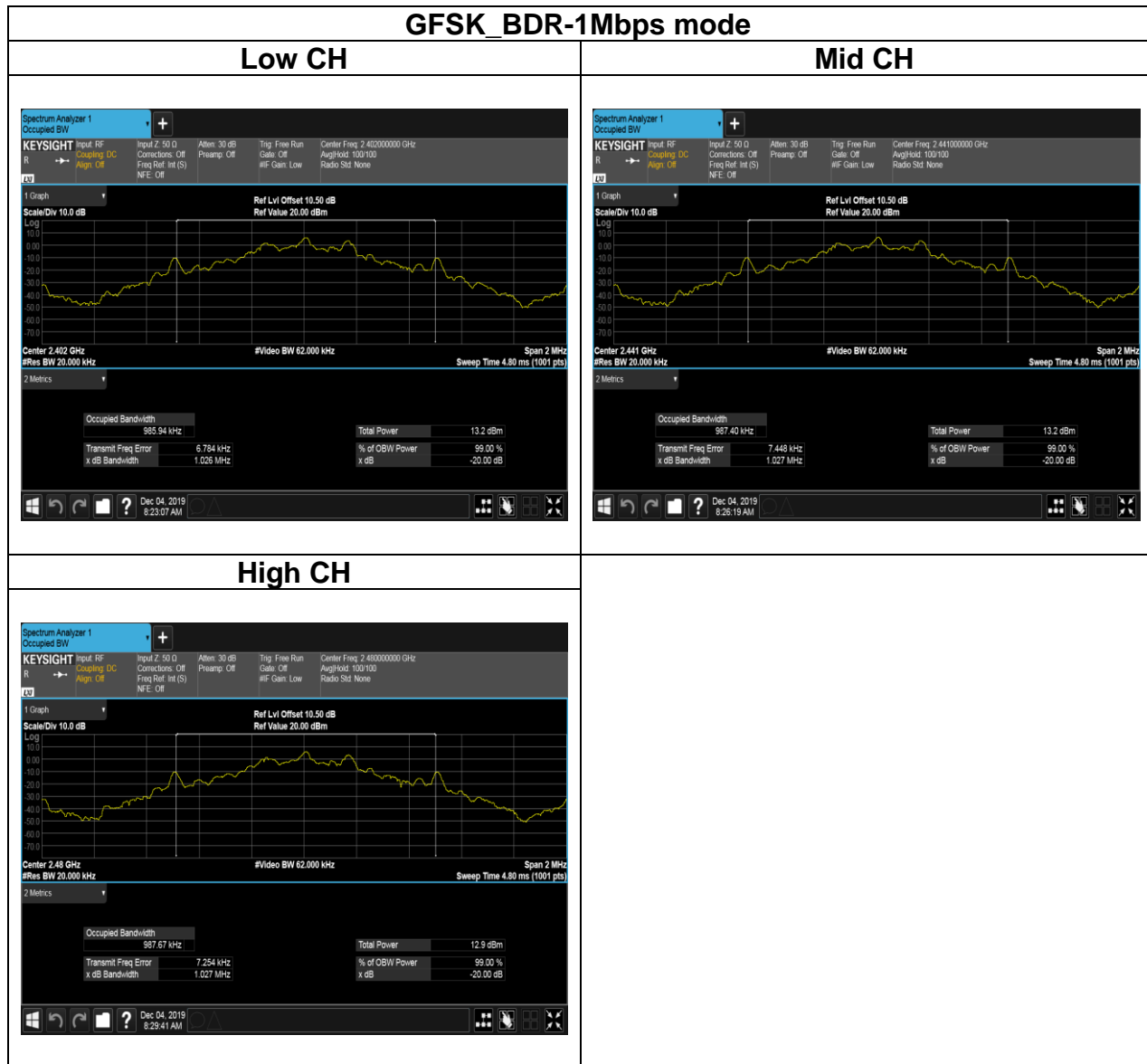

Report No.: T191120D05-RP1

8DPSK_EDR-3Mbps mode

Low CH

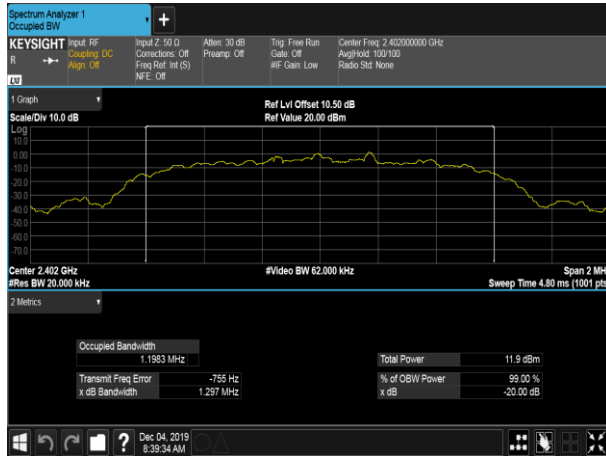

Mid CH

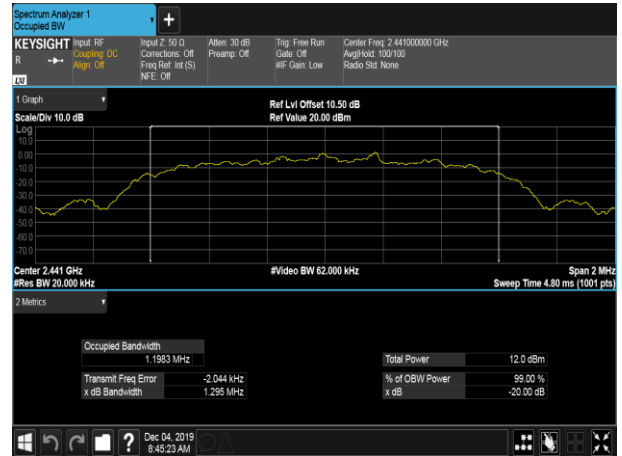

High CH



4.3 OUTPUT POWER MEASUREMENT

4.3.1 Test Limit

According to §15.247(b)(1) and RSS-247 section 5.4(b)

Peak output power :

FCC

Alternatively, frequency hopping systems operating in the 2400-2483.5 MHz band may have hopping channel carrier frequencies that are separated by 25 kHz or two-thirds of the 20 dB bandwidth of the hopping channel, whichever is greater, provided the systems operate with an output power no greater than 125 mW.

IC

According to RSS-247 section 5.4(b), For FHSs operating in the band 2400-2483.5 MHz, the maximum peak conducted output power shall not exceed 1.0 W if the hopset uses 75 or more hopping channels; the maximum peak conducted output power shall not exceed 0.125 W if the hopset uses less than 75 hopping channels. The e.i.r.p. shall not exceed 4 W, except as provided in section 5.4(e).

Limit	<input checked="" type="checkbox"/> Antenna not exceed 6 dBi : 21dBm <input type="checkbox"/> Antenna with DG greater than 6 dBi : 21dBm [Limit = 30 – (DG – 6)]
-------	--

Average output power : For reporting purposes only.

4.3.2 Test Procedure

1. The EUT RF output connected to the power meter by RF cable.
2. Setting maximum power transmit of EUT.
3. The path loss was compensated to the results for each measurement.
4. Measure and record the result of Peak output power and Average output power. in the test report.

4.3.3 Test Setup

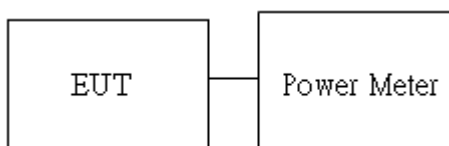

Report No.: T191120D05-RP1

4.3.4 Test Result

Peak output power :

BT										
Config.	CH	Freq. (MHz)	Power Setting	PK Power (dBm)	EIRP PK Power (dBm)	PK Power (W)	EIRP PK Power (W)	FCC/IC Limit (dBm)	IC EIRP Limit (dBm)	Antenna Gain (dBi)
GFSK BR-1Mbps (DH5)	0	2402	Default	7.20	9.76	0.0052	0.0095	21	36	2.56
	39	2441	Default	7.08	9.64	0.0051	0.0092			
	78	2480	Default	6.80	9.36	0.0048	0.0086			
8DPSK EDR- 3Mbps (3DH5)	0	2402	Default	5.01	7.57	0.0032	0.0057			
	39	2441	Default	5.18	7.74	0.0033	0.0059			
	78	2480	Default	5.14	7.70	0.0033	0.0059			

Average output power :

BT			
Config.	CH	Freq. (MHz)	AV Power (dBm)
GFSK BR-1Mbps (DH5)	0	2402	6.89
	39	2441	6.76
	78	2480	6.44
8DPSK EDR- 3Mbps (3DH5)	0	2402	4.63
	39	2441	4.58
	78	2480	4.24

Report No.: T191120D05-RP1

4.4 FREQUENCY SEPARATION

4.4.1 Test Limit

According to §15.247(a)(1) and RSS-247 section 5.1(b)

Alternatively, frequency hopping systems operating in the 2400-2483.5 MHz band may have hopping channel carrier frequencies that are separated by 25 kHz or two-thirds of the 20 dB bandwidth of the hopping channel, whichever is greater, provided the systems operate with an output power no greater than 125 mW.

Limit	> two-thirds of the 20 dB bandwidth
-------	-------------------------------------

4.4.2 Test Procedure

1. Place the EUT on the table and set it in transmitting mode.
2. EUT RF output port connected to the SA by RF cable.
3. Set the spectrum analyzer as RBW = 100kHz, VBW = 300kHz, Sweep = auto.
Max hold, mark 3 peaks of hopping channel and record the 3 peaks frequency

4.4.3 Test Setup

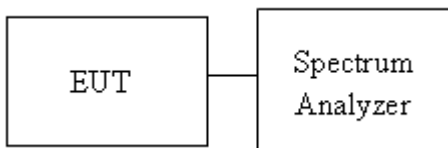

Report No.: T191120D05-RP1

4.4.4 Test Result

Test mode: GFSK_BDR-1Mbps mode / 2402-2480 MHz				
Channel	Frequency (MHz)	Channel Separation (MHz)	Channel Separation Limits (MHz)	Result
Low	2402	1.320	0.684	PASS
Mid	2441	1.320	0.685	PASS
High	2480	1.320	0.685	PASS

Test mode: 8DPSK_EDR-3Mbps mode / 2402-2480 MHz				
Channel	Frequency (MHz)	Channel Separation (MHz)	Channel Separation Limits (MHz)	Result
Low	2402	0.999	0.865	PASS
Mid	2441	0.999	0.863	PASS
High	2480	0.999	0.866	PASS

Report No.: T191120D05-RP1

Test Data

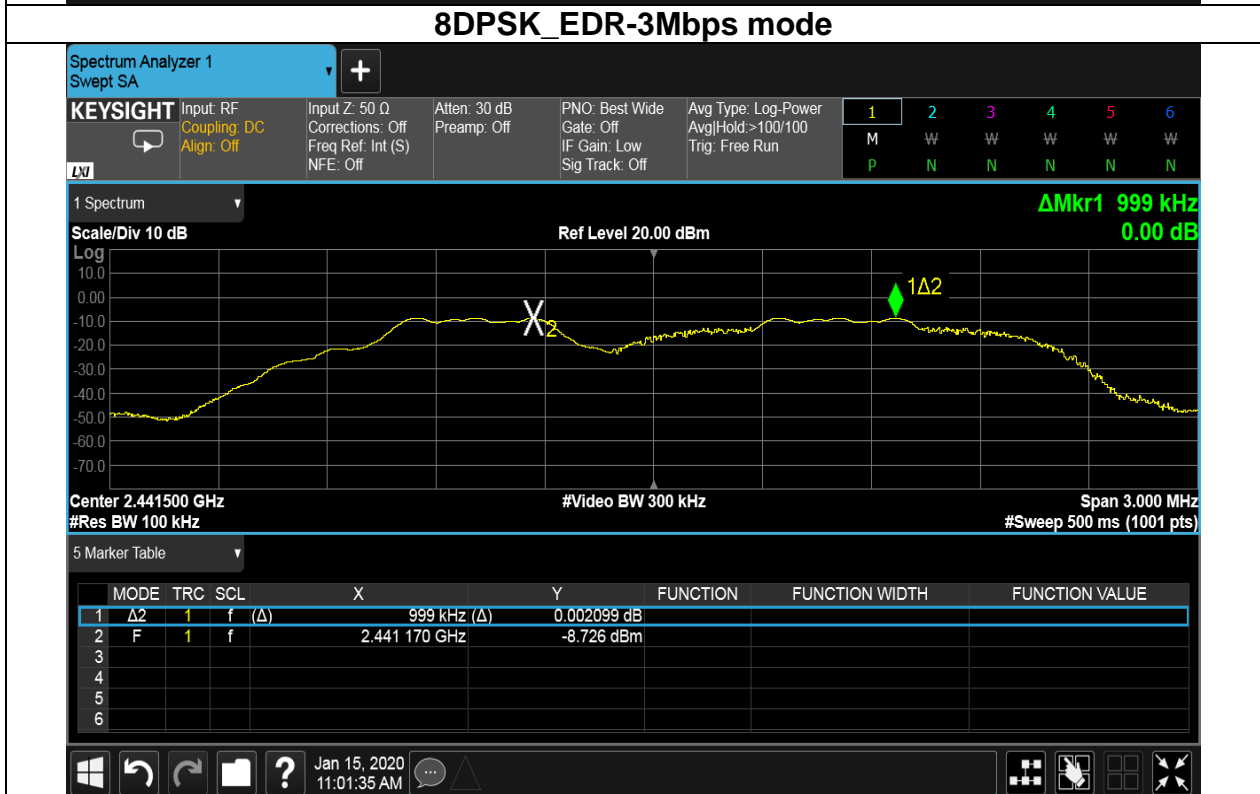
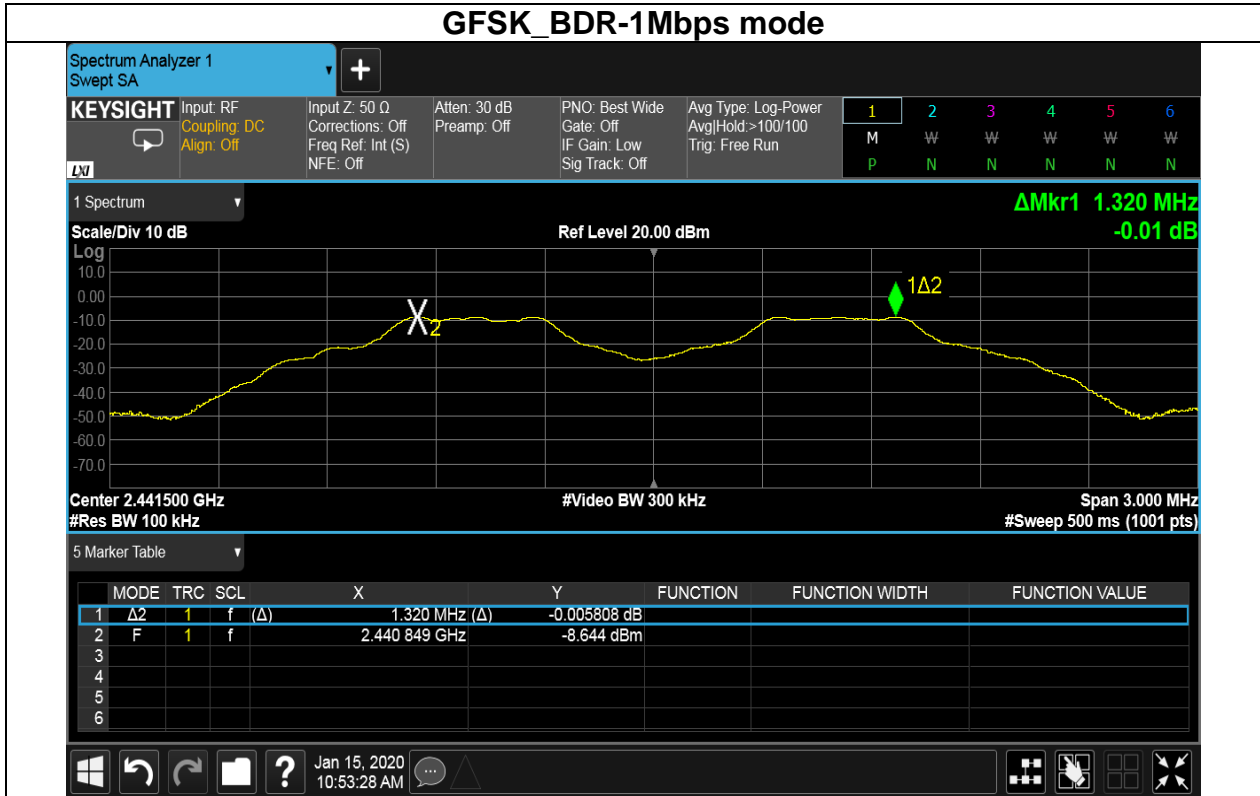

Note: We selected worst case to performed test in middle channel, The results can be meet other channel.

Report No.: T191120D05-RP1

4.5 NUMBER OF HOPPING

4.5.1 Test Limit

According to §15.247(a)(1)(iii) and RSS-247 section 5.1(d)

Frequency hopping systems in the 2400-2483.5 MHz band shall use at least 15 channels.

4.5.2 Test Procedure

Test method Refer as ANSI C63.10: 2013 clause 7.8.3

1. Place the EUT on the table and set it in transmitting mode.
2. EUT RF output port connected to the SA by RF cable.
3. Set spectrum analyzer Start Freq. = 2400 MHz, Stop Freq. = 2483.5 MHz, RBW = 100KHz, VBW = 300KHz.
4. Max hold, view and count how many channel in the band.

4.5.3 Test Setup

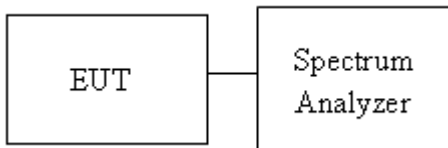

4.5.4 Test Result

Number of Hopping				
Mode	Frequency (MHz)	Hopping Channel Number	Hopping Channel Number Limits	Result
DH5	2402-2480	79	15	Pass
3-DH5	2402-2480	79	15	

Report No.: T191120D05-RP1

Test Data

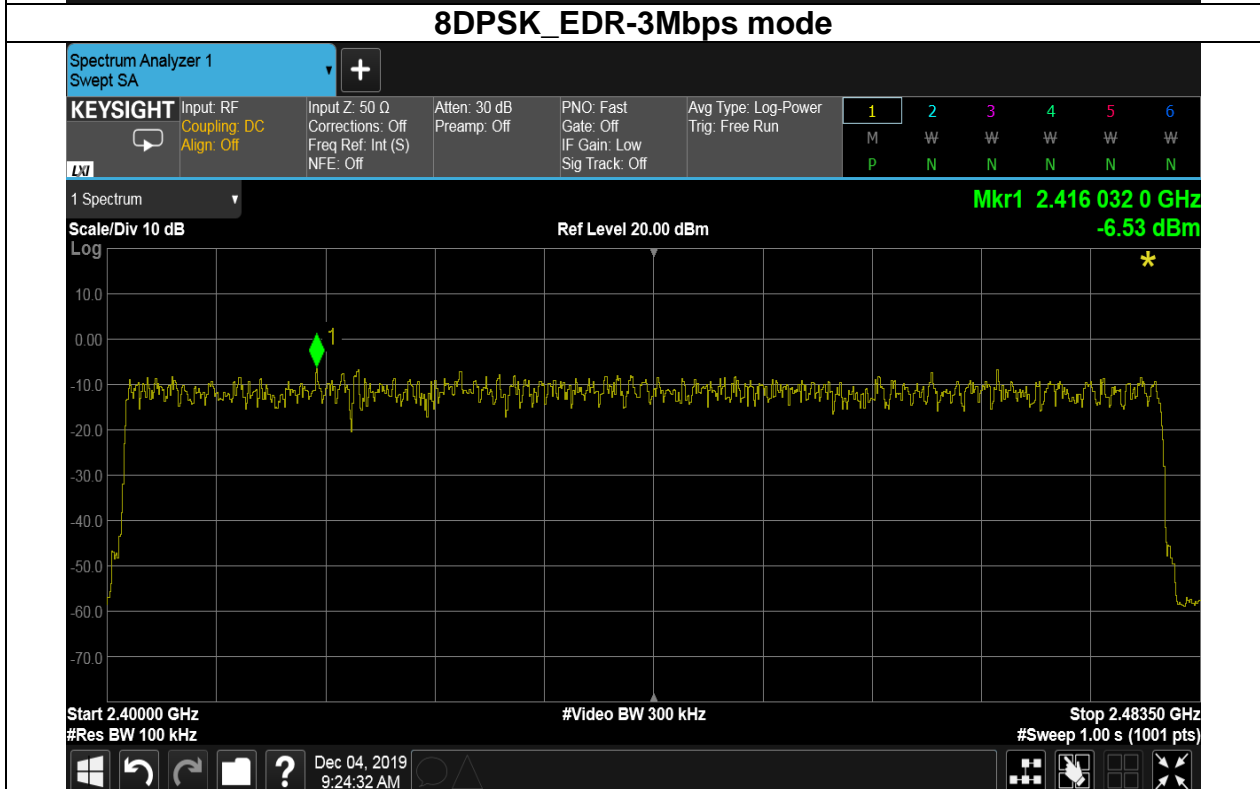
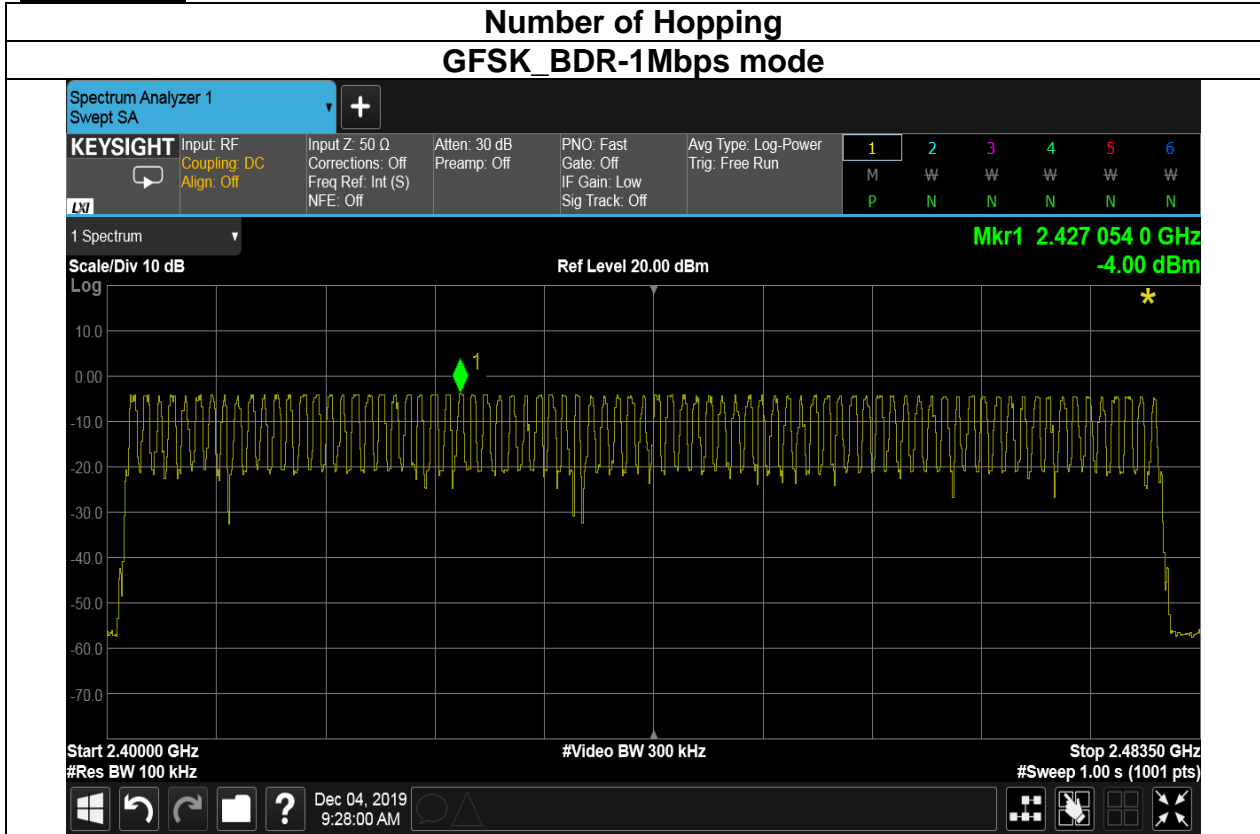

Report No.: T191120D05-RP1

4.6 CONDUCTED BANDEDGE AND SPURIOUS EMISSION

4.6.1 Test Limit

According to §15.247(d) and RSS-247 section 5.5

Limit	-20 dBc
-------	---------

4.6.2 Test Procedure

1. EUT RF output port connected to the SA by RF cable, and the path loss was compensated to result.
2. SA setting, RBW=100kHz, VBW=300kHz, Detector=Peak, Trace mode = max hold, SWT = Auto.
3. The Band Edge at 2.4GHz and 2.4835GHz are investigated with both hopping "ON" and "OFF" modes ".

4.6.3 Test Setup

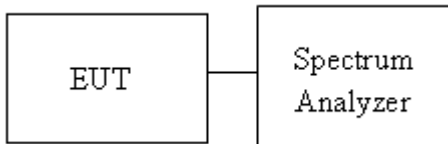

Report No.: T191120D05-RP1

4.6.4 Test Result

Test Data

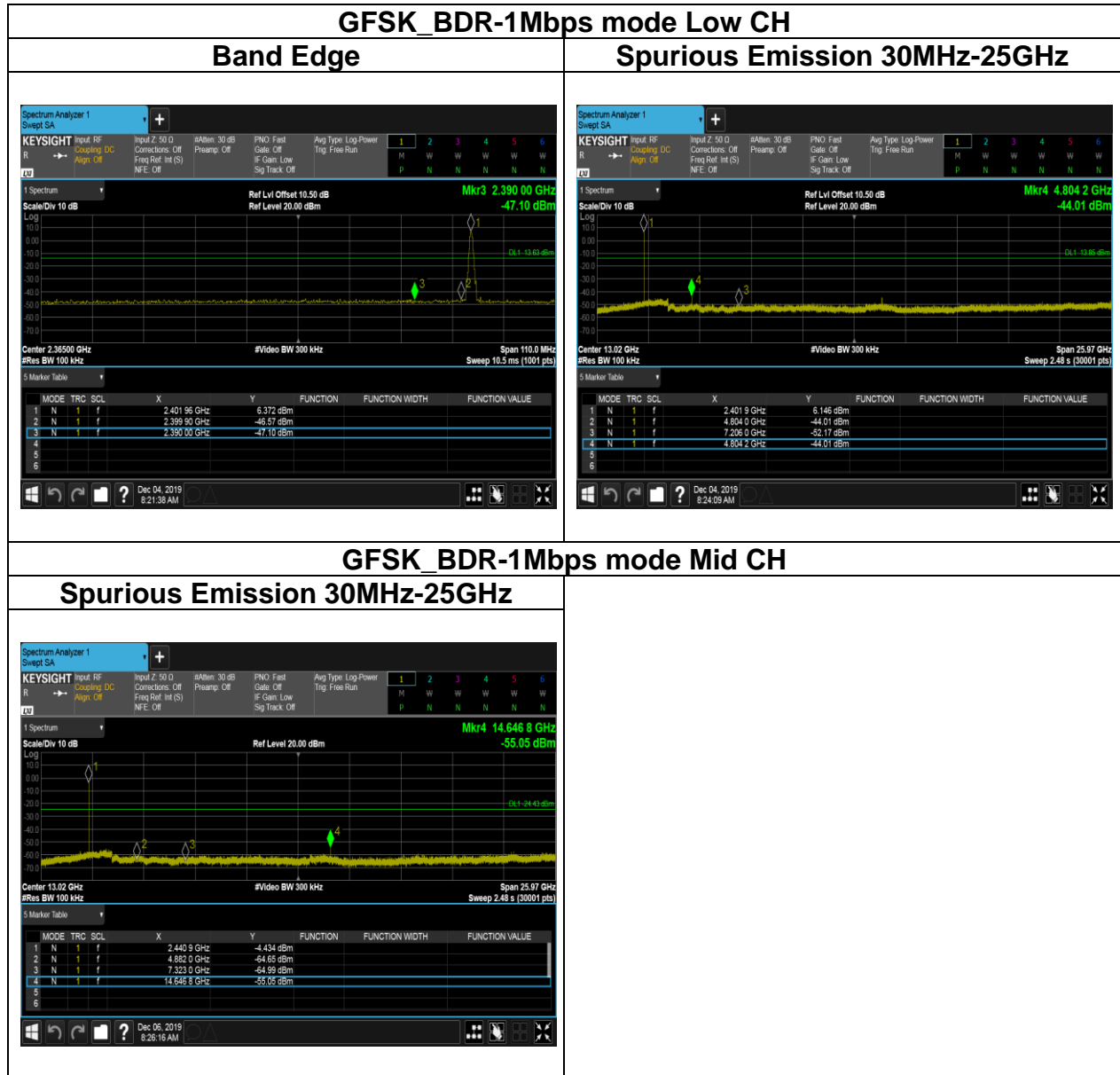

Report No.: T191120D05-RP1

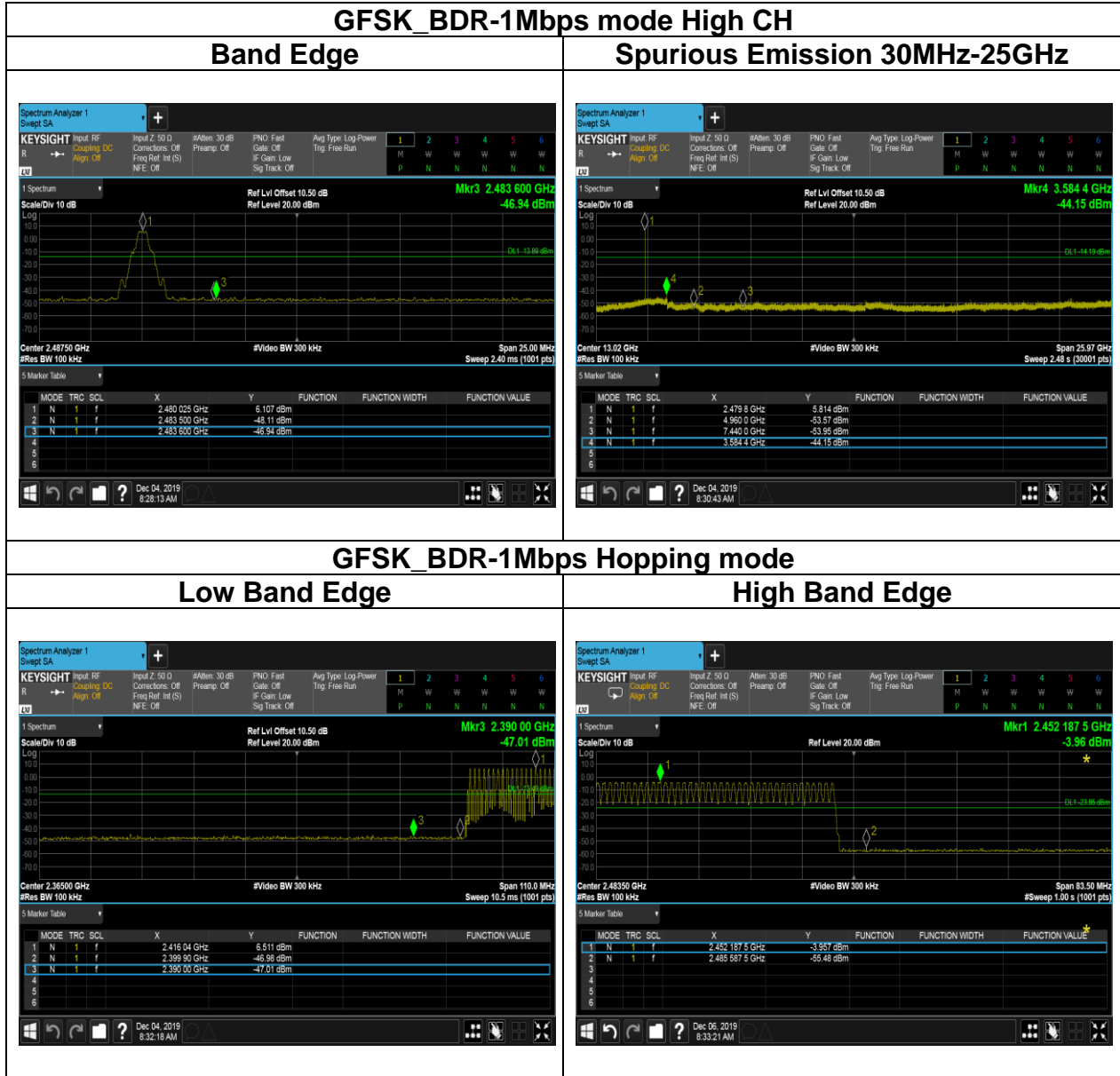

Report No.: T191120D05-RP1

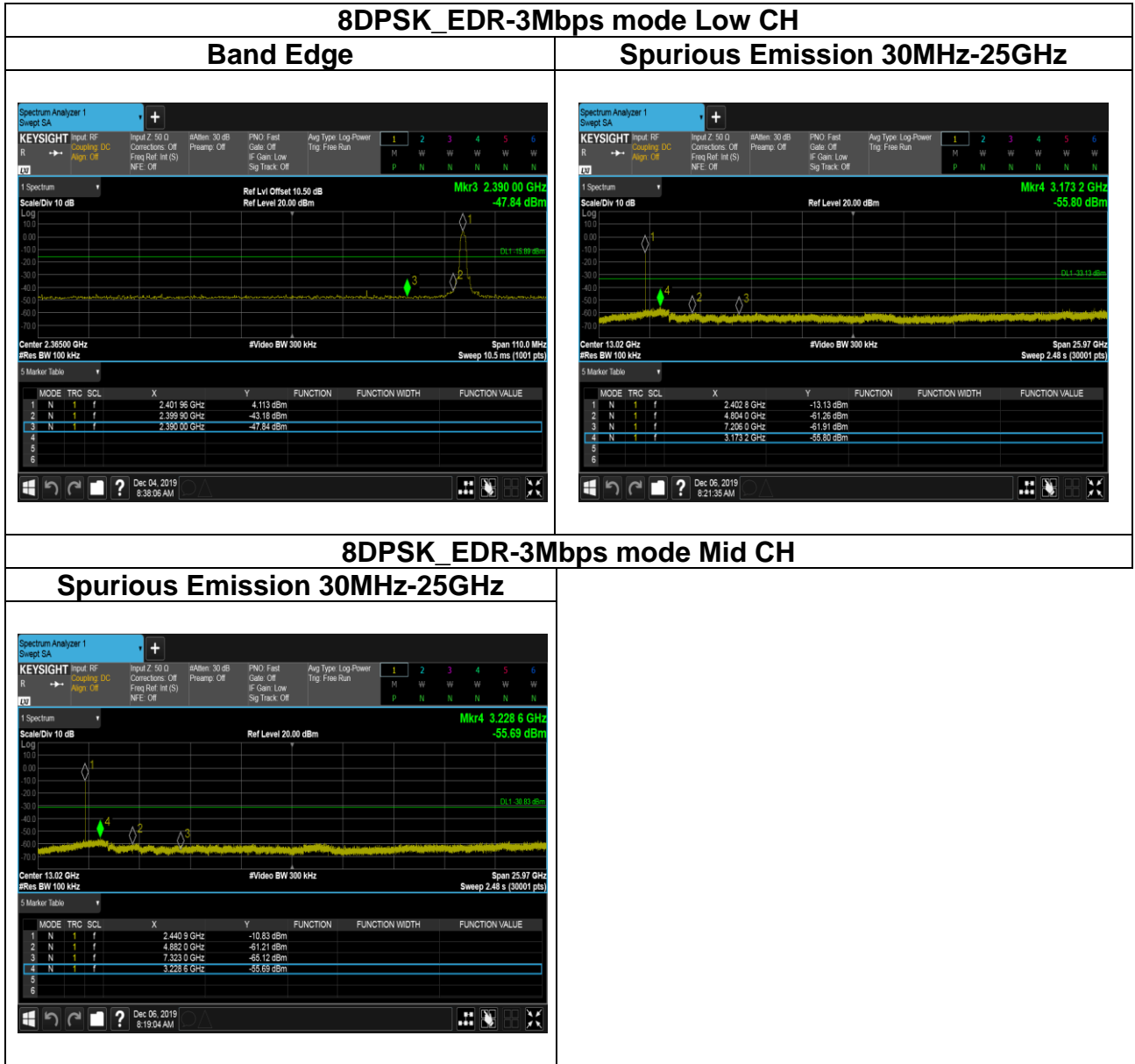

Report No.: T191120D05-RP1

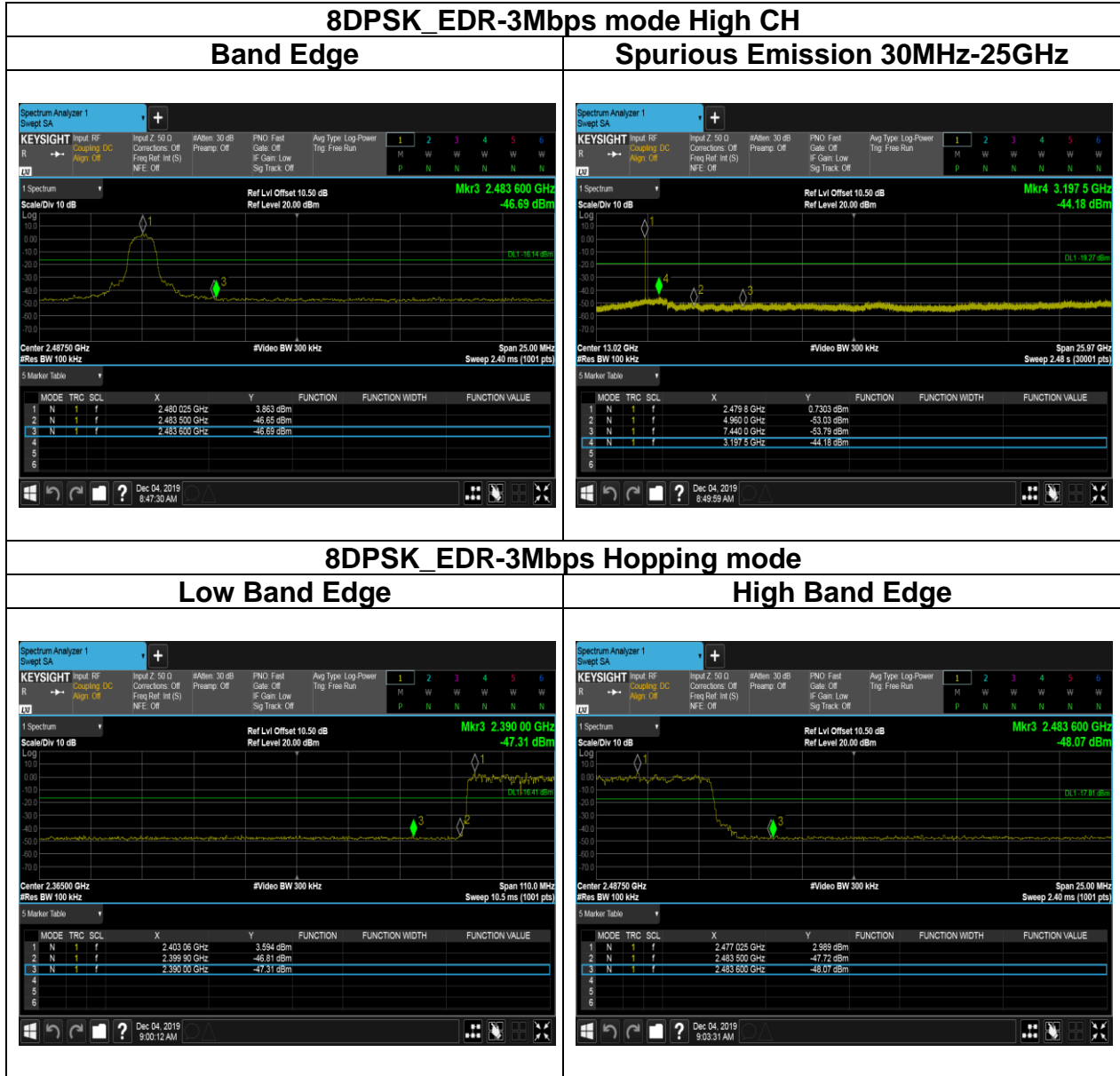

Report No.: T191120D05-RP1

4.7 TIME OF OCCUPANCY (DWELL TIME)

4.7.1 Test Limit

According to §15.247(a)(1)(iii) and RSS-247 section 5.1(d)

The average time of occupancy on any channel shall not be greater than 0.4 seconds within a period of 0.4 seconds multiplied by the number of hopping channels employed.

4.7.2 Test Procedure

1. EUT RF output port connected to the SA by RF cable.
2. Set center frequency of spectrum analyzer = operating frequency.
3. Set the spectrum analyzer as RBW, VBW=1MHz, Sweep = 1 ms

4.7.3 Test Setup

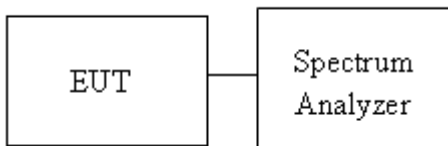

4.7.4 Test Result

Time of Occupancy (Dwell Time)							
Mode	Frequency (MHz)	Pulse Time Per Hopping (ms)	Minimum Number of Hopping Freq.	Number of pulse in	Dwell Time IN	Dwell Time Limits (s)	Result
				(0.4 * N sec)	(0.4 * N sec)		
BR-1Mbps	2441	3.0600	79	106.67	0.3264	0.4	Pass
EDR-3Mbps	2441	3.0400	79	106.67	0.3243	0.4	Pass

BR(1Mbps) & EDR(3Mbps) Packet permit maximum $1600 / 79 / 6 = 3.37$ hops per second in each channel (5 time slots RX, 1 time slot TX). So, the dwell time is the time duration of the pulse times $3.37 * 0.4 * 79 = 106.6$

* 3DH5 and DH5 were the Worst case.

Report No.: T191120D05-RP1

Test Data

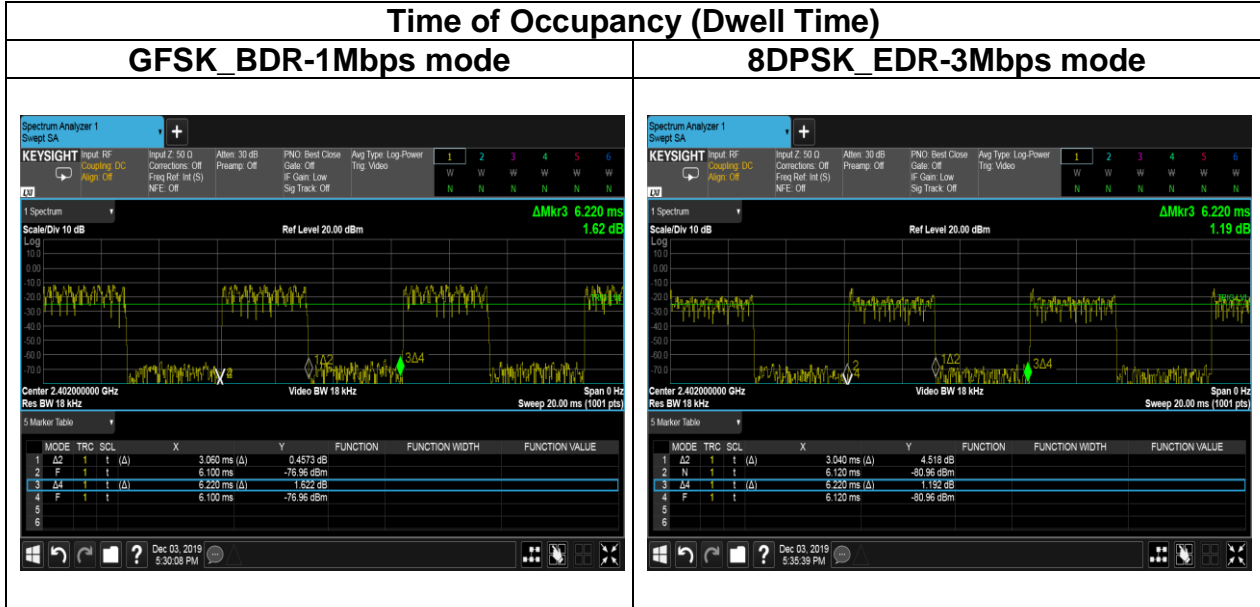

Report No.: T191120D05-RP1

4.8 RADIATION BANDEDGE AND SPURIOUS EMISSION

4.8.1 Test Limit

FCC according to §15.247(d), §15.209 and §15.205,

In any 100 kHz bandwidth outside the authorized frequency band, all harmonic and spurious must be least 20 dB below the highest emission level with the authorized frequency band. Radiation emission which fall in the restricted bands must also follow the FCC section 15.209 as below limit in table.

Below 30 MHz

Frequency	Field Strength (microvolts/m)	Magnetic H-Field (microamperes/m)	Measurement Distance (metres)
9-490 kHz	2,400/F (F in kHz)	2,400/F (F in kHz)	300
490-1,705 kHz	24,000/F (F in kHz)	24,000/F (F in kHz)	30
1.705-30 MHz	30	N/A	30

Above 30 MHz

Frequency (MHz)	Field Strength microvolts/m at 3 metres (watts, e.i.r.p.)	
	Transmitters	Receivers
30-88	100 (3 nW)	100 (3 nW)
88-216	150 (6.8 nW)	150 (6.8 nW)
216-960	200 (12 nW)	200 (12 nW)
Above 960	500 (75 nW)	500 (75 nW)

Remark:

Although these tests were performed other than open area test site, adequate comparison measurements were confirmed against 30 m open are test site. Therefore sufficient tests were made to demonstrate that the alternative site produces results that correlate with the ones of tests made in an open field based on KDB 414788.

Report No.: T191120D05-RP1

IC according to RSS-247 section 5.5, RSS-Gen, Section 8.9 and 8.10

RSS-Gen Table 3 and Table 5 – General Field Strength Limits for Transmitters and Receivers at Frequencies Above 30 MHz ^(Note)

Frequency (MHz)	Field Strength microvolts/m at 3 metres (watts, e.i.r.p.)	
	Transmitters	Receivers
30-88	100 (3 nW)	100 (3 nW)
88-216	150 (6.8 nW)	150 (6.8 nW)
216-960	200 (12 nW)	200 (12 nW)
Above 960	500 (75 nW)	500 (75 nW)

Note: Measurements for compliance with the limits in table 3 may be performed at distances other than 3 metres, in accordance with Section 6.6.

RSS-Gen Table 6: General Field Strength Limits for Transmitters at Frequencies Below 30 MHz (Transmit)

Frequency	Magnetic field strength (H-Field) ($\mu\text{A/m}$)	Measurement Distance (m)
9-490 kHz ^{Note}	6.37/F (F in kHz)	300
490-1,705 kHz	63.7/F (F in kHz)	30
1.705-30 MHz	0.08	30

Note: The emission limits for the ranges 9-90 kHz and 110-490 kHz are based on measurements employing a linear average detector..

Report No.: T191120D05-RP1

4.8.2 Test Procedure

1. The EUT is placed on a turntable, Above 1 GHz is 1.5m and below 1 GHz is 0.8m above ground plane. The EUT Configured un accordance with ANSI C63.10: 2013, and the EUT set in a continuous mode.
2. The turntable shall be rotated for 360 degrees to determine the position of maximum emission level. And EUT is set 3m away from the receiving antenna, which is scanned from 1m to 4m above the ground plane to find out the highest emissions. Measurement are made polarized in both the vertical and the horizontal positions with antenna.
3. Span shall wide enough to full capture the emission measured. The SA from 9kHz to 26.5GHz set to the low, Mid and High channels with the EUT transmit.
4. For harmonic, the worst case of output power was BDR-1Mbps. Therefore only BDR-1Mbps record in the report.
5. The SA setting following :
 - (1) Below 1G : RBW = 100kHz, VBW \geq 3 RBW, Sweep = Auto, Detector = Peak, Trace = Max hold.
 - (2) Above 1G :
 - (2.1) For Peak measurement : RBW = 1MHz, VBW \geq 3 RBW, Sweep = Auto, Detector = Peak, Trace = Max hold.
 - (2.2) For Average measurement : RBW = 1MHz, VBW
 - If Duty Cycle \geq 98%, VBW=10Hz.
 - If Duty Cycle < 98%, VBW \geq 1/T.

Remark:

1. *Although these tests were performed other than open area test site, adequate comparison measurements were confirmed against 30 m open are test site. Therefore sufficient tests were made to demonstrate that the alternative site produces results that correlate with the ones of tests made in an open field based on KDB 414788.*
2. *No emission found between lowest internal used/generated frequency to 30MHz (9kHz~30MHz).*

Report No.: T191120D05-RP1

4.8.3 Test Setup

9kHz ~ 30MHz

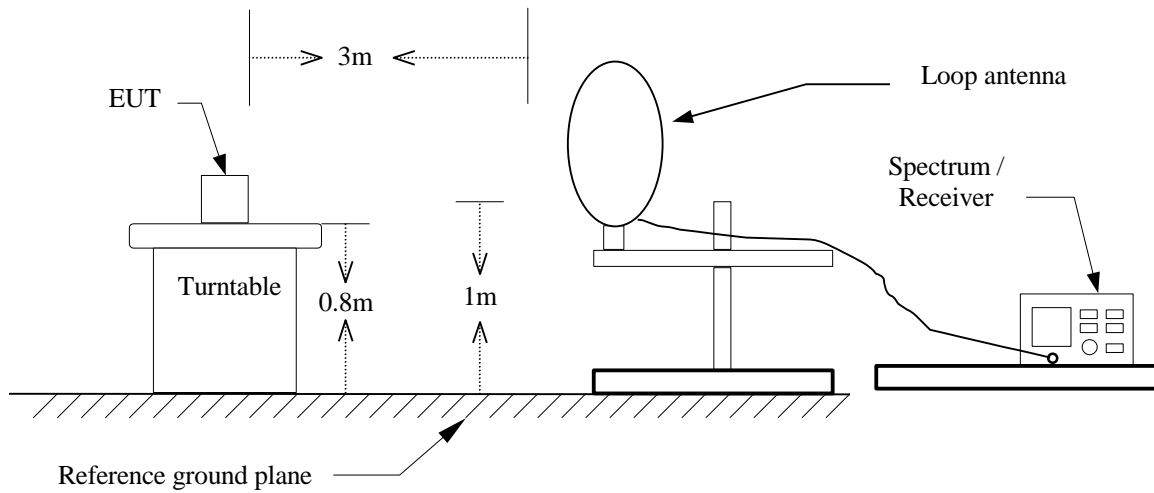

30MHz ~ 1GHz

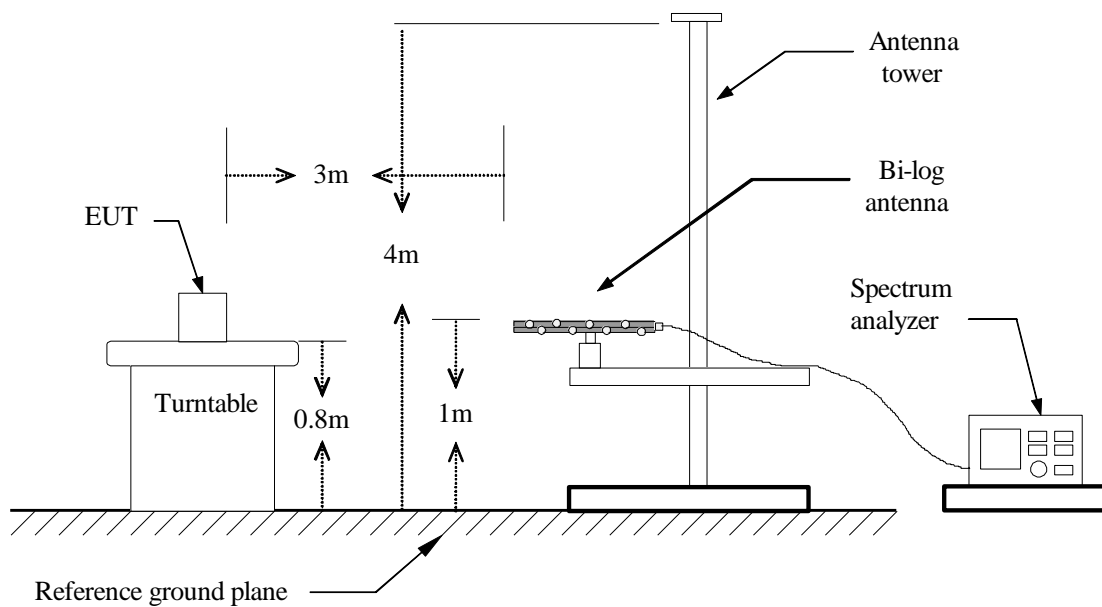

Above 1 GHz

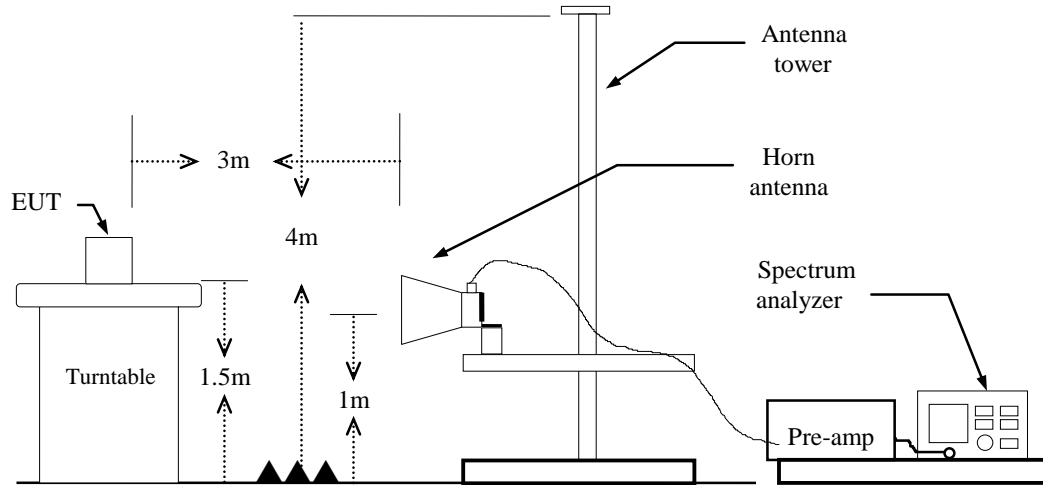

Report No.: T191120D05-RP1

4.8.4 Test Result

Band Edge Test Data

Test Mode:	GFSK_BDR-1Mbps Low CH	Temp/Hum	18.6(°C)/ 53%RH
Test Item	Band Edge	Test Date	December 11, 2019
Polarize	Vertical	Test Engineer	Jerry Chang
Detector	Peak / Average		

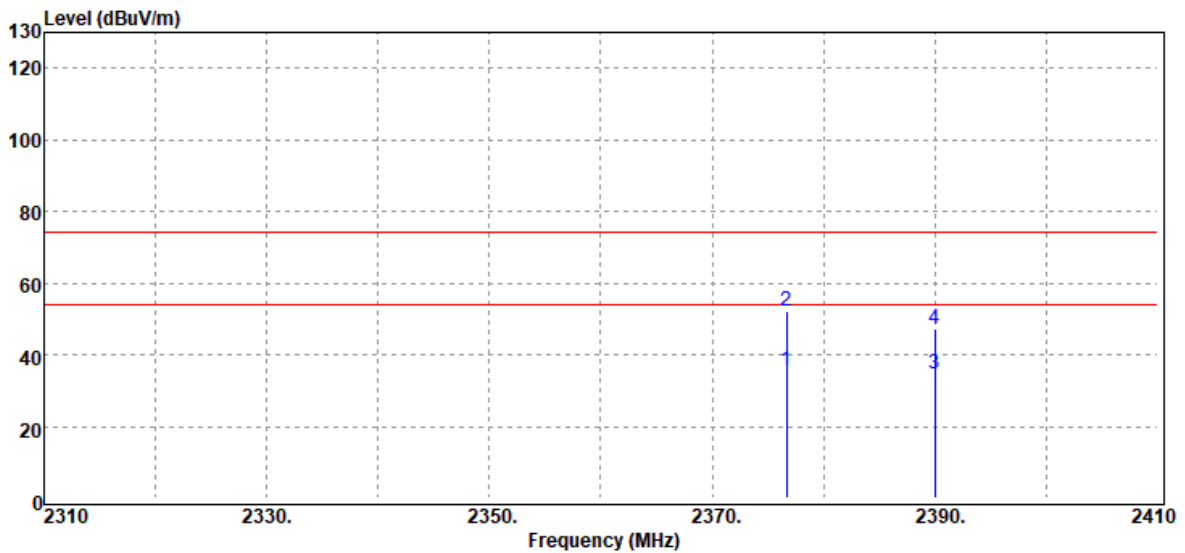

Freq. MHz	Detector Mode PK/QP/AV	Spectrum Reading Level dB μ V	Factor dB	Actual FS dB μ V/m	Limit @3m dB μ V/m	Margin dB
2376.70	Average	38.91	-3.36	35.55	54.00	-18.45
2376.70	Peak	55.32	-3.36	51.96	74.00	-22.04
2390.00	Average	37.86	-3.38	34.48	54.00	-19.52
2390.00	Peak	50.47	-3.38	47.09	74.00	-26.91

Report No.: T191120D05-RP1

Test Mode:	GFSK_BDR-1Mbps Low CH	Temp/Hum	18.6(°C)/ 53%RH
Test Item	Band Edge	Test Date	December 11, 2019
Polarize	Horizontal	Test Engineer	Jerry Chang
Detector	Peak / Average		

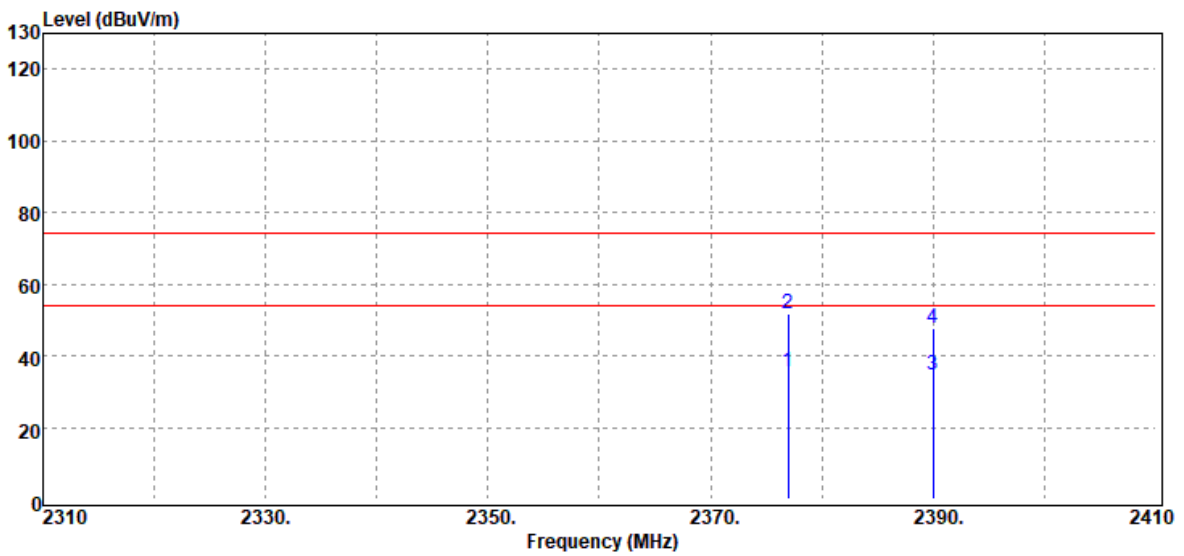

Freq. MHz	Detector Mode PK/QP/AV	Spectrum Reading Level dB μ V	Factor dB	Actual FS dB μ V/m	Limit @3m dB μ V/m	Margin dB
2377.00	Average	38.98	-3.36	35.62	54.00	-18.38
2377.00	Peak	55.31	-3.36	51.95	74.00	-22.05
2390.00	Average	38.13	-3.38	34.75	54.00	-19.25
2390.00	Peak	50.95	-3.38	47.57	74.00	-26.43

Report No.: T191120D05-RP1

Test Mode:	GFSK_BDR-1Mbps High CH	Temp/Hum	18.6(°C)/ 53%RH
Test Item	Band Edge	Test Date	December 11, 2019
Polarize	Vertical	Test Engineer	Jerry Chang
Detector	Peak / Average		

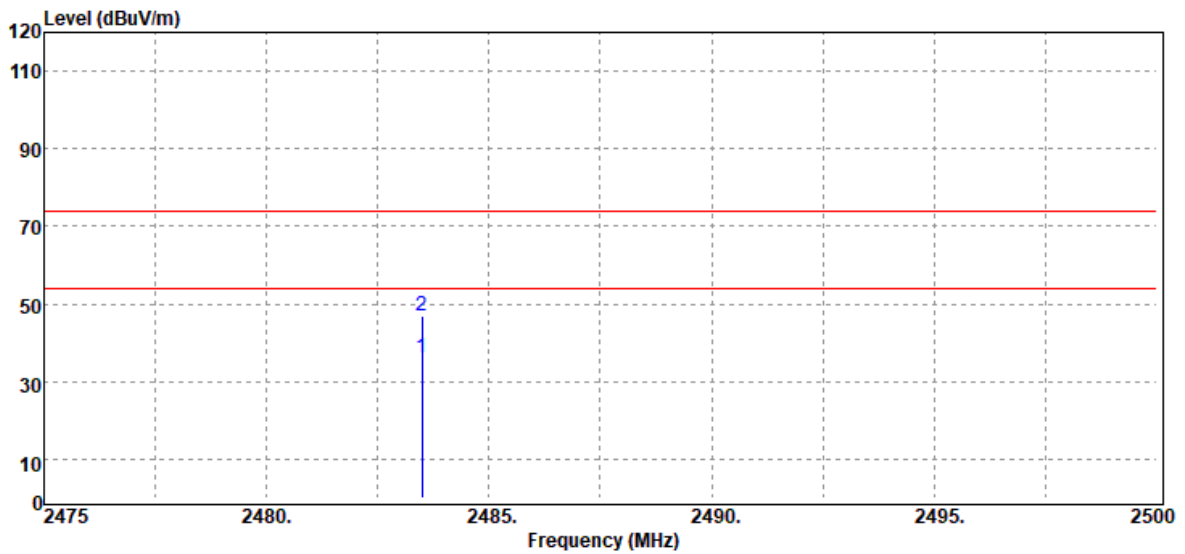

Freq. MHz	Detector Mode PK/QP/AV	Spectrum Reading Level dB μ V	Factor dB	Actual FS dB μ V/m	Limit @3m dB μ V/m	Margin dB
2483.50	Average	39.13	-2.83	36.30	54.00	-17.70
2483.50	Peak	49.65	-2.83	46.82	74.00	-27.18

Report No.: T191120D05-RP1

Test Mode:	GFSK_BDR-1Mbps High CH	Temp/Hum	18.6(°C)/ 53%RH
Test Item	Band Edge	Test Date	December 11, 2019
Polarize	Horizontal	Test Engineer	Jerry Chang
Detector	Peak / Average		

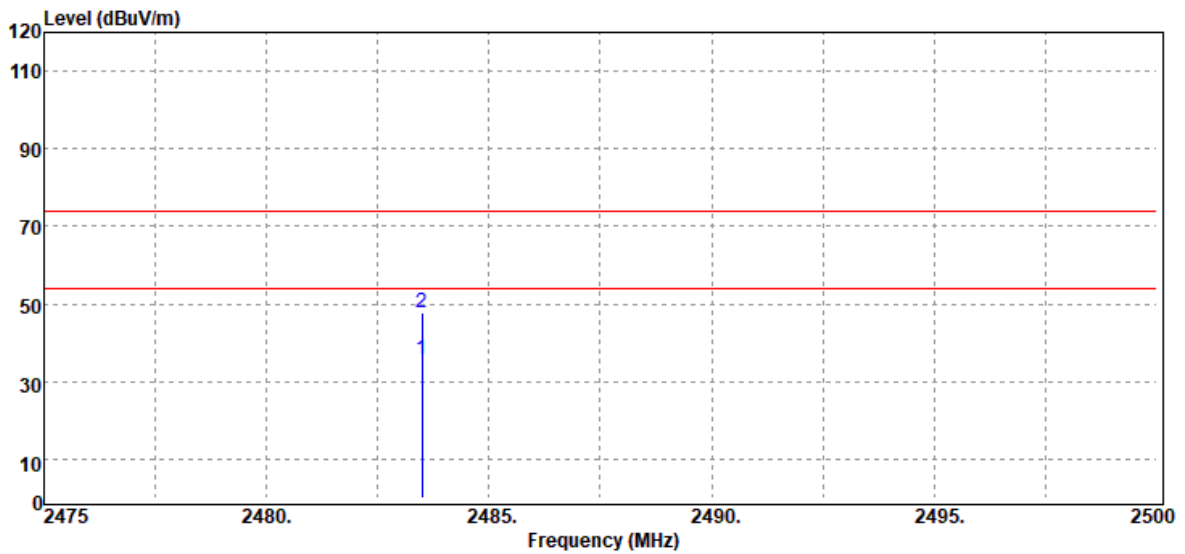

Freq. MHz	Detector Mode PK/QP/AV	Spectrum Reading Level dB μ V	Factor dB	Actual FS dB μ V/m	Limit @3m dB μ V/m	Margin dB
2483.50	Average	38.59	-2.83	35.76	54.00	-18.24
2483.50	Peak	50.45	-2.83	47.62	74.00	-26.38

Report No.: T191120D05-RP1

Test Mode:	GFSK_BDR-1Mbps Low CH Hopping	Temp/Hum	18.6(°C)/ 53%RH
Test Item	Band Edge	Test Date	December 11, 2019
Polarize	Vertical	Test Engineer	Jerry Chang
Detector	Peak / Average		

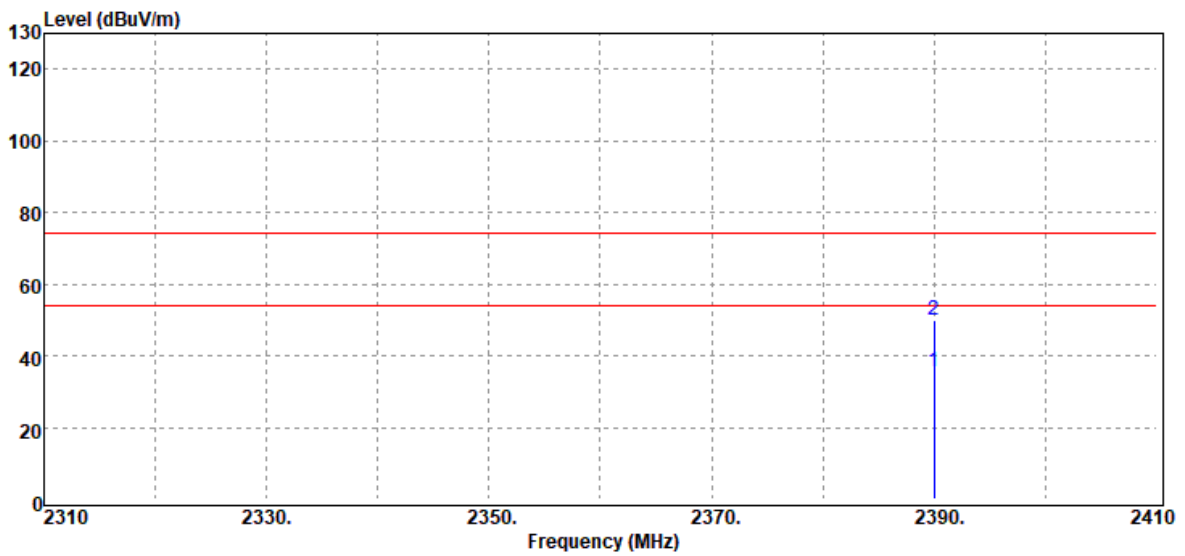

Freq. MHz	Detector Mode PK/QP/AV	Spectrum Reading Level dB μ V	Factor dB	Actual FS dB μ V/m	Limit @3m dB μ V/m	Margin dB
2390.00	Average	38.79	-3.38	35.41	54.00	-18.59
2390.00	Peak	53.17	-3.38	49.79	74.00	-24.21

Report No.: T191120D05-RP1

Test Mode:	GFSK_BDR-1Mbps Low CH Hopping	Temp/Hum	18.6(°C)/ 53%RH
Test Item	Band Edge	Test Date	December 11, 2019
Polarize	Horizontal	Test Engineer	Jerry Chang
Detector	Peak / Average		

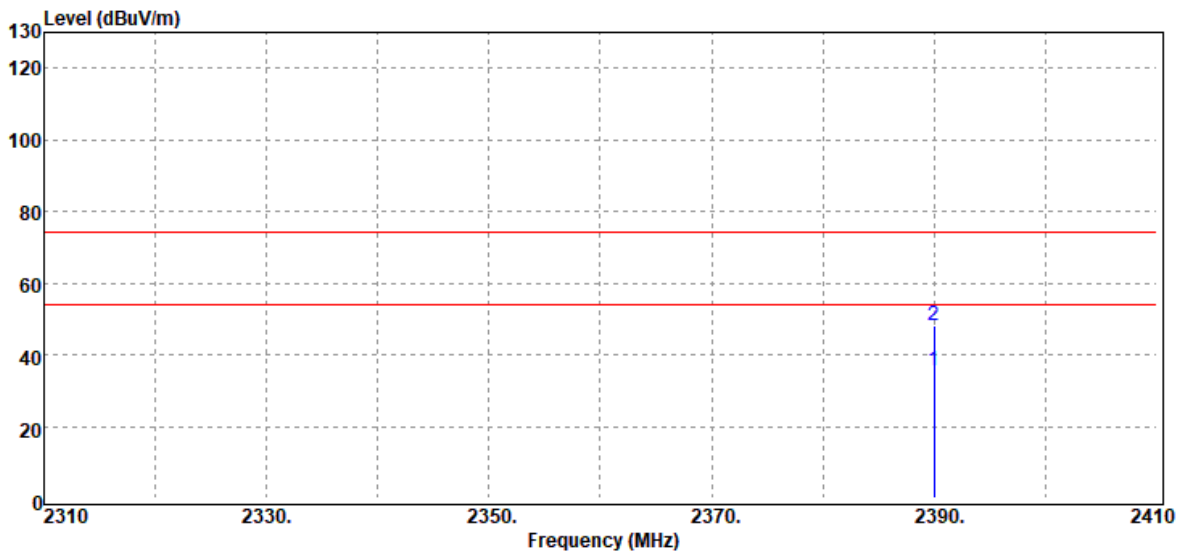

Freq. MHz	Detector Mode PK/QP/AV	Spectrum Reading Level dB μ V	Factor dB	Actual FS dB μ V/m	Limit @3m dB μ V/m	Margin dB
2390.00	Average	38.77	-3.38	35.39	54.00	-18.61
2390.00	Peak	51.44	-3.38	48.06	74.00	-25.94

Report No.: T191120D05-RP1

Test Mode:	GFSK_BDR-1Mbps High CH Hopping	Temp/Hum	18.6(°C)/ 53%RH
Test Item	Band Edge	Test Date	December 11, 2019
Polarize	Vertical	Test Engineer	Jerry Chang
Detector	Peak / Average		

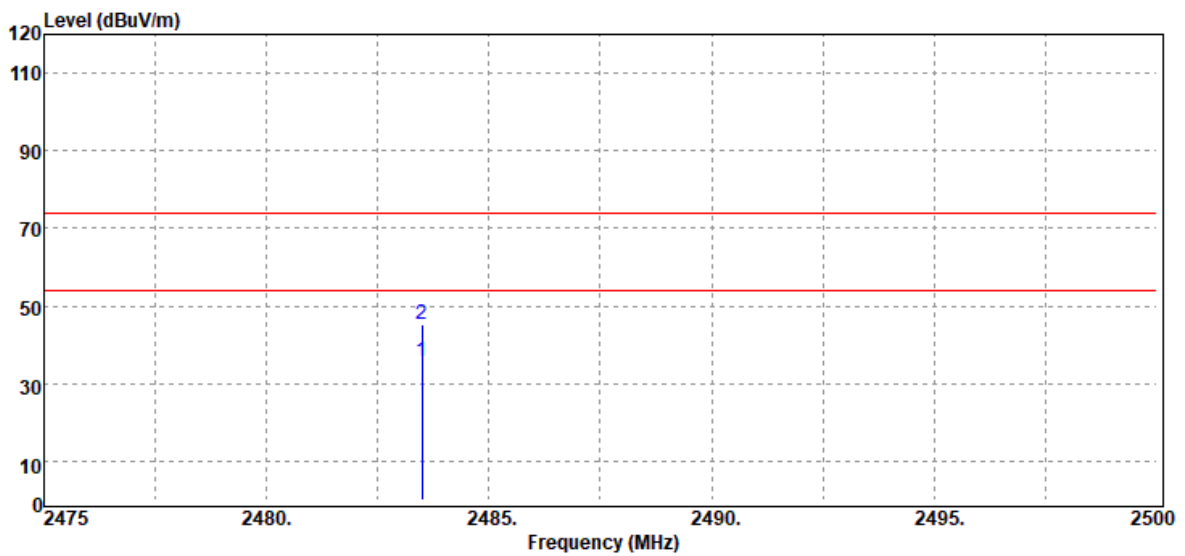

Freq. MHz	Detector Mode PK/QP/AV	Spectrum Reading Level dB μ V	Factor dB	Actual FS dB μ V/m	Limit @3m dB μ V/m	Margin dB
2483.50	Average	38.35	-2.83	35.52	54.00	-18.48
2483.50	Peak	48.25	-2.83	45.42	74.00	-28.58

Report No.: T191120D05-RP1

Test Mode:	GFSK_BDR-1Mbps High CH Hopping	Temp/Hum	18.6(°C)/ 53%RH
Test Item	Band Edge	Test Date	December 11, 2019
Polarize	Horizontal	Test Engineer	Jerry Chang
Detector	Peak / Average		

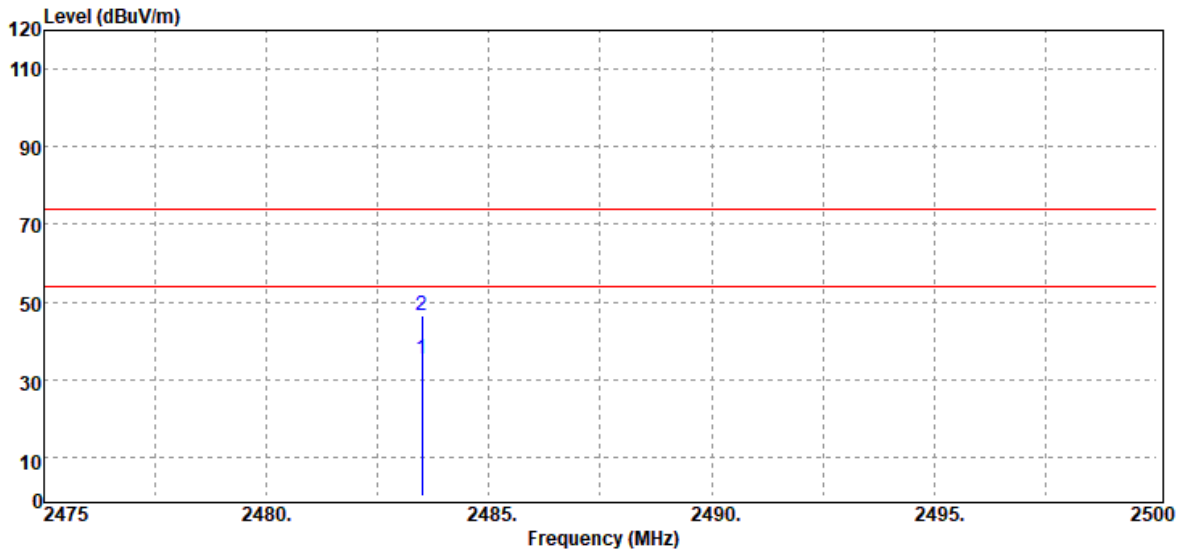

Freq. MHz	Detector Mode PK/QP/AV	Spectrum Reading Level dB μ V	Factor dB	Actual FS dB μ V/m	Limit @3m dB μ V/m	Margin dB
2483.50	Average	38.28	-2.83	35.45	54.00	-18.55
2483.50	Peak	49.29	-2.83	46.46	74.00	-27.54

Report No.: T191120D05-RP1

Test Mode:	8DPSK_EDR-3Mbps Low CH	Temp/Hum	18.6(°C)/ 53%RH
Test Item	Band Edge	Test Date	December 11, 2019
Polarize	Vertical	Test Engineer	Jerry Chang
Detector	Peak / Average		

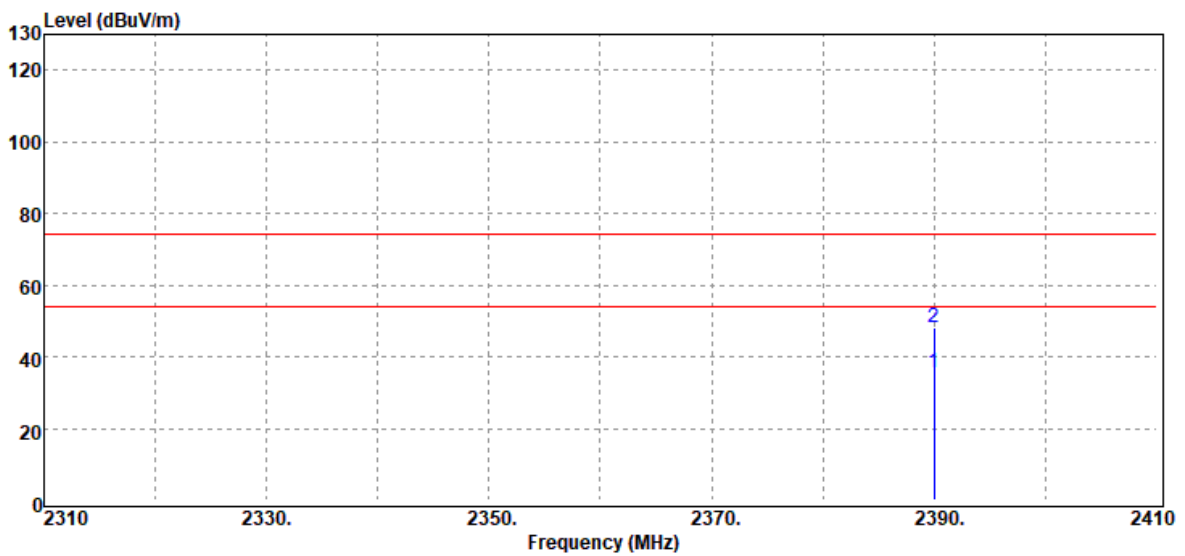

Freq. MHz	Detector Mode PK/QP/AV	Spectrum Reading Level dB μ V	Factor dB	Actual FS dB μ V/m	Limit @3m dB μ V/m	Margin dB
2390.00	Average	38.78	-3.38	35.40	54.00	-18.60
2390.00	Peak	51.44	-3.38	48.06	74.00	-25.94

Report No.: T191120D05-RP1

Test Mode:	8DPSK_EDR-3Mbps Low CH	Temp/Hum	18.6(°C)/ 53%RH
Test Item	Band Edge	Test Date	December 11, 2019
Polarize	Horizontal	Test Engineer	Jerry Chang
Detector	Peak / Average		

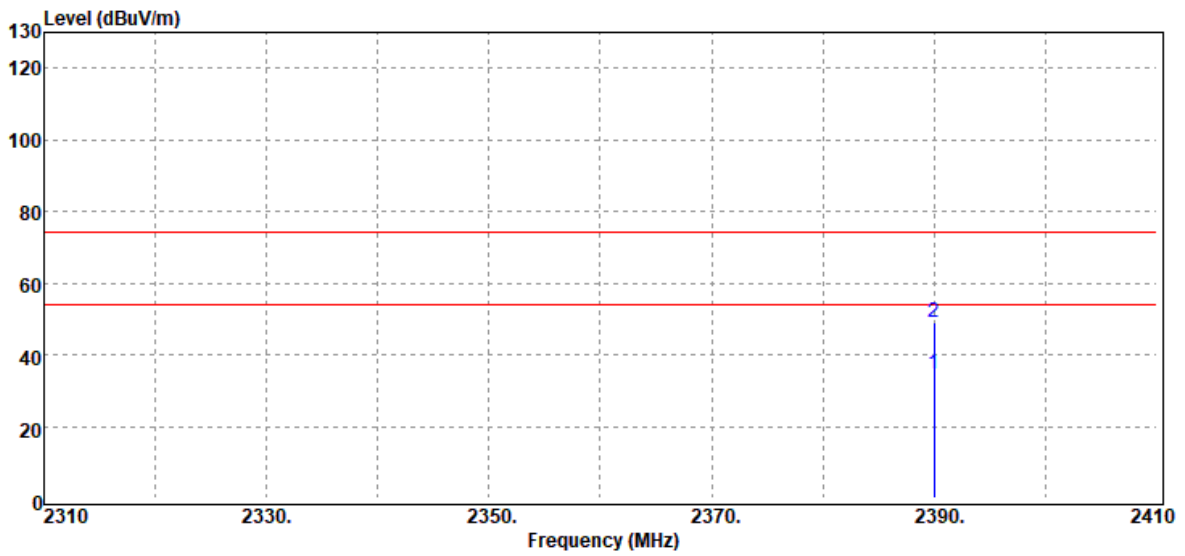

Freq. MHz	Detector Mode PK/QP/AV	Spectrum Reading Level dB μ V	Factor dB	Actual FS dB μ V/m	Limit @3m dB μ V/m	Margin dB
2390.00	Average	37.84	-3.38	34.46	54.00	-19.54
2390.00	Peak	52.19	-3.38	48.81	74.00	-25.19

Report No.: T191120D05-RP1

Test Mode:	8DPSK_EDR-3Mbps High CH	Temp/Hum	18.6(°C)/ 53%RH
Test Item	Band Edge	Test Date	December 11, 2019
Polarize	Vertical	Test Engineer	Jerry Chang
Detector	Peak / Average		

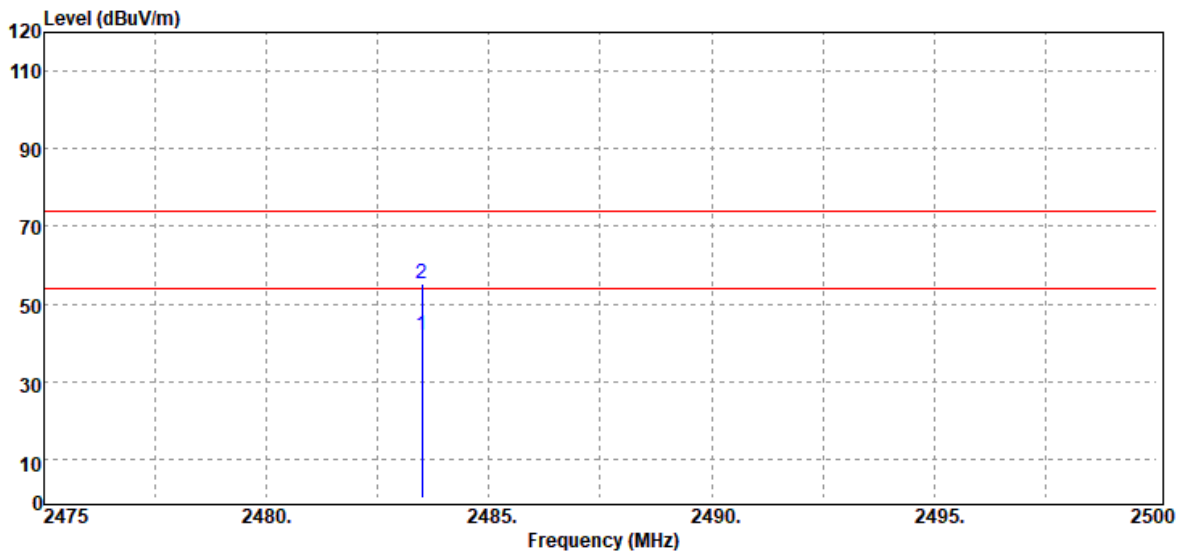

Freq. MHz	Detector Mode PK/QP/AV	Spectrum Reading Level dB μ V	Factor dB	Actual FS dB μ V/m	Limit @3m dB μ V/m	Margin dB
2483.50	Average	44.86	-2.83	42.03	54.00	-11.97
2483.50	Peak	58.22	-2.83	55.39	74.00	-18.61

Report No.: T191120D05-RP1

Test Mode:	8DPSK_EDR-3Mbps High CH	Temp/Hum	18.6(°C)/ 53%RH
Test Item	Band Edge	Test Date	December 11, 2019
Polarize	Horizontal	Test Engineer	Jerry Chang
Detector	Peak / Average		

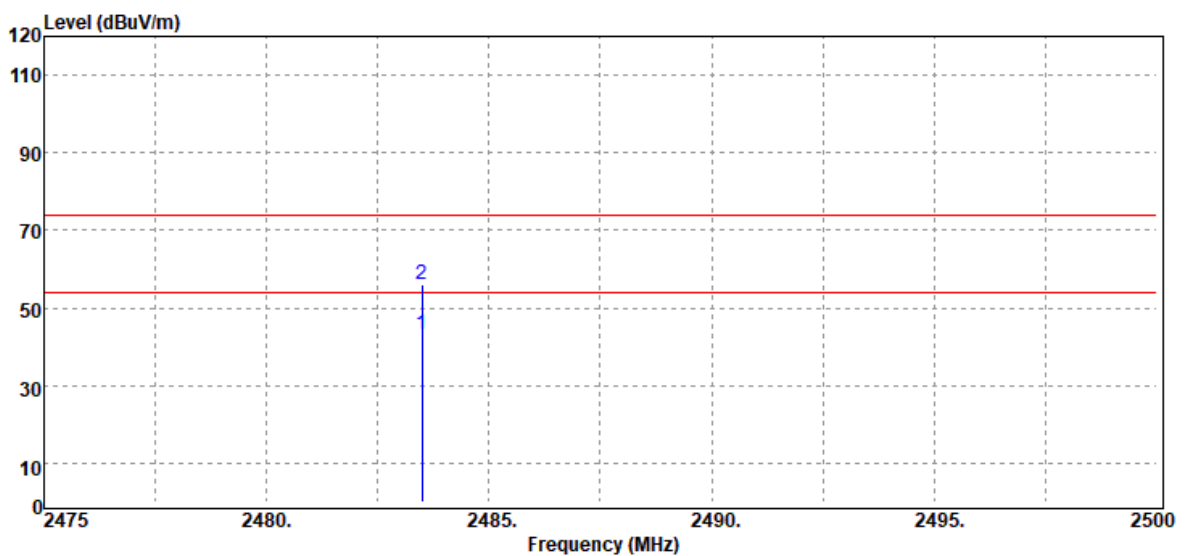

Freq. MHz	Detector Mode PK/QP/AV	Spectrum Reading Level dB μ V	Factor dB	Actual FS dB μ V/m	Limit @3m dB μ V/m	Margin dB
2483.50	Average	45.81	-2.83	42.98	54.00	-11.02
2483.50	Peak	58.87	-2.83	56.04	74.00	-17.96

Report No.: T191120D05-RP1

Test Mode:	8DPSK_EDR-3Mbps Low CH Hopping	Temp/Hum	18.6(°C)/ 53%RH
Test Item	Band Edge	Test Date	December 11, 2019
Polarize	Vertical	Test Engineer	Jerry Chang
Detector	Peak / Average		

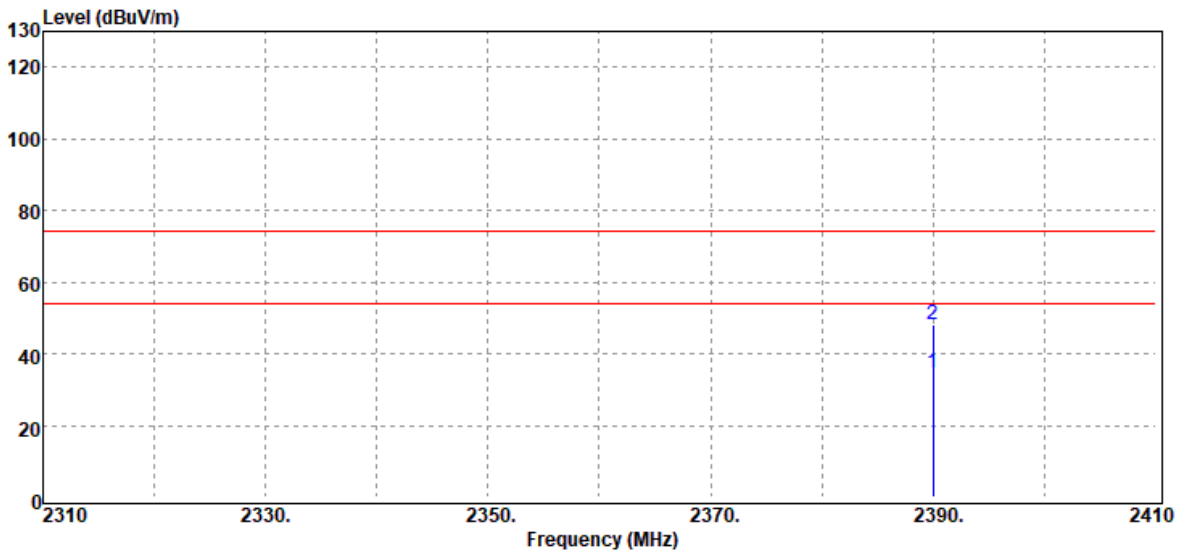

Freq. MHz	Detector Mode PK/QP/AV	Spectrum Reading Level dB μ V	Factor dB	Actual FS dB μ V/m	Limit @3m dB μ V/m	Margin dB
2390.00	Average	37.96	-3.38	34.58	54.00	-19.42
2390.00	Peak	51.62	-3.38	48.24	74.00	-25.76

Report No.: T191120D05-RP1

Test Mode:	8DPSK_EDR-3Mbps Low CH Hopping	Temp/Hum	18.6(°C)/ 53%RH
Test Item	Band Edge	Test Date	December 11, 2019
Polarize	Horizontal	Test Engineer	Jerry Chang
Detector	Peak / Average		

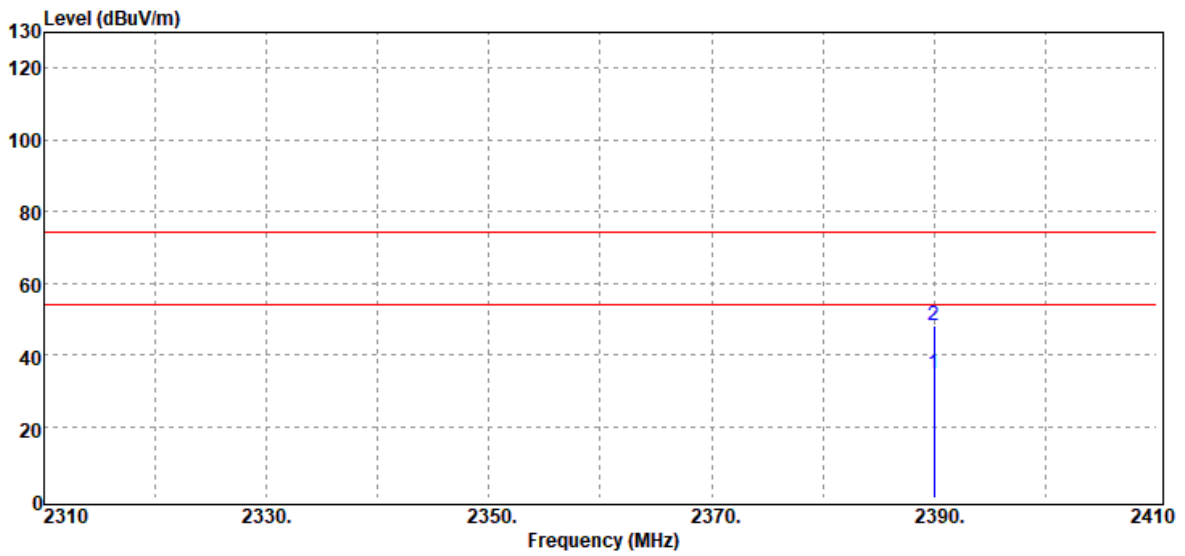

Freq. MHz	Detector Mode PK/QP/AV	Spectrum Reading Level dB μ V	Factor dB	Actual FS dB μ V/m	Limit @3m dB μ V/m	Margin dB
2390.00	Average	37.83	-3.38	34.45	54.00	-19.55
2390.00	Peak	51.32	-3.38	47.94	74.00	-26.06

Report No.: T191120D05-RP1

Test Mode:	8DPSK_EDR-3Mbps High CH Hopping	Temp/Hum	18.6(°C)/ 53%RH
Test Item	Band Edge	Test Date	December 11, 2019
Polarize	Vertical	Test Engineer	Jerry Chang
Detector	Peak / Average		

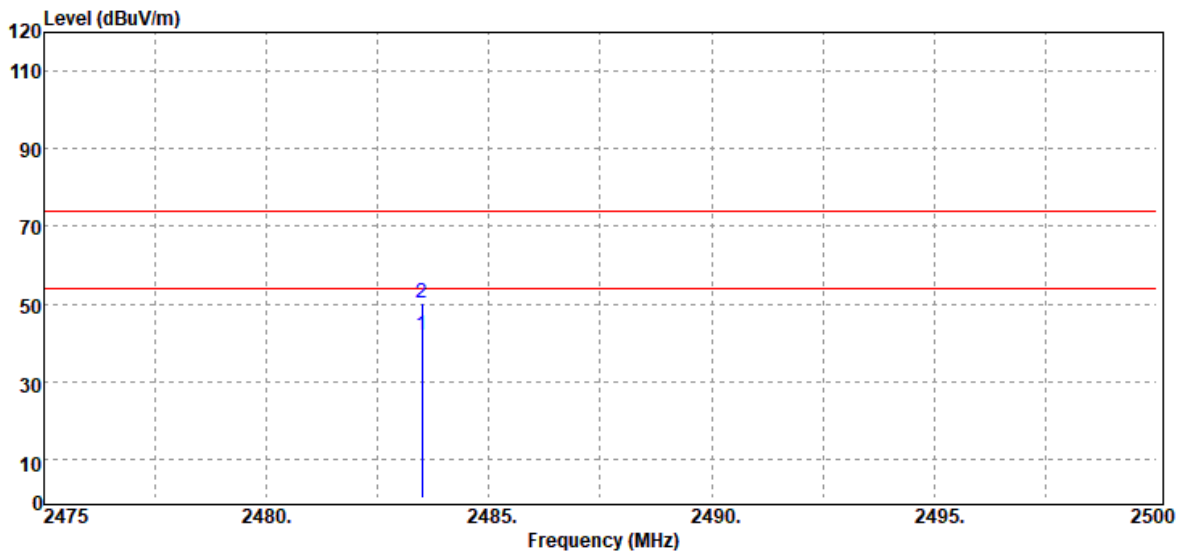

Freq. MHz	Detector Mode PK/QP/AV	Spectrum Reading Level dB μ V	Factor dB	Actual FS dB μ V/m	Limit @3m dB μ V/m	Margin dB
2483.50	Average	44.60	-2.83	41.77	54.00	-12.23
2483.50	Peak	53.05	-2.83	50.22	74.00	-23.78

Report No.: T191120D05-RP1

Test Mode:	8DPSK_EDR-3Mbps High CH Hopping	Temp/Hum	18.6(°C)/ 53%RH
Test Item	Band Edge	Test Date	December 11, 2019
Polarize	Horizontal	Test Engineer	Jerry Chang
Detector	Peak / Average		

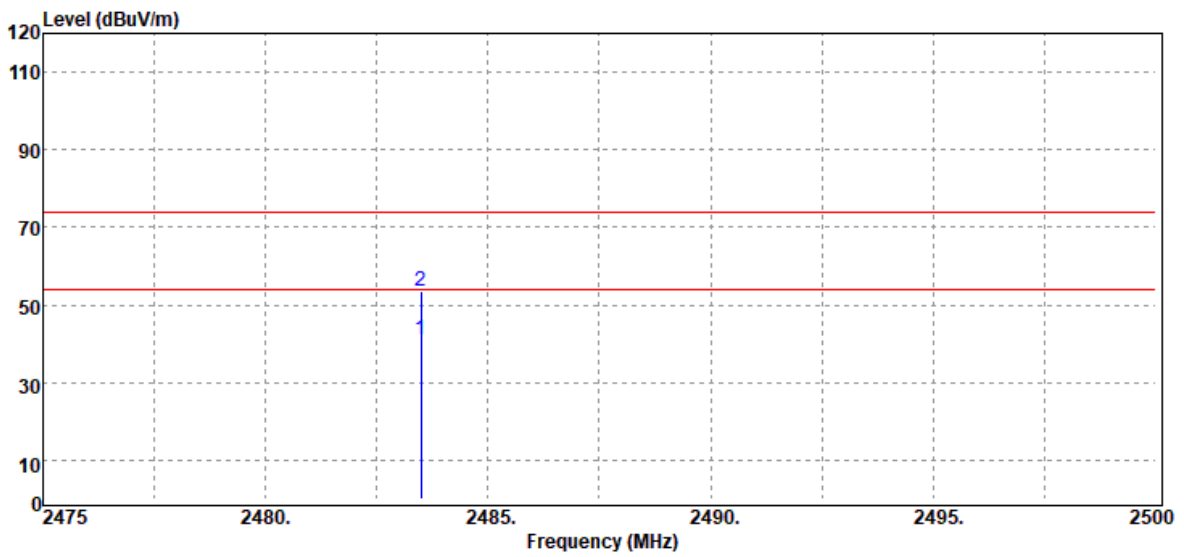

Freq. MHz	Detector Mode PK/QP/AV	Spectrum Reading Level dB μ V	Factor dB	Actual FS dB μ V/m	Limit @3m dB μ V/m	Margin dB
2483.50	Average	43.86	-2.83	41.03	54.00	-12.97
2483.50	Peak	56.38	-2.83	53.55	74.00	-20.45

Report No.: T191120D05-RP1

Below 1G Test Data

Test Mode:	BT Mode	Temp/Hum	18.6(°C)/ 53%RH
Test Item	30MHz-1GHz	Test Date	January 7, 2020
Polarize	Vertical	Test Engineer	Jerry Chang
Detector	Peak		

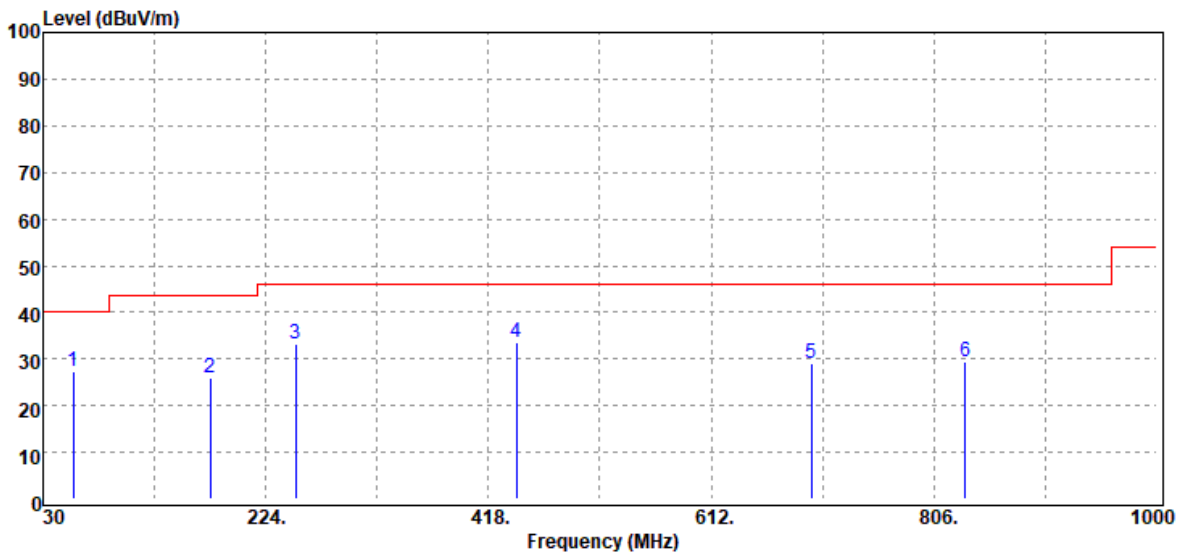

Freq. MHz	Detector Mode PK/QP/AV	Spectrum Reading Level dBµV	Factor dB	Actual FS dBµV/m	Limit @3m dBµV/m	Margin dB
56.19	Peak	43.24	-15.96	27.28	40.00	-12.72
175.50	Peak	36.94	-11.11	25.83	43.50	-17.67
250.19	Peak	43.71	-10.40	33.31	46.00	-12.69
442.25	Peak	37.57	-4.05	33.52	46.00	-12.48
699.30	Peak	29.07	-0.04	29.03	46.00	-16.97
833.16	Peak	25.76	3.51	29.27	46.00	-16.73

Note: No emission found between lowest internal used/generated frequency to 30MHz(9KHz~30MHz)

Report No.: T191120D05-RP1

Test Mode:	BT Mode	Temp/Hum	18.6(°C)/ 53%RH
Test Item	30MHz-1GHz	Test Date	January 7, 2020
Polarize	Horizontal	Test Engineer	Jerry Chang
Detector	Peak		

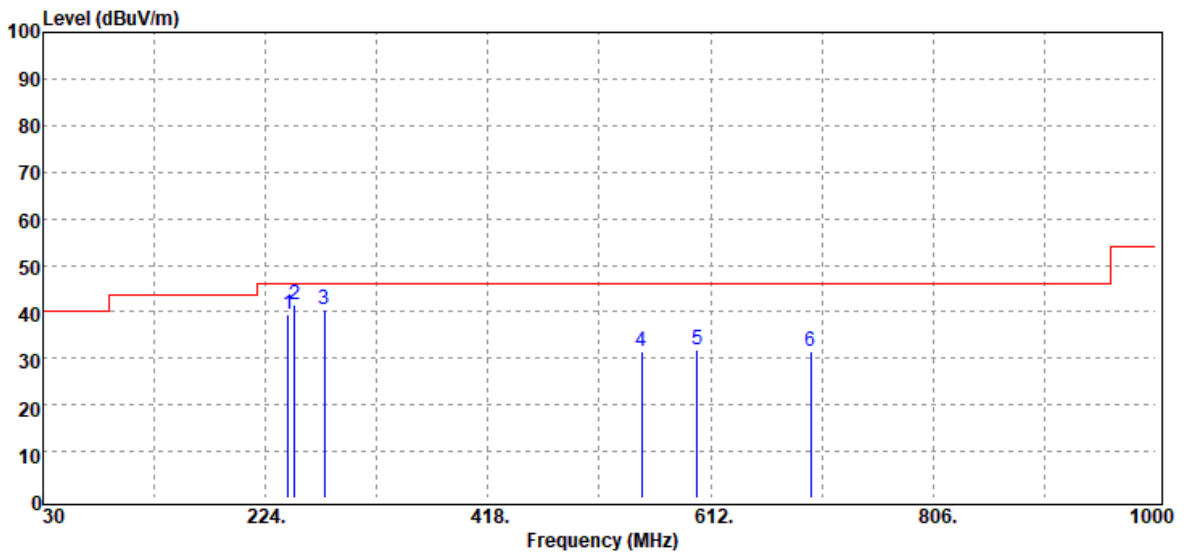

Freq. MHz	Detector Mode PK/QP/AV	Spectrum Reading Level dB μ V	Factor dB	Actual FS dB μ V/m	Limit @3m dB μ V/m	Margin dB
243.40	Peak	49.90	-10.28	39.62	46.00	-6.38
249.22	Peak	51.85	-10.36	41.49	46.00	-4.51
275.41	Peak	48.76	-8.42	40.34	46.00	-5.66
551.86	Peak	33.87	-2.22	31.65	46.00	-14.35
600.36	Peak	33.34	-1.65	31.69	46.00	-14.31
699.30	Peak	31.67	-0.04	31.63	46.00	-14.37

Note: No emission found between lowest internal used/generated frequency to 30MHz(9KHz~30MHz)

Report No.: T191120D05-RP1

Above 1G Test Data

Test Mode:	GFSK_BR-1Mbps Low CH	Temp/Hum	18.6(°C)/ 53%RH
Test Item	Harmonic	Test Date	January 7, 2020
Polarize	Vertical	Test Engineer	Jerry Chang
Detector	Peak & Average		

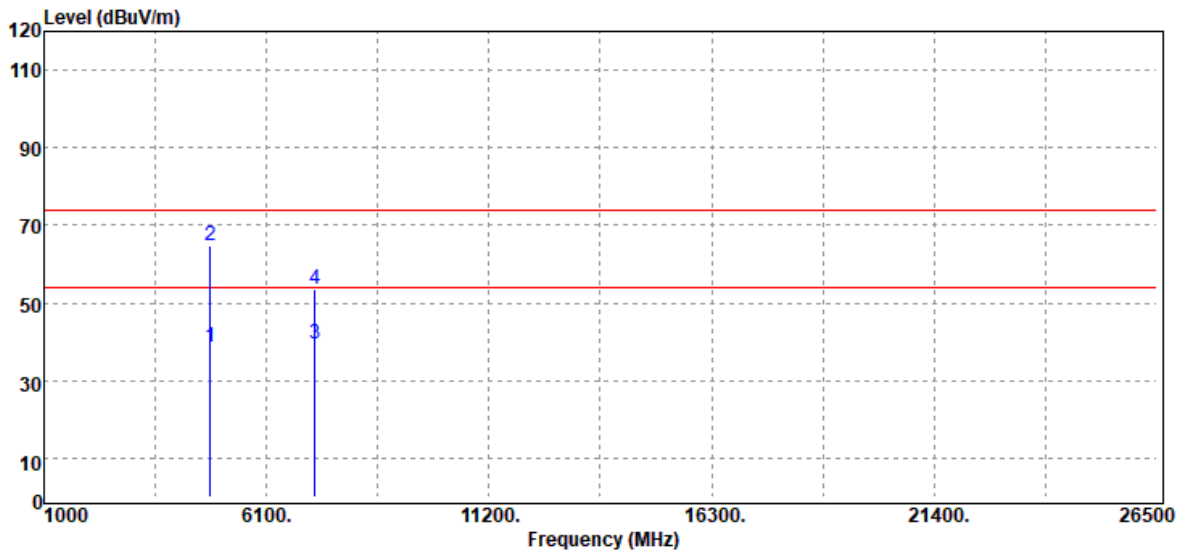

Freq. MHz	Detector Mode PK/QP/AV	Spectrum Reading Level dBμV	Factor dB	Actual FS dBμV/m	Limit @3m dBμV/m	Margin dB
4804.00	Average	34.88	3.56	38.44	54.00	-15.56
4804.00	Peak	61.28	3.56	64.84	74.00	-9.16
7206.00	Average	28.35	10.93	39.28	54.00	-14.72
7206.00	Peak	42.51	10.93	53.44	74.00	-20.56

Remark:

1. Measuring frequencies from 1 GHz to the 10th harmonic of highest fundamental frequency.

Report No.: T191120D05-RP1

Test Mode:	GFSK_BR-1Mbps Low CH	Temp/Hum	18.6(°C)/ 53%RH
Test Item	Harmonic	Test Date	January 7, 2020
Polarize	Horizontal	Test Engineer	Jerry Chang
Detector	Peak & Average		

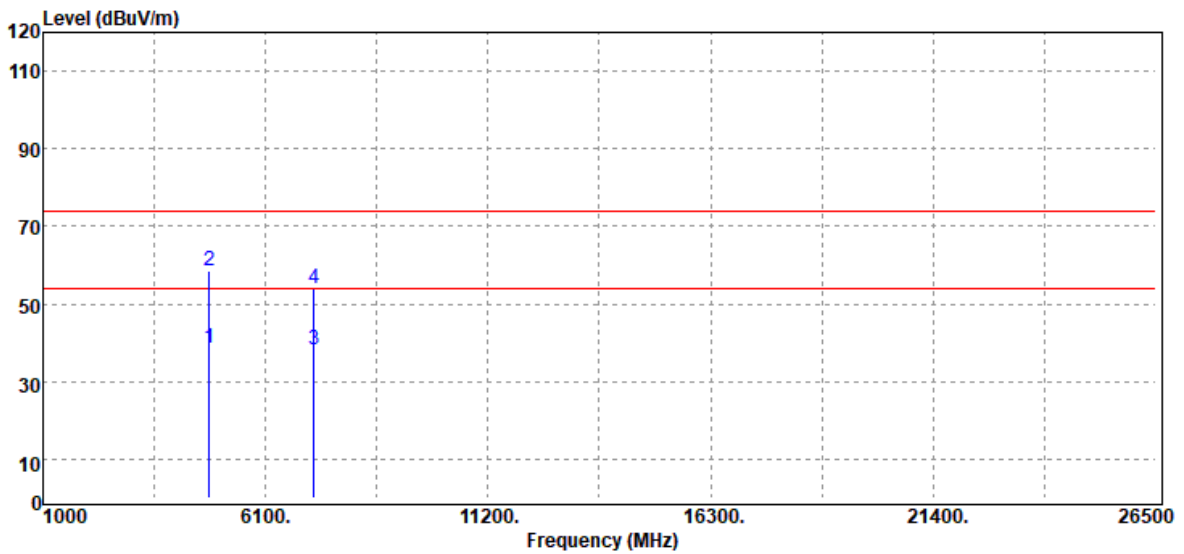

Freq. MHz	Detector Mode PK/QP/AV	Spectrum Reading Level dB μ V	Factor dB	Actual FS dB μ V/m	Limit @3m dB μ V/m	Margin dB
4804.00	Average	35.24	3.56	38.80	54.00	-15.20
4804.00	Peak	55.07	3.56	58.63	74.00	-15.37
7206.00	Average	27.48	10.93	38.41	54.00	-15.59
7206.00	Peak	43.10	10.93	54.03	74.00	-19.97

Remark:

1. Measuring frequencies from 1 GHz to the 10th harmonic of highest fundamental frequency.

Report No.: T191120D05-RP1

Test Mode:	GFSK_BR-1Mbps Mid CH	Temp/Hum	18.6(°C)/ 53%RH
Test Item	Harmonic	Test Date	January 7, 2020
Polarize	Vertical	Test Engineer	Jerry Chang
Detector	Peak & Average		

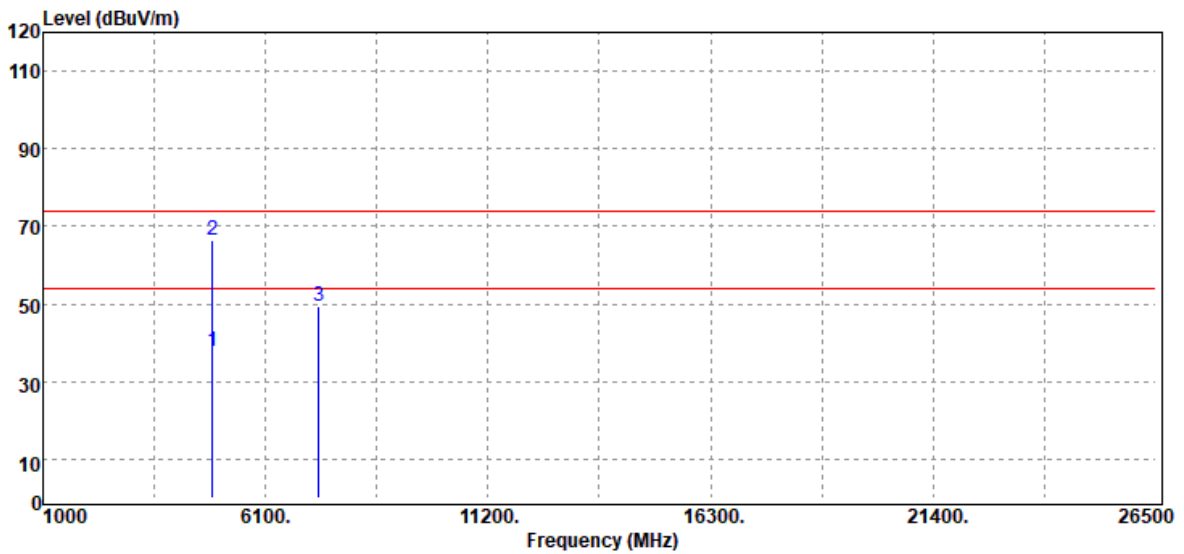

Freq. MHz	Detector Mode PK/QP/AV	Spectrum Reading Level dB μ V	Factor dB	Actual FS dB μ V/m	Limit @3m dB μ V/m	Margin dB
4882.00	Average	34.15	3.78	37.93	54.00	-16.07
4882.00	Peak	62.71	3.78	66.49	74.00	-7.51
7323.00	Peak	38.11	11.40	49.51	74.00	-24.49
N/A						

Remark:

1. Measuring frequencies from 1 GHz to the 10th harmonic of highest fundamental frequency.

Report No.: T191120D05-RP1

Test Mode:	GFSK_BR-1Mbps Mid CH	Temp/Hum	18.6(°C)/ 53%RH
Test Item	Harmonic	Test Date	January 7, 2020
Polarize	Horizontal	Test Engineer	Jerry Chang
Detector	Peak & Average		

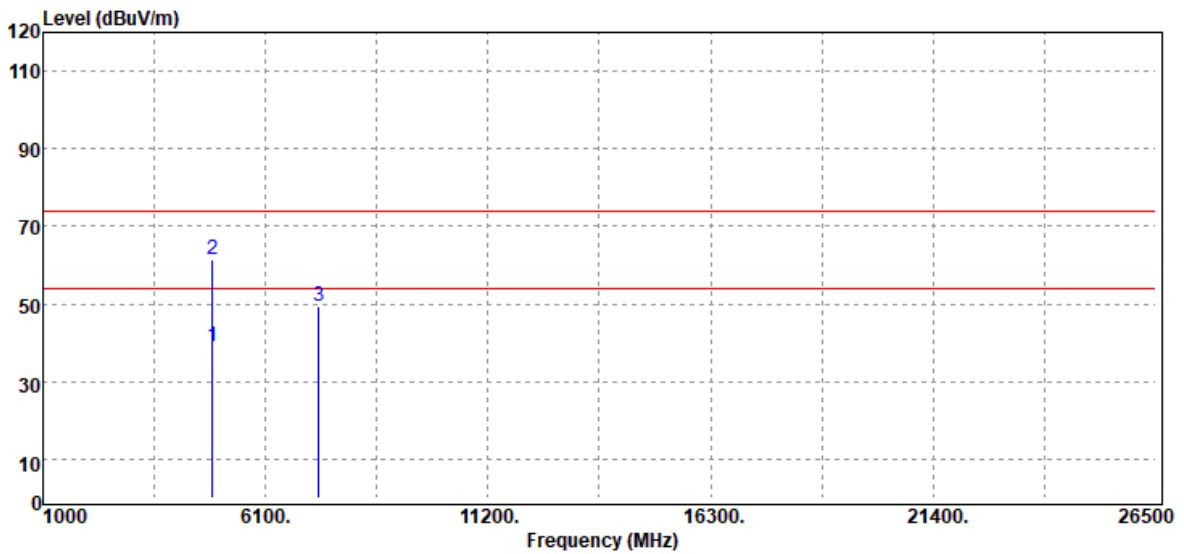

Freq. MHz	Detector Mode PK/QP/AV	Spectrum Reading Level dB μ V	Factor dB	Actual FS dB μ V/m	Limit @3m dB μ V/m	Margin dB
4882.00	Average	35.24	3.78	39.02	54.00	-14.98
4882.00	Peak	57.60	3.78	61.38	74.00	-12.62
7323.00	Peak	37.83	11.40	49.23	74.00	-24.77
N/A						

Remark:

1. Measuring frequencies from 1 GHz to the 10th harmonic of highest fundamental frequency.

Report No.: T191120D05-RP1

Test Mode:	GFSK_BR-1Mbps High CH	Temp/Hum	18.6(°C)/ 53%RH
Test Item	Harmonic	Test Date	January 7, 2020
Polarize	Vertical	Test Engineer	Jerry Chang
Detector	Peak & Average		

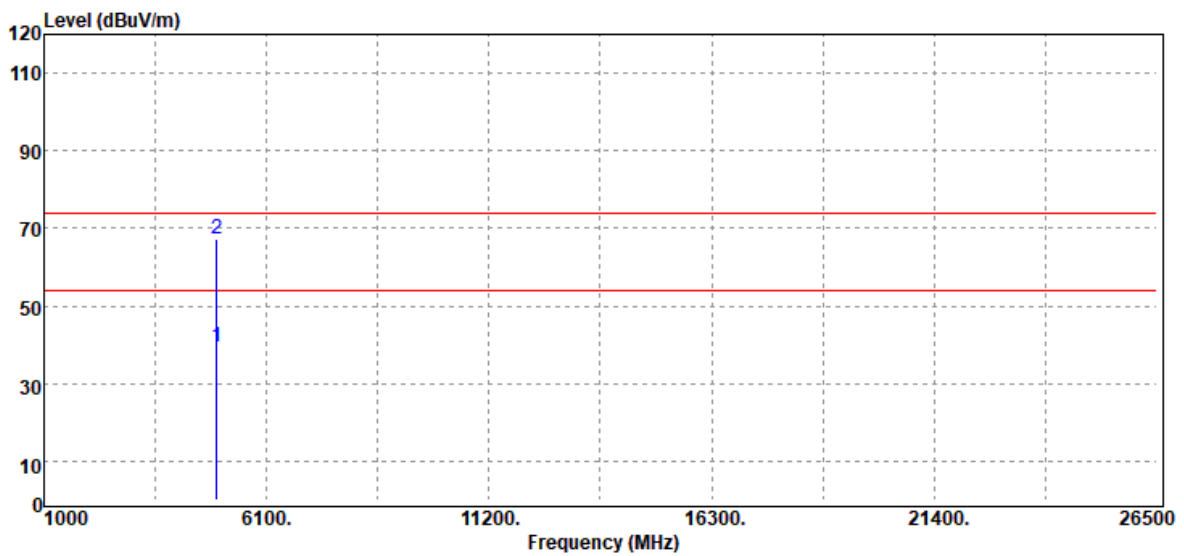

Freq. MHz	Detector Mode PK/QP/AV	Spectrum Reading Level dB μ V	Factor dB	Actual FS dB μ V/m	Limit @3m dB μ V/m	Margin dB
4960.00	Average	34.85	4.56	39.41	54.00	-14.59
4960.00	Peak	62.73	4.56	67.29	74.00	-6.71
N/A						

Remark:

1. Measuring frequencies from 1 GHz to the 10th harmonic of highest fundamental frequency.

Report No.: T191120D05-RP1

Test Mode:	GFSK_BR-1Mbps High CH	Temp/Hum	18.6(°C)/ 53%RH
Test Item	Harmonic	Test Date	January 7, 2020
Polarize	Horizontal	Test Engineer	Jerry Chang
Detector	Peak & Average		

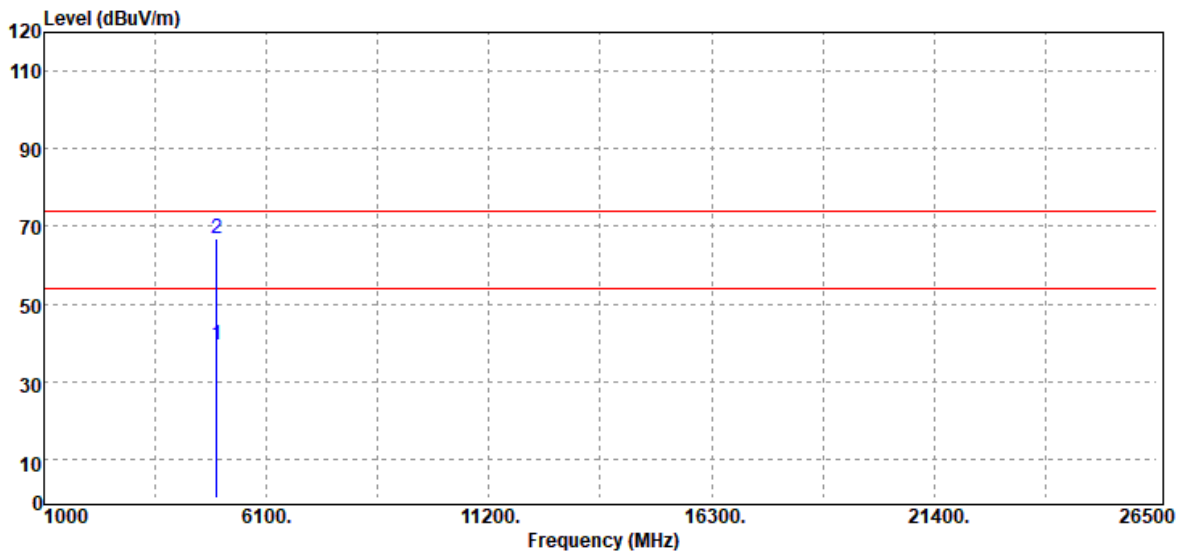

Freq. MHz	Detector Mode PK/QP/AV	Spectrum Reading Level dB μ V	Factor dB	Actual FS dB μ V/m	Limit @3m dB μ V/m	Margin dB
4960.00	Average	35.01	4.56	39.57	54.00	-14.43
4960.00	Peak	62.10	4.56	66.66	74.00	-7.34
N/A						

Remark:

1. Measuring frequencies from 1 GHz to the 10th harmonic of highest fundamental frequency.

Report No.: T191120D05-RP1

Test Mode	8DPSK_EDR-3Mbps Low CH	Temp/Hum	18.6(°C)/ 53%RH
Test Item	Harmonic	Test Date	January 7, 2020
Polarize	Vertical	Test Engineer	Jerry Chang
Detector	Peak & Average		

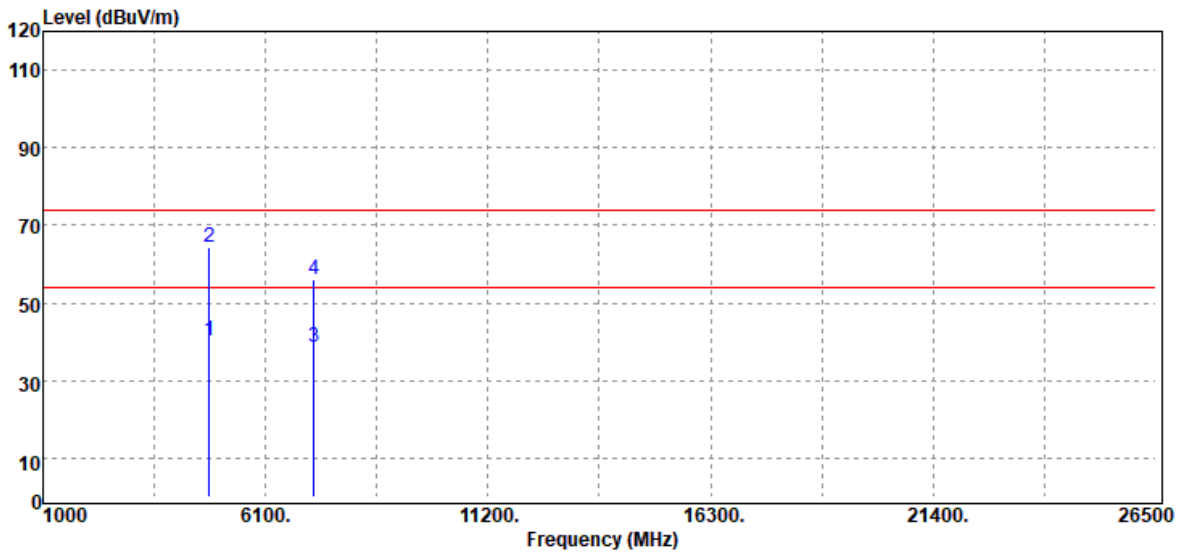

Freq. MHz	Detector Mode PK/QP/AV	Spectrum Reading Level dB μ V	Factor dB	Actual FS dB μ V/m	Limit @3m dB μ V/m	Margin dB
4804.00	Average	36.72	3.56	40.28	54.00	-13.72
4804.00	Peak	60.79	3.56	64.35	74.00	-9.65
7206.00	Average	27.81	10.93	38.74	54.00	-15.26
7206.00	Peak	45.00	10.93	55.93	74.00	-18.07

Remark:

1. Measuring frequencies from 1 GHz to the 10th harmonic of highest fundamental frequency.

Report No.: T191120D05-RP1

Test Mode	8DPSK_EDR-3Mbps Low CH	Temp/Hum	18.6(°C)/ 53%RH
Test Item	Harmonic	Test Date	January 7, 2020
Polarize	Horizontal	Test Engineer	Jerry Chang
Detector	Peak & Average		

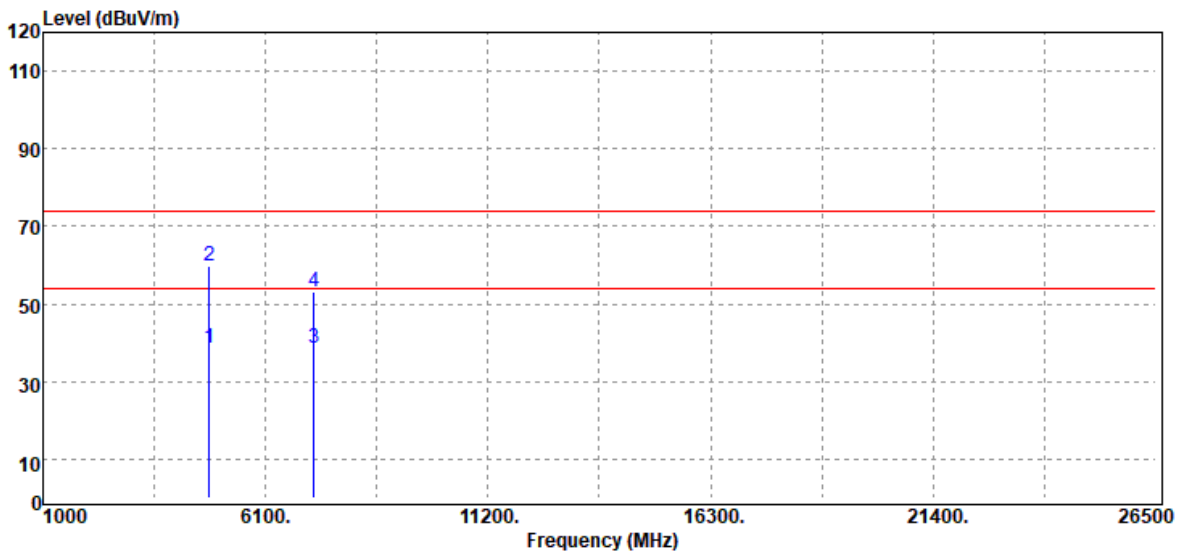

Freq. MHz	Detector Mode PK/QP/AV	Spectrum Reading Level dB μ V	Factor dB	Actual FS dB μ V/m	Limit @3m dB μ V/m	Margin dB
4804.00	Average	35.20	3.56	38.76	54.00	-15.24
4804.00	Peak	56.17	3.56	59.73	74.00	-14.27
7206.00	Average	27.61	10.93	38.54	54.00	-15.46
7206.00	Peak	42.03	10.93	52.96	74.00	-21.04

Remark:

1. Measuring frequencies from 1 GHz to the 10th harmonic of highest fundamental frequency.

Report No.: T191120D05-RP1

Test Mode	8DPSK_EDR-3Mbps Mid CH	Temp/Hum	18.6(°C)/ 53%RH
Test Item	Harmonic	Test Date	January 7, 2020
Polarize	Vertical	Test Engineer	Jerry Chang
Detector	Peak & Average		

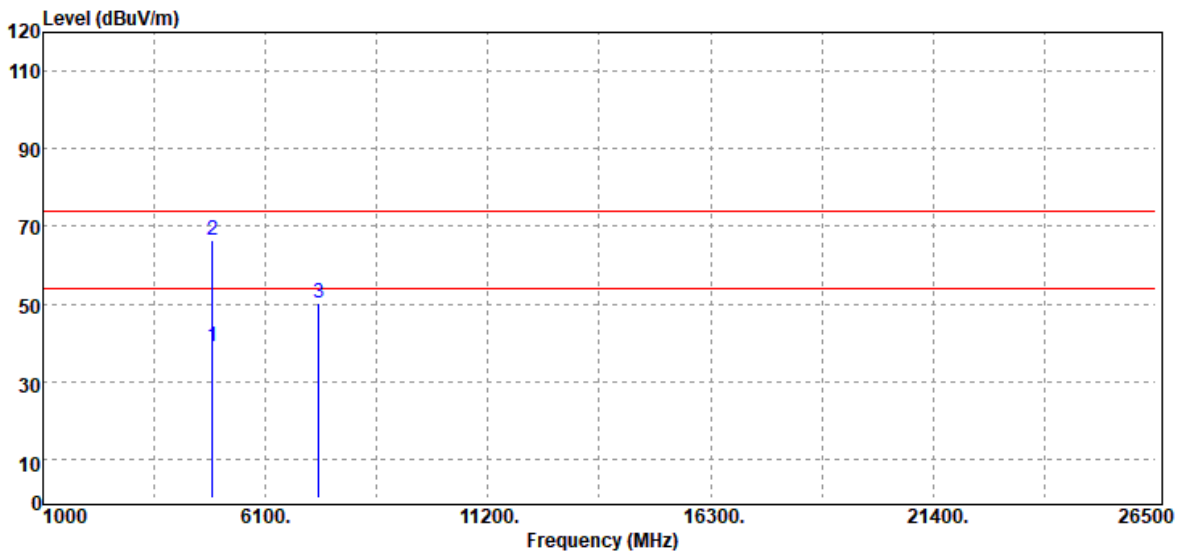

Freq. MHz	Detector Mode PK/QP/AV	Spectrum Reading Level dB μ V	Factor dB	Actual FS dB μ V/m	Limit @3m dB μ V/m	Margin dB
4882.00	Average	35.32	3.78	39.10	54.00	-14.90
4882.00	Peak	62.82	3.78	66.60	74.00	-7.40
7323.00	Peak	38.94	11.40	50.34	74.00	-23.66
N/A						

Remark:

1. Measuring frequencies from 1 GHz to the 10th harmonic of highest fundamental frequency.

Report No.: T191120D05-RP1

Test Mode	8DPSK_EDR-3Mbps Mid CH	Temp/Hum	18.6(°C)/ 53%RH
Test Item	Harmonic	Test Date	January 7, 2020
Polarize	Horizontal	Test Engineer	Jerry Chang
Detector	Peak & Average		

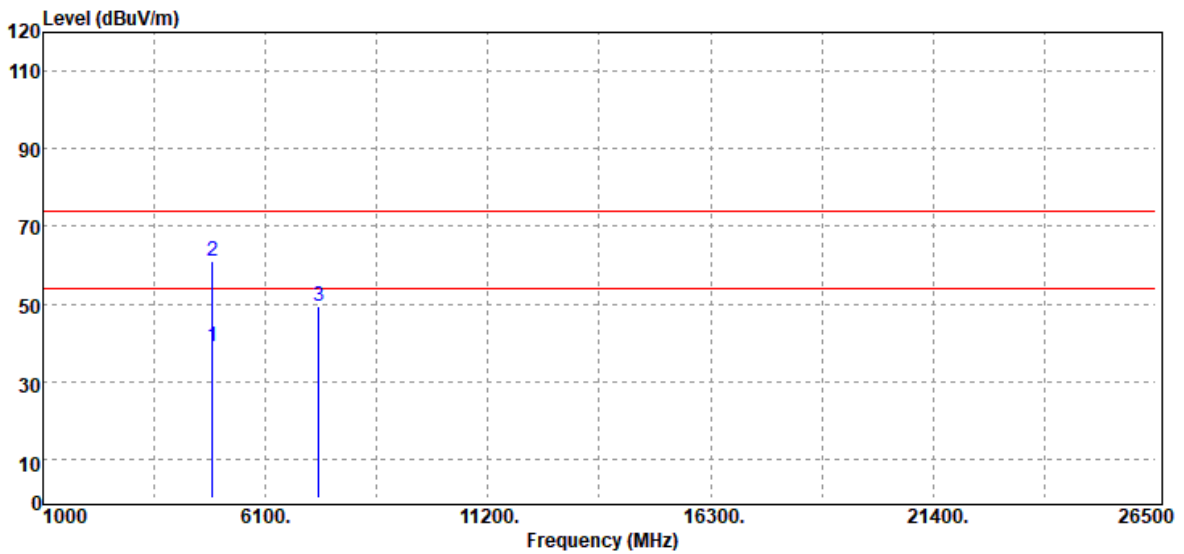

Freq. MHz	Detector Mode PK/QP/AV	Spectrum Reading Level dB μ V	Factor dB	Actual FS dB μ V/m	Limit @3m dB μ V/m	Margin dB
4882.00	Average	35.19	3.78	38.97	54.00	-15.03
4882.00	Peak	57.24	3.78	61.02	74.00	-12.98
7323.00	Peak	38.17	11.40	49.57	74.00	-24.43
N/A						

Remark:

1. Measuring frequencies from 1 GHz to the 10th harmonic of highest fundamental frequency.

Report No.: T191120D05-RP1

Test Mode	8DPSK_EDR-3Mbps High CH	Temp/Hum	18.6(°C)/ 53%RH
Test Item	Harmonic	Test Date	January 7, 2020
Polarize	Vertical	Test Engineer	Jerry Chang
Detector	Peak & Average		

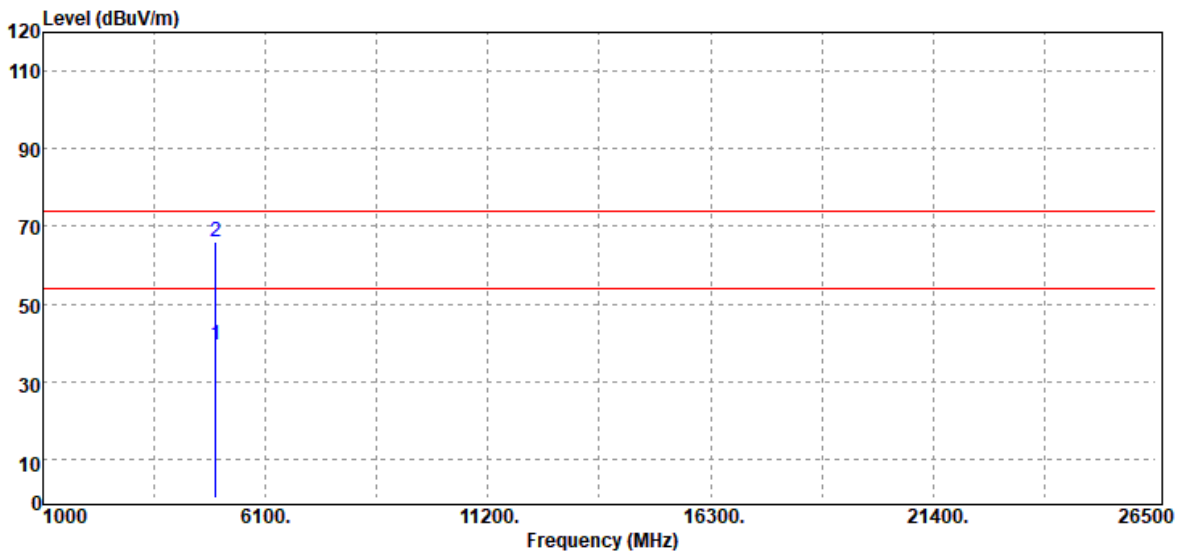

Freq. MHz	Detector Mode PK/QP/AV	Spectrum Reading Level dBµV	Factor dB	Actual FS dBµV/m	Limit @3m dBµV/m	Margin dB
4960.00	Average	35.07	4.56	39.63	54.00	-14.37
4960.00	Peak	61.56	4.56	66.12	74.00	-7.88
N/A						

Remark:

1. Measuring frequencies from 1 GHz to the 10th harmonic of highest fundamental frequency.

Report No.: T191120D05-RP1

Test Mode	8DPSK_EDR-3Mbps High CH	Temp/Hum	18.6(°C)/ 53%RH
Test Item	Harmonic	Test Date	January 7, 2020
Polarize	Horizontal	Test Engineer	Jerry Chang
Detector	Peak & Average		

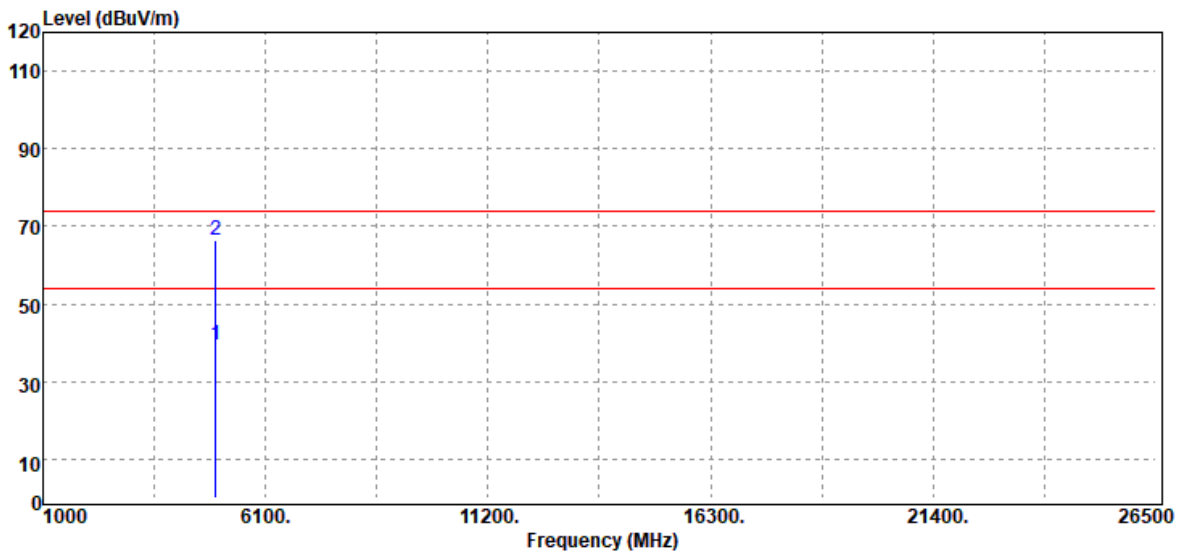

Freq. MHz	Detector Mode PK/QP/AV	Spectrum Reading Level dBμV	Factor dB	Actual FS dBμV/m	Limit @3m dBμV/m	Margin dB
4960.00	Average	35.04	4.56	39.60	54.00	-14.40
4960.00	Peak	61.85	4.56	66.41	74.00	-7.59
N/A						

Remark:

1. Measuring frequencies from 1 GHz to the 10th harmonic of highest fundamental frequency.

--End of Test Report--