



IC: 24213-1002244
Report No.: T200319D03-RC

Page: 1 / 52
Rev.: 03

INDUSTRY CANADA RSS-132 & RSS-133

TEST REPORT

For

GUARDIAN SYSTEM LTE

Model: G2-SY-CON2-1002244

Trade Name: GUARDIAN

Issued to

**Seeing Machines Ltd.
80 Mildura Street Fyshwick ACT 2609 Australia**

Issued by

**Compliance Certification Services Inc.
No.11, Wugong 6th Rd., Wugu Dist.,
New Taipei City, Taiwan. (R.O.C.)
Issued Date: June 20, 2020**

Unless otherwise stated the results shown in this test report refer only to the sample(s) tested and such sample(s) are retained for 90 days only.
除非另有說明，此報告結果僅對測試之樣品負責，同時此樣品僅保留90天。本報告未經本公司書面許可，不可部份複製。

This document is issued by the Company subject to its General Conditions of Service printed overleaf, available on request or accessible at <http://www.sgs.com.tw/Terms-and-Conditions> and, for electronic format documents, subject to Terms and Conditions for Electronic Documents at <http://www.sgs.com.tw/Terms-and-Conditions>. Attention is drawn to the limitation of liability, indemnification and jurisdiction issues defined therein. Any holder of this document is advised that information contained hereon reflects the Company's findings at the time of its intervention only and within the limits of client's instruction, if any. The Company's sole responsibility is to its Client and this document does not exonerate parties to a transaction from exercising all their rights and obligations under the transaction documents. This document cannot be reproduced, except in full, without prior written approval of the Company. Any unauthorized alteration, forgery or falsification of the content or appearance of this document is unlawful and offenders may be prosecuted to the fullest extent of the law.

Revision History

Rev.	Issue Date	Revisions	Effect Page	Revised By
00	April 24, 2020	Initial Issue	ALL	Doris Chu
01	April 28, 2020	See the following Note Rev. (01)	P.4, P.5, P.9, P.19, P.29-30, P.45, P.47	Doris Chu
02	May 11, 2020	See the following Note Rev. (02)	P.18	Angel Cheng
03	June 20, 2020	See the following Note Rev. (03)	P.1, P.4-6	Allison Chen

Rev (01):

1. Remove standard IC.
2. Revised section 2 power supply and Cellular Phone Protocol to Modulation.
3. Revised section 5.2.
4. Revised section 8.2 test data.
5. Revised section 8.4 Test Configuration and test procedure.
6. Revised section 8.5 Test Results
7. Revised section 8.6 Test Results

Rev (02):

1. Modify section 8.2. Test Configuration

Rev (03):

1. Modify IC Model No.: G2-SY-CON2-1002244.



TABLE OF CONTENTS

1. TEST RESULT CERTIFICATION.....	4
2. EUT DESCRIPTION.....	5
3. TEST METHODOLOGY.....	6
3.1 EUT CONFIGURATION	6
3.2 EUT EXERCISE	6
3.3 DESCRIPTION OF TEST MODES	6
3.4 THE WORST MODE OF MEASUREMENT.....	7
4. TEST SUMMERY.....	8
5. INSTRUMENT CALIBRATION.....	9
5.1 MEASURING INSTRUMENT CALIBRATION	9
5.2 MEASUREMENT EQUIPMENT USED	9
5.3 MEASUREMENT UNCERTAINTY	10
6. FACILITIES AND ACCREDITATIONS.....	11
6.1 FACILITIES.....	11
6.2 EQUIPMENT.....	11
7. SETUP OF EQUIPMENT UNDER TEST.....	12
7.1 SETUP CONFIGURATION OF EUT	12
7.2 SUPPORT EQUIPMENT	12
8. INDUSTRY CANADA RSS-132 & RSS-133.....	13
8.1 99% BANDWIDTH	13
8.2 ERP & EIRP MEASUREMENT	18
8.3 OUT OF BAND EMISSION AT ANTENNA TERMINALS	20
8.4 FIELD STRENGTH OF SPURIOUS RADIATION MEASUREMENT	29
8.5 FREQUENCY STABILITY V.S. TEMPERATURE MEASUREMENT	43
8.6 FREQUENCY STABILITY V.S. VOLTAGE MEASUREMENT	46
8.7 PEAK TO AVERAGE RATIO	48
9. APPENDIX -A PHOTOGRAPHS OF TEST SETUP.....	A-1

APPENDIX 1 - PHOTOGRAPHS OF EUT



Report No.: T200319D03-RC

Page: 4 / 52

Rev.: 03

1. TEST RESULT CERTIFICATION

Applicant: Seeing Machines Ltd.
80 Mildura Street Fyshwick ACT 2609 Australia

Manufacturer: ADLINK TECHNOLOGY INC.
9F, No. 166, Jian Yi Rd., Zhonghe Dist., New Taipei City, 235
Taiwan

Equipment Under Test: GUARDIAN SYSTEM LTE

Trade Name: GUARDIAN

Model Number: G2-SY-CON2-1002244

Date of Test: March 24 ~ 31, 2020

APPLICABLE STANDARDS	
STANDARD	TEST RESULT
RSS-132 Issue 3: January, 2013 and RSS-133 Issue 6: January, 2013	No non-compliance noted
Statements of Conformity	
Determination of compliance is based on the results of the compliance measurement, not taking into account measurement instrumentation uncertainty.	

We hereby certify that:

The above equipment was tested by Compliance Certification Services Inc. The test data, data evaluation, test procedures, and equipment configurations shown in this report were made in accordance with the procedures given in TIA/EIA-603-C: 2004 and the energy emitted by the sample EUT tested as described in this report is in compliance with conducted and radiated emission limits of IC RSS-132 Issue 3 and IC RSS-133 Issue 6.

The test results of this report relate only to the tested sample identified in this report.

Approved by:

Kevin Tsai
Deputy Manager
Compliance Certification Services Inc.

2. EUT DESCRIPTION

Product	GUARDIAN SYSTEM LTE
Trade Name	GUARDIAN
Model Number	G2-SY-CON2-1002244
Received Date	March 19, 2020
Power Supply	Powered from DC supply: DC 12V.
Frequency Range	GPRS: 850: 824.2 ~ 848.8 MHz GPRS: 1900: 1850.2 ~ 1909.8 MHz
Transmit Power (ERP & EIRP Power)	GPRS 850: 27.6dBm GPRS 1900: 28.2dBm
Modulation	GPRS: GMSK
Antenna Gain	Dipole Antenna GPRS 850: -0.1dBi GPRS 1900: 1.2dBi
HW Version	V1
SW Version	V9



3. TEST METHODOLOGY

The tests documented in this report were performed in accordance with IC RSS-132, SPSR503, RSS-133, SPSR510 and ANSI C63.10: 2013 and TIA/EIA-603-C.

3.1 EUT CONFIGURATION

The EUT configuration for testing is installed on RF field strength measurement to meet the Commissions requirement and operating in a manner that intends to maximize its emission characteristics in a continuous normal application.

3.2 EUT EXERCISE

The EUT was operated in the engineering mode to fix the TX frequency that was for the purpose of the measurements.

3.3 DESCRIPTION OF TEST MODES

The EUT (model: G2-SY-CON2-1002244) had been tested under operating condition. EUT staying in continuous transmitting mode was programmed.

GPRS 850:

Channel Low (CH128), Channel Mid (CH190) and Channel High (CH251) were chosen for full testing.

GPRS 1900:

Channel Low (CH512), Channel Mid (CH661) and Channel High (CH810) were chosen for full testing.

below except radiated spurious emission below 1GHz and power line conducted emissions below 30MHz, which worst case was in normal link mode only.

3.4 THE WORST MODE OF MEASUREMENT

Radiated Emission Measurement Above 1G	
Test Condition	Radiated Emission Above 1G
Power supply Mode	Mode 1: EUT power by Power supply
Worst Mode	<input checked="" type="checkbox"/> Mode 1 <input type="checkbox"/> Mode 2 <input type="checkbox"/> Mode 3 <input type="checkbox"/> Mode 4
Worst Position	<input type="checkbox"/> Placed in fixed position. <input checked="" type="checkbox"/> Placed in fixed position at X-Plane (E2-Plane) <input type="checkbox"/> Placed in fixed position at Y-Plane (E1-Plane) <input type="checkbox"/> Placed in fixed position at Z-Plane (H-Plane)

Radiated Emission Measurement Below 1G	
Test Condition	Radiated Emission Below 1G
Power supply Mode	Mode 1: EUT power by Power supply
Worst Mode	<input checked="" type="checkbox"/> Mode 1 <input type="checkbox"/> Mode 2 <input type="checkbox"/> Mode 3 <input type="checkbox"/> Mode 4

Remark:

1. The worst mode was record in this test report.
2. EUT pre-scanned in three axis ,X,Y, Z and two polarity, for radiated measurement. The worst case(X-Plane) were recorded in this report



Report No.: T200319D03-RC

Page: 8 / 52

Rev.: 03

4. TEST SUMMERY

IC Standard Section	Report Section	Test Item	Result
-	2	Antenna Requirement	Pass
RSS-GEN 6.7	8.1	99% Bandwidth	Pass
RSS-132, section 5.4 RSS-133, section 6.4	8.2	ERP and EIRP Measurement	Pass
RSS-132 section 5.5 RSS-133 section 6.5	8.3	Out of Band Emission At Antenna Terminals	Pass
RSS-132 section 5.3 RSS-133 section 6.3	8.4	Field Strength of Spurious Radiation Measurement	Pass
RSS-132 section 5.3 RSS-133 section 6.3	8.5	Frequency Stability V.S. Temperature Measurement	Pass
RSS-132 section 5.3 RSS-133 section 6.3	8.6	Frequency Stability V.S. Voltage Measurement	Pass
RSS-132, section 5.4 RSS-133, section 6.4	8.7	Peak to Average Ratio	Pass

5. INSTRUMENT CALIBRATION

5.1 MEASURING INSTRUMENT CALIBRATION

The measuring equipment, which was utilized in performing the tests documented herein, has been calibrated in accordance with the manufacturer's recommendations for utilizing calibration equipment, which is traceable to recognized national standards.

5.2 MEASUREMENT EQUIPMENT USED

Equipment Used for Emissions Measurement

Remark: Each piece of equipment is scheduled for calibration once a year and Loop Antenna is scheduled for calibration once three years.

Wugu fully Chamber					
Name of Equipment	Manufacturer	Model	Serial Number	Calibration Date	Calibration Due
Band Reject Filters	MICRO TRONICS	BRM 50702	120	02/25/2020	02/24/2021
Bilog Antenna	Sunol Sciences	JB3	A030105	07/26/2019	07/25/2020
Coaxial Cable	HUBER SUHNER	SUCOFLEX 104PEA	20995	02/25/2020	02/24/2021
Coaxial Cable	EMCI	EMC105	190914+25111	09/20/2019	09/19/2020
Digital Thermo-Hygro Meter	WISEWIND	1206	D07	01/15/2020	01/14/2021
double Ridged Guide Horn Antenna	ETC	MCTD 1209	DRH13M02003	10/04/2019	10/03/2020
Loop Ant	COM-POWER	AL-130	121051	03/27/2020	03/26/2021
Pre-Amplifier	EMEC	EM330	060609	02/25/2020	02/24/2021
Pre-Amplifier	HP	8449B	3008A00965	02/25/2020	02/24/2021
PSA Series Spectrum Analyzer	Agilent	E4446A	MY46180323	05/29/2019	05/28/2020
Antenna Tower	CCS	CC-A-1F	N/A	N.C.R	N.C.R
Controller	CCS	CC-C-1F	N/A	N.C.R	N.C.R
Turn Table	CCS	CC-T-1F	N/A	N.C.R	N.C.R
Digital Radio Communication Tester	R&S	CMU200	116604	07/15/2019	07/14/2020
Software	e3 6.11-20180413				

Conducted Emissions Test Site					
Name of Equipment	Manufacturer	Model	Serial Number	Calibration Date	Calibration Due
Coaxial Cable	Woken	WC12	CC003	06/28/2019	06/27/2020
Digital Radio Communication Tester	R&S	CMU200	116604	07/15/2019	07/14/2020
Power Divider	Solvang Technology	STI08-0015	008	08/06/2019	08/05/2020
Signal Analyzer	R&S	FSV 40	101073	09/25/2019	09/24/2020
DC Power Supplies	GW Instek	SPS-3610	GPE880163	01/10/2020	01/09/2021
Software	N/A				

Remark: Each piece of equipment is scheduled for calibration once a year.



Report No.: T200319D03-RC

Page: 10 / 52

Rev.: 03

5.3 MEASUREMENT UNCERTAINTY

PARAMETER	UNCERTAINTY
3M Semi Anechoic Chamber / 30M~200M	+/- 4.12
3M Semi Anechoic Chamber / 200M~1000M	+/- 4.68
3M Semi Anechoic Chamber / 1G~8G	+/- 5.18
3M Semi Anechoic Chamber / 8G~18G	+/- 5.47
3M Semi Anechoic Chamber / 18G~26G	+/- 3.81
3M Semi Anechoic Chamber / 26G~40G	+/- 3.87

Remark: This uncertainty represents an expanded uncertainty expressed at approximately the 95% confidence level using a coverage factor of $k=2$.



Report No.: T200319D03-RC

Page: 11 / 52

Rev.: 03

6. FACILITIES AND ACCREDITATIONS

6.1 FACILITIES

No.199, Chunghsen Road, Hsintien City, Taipei Hsien, Taiwan, R.O.C.

Tel: 886-2-2217-0894 / Fax: 886-2-2217-1029

No.11, Wugong 6th Rd., Wugu Dist., New Taipei City, Taiwan. (R.O.C.)

Tel: 886-2-2299-9720 / Fax: 886-2-2298-4045

The sites are constructed in conformance with the requirements of ANSI C63.7, ANSI C63.10:2013 and CISPR Publication 22.

6.2 EQUIPMENT

Radiated emissions are measured with one or more of the following types of linearly polarized antennas: tuned dipole, biconical, log periodic, bi-log, and/or ridged waveguide, horn. Spectrum analyzers with pre-selectors and quasi-peak detectors are used to perform radiated measurements.

Conducted emissions are measured with Line Impedance Stabilization Networks and EMI Test Receivers.

Calibrated wideband preamplifiers, coaxial cables, and coaxial attenuators are also used for making measurements.

All receiving equipment conforms to CISPR Publication 16-1, "Radio Interference Measuring Apparatus and Measurement Methods."



7. SETUP OF EQUIPMENT UNDER TEST

7.1 SETUP CONFIGURATION OF EUT

See test photographs attached in Appendix I for the actual connections between EUT and support equipment.

7.2 SUPPORT EQUIPMENT

No.	Device Type	Brand	Model	FCC ID	Series No.	Cable length & Type Discribe
1	DC Power Source	Agilent	E3640A	N/A	N/A	DC Cable 1.5m shielding

Remark:

1. *All the equipment/cables were placed in the worst-case configuration to maximize the emission during the test.*
2. *Grounding was established in accordance with the manufacturer's requirements and conditions for the intended use.*

8. INDUSTRY CANADA RSS-132 & RSS-133

8.1 99% BANDWIDTH

LIMIT

None; for reporting purposes only.

Test Configuration

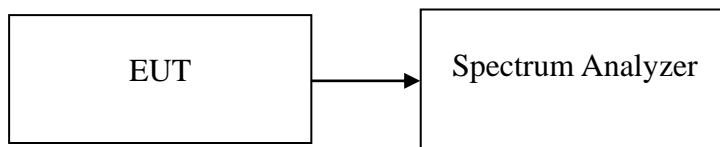

TEST PROCEDURE

The transmitter output is connected to the spectrum analyzer. The RBW is set to 1% to 3% of the 99 % bandwidth. The VBW is set to 3 times the RBW. The sweep time is coupled.

TEST RESULTS

No non-compliance noted.

Test Data

Test Mode	CH	Frequency (MHz)	99% Bandwidth (kHz)
GPRS 850	128	824.1812	243.1259
	190	836.5797	243.1259
	251	848.7797	243.1259

Test Mode	CH	Frequency (MHz)	99% Bandwidth (kHz)
GPRS 1900	512	1.8502	244.5731
	661	1.8800	244.5731
	810	1.9098	244.5731

Test Plot GPRS 850 (CH Low)

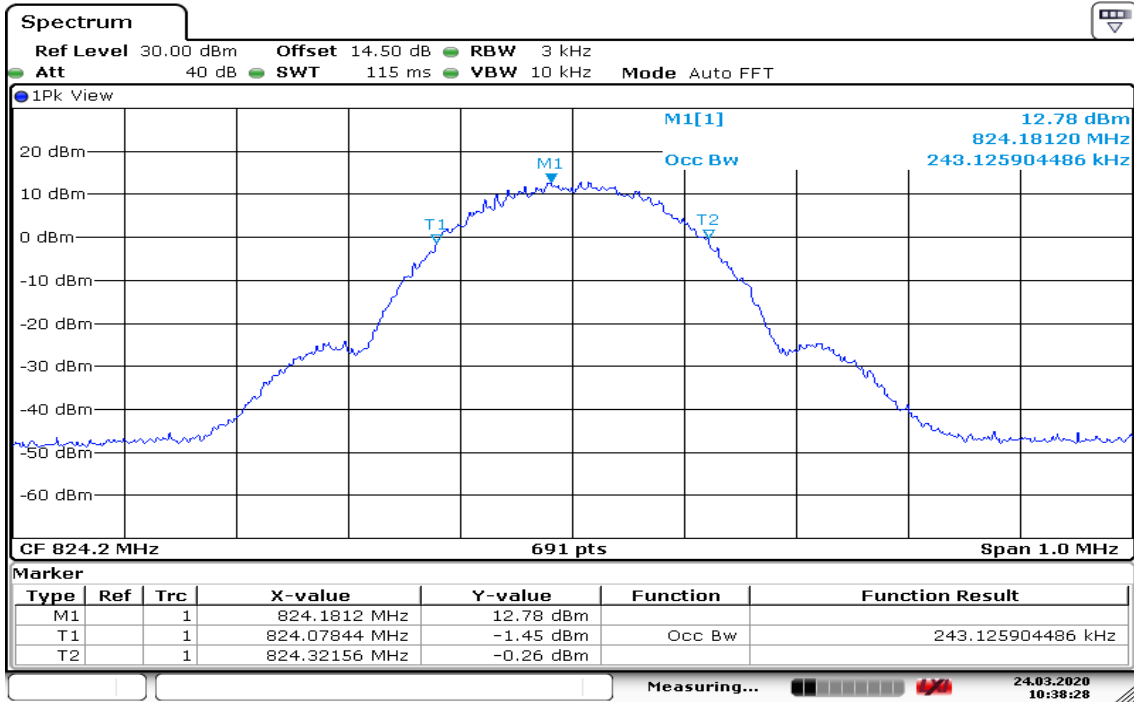

Date: 24.MAR.2020 10:38:28

GPRS 850 (CH Mid)

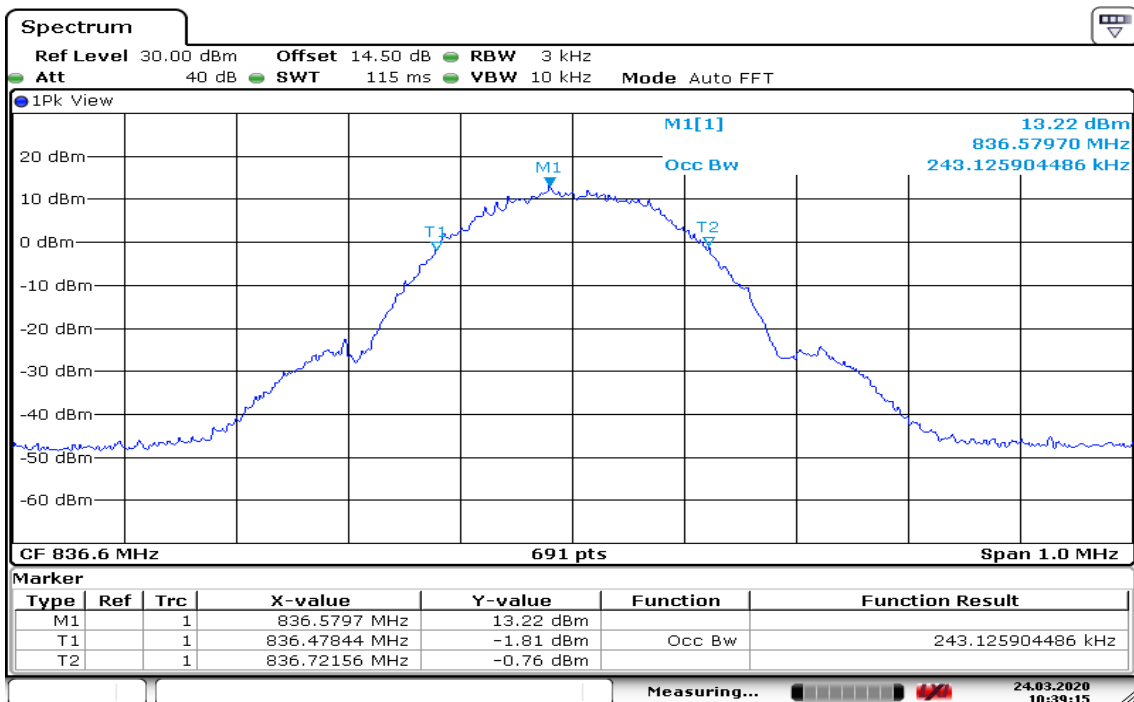

Date: 24.MAR.2020 10:39:15

GPRS 850(CH High)

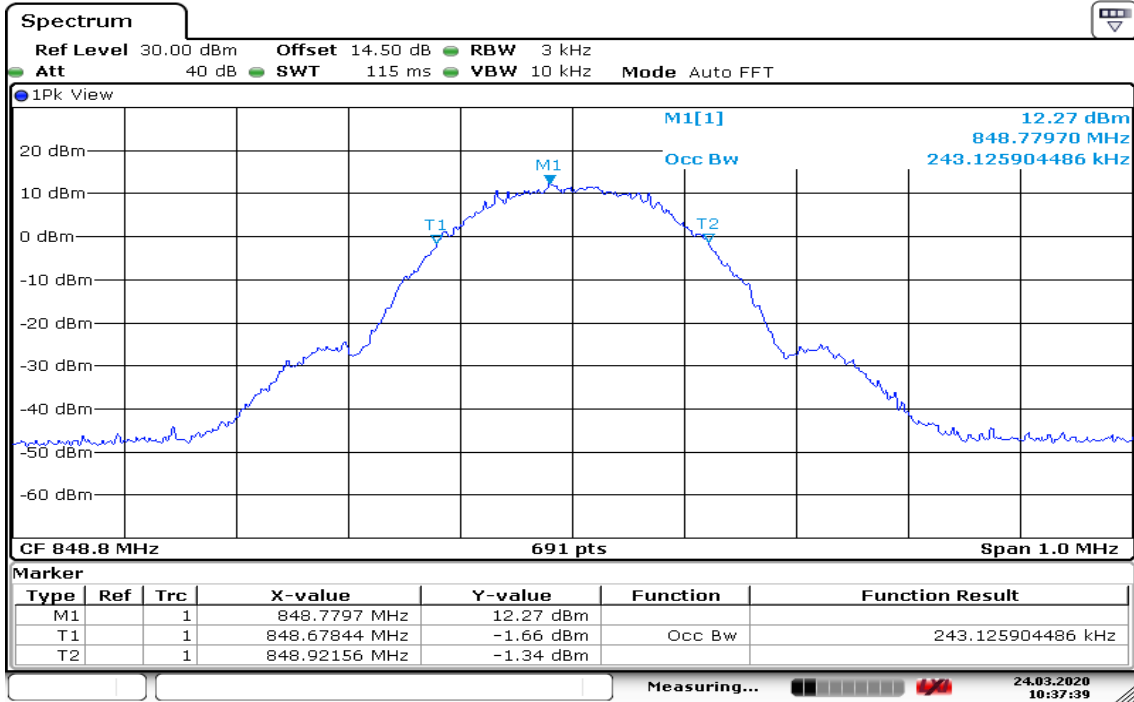

Date: 24.MAR.2020 10:37:39

Report No.: T200319D03-RC

GPRS 1900 (CH Low)

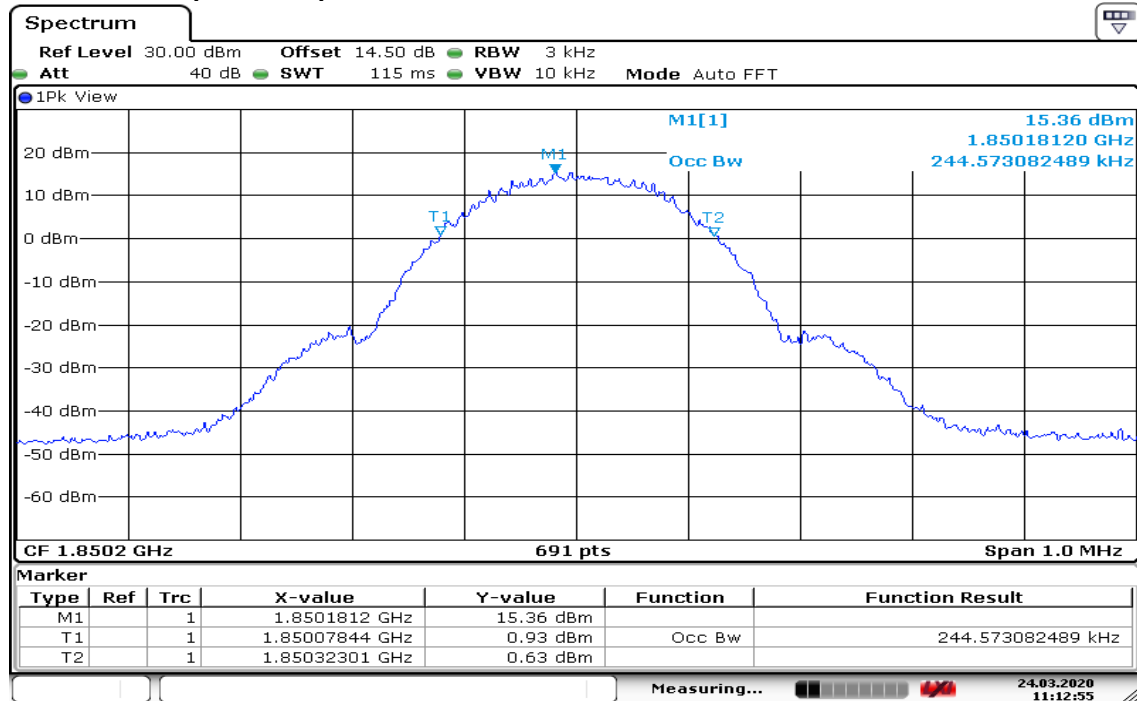

Date: 24.MAR.2020 11:12:55

GPRS 1900 (CH Mid)

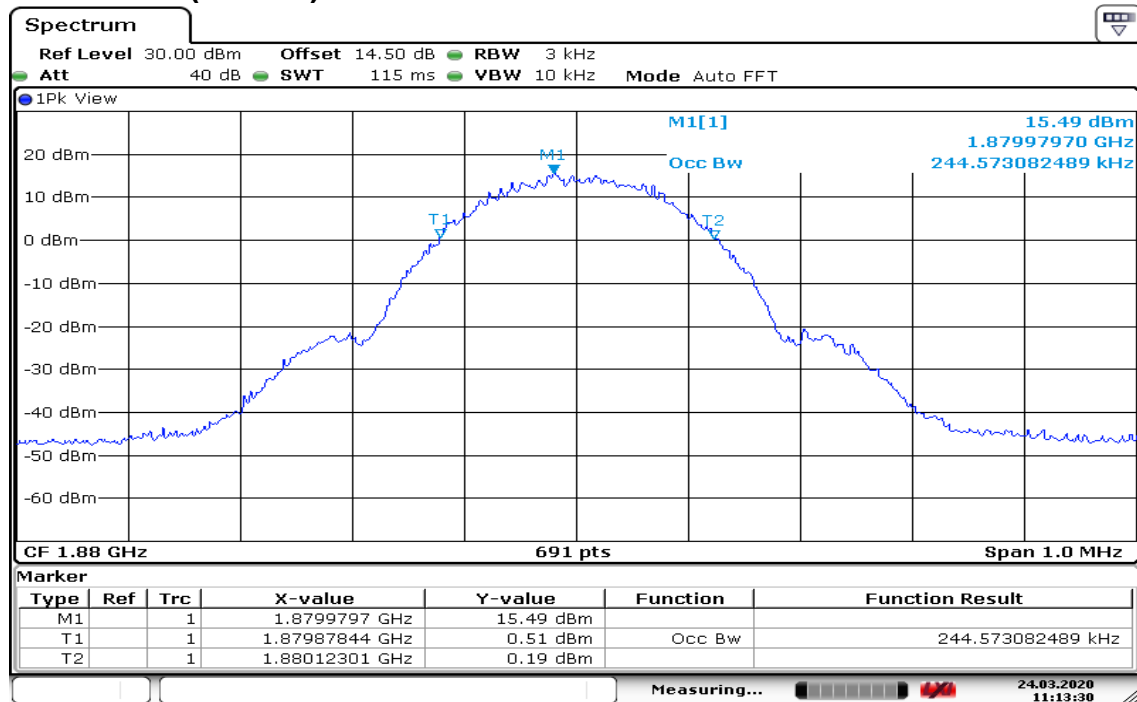

Date: 24.MAR.2020 11:13:30

GPRS 1900 (CH High)

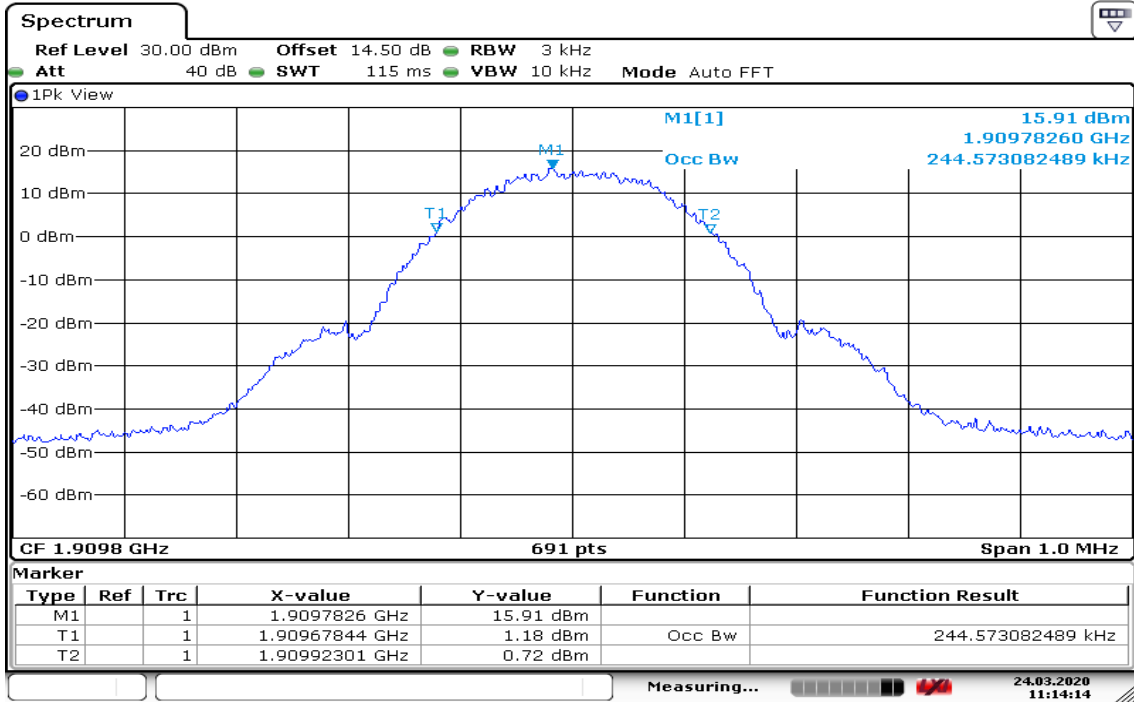

Date: 24.MAR.2020 11:14:14

8.2 ERP & EIRP MEASUREMENT

LIMIT

RSS-132, section 5.4

The transmitter output power shall be measured in terms of average power. The equivalent isotropically radiated power (e.i.r.p.) for mobile equipment shall not exceed 11.5 watts. Refer to SRSP-503 for base station e.i.r.p. limits.

RSS-133, section 6.4

The equivalent isotropically radiated power (e.i.r.p.) for transmitters shall not exceed the limits given in SRSP-510. Moreover, base station transmitters operating in the band 1930-1995 MHz shall not have output power exceeding 100 watts.

Test Configuration



Remark: Measurement setup for testing on Antenna connector

TEST PROCEDURE

The transmitter output was connected to a calibrated attenuator, the other end of which was connected to a power meter. Transmitter output was read off the power meter in dBm. The power output at the transmitter antenna port was determined by adding the value of the attenuator to the power meter reading.

ERP = S.G. output (dBm) + Antenna Gain (dBi) – Cable (dB)-2.15

EIRP = S.G. output (dBm) + Antenna Gain (dBi) – Cable (dB)

TEST RESULTS

No non-compliance noted.

Test Data

Test Mode	CH	Frequency (MHz)	Output Power (dBm)	Output Power (W)	EIRP (dBm)	Output Power (W)
GPRS 850	128	824.2	29.8	0.955	*27.6	0.569
	190	836.6	29.5	0.891	27.3	0.531
	251	848.8	29.0	0.794	26.8	0.473

Test Mode	CH	Frequency (MHz)	Output Power (dBm)	Output Power (W)	EIRP (dBm)	Output Power (W)
GPRS 1900	512	1850.2	26.4	0.437	27.6	0.575
	661	1880.0	26.5	0.447	27.7	0.589
	810	1909.8	27.0	0.501	*28.2	0.661

Remark: The value of factor includes both the loss of cable and external attenuator

8.3 OUT OF BAND EMISSION AT ANTENNA TERMINALS

LIMIT

According to RSS-132 section 5.5, RSS-133 section 6.5

Out of Band Emissions: The mean power of emission must be attenuated below the mean power of the non-modulated carrier (P) on any frequency twice or more than twice the fundamental frequency by at least $43 + 10 \log P$ dB.

Mobile Emissions in Base Frequency Range: The mean power of any emissions appearing in the base station frequency range from cellular mobile transmitters operated must be attenuated to a level not exceed -80 dBm at the transmit antenna connector.

Band Edge Requirements: In the 1MHz bands immediately outside and adjacent to the frequency block, a resolution bandwidth of at least 1% of the emission bandwidth of the fundamental emission of the transmitter may be employed to measure the Out of band Emission

Test Configuration

Out of band emission at antenna terminals:

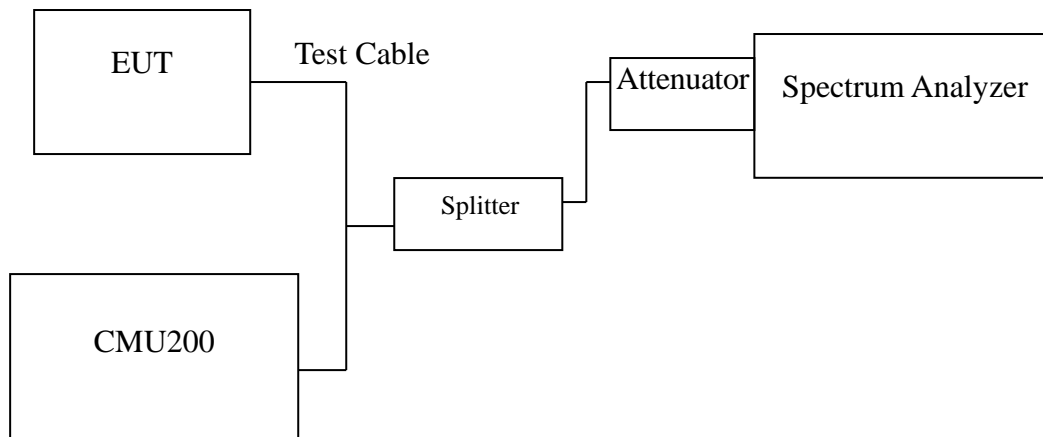



Report No.: T200319D03-RC

Page: 21 / 52

Rev.: 03

TEST PROCEDURE

The RF output of the transceiver was connected to a spectrum analyzer through appropriate attenuation. The resolution bandwidth of the spectrum analyzer was set at 1MHz, sufficient scans were taken to show the out of band Emissions if any up to 10th harmonic.

For the out of band: Set the RBW, VBW = 1MHz, Start=30MHz, Stop= 10 th harmonic. Limit = -13dBm

Band Edge Requirements (824 MHz and 849 MHz /1850MHz and 1910MHz): In the 1 MHz bands immediately outside and adjacent to the frequency block, a resolution bandwidth of at least 1 percent of the emission bandwidth of the fundamental emission of the transmitter may be employed to measure the out of band Emissions. Limit, -13dBm.

TEST RESULTS

No non-compliance noted.

Test Data

Mode	CH	Location	Description
GPRS 850	128	Figure 8-1	Conducted spurious emissions, 30MHz - 20GHz
	190	Figure 8-2	Conducted spurious emissions, 30MHz - 20GHz
	251	Figure 8-3	Conducted spurious emissions, 30MHz - 20GHz

Mode	CH	Location	Description
GPRS 1900	512	Figure 9-1	Conducted spurious emissions, 30MHz - 20GHz
	661	Figure 9-2	Conducted spurious emissions, 30MHz - 20GHz
	810	Figure 9-3	Conducted spurious emissions, 30MHz - 20GHz

Mode	CH	Location	Description
GPRS 850	128	Figure 10-1	Band Edge emissions
	251	Figure 10-2	Band Edge emissions

Mode	CH	Location	Description
GPRS 1900	512	Figure 11-1	Band Edge emissions
	810	Figure 11-2	Band Edge emissions

Test Plot GPRS 850

Figure 8-1: Out of Band emission at antenna terminals – GPRS CH Low

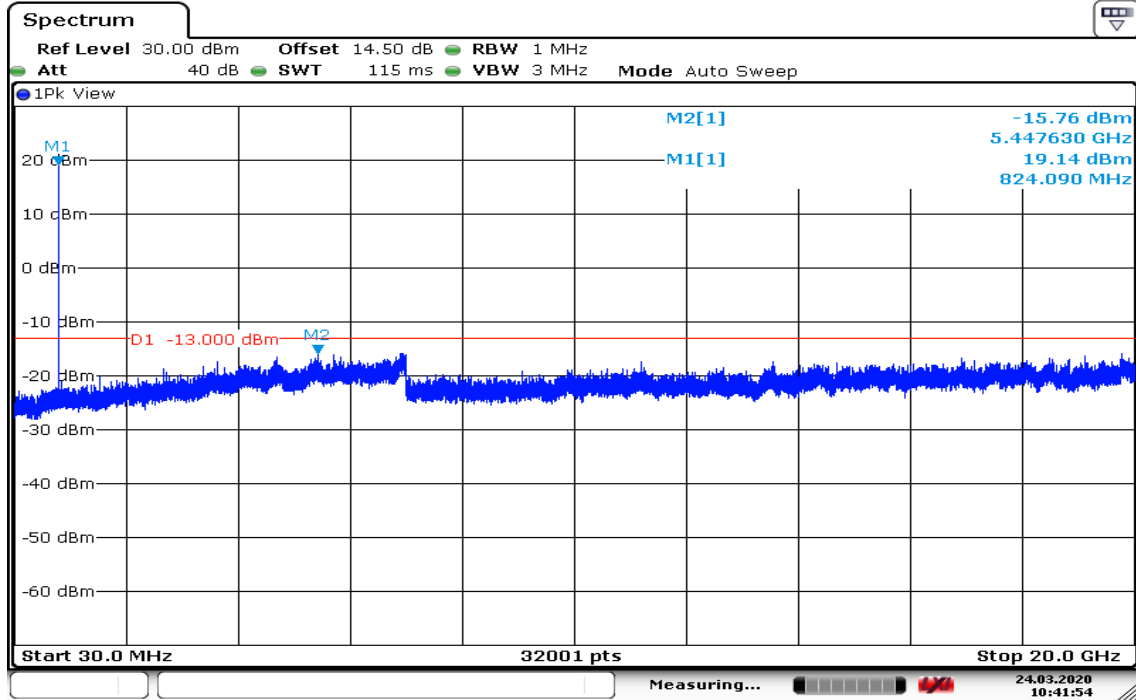

Date: 24.MAR.2020 10:41:54

Figure 8-2: Out of Band emission at antenna terminals – GPRS CH Mid

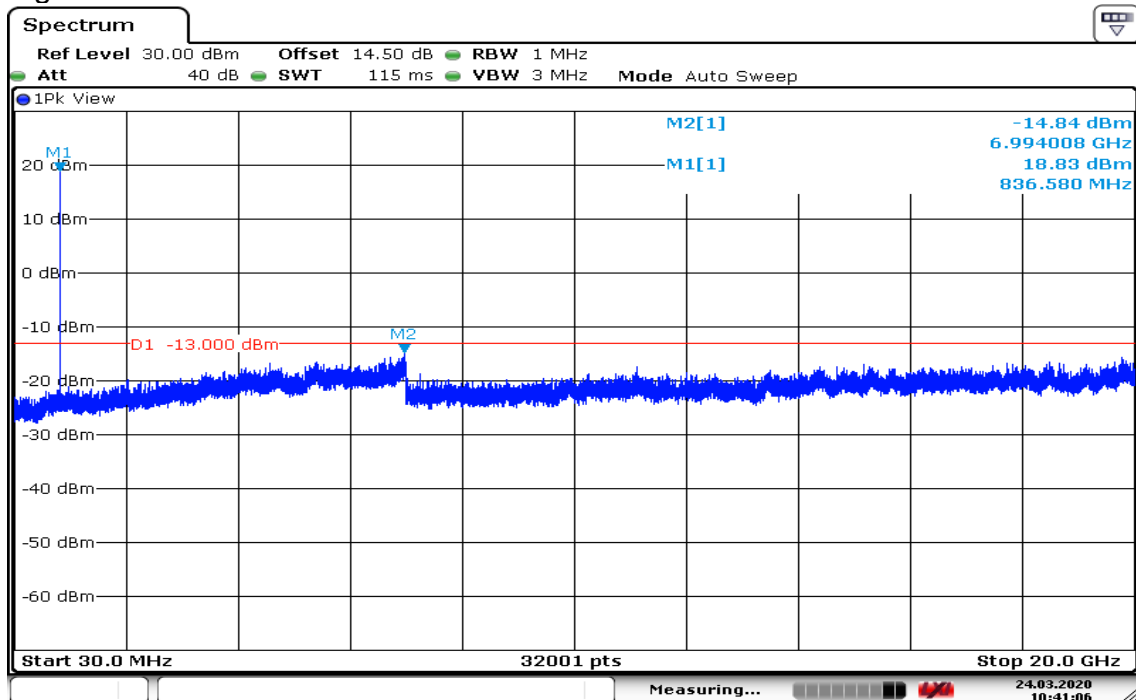

Date: 24.MAR.2020 10:41:06

Figure 8-3: Out of Band emission at antenna terminals – GPRS CH High

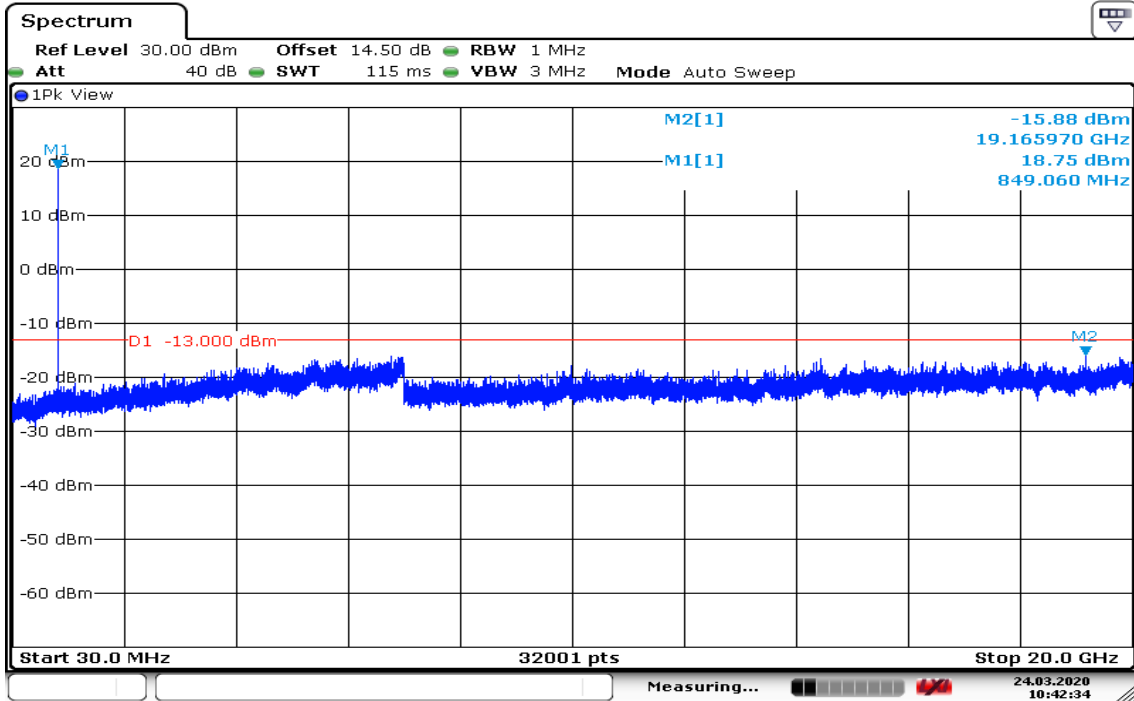

Date: 24.MAR.2020 10:42:34

GPRS 1900

Figure 9-1: Out of Band emission at antenna terminals – GPRS CH Low

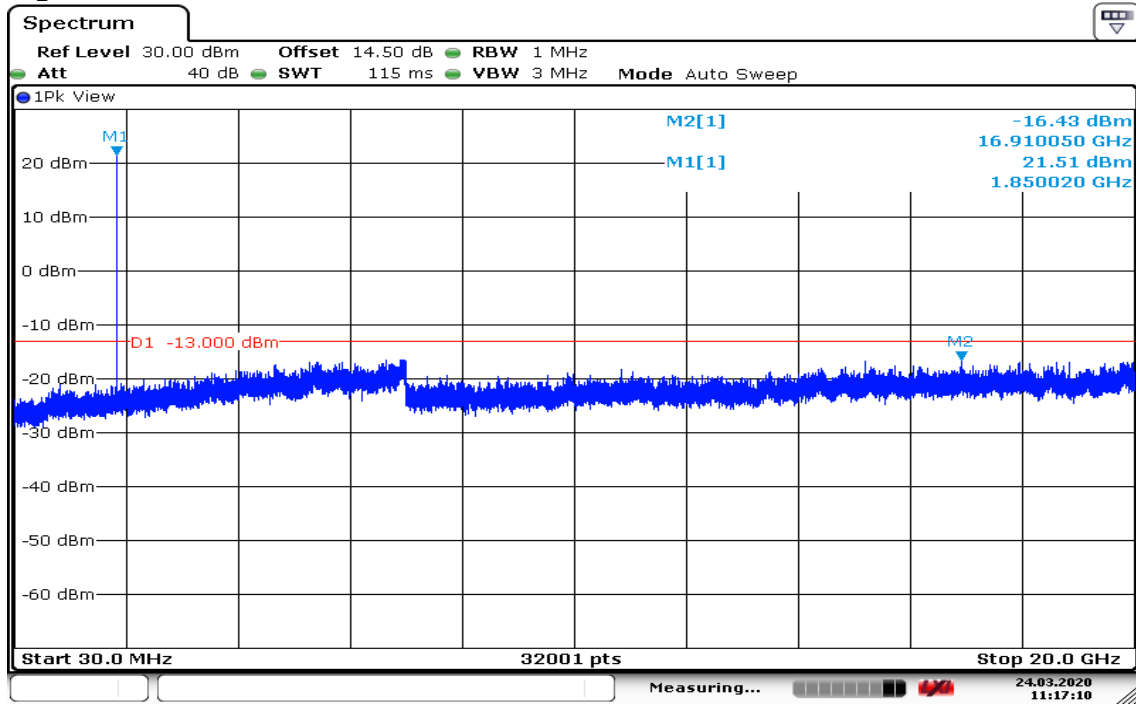

Date: 24.MAR.2020 11:17:10

Figure 9-2: Out of Band emission at antenna terminals – GPRS CH Mid

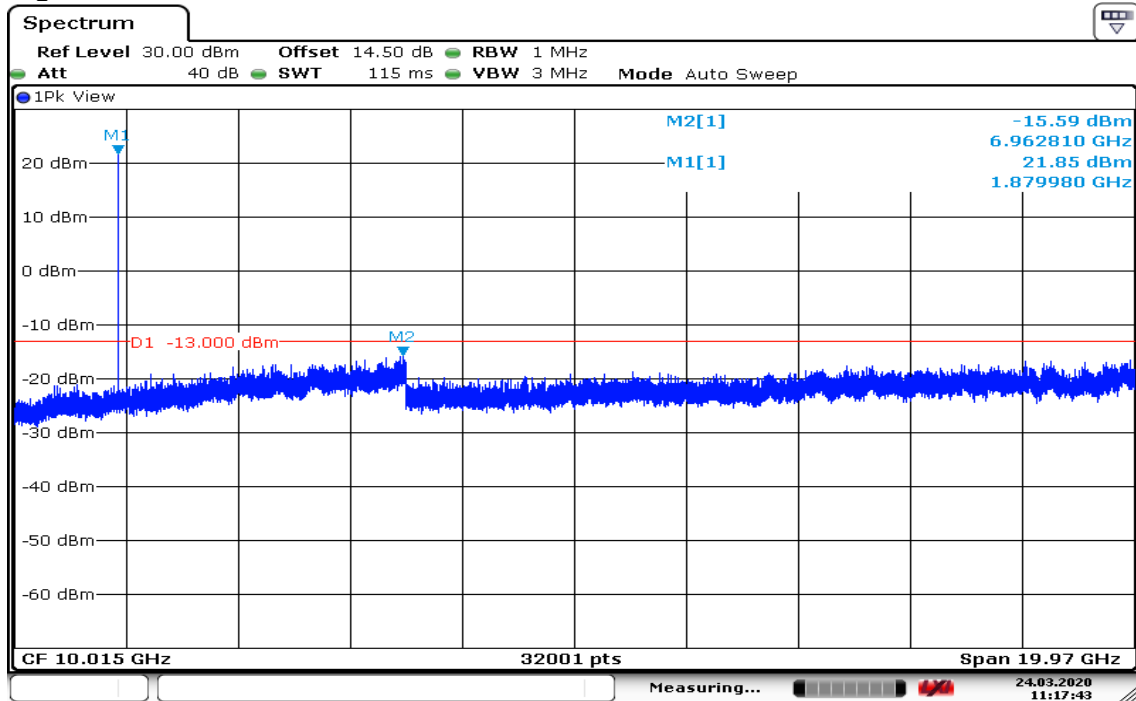

Date: 24.MAR.2020 11:17:43

Figure 9-3: Out of Band emission at antenna terminals – GPRS CH High

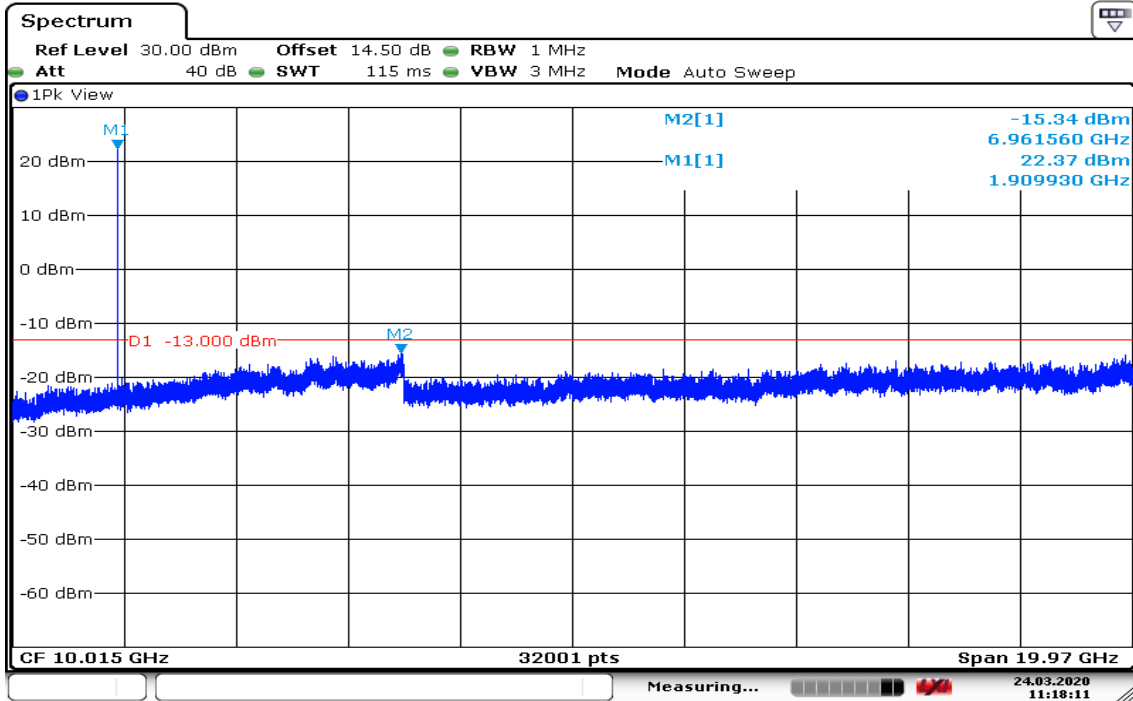

Date: 24.MAR.2020 11:18:11

GPRS 850

Figure 10-1: Band Edge emissions – GPRS CH Low

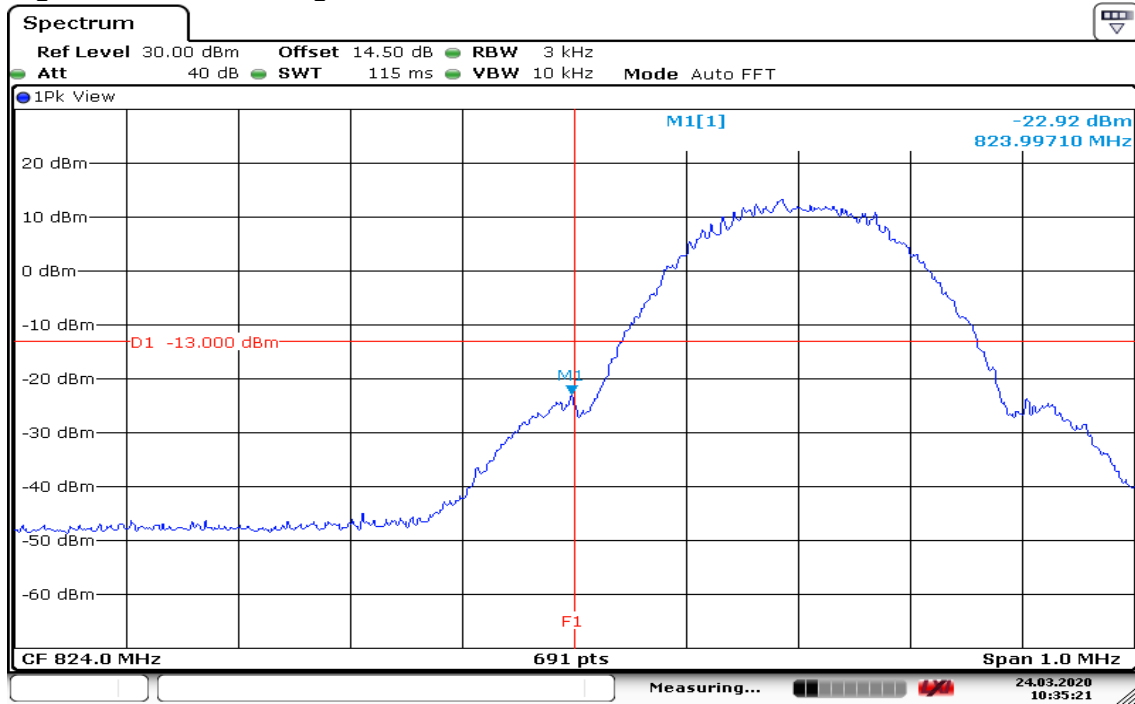

Date: 24.MAR.2020 10:35:20

Figure 10-2: Band Edge emissions –GPRS CH High

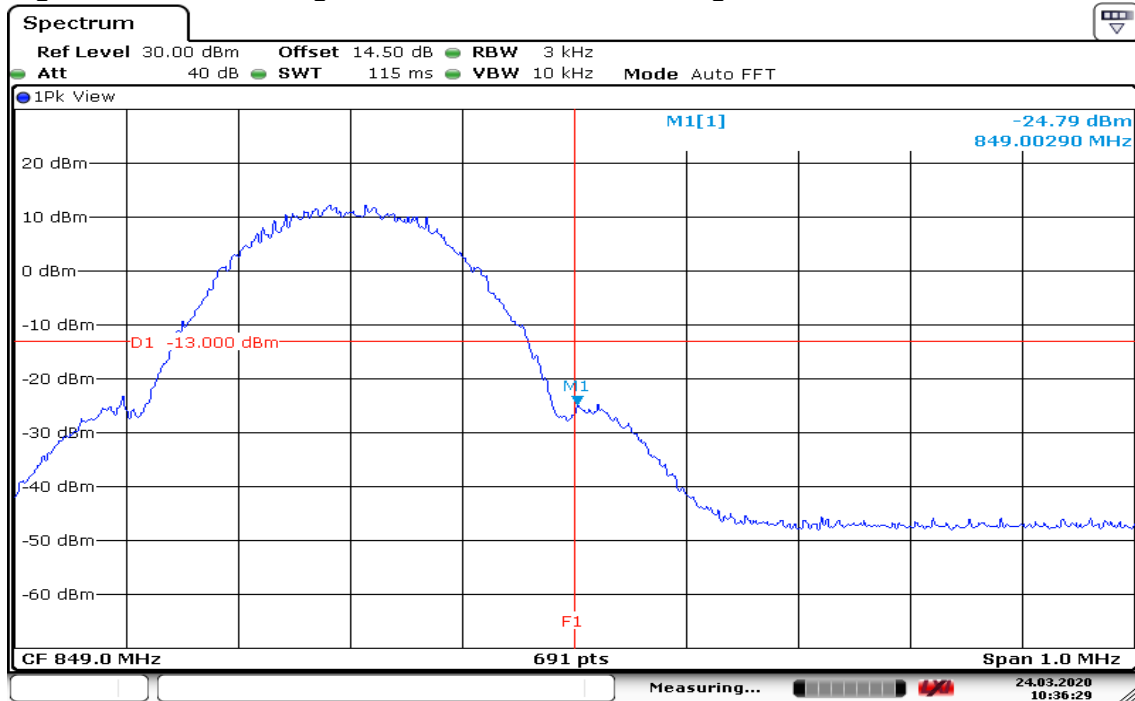

Date: 24.MAR.2020 10:36:29

GPRS 1900

Figure 11-1: Band Edge emissions – GPRS CH Low

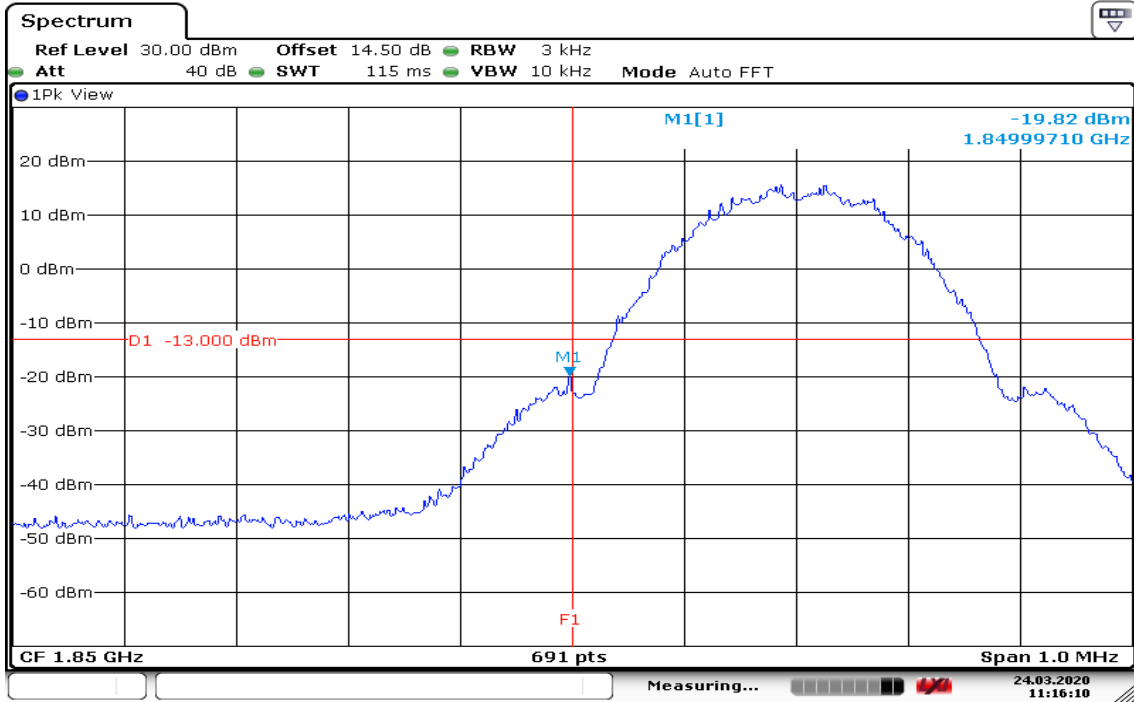

Date: 24.MAR.2020 11:16:10

Figure 11-2: Band Edge emissions – GPRS CH High

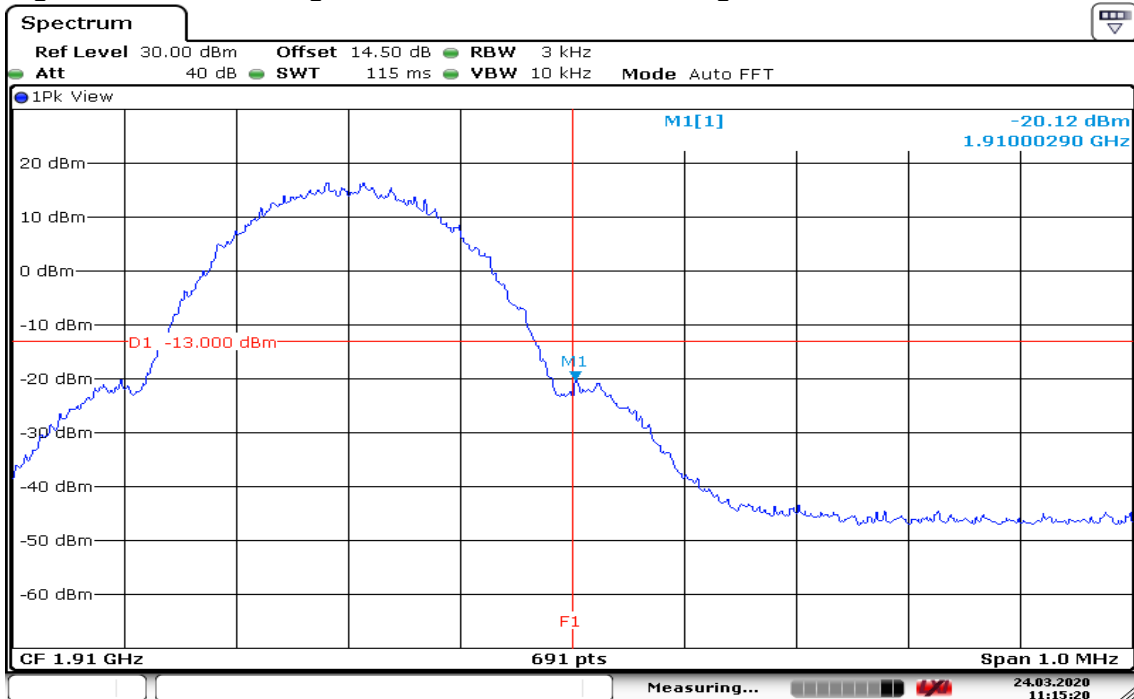

Date: 24.MAR.2020 11:15:20

8.4 FIELD STRENGTH OF SPURIOUS RADIATION MEASUREMENT

LIMIT

According to RSS-132 section 5.3, RSS-133 section 6.3

Test Configuration

Below 1 GHz

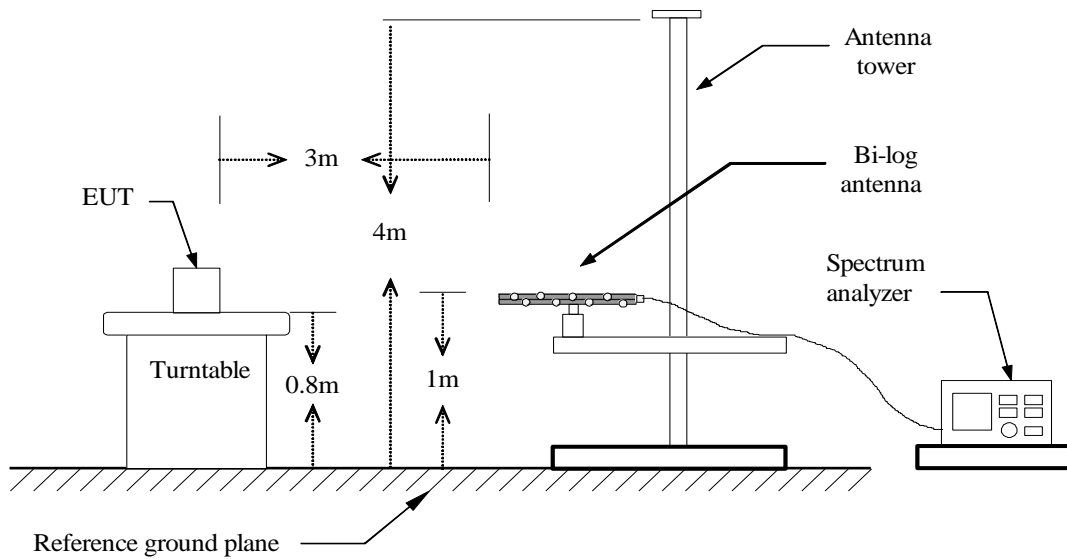

Above 1 GHz

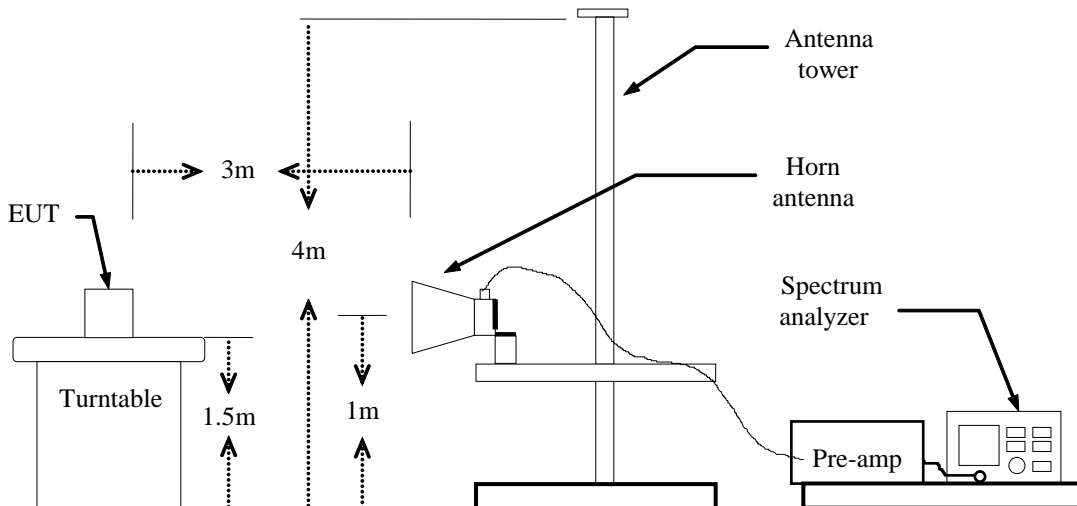

Report No.: T200319D03-RC

Substituted Method Test Set-up

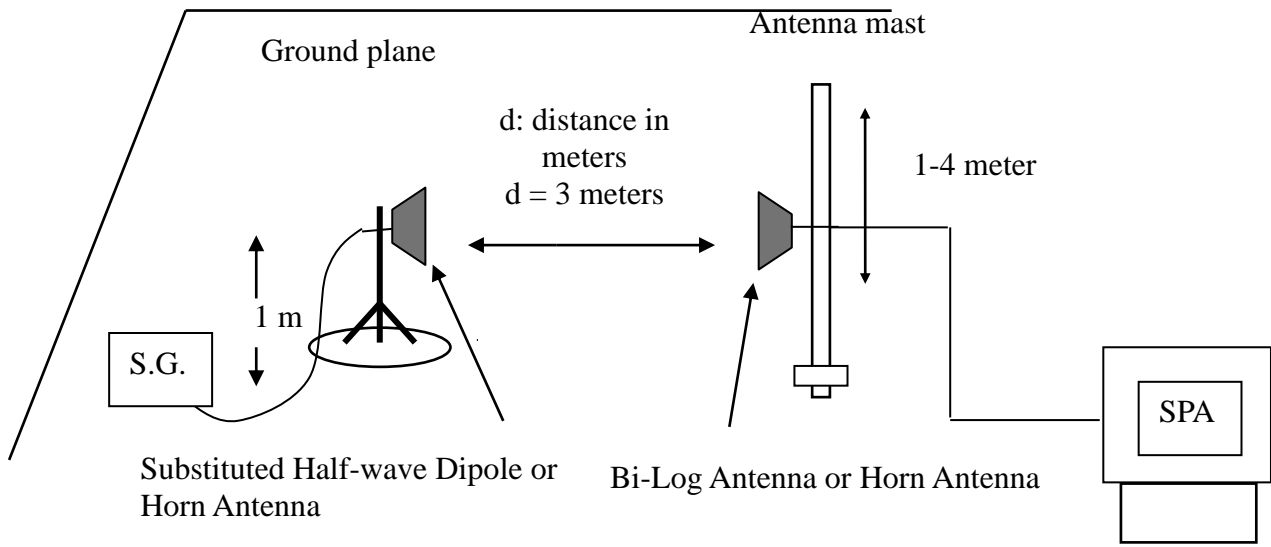

TEST PROCEDURE

1. According to KDB 971168 D01 Power Meas License Digital Systems.. Section 5.8 and TIA-603-E Section 2.2.12.
2. The EUT was placed on a turntable
 - (1) Below 1G : 0.8m
 - (2) Above 1G : 1.5m
 - (3) EUT set 3m from the receiving antenna
 - (4) The table was rotated 360 degrees of the highest spurious emission to determine the position.
3. Set the spectrum analyzer , RBW=1MHz, VBW=3MHz.
4. A horn antenna was driven by a signal generator.
5. Tune the output power of signal generator to the same emission level with EUT maximum spurious emission

$$ERP = \text{S.G. output (dBm)} + \text{Antenna Gain (dBi)} - \text{Cable (dB)} - 2.15$$

$$EIRP = \text{S.G. output (dBm)} + \text{Antenna Gain (dBi)} - \text{Cable (dB)}$$

TEST RESULTS

Refer to the attached tabular data sheets.

Report No.: T200319D03-RC

Radiated Spurious Emission Measurement Result / Below 1GHz

Operation Mode: GPRS 850 / Low CH **Test Date:** March 31, 2020
Temperature: 18.6°C **Tested by:** Jerry Chang
Humidity: 59 % RH **Polarity:** Ver.

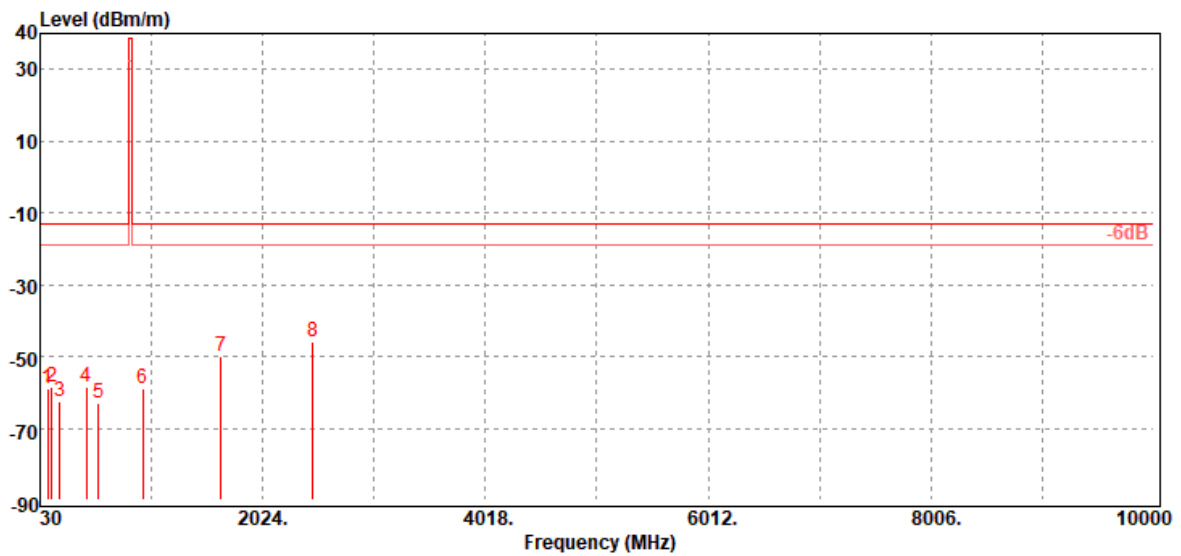

Frequency (MHz)	ERP/EIRP. (dBm)	SG Output Level (dBm)	Ant.Gain (dBi)	Cable Loss (dBm)	Limit (dBm)	Margin (dB)	Antenna Polarization (V/H)
97.90	-59.08	-50.38	-7.89	-0.81	-13.00	-46.08	V
134.76	-58.32	-48.02	-9.35	-0.95	-13.00	-45.32	V
209.45	-62.60	-59.23	-2.18	-1.19	-13.00	-49.60	V
444.19	-58.50	-54.65	-2.10	-1.75	-13.00	-45.50	V
553.80	-63.19	-59.95	-1.28	-1.96	-13.00	-50.19	V
951.50	-58.99	-55.17	-1.20	-2.62	-13.00	-45.99	V
1648.80	-50.09	-56.24	9.70	-3.55	-13.00	-37.09	V
2473.20	-46.10	-52.25	10.69	-4.54	-13.00	-33.10	V

Remark:

1. Measuring frequencies from 1 GHz to the 10th harmonic of highest fundamental frequency.

Report No.: T200319D03-RC

Operation Mode: GPRS 850 / Low CH **Test Date:** March 31, 2020
Temperature: 18.6°C **Tested by:** Jerry Chang
Humidity: 59 % RH **Polarity:** Hor.

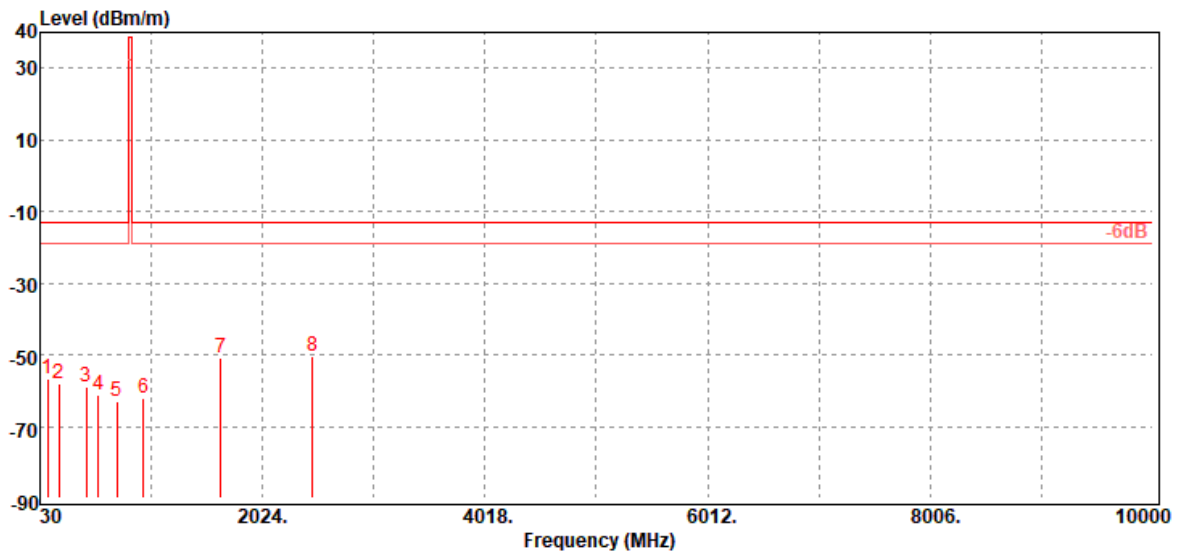

Frequency (MHz)	ERP/EIRP. (dBm)	SG Output Level (dBm)	Ant.Gain (dBi)	Cable Loss (dBm)	Limit (dBm)	Margin (dB)	Antenna Polarization (V/H)
95.96	-56.88	-48.68	-7.40	-0.80	-13.00	-43.88	H
202.66	-58.20	-53.29	-3.74	-1.17	-13.00	-45.20	H
444.19	-58.93	-55.08	-2.10	-1.75	-13.00	-45.93	H
555.74	-61.31	-58.04	-1.31	-1.96	-13.00	-48.31	H
721.61	-62.94	-59.28	-1.40	-2.26	-13.00	-49.94	H
953.44	-61.99	-58.17	-1.20	-2.62	-13.00	-48.99	H
1648.80	-50.90	-57.05	9.70	-3.55	-13.00	-37.90	H
2473.20	-50.43	-56.58	10.69	-4.54	-13.00	-37.43	H

Remark:

1. Measuring frequencies from 1 GHz to the 10th harmonic of highest fundamental frequency.

Report No.: T200319D03-RC

Operation Mode: GPRS 850 / Mid CH **Test Date:** March 31, 2020
Temperature: 18.6°C **Tested by:** Jerry Chang
Humidity: 59 % RH **Polarity:** Ver.

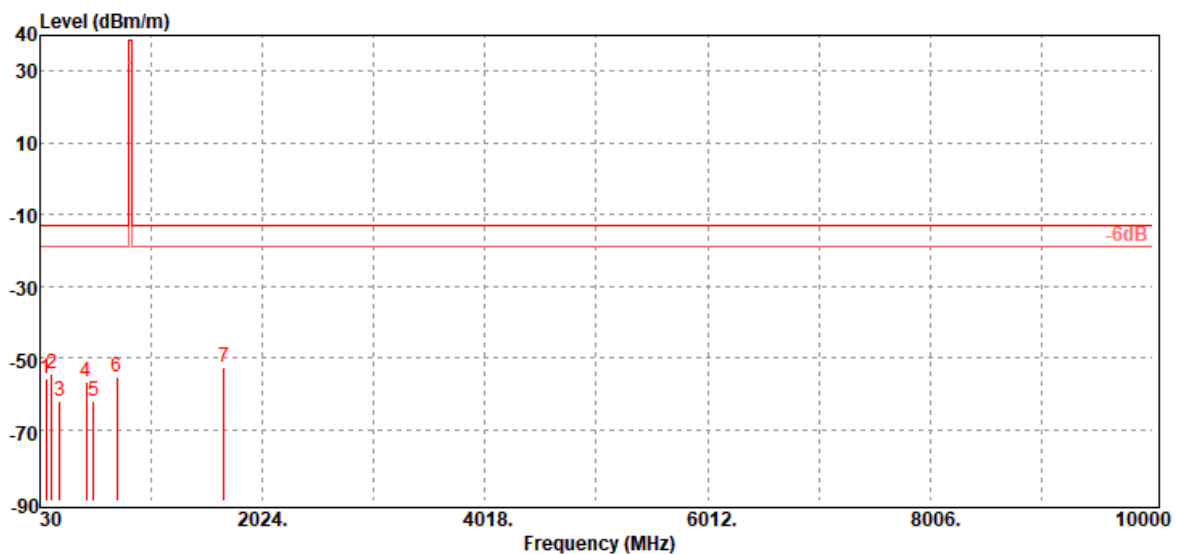

Frequency (MHz)	ERP/EIRP. (dBm)	SG Output Level (dBm)	Ant.Gain (dBi)	Cable Loss (dBm)	Limit (dBm)	Margin (dB)	Antenna Polarization (V/H)
86.26	-55.80	-47.49	-7.55	-0.76	-13.00	-42.80	V
134.76	-54.33	-44.03	-9.35	-0.95	-13.00	-41.33	V
204.60	-62.33	-58.19	-2.96	-1.18	-13.00	-49.33	V
445.16	-56.61	-52.76	-2.10	-1.75	-13.00	-43.61	V
513.06	-62.31	-58.83	-1.58	-1.90	-13.00	-49.31	V
715.79	-55.15	-51.5	-1.40	-2.25	-13.00	-42.15	V
1679.00	-52.76	-59.04	9.87	-3.59	-13.00	-39.76	V

Remark:

1. Measuring frequencies from 1 GHz to the 10th harmonic of highest fundamental frequency.

Report No.: T200319D03-RC

Operation Mode: GPRS 850 / Mid CH **Test Date:** March 31, 2020
Temperature: 18.6°C **Tested by:** Jerry Chang
Humidity: 59 % RH **Polarity:** Hor.

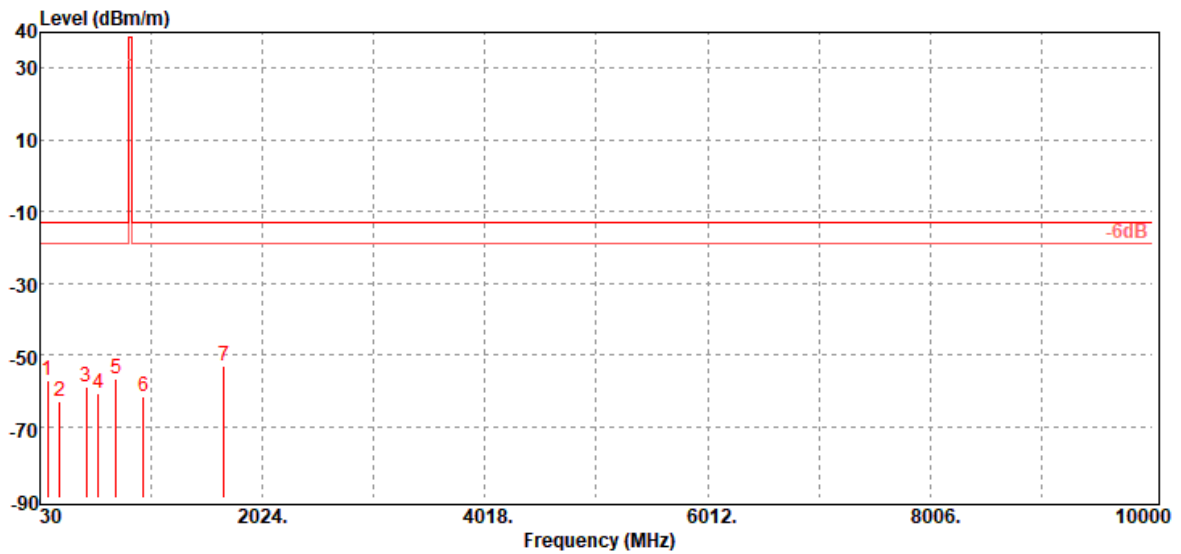

Frequency (MHz)	ERP/EIRP. (dBm)	SG Output Level (dBm)	Ant.Gain (dBi)	Cable Loss (dBm)	Limit (dBm)	Margin (dB)	Antenna Polarization (V/H)
95.96	-57.25	-49.05	-7.40	-0.80	-13.00	-44.25	H
206.54	-62.91	-59.15	-2.58	-1.18	-13.00	-49.91	H
445.16	-58.88	-55.03	-2.10	-1.75	-13.00	-45.88	H
553.80	-60.65	-57.41	-1.28	-1.96	-13.00	-47.65	H
713.85	-56.89	-53.24	-1.40	-2.25	-13.00	-43.89	H
959.26	-61.87	-57.95	-1.29	-2.63	-13.00	-48.87	H
1679.00	-52.95	-59.23	9.87	-3.59	-13.00	-39.95	H

Remark:

1. Measuring frequencies from 1 GHz to the 10th harmonic of highest fundamental frequency.

Report No.: T200319D03-RC

Operation Mode: GPRS 850 / High CH **Test Date:** March 31, 2020
Temperature: 18.6°C **Tested by:** Jerry Chang
Humidity: 59 % RH **Polarity:** Ver.

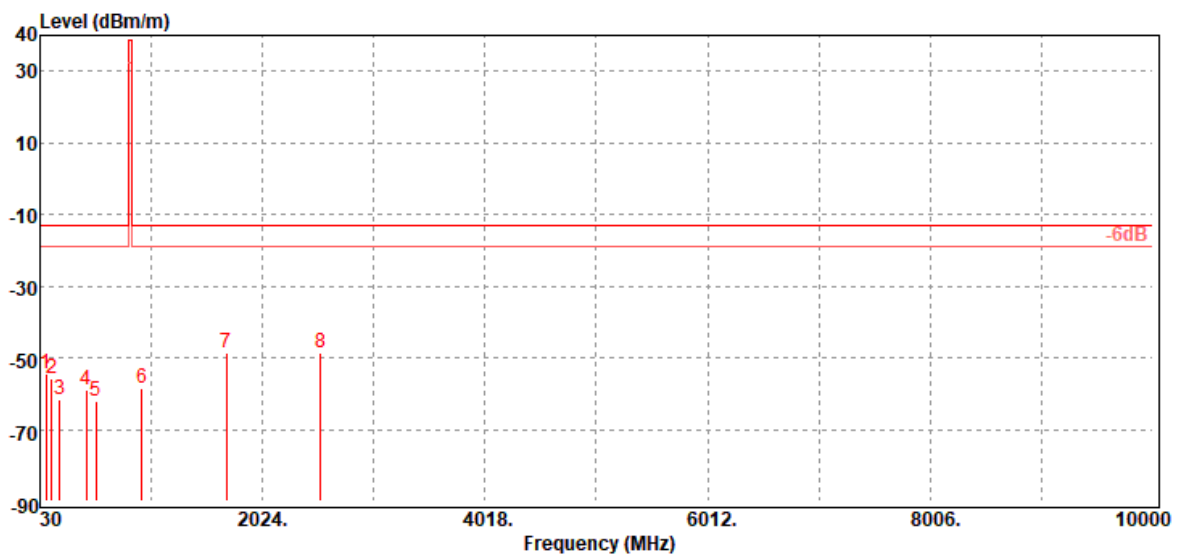

Frequency (MHz)	ERP/EIRP. (dBm)	SG Output Level (dBm)	Ant.Gain (dBi)	Cable Loss (dBm)	Limit (dBm)	Margin (dB)	Antenna Polarization (V/H)
86.26	-54.37	-46.06	-7.55	-0.76	-13.00	-41.37	V
134.76	-55.99	-45.69	-9.35	-0.95	-13.00	-42.99	V
206.54	-61.66	-57.9	-2.58	-1.18	-13.00	-48.66	V
447.10	-58.75	-54.9	-2.10	-1.75	-13.00	-45.75	V
532.46	-62.12	-58.9	-1.30	-1.92	-13.00	-49.12	V
943.74	-58.56	-54.72	-1.23	-2.61	-13.00	-45.56	V
1697.60	-48.44	-54.82	9.99	-3.61	-13.00	-35.44	V
2546.40	-48.67	-54.84	10.80	-4.63	-13.00	-35.67	V

Remark:

1. Measuring frequencies from 1 GHz to the 10th harmonic of highest fundamental frequency.

Report No.: T200319D03-RC

Operation Mode: GPRS 850 / High CH **Test Date:** March 31, 2020
Temperature: 18.6°C **Tested by:** Jerry Chang
Humidity: 59 % RH **Polarity:** Hor.

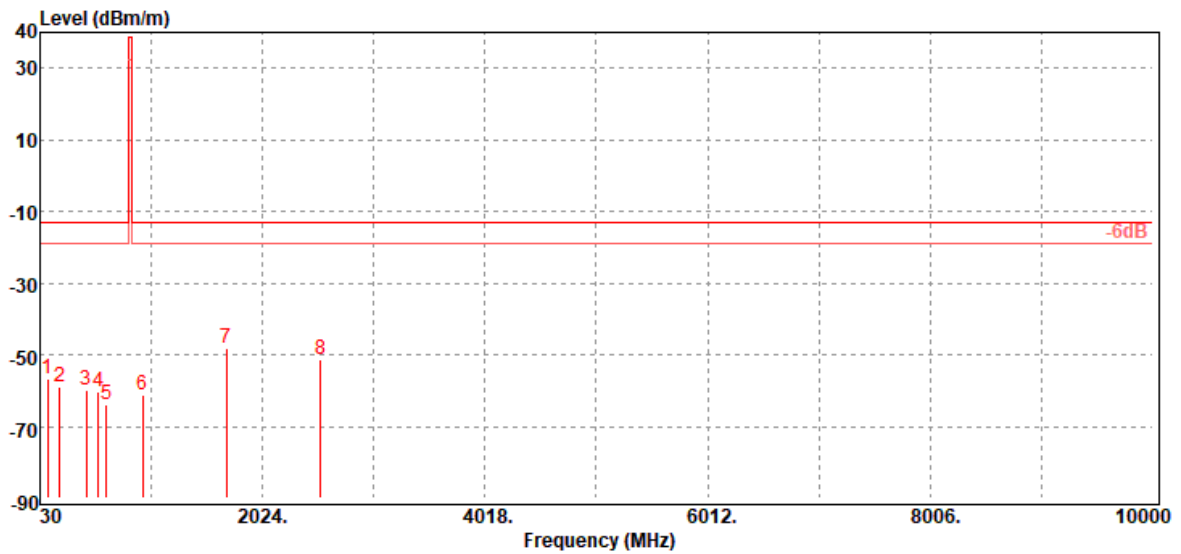

Frequency (MHz)	ERP/EIRP. (dBm)	SG Output Level (dBm)	Ant.Gain (dBi)	Cable Loss (dBm)	Limit (dBm)	Margin (dB)	Antenna Polarization (V/H)
95.96	-56.89	-48.69	-7.40	-0.80	-13.00	-43.89	H
206.54	-58.74	-54.98	-2.58	-1.18	-13.00	-45.74	H
444.19	-59.76	-55.91	-2.10	-1.75	-13.00	-46.76	H
553.80	-60.53	-57.29	-1.28	-1.96	-13.00	-47.53	H
623.64	-63.72	-60.21	-1.40	-2.11	-13.00	-50.72	H
951.50	-61.01	-57.19	-1.20	-2.62	-13.00	-48.01	H
1697.60	-47.97	-54.35	9.99	-3.61	-13.00	-34.97	H
2546.40	-51.23	-57.4	10.80	-4.63	-13.00	-38.23	H

Remark:

1. Measuring frequencies from 1 GHz to the 10th harmonic of highest fundamental frequency.

Report No.: T200319D03-RC

Radiated Spurious Emission Measurement Result

Operation Mode: GPRS 1900 / Low CH **Test Date:** March 31, 2020
Temperature: 18.6°C **Tested by:** Jerry Chang
Humidity: 59 % RH **Polarity:** Ver.

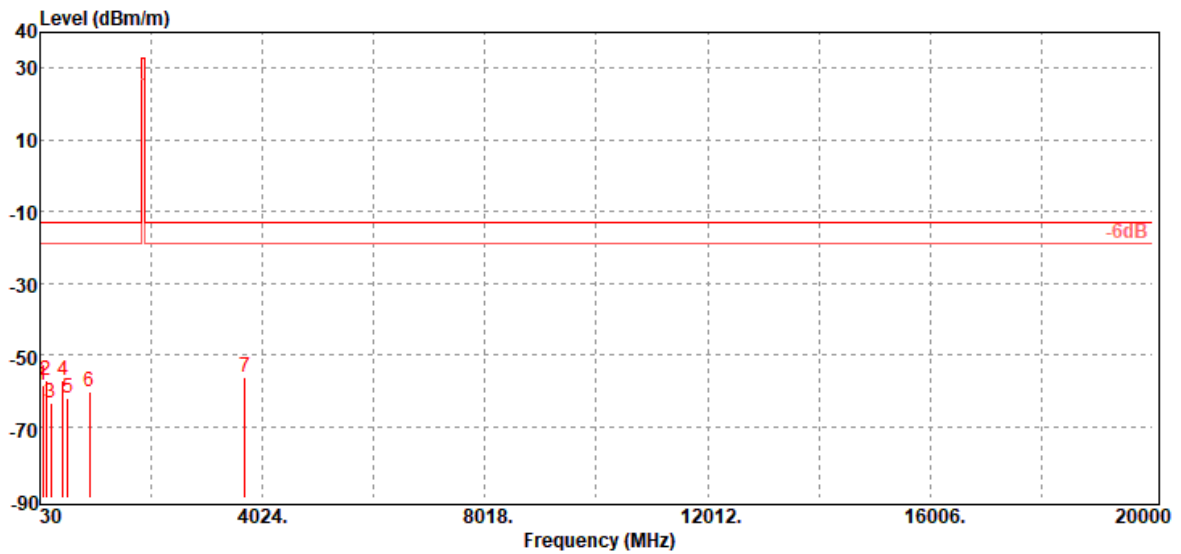

Frequency (MHz)	ERP/EIRP (dBm)	SG Output Level (dBm)	Ant.Gain (dBi)	Cable Loss (dBm)	Limit (dBm)	Margin (dB)	Antenna Polarization (V/H)
86.26	-58.62	-50.31	-7.55	-0.76	-13.00	-45.62	V
134.76	-57.38	-47.08	-9.35	-0.95	-13.00	-44.38	V
222.06	-63.47	-60.29	-1.96	-1.22	-13.00	-50.47	V
444.19	-57.31	-53.46	-2.10	-1.75	-13.00	-44.31	V
531.49	-62.15	-58.93	-1.30	-1.92	-13.00	-49.15	V
920.46	-60.45	-56.57	-1.30	-2.58	-13.00	-47.45	V
3700.40	-56.08	-62.87	12.50	-5.71	-13.00	-43.08	V

Remark:

1. Measuring frequencies from 1 GHz to the 10th harmonic of highest fundamental frequency.

Report No.: T200319D03-RC

Operation Mode: GPRS 1900 / Low CH **Test Date:** March 31, 2020
Temperature: 18.6°C **Tested by:** Jerry Chang
Humidity: 59 % RH **Polarity:** Hor.

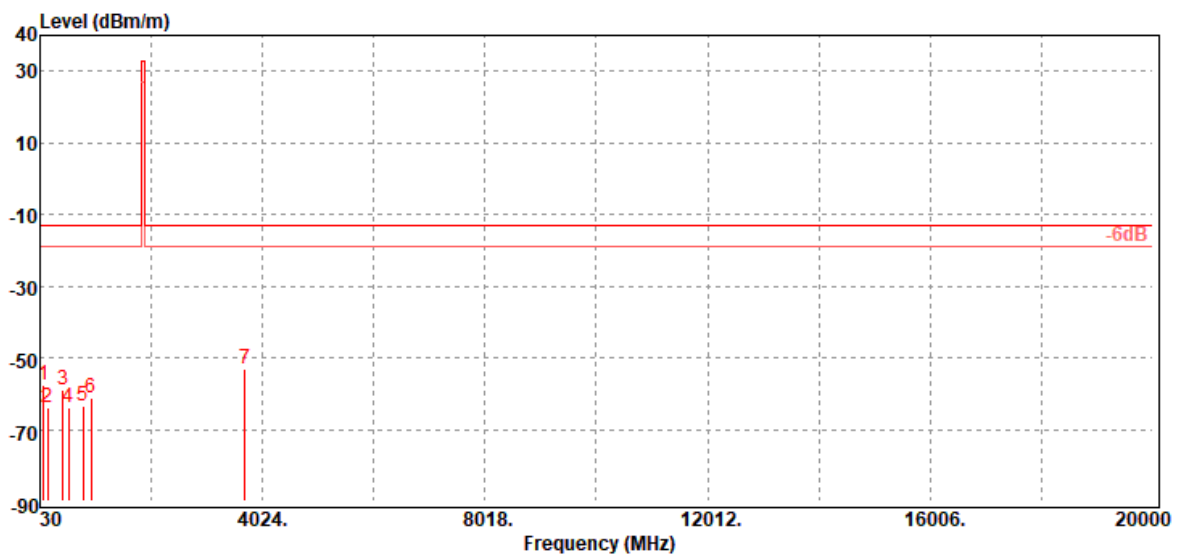

Frequency (MHz)	ERP/EIRP. (dBm)	SG Output Level (dBm)	Ant.Gain (dBi)	Cable Loss (dBm)	Limit (dBm)	Margin (dB)	Antenna Polarization (V/H)
95.96	-57.41	-49.21	-7.40	-0.80	-13.00	-44.41	H
162.89	-63.90	-56.84	-6.01	-1.05	-13.00	-50.90	H
444.19	-59.00	-55.15	-2.10	-1.75	-13.00	-46.00	H
548.95	-63.83	-60.68	-1.20	-1.95	-13.00	-50.83	H
799.21	-63.47	-59.82	-1.28	-2.37	-13.00	-50.47	H
944.71	-61.31	-57.49	-1.21	-2.61	-13.00	-48.31	H
3700.40	-53.26	-60.05	12.50	-5.71	-13.00	-40.26	H

Remark:

1. Measuring frequencies from 1 GHz to the 10th harmonic of highest fundamental frequency.

Report No.: T200319D03-RC

Operation Mode: GPRS 1900 / Mid CH **Test Date:** March 31, 2020
Temperature: 18.6°C **Tested by:** Jerry Chang
Humidity: 59 % RH **Polarity:** Ver.

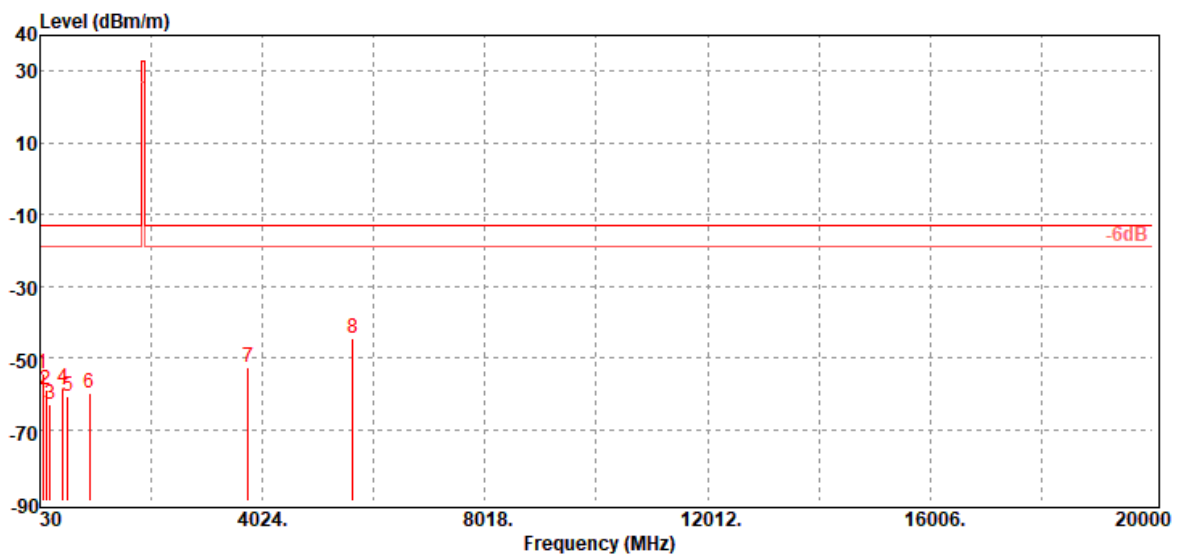

Frequency (MHz)	ERP/EIRP. (dBm)	SG Output Level (dBm)	Ant.Gain (dBi)	Cable Loss (dBm)	Limit (dBm)	Margin (dB)	Antenna Polarization (V/H)
86.26	-54.47	-46.16	-7.55	-0.76	-13.00	-41.47	V
134.76	-58.86	-48.56	-9.35	-0.95	-13.00	-45.86	V
212.36	-63.20	-59.9	-2.10	-1.20	-13.00	-50.20	V
444.19	-58.41	-54.56	-2.10	-1.75	-13.00	-45.41	V
532.46	-60.80	-57.58	-1.30	-1.92	-13.00	-47.80	V
912.70	-60.06	-56.14	-1.35	-2.57	-13.00	-47.06	V
3760.00	-52.48	-59.14	12.42	-5.76	-13.00	-39.48	V
5640.00	-44.66	-50.78	13.26	-7.14	-13.00	-31.66	V

Remark:

1. Measuring frequencies from 1 GHz to the 10th harmonic of highest fundamental frequency.

Report No.: T200319D03-RC

Operation Mode: GPRS 1900 / Mid CH **Test Date:** March 31, 2020
Temperature: 18.6°C **Tested by:** Jerry Chang
Humidity: 59 % RH **Polarity:** Hor.

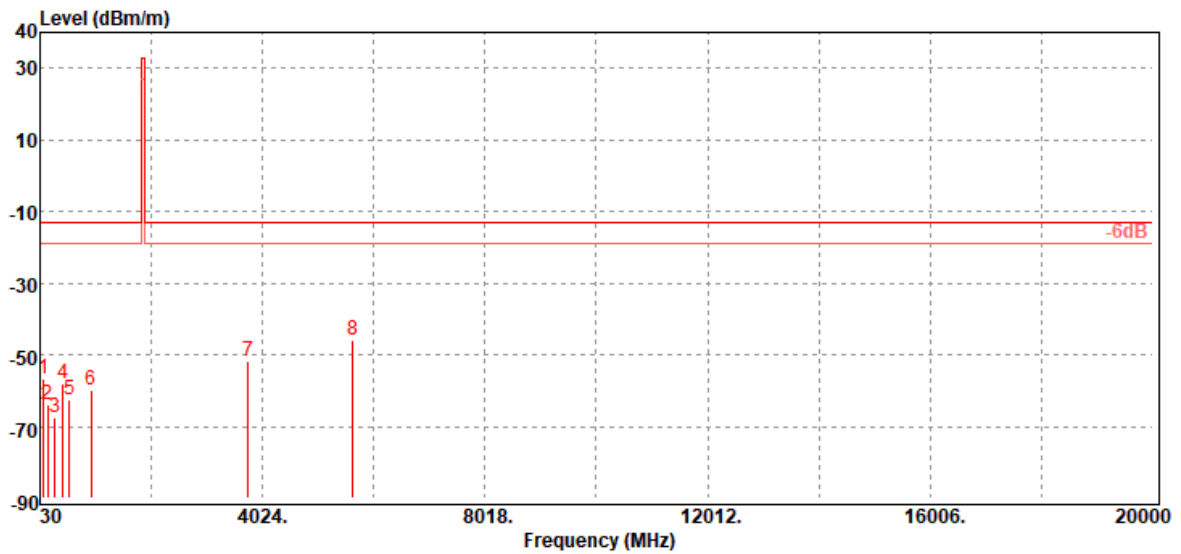

Frequency (MHz)	ERP/EIRP. (dBm)	SG Output Level (dBm)	Ant.Gain (dBi)	Cable Loss (dBm)	Limit (dBm)	Margin (dB)	Antenna Polarization (V/H)
95.96	-56.86	-48.66	-7.40	-0.80	-13.00	-43.86	H
162.89	-63.80	-56.74	-6.01	-1.05	-13.00	-50.80	H
291.90	-67.45	-63.88	-2.16	-1.41	-13.00	-54.45	H
445.16	-58.22	-54.37	-2.10	-1.75	-13.00	-45.22	H
550.89	-62.48	-59.31	-1.22	-1.95	-13.00	-49.48	H
954.41	-59.77	-55.95	-1.20	-2.62	-13.00	-46.77	H
3760.00	-51.83	-58.49	12.42	-5.76	-13.00	-38.83	H
5640.00	-46.04	-52.16	13.26	-7.14	-13.00	-33.04	H

Remark:

1. Measuring frequencies from 1 GHz to the 10th harmonic of highest fundamental frequency.

Report No.: T200319D03-RC

Operation Mode: GPRS 1900 / High CH **Test Date:** March 31, 2020
Temperature: 18.6°C **Tested by:** Jerry Chang
Humidity: 59 % RH **Polarity:** Ver.

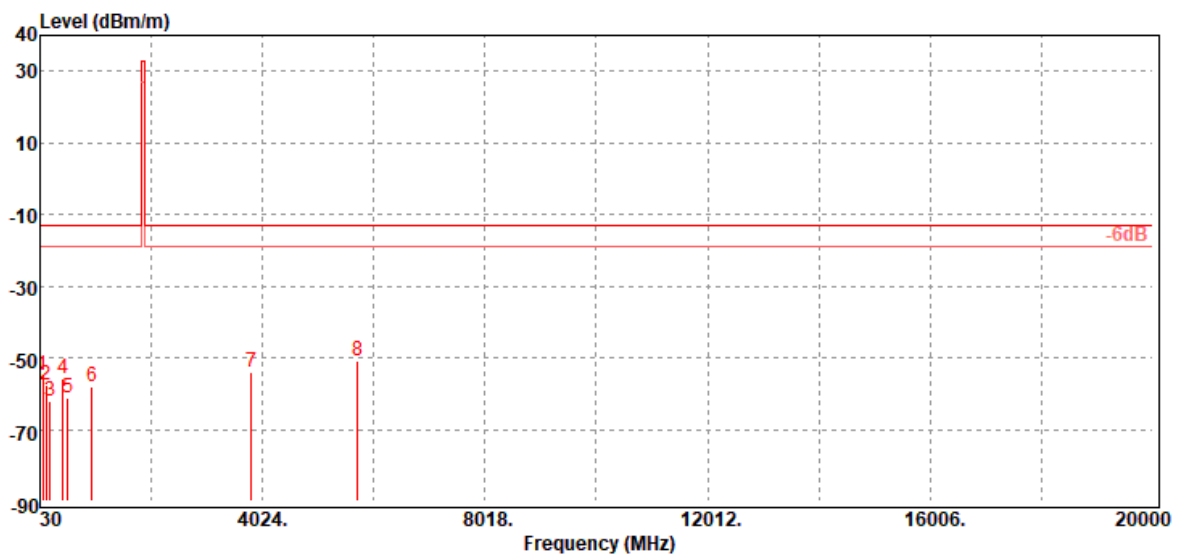

Frequency (MHz)	ERP/EIRP (dBm)	SG Output Level (dBm)	Ant.Gain (dBi)	Cable Loss (dBm)	Limit (dBm)	Margin (dB)	Antenna Polarization (V/H)
86.26	-55.12	-46.81	-7.55	-0.76	-13.00	-42.12	V
134.76	-57.71	-47.41	-9.35	-0.95	-13.00	-44.71	V
209.45	-61.91	-58.54	-2.18	-1.19	-13.00	-48.91	V
444.19	-55.85	-52	-2.10	-1.75	-13.00	-42.85	V
532.46	-61.16	-57.94	-1.30	-1.92	-13.00	-48.16	V
958.29	-58.15	-54.26	-1.27	-2.62	-13.00	-45.15	V
3819.60	-54.04	-60.69	12.46	-5.81	-13.00	-41.04	V
5729.40	-50.89	-56.8	13.10	-7.19	-13.00	-37.89	V

Remark:

1. Measuring frequencies from 1 GHz to the 10th harmonic of highest fundamental frequency.

Report No.: T200319D03-RC

Operation Mode: GPRS 1900 / High CH **Test Date:** March 31, 2020
Temperature: 18.6°C **Tested by:** Jerry Chang
Humidity: 59 % RH **Polarity:** Hor.

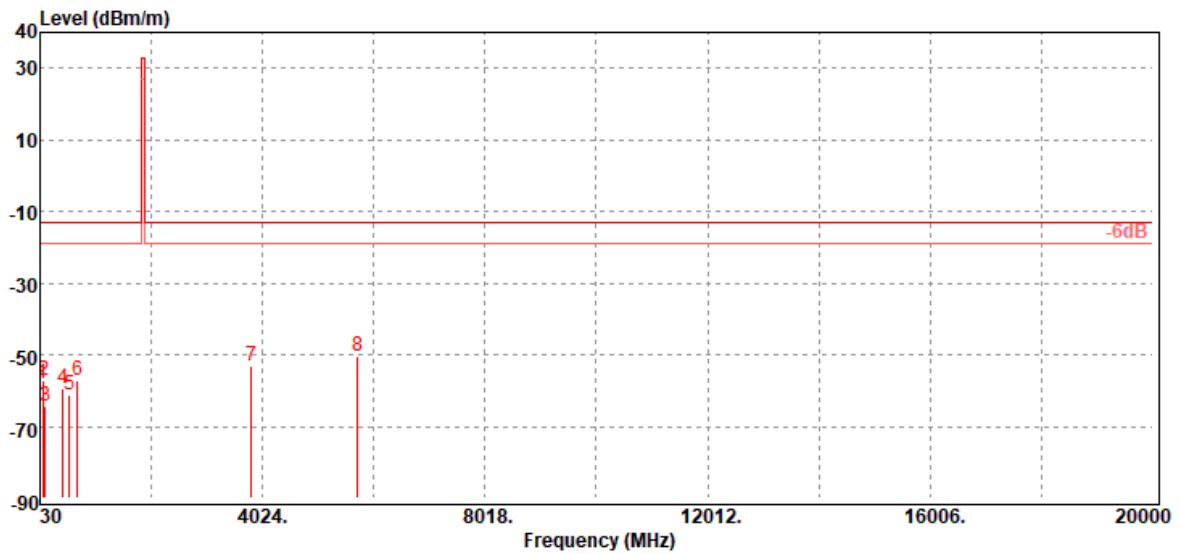

Frequency (MHz)	ERP/EIRP. (dBm)	SG Output Level (dBm)	Ant.Gain (dBi)	Cable Loss (dBm)	Limit (dBm)	Margin (dB)	Antenna Polarization (V/H)
81.41	-57.91	-48.77	-8.40	-0.74	-13.00	-44.91	H
95.96	-57.28	-49.08	-7.40	-0.80	-13.00	-44.28	H
127.00	-64.35	-52.93	-10.50	-0.92	-13.00	-51.35	H
444.19	-59.56	-55.71	-2.10	-1.75	-13.00	-46.56	H
555.74	-61.23	-57.96	-1.31	-1.96	-13.00	-48.23	H
699.30	-57.32	-53.69	-1.40	-2.23	-13.00	-44.32	H
3819.60	-52.95	-59.6	12.46	-5.81	-13.00	-39.95	H
5729.40	-50.48	-56.39	13.10	-7.19	-13.00	-37.48	H

Remark:

1. Measuring frequencies from 1 GHz to the 10th harmonic of highest fundamental frequency.

8.5 FREQUENCY STABILITY V.S. TEMPERATURE MEASUREMENT

LIMIT

According to RSS-132 section 5.3, RSS-133 section 6.3

The frequency stability shall be sufficient to ensure that the fundamental emission stays within the authorized frequency block.

Test Configuration

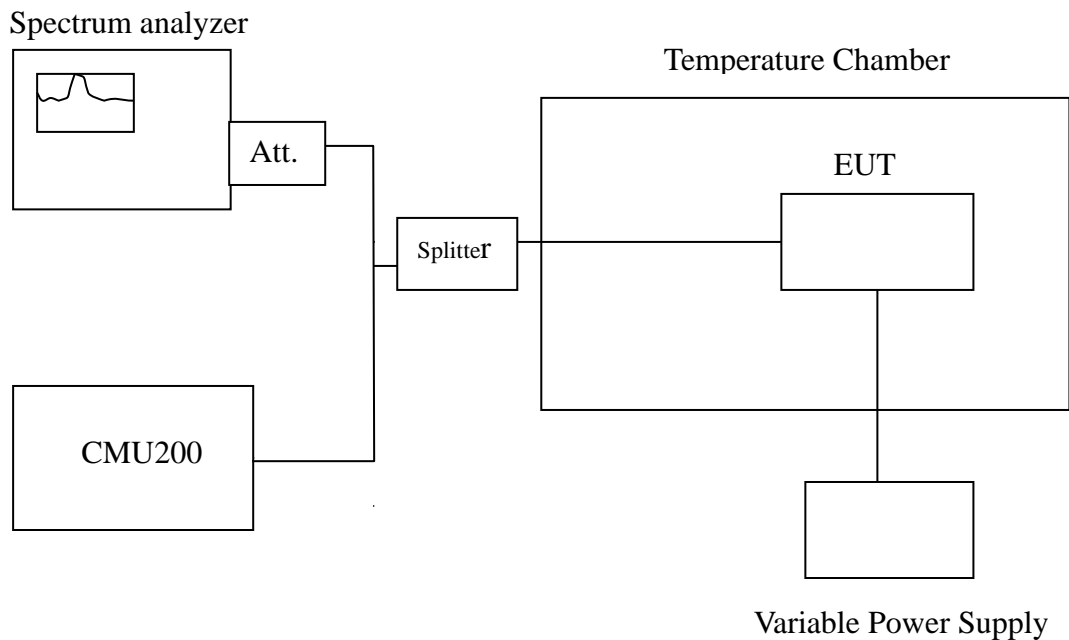

Remark: Measurement setup for testing on Antenna connector



Report No.: T200319D03-RC

Page: 44 / 52

Rev.: 03

TEST PROCEDURE

The equipment under test was connected to an external AC or DC power supply and input rated voltage. RF output was connected to a frequency counter or spectrum analyzer via feed through attenuators. The EUT was placed inside the temperature chamber. Set the spectrum analyzer RBW low enough to obtain the desired frequency resolution and measure EUT 20°C operating frequency as reference frequency. Turn EUT off and set the chamber temperature to -40°C. After the temperature stabilized for approximately 30 minutes recorded the frequency. Repeat step measure with 10°C increased per stage until the highest temperature of +65°C reached.

TEST RESULTS

No non-compliance noted.

Reference Frequency: GPRS Mid Channel 836.6 MHz @ 20°C				
Limit: 824.2 ~ 848.8 MHz				
Power Supply Vdc	Environment Temperature (°C)	Frequency (Hz)	Frequency Error (ppm)	Limit (ppm)
12	65	2	0.002391	2.5
	50	2	0.002391	2.5
	40	3	0.003586	2.5
	30	0	0.000000	2.5
	20	0	0.000000	2.5
	10	-1	-0.001195	2.5
	0	0	0.000000	2.5
	-10	2	0.002391	2.5
	-20	3	0.003586	2.5
	-30	3	0.003586	2.5
	-40	4	0.0048	2.5

Reference Frequency: GPRS Mid Channel 1880 MHz @ 20°C				
Limit: 1850.2 ~ 1909.8 MHz				
Power Supply Vdc	Environment Temperature (°C)	Frequency (Hz)	Frequency Error (ppm)	Limit (ppm)
12	65	5	0.002660	2.5
	50	6	0.003191	2.5
	40	6	0.003191	2.5
	30	0	0.000000	2.5
	20	0	0.000000	2.5
	10	3	0.001596	2.5
	0	5	0.002660	2.5
	-10	7	0.003723	2.5
	-20	2	0.001064	2.5
	-30	4	0.002128	2.5
	-40	5	0.0027	2.5

Report No.: T200319D03-RC

8.6 FREQUENCY STABILITY V.S. VOLTAGE MEASUREMENT

LIMIT

According to RSS-132 section 5.3, RSS-133 section 6.3

Test Configuration

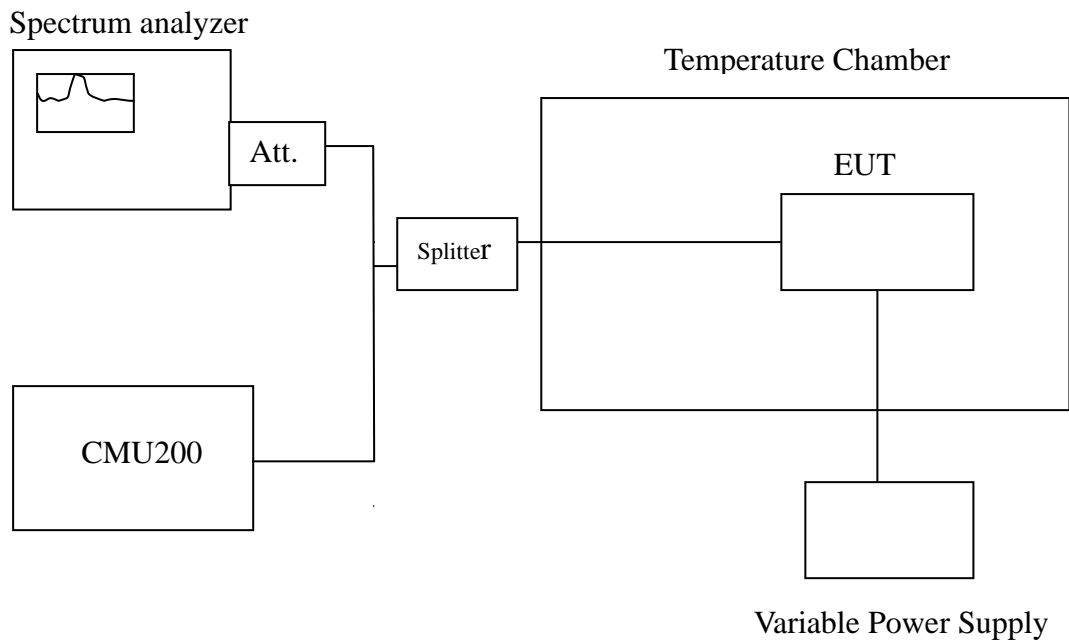

Remark: Measurement setup for testing on Antenna connector.

TEST PROCEDURE

Set chamber temperature to 20°C. Use a variable AC power supply / DC power source to power the EUT and set the voltage to rated voltage. Set the spectrum analyzer RBW low enough to obtain the desired frequency resolution and recorded the frequency.

Reduce the input voltage to specify extreme voltage variation ($\pm 15\%$) and endpoint, record the maximum frequency change.

TEST RESULTS

No non-compliance noted.

Reference Frequency: GPRS Mid Channel 836.6 MHz @ 20°C				
Limit: 824.2 ~ 848.8 MHz				
Power Supply Vdc	Environment Temperature (°C)	Frequency (Hz)	Frequency Error (ppm)	Limit (ppm)
10.2	20	0	0.000000	2.5
12		0	0.000000	2.5
13.8		0	0.000000	2.5

Reference Frequency: GPRS Mid Channel 1880 MHz @ 20°C				
Limit: 1850.2 ~ 1909.8 MHz				
Power Supply Vdc	Environment Temperature (°C)	Frequency (Hz)	Frequency Error (ppm)	Limit (ppm)
10.2	20	0	0.000000	2.5
12		0	0.000000	2.5
13.8		0	0.000000	2.5

Note: This sample supports USB 5V and battery, the USB 5V is the worst case.



Report No.: T200319D03-RC

Page: 48 / 52

Rev.: 03

8.7 PEAK TO AVERAGE RATIO

LIMIT

In measuring transmissions in this band using an average power technique, the peak to-average ratio (PAR) of the transmission may not exceed 13 dB.

TEST PROCEDURES

1. Set resolution/measurement bandwidth \geq signal's occupied bandwidth.
2. Set the number of counts to a value that stabilizes the measured CCDF curve.
3. Record the maximum PAPR level associated with a probability of 0.1%.

TEST DATA

GPRS 850

Low CH

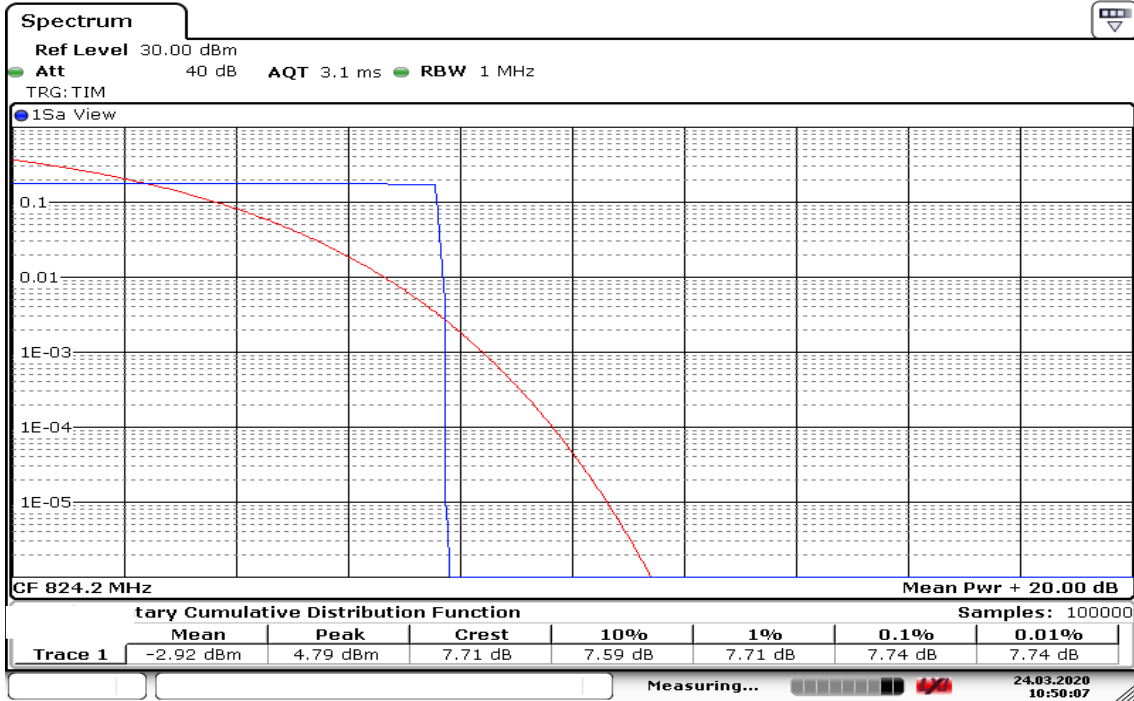

Date: 24.MAR.2020 10:50:07

Mid CH

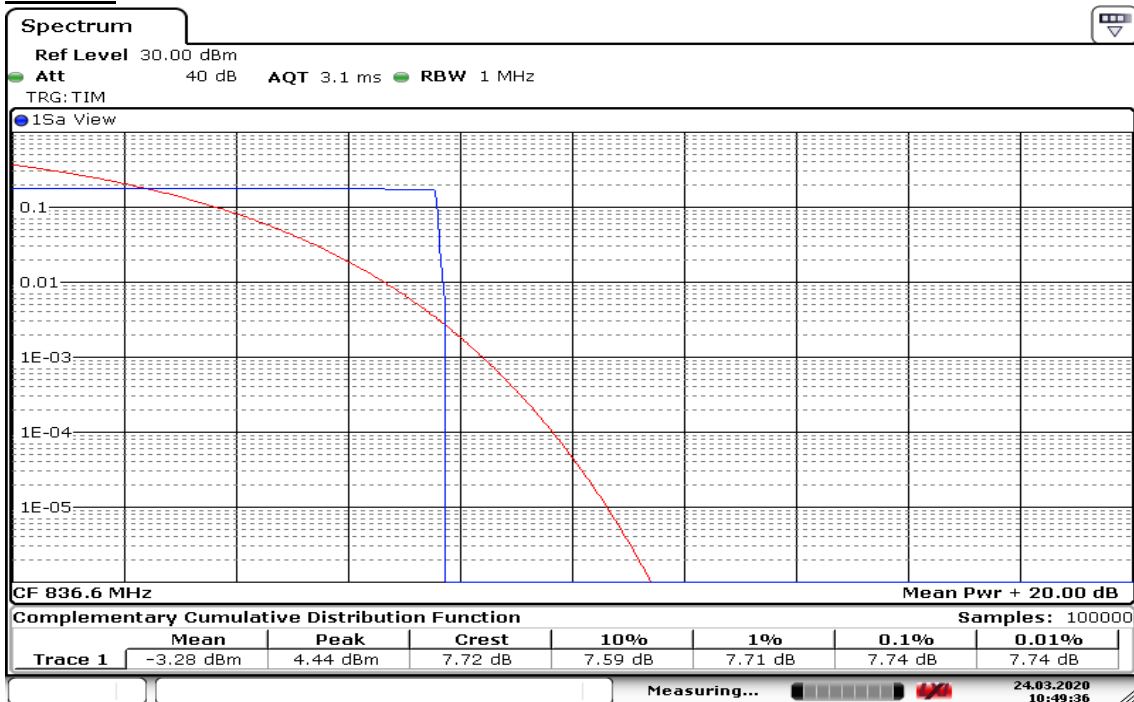

Date: 24.MAR.2020 10:49:36

High CH

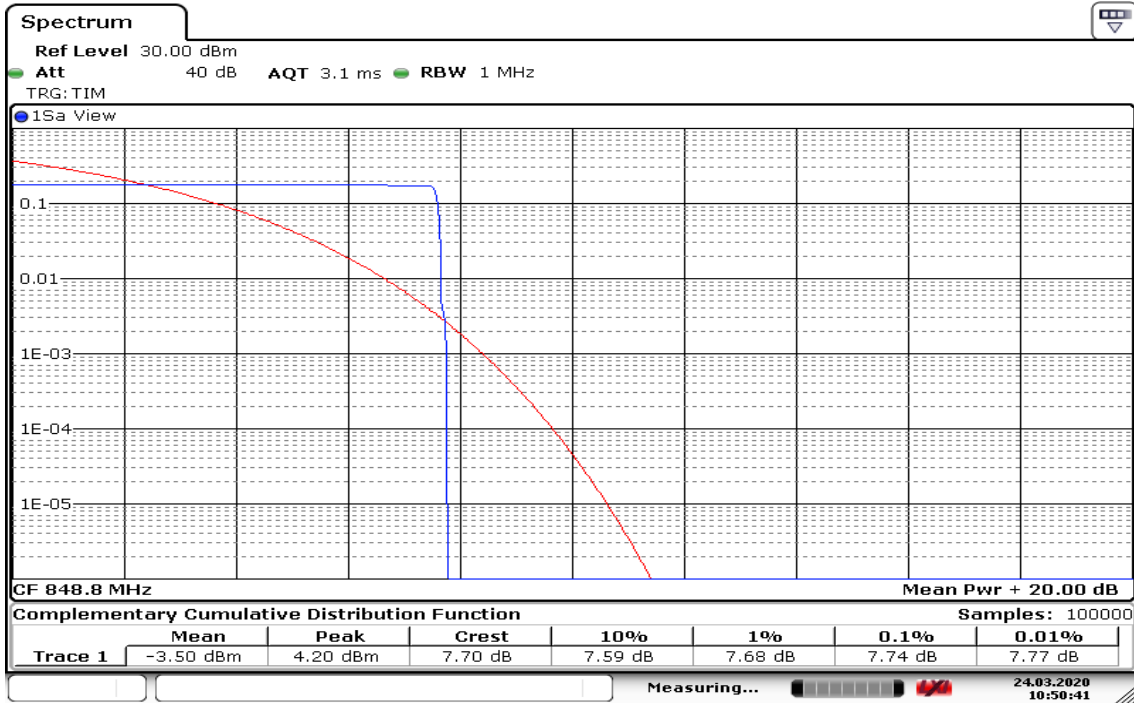

Date: 24.MAR.2020 10:50:41

GPRS 1900

Low CH

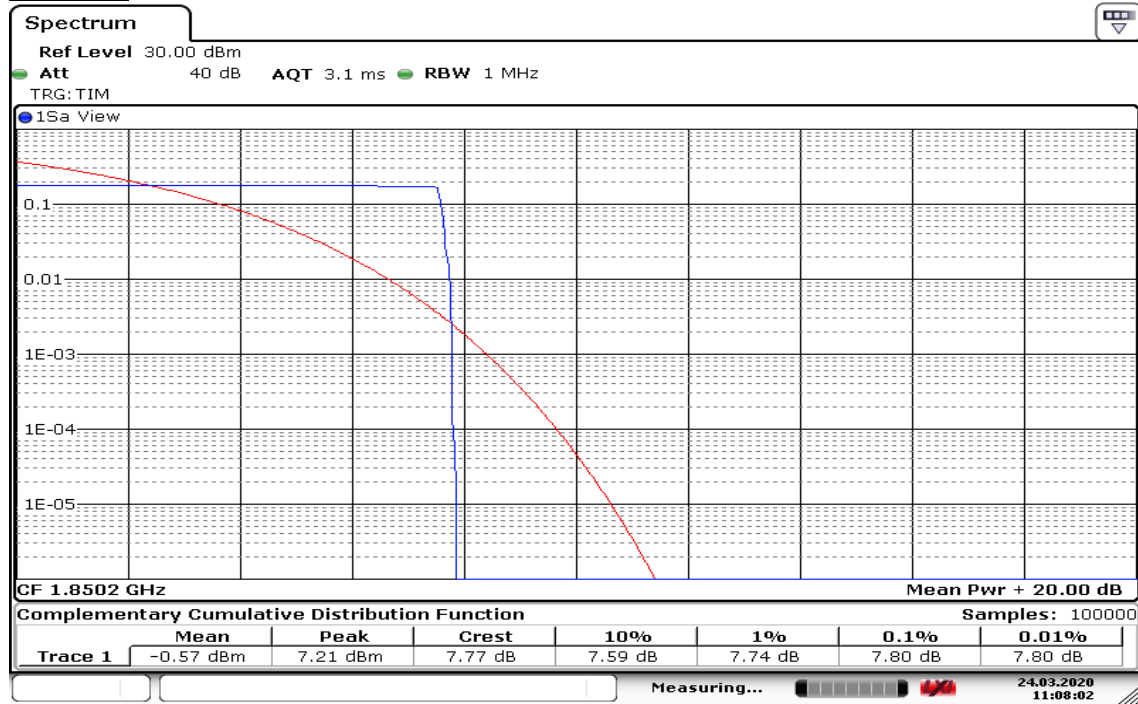

Date: 24.MAR.2020 11:08:02

Mid CH

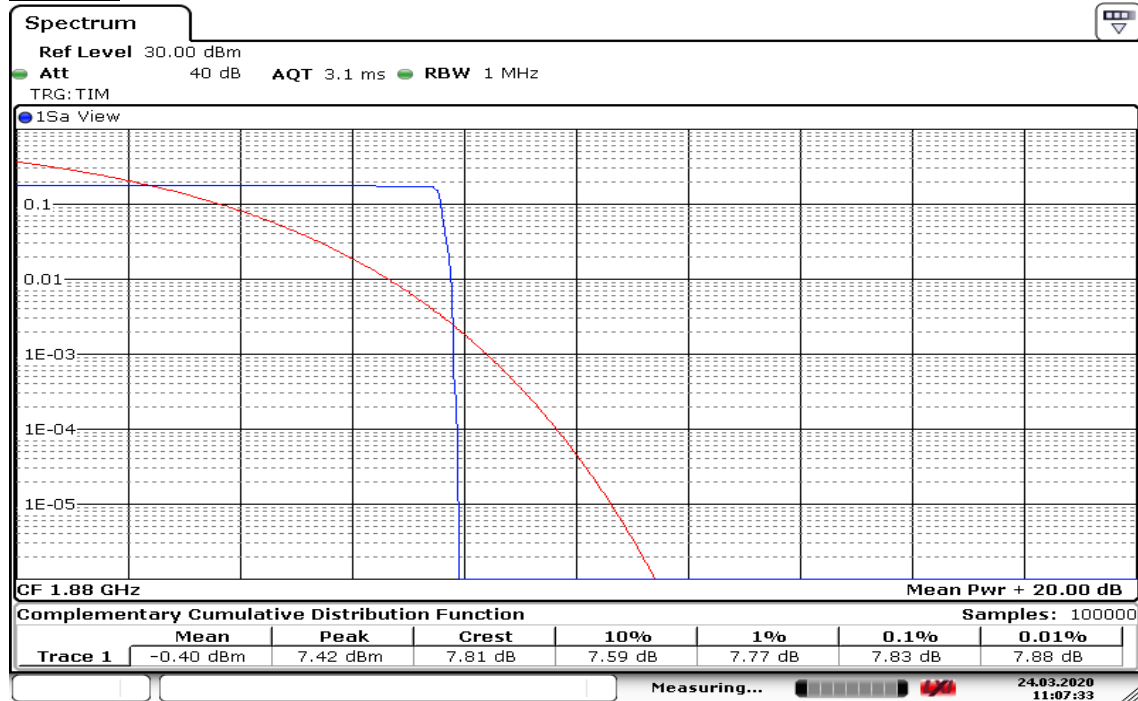

Date: 24.MAR.2020 11:07:33

High CH

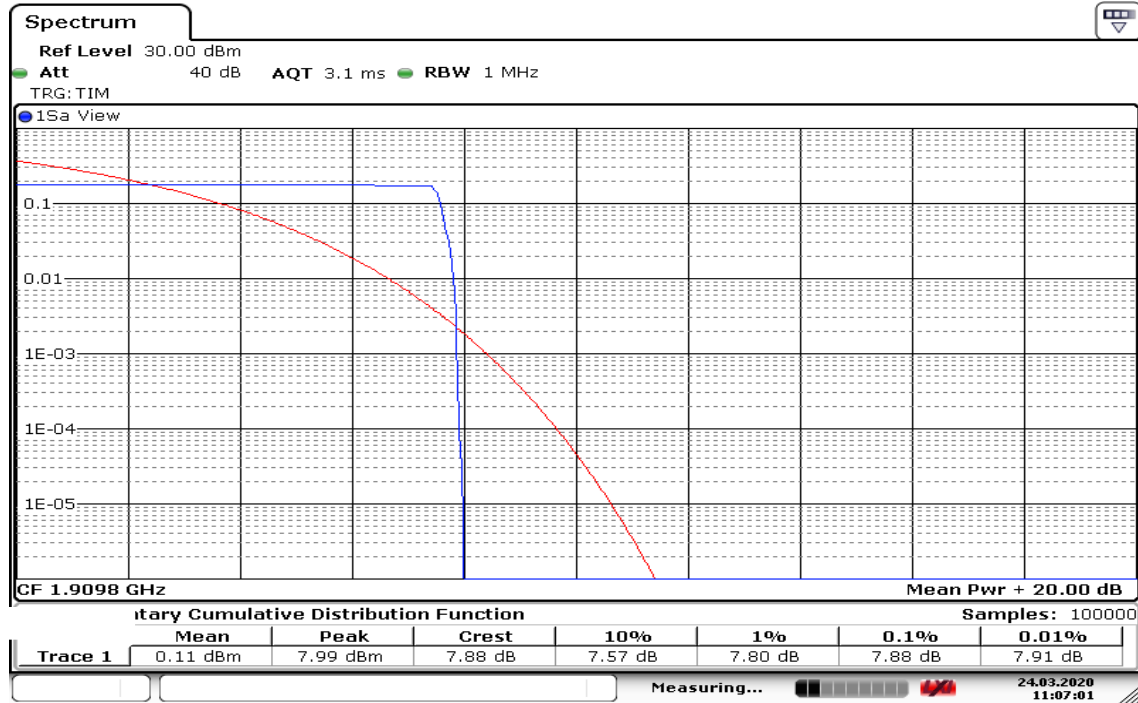

Date: 24.MAR.2020 11:07:01

-- End of Test Report --