

# RADIO TEST REPORT

## FCC 47 CFR PART 15 SUBPART C INDUSTRY CANADA RSS-247

<b>Test Standard</b>	<b>FCC Part 15.247 RSS-247 issue 2 and RSS-GEN issue 5</b>
<b>Product name</b>	<b>GUARDIAN SYSTEM LTE</b>
<b>Brand Name</b>	<b>GUARDIAN</b>
<b>FCC Model No.</b>	<b>G2-SY-CON2</b>
<b>IC Model No.</b>	<b>G2-SY-CON2-1002244</b>
<b>Test Result</b>	<b>Pass</b>
<b>Statements of Conformity</b>	<b>Determination of compliance is based on the results of the compliance measurement, not taking into account measurement instrumentation uncertainty.</b>

The test Result was tested by Compliance Certification Services Inc. The test data, data evaluation, test procedures, and equipment configurations shown in this report were given in ANSI C63.10: 2013 and compliance standards.

The test results of this report relate only to the tested sample (EUT) identified in this report.

The test Report of full or partial shall not copy. Without written approval of Compliance Certification Services Inc. (Wugu Laboratory)

Approved by:



---

Kevin Tsai  
Deputy Manager

Unless otherwise stated the results shown in this test report refer only to the sample(s) tested and such sample(s) are retained for 90 days only.  
除非另有說明，此報告結果僅對測試之樣品負責，同時此樣品僅保留90天。本報告未經本公司書面許可，不可部份複製。

This document is issued by the Company subject to its General Conditions of Service printed overleaf, available on request or accessible at <http://www.sgs.com.tw/Terms-and-Conditions> and, for electronic format documents, subject to Terms and Conditions for Electronic Documents at <http://www.sgs.com.tw/Terms-and-Conditions>. Attention is drawn to the limitation of liability, indemnification and jurisdiction issues defined therein. Any holder of this document is advised that information contained hereon reflects the Company's findings at the time of its intervention only and within the limits of client's instruction, if any. The Company's sole responsibility is to its Client and this document does not exonerate parties to a transaction from exercising all their rights and obligations under the transaction documents. This document cannot be reproduced, except in full, without prior written approval of the Company. Any unauthorized alteration, forgery or falsification of the content or appearance of this document is unlawful and offenders may be prosecuted to the fullest extent of the law.

### Revision History

Rev.	Issue Date	Revisions	Effect Page	Revised By
00	January 22, 2020	Initial Issue	ALL	Doris Chu
01	May 29, 2020	See the following Note Rev. (01)	P.4	Angel Cheng
02	June 20, 2020	See the following Note Rev. (02)	P.1, P.4	Allison Chen

**Rev (01):**

1. Revised section 2 power supply and Emission Designator.

**Rev (02):**

1. Modify IC Model No.: G2-SY-CON2-1002244.

## Table of contents

<b>1.</b>	<b>GENERAL INFORMATION .....</b>	<b>4</b>
1.1	<b>EUT INFORMATION .....</b>	4
1.2	<b>EUT CHANNEL INFORMATION .....</b>	5
1.3	<b>ANTENNA INFORMATION .....</b>	5
1.4	<b>MEASUREMENT UNCERTAINTY.....</b>	6
1.5	<b>FACILITIES AND TEST LOCATION .....</b>	6
1.6	<b>INSTRUMENT CALIBRATION .....</b>	7
1.7	<b>SUPPORT AND EUT ACCESSORIES EQUIPMENT .....</b>	8
1.8	<b>TEST METHODOLOGY AND APPLIED STANDARDS .....</b>	8
<b>2.</b>	<b>TEST SUMMERY .....</b>	<b>9</b>
<b>3.</b>	<b>DESCRIPTION OF TEST MODES.....</b>	<b>10</b>
3.1	<b>THE WORST MODE OF OPERATING CONDITION .....</b>	10
3.2	<b>THE WORST MODE OF MEASUREMENT .....</b>	11
3.3	<b>EUT DUTY CYCLE.....</b>	12
<b>4.</b>	<b>TEST RESULT .....</b>	<b>13</b>
4.1	<b>AC POWER LINE CONDUCTED EMISSION .....</b>	13
4.2	<b>6dB BANDWIDTH AND OCCUPIED BANDWIDTH(99%).....</b>	14
4.3	<b>OUTPUT POWER MEASUREMENT .....</b>	17
4.4	<b>POWER SPECTRAL DENSITY.....</b>	19
4.5	<b>CONDUCTED BAND EDGE AND SPURIOUS EMISSION .....</b>	21
4.6	<b>RADIATION BANDEDGE AND SPURIOUS EMISSION .....</b>	25
<b>APPENDIX 1 - PHOTOGRAPHS OF EUT</b>		

## 1. GENERAL INFORMATION

### 1.1 EUT INFORMATION

<b>FCC Applicant</b>	Seeing Machines Pty Ltd 80 Mildura Street, Fyshwick, ACT , Canberra 2609 Australia
<b>IC Applicant</b>	Seeing Machines Ltd. 80 Mildura Street Fyshwick ACT 2609 Australia
<b>Manufacturer</b>	ADLINK TECHNOLOGY INC. 9F, No. 166, Jian Yi Rd., Zhonghe Dist., New Taipei City, 235 Taiwan
<b>Equipment</b>	GUARDIAN SYSTEM LTE
<b>FCC Model No.</b>	G2-SY-CON2
<b>IC Model No.</b>	G2-SY-CON2-1002244
<b>Model Discrepancy</b>	N/A
<b>Trade Name</b>	GUARDIAN
<b>Received Date</b>	November 20, 2019
<b>Date of Test</b>	December 4, 2019 ~ January 6, 2020
<b>Output Power (W)</b>	BLE-1Mbps: 0.0133 (EIRP: 0.0240)
<b>Power Operation</b>	Powered from DC supply: DC 12V.
<b>HW Version</b>	V1
<b>SW Version</b>	V9

Report No.: T191120D05-RP2

## 1.2 EUT CHANNEL INFORMATION

Frequency Range	2402MHz-2480MHz
Modulation Type	GFSK for BLE-1Mbps
Number of channels	40 Channels

**Remark:**

Refer as ANSI C63.10: 2013 clause 5.6.1 Table 4 for test channels

Number of frequencies to be tested		
Frequency range in which device operates	Number of frequencies	Location in frequency range of operation
<input type="checkbox"/> 1 MHz or less	1	Middle
<input type="checkbox"/> 1 MHz to 10 MHz	2	1 near top and 1 near bottom
<input checked="" type="checkbox"/> More than 10 MHz	3	1 near top, 1 near middle, and 1 near bottom

## 1.3 ANTENNA INFORMATION

Antenna Type	<input type="checkbox"/> PIFA <input type="checkbox"/> PCB <input type="checkbox"/> Dipole <input type="checkbox"/> Coils <input checked="" type="checkbox"/> FPC
Antenna Gain	Gain: 2.56 dBi
Antenna Connector	i-pex

Report No.: T191120D05-RP2

## 1.4 MEASUREMENT UNCERTAINTY

PARAMETER	UNCERTAINTY
AC Powerline Conducted Emission	+/- 1.2575
Emission bandwidth, 20dB bandwidth	+/- 0.0014
RF output power, conducted	+/- 1.14
Power density, conducted	+/- 1.40
3M Semi Anechoic Chamber / 30M~200M	+/- 4.12
3M Semi Anechoic Chamber / 200M~1000M	+/- 4.68
3M Semi Anechoic Chamber / 1G~8G	+/- 5.18
3M Semi Anechoic Chamber / 8G~18G	+/- 5.47
3M Semi Anechoic Chamber / 18G~26G	+/- 3.81
3M Semi Anechoic Chamber / 26G~40G	+/- 3.87

**Remark:**

1. This uncertainty represents an expanded uncertainty expressed at approximately the 95% confidence level using a coverage factor of  $k=2$
2. ISO/IEC 17025 requires that an estimate of the measurement uncertainties associated with the emissions test results be included in the report.

## 1.5 FACILITIES AND TEST LOCATION

All measurement facilities used to collect the measurement data are located at No.11, Wugong 6th Rd., Wugong Dist., New Taipei City, Taiwan. (R.O.C.)

Test site	Test Engineer	Remark
AC Conduction Room	-	Not applicable, because EUT not connect to AC Main Source direct.
Radiation	Jerry Chang	-
RF Conducted	Dally Hong	-

**Remark:** The sites are constructed in conformance with the requirements of ANSI C63.7, ANSI C63.4 and CISPR Publication 22.

Report No.: T191120D05-RP2

## 1.6 INSTRUMENT CALIBRATION

RF Conducted Test Site					
Equipment	Manufacturer	Model	S/N	Cal Date	Cal Due
Coaxial Cable	Woken	WC12	CC001	06/28/2019	06/27/2020
Coaxial Cable	Woken	WC12	CC003	06/28/2019	06/27/2020
EXA Signal Analyzer	KEYSIGHT	N9010B	MY55460167	07/31/2019	07/30/2020
Power Meter	Anritsu	ML2495A	1149001	02/12/2019	02/11/2020
Power Seneor	Anritsu	MA2491A	030982	02/12/2019	02/11/2020
Wideband Radio Communication Tester	R&S	CMW 500	116875	07/29/2019	07/28/2020
DC Power Supplies	GW Instek	SPS-3610	GPE880163	01/14/2019	1/13/2020
Software	N/A				

3M 966 Chamber Test Site					
Equipment	Manufacturer	Model	S/N	Cal Date	Cal Due
Band Reject Filters	MICRO TRONICS	BRM 50702	120	02/26/2019	02/25/2020
Bilog Antenna	Sunol Sciences	JB3	A030105	07/26/2019	07/25/2020
Coaxial Cable	HUBER SUHNER	SUCOFLEX 104PEA	20995	02/26/2019	02/25/2020
Coaxial Cable	EMCI	EMC105	190914+25111	09/20/2019	09/19/2020
Digital Thermo-Hygro Meter	WISEWIND	1206	D07	01/30/2019	01/29/2020
double Ridged Guide Horn Antenna	ETC	MCTD 1209	DRH13M02003	10/04/2019	10/03/2020
Loop Ant	COM-POWER	AL-130	121051	03/22/2019	03/21/2020
Pre-Amplifier	EMEC	EM330	060609	02/26/2019	02/25/2020
Pre-Amplifier	HP	8449B	3008A00965	02/26/2019	02/25/2020
PSA Series Spectrum Analyzer	Agilent	E4446A	MY46180323	05/29/2019	05/28/2020
Antenna Tower	CCS	CC-A-1F	N/A	N.C.R	N.C.R
Controller	CCS	CC-C-1F	N/A	N.C.R	N.C.R
Turn Table	CCS	CC-T-1F	N/A	N.C.R	N.C.R
Software	e3 6.11-20180413				

AC line Conduction Test Room					
Equipment	Manufacturer	Model	S/N	Cal Date	Cal Due
N/A					

**Note:**

1. The calibration interval of the above test instruments is 12 months and the calibrations are traceable to NML/ROC and NIST/USA.
2. N.C.R. = No Calibration Required

## 1.7 SUPPORT AND EUT ACCESSORIES EQUIPMENT

EUT Accessories Equipment						
No.	Equipment	Brand	Model	Series No.	FCC ID	IC ID
	N/A					

Support Equipment						
No.	Equipment	Brand	Model	Series No.	FCC ID	IC ID
1	NB(J)	TOSHIBA	PT345T-00L002	N/A	PD97260H	1000M-7260H

## 1.8 TEST METHODOLOGY AND APPLIED STANDARDS

The test methodology, setups and results comply with all requirements in accordance with ANSI C63.10:2013, FCC Part 2, FCC Part 15.247, KDB 558074 D01, RSS-247 Issue 2 and RSS-GEN Issue 5



Report No.: T191120D05-RP2

## 2. TEST SUMMERY

FCC Standard Section	IC Standard Section	Report Section	Test Item	Result
15.203	-	1.3	Antenna Requirement	Pass
15.207(a)	RSS-GEN 8.8	4.1	AC Conducted Emission	N/A
15.247(a)(2)	RSS-247(5.2)(a)	4.2	6 dB Bandwidth	Pass
-	RSS-GEN 6.7	4.2	Occupied Bandwidth (99%)	Pass
15.247(b)(3)	RSS-247(5.4)(d)	4.3	Output Power Measurement	Pass
15.247(e)	RSS-247(5.2)(b)	4.4	Power Spectral Density	Pass
15.247(d)	RSS-247(5.5)	4.5	Conducted Band Edge	Pass
15.247(d)	RSS-247(5.5)	4.5	Conducted Spurious Emission	Pass
15.247(d)	RSS-GEN 8.9, 8.10	4.6	Radiation Band Edge	Pass
15.247(d)	RSS-GEN 8.9, 8.10	4.6	Radiation Spurious Emission	Pass

### 3. DESCRIPTION OF TEST MODES

#### 3.1 THE WORST MODE OF OPERATING CONDITION

Operation mode	BLE Mode (1Mbps)
Test Channel Frequencies	1.Lowest Channel : 2402MHz 2.Middle Channel : 2440MHz 3.Highest Channel : 2480MHz

**Remark:**

1. EUT pre-scanned data rate of output power for each mode, the worst data rate were recorded in this report.

### 3.2 THE WORST MODE OF MEASUREMENT

Radiated Emission Measurement Above 1G	
Test Condition	Radiated Emission Above 1G
Power supply Mode	Mode 1: EUT power by Power supply
Worst Mode	<input checked="" type="checkbox"/> Mode 1 <input type="checkbox"/> Mode 2 <input type="checkbox"/> Mode 3 <input type="checkbox"/> Mode 4
Worst Position	<input type="checkbox"/> Placed in fixed position. <input checked="" type="checkbox"/> Placed in fixed position at X-Plane (E2-Plane) <input type="checkbox"/> Placed in fixed position at Y-Plane (E1-Plane) <input type="checkbox"/> Placed in fixed position at Z-Plane (H-Plane)

Radiated Emission Measurement Below 1G	
Test Condition	Radiated Emission Below 1G
Power supply Mode	Mode 1: EUT power by Power supply
Worst Mode	<input checked="" type="checkbox"/> Mode 1 <input type="checkbox"/> Mode 2 <input type="checkbox"/> Mode 3 <input type="checkbox"/> Mode 4

*Remark:*

- 1. The worst mode was record in this test report.*
- 2. EUT pre-scanned in three axis ,X,Y, Z and two polarity, for radiated measurement. The worst case(X-Plane) were recorded in this report*

Report No.: T191120D05-RP2

### 3.3 EUT DUTY CYCLE

Duty Cycle				
Configuration	Duty Cycle (%)	Duty Factor (dB) =10*log (1/Duty Cycle)	1/T (kHz)	VBW setting (kHz)
BLE-1Mbps	65.60	1.83	2.44	3.00

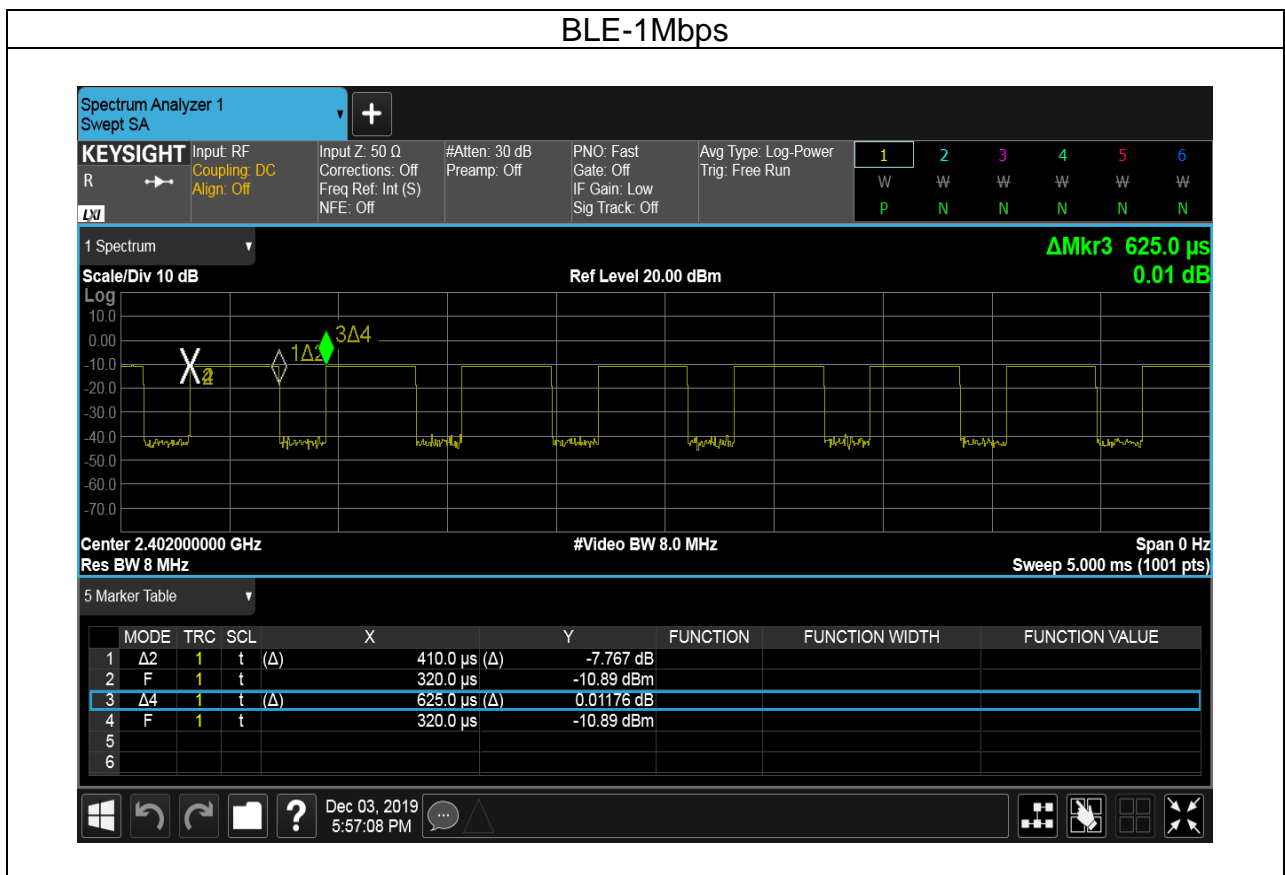

Report No.: T191120D05-RP2

## 4. TEST RESULT

### 4.1 AC POWER LINE CONDUCTED EMISSION

#### 4.1.1 Test Limit

According to §15.207(a) and RSS-GEN section 8.8,

Frequency Range (MHz)	Limits(dB $\mu$ V)	
	Quasi-peak	Average
0.15 to 0.50	66 to 56*	56 to 46*
0.50 to 5	56	46
5 to 30	60	50

\* Decreases with the logarithm of the frequency.

#### 4.1.2 Test Procedure

Test method Refer as ANSI C63.10: 2013 clause 6.2,

1. The EUT was placed above horizontal ground plane and 0.4m above vertical ground plane
2. EUT connected to the line impedance stabilization network (LISN)
3. Receiver set RBW of 9kHz and Detector Peak, and note as quasi-peak and average.
4. Maximum procedure was performed on the six highest emissions to ensure EUT compliance.
5. Recorded Line for Neutral and Line.

#### 4.1.3 Test Setup

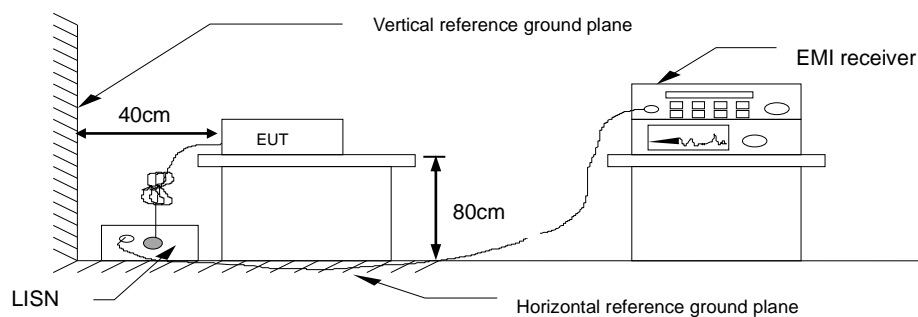

#### 4.1.4 Test Result

**Not applicable, because EUT not connect to AC Main Source direct.**

Report No.: T191120D05-RP2

## 4.2 6dB BANDWIDTH AND OCCUPIED BANDWIDTH (99%)

### 4.2.1 Test Limit

According to §15.247(a)(2) and RSS-247 section 5.2(a)

#### 6 dB Bandwidth :

Limit	Shall be at least 500kHz
-------	--------------------------

Occupied Bandwidth(99%) : For reporting purposes only.

### 4.2.2 Test Procedure

Test method Refer as KDB 558074 D01 and ANSI C63.10: 2013 clause 6.9.2,

1. The EUT RF output connected to the spectrum analyzer by RF cable.
2. Setting maximum power transmit of EUT.
3. SA set RBW =100KHz, VBW = 300KHz and Detector = Peak, to measurement 6dB Bandwidth.
4. SA set RBW = 1% ~ 5% OBW, VBW = three times the RBW and Detector = Peak, to measurement 99% Bandwidth.
5. Measure and record the result of 6 dB Bandwidth and 99% Bandwidth. in the test report.

### 4.2.3 Test Setup

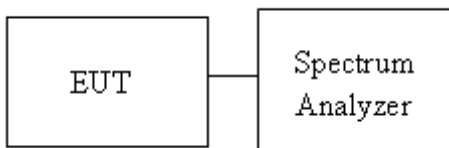

### 4.2.4 Test Result

Test mode: BLE-1Mbps mode / 2402-2480 MHz				
Channel	Frequency (MHz)	OBW (99%) (MHz)	6dB BW (MHz)	6dB limit (kHz)
Low	2402	1.0174	0.6818	>500
Mid	2440	1.0161	0.6763	
High	2480	1.0169	0.6833	

Report No.: T191120D05-RP2

## 6dB BANDWIDTH Test Data

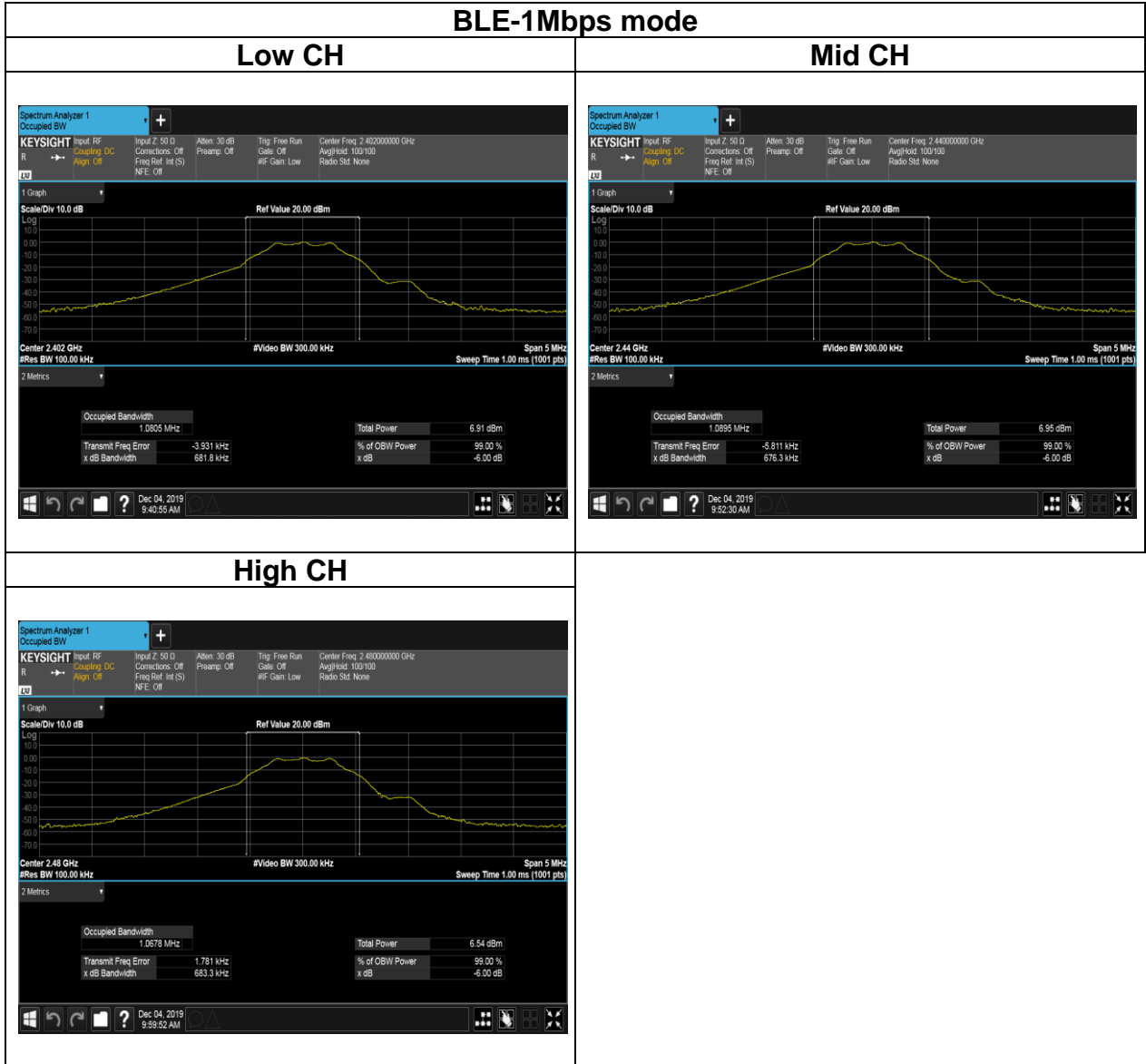

Report No.: T191120D05-RP2

## BANDWIDTH (99%) Test Data

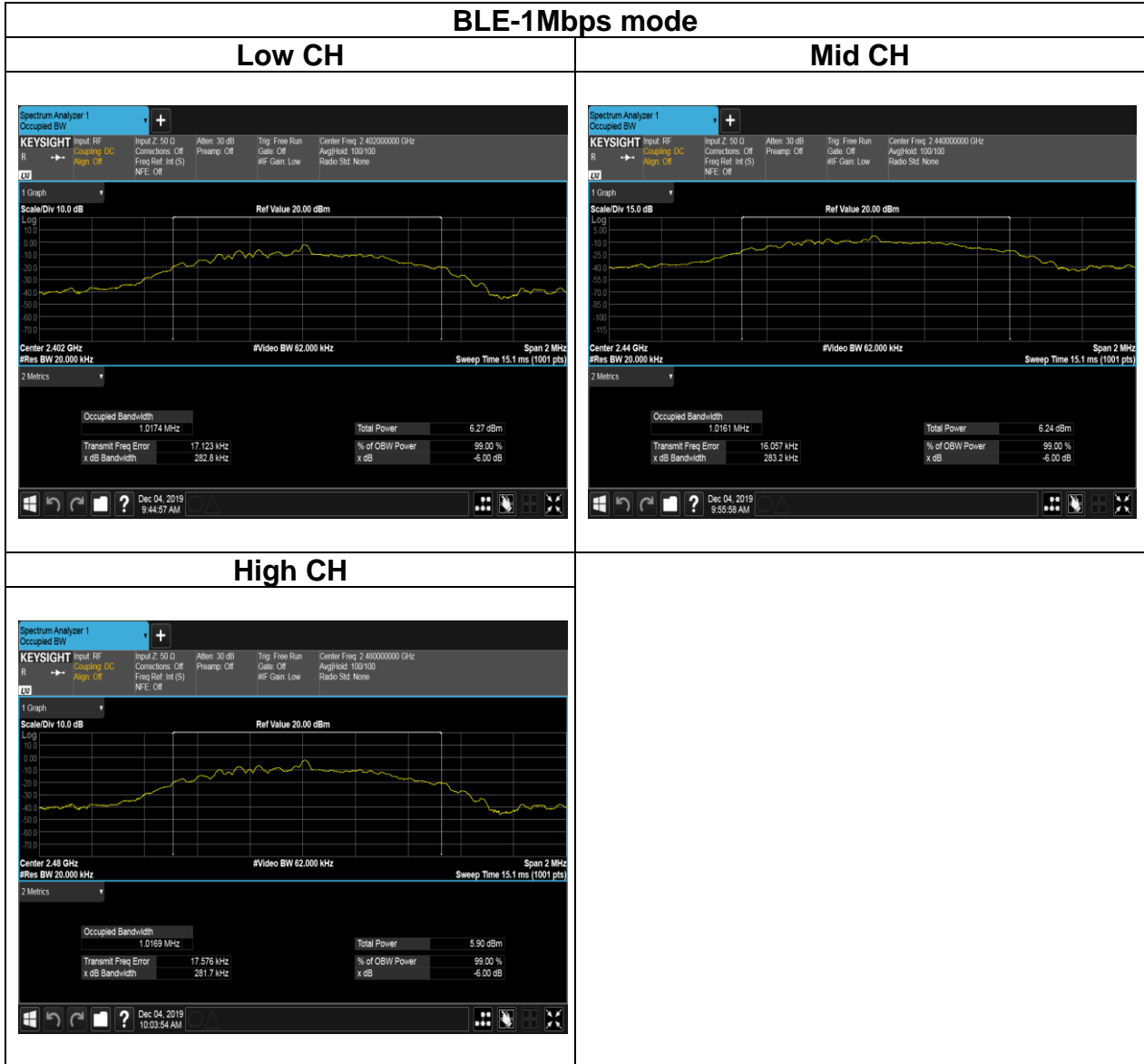



Report No.: T191120D05-RP2

## 4.3 OUTPUT POWER MEASUREMENT

### 4.3.1 Test Limit

According to §15.247(b)(3) and RSS-247 section 5.4(d),

**Peak output power** :

#### FCC

For systems using digital modulation in the 2400-2483.5 MHz: 1 Watt(30 dBm), base on the use of antennas with directional gain not exceed 6 dBi If transmitting antennas of directional gain greater than 6dBi are used the peak output power the conducted output power from the intentional radiator shall be reduced by the amount in dB that the directional gain of the antenna exceeds 6 dBi. In case of point-to-point operation, the limit has to be reduced by 1dB for every 3 dB that the directional gain of the antenna exceeds 6 dBi.

#### IC

For DTSs employing digital modulation techniques operating in the bands 2400-2483.5 MHz, the maximum peak conducted output power shall not exceed 1 W. The e.i.r.p. shall not exceed 4 W, except as provided in section 5.4(e), base on the use of antennas with directional gain not exceed 6 dBi If transmitting antennas of directional gain greater than 6dBi are used the peak output power the conducted output power from the intentional radiator shall be reduced by the amount in dB that the directional gain of the antenna exceeds 6 dBi. In case of point-to-point operation, the limit has to be reduced by 1dB for every 3 dB that the directional gain of the antenna exceeds 6 dBi.

Limit	<input checked="" type="checkbox"/> Antenna not exceed 6 dBi : 30dBm <input type="checkbox"/> Antenna with DG greater than 6 dBi [ Limit = 30 – (DG – 6) ] <input type="checkbox"/> Point-to-point operation
-------	---

**Average output power** : For reporting purposes only.

### 4.3.2 Test Procedure

Test method Refer as KDB 558074 D01.

1. The EUT RF output connected to the power meter by RF cable.
2. Setting maximum power transmit of EUT.
3. The path loss was compensated to the results for each measurement.
4. Measure and record the result of Peak output power and Average output power. in the test report.

### 4.3.3 Test Setup

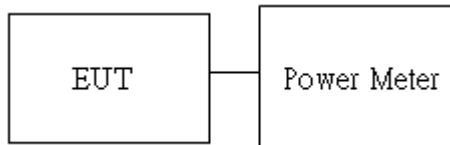

### 4.3.4 Test Result

#### Peak output power :

BLE Mode										
Config.	CH	Freq. (MHz)	Power Setting	PK Power (dBm)	EIRP PK Power (dBm)	PK Power (W)	EIRP PK Power (W)	FCC Limit (dBm)	IC Limit (dBm)	Antenna Gain (dBi)
BLE Data rate: 1Mbps	0	2402	0x0f	11.25	13.81	0.0133	0.0240	30	36	2.56
	19	2440	0x0f	11.11	13.67	0.0129	0.0233			
	39	2480	0x0f	10.83	13.39	0.0121	0.0218			

#### Average output power :

BLE Mode			
Config.	CH	Freq. (MHz)	AV Power (dBm)
BLE Data rate: 1Mbps	0	2402	11.13
	19	2440	10.99
	39	2480	10.69

Report No.: T191120D05-RP2

## 4.4 POWER SPECTRAL DENSITY

### 4.4.1 Test Limit

According to §15.247(e) and RSS-247 section 5.2(b)

For digitally modulated systems, the power spectral density conducted from the intentional radiator to the antenna shall not be greater than 8 dBm in any 3 kHz band during any time interval of continuous transmission.

Limit	<input checked="" type="checkbox"/> Antenna not exceed 6 dBi : 8dBm <input type="checkbox"/> Antenna with DG greater than 6 dBi [ Limit = 8 – (DG – 6) ] <input type="checkbox"/> Point-to-point operation :
-------	---

### 4.4.2 Test Procedure

Test method Refer as KDB 558074 D01.

1. The EUT RF output connected to the spectrum analyzer by RF cable.
2. Setting maximum power transmit of EUT
3. SA set RBW = 3kHz, VBW = 30kHz, Span = 1.5 times DTS Bandwidth (6 dB BW), Detector = Peak, Sweep Time = Auto and Trace = Max hold.
4. The path loss and Duty Factor were compensated to the results for each measurement by SA.
5. Mark the maximum level.
6. Measure and record the result of power spectral density. in the test report.

### 4.4.3 Test Setup

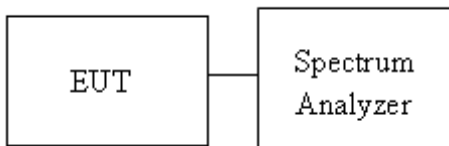

### 4.4.4 Test Result

Test mode: BLE-1Mbps mode / 2402-2480 MHz			
Channel	Frequency (MHz)	PSD (dBm)	FCC / IC limit (dBm)
Low	2402	-3.69	8
Mid	2440	-3.77	
High	2480	-4.14	

Report No.: T191120D05-RP2

## Test Data

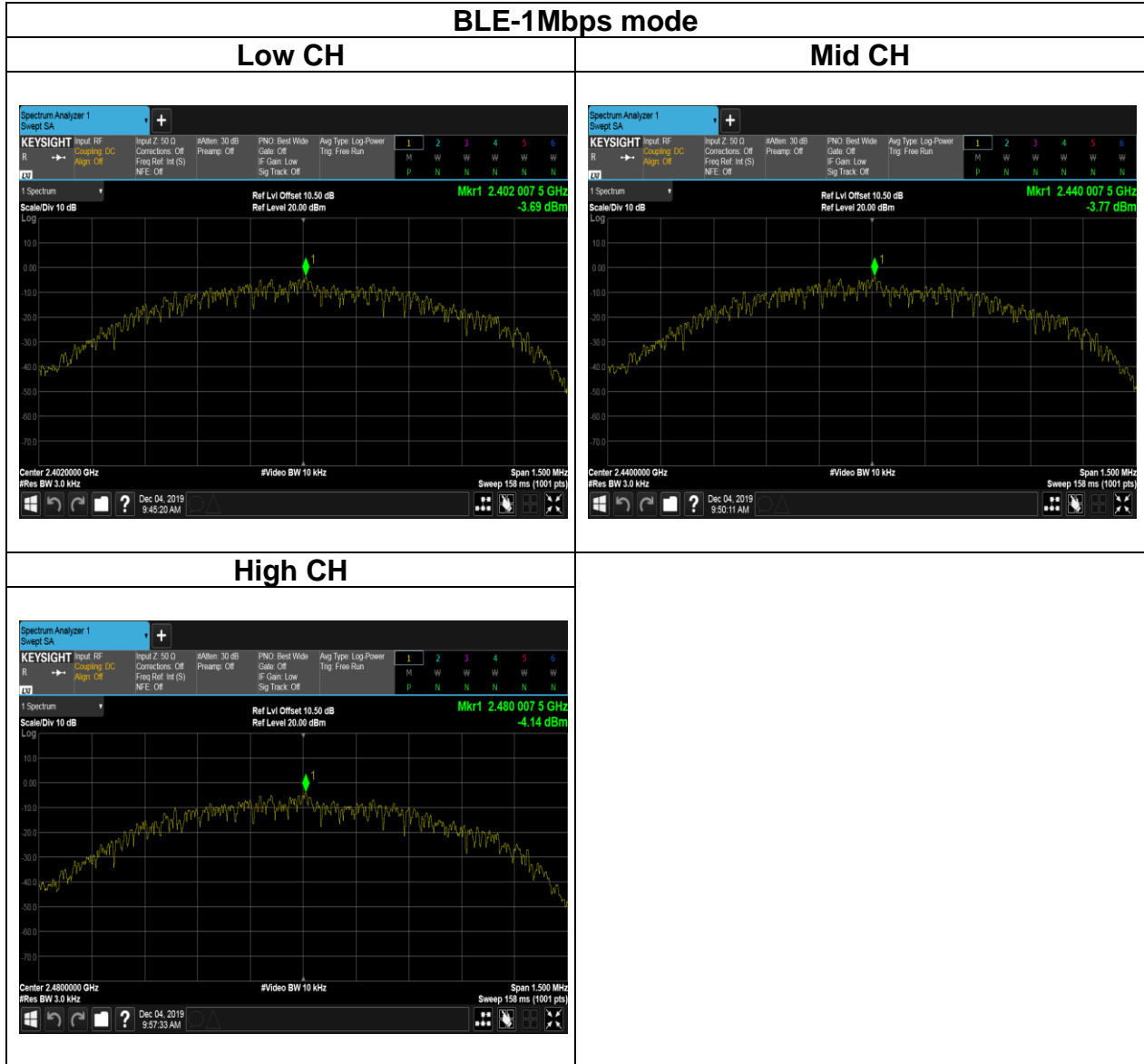

## 4.5 CONDUCTED BAND EDGE AND SPURIOUS EMISSION

### 4.5.1 Test Limit

According to §15.247(d) and RSS-247 section 5.5

**FCC:** In any 100 kHz bandwidth outside the authorized frequency band, Non-restricted bands shall be attenuated at least 20 dB/30 dB relative to the maximum PSD level in 100 kHz by RF conducted or a radiated measurement which fall in the restricted bands, as defined in §15.205(a), must also comply with the radiated emission limits specified in §15.209(a).

**IC:** In any 100 kHz bandwidth outside the frequency band in which the spread spectrum or digitally modulated device is operating, the RF power that is produced shall be at least 20 dB below that in the 100 kHz bandwidth within the band that contains the highest level of the desired power, based on either an RF conducted or a radiated measurement, provided that the transmitter demonstrates compliance with the peak conducted power limits. If the transmitter complies with the conducted power limits based on the use of root-mean-square averaging over a time interval, as permitted under section 5.4(d), the attenuation required shall be 30 dB instead of 20 dB. Attenuation below the general field strength limits specified in RSS-Gen is not required.

### 4.5.2 Test Procedure

Test method Refer as KDB 558074 D01.

1. EUT RF output port connected to the SA by RF cable, and the path loss was compensated to result.
2. SA setting, RBW=100kHz, VBW=300kHz, Detector=Peak, Trace mode = max hold, SWT = Auto.
3. In any 100 kHz bandwidth outside the authorized frequency band, shall be attenuated at least 20 dB relative to the maximum in-band peak PSD level in 100 kHz when conducted power procedure is used. If the transmitter complies with the conducted power limits based on the use of RMS averaging over a time interval, the attenuation required under this paragraph shall be 30 dB instead of 20 dB.

### 4.5.3 Test Setup

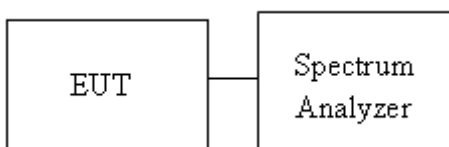

Report No.: T191120D05-RP2

### 4.5.4 Test Result

#### Test Data

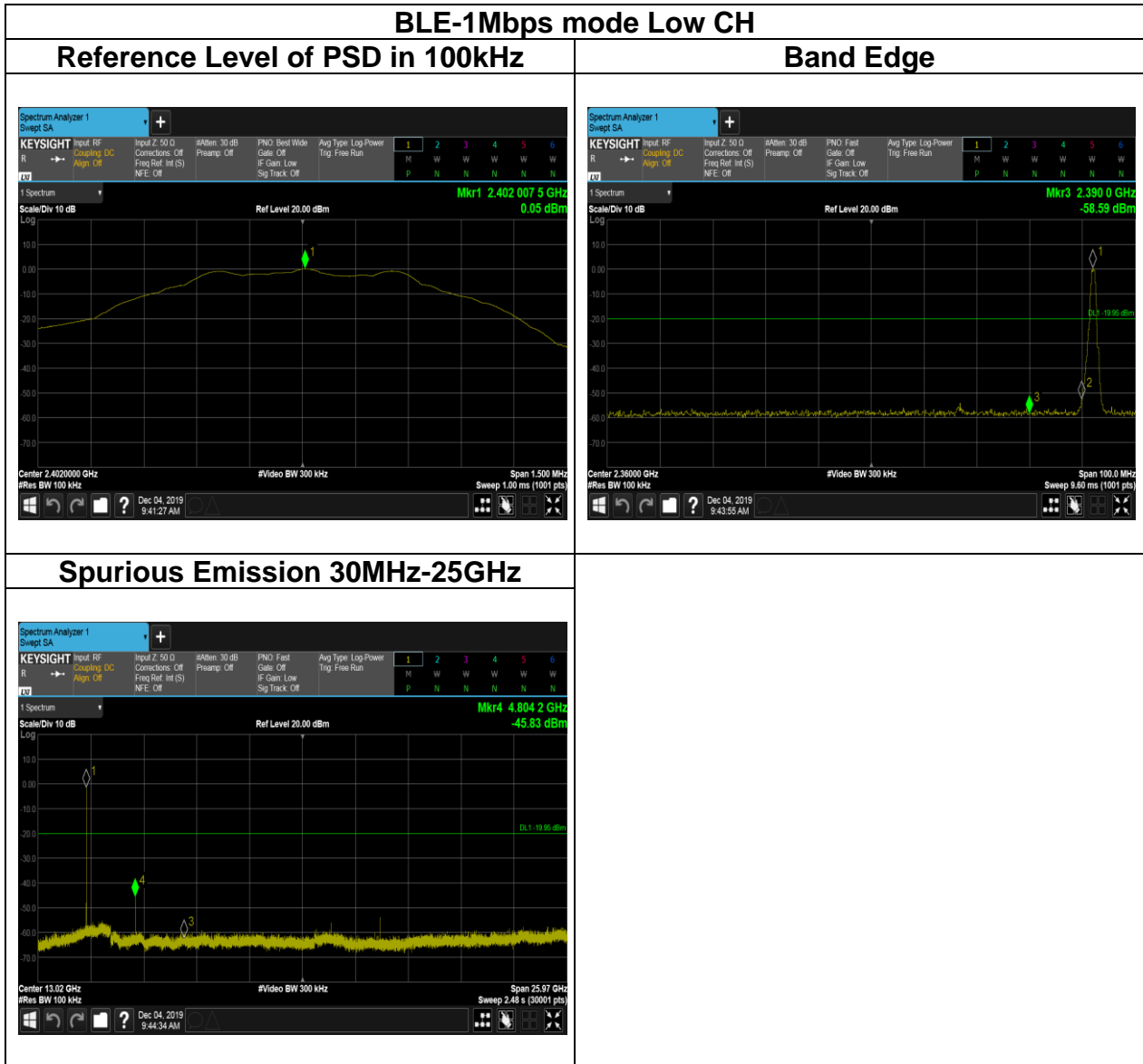

Report No.: T191120D05-RP2

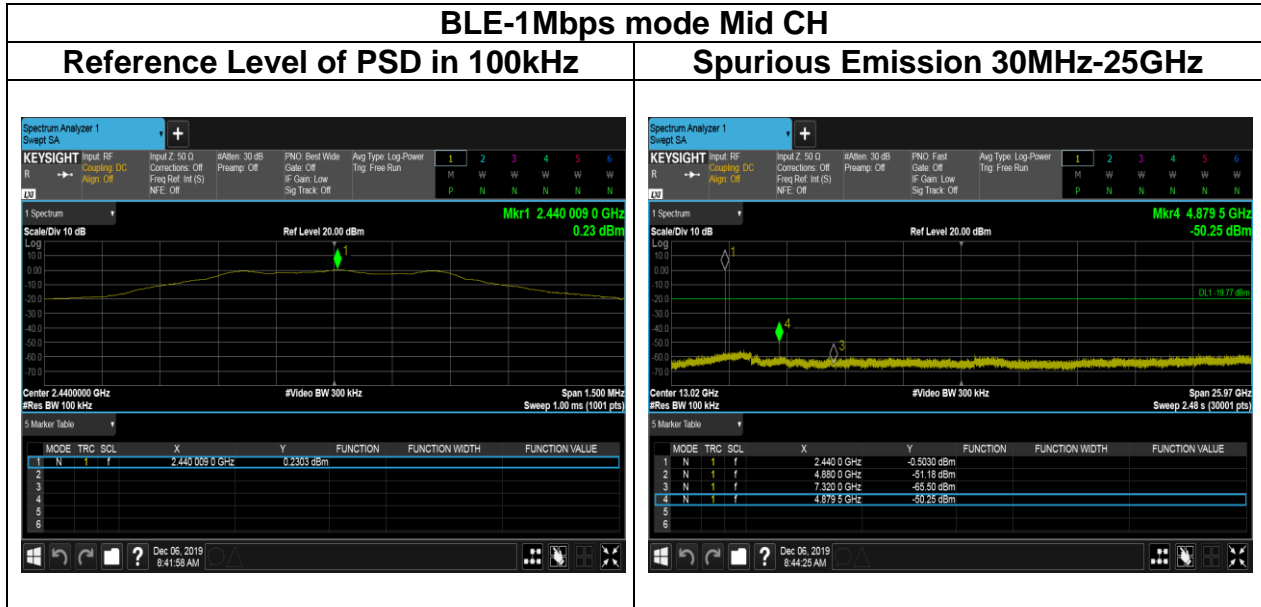

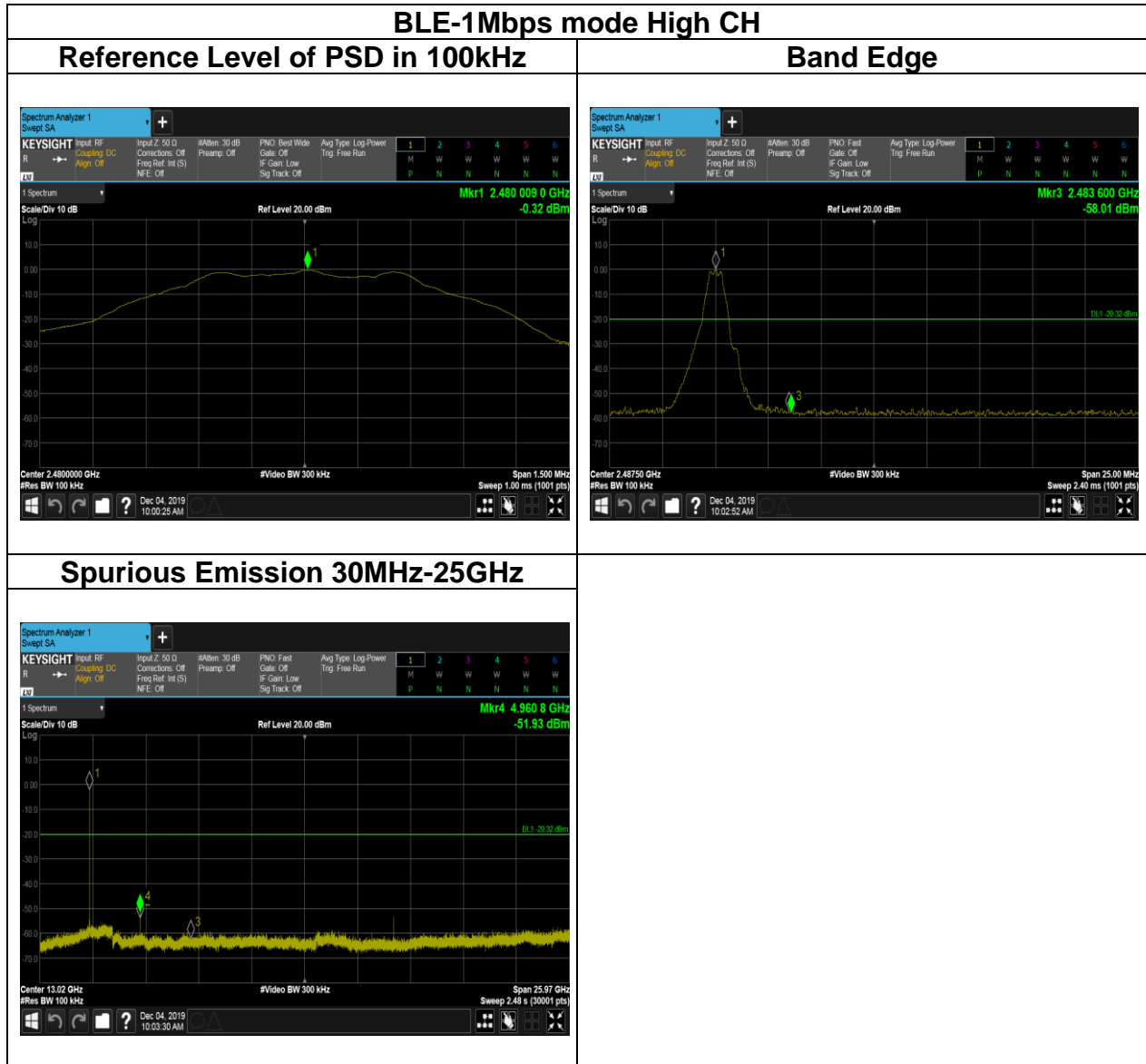



Report No.: T191120D05-RP2

## 4.6 RADIATION BANDEGE AND SPURIOUS EMISSION

### 4.6.1 Test Limit

FCC according to §15.247(d), §15.209 and §15.205,

In any 100 kHz bandwidth outside the authorized frequency band, all harmonic and spurious must be least 20 dB below the highest emission level with the authorized frequency band. Radiation emission which fall in the restricted bands must also follow the FCC section 15.209 as below limit in table.

#### Below 30 MHz

Frequency	Field Strength (microvolts/m)	Magnetic H-Field (microamperes/m)	Measurement Distance (metres)
9-490 kHz	2,400/F (F in kHz)	2,400/F (F in kHz)	300
490-1,705 kHz	24,000/F (F in kHz)	24,000/F (F in kHz)	30
1.705-30 MHz	30	N/A	30

#### Above 30 MHz

Frequency (MHz)	Field Strength microvolts/m at 3 metres (watts, e.i.r.p.)	
	Transmitters	Receivers
30-88	100 (3 nW)	100 (3 nW)
88-216	150 (6.8 nW)	150 (6.8 nW)
216-960	200 (12 nW)	200 (12 nW)
Above 960	500 (75 nW)	500 (75 nW)

Remark:

Although these tests were performed other than open area test site, adequate comparison measurements were confirmed against 30 m open are test site. Therefore sufficient tests were made to demonstrate that the alternative site produces results that correlate with the ones of tests made in an open field based on KDB 414788.

Report No.: T191120D05-RP2

IC according to RSS-247 section 5.5, RSS-Gen, Section 8.9 and 8.10

**RSS-Gen Table 3 and Table 5 – General Field Strength Limits for Transmitters and Receivers at Frequencies Above 30 MHz** <sup>(Note)</sup>

Frequency (MHz)	Field Strength microvolts/m at 3 metres (watts, e.i.r.p.)	
	Transmitters	Receivers
30-88	100 (3 nW)	100 (3 nW)
88-216	150 (6.8 nW)	150 (6.8 nW)
216-960	200 (12 nW)	200 (12 nW)
Above 960	500 (75 nW)	500 (75 nW)

**Note:** Measurements for compliance with the limits in table 3 may be performed at distances other than 3 metres, in accordance with Section 6.6.

**RSS-Gen Table 6: General Field Strength Limits for Transmitters at Frequencies Below 30 MHz (Transmit)**

Frequency	Magnetic field strength (H-Field) ( $\mu\text{A/m}$ )	Measurement Distance (m)
9-490 kHz <sup>Note</sup>	6.37/F (F in kHz)	300
490-1,705 kHz	63.7/F (F in kHz)	30
1.705-30 MHz	0.08	30

**Note:** The emission limits for the ranges 9-90 kHz and 110-490 kHz are based on measurements employing a linear average detector..

#### 4.6.2 Test Procedure

Test method Refer as KDB 558074 D01.

1. The EUT is placed on a turntable, Above 1 GHz is 1.5m and below 1 GHz is 0.8m above ground plane. The EUT Configured un accordance with ANSI C63.10: 2013, and the EUT set in a continuous mode.
2. The turntable shall be rotated for 360 degrees to determine the position of maximum emission level. And EUT is set 3m away from the receiving antenna, which is scanned from 1m to 4m above the ground plane to find out the highest emissions. Measurement are made polarized in both the vertical and the horizontal positions with antenna.
3. Span shall wide enough to full capture the emission measured. The SA from 9KHz to 26.5GHz set to the low, Mid and High channels with the EUT transmit.
4. The SA setting following :
  - (1) Below 1G : RBW = 100kHz, VBW  $\geq$  3 RBW, Sweep = Auto, Detector = Peak, Trace = Max hold.
  - (2) Above 1G :
    - (2.1) For Peak measurement : RBW = 1MHz, VBW  $\geq$  3 RBW, Sweep = Auto, Detector = Peak, Trace = Max hold.
    - (2.2) For Average measurement : RBW = 1MHz, VBW
      - If Duty Cycle  $\geq$  98%, VBW=10Hz.
      - If Duty Cycle < 98%, VBW=1/T.

Remark:

1. Although these tests were performed other than open area test site, adequate comparison measurements were confirmed against 30 m open are test site. Therefore sufficient tests were made to demonstrate that the alternative site produces results that correlate with the ones of tests made in an open field based on KDB 414788.
2. No emission found between lowest internal used/generated frequency to 30MHz (9kHz~30MHz).

### 4.6.3 Test Setup

#### 9kHz ~ 30MHz

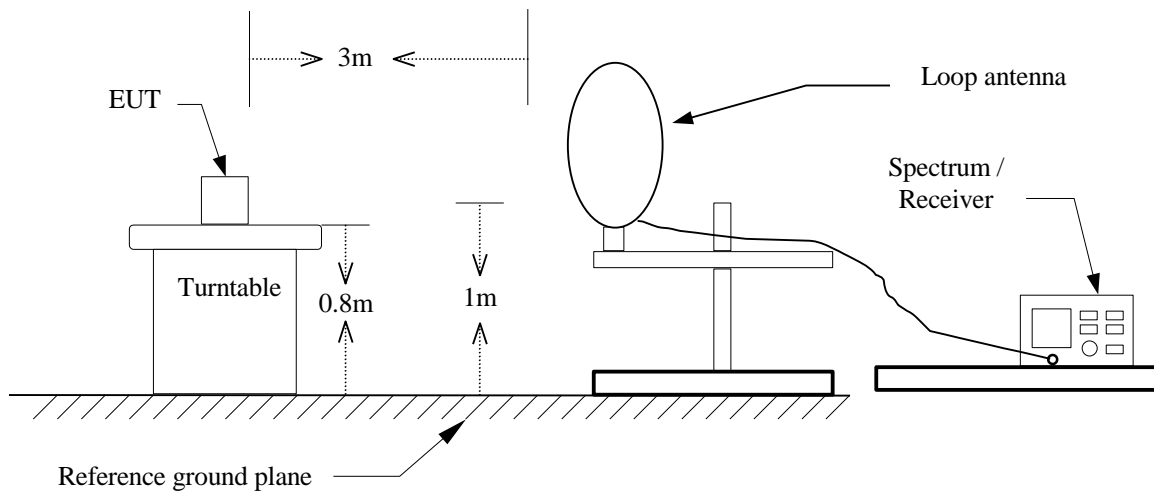

#### 30MHz ~ 1GHz

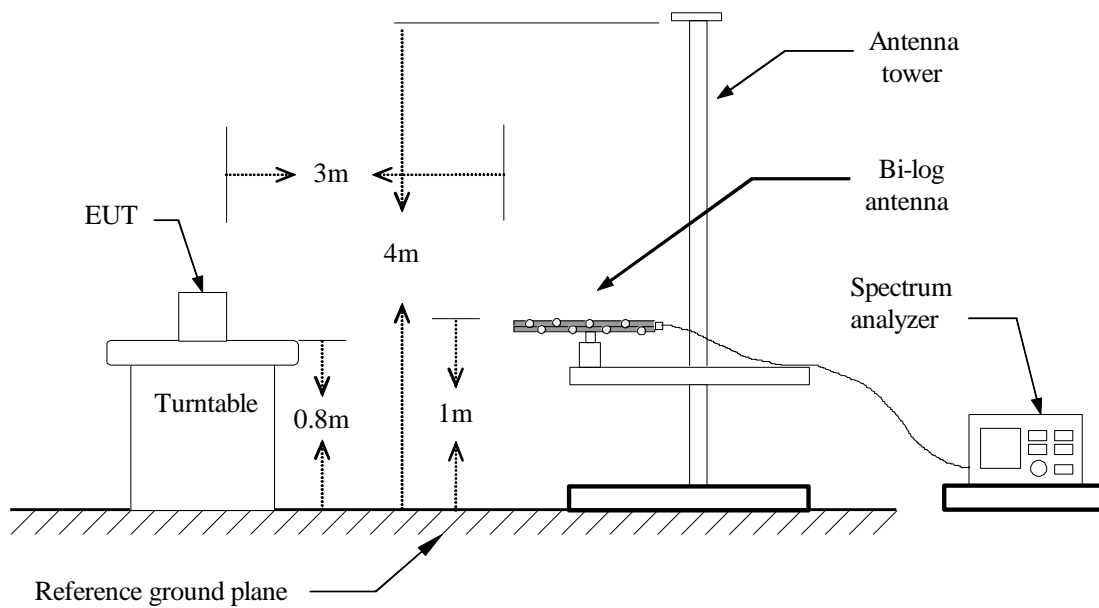

## Above 1 GHz

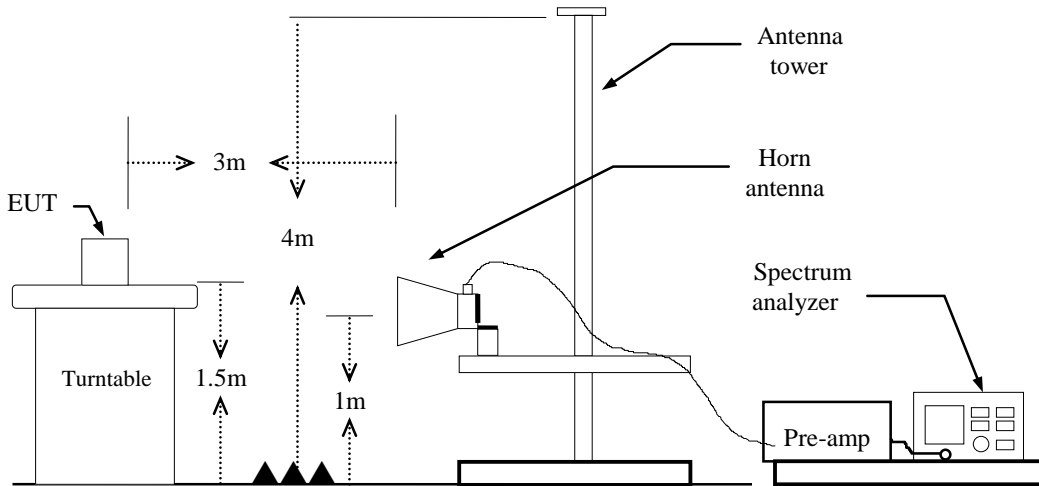

Report No.: T191120D05-RP2

### 4.6.4 Test Result

#### Band Edge Test Data

Test Mode:	BLE-1Mbps Low CH	Temp/Hum	18.6(°C)/ 53%RH
Test Item	Band Edge	Test Date	January 6, 2020
Polarize	Vertical	Test Engineer	Jerry Chang
Detector	Peak / Average		

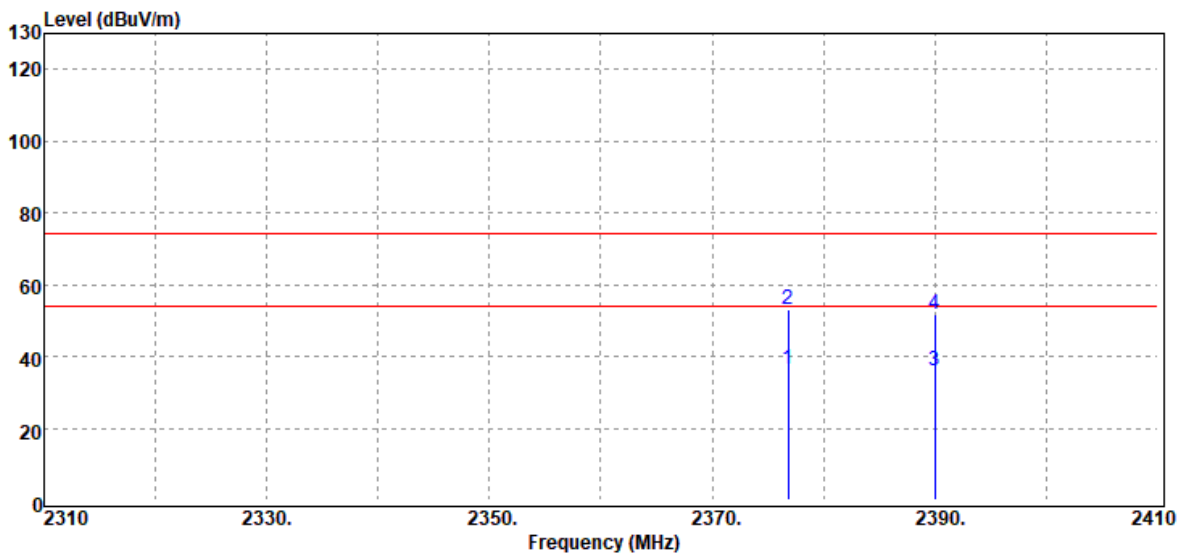

Freq. MHz	Detector Mode PK/QP/AV	Spectrum Reading Level dB $\mu$ V	Factor dB	Actual FS dB $\mu$ V/m	Limit @3m dB $\mu$ V/m	Margin dB
2376.80	Average	39.27	-2.82	36.45	54.00	-17.55
2376.80	Peak	56.07	-2.82	53.25	74.00	-20.75
2390.00	Average	38.86	-2.82	36.04	54.00	-17.96
2390.00	Peak	54.61	-2.82	51.79	74.00	-22.21

Report No.: T191120D05-RP2

Test Mode:	BLE-1Mbps Low CH	Temp/Hum	18.6(°C)/ 53%RH
Test Item	Band Edge	Test Date	January 6, 2020
Polarize	Horizontal	Test Engineer	Jerry Chang
Detector	Peak / Average		

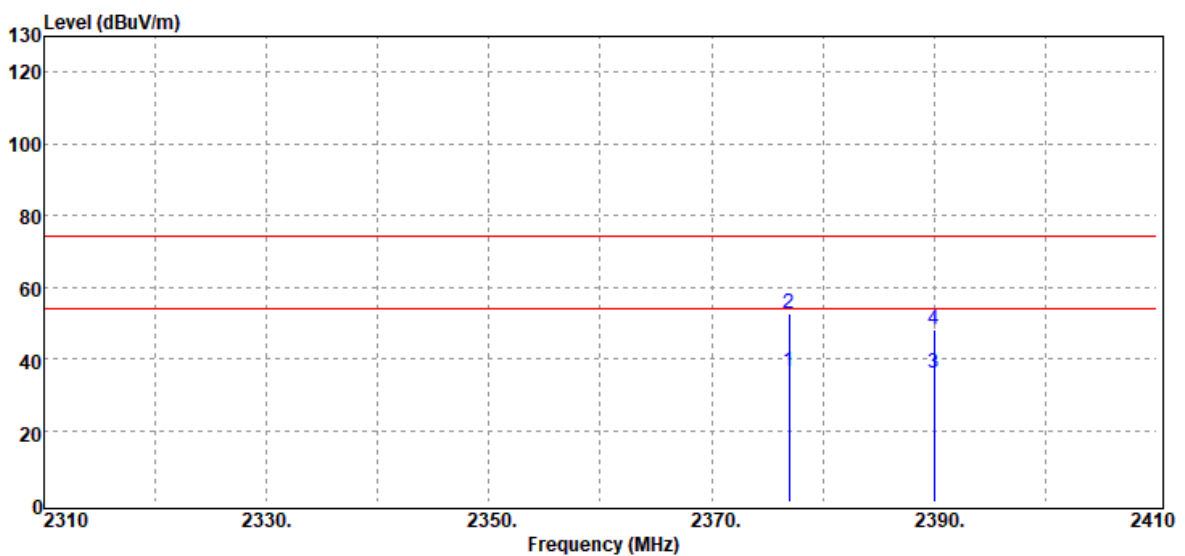

Freq. MHz	Detector Mode PK/QP/AV	Spectrum Reading Level dB $\mu$ V	Factor dB	Actual FS dB $\mu$ V/m	Limit @3m dB $\mu$ V/m	Margin dB
2377.00	Average	39.11	-2.82	36.29	54.00	-17.71
2377.00	Peak	55.31	-2.82	52.49	74.00	-21.51
2390.00	Average	38.95	-2.82	36.13	54.00	-17.87
2390.00	Peak	50.77	-2.82	47.95	74.00	-26.05

Report No.: T191120D05-RP2

Test Mode:	BLE-1Mbps High CH	Temp/Hum	18.6(°C)/ 53%RH
Test Item	Band Edge	Test Date	December 11, 2019
Polarize	Vertical	Test Engineer	Jerry Chang
Detector	Peak / Average		

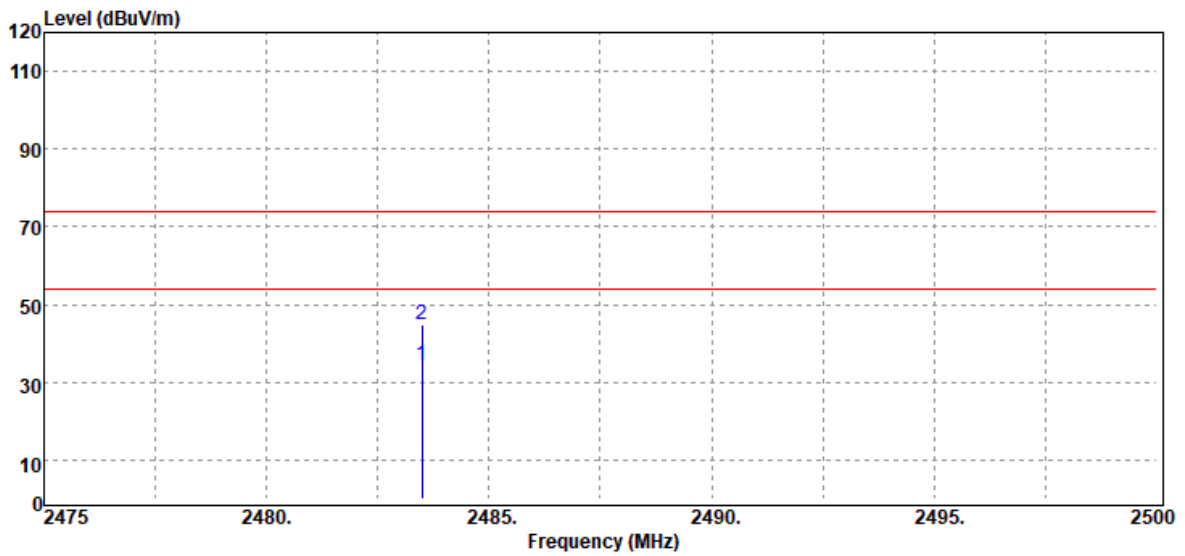

Freq. MHz	Detector Mode PK/QP/AV	Spectrum Reading Level dB $\mu$ V	Factor dB	Actual FS dB $\mu$ V/m	Limit @3m dB $\mu$ V/m	Margin dB
2483.50	Average	37.31	-2.83	34.48	54.00	-19.52
2483.50	Peak	47.55	-2.83	44.72	74.00	-29.28



Report No.: T191120D05-RP2

Test Mode:	BLE-1Mbps High CH	Temp/Hum	18.6(°C)/ 53%RH
Test Item	Band Edge	Test Date	December 11, 2019
Polarize	Horizontal	Test Engineer	Jerry Chang
Detector	Peak / Average		

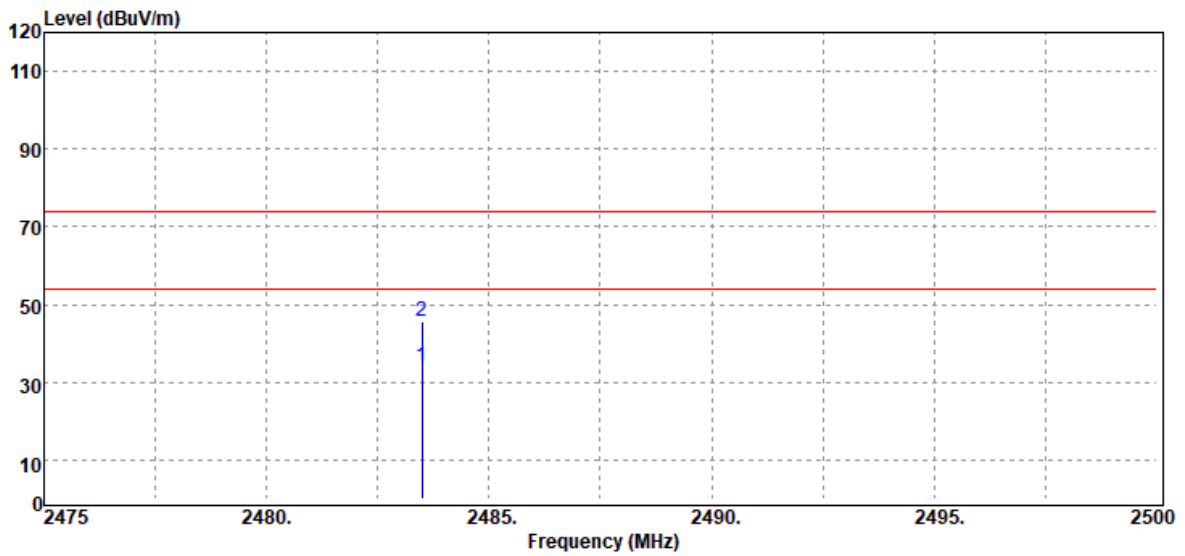

Freq. MHz	Detector Mode PK/QP/AV	Spectrum Reading Level dB $\mu$ V	Factor dB	Actual FS dB $\mu$ V/m	Limit @3m dB $\mu$ V/m	Margin dB
2483.50	Average	36.99	-2.83	34.16	54.00	-19.84
2483.50	Peak	48.46	-2.83	45.63	74.00	-28.37

Report No.: T191120D05-RP2

**Below 1G Test Data**

Test Mode:	BLE-1Mbps Mode	Temp/Hum	18.6(°C)/ 53%RH
Test Item	30MHz-1GHz	Test Date	January 6, 2020
Polarize	Vertical	Test Engineer	Jerry Chang
Detector	Peak		

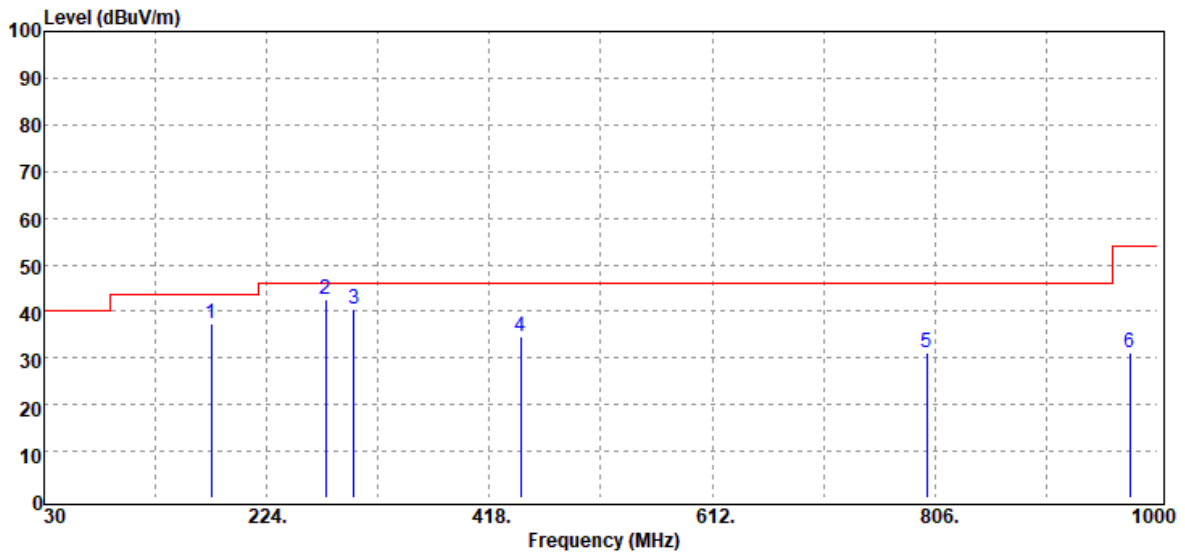

Freq. MHz	Detector Mode PK/QP/AV	Spectrum Reading Level dBuV	Factor dB	Actual FS dBuV/m	Limit @3m dBuV/m	Margin dB
175.50	Peak	48.41	-11.11	37.30	43.50	-6.20
275.41	Peak	51.10	-8.42	42.68	46.00	-3.32
299.66	Peak	48.66	-8.25	40.41	46.00	-5.59
445.16	Peak	38.70	-4.06	34.64	46.00	-11.36
799.21	Peak	29.58	1.52	31.10	46.00	-14.90
975.75	Peak	25.58	5.54	31.12	54.00	-22.88

Note: No emission found between lowest internal used/generated frequency to 30MHz (9kHz~30MHz).

Report No.: T191120D05-RP2

Test Mode:	BLE-1Mbps Mode	Temp/Hum	18.6(°C)/ 53%RH
Test Item	30MHz-1GHz	Test Date	January 6, 2020
Polarize	Horizontal	Test Engineer	Jerry Chang
Detector	Peak		

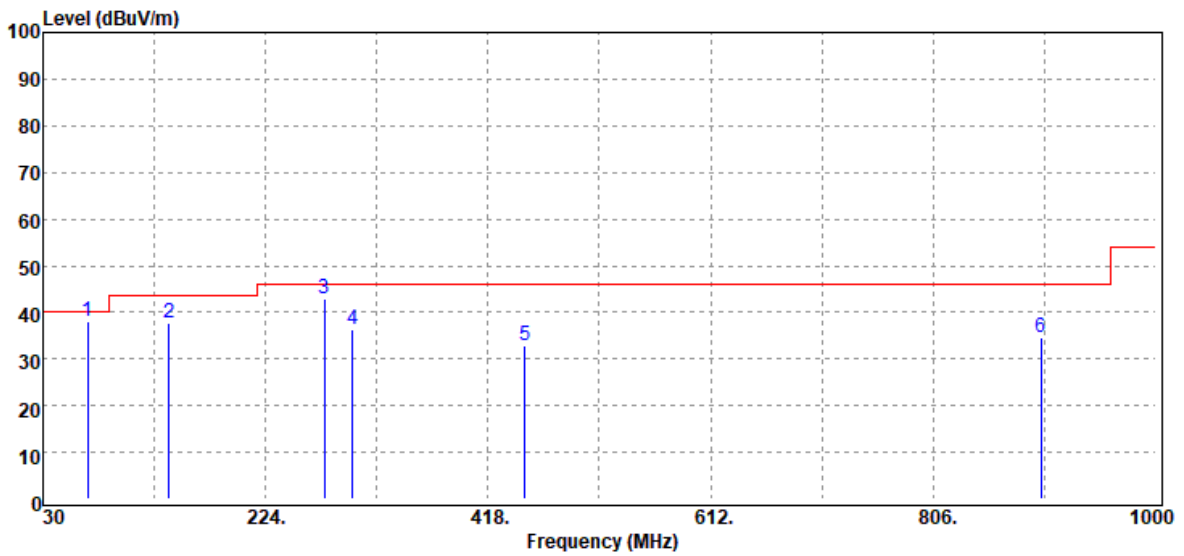

Freq. MHz	Detector Mode PK/QP/AV	Spectrum Reading Level dB $\mu$ V	Factor dB	Actual FS dB $\mu$ V/m	Limit @3m dB $\mu$ V/m	Margin dB
68.80	Peak	52.87	-14.93	37.94	40.00	-2.06
139.61	Peak	47.69	-9.82	37.87	43.50	-5.63
275.41	Peak	51.45	-8.42	43.03	46.00	-2.97
299.66	Peak	44.51	-8.25	36.26	46.00	-9.74
450.01	Peak	36.87	-3.88	32.99	46.00	-13.01
900.09	Peak	30.30	4.19	34.49	46.00	-11.51

Note: No emission found between lowest internal used/generated frequency to 30MHz (9kHz~30MHz).

Report No.: T191120D05-RP2

**Above 1G Test Data**

Test Mode:	BLE-1Mbps Low CH	Temp/Hum	18.6(°C)/ 53%RH
Test Item	Harmonic	Test Date	January 6, 2020
Polarize	Vertical	Test Engineer	Jerry Chang
Detector	Peak & Average		

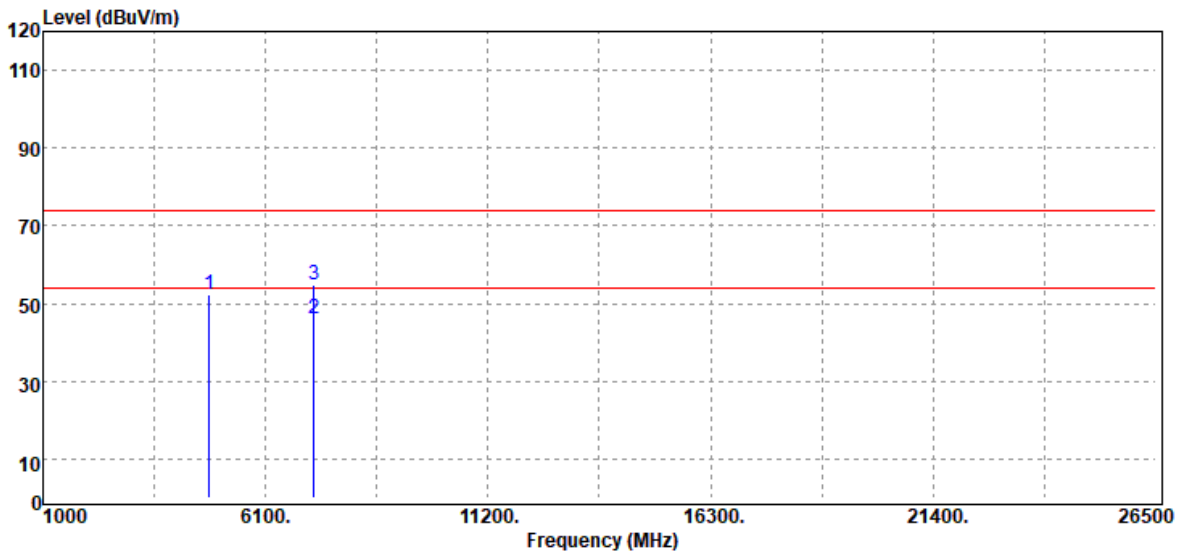

Freq. MHz	Detector Mode PK/QP/AV	Spectrum Reading Level dB $\mu$ V	Factor dB	Actual FS dB $\mu$ V/m	Limit @3m dB $\mu$ V/m	Margin dB
4804.00	Peak	48.57	3.56	52.13	74.00	-21.87
7206.00	Average	35.25	10.93	46.18	54.00	-7.82
7206.00	Peak	43.98	10.93	54.91	74.00	-19.09
N/A						

**Remark:**

1. Measuring frequencies from 1 GHz to the 10th harmonic of highest fundamental frequency.

Report No.: T191120D05-RP2

Test Mode:	BLE-1Mbps Low CH	Temp/Hum	18.6(°C)/ 53%RH
Test Item	Harmonic	Test Date	January 6, 2020
Polarize	Horizontal	Test Engineer	Jerry Chang
Detector	Peak & Average		

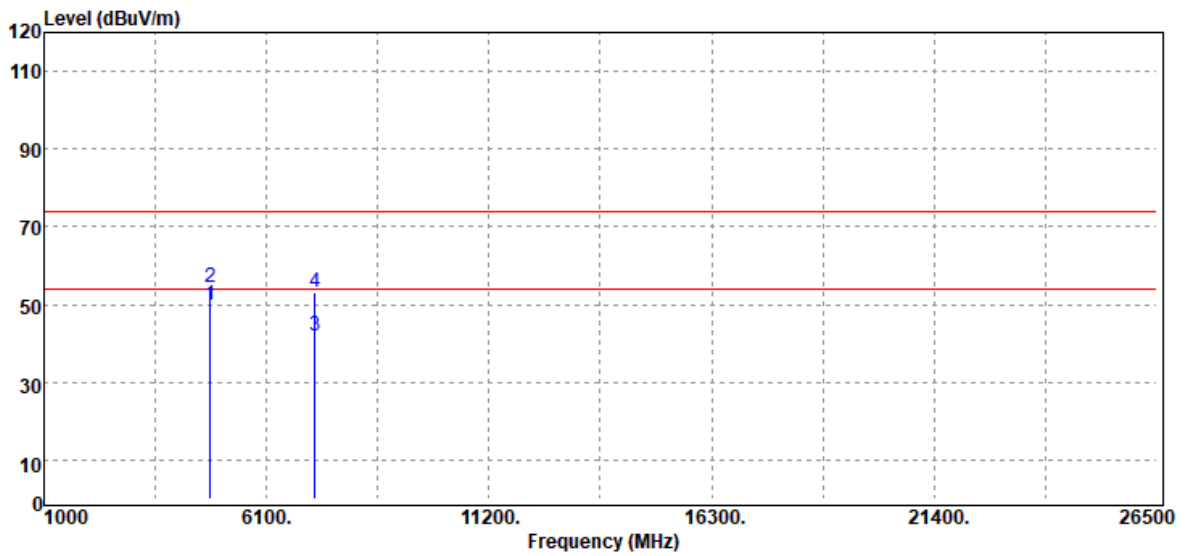

Freq. MHz	Detector Mode PK/QP/AV	Spectrum Reading Level dB $\mu$ V	Factor dB	Actual FS dB $\mu$ V/m	Limit @3m dB $\mu$ V/m	Margin dB
4804.00	Average	46.35	3.56	49.91	54.00	-4.09
4804.00	Peak	50.96	3.56	54.52	74.00	-19.48
7206.00	Average	31.19	10.93	42.12	54.00	-11.88
7206.00	Peak	42.34	10.93	53.27	74.00	-20.73

**Remark:**

- Measuring frequencies from 1 GHz to the 10th harmonic of highest fundamental frequency.

Report No.: T191120D05-RP2

Test Mode:	BLE-1Mbps Mid CH	Temp/Hum	18.6(°C)/ 53%RH
Test Item	Harmonic	Test Date	January 6, 2020
Polarize	Vertical	Test Engineer	Jerry Chang
Detector	Peak		

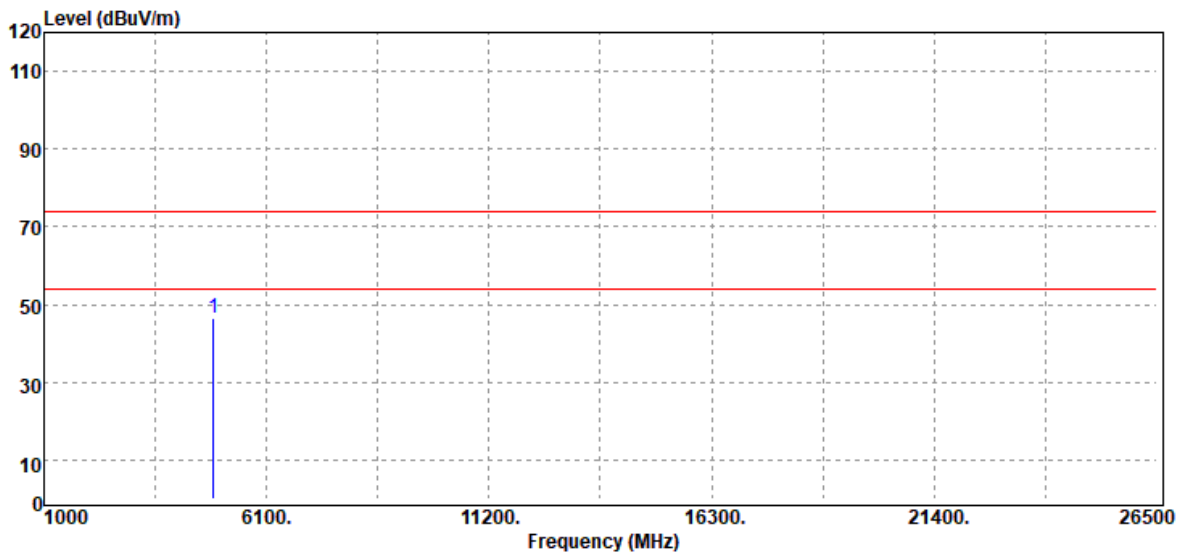

Freq. MHz	Detector Mode PK/QP/AV	Spectrum Reading Level dB $\mu$ V	Factor dB	Actual FS dB $\mu$ V/m	Limit @3m dB $\mu$ V/m	Margin dB
4880.00	Peak	42.53	3.77	46.30	74.00	-27.70
N/A						

**Remark:**

1. Measuring frequencies from 1 GHz to the 10th harmonic of highest fundamental frequency.
2. For above 1GHz, the EUT peak value was under average limit, therefore the Average value compliance with the average limit

Report No.: T191120D05-RP2

Test Mode:	BLE-1Mbps Mid CH	Temp/Hum	18.6(°C)/ 53%RH
Test Item	Harmonic	Test Date	January 6, 2020
Polarize	Horizontal	Test Engineer	Jerry Chang
Detector	Peak		

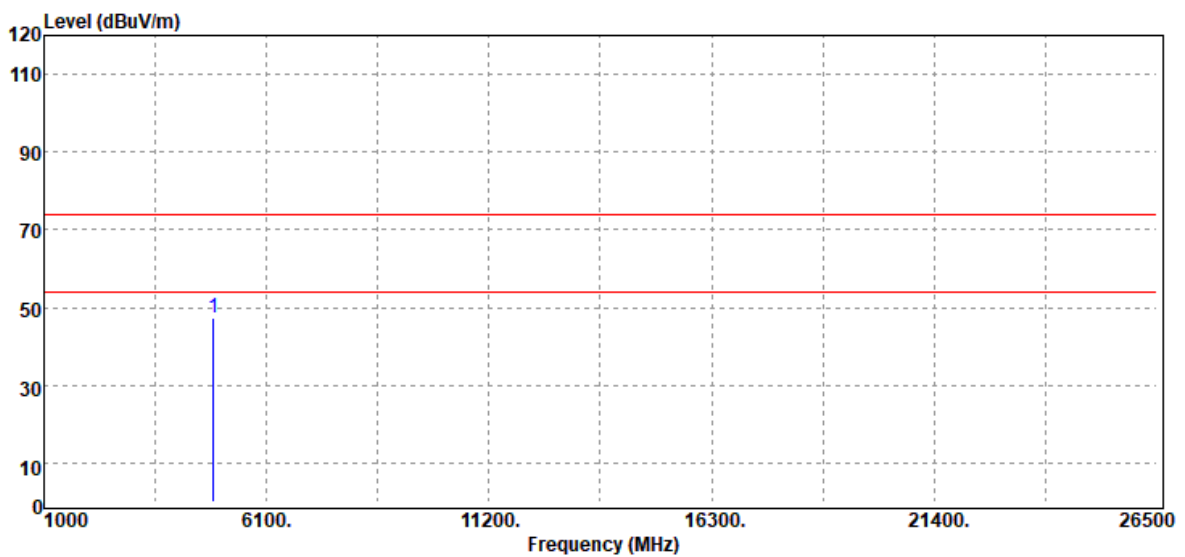

Freq. MHz	Detector Mode PK/QP/AV	Spectrum Reading Level dB $\mu$ V	Factor dB	Actual FS dB $\mu$ V/m	Limit @3m dB $\mu$ V/m	Margin dB
4880.00	Peak	43.54	3.77	47.31	74.00	-26.69
N/A						

**Remark:**

1. Measuring frequencies from 1 GHz to the 10th harmonic of highest fundamental frequency.
2. For above 1GHz, the EUT peak value was under average limit, therefore the Average value compliance with the average limit

Report No.: T191120D05-RP2

Test Mode:	BLE-1Mbps High CH	Temp/Hum	18.6(°C)/ 53%RH
Test Item	Harmonic	Test Date	January 6, 2020
Polarize	Vertical	Test Engineer	Jerry Chang
Detector	Peak		

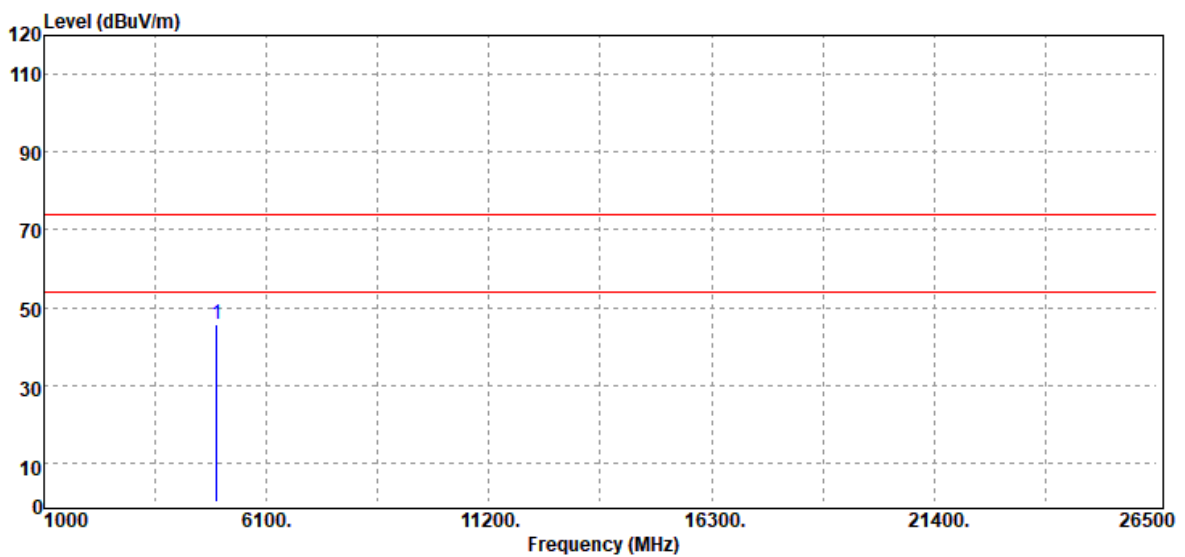

Freq. MHz	Detector Mode PK/QP/AV	Spectrum Reading Level dB $\mu$ V	Factor dB	Actual FS dB $\mu$ V/m	Limit @3m dB $\mu$ V/m	Margin dB
4960.00	Peak	41.90	3.85	45.75	74.00	-28.25
N/A						

**Remark:**

1. Measuring frequencies from 1 GHz to the 10th harmonic of highest fundamental frequency.
2. For above 1GHz, the EUT peak value was under average limit, therefore the Average value compliance with the average limit



Report No.: T191120D05-RP2

Test Mode:	BLE-1Mbps High CH	Temp/Hum	18.6(°C)/ 53%RH
Test Item	Harmonic	Test Date	January 6, 2020
Polarize	Horizontal	Test Engineer	Jerry Chang
Detector	Peak		

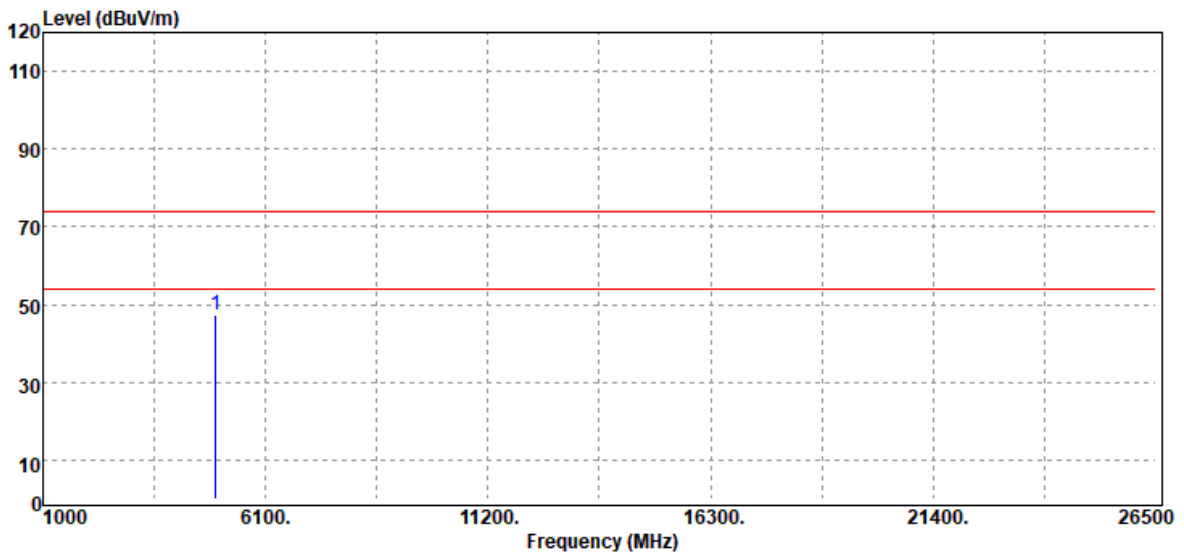

Freq. MHz	Detector Mode PK/QP/AV	Spectrum Reading Level dB $\mu$ V	Factor dB	Actual FS dB $\mu$ V/m	Limit @3m dB $\mu$ V/m	Margin dB
4960.00	Peak	43.30	3.85	47.15	74.00	-26.85
N/A						

**Remark:**

1. Measuring frequencies from 1 GHz to the 10th harmonic of highest fundamental frequency.
2. For above 1GHz, the EUT peak value was under average limit, therefore the Average value compliance with the average limit

**--End of Test Report--**