



A D T

# FCC TEST REPORT (15.247)

**REPORT NO.:** RF981212L01

**MODEL NO.:** SBG6580 Diagnostic  
(refer to item 3.1 for more detail)

**RECEIVED:** Dec. 14, 2009

**TESTED:** Dec. 23 ~ Dec. 29, 2009

**ISSUED:** Jan. 04, 2010

**APPLICANT:** GENERAL INSTRUMENT OF TAIWAN, LTD.

**ADDRESS:** 1, Lane 232 , Pao Chiao Road , Shin Dian,  
Taipei, Taiwan 231 , R.O.C.

**ISSUED BY:** Bureau Veritas Consumer Products Services  
(H.K.) Ltd., Taoyuan Branch

**LAB ADDRESS:** No. 47, 14th Ling, Chia Pau Tsuen, Lin Kou  
Hsiang, Taipei Hsien 244, Taiwan, R.O.C.

**TEST LOCATION:** No. 19, Hwa Ya 2nd Rd, Wen Hwa Tsuen, Kwei  
Shan Hsiang, Taoyuan Hsien 333, Taiwan,  
R.O.C.

This test report consists of 132 pages in total. It may be duplicated completely for legal use with the approval of the applicant. It should not be reproduced except in full, without the written approval of our laboratory. The client should not use it to claim product endorsement by TAF or any government agencies. The test results in the report only apply to the tested sample.





A D T

## TABLE OF CONTENTS

1.	CERTIFICATION.....	5
2.	SUMMARY OF TEST RESULTS .....	6
2.1	MEASUREMENT UNCERTAINTY.....	6
3.	GENERAL INFORMATION.....	7
3.1	GENERAL DESCRIPTION OF EUT .....	7
3.2	DESCRIPTION OF TEST MODES .....	9
3.2.1	CONFIGURATION OF SYSTEM UNDER TEST .....	9
3.2.2	TEST MODE APPLICABILITY AND TESTED CHANNEL DETAIL .....	10
3.3	GENERAL DESCRIPTION OF APPLIED STANDARDS .....	14
3.4	DESCRIPTION OF SUPPORT UNITS .....	14
4.	TEST TYPES AND RESULTS (FOR 2.4GHz BAND) .....	15
4.1	RADIATED EMISSION MEASUREMENT .....	15
4.1.1	LIMITS OF RADIATED EMISSION MEASUREMENT .....	15
4.1.2	TEST INSTRUMENTS.....	16
4.1.3	TEST PROCEDURES .....	17
4.1.4	DEVIATION FROM TEST STANDARD.....	17
4.1.5	TEST SETUP .....	18
4.1.6	EUT OPERATING CONDITIONS .....	18
4.1.7	TEST RESULTS .....	19
4.2	CONDUCTED EMISSION MEASUREMENT .....	35
4.2.1	LIMITS OF CONDUCTED EMISSION MEASUREMENT .....	35
4.2.2	TEST INSTRUMENTS.....	35
4.2.3	TEST PROCEDURES .....	36
4.2.4	DEVIATION FROM TEST STANDARD.....	36
4.2.5	TEST SETUP .....	37
4.2.6	EUT OPERATING CONDITIONS .....	37
4.2.7	TEST RESULTS .....	38
4.3	6dB BANDWIDTH MEASUREMENT .....	40
4.3.1	LIMITS OF 6dB BANDWIDTH MEASUREMENT .....	40
4.3.2	TEST INSTRUMENTS.....	40
4.3.3	TEST PROCEDURE.....	40
4.3.4	DEVIATION FROM TEST STANDARD.....	40
4.3.5	TEST SETUP .....	41
4.3.6	EUT OPERATING CONDITIONS .....	41
4.3.7	TEST RESULTS .....	42
4.4	MAXIMUM OUTPUT POWER .....	47
4.4.1	LIMITS OF MAXIMUM OUTPUT POWER MEASUREMENT.....	47
4.4.2	INSTRUMENTS.....	47
4.4.3	TEST PROCEDURES .....	47
4.4.4	DEVIATION FROM TEST STANDARD.....	48
4.4.5	TEST SETUP .....	48
4.4.6	EUT OPERATING CONDITIONS .....	48
4.4.7	TEST RESULTS .....	49
4.5	POWER SPECTRAL DENSITY MEASUREMENT.....	50
4.5.1	LIMITS OF POWER SPECTRAL DENSITY MEASUREMENT .....	50
4.5.2	TEST INSTRUMENTS.....	50
4.5.3	TEST PROCEDURE.....	50



A D T

4.5.4	DEVIATION FROM TEST STANDARD.....	51
4.5.5	TEST SETUP.....	51
4.5.6	EUT OPERATING CONDITION.....	51
4.5.7	TEST RESULTS .....	52
4.6	BAND EDGES MEASUREMENT .....	57
4.6.1	LIMITS OF BAND EDGES MEASUREMENT .....	57
4.6.2	TEST INSTRUMENTS.....	57
4.6.3	TEST PROCEDURE.....	58
4.6.4	DEVIATION FROM TEST STANDARD.....	58
4.6.5	EUT OPERATING CONDITION.....	58
4.6.6	TEST RESULTS .....	59
5.	TEST TYPES AND RESULTS (FOR 5.0GHz BAND).....	79
5.1	RADIATED EMISSION MEASUREMENT .....	79
5.1.1	LIMITS OF RADIATED EMISSION MEASUREMENT .....	79
5.1.2	TEST INSTRUMENTS.....	80
5.1.3	TEST PROCEDURES .....	81
5.1.4	DEVIATION FROM TEST STANDARD.....	81
5.1.5	TEST SETUP.....	82
5.1.6	EUT OPERATING CONDITIONS .....	82
5.1.7	TEST RESULTS .....	83
5.2	CONDUCTED EMISSION MEASUREMENT .....	95
5.2.1	LIMITS OF CONDUCTED EMISSION MEASUREMENT .....	95
5.2.2	TEST INSTRUMENTS.....	95
5.2.3	TEST PROCEDURES .....	96
5.2.4	DEVIATION FROM TEST STANDARD.....	96
5.2.5	TEST SETUP.....	97
5.2.6	EUT OPERATING CONDITIONS .....	97
5.2.7	TEST RESULTS .....	98
5.3	6dB BANDWIDTH MEASUREMENT.....	100
5.3.1	LIMITS OF 6dB BANDWIDTH MEASUREMENT .....	100
5.3.2	TEST INSTRUMENTS.....	100
5.3.3	TEST PROCEDURE.....	100
5.3.4	DEVIATION FROM TEST STANDARD.....	101
5.3.5	TEST SETUP.....	101
5.3.6	EUT OPERATING CONDITIONS .....	101
5.3.7	TEST RESULTS .....	102
5.4	MAXIMUM OUTPUT POWER.....	106
5.4.1	LIMITS OF MAXIMUM OUTPUT POWER MEASUREMENT.....	106
5.4.2	INSTRUMENTS.....	106
5.4.3	TEST PROCEDURES .....	106
5.4.4	DEVIATION FROM TEST STANDARD.....	107
5.4.5	TEST SETUP.....	107
5.4.6	EUT OPERATING CONDITIONS .....	107
5.4.7	TEST RESULTS .....	108
5.5	POWER SPECTRAL DENSITY MEASUREMENT.....	109
5.5.1	LIMITS OF POWER SPECTRAL DENSITY MEASUREMENT .....	109
5.5.2	TEST INSTRUMENTS.....	109
5.5.3	TEST PROCEDURE.....	109
5.5.4	DEVIATION FROM TEST STANDARD.....	110
5.5.5	TEST SETUP.....	110



**A D T**

5.5.6	EUT OPERATING CONDITION.....	110
5.5.7	TEST RESULTS .....	111
5.6	BAND EDGES MEASUREMENT .....	115
5.6.1	LIMITS OF BAND EDGES MEASUREMENT .....	115
5.6.2	TEST INSTRUMENTS.....	115
5.6.3	TEST PROCEDURE.....	116
5.6.4	DEVIATION FROM TEST STANDARD.....	116
5.6.5	EUT OPERATING CONDITION.....	116
5.6.6	TEST RESULTS .....	117
6.	PHOTOGRAPHS OF THE TEST CONFIGURATION.....	130
7.	INFORMATION ON THE TESTING LABORATORIES .....	131
8.	APPENDIX A - MODIFICATIONS RECORDERS FOR ENGINEERING CHANGES TO THE EUT BY THE LAB .....	132



A D T

## 1. CERTIFICATION

**PRODUCT:** DOCSIS 3.0 Wi-Fi Gateway

**MODEL NO.:** SBG6580 Diagnostic (refer to item 3.1 for more detail)

**BRAND:** MOTOROLA

**APPLICANT:** GENERAL INSTRUMENT OF TAIWAN, LTD.

**TEST SAMPLE:** ENGINEERING SAMPLE

**TESTED:** Dec. 23 ~ Dec. 29, 2009

**STANDARDS:** FCC Part 15, Subpart C (Section 15.247)

ANSI C63.4-2003

The above equipment (Model: SBG6580 Diagnostic) has been tested by **Bureau Veritas Consumer Products Services (H.K.) Ltd., Taoyuan Branch**, and found compliance with the requirement of the above standards. The test record, data evaluation & Equipment Under Test (EUT) configurations represented herein are true and accurate accounts of the measurements of the sample's EMC characteristics under the conditions specified in this report.

**PREPARED BY** : Andrea Hsia , **DATE:** Jan. 04, 2010  
Andrea Hsia / Specialist

**TECHNICAL ACCEPTANCE** : Long Chen , **DATE:** Jan. 04, 2010  
Responsible for RF Long Chen / Senior Engineer

**APPROVED BY** : Gary Chang , **DATE:** Jan. 04, 2010  
Gary Chang / Assistant Manager

## 2. SUMMARY OF TEST RESULTS

The EUT has been tested according to the following specifications:

<b>APPLIED STANDARD: FCC PART 15, SUBPART C (SECTION 15.247)</b>			
<b>STANDARD SECTION</b>	<b>TEST TYPE AND LIMIT</b>	<b>RESULT</b>	<b>REMARK</b>
15.207	AC Power Conducted Emission	PASS	Meet the requirement of limit. Minimum passing margin is -13.75dB at 0.158MHz
15.247(a)(2)	Spectrum Bandwidth of a Direct Sequence Spread Spectrum System Limit: min. 500kHz	PASS	Meet the requirement of limit.
15.247(b)	Maximum Peak Output Power Limit: max. 30dBm	PASS	Meet the requirement of limit.
15.247(d)	Radiated Emissions Limit: Table 15.209	PASS	Meet the requirement of limit. Minimum passing margin is -1.0dB at 2500.00MHz
15.247(e)	Power Spectral Density Limit: max. 8dBm	PASS	Meet the requirement of limit.
15.247(d)	Band Edge Measurement Limit: 20dB less than the peak value of fundamental frequency	PASS	Meet the requirement of limit.
15.203	Antenna Requirement	PASS	Antenna connector is UFL not a standard connector.

### 2.1 MEASUREMENT UNCERTAINTY

Where relevant, the following measurement uncertainty levels have been estimated for tests performed on the EUT as specified in CISPR 16-4-2:

<b>MEASUREMENT</b>	<b>FREQUENCY</b>	<b>UNCERTAINTY</b>
Conducted emissions	9kHz~30MHz	2.44 dB
Radiated emissions	30MHz ~ 200MHz	2.93 dB
	200MHz ~1000MHz	2.95 dB
	1GHz ~ 18GHz	2.26 dB
	18GHz ~ 40GHz	1.94 dB

This uncertainty represents an expanded uncertainty expressed at approximately the 95% confidence level using a coverage factor of  $k = 2$ .



### 3. GENERAL INFORMATION

#### 3.1 GENERAL DESCRIPTION OF EUT

<b>PRODUCT</b>	DOCSIS 3.0 Wi-Fi Gateway
<b>MODEL NO.</b>	SBG6580 Diagnostic
<b>FCC ID</b>	W5H5BG6580
<b>POWER SUPPLY</b>	12Vdc
<b>MODULATION TYPE</b>	CCK, DQPSK, DBPSK for DSSS 64QAM, 16QAM, QPSK, BPSK for OFDM
<b>MODULATION TECHNOLOGY</b>	DSSS, OFDM
<b>TRANSFER RATE</b>	802.11b: 11.0/ 5.5/ 2.0/ 1.0Mbps 802.11g: 54.0/ 48.0/ 36.0/ 24.0/ 18.0/ 12.0/ 9.0/ 6.0Mbps 802.11a: 54.0/ 48.0/ 36.0/ 24.0/ 18.0/ 12.0/ 9.0/ 6.0Mbps 802.11n: up to 300.0Mbps
<b>OPERATING FREQUENCY</b>	2.4GHz: 2412.0 ~ 2462.0MHz 5.0GHz: 5745.0 ~ 5825.0MHz
<b>NUMBER OF CHANNEL</b>	2.4GHz: 11 for 802.11b, 802.11g, 802.11n (20MHz) 7 for 802.11n (40MHz) 5.0GHz: 5 for 802.11a, 802.11n (20MHz) 2 for 802.11n (40MHz)
<b>OUTPUT POWER</b>	249.1mW for 2412.0 ~ 2462.0MHz 378.8mW for 5745.0 ~ 5825.0MHz
<b>ANTENNA TYPE</b>	2.4GHz: Printed antenna with 3.5dBi gain (Antenna A) Printed antenna with 5.2dBi gain (Antenna B) 5.0GHz: Printed antenna with 4.0dBi gain (Antenna A) Printed antenna with 5.5dBi gain (Antenna B)
<b>ANTENNA CONNECTOR</b>	UFL
<b>DATA CABLE</b>	1.8m non-shielded RJ45 cable without core 1.5m non-shielded Diag cable without core
<b>I/O PORTS</b>	Refer to User's manual
<b>ASSOCIATED DEVICES</b>	Adapter

**NOTE:**

1. All models are list as below:

Brand Name	Model Name	Remark
MOTOROLA	SBG6580	without Diagnostic port
	SBG6580 Diagnostic	with Diagnostic port

\*\*After pre-tested found model: SBG6580 Diagnostic was the worst. Therefore chosen for final test and presented in the test report.

2. The EUT is a DOCSIS 3.0 Wi-Fi Gateway. The functions of EUT listed as below:

	TEST STANDARD	REFERENCE REPORT
WLAN 802.11b/g, 802.11n	FCC Part 15, Subpart C (Section 15.247)	RF981212L01
WLAN 802.11a, 802.11n (5745~5825 MHz)		
WLAN 802.11a, 802.11n (5180~ 5240MHz)	FCC Part 15, Subpart E (Section 15.407)	RF981212L01-1

3. The frequency bands used in this EUT are listed as follows:

Frequency Band (MHz)	2412~2462	5180~5240	5745~5825
802.11b	√		
802.11g	√		
802.11a		√	√
802.11n (20MHz)	√	√	√
802.11n (40MHz)	√	√	√

4. The EUT incorporates a MIMO function. Physically, the EUT provides two completed transmitters and two receivers.

MODULATION MODE	TX FUNCTION	TX ANTENNA
802.11b	1TX	Only Ant A
802.11g	1TX	Ant A or B
802.11a	1TX	Ant A or B
Draft 802.11n (20MHz)	2TX	2 TX : Ant A & B
Draft 802.11n (40MHz)	2TX	2 TX : Ant A & B

5. The EUT was powered by the following adapter:

<b>BRAND:</b>	DELTA
<b>MODEL:</b>	EADP-24MB A
<b>INPUT:</b>	100-240Vac, 50-60Hz, 0.6A
<b>OUTPUT:</b>	12Vdc, 2A
<b>POWER LINE:</b>	AC 1.8m non-shielded cable without core DC 1.5m non-shielded cable without core

6. The above EUT information was declared by manufacturer and for more detailed features description, please refer to the manufacturer's specifications or user's manual.



### 3.2 DESCRIPTION OF TEST MODES

#### FOR 2.4GHz:

11 channels are provided for 802.11b, 802.11g and 802.11n (20MHz):

CHANNEL	FREQUENCY	CHANNEL	FREQUENCY
1	2412MHz	7	2442MHz
2	2417MHz	8	2447MHz
3	2422MHz	9	2452MHz
4	2427MHz	10	2457MHz
5	2432MHz	11	2462MHz
6	2437MHz		

7 channels are provided for 802.11n (40MHz):

CHANNEL	FREQUENCY	CHANNEL	FREQUENCY
1	2422MHz	5	2442MHz
2	2427MHz	6	2447MHz
3	2432MHz	7	2452MHz
4	2437MHz		

#### FOR 5.0GHz (5725 ~ 5850MHz):

5 channels are provided for 802.11a and 802.11n (20MHz):

CHANNEL	FREQUENCY	CHANNEL	FREQUENCY
149	5745MHz	161	5805MHz
153	5765MHz	165	5825MHz
157	5785MHz		

2 channels are provided for 802.11n (40MHz):

CHANNEL	FREQUENCY	CHANNEL	FREQUENCY
151	5755MHz	159	5795MHz

#### 3.2.1 CONFIGURATION OF SYSTEM UNDER TEST

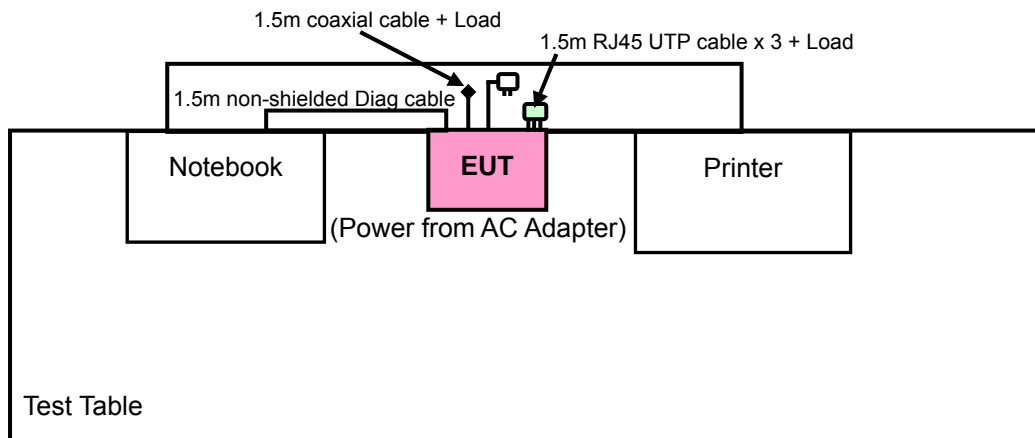

### 3.2.2 TEST MODE APPLICABILITY AND TESTED CHANNEL DETAIL

#### FOR 2.400 ~ 2.4835GHz:

EUT CONFIGURE MODE	APPLICABLE TO				DESCRIPTION
	RE $\geq$ 1G	RE<1G	PLC	APCM	
-	√	√	√	√	-

Where **RE $\geq$ 1G**: Radiated Emission above 1GHz      **RE<1G**: Radiated Emission below 1GHz  
**PLC**: Power Line Conducted Emission      **APCM**: Antenna Port Conducted Measurement

#### RADIATED EMISSION TEST (ABOVE 1GHz):

- Pre-Scan has been conducted to determine the worst-case mode from all possible combinations between available modulations, XYZ axis and antenna ports (if EUT with antenna diversity architecture).
- Following channel(s) was (were) selected for the final test as listed below.

MODE	AVAILABLE CHANNEL	TESTED CHANNEL	MODULATION TECHNOLOGY	MODULATION TYPE	DATA RATE (Mbps)	AXIS	ANT.
802.11b	1 to 11	1, 6, 11	DSSS	DBPSK	1.0	Z	A
802.11g	1 to 11	1, 6, 11	OFDM	BPSK	6.0	Z	A
802.11g	1 to 11	1, 6, 11	OFDM	BPSK	6.0	Z	B
802.11n (20MHz)	1 to 11	1, 6, 11	OFDM	BPSK	7.2	Z	A+B
802.11n (40MHz)	1 to 7	1, 4, 7	OFDM	BPSK	15.0	Z	A+B

#### RADIATED EMISSION TEST (BELOW 1GHz):

- Pre-Scan has been conducted to determine the worst-case mode from all possible combinations between available modulations, XYZ axis and antenna ports (if EUT with antenna diversity architecture).
- Following channel(s) was (were) selected for the final test as listed below.

MODE	AVAILABLE CHANNEL	TESTED CHANNEL	MODULATION TECHNOLOGY	MODULATION TYPE	DATA RATE (Mbps)	AXIS	ANT.
802.11n (40MHz)	1 to 7	1	OFDM	BPSK	15.0	Z	A+B

#### POWER LINE CONDUCTED EMISSION TEST:

- Pre-Scan has been conducted to determine the worst-case mode from all possible combinations between available modulations, data rates and antenna ports (if EUT with antenna diversity architecture).
- Following channel(s) was (were) selected for the final test as listed below.

MODE	AVAILABLE CHANNEL	TESTED CHANNEL	MODULATION TECHNOLOGY	MODULATION TYPE	DATA RATE (Mbps)	ANT.
802.11n (40MHz)	1 to 7	1	OFDM	BPSK	15.0	A+B



**BANDEDGE MEASUREMENT:**

- Pre-Scan has been conducted to determine the worst-case mode from all possible combinations between available modulations, data rates and antenna ports (if EUT with antenna diversity architecture).
- Following channel(s) was (were) selected for the final test as listed below.

MODE	AVAILABLE CHANNEL	TESTED CHANNEL	MODULATION TECHNOLOGY	MODULATION TYPE	DATA RATE (Mbps)	ANT.
802.11b	1 to 11	1, 11	DSSS	DBPSK	1.0	A
802.11g	1 to 11	1, 11	OFDM	BPSK	6.0	A
802.11g	1 to 11	1, 11	OFDM	BPSK	6.0	B
802.11n (20MHz)	1 to 11	1, 11	OFDM	BPSK	7.2	A+B
802.11n (40MHz)	1 to 7	1, 7	OFDM	BPSK	15.0	A+B

**ANTENNA PORT CONDUCTED MEASUREMENT:**

- This item includes all test value of each mode, but only includes spectrum plot of worst value of each mode.
- Pre-Scan has been conducted to determine the worst-case mode from all possible combinations between available modulations, data rates and antenna ports (if EUT with antenna diversity architecture).
- Following channel(s) was (were) selected for the final test as listed below.

MODE	AVAILABLE CHANNEL	TESTED CHANNEL	MODULATION TECHNOLOGY	MODULATION TYPE	DATA RATE (Mbps)	ANT.
802.11b	1 to 11	1, 6, 11	DSSS	DBPSK	1.0	A
802.11g	1 to 11	1, 6, 11	OFDM	BPSK	6.0	A
802.11g	1 to 11	1, 6, 11	OFDM	BPSK	6.0	B
802.11n (20MHz)	1 to 11	1, 6, 11	OFDM	BPSK	7.2	A+B
802.11n (40MHz)	1 to 7	1, 4, 7	OFDM	BPSK	15.0	A+B

**TEST CONDITION:**

APPLICABLE TO	ENVIRONMENTAL CONDITIONS	INPUT POWER (SYSTEM)	TESTED BY
RE≥1G	21deg. C, 65%RH, 999 hPa	120Vac, 60Hz	Sun Lin, Lori Chiu
RE<1G	15deg. C, 63%RH, 999 hPa	120Vac, 60Hz	Lori Chiu
PLC	23deg. C, 70%RH, 988 hPa	120Vac, 60Hz	Mick Chou
APCM	22deg. C, 61%RH, 999 hPa	120Vac, 60Hz	Dean Wang



A D T

**FOR 5.725 ~ 5.850GHz:**

EUT CONFIGURE MODE	APPLICABLE TO				DESCRIPTION
	PLC	RE<1G	RE≥1G	APCM	
-	√	√	√	√	-

Where **PLC:** Power Line Conducted Emission      **RE<1G:** Radiated Emission below 1GHz  
**RE≥1G:** Radiated Emission above 1GHz      **APCM:** Antenna Port Conducted Measurement

**RADIATED EMISSION TEST (ABOVE 1GHz):**

- Pre-Scan has been conducted to determine the worst-case mode from all possible combinations between available modulations, XYZ axis and antenna ports (if EUT with antenna diversity architecture).
- Following channel(s) was (were) selected for the final test as listed below.

MODE	AVAILABLE CHANNEL	TESTED CHANNEL	MODULATION TECHNOLOGY	MODULATION TYPE	DATA RATE (Mbps)	AXIS	ANT.
802.11a	149 to 165	149, 157, 165	OFDM	BPSK	6.0	Z	A
802.11a	149 to 165	149, 157, 165	OFDM	BPSK	6.0	Z	B
802.11n (20MHz)	149 to 165	149, 157, 165	OFDM	BPSK	7.2	Z	A+B
802.11n (40MHz)	151 to 159	151, 159	OFDM	BPSK	15.0	Z	A+B

**RADIATED EMISSION TEST (BELOW 1GHz):**

- Pre-Scan has been conducted to determine the worst-case mode from all possible combinations between available modulations, data rates and antenna ports (if EUT with antenna diversity architecture).
- Following channel(s) was (were) selected for the final test as listed below.

MODE	AVAILABLE CHANNEL	TESTED CHANNEL	MODULATION TECHNOLOGY	MODULATION TYPE	DATA RATE (Mbps)	AXIS	ANT.
802.11n (20MHz)	149 to 165	149	OFDM	BPSK	7.2	Z	A+B

**POWER LINE CONDUCTED EMISSION TEST:**

- Pre-Scan has been conducted to determine the worst-case mode from all possible combinations between available modulations, data rates and antenna ports (if EUT with antenna diversity architecture).
- Following channel(s) was (were) selected for the final test as listed below.

MODE	AVAILABLE CHANNEL	TESTED CHANNEL	MODULATION TECHNOLOGY	MODULATION TYPE	DATA RATE (Mbps)	ANT.
802.11n (20MHz)	149 to 165	149	OFDM	BPSK	7.2	A+B



**BANDEDGE MEASUREMENT:**

- Pre-Scan has been conducted to determine the worst-case mode from all possible combinations between available modulations, data rates and antenna ports (if EUT with antenna diversity architecture).
- Following channel(s) was (were) selected for the final test as listed below.

MODE	AVAILABLE CHANNEL	TESTED CHANNEL	MODULATION TECHNOLOGY	MODULATION TYPE	DATA RATE (Mbps)	ANT.
802.11a	149 to 165	149, 165	OFDM	BPSK	6.0	A
802.11a	149 to 165	149, 165	OFDM	BPSK	6.0	B
802.11n (20MHz)	149 to 165	149, 165	OFDM	BPSK	7.2	A+B
802.11n (40MHz)	151 to 159	151, 159	OFDM	BPSK	15.0	A+B

**ANTENNA PORT CONDUCTED MEASUREMENT:**

- This item includes all test value of each mode, but only includes spectrum plot of worst value of each mode.
- Pre-Scan has been conducted to determine the worst-case mode from all possible combinations between available modulations, data rates and antenna ports (if EUT with antenna diversity architecture).
- Following channel(s) was (were) selected for the final test as listed below.

MODE	AVAILABLE CHANNEL	TESTED CHANNEL	MODULATION TECHNOLOGY	MODULATION TYPE	DATA RATE (Mbps)	ANT.
802.11a	149 to 165	149, 157, 165	OFDM	BPSK	6.0	A
802.11a	149 to 165	149, 157, 165	OFDM	BPSK	6.0	B
802.11n (20MHz)	149 to 165	149, 157, 165	OFDM	BPSK	7.2	A+B
802.11n (40MHz)	151 to 159	151, 159	OFDM	BPSK	15.0	A+B

**TEST CONDITION:**

APPLICABLE TO	ENVIRONMENTAL CONDITIONS	INPUT POWER (SYSTEM)	TESTED BY
RE≥1G	21deg. C, 65%RH, 999 hPa	120Vac, 60Hz	Lori Chiu
RE<1G	15deg. C, 63%RH, 999 hPa	120Vac, 60Hz	Lori Chiu
PLC	21deg. C, 60%RH, 988 hPa	120Vac, 60Hz	Mick Chou
APCM	22deg. C, 61%RH, 999 hPa	120Vac, 60Hz	Dean Wang



A D T

### 3.3 GENERAL DESCRIPTION OF APPLIED STANDARDS

The EUT is a RF Product. According to the specifications of the manufacturer, it must comply with the requirements of the following standards:

#### **FCC Part 15, Subpart C (15.247)**

#### **ANSI C63.4-2003**

All test items have been performed and recorded as per the above standards.

**NOTE:** The EUT is also considered as a kind of computer peripheral, because the connection to computer is necessary for typical use. It has been verified to comply with the requirements of FCC Part 15, Subpart B, Class B (DoC). The test report has been issued separately.

### 3.4 DESCRIPTION OF SUPPORT UNITS

The EUT has been tested as an independent unit together with other necessary accessories or support units. The following support units or accessories were used to form a representative test configuration during the tests.

NO.	PRODUCT	BRAND	MODEL NO.	SERIAL NO.	FCC ID
1	NOTEBOOK	HP	Nc6000	NA	NA
2	PRINTER	EPSON	LQ-300+	DCGY054011	FCC DoC Approved

NO.	SIGNAL CABLE DESCRIPTION OF THE ABOVE SUPPORT UNITS
1	1.5m non-shielded Diag cable without core
2	1.8m braid shielded wire, DB25 connector, w/o core.

**NOTE:** 1. All power cords of the above support units are non shielded (1.8m).  
2. Item 1 was supplied from client.



A D T

## 4. TEST TYPES AND RESULTS (FOR 2.4GHz BAND)

### 4.1 RADIATED EMISSION MEASUREMENT

#### 4.1.1 LIMITS OF RADIATED EMISSION MEASUREMENT

Emissions radiated outside of the specified bands, shall be according to the general radiated limits in 15.209 as following:

FREQUENCIES (MHz)	FIELD STRENGTH (microvolts/meter)	MEASUREMENT DISTANCE (meters)
0.009 ~ 0.490	2400/F(kHz)	300
0.490 ~ 1.705	24000/F(kHz)	30
1.705 ~ 30.0	30	30
30 ~ 88	100	3
88 ~ 216	150	3
216 ~ 960	200	3
Above 960	500	3

**NOTE:**

1. The lower limit shall apply at the transition frequencies.
2. Emission level (dBuV/m) = 20 log Emission level (uV/m).
3. As shown in 15.35(b), for frequencies above 1000MHz, the field strength limits are based on average detector, however, the peak field strength of any emission shall not exceed the maximum permitted average limits, specified above by more than 20dB under any condition of modulation.



A D T

#### 4.1.2 TEST INSTRUMENTS

DESCRIPTION & MANUFACTURER	MODEL NO.	SERIAL NO.	DATE OF CALIBRATION	DUE DATE OF CALIBRATION
Test Receiver ROHDE & SCHWARZ	ESIB7	100212	May 25, 2009	May 24, 2010
Spectrum Analyzer ROHDE & SCHWARZ	FSP40	100040	Jul. 07, 2009	Jul. 06, 2010
BILOG Antenna SCHWARZBECK	VULB9168	9168-156	Apr. 30, 2009	Apr. 29, 2010
HORN Antenna SCHWARZBECK	BBHA 9120 D	9120D-563	Aug. 10, 2009	Aug. 09, 2010
HORN Antenna SCHWARZBECK	BBHA 9170	BBHA9170242	Jan. 06, 2009	Jan. 05, 2010
Preamplifier Agilent	8449B	3008A01910	Sep. 11, 2009	Sep. 10, 2010
Preamplifier Agilent	8447D	2944A10738	Nov. 04, 2009	Nov. 03, 2010
RF signal cable HUBER+SUHNNER	SUCOFLEX 104	218190/4 231241/4	May 13, 2009	May 12, 2010
RF signal cable Worken	8D-FB	Cable-HYCH9-01	Aug. 17, 2009	Aug. 16, 2010
Software	ADT_Radiated_ V7.6.15.9.2	NA	NA	NA
Antenna Tower EMCO	2070/2080	512.835.4684	NA	NA
Turn Table EMCO	2087-2.03	NA	NA	NA
Antenna Tower & Turn Table Controller EMCO	2090	NA	NA	NA

- NOTE:**
1. The calibration interval of the above test instruments is 12 months and the calibrations are traceable to NML/ROC and NIST/USA.
  2. The test was performed in HwaYa Chamber 9.
  3. The horn antenna and HP preamplifier (model: 8449B) are used only for the measurement of emission frequency above 1GHz if tested.
  4. The FCC Site Registration No. is 460141.
  5. The IC Site Registration No. is IC 7450F-4.





A D T

#### 4.1.3 TEST PROCEDURES

- a. The EUT was placed on the top of a rotating table 0.8 meters above the ground at a 3 meters semi-anechoic chamber. The table was rotated 360 degrees to determine the position of the highest radiation.
- b. The EUT was set 3 meters away from the interference-receiving antenna, which was mounted on the top of a variable-height antenna tower.
- c. The antenna is a broadband antenna, and its height is varied from one meter to four meters above the ground to determine the maximum value of the field strength. Both horizontal and vertical polarizations of the antenna are set to make the measurement.
- d. For each suspected emission, the EUT was arranged to its worst case and then the antenna was tuned to heights from 1 meter to 4 meters and the rotatable table was turned from 0 degrees to 360 degrees to find the maximum reading.
- e. The test-receiver system was set to Peak Detect Function and Specified Bandwidth with Maximum Hold Mode.
- f. If the emission level of the EUT in peak mode was lower than the limit specified, then testing could be stopped and the peak values of the EUT would be reported. Otherwise the emissions would be re-tested one by one using peak, quasi-peak or average method as specified and then reported in a data sheet.

**NOTE:**

1. The resolution bandwidth and video bandwidth of test receiver/spectrum analyzer is 120kHz for Quasi-peak detection at frequency below 1GHz.
2. The resolution bandwidth of test receiver/spectrum analyzer is 100kHz and video bandwidth is 300kHz for Peak detection at frequency above 1GHz.
3. The resolution bandwidth of test receiver/spectrum analyzer is 1MHz and the video bandwidth is 10Hz for Average detection (AV) at frequency above 1GHz.
4. All modes of operation were investigated and the worst-case emissions are reported.

#### 4.1.4 DEVIATION FROM TEST STANDARD

No deviation

#### 4.1.5 TEST SETUP

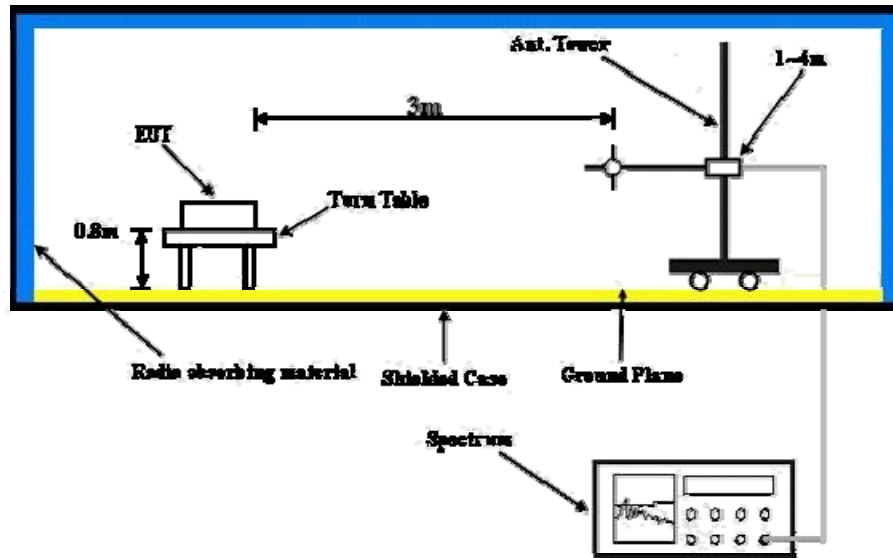

For the actual test configuration, please refer to the attached file (Test Setup Photo).

#### 4.1.6 EUT OPERATING CONDITIONS

- Connected EUT with notebook system and placed on a testing table.
- The communication partners connected with EUT via a RS 232 cable and run a test program (provided by manufacturer) to enable EUT under transmission condition continuously at specific channel frequency.
- The necessary accessories enable the EUT in full functions.



A D T

#### 4.1.7 TEST RESULTS

##### 802.11b

EUT TEST CONDITION		MEASUREMENT DETAIL	
CHANNEL	Channel 1	FREQUENCY RANGE	1 ~ 25GHz
INPUT POWER (SYSTEM)	120Vac, 60 Hz	DETECTOR FUNCTION	Peak (PK) Average (AV)
ENVIRONMENTAL CONDITIONS	21deg. C, 65%RH 1020 hPa	TESTED BY	Sun Lin

ANTENNA POLARITY & TEST DISTANCE: HORIZONTAL AT 3 M								
NO.	FREQ. (MHz)	EMISSION LEVEL (dBuV/m)	LIMIT (dBuV/m)	MARGIN (dB)	ANTENNA HEIGHT (m)	TABLE ANGLE (Degree)	RAW VALUE (dBuV)	CORRECTION FACTOR (dB/m)
1	2390.00	61.1 PK	74.0	-12.9	1.32 H	112	28.88	32.22
2	2390.00	47.6 AV	54.0	-6.4	1.32 H	112	15.38	32.22
3	*2412.00	108.6 PK			1.29 H	112	76.30	32.30
4	*2412.00	103.6 AV			1.29 H	112	71.30	32.30
5	2500.00	61.8 PK	74.0	-12.2	1.27 H	113	29.18	32.62
6	2500.00	52.2 AV	54.0	-1.8	1.27 H	113	19.58	32.62
7	4824.00	55.4 PK	74.0	-18.6	1.33 H	200	17.07	38.33
8	4824.00	50.8 AV	54.0	-3.2	1.33 H	200	12.47	38.33
ANTENNA POLARITY & TEST DISTANCE: VERTICAL AT 3 M								
NO.	FREQ. (MHz)	EMISSION LEVEL (dBuV/m)	LIMIT (dBuV/m)	MARGIN (dB)	ANTENNA HEIGHT (m)	TABLE ANGLE (Degree)	RAW VALUE (dBuV)	CORRECTION FACTOR (dB/m)
1	2390.00	59.9 PK	74.0	-14.1	1.00 V	226	27.68	32.22
2	2390.00	49.0 AV	54.0	-5.0	1.00 V	226	16.78	32.22
3	*2412.00	106.9 PK			1.00 V	226	74.60	32.30
4	*2412.00	101.7 AV			1.00 V	226	69.40	32.30
5	2500.00	61.5 PK	74.0	-12.5	1.48 V	18	28.88	32.62
6	2500.00	52.7 AV	54.0	-1.3	1.48 V	18	20.08	32.62
7	4824.00	55.9 PK	74.0	-18.1	1.49 V	277	17.57	38.33
8	4824.00	51.3 AV	54.0	-2.7	1.49 V	277	12.97	38.33

- REMARKS:**
1. Emission level (dBuV/m) = Raw Value (dBuV) + Correction Factor (dB/m).
  2. Correction Factor (dB/m) = Antenna Factor (dB/m) + Cable Factor (dB).
  3. The other emission levels were very low against the limit.
  4. Margin value = Emission level – Limit value.
  5. “ \* “: Fundamental frequency.



A D T

EUT TEST CONDITION		MEASUREMENT DETAIL	
CHANNEL	Channel 6	FREQUENCY RANGE	1 ~ 25GHz
INPUT POWER (SYSTEM)	120Vac, 60 Hz	DETECTOR FUNCTION	Peak (PK) Average (AV)
ENVIRONMENTAL CONDITIONS	21deg. C, 65%RH 1020 hPa	TESTED BY	Sun Lin

ANTENNA POLARITY & TEST DISTANCE: HORIZONTAL AT 3 M								
NO.	FREQ. (MHz)	EMISSION LEVEL (dBuV/m)	LIMIT (dBuV/m)	MARGIN (dB)	ANTENNA HEIGHT (m)	TABLE ANGLE (Degree)	RAW VALUE (dBuV)	CORRECTION FACTOR (dB/m)
1	*2437.00	108.5 PK			1.30 H	132	76.11	32.39
2	*2437.00	103.9 AV			1.30 H	132	71.51	32.39
3	2500.00	61.8 PK	74.0	-12.2	1.33 H	124	29.18	32.62
4	2500.00	52.0 AV	54.0	-2.0	1.33 H	124	19.38	32.62
5	4874.00	54.6 PK	74.0	-19.4	1.21 H	194	16.19	38.41
6	4874.00	49.7 AV	54.0	-4.3	1.21 H	194	11.29	38.41
ANTENNA POLARITY & TEST DISTANCE: VERTICAL AT 3 M								
NO.	FREQ. (MHz)	EMISSION LEVEL (dBuV/m)	LIMIT (dBuV/m)	MARGIN (dB)	ANTENNA HEIGHT (m)	TABLE ANGLE (Degree)	RAW VALUE (dBuV)	CORRECTION FACTOR (dB/m)
1	*2437.00	106.8 PK			1.25 V	224	74.41	32.39
2	*2437.00	101.4 AV			1.25 V	224	69.01	32.39
3	2500.00	61.3 PK	74.0	-12.7	1.00 V	145	28.68	32.62
4	2500.00	52.7 AV	54.0	-1.3	1.00 V	145	20.08	32.62
5	4874.00	55.0 PK	74.0	-19.0	1.53 V	207	16.59	38.41
6	4874.00	51.5 AV	54.0	-2.5	1.53 V	207	13.09	38.41

- REMARKS:**
1. Emission level (dBuV/m) = Raw Value (dBuV) + Correction Factor (dB/m).
  2. Correction Factor (dB/m) = Antenna Factor (dB/m) + Cable Factor (dB).
  3. The other emission levels were very low against the limit.
  4. Margin value = Emission level – Limit value.
  5. “ \* “: Fundamental frequency.



A D T

EUT TEST CONDITION		MEASUREMENT DETAIL	
CHANNEL	Channel 11	FREQUENCY RANGE	1 ~ 25GHz
INPUT POWER (SYSTEM)	120Vac, 60 Hz	DETECTOR FUNCTION	Peak (PK) Average (AV)
ENVIRONMENTAL CONDITIONS	21deg. C, 65%RH 1020 hPa	TESTED BY	Sun Lin

ANTENNA POLARITY & TEST DISTANCE: HORIZONTAL AT 3 M								
NO.	FREQ. (MHz)	EMISSION LEVEL (dBuV/m)	LIMIT (dBuV/m)	MARGIN (dB)	ANTENNA HEIGHT (m)	TABLE ANGLE (Degree)	RAW VALUE (dBuV)	CORRECTION FACTOR (dB/m)
1	*2462.00	108.4 PK			1.27 H	113	75.92	32.48
2	*2462.00	103.3 AV			1.27 H	113	70.82	32.48
3	2483.50	59.6 PK	74.0	-14.4	1.27 H	113	27.04	32.56
4	2483.50	49.2 AV	54.0	-4.8	1.27 H	113	16.64	32.56
5	2500.00	61.5 PK	74.0	-12.5	1.32 H	127	28.88	32.62
6	2500.00	52.1 AV	54.0	-1.9	1.32 H	127	19.48	32.62
7	4924.00	55.1 PK	74.0	-18.9	1.28 H	193	16.59	38.51
8	4924.00	50.2 AV	54.0	-3.8	1.28 H	193	11.69	38.51
ANTENNA POLARITY & TEST DISTANCE: VERTICAL AT 3 M								
NO.	FREQ. (MHz)	EMISSION LEVEL (dBuV/m)	LIMIT (dBuV/m)	MARGIN (dB)	ANTENNA HEIGHT (m)	TABLE ANGLE (Degree)	RAW VALUE (dBuV)	CORRECTION FACTOR (dB/m)
1	*2462.00	106.7 PK			1.21 V	220	74.22	32.48
2	*2462.00	101.3 AV			1.21 V	220	68.82	32.48
3	2483.50	59.7 PK	74.0	-14.3	1.21 V	220	27.14	32.56
4	2483.50	48.9 AV	54.0	-5.1	1.21 V	220	16.34	32.56
5	2500.00	61.1 PK	74.0	-12.9	1.52 V	23	28.48	32.62
6	2500.00	52.4 AV	54.0	-1.6	1.52 V	23	19.78	32.62
7	4924.00	55.6 PK	74.0	-18.4	1.53 V	251	17.09	38.51
8	4924.00	51.2 AV	54.0	-2.8	1.53 V	251	12.69	38.51

- REMARKS:**
1. Emission level (dBuV/m) = Raw Value (dBuV) + Correction Factor (dB/m).
  2. Correction Factor (dB/m) = Antenna Factor (dB/m) + Cable Factor (dB).
  3. The other emission levels were very low against the limit.
  4. Margin value = Emission level – Limit value.
  5. “ \* “: Fundamental frequency.



A D T

802.11g (Antenna A)

EUT TEST CONDITION		MEASUREMENT DETAIL	
CHANNEL	Channel 1	FREQUENCY RANGE	1 ~ 25GHz
INPUT POWER (SYSTEM)	120Vac, 60 Hz	DETECTOR FUNCTION	Peak (PK) Average (AV)
ENVIRONMENTAL CONDITIONS	21deg. C, 65%RH 1020 hPa	TESTED BY	Sun Lin

ANTENNA POLARITY & TEST DISTANCE: HORIZONTAL AT 3 M								
NO.	FREQ. (MHz)	EMISSION LEVEL (dBuV/m)	LIMIT (dBuV/m)	MARGIN (dB)	ANTENNA HEIGHT (m)	TABLE ANGLE (Degree)	RAW VALUE (dBuV)	CORRECTION FACTOR (dB/m)
1	2390.00	63.2 PK	74.0	-10.8	1.30 H	108	30.98	32.22
2	2390.00	51.9 AV	54.0	-2.1	1.30 H	108	19.68	32.22
3	*2412.00	105.4 PK			1.30 H	108	73.10	32.30
4	*2412.00	91.3 AV			1.30 H	108	59.00	32.30
5	2500.00	61.5 PK	74.0	-12.5	1.35 H	107	28.88	32.62
6	2500.00	52.1 AV	54.0	-1.9	1.35 H	107	19.48	32.62
7	4824.00	52.2 PK	74.0	-21.8	1.23 H	286	13.87	38.33
8	4824.00	36.9 AV	54.0	-17.1	1.23 H	286	-1.43	38.33
ANTENNA POLARITY & TEST DISTANCE: VERTICAL AT 3 M								
NO.	FREQ. (MHz)	EMISSION LEVEL (dBuV/m)	LIMIT (dBuV/m)	MARGIN (dB)	ANTENNA HEIGHT (m)	TABLE ANGLE (Degree)	RAW VALUE (dBuV)	CORRECTION FACTOR (dB/m)
1	2390.00	65.1 PK	74.0	-8.9	1.56 V	13	32.88	32.22
2	2390.00	51.9 AV	54.0	-2.1	1.56 V	13	19.68	32.22
3	*2412.00	104.9 PK			1.56 V	13	72.6	32.30
4	*2412.00	90.7 AV			1.56 V	13	58.40	32.30
5	2500.00	61.3 PK	74.0	-12.7	1.53 V	25	28.68	32.62
6	2500.00	52.4 AV	54.0	-1.6	1.53 V	25	19.78	32.62
7	4824.00	56.4 PK	74.0	-17.6	1.47 V	239	18.07	38.33
8	4824.00	38.3 AV	54.0	-15.7	1.47 V	239	-0.03	38.33

- REMARKS:**
1. Emission level (dBuV/m) = Raw Value (dBuV) + Correction Factor (dB/m).
  2. Correction Factor (dB/m) = Antenna Factor (dB/m) + Cable Factor (dB).
  3. The other emission levels were very low against the limit.
  4. Margin value = Emission level – Limit value.
  5. “ \* “: Fundamental frequency.



A D T

EUT TEST CONDITION		MEASUREMENT DETAIL	
CHANNEL	Channel 6	FREQUENCY RANGE	1 ~ 25GHz
INPUT POWER (SYSTEM)	120Vac, 60 Hz	DETECTOR FUNCTION	Peak (PK) Average (AV)
ENVIRONMENTAL CONDITIONS	21deg. C, 65%RH 1020 hPa	TESTED BY	Sun Lin

ANTENNA POLARITY & TEST DISTANCE: HORIZONTAL AT 3 M								
NO.	FREQ. (MHz)	EMISSION LEVEL (dBuV/m)	LIMIT (dBuV/m)	MARGIN (dB)	ANTENNA HEIGHT (m)	TABLE ANGLE (Degree)	RAW VALUE (dBuV)	CORRECTION FACTOR (dB/m)
1	*2437.00	105.3 PK			1.30 H	111	72.91	32.39
2	*2437.00	91.3 AV			1.30 H	111	58.91	32.39
3	2500.00	61.3 PK	74.0	-12.7	1.23 H	147	28.68	32.62
4	2500.00	52.2 AV	54.0	-1.8	1.23 H	147	19.58	32.62
5	4874.00	52.3 PK	74.0	-21.7	1.27 H	255	13.89	38.41
6	4874.00	37.1 AV	54.0	-16.9	1.27 H	255	-1.31	38.41
ANTENNA POLARITY & TEST DISTANCE: VERTICAL AT 3 M								
NO.	FREQ. (MHz)	EMISSION LEVEL (dBuV/m)	LIMIT (dBuV/m)	MARGIN (dB)	ANTENNA HEIGHT (m)	TABLE ANGLE (Degree)	RAW VALUE (dBuV)	CORRECTION FACTOR (dB/m)
1	*2437.00	104.9 PK			1.54 V	19	72.51	32.39
2	*2437.00	90.5 AV			1.54 V	19	58.11	32.39
3	2500.00	61.1 PK	74.0	-12.9	1.47 V	33	28.48	32.62
4	2500.00	52.1 AV	54.0	-1.9	1.47 V	33	19.48	32.62
5	4874.00	56.3 PK	74.0	-17.7	1.32 V	251	17.89	38.41
6	4874.00	39.1 AV	54.0	-14.9	1.32 V	251	0.69	38.41

- REMARKS:**
1. Emission level (dBuV/m) = Raw Value (dBuV) + Correction Factor (dB/m).
  2. Correction Factor (dB/m) = Antenna Factor (dB/m) + Cable Factor (dB).
  3. The other emission levels were very low against the limit.
  4. Margin value = Emission level – Limit value.
  5. “ \* “: Fundamental frequency.



A D T

EUT TEST CONDITION		MEASUREMENT DETAIL	
CHANNEL	Channel 11	FREQUENCY RANGE	1 ~ 25GHz
INPUT POWER (SYSTEM)	120Vac, 60 Hz	DETECTOR FUNCTION	Peak (PK) Average (AV)
ENVIRONMENTAL CONDITIONS	21deg. C, 65%RH 1020 hPa	TESTED BY	Sun Lin

ANTENNA POLARITY & TEST DISTANCE: HORIZONTAL AT 3 M								
NO.	FREQ. (MHz)	EMISSION LEVEL (dBuV/m)	LIMIT (dBuV/m)	MARGIN (dB)	ANTENNA HEIGHT (m)	TABLE ANGLE (Degree)	RAW VALUE (dBuV)	CORRECTION FACTOR (dB/m)
1	2390.00	65.4 PK	74.0	-8.6	1.25 H	111	33.18	32.22
2	2390.00	51.3 AV	54.0	-2.7	1.25 H	111	19.08	32.22
3	*2462.00	105.3 PK			1.25 H	111	72.82	32.48
4	*2462.00	91.2 AV			1.25 H	111	58.72	32.48
5	2500.00	61.1 PK	74.0	-12.9	1.45 H	113	28.48	32.62
6	2500.00	52.0 AV	54.0	-2.0	1.45 H	113	19.38	32.62
7	4924.00	52.3 PK	74.0	-21.7	1.18 H	278	13.79	38.51
8	4924.00	36.5 AV	54.0	-17.5	1.18 H	278	-2.01	38.51
ANTENNA POLARITY & TEST DISTANCE: VERTICAL AT 3 M								
NO.	FREQ. (MHz)	EMISSION LEVEL (dBuV/m)	LIMIT (dBuV/m)	MARGIN (dB)	ANTENNA HEIGHT (m)	TABLE ANGLE (Degree)	RAW VALUE (dBuV)	CORRECTION FACTOR (dB/m)
1	*2462.00	104.7 PK			1.46 V	27	72.22	32.48
2	*2462.00	90.3 AV			1.46 V	27	57.82	32.48
3	2483.50	65.2 PK	74.0	-8.8	1.46 V	27	32.64	32.56
4	2483.50	51.0 AV	54.0	-3.0	1.46 V	27	18.44	32.56
5	2500.00	61.1 PK	74.0	-12.9	1.51 V	39	28.48	32.62
6	2500.00	52.0 AV	54.0	-2.0	1.51 V	39	19.38	32.62
7	4924.00	56.1 PK	74.0	-17.9	1.43 V	267	17.59	38.51
8	4924.00	39.1 AV	54.0	-14.9	1.43 V	267	0.59	38.51

- REMARKS:**
1. Emission level (dBuV/m) = Raw Value (dBuV) + Correction Factor (dB/m).
  2. Correction Factor (dB/m) = Antenna Factor (dB/m) + Cable Factor (dB).
  3. The other emission levels were very low against the limit.
  4. Margin value = Emission level – Limit value.
  5. “ \* “: Fundamental frequency.





A D T

802.11g (Antenna B)

EUT TEST CONDITION		MEASUREMENT DETAIL	
CHANNEL	Channel 1	FREQUENCY RANGE	1 ~ 25GHz
INPUT POWER (SYSTEM)	120Vac, 60 Hz	DETECTOR FUNCTION	Peak (PK) Average (AV)
ENVIRONMENTAL CONDITIONS	21deg. C, 65%RH 1020 hPa	TESTED BY	Lori Chiu

ANTENNA POLARITY & TEST DISTANCE: HORIZONTAL AT 3 M								
NO.	FREQ. (MHz)	EMISSION LEVEL (dBuV/m)	LIMIT (dBuV/m)	MARGIN (dB)	ANTENNA HEIGHT (m)	TABLE ANGLE (Degree)	RAW VALUE (dBuV)	CORRECTION FACTOR (dB/m)
1	2390.00	68.6 PK	74.0	-5.4	1.33 H	108	36.38	32.22
2	2390.00	51.9 AV	54.0	-2.1	1.33 H	108	19.68	32.22
3	*2412.00	107.8 PK			1.32 H	144	75.5	32.30
4	*2412.00	92.9 AV			1.32 H	144	60.60	32.30
5	2500.00	60.2 PK	74.0	-13.8	1.01 H	34	27.58	32.62
6	2500.00	50.2 AV	54.0	-3.8	1.01 H	34	17.58	32.62
7	4824.00	48.9 PK	74.0	-25.1	1.13 H	302	10.57	38.33
8	4824.00	36.4 AV	54.0	-17.6	1.13 H	302	-1.93	38.33
ANTENNA POLARITY & TEST DISTANCE: VERTICAL AT 3 M								
NO.	FREQ. (MHz)	EMISSION LEVEL (dBuV/m)	LIMIT (dBuV/m)	MARGIN (dB)	ANTENNA HEIGHT (m)	TABLE ANGLE (Degree)	RAW VALUE (dBuV)	CORRECTION FACTOR (dB/m)
1	2390.00	59.8 PK	74.0	-14.2	1.11 V	205	27.58	32.22
2	2390.00	47.8 AV	54.0	-6.2	1.11 V	205	15.58	32.22
3	*2412.00	98.5 PK			1.11 V	205	66.20	32.30
4	*2412.00	84.9 AV			1.11 V	205	52.60	32.30
5	2500.00	57.7 PK	74.0	-16.3	1.11 V	11	25.08	32.62
6	2500.00	47.3 AV	54.0	-6.7	1.11 V	11	14.68	32.62
7	4824.00	47.8 PK	74.0	-26.2	1.12 V	201	9.47	38.33
8	4824.00	35.0 AV	54.0	-19.0	1.12 V	201	-3.33	38.33

- REMARKS:**
1. Emission level (dBuV/m) = Raw Value (dBuV) + Correction Factor (dB/m).
  2. Correction Factor (dB/m) = Antenna Factor (dB/m) + Cable Factor (dB).
  3. The other emission levels were very low against the limit.
  4. Margin value = Emission level – Limit value.
  5. “ \* “: Fundamental frequency.



A D T

EUT TEST CONDITION		MEASUREMENT DETAIL	
CHANNEL	Channel 6	FREQUENCY RANGE	1 ~ 25GHz
INPUT POWER (SYSTEM)	120Vac, 60 Hz	DETECTOR FUNCTION	Peak (PK) Average (AV)
ENVIRONMENTAL CONDITIONS	21deg. C, 65%RH 1020 hPa	TESTED BY	Lori Chiu

ANTENNA POLARITY & TEST DISTANCE: HORIZONTAL AT 3 M								
NO.	FREQ. (MHz)	EMISSION LEVEL (dBuV/m)	LIMIT (dBuV/m)	MARGIN (dB)	ANTENNA HEIGHT (m)	TABLE ANGLE (Degree)	RAW VALUE (dBuV)	CORRECTION FACTOR (dB/m)
1	*2437.00	107.8 PK			1.11 H	160	75.41	32.39
2	*2437.00	92.8 AV			1.11 H	160	60.41	32.39
3	2500.00	60.6 PK	74.0	-13.4	1.10 H	100	27.98	32.62
4	2500.00	50.1 AV	54.0	-3.9	1.10 H	100	17.48	32.62
5	4874.00	48.5 PK	74.0	-25.5	1.50 H	247	10.09	38.41
6	4874.00	35.5 AV	54.0	-18.5	1.50 H	247	-2.91	38.41
ANTENNA POLARITY & TEST DISTANCE: VERTICAL AT 3 M								
NO.	FREQ. (MHz)	EMISSION LEVEL (dBuV/m)	LIMIT (dBuV/m)	MARGIN (dB)	ANTENNA HEIGHT (m)	TABLE ANGLE (Degree)	RAW VALUE (dBuV)	CORRECTION FACTOR (dB/m)
1	*2437.00	98.4 PK			1.10 V	200	66.01	32.39
2	*2437.00	84.7 AV			1.10 V	200	52.31	32.39
3	2500.00	57.9 PK	74.0	-16.1	1.09 V	200	25.28	32.62
4	2500.00	47.4 AV	54.0	-6.6	1.09 V	200	14.78	32.62
5	4874.00	47.5 PK	74.0	-26.5	1.00 V	345	9.09	38.41
6	4874.00	35.0 AV	54.0	-19.0	1.00 V	345	-3.41	38.41

- REMARKS:**
1. Emission level (dBuV/m) = Raw Value (dBuV) + Correction Factor (dB/m).
  2. Correction Factor (dB/m) = Antenna Factor (dB/m) + Cable Factor (dB).
  3. The other emission levels were very low against the limit.
  4. Margin value = Emission level – Limit value.
  5. “ \* “: Fundamental frequency.



A D T

EUT TEST CONDITION		MEASUREMENT DETAIL	
CHANNEL	Channel 11	FREQUENCY RANGE	1 ~ 25GHz
INPUT POWER (SYSTEM)	120Vac, 60 Hz	DETECTOR FUNCTION	Peak (PK) Average (AV)
ENVIRONMENTAL CONDITIONS	21deg. C, 65%RH 1020 hPa	TESTED BY	Lori Chiu

ANTENNA POLARITY & TEST DISTANCE: HORIZONTAL AT 3 M								
NO.	FREQ. (MHz)	EMISSION LEVEL (dBuV/m)	LIMIT (dBuV/m)	MARGIN (dB)	ANTENNA HEIGHT (m)	TABLE ANGLE (Degree)	RAW VALUE (dBuV)	CORRECTION FACTOR (dB/m)
1	*2462.00	107.7 PK			1.29 H	105	75.22	32.48
2	*2462.00	93.3 AV			1.29 H	105	60.82	32.48
3	2483.50	66.7 PK	74.0	-7.3	1.30 H	104	34.14	32.56
4	2483.50	52.9 AV	54.0	-1.1	1.30 H	104	20.34	32.56
5	2500.00	60.6 PK	74.0	-13.4	1.30 H	107	27.98	32.62
6	2500.00	49.4 AV	54.0	-4.6	1.30 H	107	16.78	32.62
7	4924.00	47.2 PK	74.0	-26.8	1.06 H	330	8.69	38.51
8	4924.00	34.1 AV	54.0	-19.9	1.06 H	330	-4.41	38.51
ANTENNA POLARITY & TEST DISTANCE: VERTICAL AT 3 M								
NO.	FREQ. (MHz)	EMISSION LEVEL (dBuV/m)	LIMIT (dBuV/m)	MARGIN (dB)	ANTENNA HEIGHT (m)	TABLE ANGLE (Degree)	RAW VALUE (dBuV)	CORRECTION FACTOR (dB/m)
1	*2462.00	97.9 PK			1.11 V	212	65.42	32.48
2	*2462.00	84.1 AV			1.11 V	212	51.62	32.48
3	2483.50	59.9 PK	74.0	-14.1	1.11 V	212	27.34	32.56
4	2483.50	48.0 AV	54.0	-6.0	1.11 V	212	15.44	32.56
5	2500.00	58.5 PK	74.0	-15.5	1.11 V	1	25.88	32.62
6	2500.00	47.3 AV	54.0	-6.7	1.11 V	1	14.68	32.62
7	4924.00	46.8 PK	74.0	-27.2	1.13 V	205	8.29	38.51
8	4924.00	33.7 AV	54.0	-20.3	1.13 V	205	-4.81	38.51

- REMARKS:**
1. Emission level (dBuV/m) = Raw Value (dBuV) + Correction Factor (dB/m).
  2. Correction Factor (dB/m) = Antenna Factor (dB/m) + Cable Factor (dB).
  3. The other emission levels were very low against the limit.
  4. Margin value = Emission level – Limit value.
  5. “ \* “: Fundamental frequency.



A D T

802.11n (20MHz)

EUT TEST CONDITION		MEASUREMENT DETAIL	
CHANNEL	Channel 1	FREQUENCY RANGE	1 ~ 25GHz
INPUT POWER (SYSTEM)	120Vac, 60 Hz	DETECTOR FUNCTION	Peak (PK) Average (AV)
ENVIRONMENTAL CONDITIONS	21deg. C, 65%RH 1020 hPa	TESTED BY	Lori Chiu

ANTENNA POLARITY & TEST DISTANCE: HORIZONTAL AT 3 M								
NO.	FREQ. (MHz)	EMISSION LEVEL (dBuV/m)	LIMIT (dBuV/m)	MARGIN (dB)	ANTENNA HEIGHT (m)	TABLE ANGLE (Degree)	RAW VALUE (dBuV)	CORRECTION FACTOR (dB/m)
1	2390.00	66.2 PK	74.0	-7.8	1.14 H	135	33.98	32.22
2	2390.00	51.7 AV	54.0	-2.3	1.14 H	135	19.48	32.22
3	*2412.00	108.0 PK			1.14 H	135	75.70	32.30
4	*2412.00	93.9 AV			1.14 H	135	61.60	32.30
5	2500.00	60.6 PK	74.0	-13.4	1.08 H	132	27.98	32.62
6	2500.00	50.3 AV	54.0	-3.7	1.08 H	132	17.68	32.62
7	4824.00	48.9 PK	74.0	-25.1	1.19 H	315	10.57	38.33
8	4824.00	35.3 AV	54.0	-18.7	1.19 H	315	-3.03	38.33
ANTENNA POLARITY & TEST DISTANCE: VERTICAL AT 3 M								
NO.	FREQ. (MHz)	EMISSION LEVEL (dBuV/m)	LIMIT (dBuV/m)	MARGIN (dB)	ANTENNA HEIGHT (m)	TABLE ANGLE (Degree)	RAW VALUE (dBuV)	CORRECTION FACTOR (dB/m)
1	2390.00	63.5 PK	74.0	-10.5	1.00 V	264	31.28	32.22
2	2390.00	49.8 AV	54.0	-4.2	1.00 V	264	17.58	32.22
3	*2412.00	106.0 PK			1.00 V	264	73.70	32.30
4	*2412.00	92.2 AV			1.00 V	264	59.90	32.30
5	2500.00	60.9 PK	74.0	-13.1	1.03 V	293	28.28	32.62
6	2500.00	52.9 AV	54.0	-1.1	1.03 V	293	20.28	32.62
7	4824.00	55.0 PK	74.0	-19.0	1.20 V	242	16.67	38.33
8	4824.00	38.2 AV	54.0	-15.8	1.20 V	242	-0.13	38.33

- REMARKS:**
1. Emission level (dBuV/m) = Raw Value (dBuV) + Correction Factor (dB/m).
  2. Correction Factor (dB/m) = Antenna Factor (dB/m) + Cable Factor (dB).
  3. The other emission levels were very low against the limit.
  4. Margin value = Emission level – Limit value.
  5. “ \* ”: Fundamental frequency.



A D T

EUT TEST CONDITION		MEASUREMENT DETAIL	
CHANNEL	Channel 6	FREQUENCY RANGE	1 ~ 25GHz
INPUT POWER (SYSTEM)	120Vac, 60 Hz	DETECTOR FUNCTION	Peak (PK) Average (AV)
ENVIRONMENTAL CONDITIONS	21deg. C, 65%RH 1020 hPa	TESTED BY	Lori Chiu

ANTENNA POLARITY & TEST DISTANCE: HORIZONTAL AT 3 M								
NO.	FREQ. (MHz)	EMISSION LEVEL (dBuV/m)	LIMIT (dBuV/m)	MARGIN (dB)	ANTENNA HEIGHT (m)	TABLE ANGLE (Degree)	RAW VALUE (dBuV)	CORRECTION FACTOR (dB/m)
1	*2437.00	108.0 PK			1.13 H	134	75.61	32.39
2	*2437.00	94.0 AV			1.13 H	134	61.61	32.39
3	2500.00	60.0 PK	74.0	-14.0	1.13 H	134	27.38	32.62
4	2500.00	49.8 AV	54.0	-4.2	1.13 H	134	17.18	32.62
5	4874.00	47.2 PK	74.0	-26.8	1.11 H	150	8.79	38.41
6	4874.00	34.5 AV	54.0	-19.5	1.11 H	150	-3.91	38.41
ANTENNA POLARITY & TEST DISTANCE: VERTICAL AT 3 M								
NO.	FREQ. (MHz)	EMISSION LEVEL (dBuV/m)	LIMIT (dBuV/m)	MARGIN (dB)	ANTENNA HEIGHT (m)	TABLE ANGLE (Degree)	RAW VALUE (dBuV)	CORRECTION FACTOR (dB/m)
1	*2437.00	106.3 PK			1.11 V	266	73.91	32.39
2	*2437.00	92.4 AV			1.11 V	266	60.01	32.39
3	2500.00	61.6 PK	74.0	-12.4	1.00 V	280	28.98	32.62
4	2500.00	53.0 AV	54.0	-1.0	1.00 V	280	20.38	32.62
5	4874.00	55.8 PK	74.0	-18.2	1.01 V	114	17.39	38.41
6	4874.00	37.1 AV	54.0	-16.9	1.01 V	114	-1.31	38.41

- REMARKS:**
1. Emission level (dBuV/m) = Raw Value (dBuV) + Correction Factor (dB/m).
  2. Correction Factor (dB/m) = Antenna Factor (dB/m) + Cable Factor (dB).
  3. The other emission levels were very low against the limit.
  4. Margin value = Emission level – Limit value.
  5. “ \* “: Fundamental frequency.



A D T

EUT TEST CONDITION		MEASUREMENT DETAIL	
CHANNEL	Channel 11	FREQUENCY RANGE	1 ~ 25GHz
INPUT POWER (SYSTEM)	120Vac, 60 Hz	DETECTOR FUNCTION	Peak (PK) Average (AV)
ENVIRONMENTAL CONDITIONS	21deg. C, 65%RH 1020 hPa	TESTED BY	Lori Chiu

ANTENNA POLARITY & TEST DISTANCE: HORIZONTAL AT 3 M								
NO.	FREQ. (MHz)	EMISSION LEVEL (dBuV/m)	LIMIT (dBuV/m)	MARGIN (dB)	ANTENNA HEIGHT (m)	TABLE ANGLE (Degree)	RAW VALUE (dBuV)	CORRECTION FACTOR (dB/m)
1	*2462.00	108.2 PK			1.38 H	332	75.72	32.48
2	*2462.00	94.1 AV			1.38 H	332	61.62	32.48
3	2483.50	68.2 PK	74.0	-5.8	1.10 H	135	35.64	32.56
4	2483.50	52.8 AV	54.0	-1.2	1.10 H	135	20.24	32.56
5	2500.00	59.7 PK	74.0	-14.3	1.11 H	114	27.08	32.62
6	2500.00	49.6 AV	54.0	-4.4	1.11 H	114	16.98	32.62
7	4924.00	46.6 PK	74.0	-27.4	1.10 H	35	8.09	38.51
8	4924.00	33.9 AV	54.0	-20.1	1.10 H	35	-4.61	38.51
ANTENNA POLARITY & TEST DISTANCE: VERTICAL AT 3 M								
NO.	FREQ. (MHz)	EMISSION LEVEL (dBuV/m)	LIMIT (dBuV/m)	MARGIN (dB)	ANTENNA HEIGHT (m)	TABLE ANGLE (Degree)	RAW VALUE (dBuV)	CORRECTION FACTOR (dB/m)
1	*2462.00	106.1 PK			1.00 V	273	73.62	32.48
2	*2462.00	92.6 AV			1.00 V	273	60.12	32.48
3	2483.50	68.0 PK	74.0	-6.0	1.00 V	272	35.44	32.56
4	2483.50	52.4 AV	54.0	-1.6	1.00 V	272	19.84	32.56
5	2500.00	62.5 PK	74.0	-11.5	1.01 V	281	29.88	32.62
6	2500.00	52.8 AV	54.0	-1.2	1.01 V	281	20.18	32.62
7	4924.00	56.6 PK	74.0	-17.4	1.00 V	303	18.09	38.51
8	4924.00	35.9 AV	54.0	-18.1	1.00 V	303	-2.61	38.51

- REMARKS:**
1. Emission level (dBuV/m) = Raw Value (dBuV) + Correction Factor (dB/m).
  2. Correction Factor (dB/m) = Antenna Factor (dB/m) + Cable Factor (dB).
  3. The other emission levels were very low against the limit.
  4. Margin value = Emission level – Limit value.
  5. “ \* “: Fundamental frequency.



A D T

802.11n (40MHz)

EUT TEST CONDITION		MEASUREMENT DETAIL	
CHANNEL	Channel 1	FREQUENCY RANGE	1 ~ 25GHz
INPUT POWER (SYSTEM)	120Vac, 60 Hz	DETECTOR FUNCTION	Peak (PK) Average (AV)
ENVIRONMENTAL CONDITIONS	21deg. C, 65%RH 1020 hPa	TESTED BY	Lori Chiu

ANTENNA POLARITY & TEST DISTANCE: HORIZONTAL AT 3 M								
NO.	FREQ. (MHz)	EMISSION LEVEL (dBuV/m)	LIMIT (dBuV/m)	MARGIN (dB)	ANTENNA HEIGHT (m)	TABLE ANGLE (Degree)	RAW VALUE (dBuV)	CORRECTION FACTOR (dB/m)
1	2390.00	68.4 PK	74.0	-5.6	1.12 H	132	36.18	32.22
2	2390.00	52.9 AV	54.0	-1.1	1.12 H	132	20.68	32.22
3	*2422.00	106.7 PK			1.14 H	131	74.36	32.34
4	*2422.00	91.3 AV			1.14 H	131	58.96	32.34
5	2500.00	60.0 PK	74.0	-14.0	1.13 H	109	27.38	32.62
6	2500.00	48.4 AV	54.0	-5.6	1.13 H	109	15.78	32.62
7	4844.00	46.1 PK	74.0	-27.9	1.13 H	186	7.74	38.36
8	4844.00	33.8 AV	54.0	-20.2	1.13 H	186	-4.56	38.36
ANTENNA POLARITY & TEST DISTANCE: VERTICAL AT 3 M								
NO.	FREQ. (MHz)	EMISSION LEVEL (dBuV/m)	LIMIT (dBuV/m)	MARGIN (dB)	ANTENNA HEIGHT (m)	TABLE ANGLE (Degree)	RAW VALUE (dBuV)	CORRECTION FACTOR (dB/m)
1	2390.00	68.2 PK	74.0	-5.8	1.01 V	265	35.98	32.22
2	2390.00	52.3 AV	54.0	-1.7	1.01 V	265	20.08	32.22
3	*2422.00	102.5 PK			1.00 V	265	70.16	32.34
4	*2422.00	89.6 AV			1.00 V	265	57.26	32.34
5	2500.00	61.1 PK	74.0	-12.9	1.02 V	278	28.48	32.62
6	2500.00	52.9 AV	54.0	-1.1	1.02 V	278	20.28	32.62
7	4844.00	49.3 PK	74.0	-24.7	1.31 V	246	10.94	38.36
8	4844.00	35.2 AV	54.0	-18.8	1.31 V	246	-3.16	38.36

- REMARKS:**
1. Emission level (dBuV/m) = Raw Value (dBuV) + Correction Factor (dB/m).
  2. Correction Factor (dB/m) = Antenna Factor (dB/m) + Cable Factor (dB).
  3. The other emission levels were very low against the limit.
  4. Margin value = Emission level – Limit value.
  5. “ \* ”: Fundamental frequency.



A D T

EUT TEST CONDITION		MEASUREMENT DETAIL	
CHANNEL	Channel 4	FREQUENCY RANGE	1 ~ 25GHz
INPUT POWER (SYSTEM)	120Vac, 60 Hz	DETECTOR FUNCTION	Peak (PK) Average (AV)
ENVIRONMENTAL CONDITIONS	21deg. C, 65%RH 1020 hPa	TESTED BY	Lori Chiu

ANTENNA POLARITY & TEST DISTANCE: HORIZONTAL AT 3 M								
NO.	FREQ. (MHz)	EMISSION LEVEL (dBuV/m)	LIMIT (dBuV/m)	MARGIN (dB)	ANTENNA HEIGHT (m)	TABLE ANGLE (Degree)	RAW VALUE (dBuV)	CORRECTION FACTOR (dB/m)
1	*2437.00	106.7 PK			1.10 H	133	74.31	32.39
2	*2437.00	91.4 AV			1.10 H	133	59.01	32.39
3	2500.00	63.5 PK	74.0	-10.5	1.01 H	133	30.88	32.62
4	2500.00	49.0 AV	54.0	-5.0	1.01 H	133	16.38	32.62
5	4874.00	46.5 PK	74.0	-27.5	1.01 H	112	8.09	38.41
6	4874.00	33.9 AV	54.0	-20.1	1.01 H	112	-4.51	38.41
ANTENNA POLARITY & TEST DISTANCE: VERTICAL AT 3 M								
NO.	FREQ. (MHz)	EMISSION LEVEL (dBuV/m)	LIMIT (dBuV/m)	MARGIN (dB)	ANTENNA HEIGHT (m)	TABLE ANGLE (Degree)	RAW VALUE (dBuV)	CORRECTION FACTOR (dB/m)
1	*2437.00	101.9 PK			1.00 V	262	69.51	32.39
2	*2437.00	88.4 AV			1.00 V	262	56.01	32.39
3	2500.00	61.2 PK	74.0	-12.8	1.01 V	280	28.58	32.62
4	2500.00	53.0 AV	54.0	-1.0	1.01 V	280	20.38	32.62
5	4874.00	49.5 PK	74.0	-24.5	1.00 V	155	11.09	38.41
6	4874.00	35.4 AV	54.0	-18.6	1.00 V	155	-3.01	38.41

- REMARKS:**
1. Emission level (dBuV/m) = Raw Value (dBuV) + Correction Factor (dB/m).
  2. Correction Factor (dB/m) = Antenna Factor (dB/m) + Cable Factor (dB).
  3. The other emission levels were very low against the limit.
  4. Margin value = Emission level – Limit value.
  5. “ \* “: Fundamental frequency.





A D T

EUT TEST CONDITION		MEASUREMENT DETAIL	
CHANNEL	Channel 7	FREQUENCY RANGE	1 ~ 25GHz
INPUT POWER (SYSTEM)	120Vac, 60 Hz	DETECTOR FUNCTION	Peak (PK) Average (AV)
ENVIRONMENTAL CONDITIONS	21deg. C, 65%RH 1020 hPa	TESTED BY	Lori Chiu

ANTENNA POLARITY & TEST DISTANCE: HORIZONTAL AT 3 M								
NO.	FREQ. (MHz)	EMISSION LEVEL (dBuV/m)	LIMIT (dBuV/m)	MARGIN (dB)	ANTENNA HEIGHT (m)	TABLE ANGLE (Degree)	RAW VALUE (dBuV)	CORRECTION FACTOR (dB/m)
1	*2452.00	106.7 PK			1.09 H	132	74.21	32.45
2	*2452.00	91.4 AV			1.09 H	132	58.93	32.45
3	2483.50	67.3 PK	74.0	-6.7	1.08 H	132	34.70	32.57
4	2483.50	52.9 AV	54.0	-1.1	1.08 H	132	20.28	32.57
5	2500.00	66.1 PK	74.0	-7.9	1.08 H	130	33.49	32.63
6	2500.00	51.1 AV	54.0	-2.9	1.08 H	130	18.42	32.63
7	4904.00	46.3 PK	74.0	-27.7	1.06 H	220	7.85	38.47
8	4904.00	33.9 AV	54.0	-20.1	1.06 H	220	-4.53	38.47
ANTENNA POLARITY & TEST DISTANCE: VERTICAL AT 3 M								
NO.	FREQ. (MHz)	EMISSION LEVEL (dBuV/m)	LIMIT (dBuV/m)	MARGIN (dB)	ANTENNA HEIGHT (m)	TABLE ANGLE (Degree)	RAW VALUE (dBuV)	CORRECTION FACTOR (dB/m)
1	*2452.00	101.8 PK			1.00 V	265	69.33	32.45
2	*2452.00	88.4 AV			1.00 V	265	55.97	32.45
3	2483.50	66.9 PK	74.0	-7.1	1.01 V	265	34.29	32.56
4	2483.50	51.5 AV	54.0	-2.5	1.01 V	265	18.98	32.56
5	2500.00	60.8 PK	74.0	-13.2	1.55 V	298	28.21	32.62
6	2500.00	50.8 AV	54.0	-3.2	1.55 V	298	18.20	32.62
7	4904.00	49.5 PK	74.0	-24.5	1.29 V	250	11.07	38.46
8	4904.00	35.6 AV	54.0	-18.4	1.29 V	250	-2.91	38.46

- REMARKS:**
1. Emission level (dBuV/m) = Raw Value (dBuV) + Correction Factor (dB/m).
  2. Correction Factor (dB/m) = Antenna Factor (dB/m) + Cable Factor (dB).
  3. The other emission levels were very low against the limit.
  4. Margin value = Emission level – Limit value.
  5. “ \* “: Fundamental frequency.



A D T

**BELOW 1GHz WORST-CASE DATA : 802.11n (40MHz)**

EUT TEST CONDITION		MEASUREMENT DETAIL	
CHANNEL	Channel 1	FREQUENCY RANGE	Below 1000MHz
INPUT POWER (SYSTEM)	120Vac, 60 Hz	DETECTOR FUNCTION	Quasi-Peak
ENVIRONMENTAL CONDITIONS	15deg. C, 63%RH 1020 hPa	TESTED BY	Lori Chiu

ANTENNA POLARITY & TEST DISTANCE: HORIZONTAL AT 3 M								
NO.	FREQ. (MHz)	EMISSION LEVEL (dBuV/m)	LIMIT (dBuV/m)	MARGIN (dB)	ANTENNA HEIGHT (m)	TABLE ANGLE (Degree)	RAW VALUE (dBuV)	CORRECTION FACTOR (dB/m)
1	86.28	31.3 QP	40.0	-8.7	2.00 H	151	22.51	8.79
2	199.05	36.9 QP	43.5	-6.6	1.00 H	106	26.23	10.67
3	333.21	36.9 QP	46.0	-9.1	1.00 H	130	22.45	14.45
4	498.47	38.8 QP	46.0	-7.2	2.00 H	157	19.61	19.19
5	753.18	41.9 QP	46.0	-4.1	1.00 H	157	17.87	24.03
6	877.61	38.4 QP	46.0	-7.6	1.00 H	55	12.50	25.90
ANTENNA POLARITY & TEST DISTANCE: VERTICAL AT 3 M								
NO.	FREQ. (MHz)	EMISSION LEVEL (dBuV/m)	LIMIT (dBuV/m)	MARGIN (dB)	ANTENNA HEIGHT (m)	TABLE ANGLE (Degree)	RAW VALUE (dBuV)	CORRECTION FACTOR (dB/m)
1	59.06	34.4 QP	40.0	-5.6	1.25 V	310	20.98	13.42
2	105.73	36.1 QP	43.5	-7.4	1.00 V	169	26.08	10.02
3	364.32	38.2 QP	46.0	-7.8	1.50 V	178	23.01	15.19
4	750.01	42.6 QP	46.0	-3.4	1.25 V	149	18.65	23.95
5	799.84	39.4 QP	46.0	-6.6	1.00 V	163	14.08	25.32
6	877.61	38.1 QP	46.0	-7.9	1.00 V	220	12.20	25.90

- REMARKS:**
1. Emission level (dBuV/m) = Raw Value (dBuV) + Correction Factor (dB/m).
  2. Correction Factor (dB/m) = Antenna Factor (dB/m) + Cable Factor (dB).
  3. The other emission levels were very low against the limit.
  4. Margin value = Emission level – Limit value.



A D T

## 4.2 CONDUCTED EMISSION MEASUREMENT

### 4.2.1 LIMITS OF CONDUCTED EMISSION MEASUREMENT

FREQUENCY OF EMISSION (MHz)	CONDUCTED LIMIT (dB $\mu$ V)	
	Quasi-peak	Average
0.15 ~ 0.5	66 to 56	56 to 46
0.5 ~ 5	56	46
5 ~ 30	60	50

- NOTE:** 1. The lower limit shall apply at the transition frequencies.  
2. The limit decreases in line with the logarithm of the frequency in the range of 0.15 to 0.50MHz.  
3. All emanations from a class A/B digital device or system, including any network of conductors and apparatus connected thereto, shall not exceed the level of field strengths specified above.

### 4.2.2 TEST INSTRUMENTS

DESCRIPTION & MANUFACTURER	MODEL NO.	SERIAL NO.	DATE OF CALIBRATION	DUE DATE OF CALIBRATION
Test Receiver ROHDE & SCHWARZ	ESCS30	100289	Nov. 23, 2009	Nov. 22, 2010
RF signal cable Woken	5D-FB	Cable-HYC01-01	Dec. 31, 2008	Dec. 30, 2009
LISN ROHDE & SCHWARZ	ESH3-Z5	100312	Jun. 18, 2009	Jun. 17, 2010
LISN ROHDE & SCHWARZ	ESH3-Z5	835239/001	Feb. 24, 2009	Feb. 23, 2010
Software ADT	ADT_Cond_ V7.3.7	NA	NA	NA

- NOTE:** 1. The calibration interval of the above test instruments is 12 months and the calibrations are traceable to NML/ROC and NIST/USA.  
2. The test was performed in HwaYa Shielded Room 1.  
3. The VCCI Site Registration No. is C-2040.



A D T

#### 4.2.3 TEST PROCEDURES

- a. The EUT was placed 0.4 meters from the conducting wall of the shielded room with EUT being connected to the power mains through a line impedance stabilization network (LISN). Other support units were connected to the power mains through another LISN. The two LISNs provide 50 ohm/ 50uH of coupling impedance for the measuring instrument.
- b. Both lines of the power mains connected to the EUT were checked for maximum conducted interference.
- c. The frequency range from 150kHz to 30MHz was searched. Emission levels under (Limit - 20dB) was not recorded.

**NOTE:** All modes of operation were investigated and the worst-case emissions are reported.

#### 4.2.4 DEVIATION FROM TEST STANDARD

No deviation

#### 4.2.5 TEST SETUP

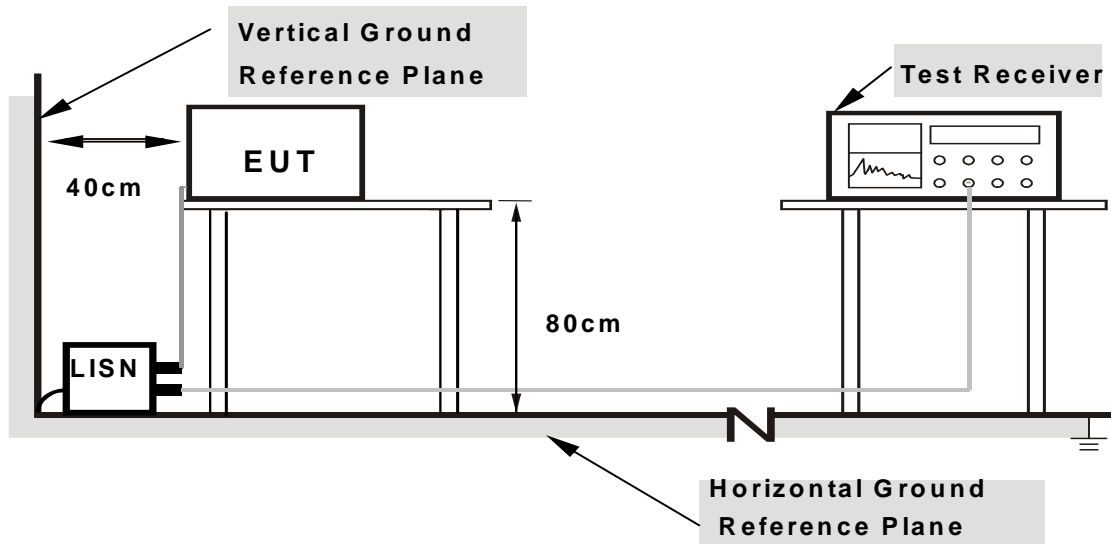

**Note: 1. Support units were connected to second LISN.**

**2. Both of LISNs (AMN) are 80 cm from EUT and at least 80 cm from other units and other metal planes**

For the actual test configuration, please refer to the attached file (Test Setup Photo).

#### 4.2.6 EUT OPERATING CONDITIONS

Same as 4.1.6.

### 4.2.7 TEST RESULTS

#### CONDUCTED WORST-CASE DATA : 802.11n (40MHz)

PHASE	Line 1	6dB BANDWIDTH	9kHz
-------	--------	---------------	------

No	Freq. [MHz]	Corr. Factor (dB)	Reading Value [dB (uV)]		Emission Level [dB (uV)]		Limit [dB (uV)]		Margin (dB)	
			Q.P.	AV.	Q.P.	AV.	Q.P.	AV.	Q.P.	AV.
1	0.154	0.13	51.11	-	51.24	-	65.79	55.79	-14.55	-
2	0.240	0.13	42.70	-	42.83	-	62.10	52.10	-19.27	-
3	0.310	0.14	34.72	-	34.86	-	59.97	49.97	-25.11	-
4	0.677	0.14	34.59	-	34.73	-	56.00	46.00	-21.27	-
5	7.891	0.60	36.95	-	37.55	-	60.00	50.00	-22.45	-
6	19.191	1.32	35.20	-	36.52	-	60.00	50.00	-23.48	-

- REMARKS:**
1. Q.P. and AV. are abbreviations of quasi-peak and average individually.
  2. "-": The Quasi-peak reading value also meets average limit and measurement with the average detector is unnecessary.
  3. The emission levels of other frequencies were very low against the limit.
  4. Margin value = Emission level - Limit value
  5. Correction factor = Insertion loss + Cable loss
  6. Emission Level = Correction Factor + Reading Value.

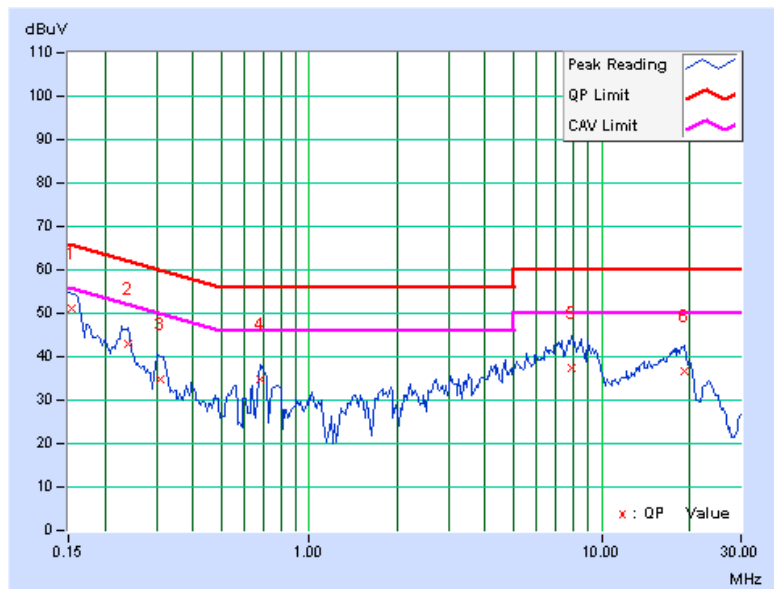

PHASE	Line 2	6dB BANDWIDTH	9kHz
-------	--------	---------------	------

No	Freq. [MHz]	Corr. Factor (dB)	Reading Value		Emission Level		Limit		Margin	
			[dB (uV)]		[dB (uV)]		[dB (uV)]		(dB)	
			Q.P.	AV.	Q.P.	AV.	Q.P.	AV.	Q.P.	AV.
1	0.158	0.09	51.74	-	51.83	-	65.58	55.58	-13.75	-
2	0.232	0.09	42.11	-	42.20	-	62.38	52.38	-20.18	-
3	0.302	0.10	35.36	-	35.46	-	60.18	50.18	-24.72	-
4	0.685	0.10	32.78	-	32.88	-	56.00	46.00	-23.12	-
5	7.879	0.46	36.53	-	36.99	-	60.00	50.00	-23.01	-
6	18.531	0.88	33.70	-	34.58	-	60.00	50.00	-25.42	-

- REMARKS:**
1. Q.P. and AV. are abbreviations of quasi-peak and average individually.
  2. "-": The Quasi-peak reading value also meets average limit and measurement with the average detector is unnecessary.
  3. The emission levels of other frequencies were very low against the limit.
  4. Margin value = Emission level - Limit value
  5. Correction factor = Insertion loss + Cable loss
  6. Emission Level = Correction Factor + Reading Value.

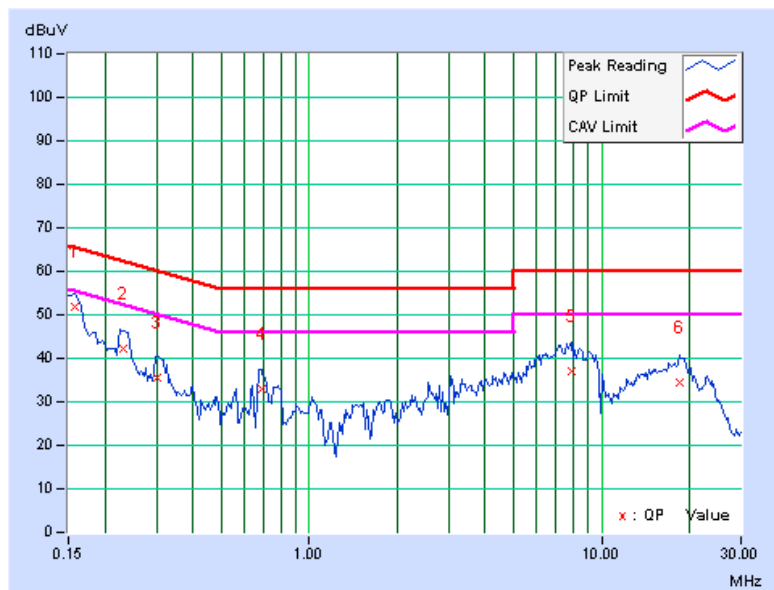



A D T

### 4.3 6dB BANDWIDTH MEASUREMENT

#### 4.3.1 LIMITS OF 6dB BANDWIDTH MEASUREMENT

The minimum of 6dB Bandwidth Measurement is 0.5 MHz.

#### 4.3.2 TEST INSTRUMENTS

DESCRIPTION & MANUFACTURER	MODEL NO.	SERIAL NO.	DATE OF CALIBRATION	DUE DATE OF CALIBRATION
R&S SPECTRUM ANALYZER	FSP40	100040	Jul. 07, 2009	Jul. 06, 2010

**NOTE:** The calibration interval of the above test instruments is 12 months and the calibrations are traceable to NML/ROC and NIST/USA.

#### 4.3.3 TEST PROCEDURE

The transmitter output was connected to the spectrum analyzer through an attenuator. The bandwidth of the fundamental frequency was measured by spectrum analyzer with 100kHz RBW and 300kHz VBW. The 6dB bandwidth is defined as the total spectrum the power of which is higher than peak power minus 6dB.

#### 4.3.4 DEVIATION FROM TEST STANDARD

No deviation



#### 4.3.5 TEST SETUP

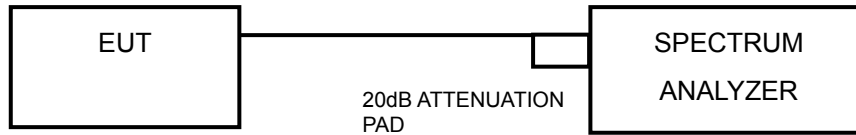

#### 4.3.6 EUT OPERATING CONDITIONS

The software provided by client to enable the EUT under transmission condition continuously at lowest, middle and highest channel frequencies individually.



A D T

### 4.3.7 TEST RESULTS

#### 802.11b

CHANNEL	CHANNEL FREQUENCY (MHz)	6dB BANDWIDTH (MHz)	MINIMUM LIMIT (MHz)	PASS / FAIL
1	2412	8.08	0.5	PASS
6	2437	8.10	0.5	PASS
11	2462	7.64	0.5	PASS

#### CH 6

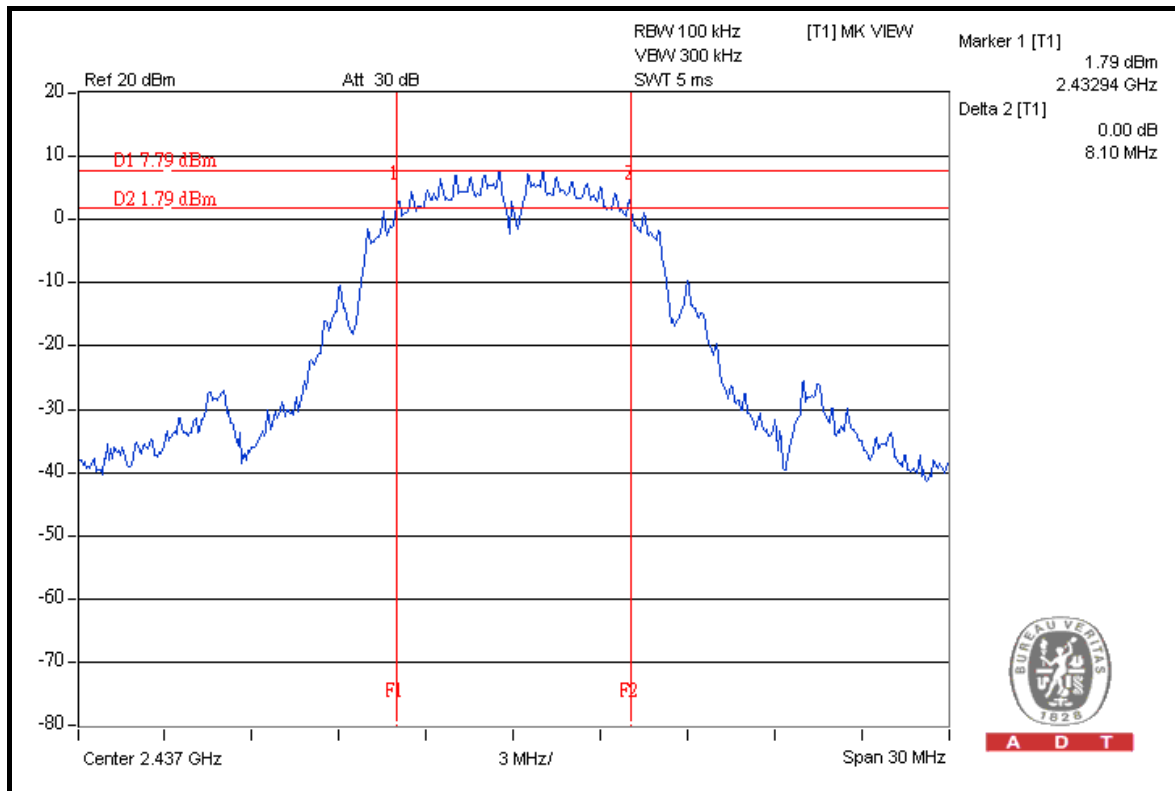



A D T

### 802.11g (Antenna A)

CHANNEL	CHANNEL FREQUENCY (MHz)	6dB BANDWIDTH (MHz)	MINIMUM LIMIT (MHz)	PASS / FAIL
1	2412	15.13	0.5	PASS
6	2437	14.46	0.5	PASS
11	2462	15.18	0.5	PASS

### CH 11

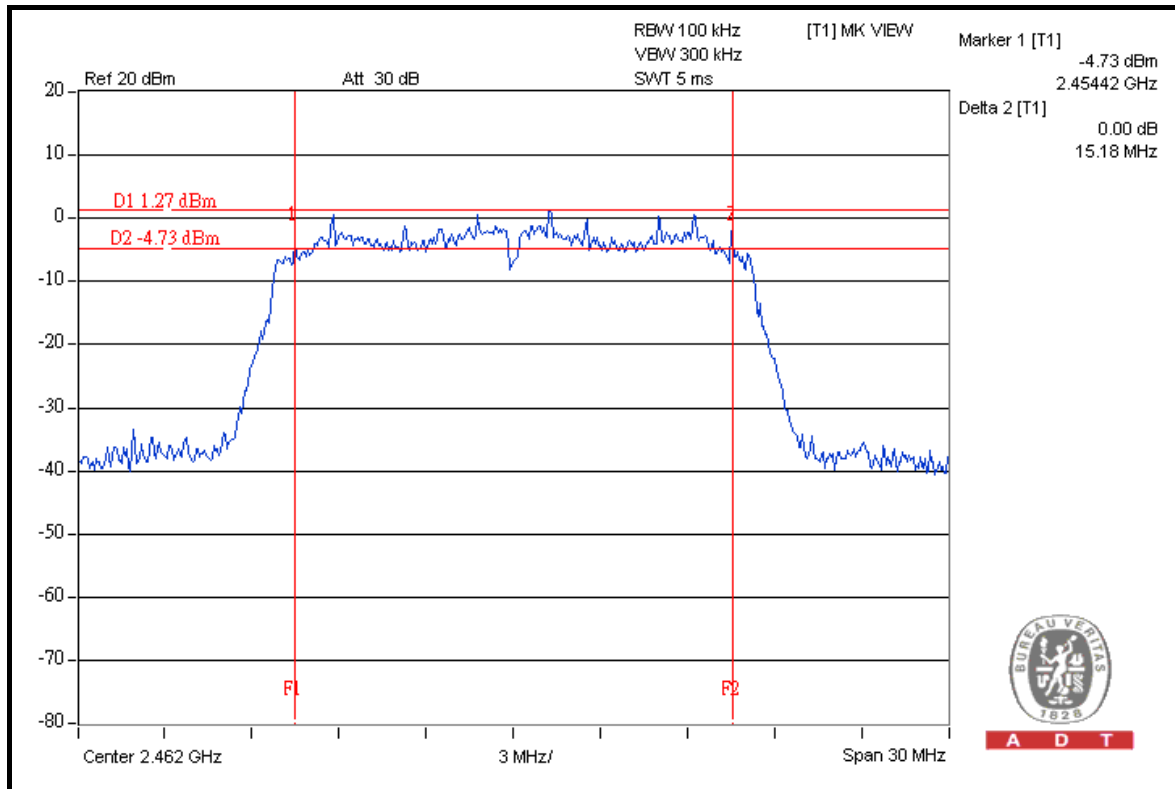



A D T

### 802.11g (Antenna B)

CHANNEL	CHANNEL FREQUENCY (MHz)	6dB BANDWIDTH (MHz)	MINIMUM LIMIT (MHz)	PASS / FAIL
1	2412	14.55	0.5	PASS
6	2437	14.59	0.5	PASS
11	2462	15.15	0.5	PASS

### CH 11

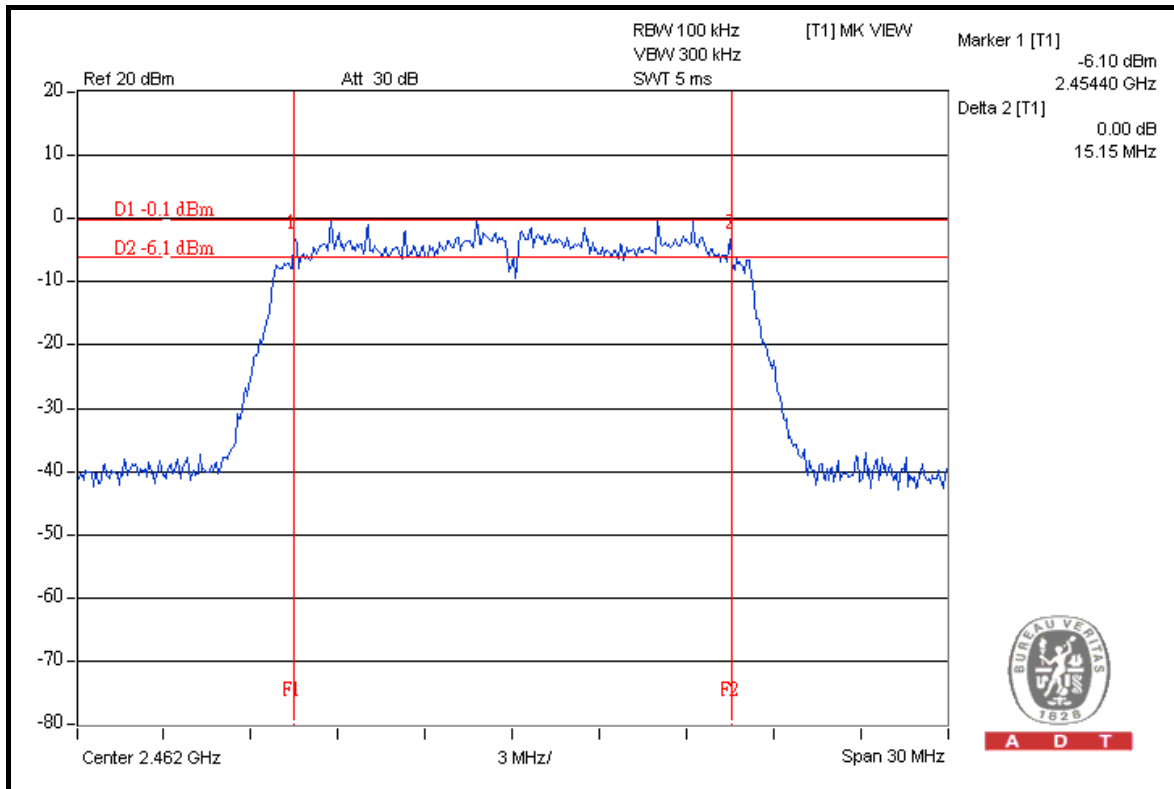



A D T

### 802.11n (20MHz)

CHANNEL	CHANNEL FREQUENCY (MHz)	6dB BANDWIDTH (MHz)		MINIMUM LIMIT (MHz)	PASS / FAIL
		CHAIN 0	CHAIN 1		
1	2412	15.17	15.67	0.5	PASS
6	2437	15.99	16.41	0.5	PASS
11	2462	15.13	17.35	0.5	PASS

### FOR CHAIN 1: CH 11

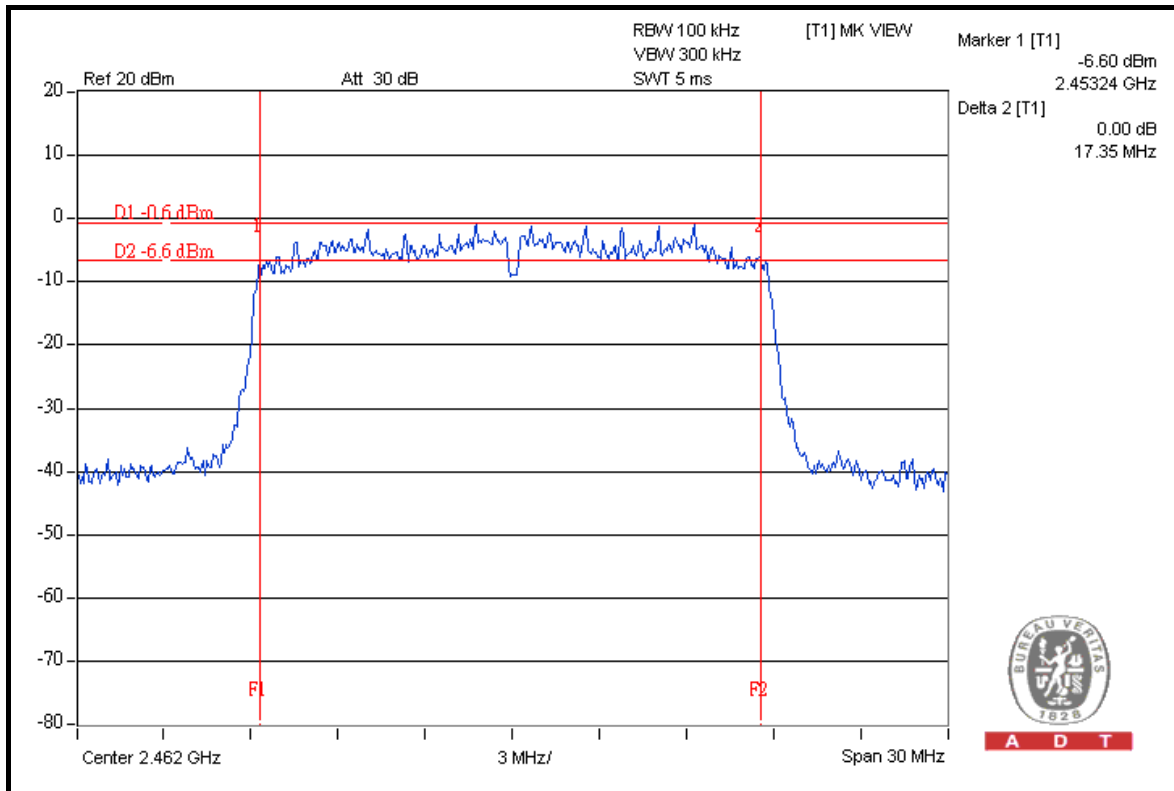



A D T

### 802.11n (40MHz)

<b>MODULATION TYPE</b>	BPSK	<b>TRANSFER RATE</b>	15Mbps
<b>INPUT POWER (SYSTEM)</b>	120Vac, 60Hz	<b>ENVIRONMENTAL CONDITIONS</b>	25deg.C, 63%RH, 991hPa
<b>TESTED BY</b>	Dean Wang		

CHANNEL	CHANNEL FREQUENCY (MHz)	6dB BANDWIDTH (MHz)		MINIMUM LIMIT (MHz)	PASS / FAIL
		CHAIN 0	CHAIN 1		
1	2422	36.35	36.44	0.5	PASS
4	2437	36.46	36.52	0.5	PASS
7	2452	36.04	36.50	0.5	PASS

### FOR CHAIN 1: CH 4

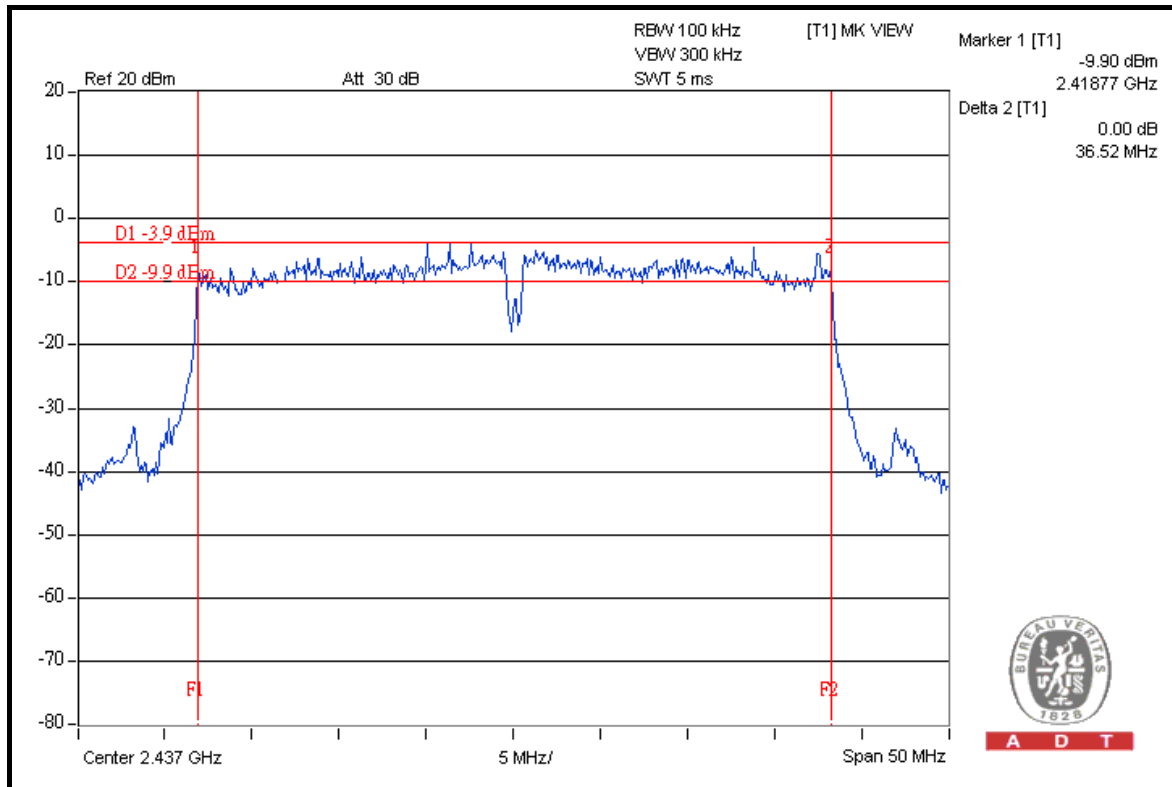

A D T



A D T

## 4.4 MAXIMUM OUTPUT POWER

### 4.4.1 LIMITS OF MAXIMUM OUTPUT POWER MEASUREMENT

The Maximum Output Power Measurement is 30dBm.

### 4.4.2 INSTRUMENTS

DESCRIPTION & MANUFACTURER	MODEL NO.	SERIAL NO.	DATE OF CALIBRATION	DUE DATE OF CALIBRATION
High Speed Peak Power Meter	ML2495A	0824012	Aug. 10, 2009	Aug. 09, 2010
Power Sensor	MA2411B	0738138	Aug. 10, 2009	Aug. 09, 2010

**Note:**

1. The calibration interval of the above test instruments is 12 months and the calibrations are traceable to NML/ROC and NIST/USA.
2. Measurement Bandwidth of ML2495A is 65MHz greater than 6dB bandwidth of emission.

### 4.4.3 TEST PROCEDURES

A power sensor was used on the output port of the EUT. A power meter was used to read the response of the power sensor. Record the power level.

#### 4.4.4 DEVIATION FROM TEST STANDARD

No deviation

#### 4.4.5 TEST SETUP

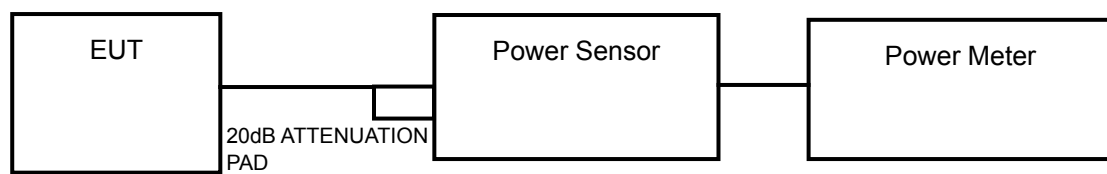

#### 4.4.6 EUT OPERATING CONDITIONS

Same as Item 4.3.6





## 4.4.7 TEST RESULTS

## 802.11b

CHAN.	CHAN. FREQ. (MHz)	POWER OUTPUT (dBm)	POWER (mW)	POWER LIMIT (dBm)	PASS / FAIL
1	2412	21.1	128.8	30	PASS
6	2437	21.1	128.8	30	PASS
11	2462	21.2	131.8	30	PASS

## 802.11g (Antenna A)

CHAN.	CHAN. FREQ. (MHz)	POWER OUTPUT (dBm)	POWER (mW)	POWER LIMIT (dBm)	PASS / FAIL
1	2412	22.1	162.2	30	PASS
6	2437	22.3	169.8	30	PASS
11	2462	22.1	162.2	30	PASS

## 802.11g (Antenna B)

CHAN.	CHAN. FREQ. (MHz)	POWER OUTPUT (dBm)	POWER (mW)	POWER LIMIT (dBm)	PASS / FAIL
1	2412	22.3	169.8	30	PASS
6	2437	22.2	166.0	30	PASS
11	2462	20.6	114.8	30	PASS

## 802.11n (20MHz)

CHAN.	CHAN. FREQ. (MHz)	POWER OUTPUT (dBm)		TOTAL POWER (mW)	TOTAL POWER (dBm)	POWER LIMIT (dBm)	PASS / FAIL
		CHAIN 0	CHAIN 1				
1	2412	20.4	21.1	238.5	23.8	30	PASS
6	2437	20.3	21.4	245.2	23.9	30	PASS
11	2462	20.2	20.7	222.2	23.5	30	PASS

## 802.11n (40MHz)

CHAN.	CHAN. FREQ. (MHz)	POWER OUTPUT (dBm)		TOTAL POWER (mW)	TOTAL POWER (dBm)	POWER LIMIT (dBm)	PASS / FAIL
		CHAIN 0	CHAIN 1				
1	2422	20.8	21.1	249.1	24.0	30	PASS
4	2437	20.3	20.2	211.9	23.3	30	PASS
7	2452	20.3	20.2	211.9	23.3	30	PASS



A D T

## 4.5 POWER SPECTRAL DENSITY MEASUREMENT

### 4.5.1 LIMITS OF POWER SPECTRAL DENSITY MEASUREMENT

The Maximum of Power Spectral Density Measurement is 8dBm.

### 4.5.2 TEST INSTRUMENTS

DESCRIPTION & MANUFACTURER	MODEL NO.	SERIAL NO.	DATE OF CALIBRATION	DUE DATE OF CALIBRATION
R&S SPECTRUM ANALYZER	FSP40	100040	Jul. 07, 2009	Jul. 06, 2010

**NOTE:** The calibration interval of the above test instruments is 12 months and the calibrations are traceable to NML/ROC and NIST/USA.

### 4.5.3 TEST PROCEDURE

The transmitter output was connected to the spectrum analyzer through an attenuator, the bandwidth of the fundamental frequency was measured with the spectrum analyzer using 3kHz RBW and 30kHz VBW, set sweep time = span/3kHz. The power spectral density was measured and recorded.

The sweep time is allowed to be longer than span/3kHz for a full response of the mixer in the spectrum analyzer.

#### 4.5.4 DEVIATION FROM TEST STANDARD

No deviation

#### 4.5.5 TEST SETUP

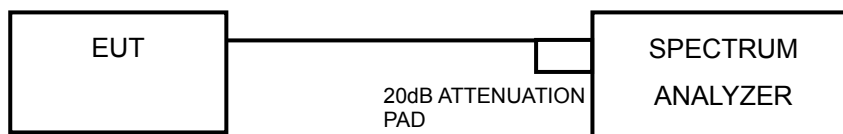

#### 4.5.6 EUT OPERATING CONDITION

Same as Item 4.3.6



A D T

### 4.5.7 TEST RESULTS

#### 802.11b

CHANNEL	CHANNEL FREQUENCY (MHz)	RF POWER LEVEL IN 3 kHz BW (dBm)	MAXIMUM LIMIT (dBm)	PASS/FAIL
1	2412	-6.1	8	PASS
6	2437	-5.9	8	PASS
11	2462	-6.2	8	PASS

#### CH 6

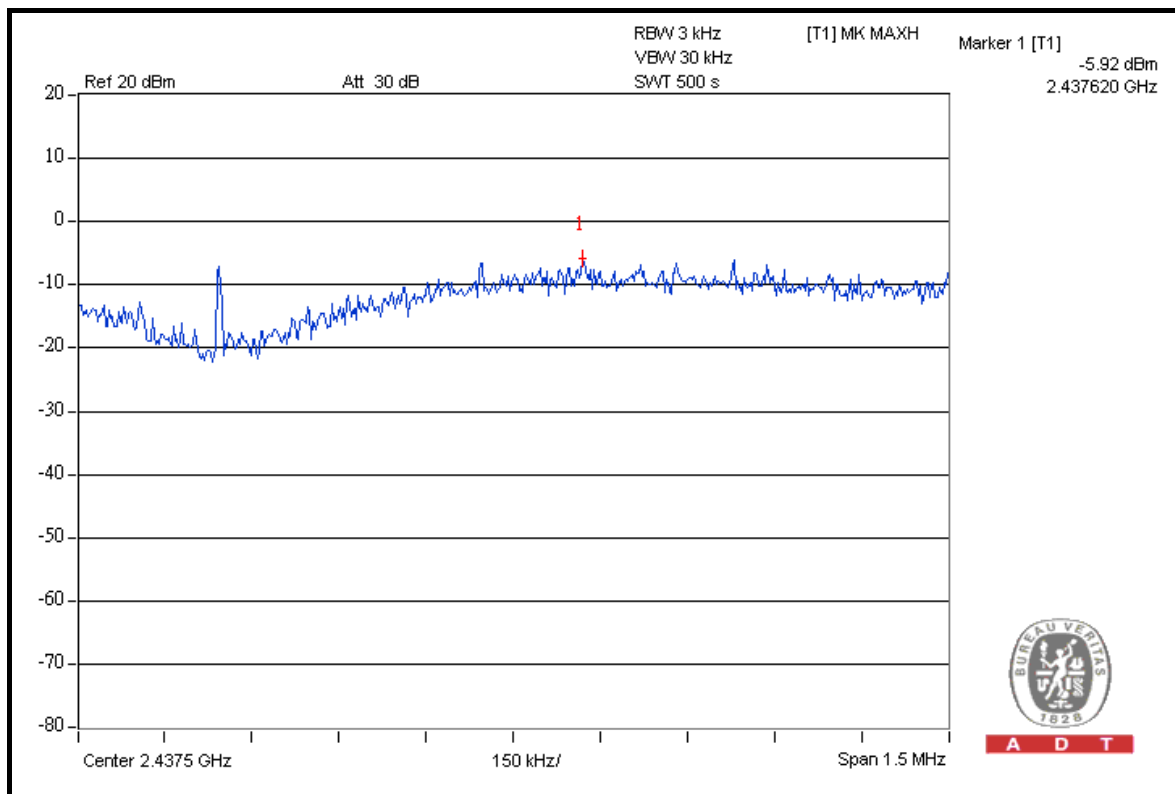



A D T

### 802.11g (Antenna A)

CHANNEL	CHANNEL FREQUENCY (MHz)	RF POWER LEVEL IN 3 kHz BW (dBm)	MAXIMUM LIMIT (dBm)	PASS/FAIL
1	2412	-11.6	8	PASS
6	2437	-11.2	8	PASS
11	2462	-11.3	8	PASS

### CH 6

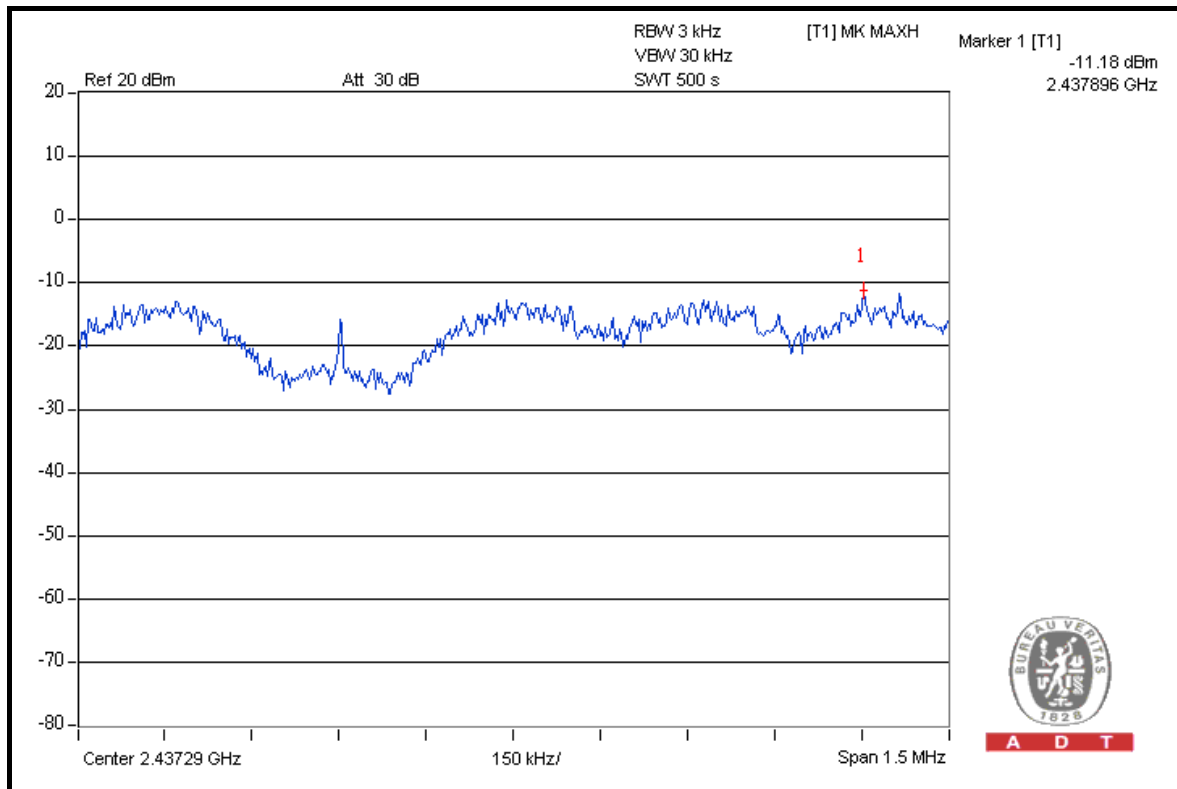



A D T

### 802.11g (Antenna B)

CHANNEL	CHANNEL FREQUENCY (MHz)	RF POWER LEVEL IN 3 kHz BW (dBm)	MAXIMUM LIMIT (dBm)	PASS/FAIL
1	2412	-11.1	8	PASS
6	2437	-11.1	8	PASS
11	2462	-12.5	8	PASS

### CH 1

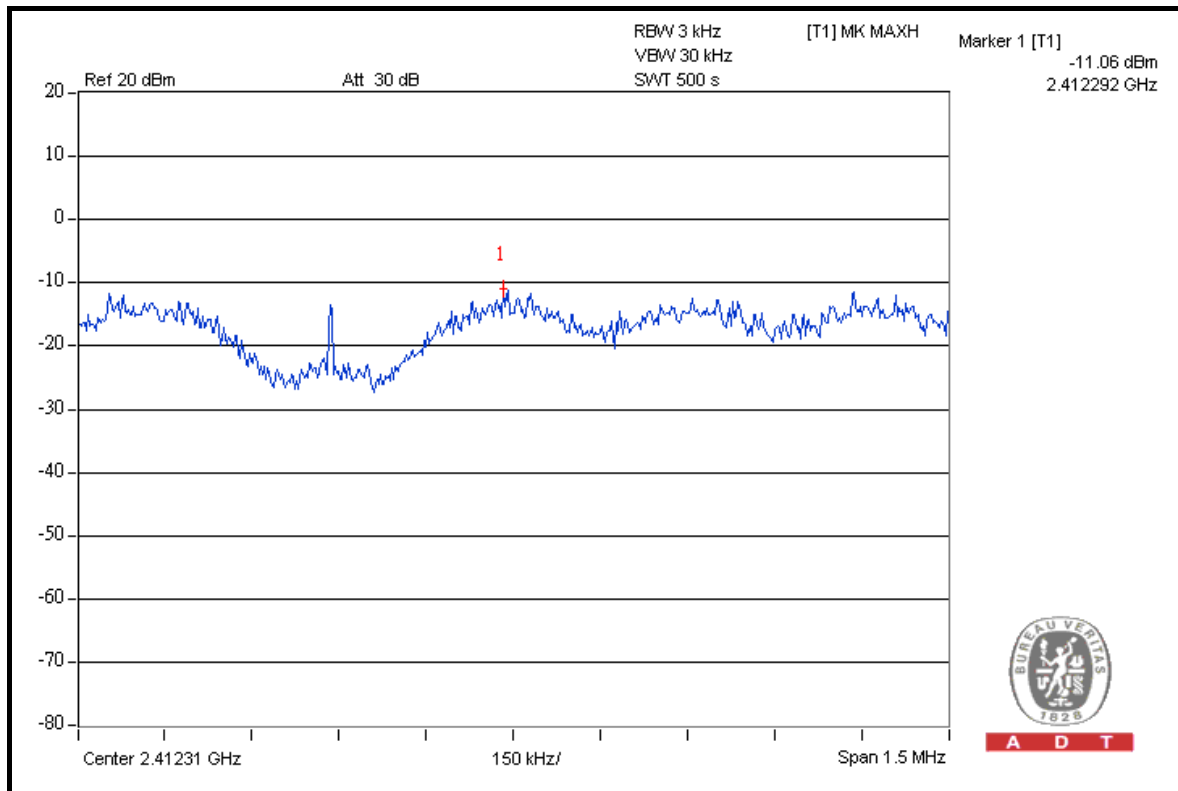



A D T

### 802.11n (20MHz)

CHANNEL	CHAN. FREQ. (MHz)	RF POWER LEVEL IN 3 kHz BW (dBm)		TOTAL POWER DENSITY (dBm)	MAXIMUM LIMIT (dBm)	PASS/FAIL
		CHAIN 0	CHAIN 1			
1	2412	-13.7	-11.8	-9.6	8	PASS
6	2437	-13.9	-11.4	-9.4	8	PASS
11	2462	-13.7	-11.9	-9.7	8	PASS

### FOR CHAIN 1: CH 6

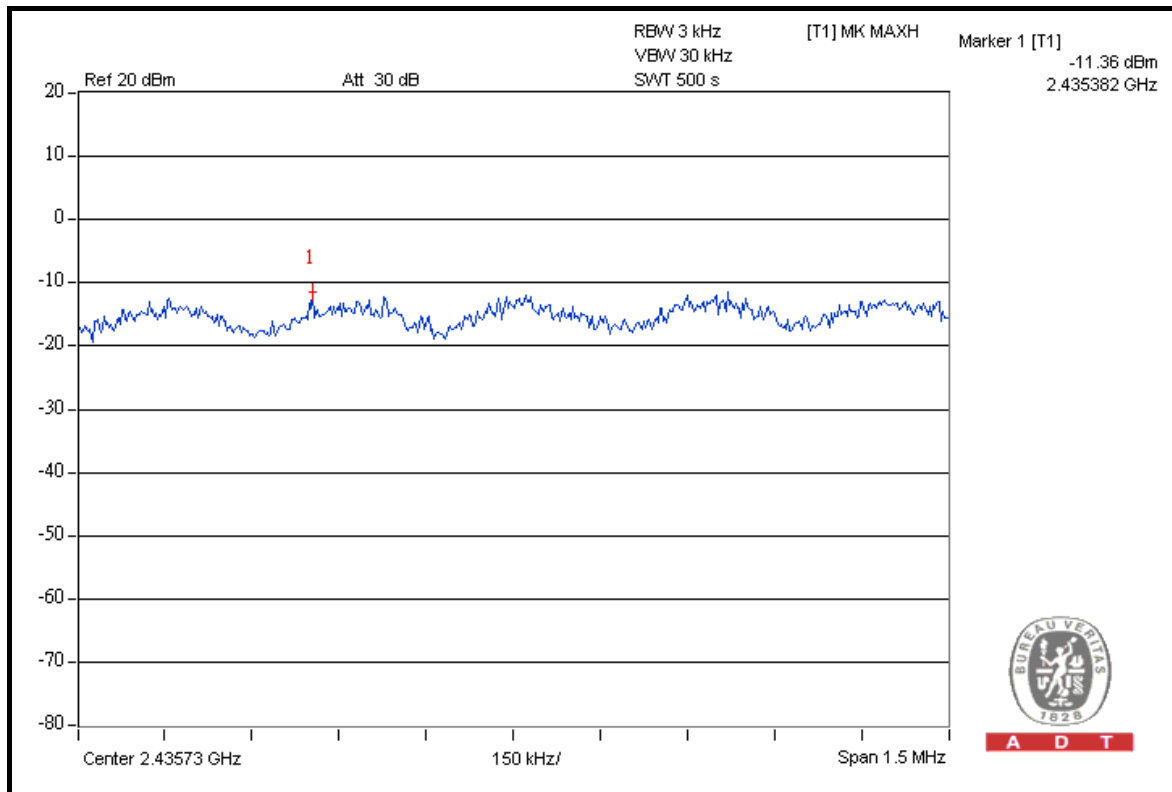



A D T

### 802.11n (40MHz)

CHANNEL	CHAN. FREQ. (MHz)	RF POWER LEVEL IN 3 kHz BW (dBm)		TOTAL POWER DENSITY (dBm)	MAXIMUM LIMIT (dBm)	PASS/FAIL
		CHAIN 0	CHAIN 1			
1	2422	-16.1	-15.4	-12.8	8	PASS
4	2437	-16.4	-16.2	-13.3	8	PASS
7	2452	-16.5	-16.1	-13.3	8	PASS

### FOR CHAIN 1: CH 1

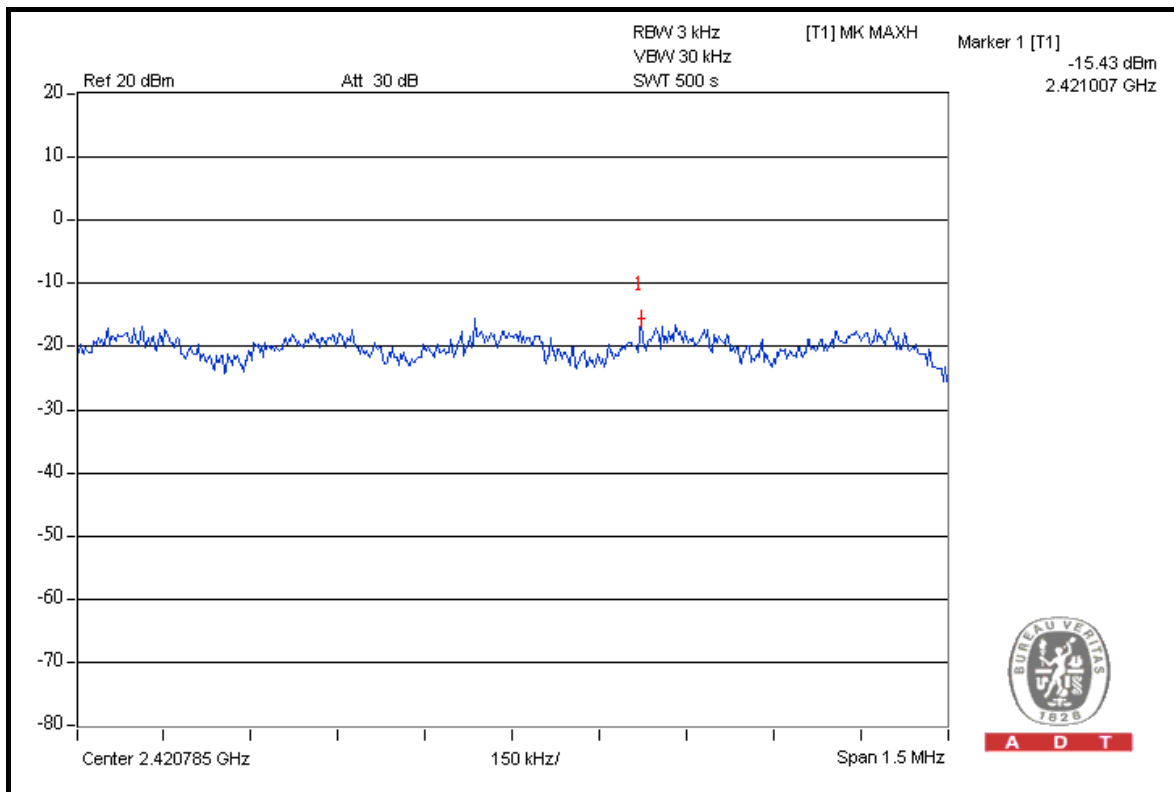





ADT

## 4.6 BAND EDGES MEASUREMENT

### 4.6.1 LIMITS OF BAND EDGES MEASUREMENT

Below -20dB of the highest emission level of operating band (in 100kHz Resolution Bandwidth).

### 4.6.2 TEST INSTRUMENTS

DESCRIPTION & MANUFACTURER	MODEL NO.	SERIAL NO.	DATE OF CALIBRATION	CALIBRATED UNTIL
<b>FOR CONDUCTED MEASUREMENT</b>				
R&S SPECTRUM ANALYZER	FSP40	100040	Jul. 07, 2009	Jul. 06, 2010
<b>FOR RADIATED MEASUREMENT</b>				
Test Receiver ROHDE & SCHWARZ	ESIB7	100212	May 25, 2009	May 24, 2010
Spectrum Analyzer ROHDE & SCHWARZ	FSP40	100040	Jul. 07, 2009	Jul. 06, 2010
BILOG Antenna SCHWARZBECK	VULB9168	9168-156	Apr. 30, 2009	Apr. 29, 2010
HORN Antenna SCHWARZBECK	BBHA 9120 D	9120D-563	Aug. 10, 2009	Aug. 09, 2010
HORN Antenna SCHWARZBECK	BBHA 9170	BBHA9170242	Jan. 06, 2009	Jan. 05, 2010
Preamplifier Agilent	8449B	3008A01910	Sep. 11, 2009	Sep. 10, 2010
Preamplifier Agilent	8447D	2944A10738	Nov. 04, 2009	Nov. 03, 2010
RF signal cable HUBER+SUHNNER	SUCOFLEX 104	218190/4 231241/4	May 13, 2009	May 12, 2010
RF signal cable Worken	8D-FB	Cable-HYCH9-01	Aug. 17, 2009	Aug. 16, 2010
Software	ADT_Radiated_ V7.6.15.9.2	NA	NA	NA
Antenna Tower EMCO	2070/2080	512.835.4684	NA	NA
Turn Table EMCO	2087-2.03	NA	NA	NA
Antenna Tower & Turn Table Controller EMCO	2090	NA	NA	NA

**NOTE:** The calibration interval of the above test instruments is 12 months and the calibrations are traceable to NML/ROC and NIST/USA.



A D T

#### 4.6.3 TEST PROCEDURE

##### FOR CONDUCTED MEASUREMENT

The transmitter output was connected to the spectrum analyzer via a low loss cable. Set both RBW and VBW of spectrum analyzer to 100kHz and 300kHz with suitable frequency span including 100MHz bandwidth from band edge. The band edges was measured and recorded.

The spectrum plots (Peak RBW = 100kHz, VBW = 300kHz; Average RBW = 1MHz, VBW = 10Hz) are attached on the following pages.

##### FOR RADIATED MEASUREMENT

- a. The EUT was placed on the top of a rotating table 0.8 meters above the ground at a 3 meter semi-anechoic chamber. The table was rotated 360 degrees to determine the position of the highest radiation.
- b. The EUT was set 3 meters away from the interference-receiving antenna, which was mounted on the top of a variable-height antenna tower.
- c. The antenna is a broadband antenna, and its height is varied from one meter to four meters above the ground to determine the maximum value of the field strength. Both horizontal and vertical polarizations of the antenna are set to make the measurement.
- d. For each suspected emission, the EUT was arranged to its worst case and then the antenna was tuned to heights from 1 meter to 4 meters and the rotatable table was turned from 0 degrees to 360 degrees to find the maximum reading.
- e. Set both RBW and VBW of spectrum analyzer to 100kHz and 300kHz with suitable frequency span including 100MHz bandwidth from band edge. The band edges was measured and recorded.

The spectrum plots (Peak RBW = 100kHz, VBW = 300kHz) are attached on the following pages.

**NOTE:** The resolution bandwidth of test receiver/spectrum analyzer is 1MHz and the video bandwidth is 10Hz for Average detection (AV) at frequency above 1GHz.

#### 4.6.4 DEVIATION FROM TEST STANDARD

No deviation

#### 4.6.5 EUT OPERATING CONDITION

Same as Item 4.3.6



#### 4.6.6 TEST RESULTS

The spectrum plots are attached on the following pages. D1 line indicates the highest level, and D2 line indicates the 20dB offset below D1. It shows compliance with the requirement in part 15.247(d).

#### 802.11b

##### RESTRICT BAND (2310 ~ 2390 MHz)

FREQUENCY (MHz)	FUNDAMENTAL EMISSION (dBuV/m)	DELTA (dB)	MAXIMUM FIELD STRENGTH IN RESTRICT BAND (dBuV/m)	LIMIT (dBuV/m)
2412.00 (PK)	108.6	53.00	55.60	74.00
2412.00 (AV)	103.6	58.28	45.32	54.00

##### RESTRICT BAND (2483.5 ~ 2500 MHz)

FREQUENCY (MHz)	FUNDAMENTAL EMISSION (dBuV/m)	DELTA (dB)	MAXIMUM FIELD STRENGTH IN RESTRICT BAND (dBuV/m)	LIMIT (dBuV/m)
2462.00 (PK)	108.4	52.93	55.47	74.00
2462.00 (AV)	103.3	56.78	46.52	54.00

#### NOTE:

1. Delta = Amplitude between the peak of the fundamental and the peak of the band edge emission. Please check following 3 pages.
2. Maximum field strength in restrict band = Fundamental emission – Delta.



A D T

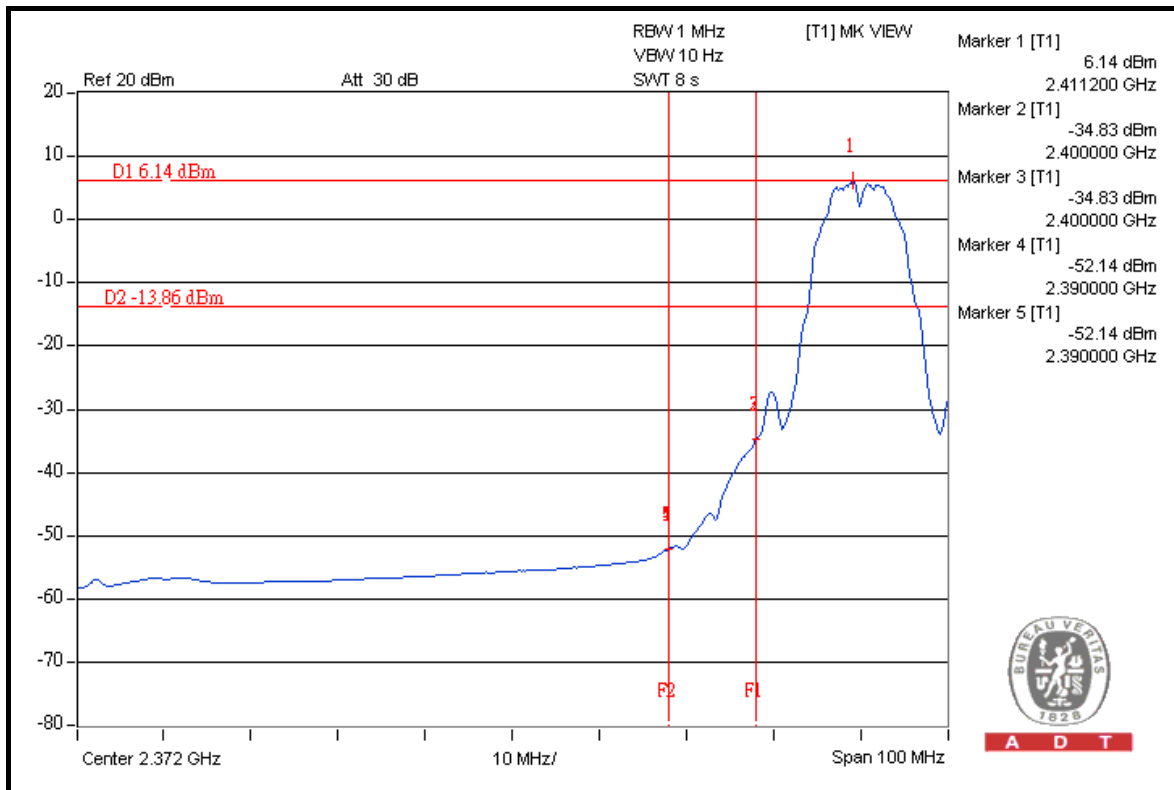
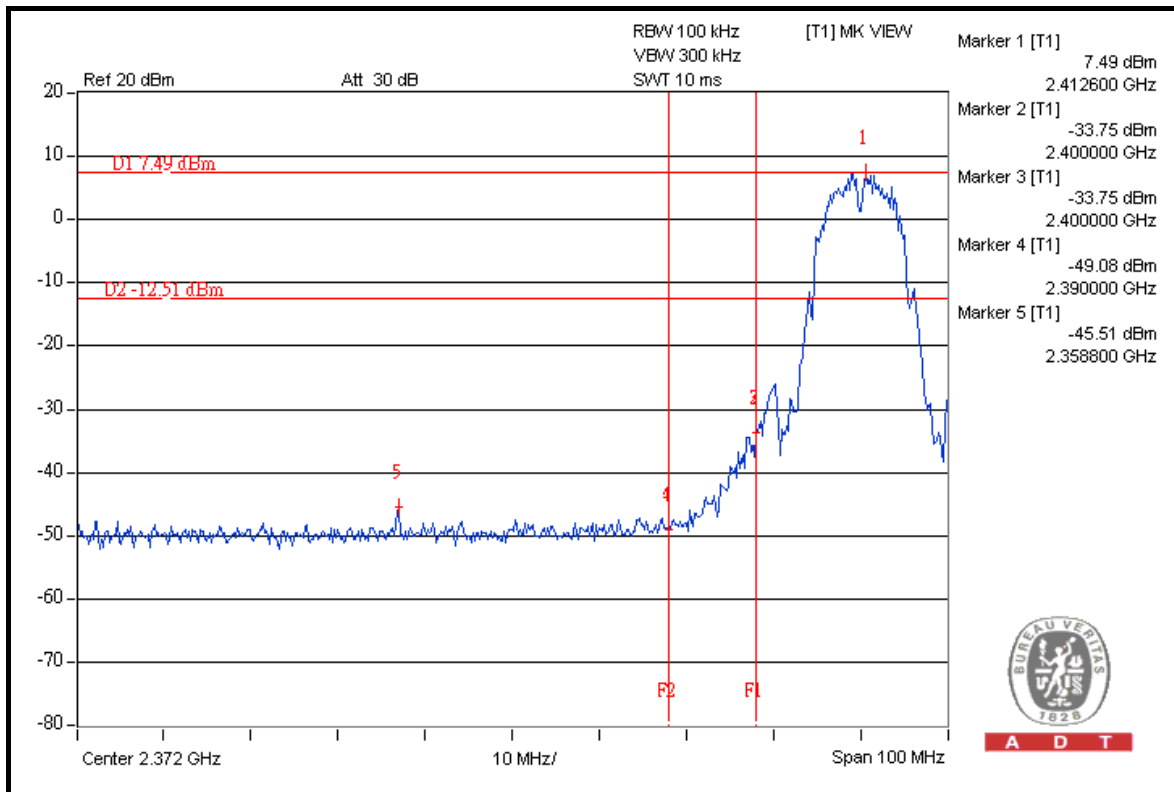



A D T

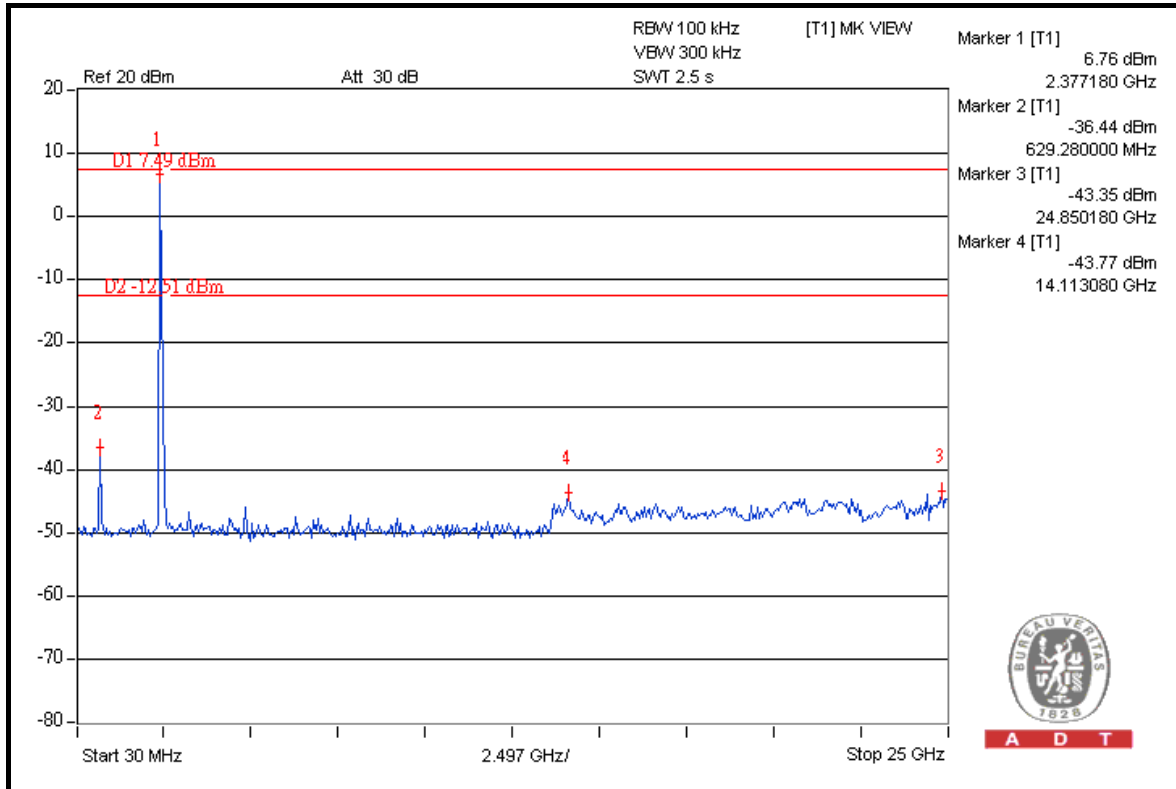

A D T

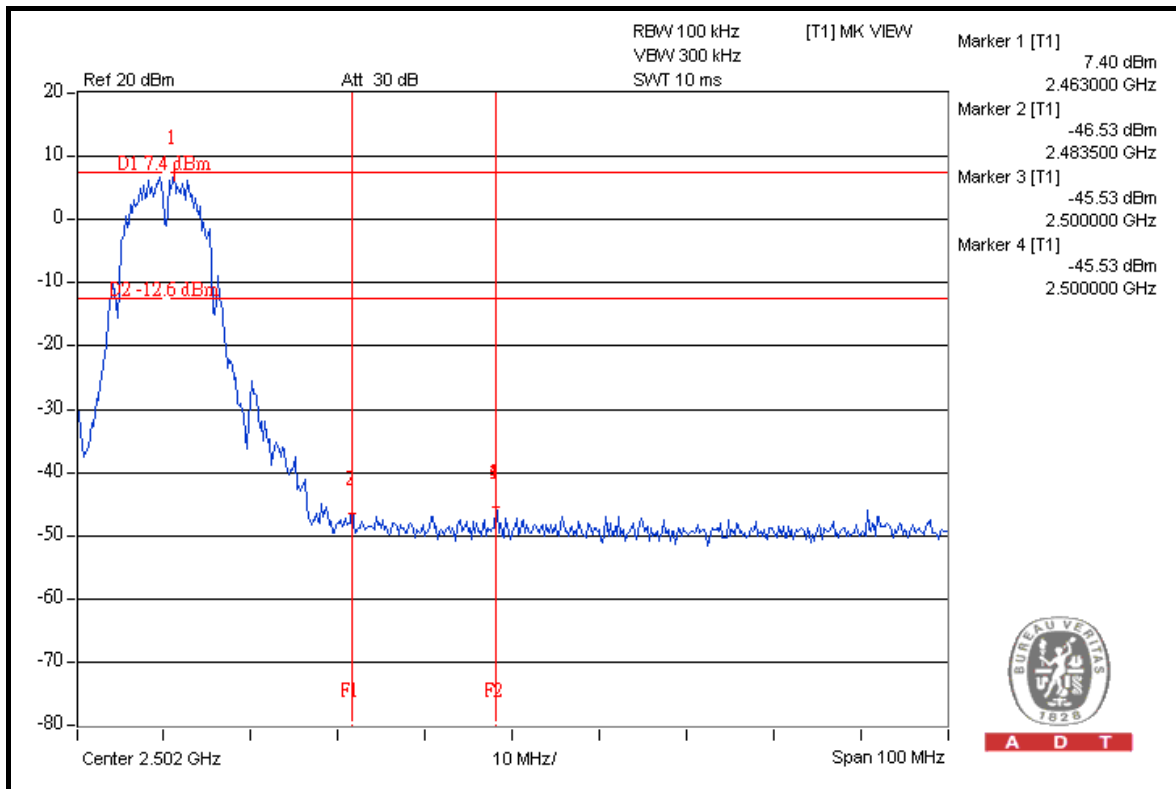

A D T



A D T

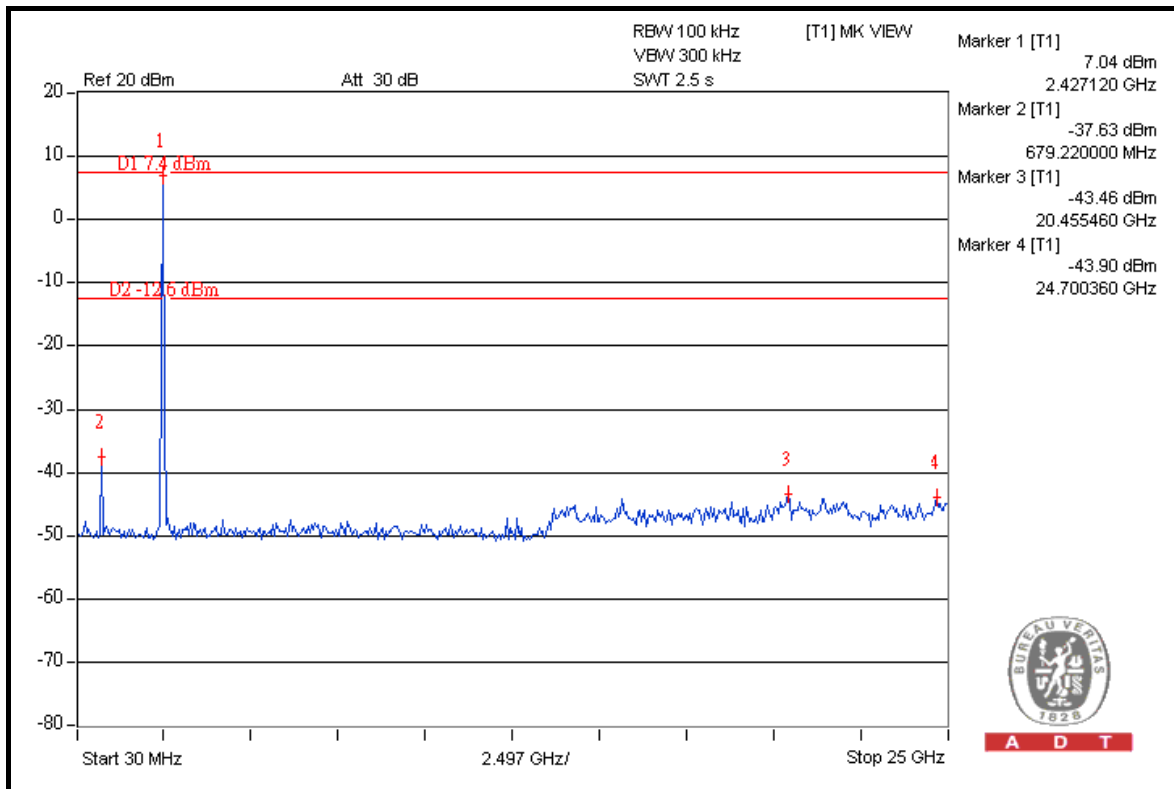
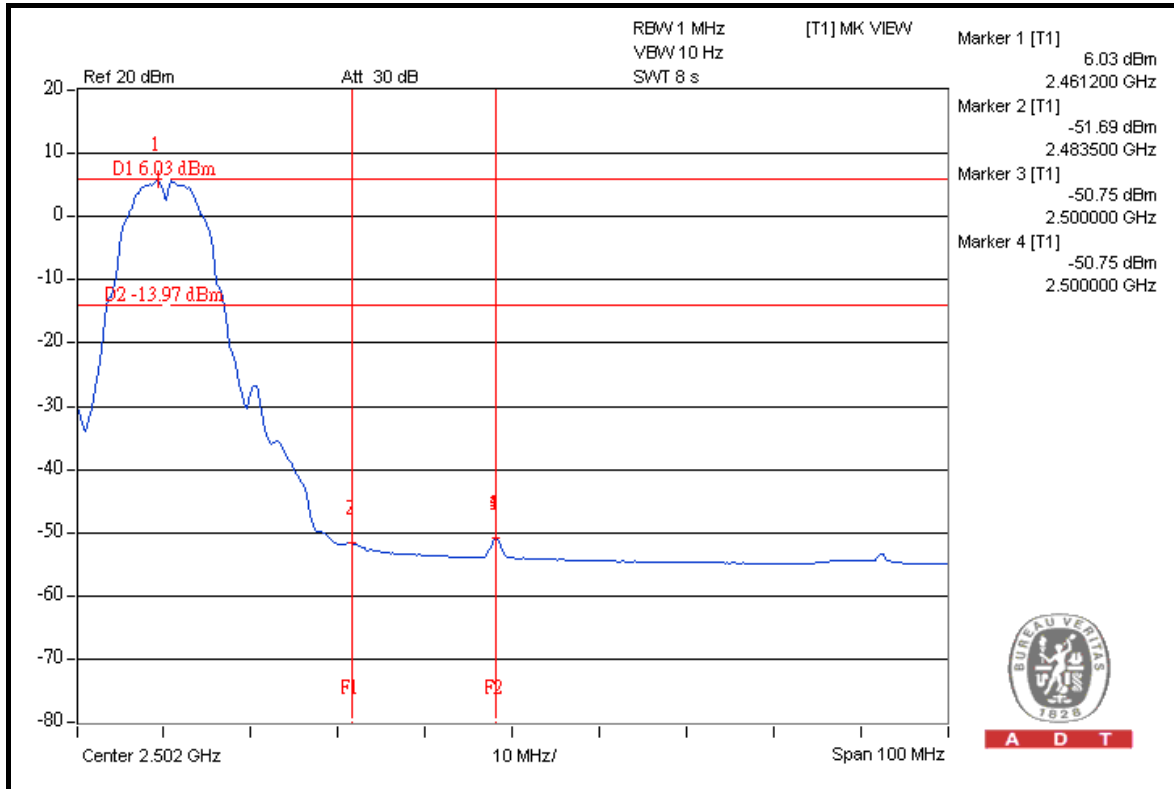



A D T

## 802.11g (Antenna A)

### RESTRICT BAND (2310 ~ 2390 MHz)

FREQUENCY (MHz)	FUNDAMENTAL EMISSION (dBuV/m)	DELTA (dB)	MAXIMUM FIELD STRENGTH IN RESTRICT BAND (dBuV/m)	LIMIT (dBuV/m)
2412.00 (PK)	105.4	43.61	61.79	74.00
2412.00 (AV)	91.3	41.81	49.49	54.00

### RESTRICT BAND (2483.5 ~ 2500 MHz)

FREQUENCY (MHz)	FUNDAMENTAL EMISSION (dBuV/m)	DELTA (dB)	MAXIMUM FIELD STRENGTH IN RESTRICT BAND (dBuV/m)	LIMIT (dBuV/m)
2462.00 (PK)	105.3	43.67	61.63	74.00
2462.00 (AV)	91.2	40.80	50.40	54.00

#### NOTE:

1. Delta = Amplitude between the peak of the fundamental and the peak of the band edge emission. Please check following 3 pages.
2. Maximum field strength in restrict band = Fundamental emission – Delta.



A D T

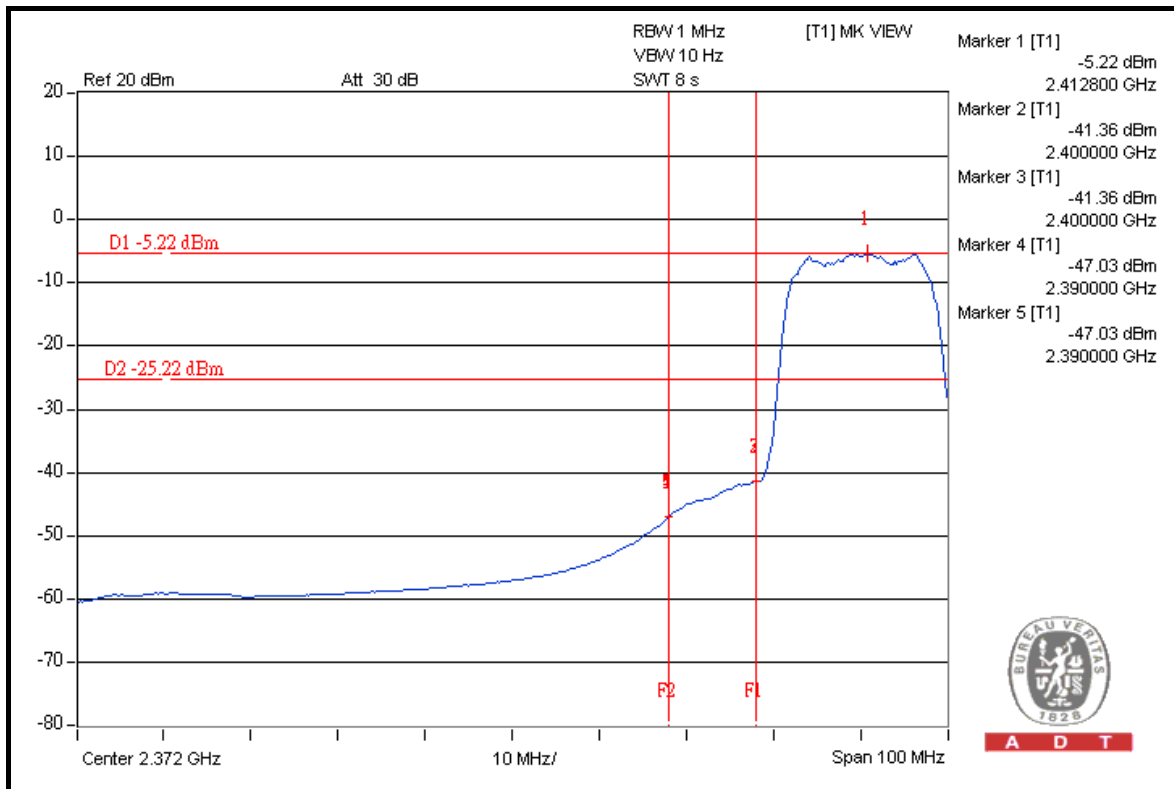
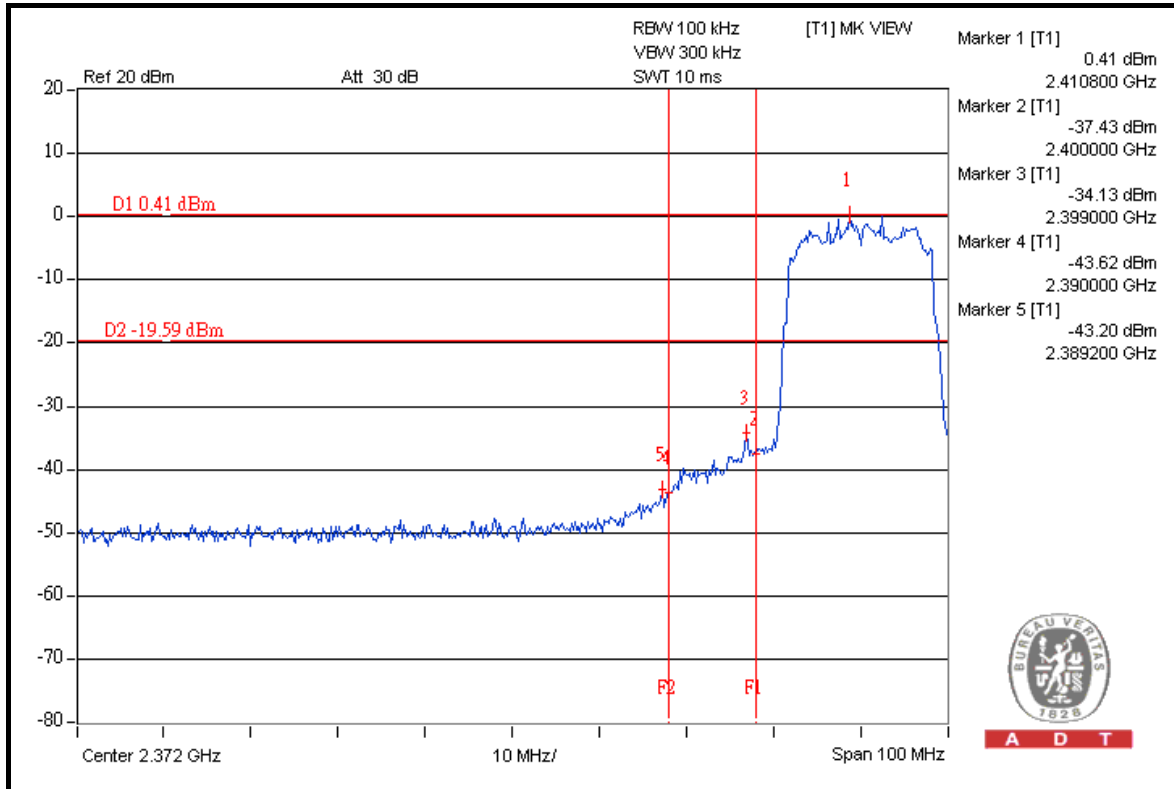





A D T

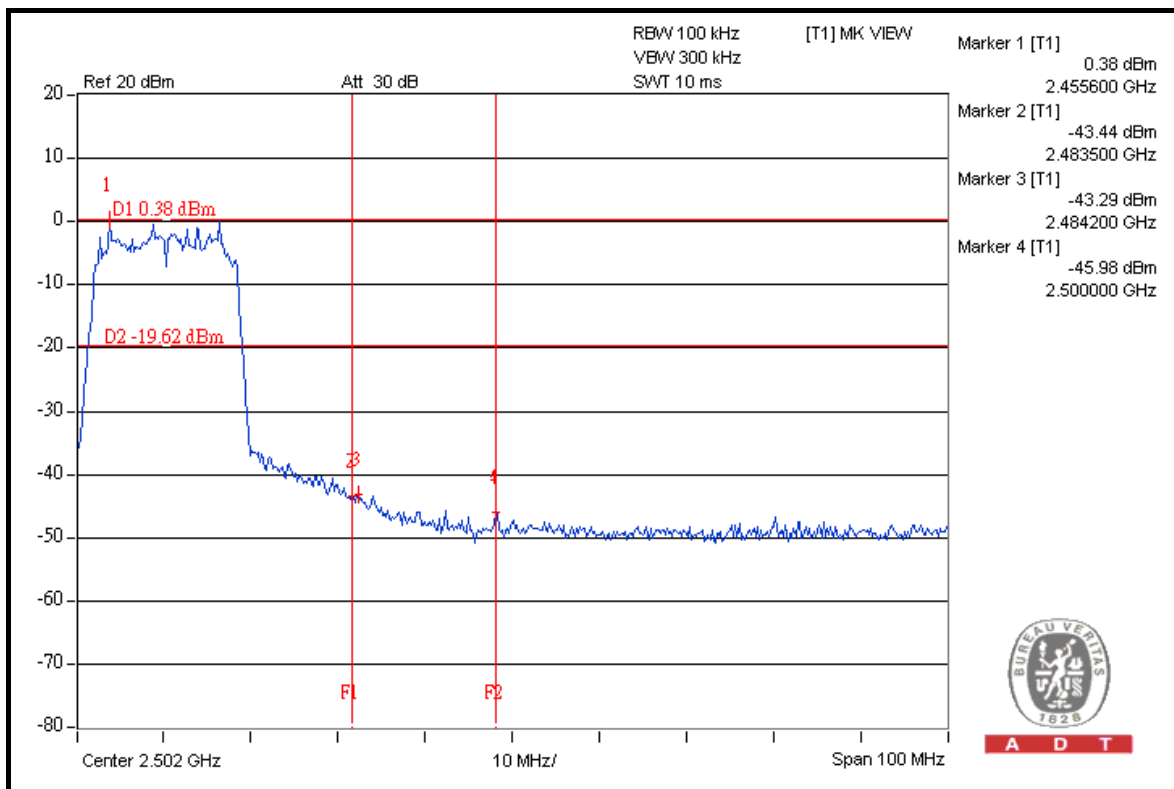
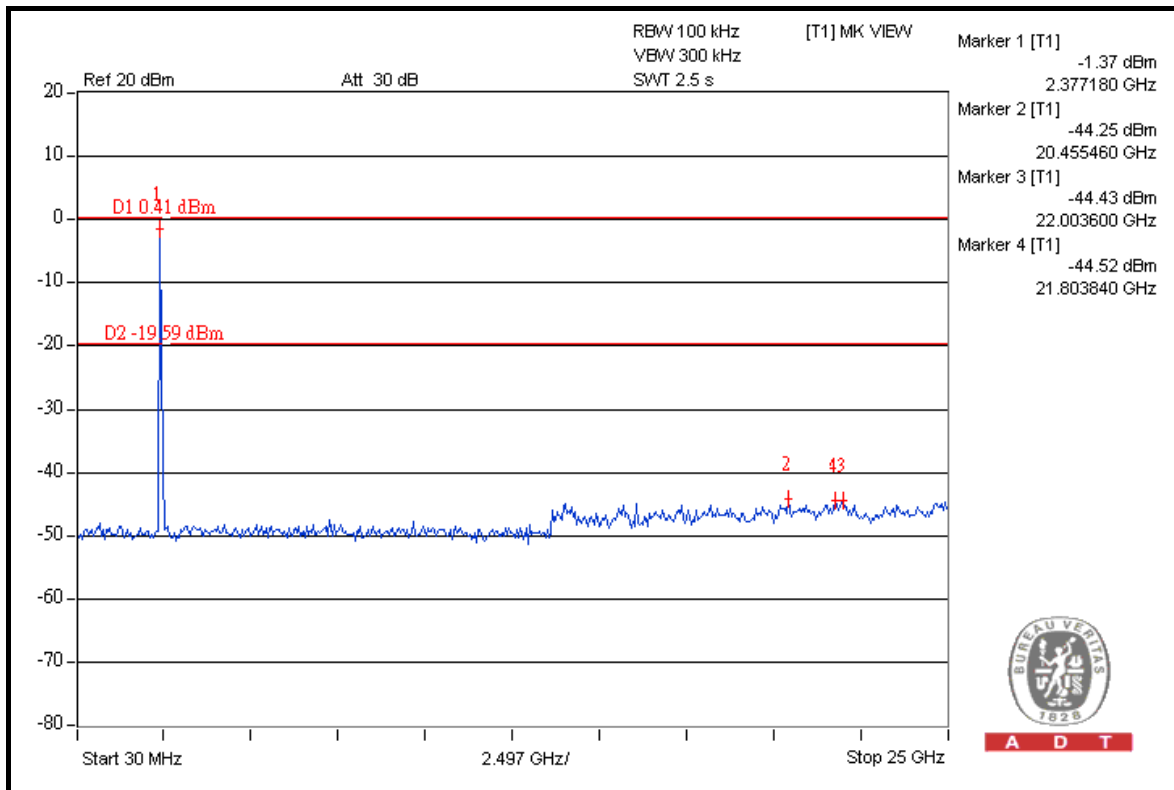



A D T

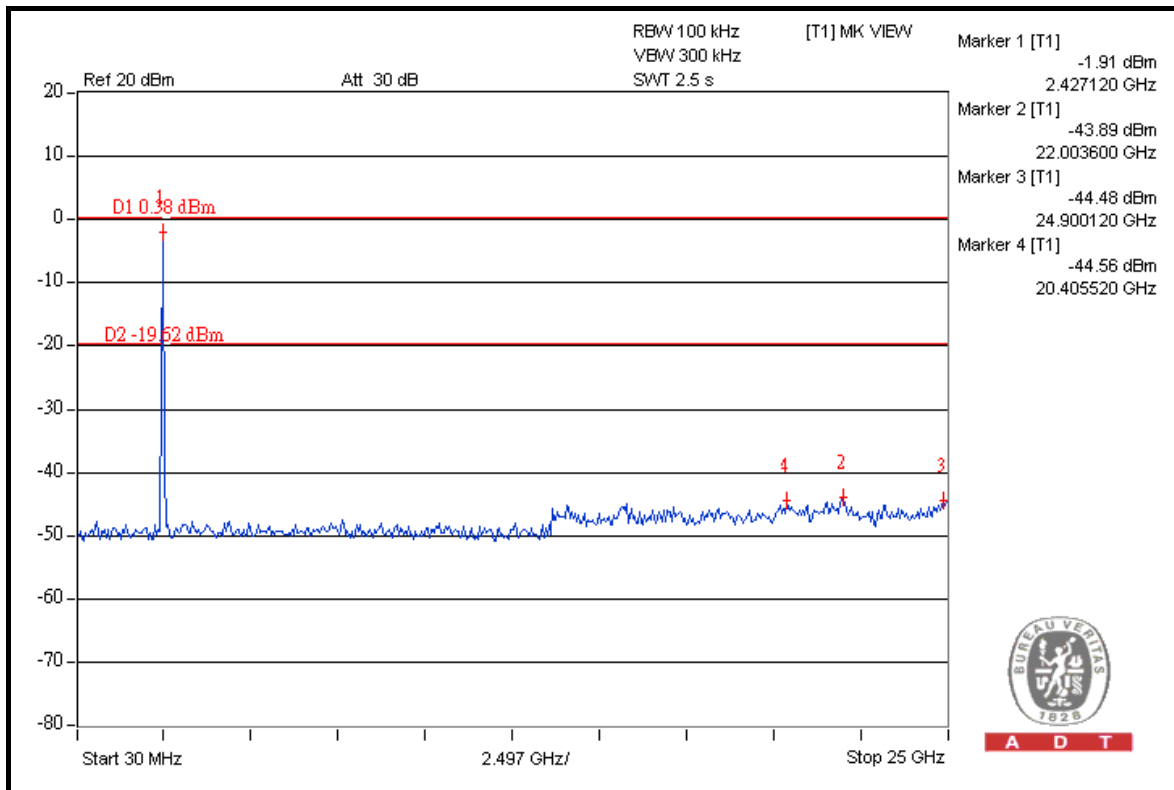
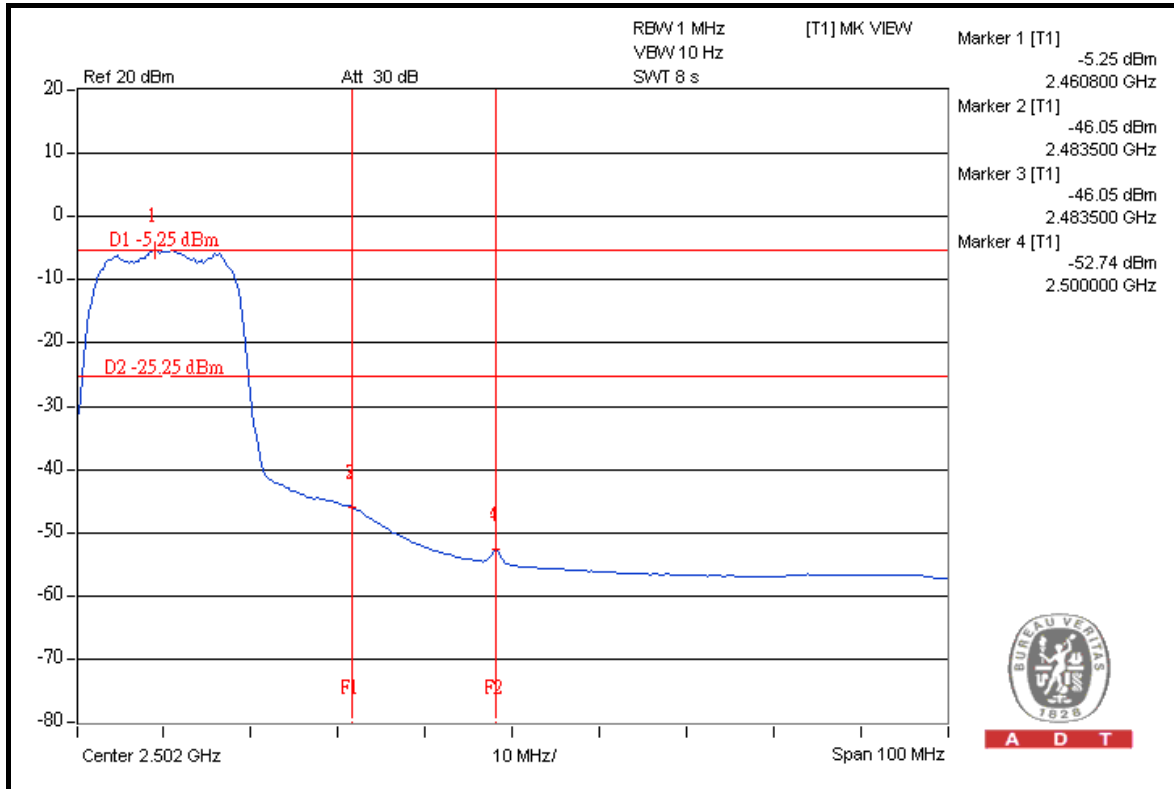



A D T

### 802.11g (Antenna B)

#### RESTRICT BAND (2310 ~ 2390 MHz)

FREQUENCY (MHz)	FUNDAMENTAL EMISSION (dBuV/m)	DELTA (dB)	MAXIMUM FIELD STRENGTH IN RESTRICT BAND (dBuV/m)	LIMIT (dBuV/m)
2412.00 (PK)	107.8	42.63	65.17	74.00
2412.00 (AV)	92.9	41.97	50.93	54.00

#### RESTRICT BAND (2483.5 ~ 2500 MHz)

FREQUENCY (MHz)	FUNDAMENTAL EMISSION (dBuV/m)	DELTA (dB)	MAXIMUM FIELD STRENGTH IN RESTRICT BAND (dBuV/m)	LIMIT (dBuV/m)
2462.00 (PK)	107.7	42.67	65.03	74.00
2462.00 (AV)	93.3	41.19	52.11	54.00

**NOTE:**

1. Delta = Amplitude between the peak of the fundamental and the peak of the band edge emission. Please check following 3 pages.
2. Maximum field strength in restrict band = Fundamental emission – Delta.



A D T

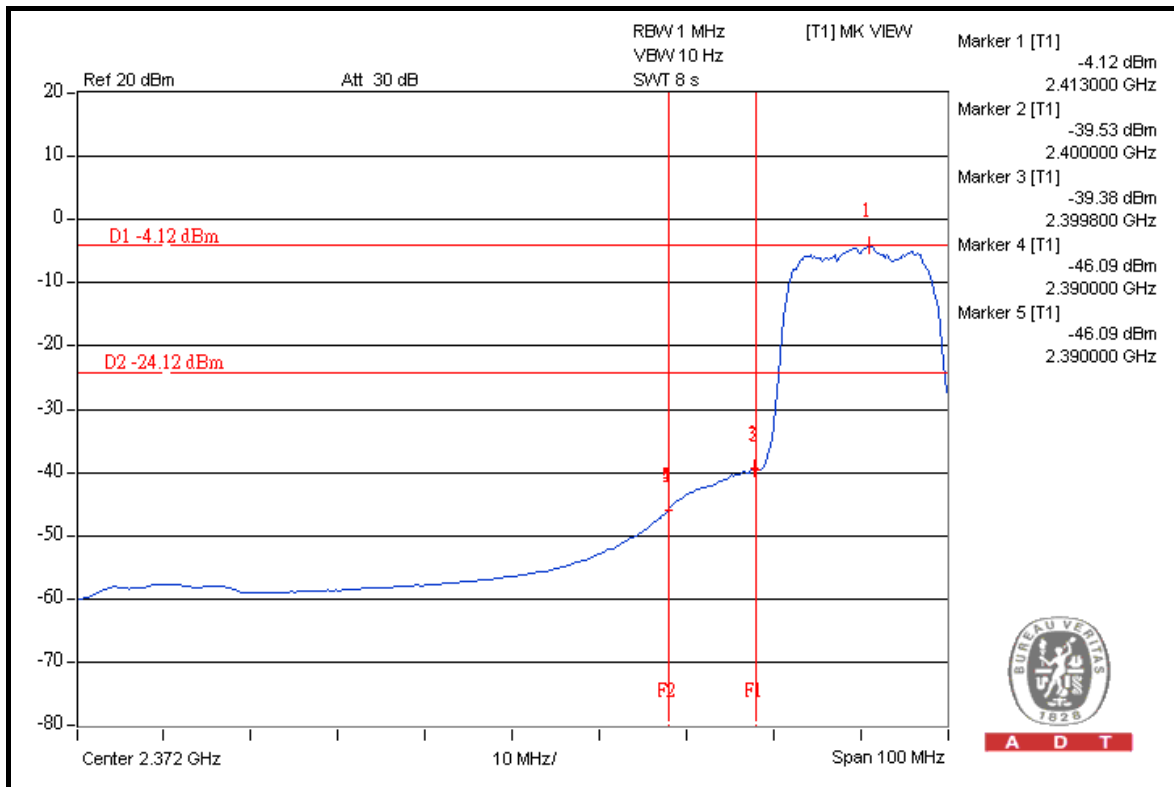
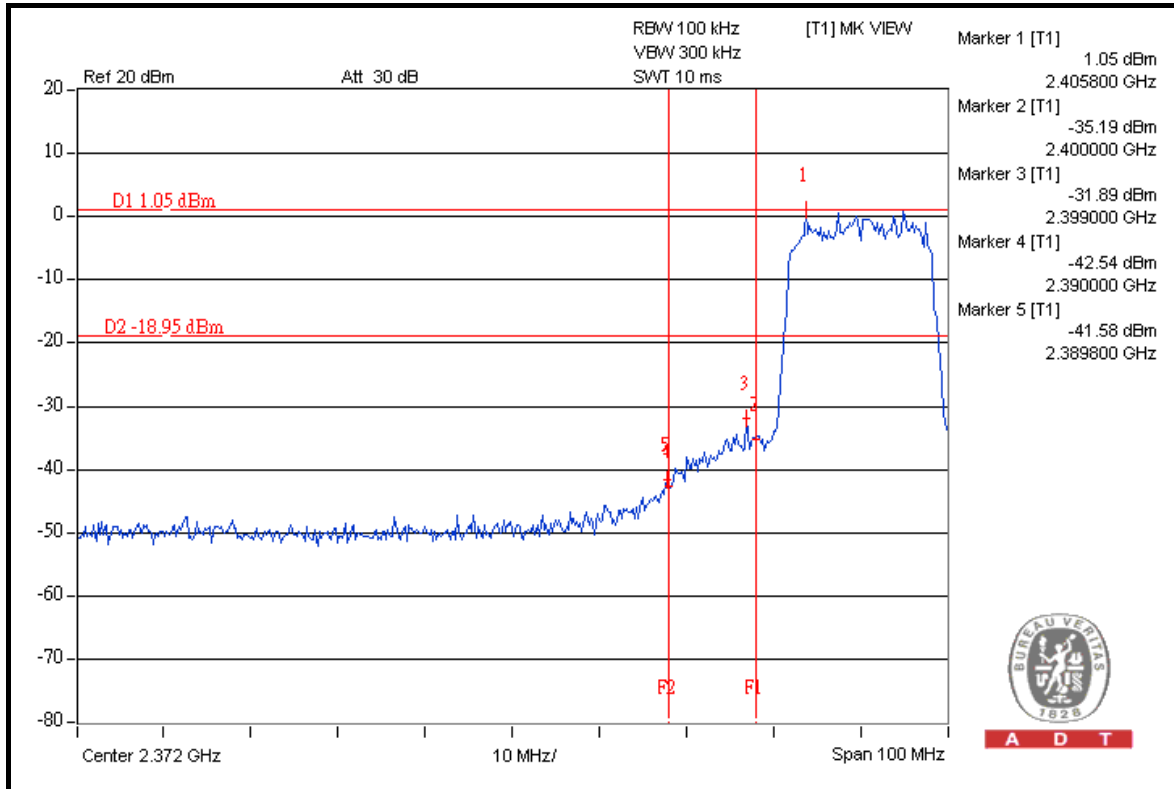



A D T

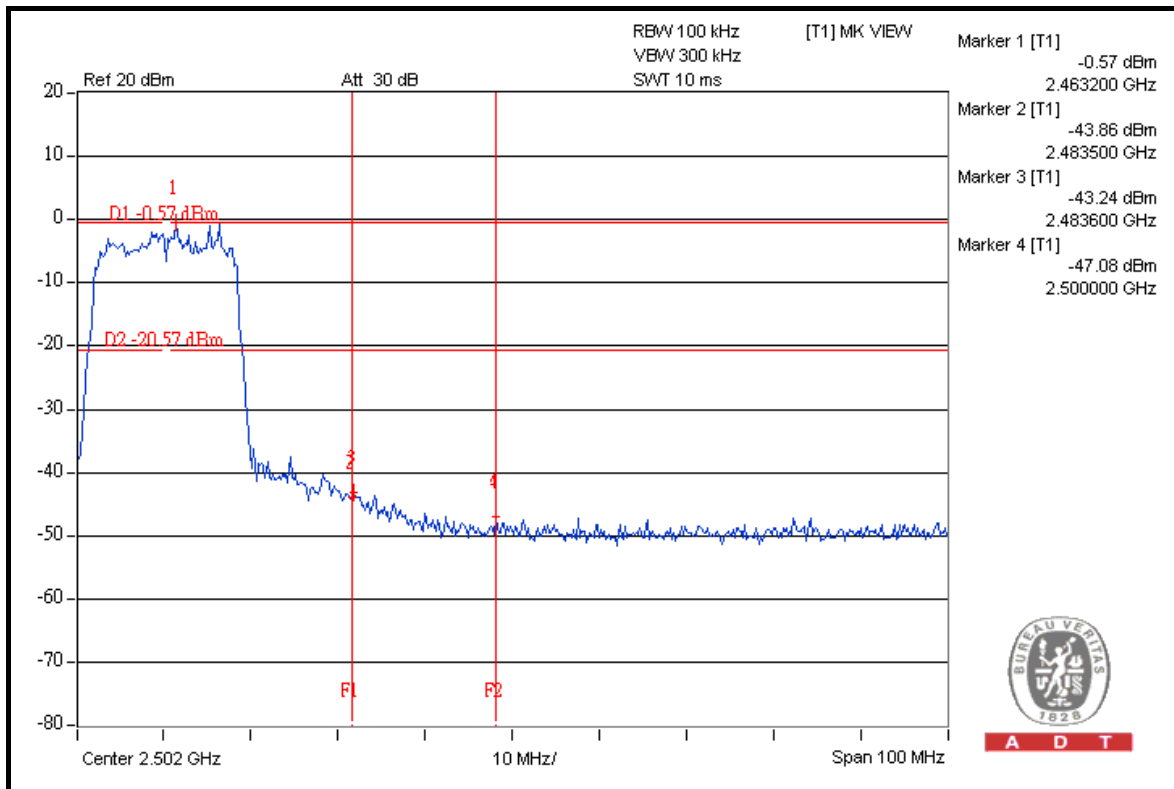
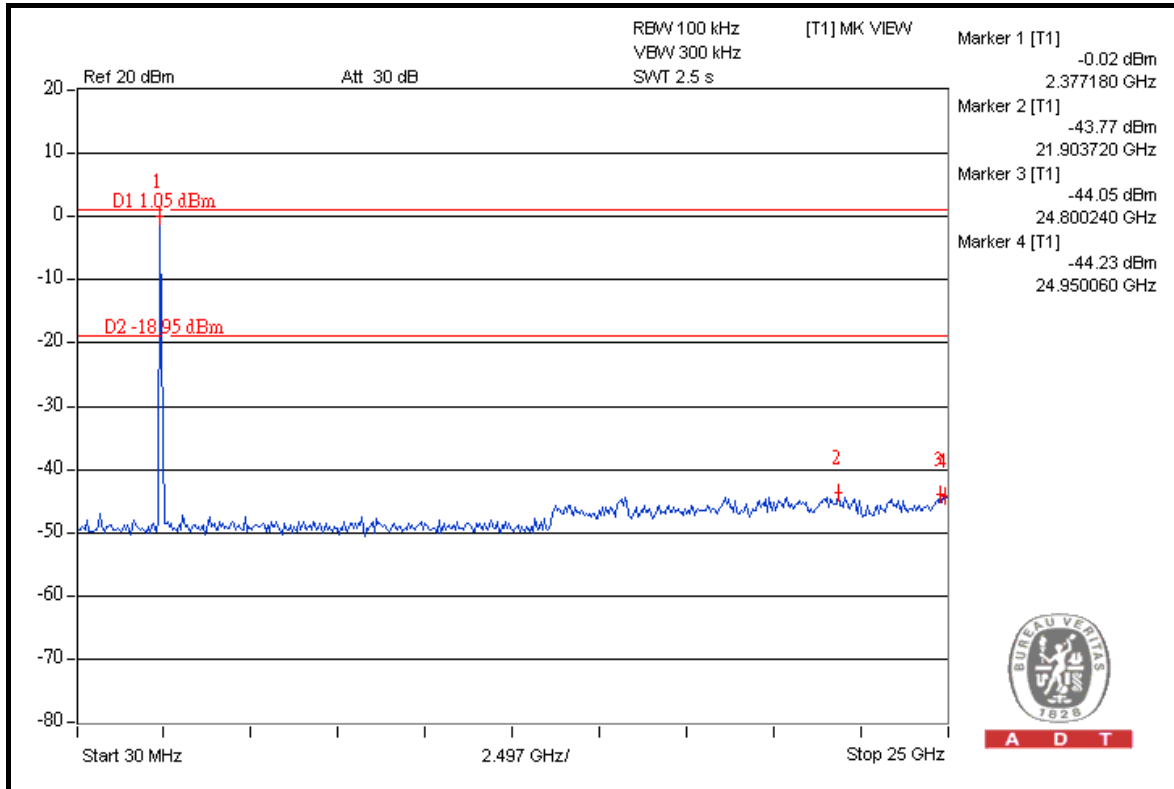



A D T

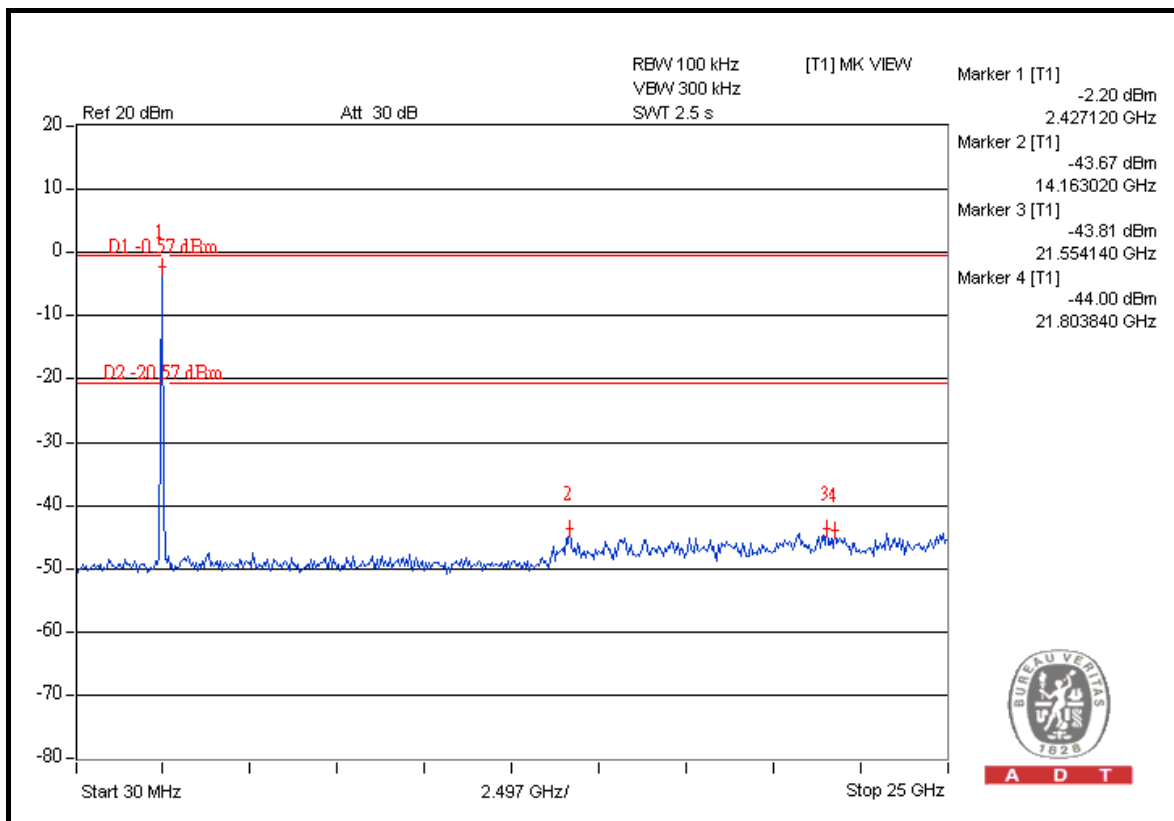
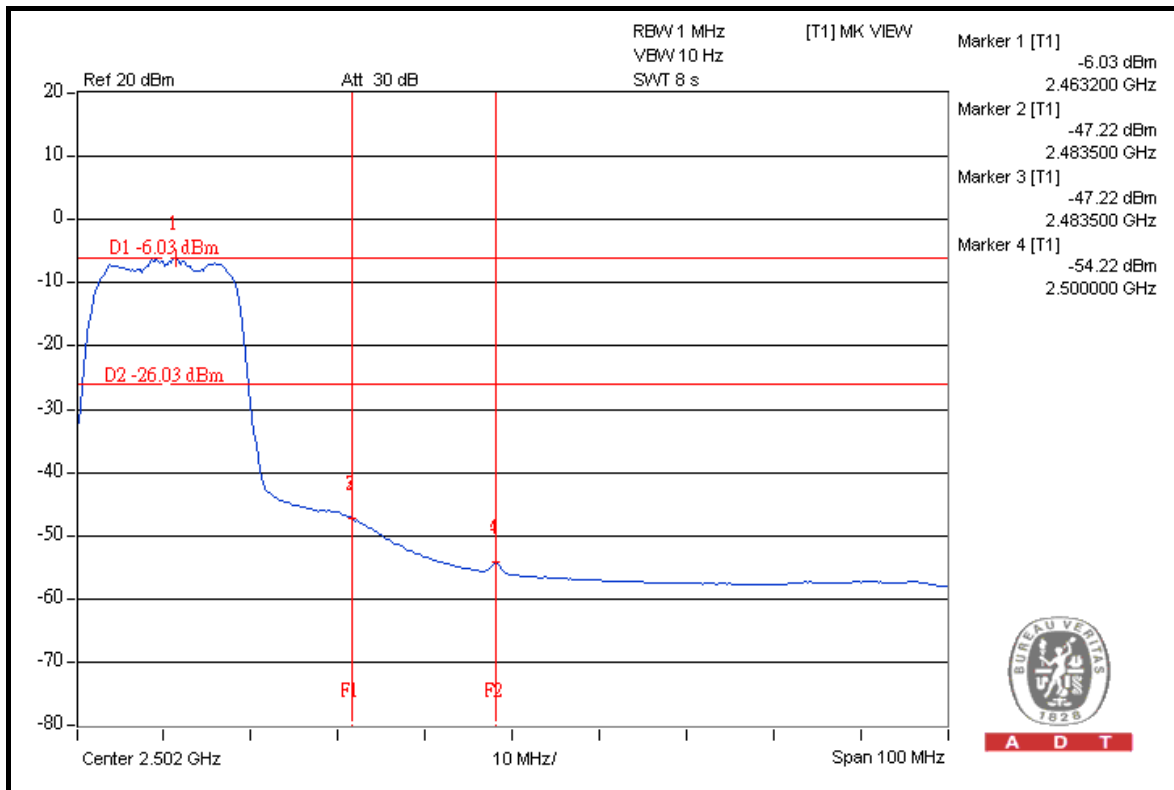



A D T

### 802.11n (20MHz)

#### RESTRICT BAND (2310 ~ 2390 MHz)

FREQUENCY (MHz)	FUNDAMENTAL EMISSION (dBuV/m)	DELTA (dB)	MAXIMUM FIELD STRENGTH IN RESTRICT BAND (dBuV/m)	LIMIT (dBuV/m)
2412.00 (PK)	108.0	42.76	65.24	74.00
2412.00 (AV)	93.9	42.11	51.79	54.00

#### RESTRICT BAND (2483.5 ~ 2500 MHz)

FREQUENCY (MHz)	FUNDAMENTAL EMISSION (dBuV/m)	DELTA (dB)	MAXIMUM FIELD STRENGTH IN RESTRICT BAND (dBuV/m)	LIMIT (dBuV/m)
2462.00 (PK)	108.2	42.59	65.61	74.00
2462.00 (AV)	94.1	41.98	52.12	54.00

#### NOTE:

1. Delta = Amplitude between the peak of the fundamental and the peak of the band edge emission. Please check following 3 pages.
2. Maximum field strength in restrict band = Fundamental emission – Delta.



A D T

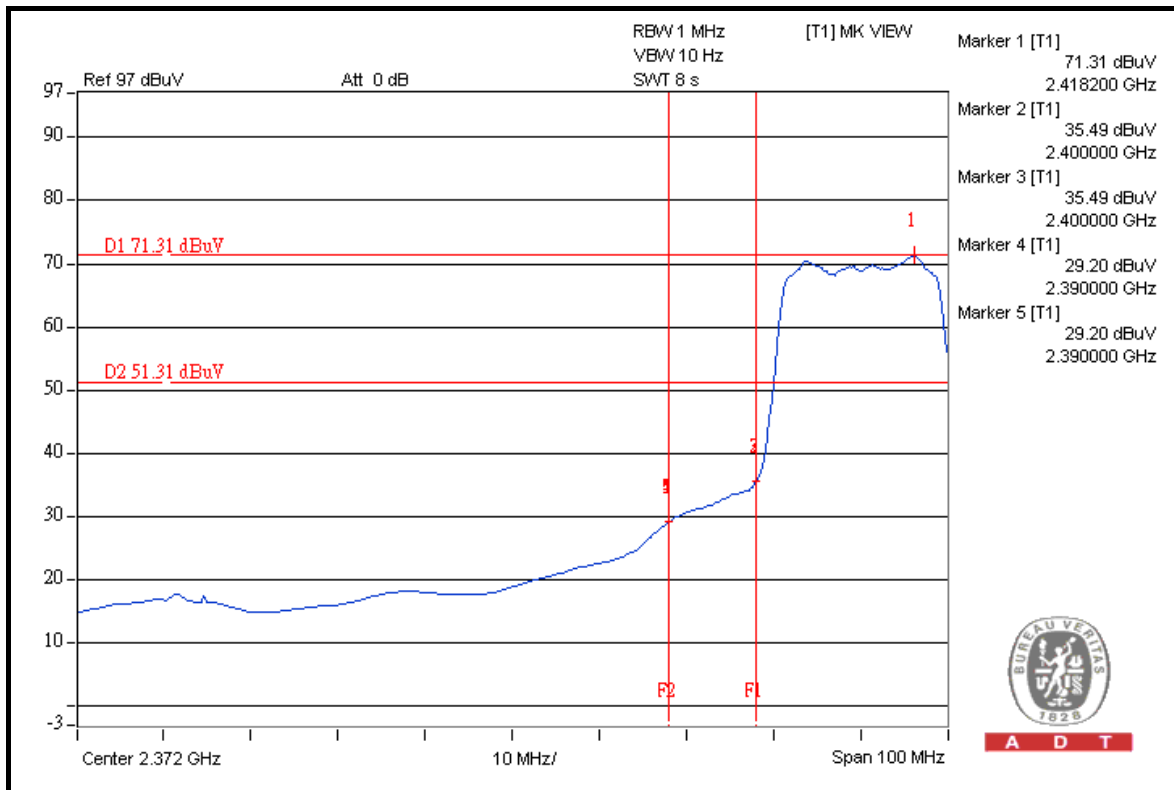
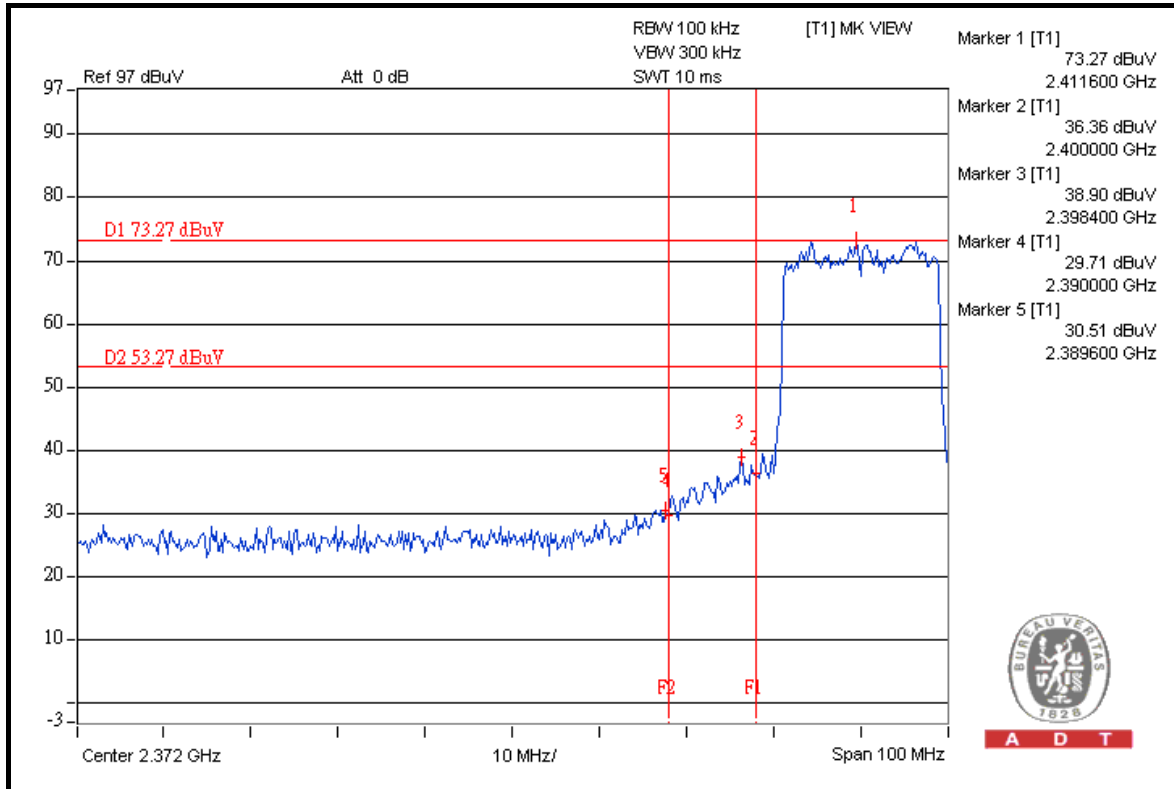





A D T

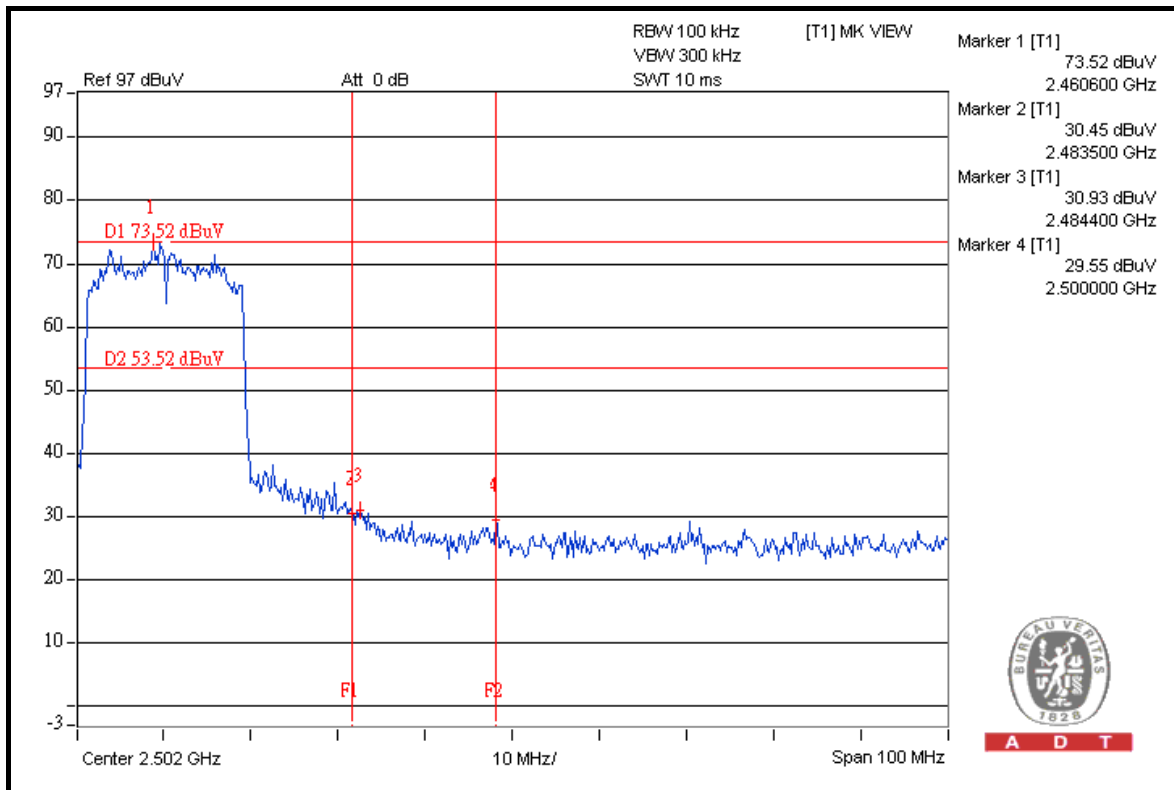
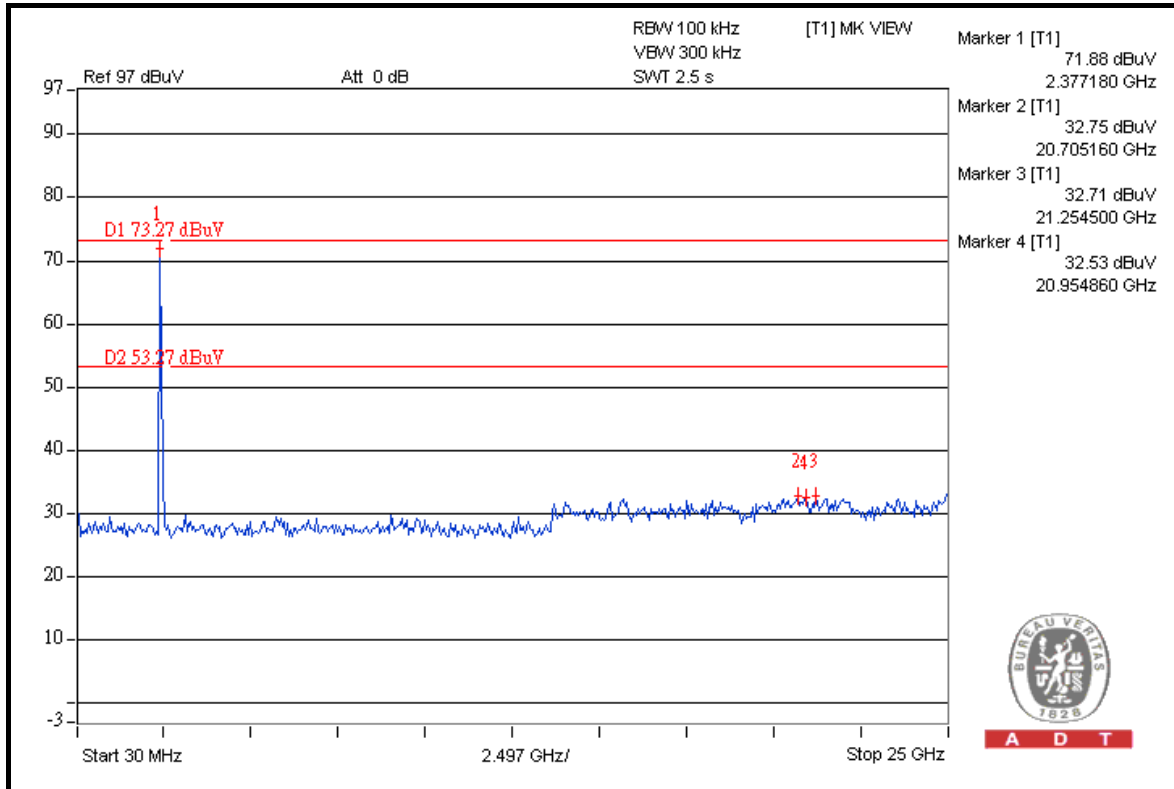



A D T

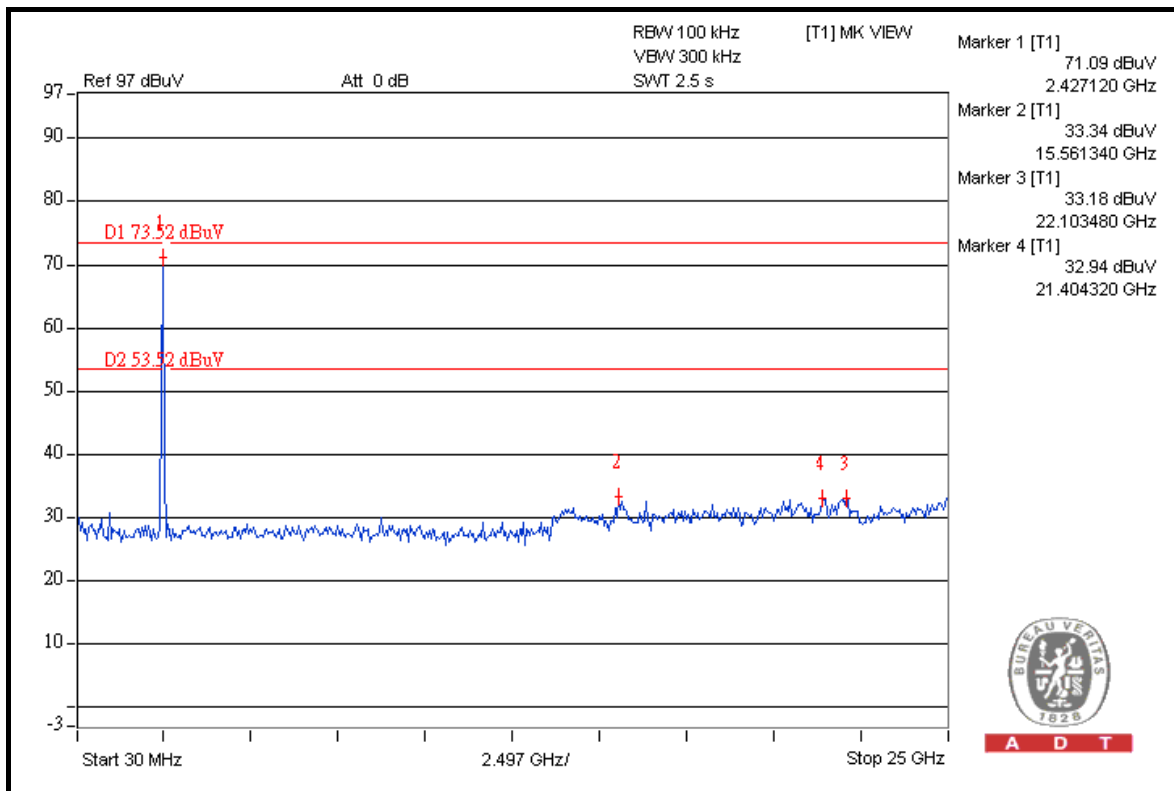
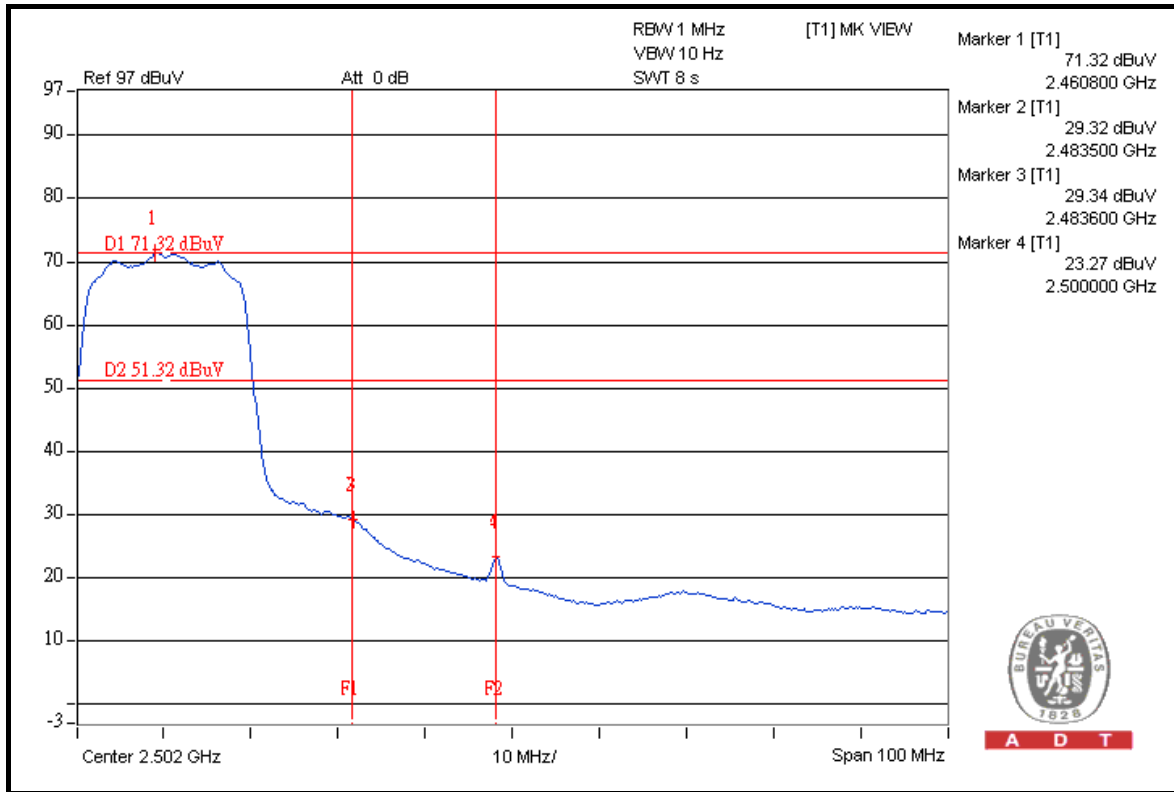



A D T

### 802.11n (40MHz)

#### RESTRICT BAND (2310 ~ 2390 MHz)

FREQUENCY (MHz)	FUNDAMENTAL EMISSION (dBuV/m)	DELTA (dB)	MAXIMUM FIELD STRENGTH IN RESTRICT BAND (dBuV/m)	LIMIT (dBuV/m)
2422.00 (PK)	106.7	36.50	70.20	74.00
2422.00 (AV)	91.3	38.34	52.96	54.00

#### RESTRICT BAND (2483.5 ~ 2500 MHz)

FREQUENCY (MHz)	FUNDAMENTAL EMISSION (dBuV/m)	DELTA (dB)	MAXIMUM FIELD STRENGTH IN RESTRICT BAND (dBuV/m)	LIMIT (dBuV/m)
2452.00 (PK)	106.7	38.00	68.70	74.00
2452.00 (AV)	91.4	38.91	52.49	54.00

**NOTE:**

1. Delta = Amplitude between the peak of the fundamental and the peak of the band edge emission. Please check following 3 pages.
2. Maximum field strength in restrict band = Fundamental emission – Delta.



A D T

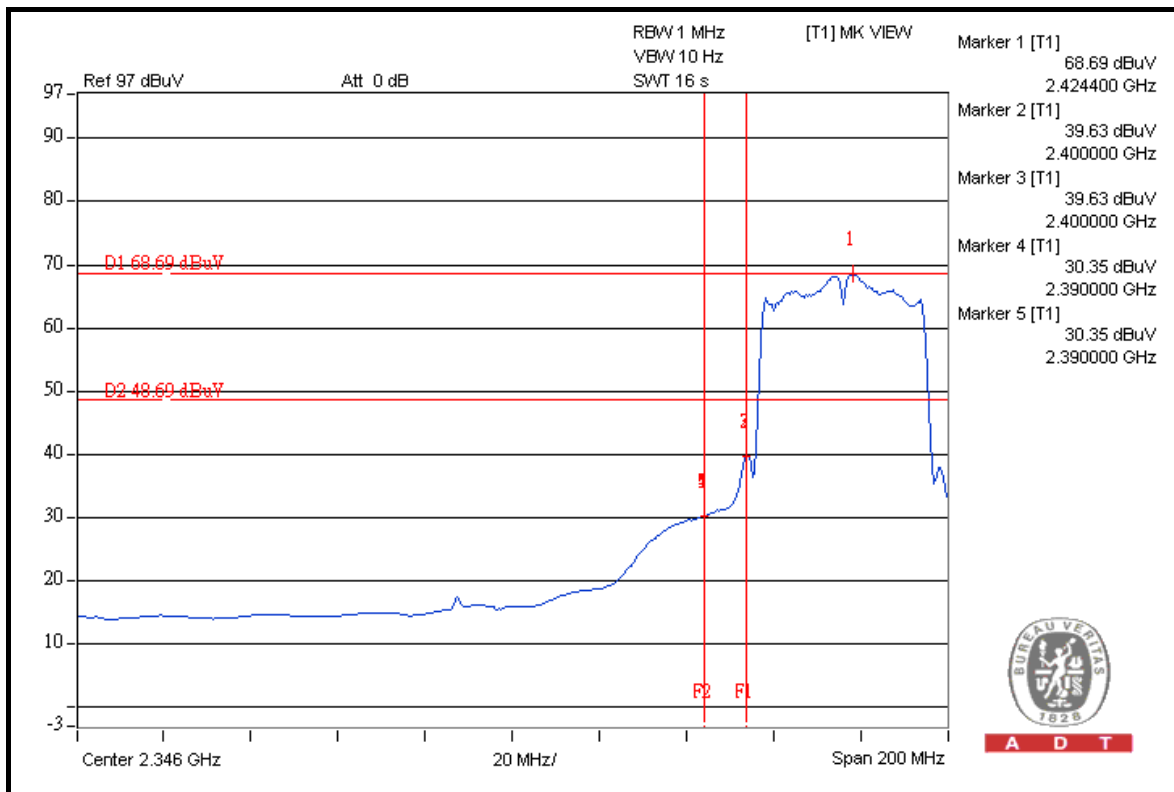
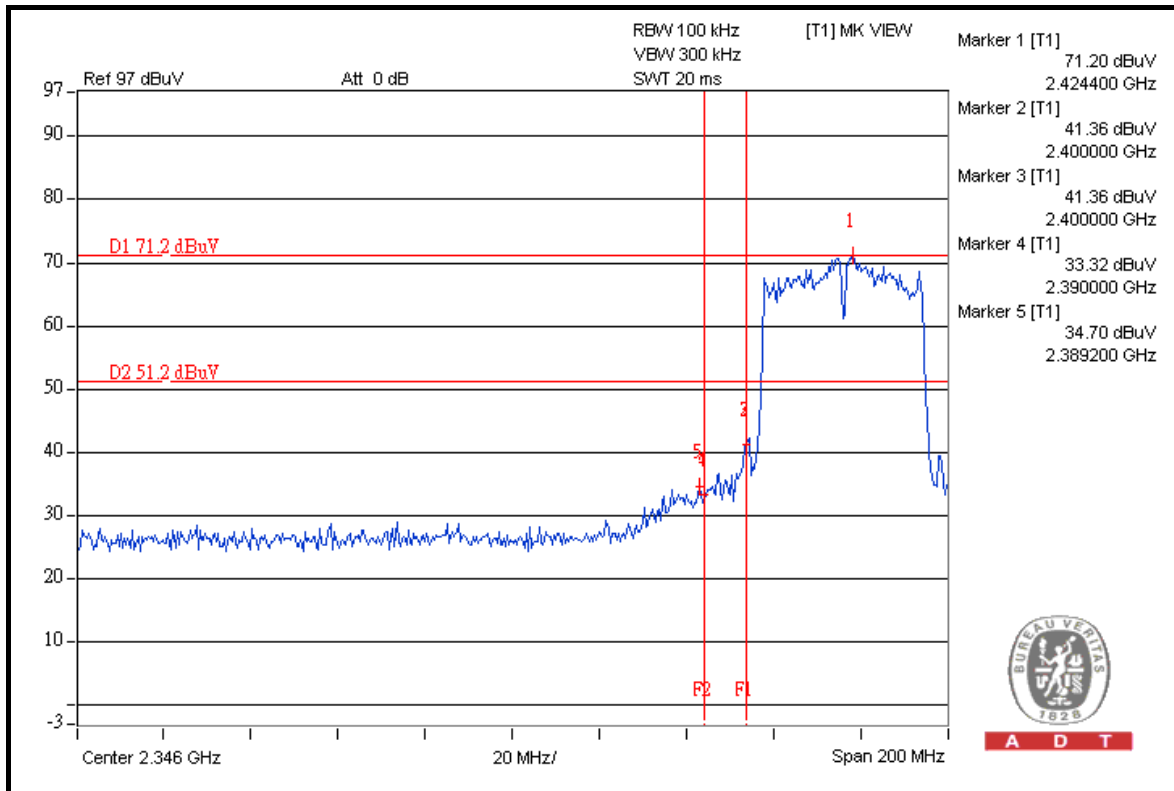



A D T

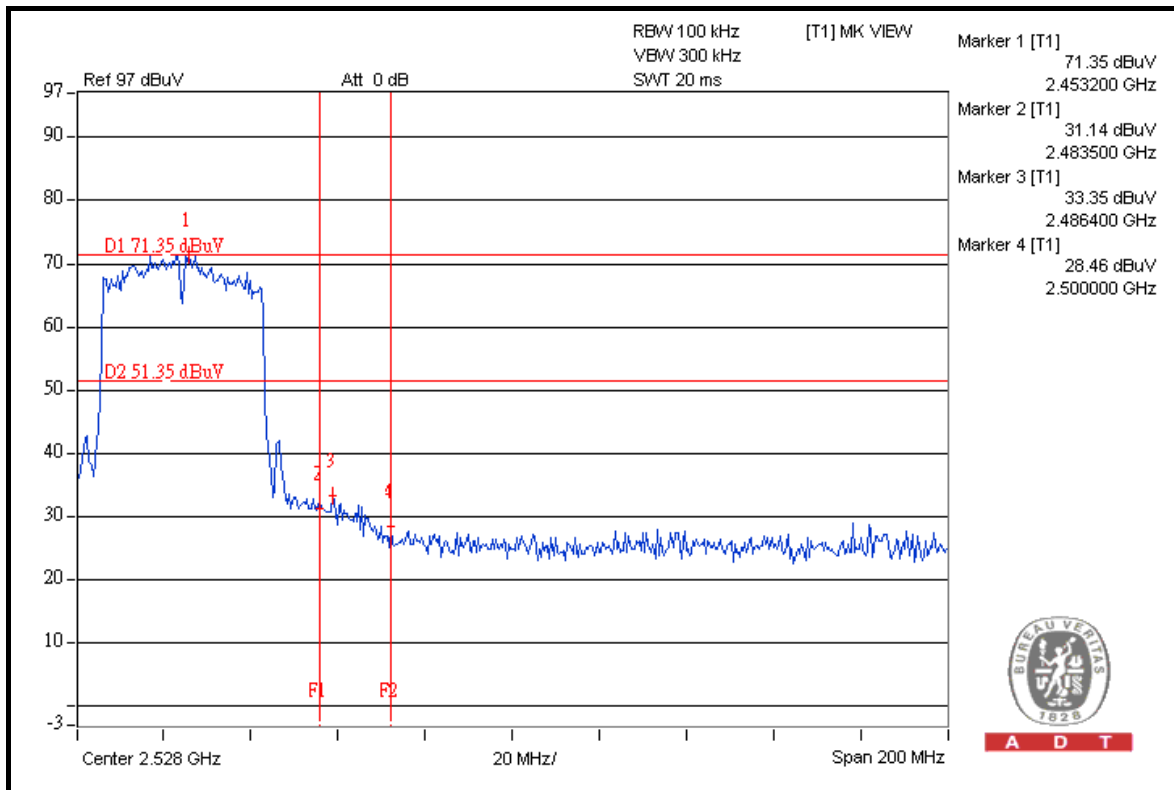
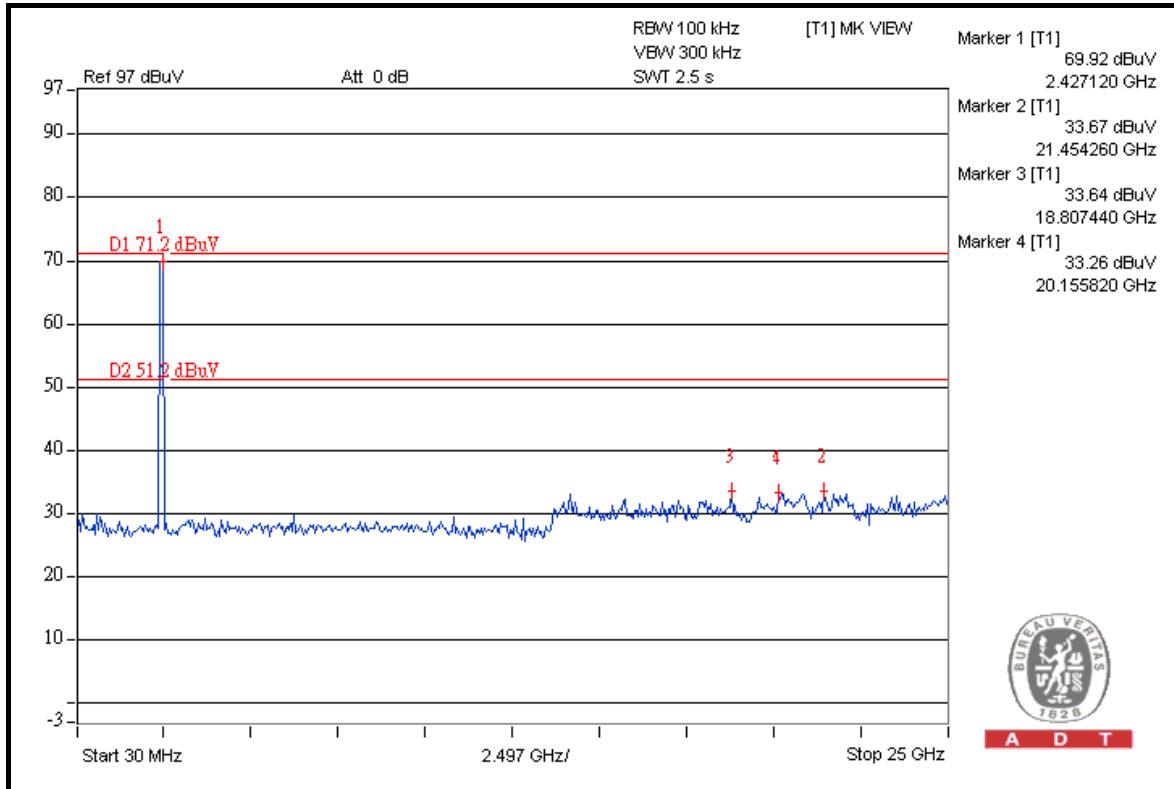



A D T

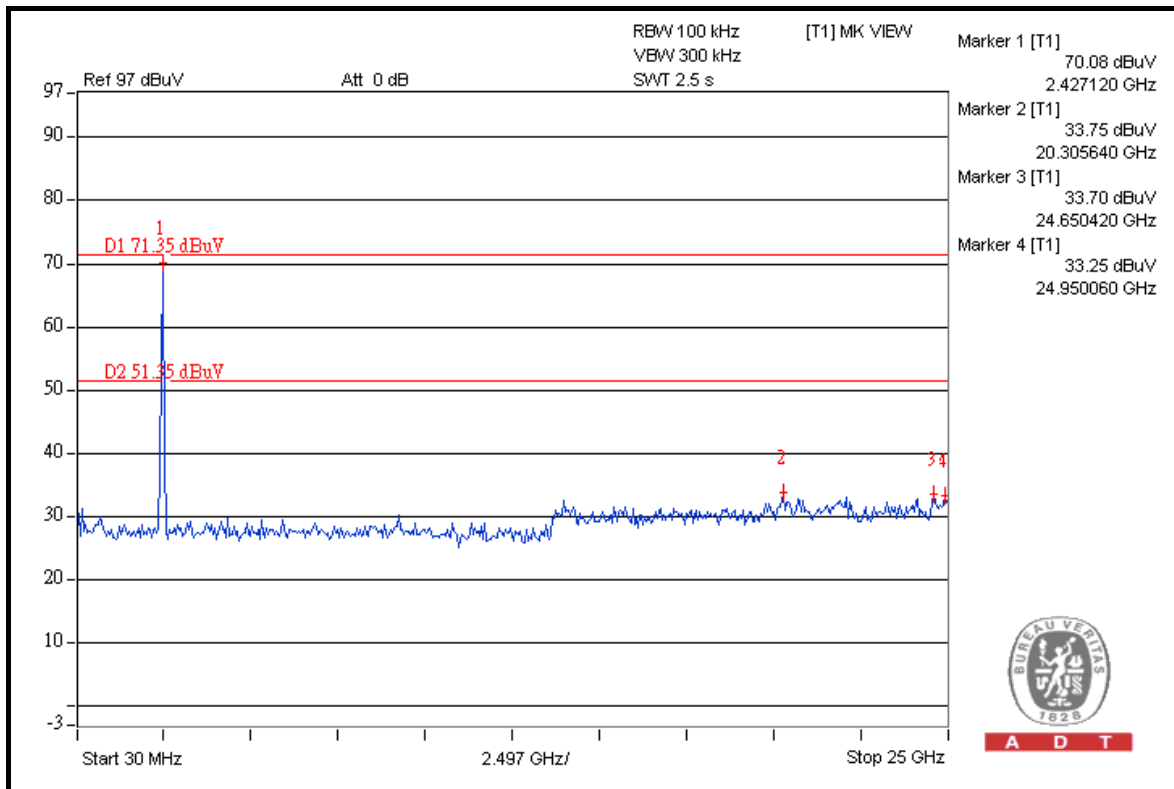
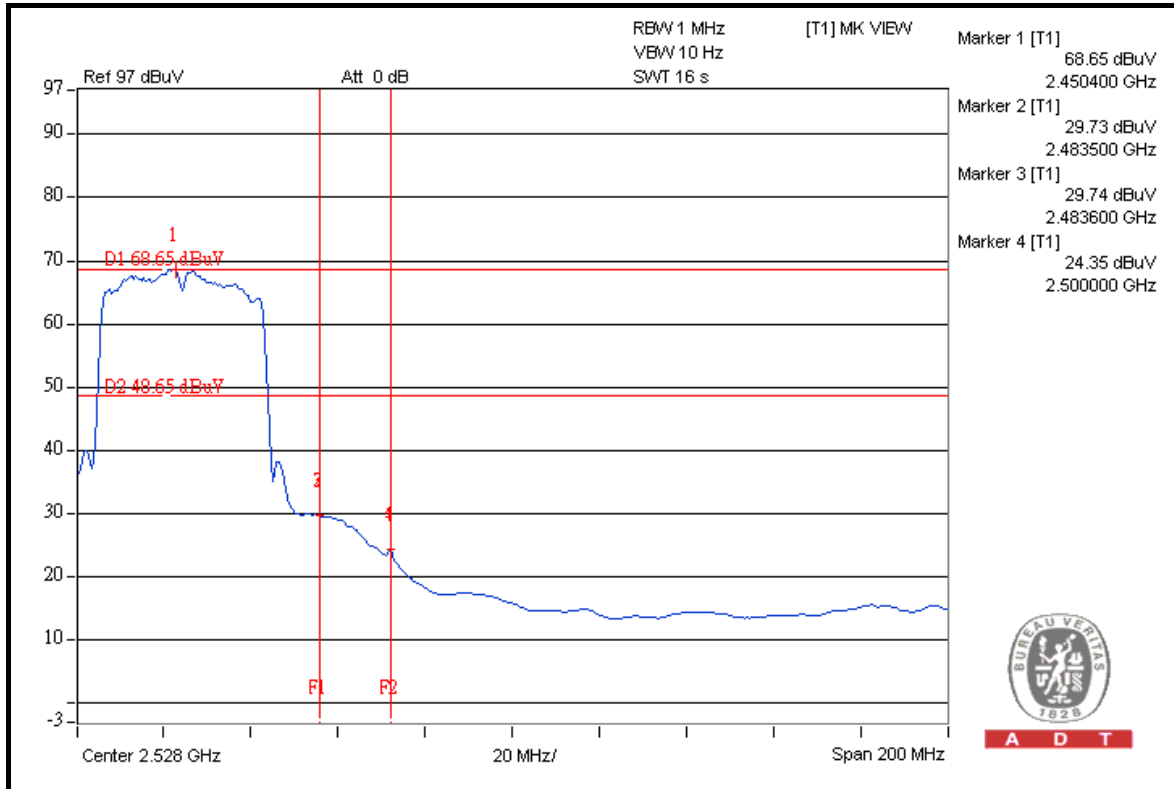



## 5. TEST TYPES AND RESULTS (FOR 5.0GHz BAND)

### 5.1 RADIATED EMISSION MEASUREMENT

#### 5.1.1 LIMITS OF RADIATED EMISSION MEASUREMENT

Emissions radiated outside of the specified bands, shall be according to the general radiated limits in 15.209 as following:

FREQUENCIES (MHz)	FIELD STRENGTH (microvolts/meter)	MEASUREMENT DISTANCE (meters)
0.009 ~ 0.490	2400/F(kHz)	300
0.490 ~ 1.705	24000/F(kHz)	30
1.705 ~ 30.0	30	30
30 ~ 88	100	3
88 ~ 216	150	3
216 ~ 960	200	3
Above 960	500	3

**NOTE:**

1. The lower limit shall apply at the transition frequencies.
2. Emission level (dBuV/m) = 20 log Emission level (uV/m).
3. As shown in 15.35(b), for frequencies above 1000MHz, the field strength limits are based on average detector, however, the peak field strength of any emission shall not exceed the maximum permitted average limits, specified above by more than 20dB under any condition of modulation.



A D T

### 5.1.2 TEST INSTRUMENTS

DESCRIPTION & MANUFACTURER	MODEL NO.	SERIAL NO.	DATE OF CALIBRATION	DUE DATE OF CALIBRATION
Test Receiver ROHDE & SCHWARZ	ESIB7	100212	May 25, 2009	May 24, 2010
Spectrum Analyzer ROHDE & SCHWARZ	FSP40	100040	Jul. 07, 2009	Jul. 06, 2010
BILOG Antenna SCHWARZBECK	VULB9168	9168-156	Apr. 30, 2009	Apr. 29, 2010
HORN Antenna SCHWARZBECK	BBHA 9120 D	9120D-563	Aug. 10, 2009	Aug. 09, 2010
HORN Antenna SCHWARZBECK	BBHA 9170	BBHA9170242	Jan. 06, 2009	Jan. 05, 2010
Preamplifier Agilent	8449B	3008A01910	Sep. 11, 2009	Sep. 10, 2010
Preamplifier Agilent	8447D	2944A10738	Nov. 04, 2009	Nov. 03, 2010
RF signal cable HUBER+SUHNNER	SUCOFLEX 104	218190/4 231241/4	May 13, 2009	May 12, 2010
RF signal cable Worken	8D-FB	Cable-HYCH9-01	Aug. 17, 2009	Aug. 16, 2010
Software	ADT_Radiated_ V7.6.15.9.2	NA	NA	NA
Antenna Tower EMCO	2070/2080	512.835.4684	NA	NA
Turn Table EMCO	2087-2.03	NA	NA	NA
Antenna Tower & Turn Table Controller EMCO	2090	NA	NA	NA
26GHz ~ 40GHz Amplifier	EM26400	07026401	Aug. 27, 2009	Aug. 26, 2010

- NOTE:**
1. The calibration interval of the above test instruments is 12 months and the calibrations are traceable to NML/ROC and NIST/USA.
  2. The test was performed in HwaYa Chamber 9.
  3. The horn antenna and HP preamplifier (model: 8449B) are used only for the measurement of emission frequency above 1GHz if tested.
  4. The FCC Site Registration No. is 460141.
  5. The IC Site Registration No. is IC 7450F-4.





A D T

### 5.1.3 TEST PROCEDURES

- a. The EUT was placed on the top of a rotating table 0.8 meters above the ground at a 3 meters semi-anechoic chamber. The table was rotated 360 degrees to determine the position of the highest radiation.
- b. The EUT was set 3 meters away from the interference-receiving antenna, which was mounted on the top of a variable-height antenna tower.
- c. The antenna is a broadband antenna, and its height is varied from one meter to four meters above the ground to determine the maximum value of the field strength. Both horizontal and vertical polarizations of the antenna are set to make the measurement.
- d. For each suspected emission, the EUT was arranged to its worst case and then the antenna was tuned to heights from 1 meter to 4 meters and the rotatable table was turned from 0 degrees to 360 degrees to find the maximum reading.
- e. The test-receiver system was set to Peak Detect Function and Specified Bandwidth with Maximum Hold Mode.
- f. If the emission level of the EUT in peak mode was lower than the limit specified, then testing could be stopped and the peak values of the EUT would be reported. Otherwise the emissions would be re-tested one by one using peak, quasi-peak or average method as specified and then reported in a data sheet.

**NOTE:**

1. The resolution bandwidth and video bandwidth of test receiver/spectrum analyzer is 120kHz for Quasi-peak detection at frequency below 1GHz.
2. The resolution bandwidth of test receiver/spectrum analyzer is 100kHz and video bandwidth is 300kHz for Peak detection at frequency above 1GHz.
3. The resolution bandwidth of test receiver/spectrum analyzer is 1MHz and the video bandwidth is 10Hz for Average detection (AV) at frequency above 1GHz.
4. All modes of operation were investigated and the worst-case emissions are reported.

### 5.1.4 DEVIATION FROM TEST STANDARD

No deviation

### 5.1.5 TEST SETUP

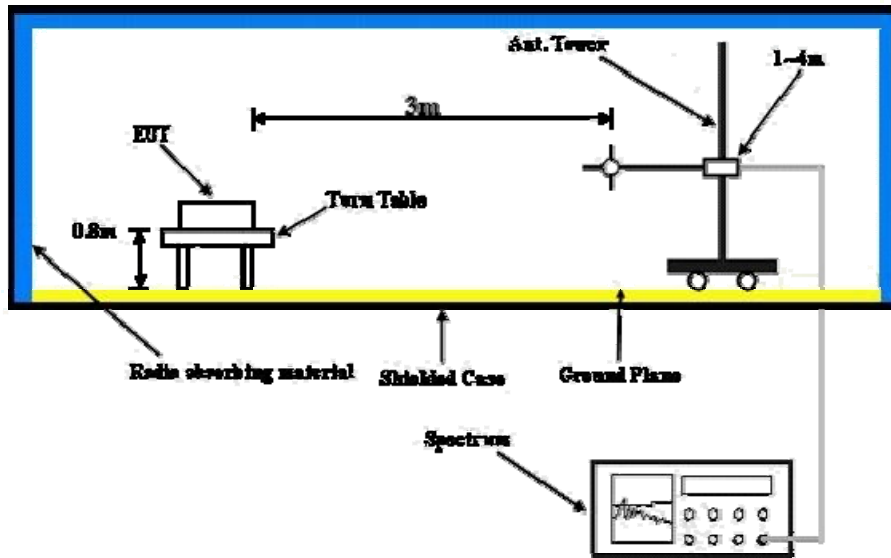

For the actual test configuration, please refer to the attached file (Test Setup Photo).

### 5.1.6 EUT OPERATING CONDITIONS

Same as 4.1.6



A D T

## 5.1.7 TEST RESULTS

### 802.11a (Antenna A)

EUT TEST CONDITION		MEASUREMENT DETAIL	
CHANNEL	Channel 149	FREQUENCY RANGE	1 ~ 40GHz
INPUT POWER (SYSTEM)	120Vac, 60 Hz	DETECTOR FUNCTION	Peak (PK) Average (AV)
ENVIRONMENTAL CONDITIONS	21deg. C, 65%RH 1020 hPa	TESTED BY	Lori Chiu

ANTENNA POLARITY & TEST DISTANCE: HORIZONTAL AT 3 M								
NO.	FREQ. (MHz)	EMISSION LEVEL (dBuV/m)	LIMIT (dBuV/m)	MARGIN (dB)	ANTENNA HEIGHT (m)	TABLE ANGLE (Degree)	RAW VALUE (dBuV)	CORRECTION FACTOR (dB/m)
1	2500.00	59.3 PK	74.0	-14.7	1.13 H	23	26.71	32.62
2	2500.00	48.2 AV	54.0	-5.8	1.13 H	23	15.61	32.62
3	#5725.00	72.8 PK	87.2	-14.4	1.00 H	322	32.85	39.92
4	#5725.00	48.6 AV	74.5	-25.9	1.00 H	322	8.67	39.92
5	*5745.00	107.2 PK			1.08 H	12	67.28	39.93
6	*5745.00	94.5 AV			1.08 H	12	54.60	39.93
7	11490.00	60.7 PK	74.0	-13.3	1.29 H	238	10.07	50.62
8	11490.00	47.1 AV	54.0	-6.9	1.29 H	238	-3.57	50.62
ANTENNA POLARITY & TEST DISTANCE: VERTICAL AT 3 M								
NO.	FREQ. (MHz)	EMISSION LEVEL (dBuV/m)	LIMIT (dBuV/m)	MARGIN (dB)	ANTENNA HEIGHT (m)	TABLE ANGLE (Degree)	RAW VALUE (dBuV)	CORRECTION FACTOR (dB/m)
1	2500.00	61.3 PK	74.0	-12.7	1.12 V	293	28.63	32.62
2	2500.00	53.0 AV	54.0	-1.0	1.12 V	293	20.34	32.62
3	#5725.00	75.9 PK	86.6	-10.7	1.00 V	12	36.01	39.92
4	#5725.00	51.9 AV	73.3	-21.4	1.00 V	12	11.95	39.92
5	*5745.00	106.6 PK			1.21 V	241	66.66	39.93
6	*5745.00	93.3 AV			1.21 V	241	53.34	39.93
7	11490.00	59.9 PK	74.0	-14.1	1.35 V	172	9.25	50.62
8	11490.00	46.2 AV	54.0	-7.8	1.35 V	172	-4.41	50.62

- REMARKS:**
1. Emission level (dBuV/m) = Raw Value (dBuV) + Correction Factor (dB/m).
  2. Correction Factor (dB/m) = Antenna Factor (dB/m) + Cable Factor (dB).
  3. The other emission levels were very low against the limit.
  4. Margin value = Emission level – Limit value.
  5. “ \* “: Fundamental frequency.
  6. The limit value is defined as per 15.247.
  7. "#": The radiated frequency is out the restricted band.



A D T

EUT TEST CONDITION		MEASUREMENT DETAIL	
CHANNEL	Channel 157	FREQUENCY RANGE	1 ~ 40GHz
INPUT POWER (SYSTEM)	120Vac, 60 Hz	DETECTOR FUNCTION	Peak (PK) Average (AV)
ENVIRONMENTAL CONDITIONS	21deg. C, 65%RH 1020 hPa	TESTED BY	Lori Chiu

ANTENNA POLARITY & TEST DISTANCE: HORIZONTAL AT 3 M								
NO.	FREQ. (MHz)	EMISSION LEVEL (dBuV/m)	LIMIT (dBuV/m)	MARGIN (dB)	ANTENNA HEIGHT (m)	TABLE ANGLE (Degree)	RAW VALUE (dBuV)	CORRECTION FACTOR (dB/m)
1	2500.00	59.4 PK	74.0	-14.6	1.27 H	11	26.77	32.62
2	2500.00	48.5 AV	54.0	-5.5	1.27 H	11	15.85	32.62
3	*5785.00	106.9 PK			1.05 H	2	66.95	39.96
4	*5785.00	93.8 AV			1.05 H	2	53.87	39.96
5	11570.00	60.2 PK	74.0	-13.8	1.05 H	247	9.73	50.50
6	11570.00	47.0 AV	54.0	-7.0	1.05 H	247	-3.54	50.50
ANTENNA POLARITY & TEST DISTANCE: VERTICAL AT 3 M								
NO.	FREQ. (MHz)	EMISSION LEVEL (dBuV/m)	LIMIT (dBuV/m)	MARGIN (dB)	ANTENNA HEIGHT (m)	TABLE ANGLE (Degree)	RAW VALUE (dBuV)	CORRECTION FACTOR (dB/m)
1	2500.00	61.6 PK	74.0	-12.4	1.11 V	271	28.94	32.62
2	2500.00	53.0 AV	54.0	-1.0	1.11 V	271	20.35	32.62
3	*5785.00	106.3 PK			1.32 V	217	66.32	39.96
4	*5785.00	93.2 AV			1.32 V	217	53.23	39.96
5	11570.00	59.4 PK	74.0	-14.6	1.39 V	258	8.86	50.50
6	11570.00	46.5 AV	54.0	-7.5	1.39 V	258	-4.02	50.50

- REMARKS:**
1. Emission level (dBuV/m) = Raw Value (dBuV) + Correction Factor (dB/m).
  2. Correction Factor (dB/m) = Antenna Factor (dB/m) + Cable Factor (dB).
  3. The other emission levels were very low against the limit.
  4. Margin value = Emission level – Limit value.
  5. “ \* “: Fundamental frequency.
  6. The limit value is defined as per 15.247.



A D T

EUT TEST CONDITION		MEASUREMENT DETAIL	
CHANNEL	Channel 165	FREQUENCY RANGE	1 ~ 40GHz
INPUT POWER (SYSTEM)	120Vac, 60 Hz	DETECTOR FUNCTION	Peak (PK) Average (AV)
ENVIRONMENTAL CONDITIONS	21deg. C, 65%RH 1020 hPa	TESTED BY	Lori Chiu

ANTENNA POLARITY & TEST DISTANCE: HORIZONTAL AT 3 M								
NO.	FREQ. (MHz)	EMISSION LEVEL (dBuV/m)	LIMIT (dBuV/m)	MARGIN (dB)	ANTENNA HEIGHT (m)	TABLE ANGLE (Degree)	RAW VALUE (dBuV)	CORRECTION FACTOR (dB/m)
1	2500.00	59.3 PK	74.0	-14.7	1.09 H	53	26.70	32.62
2	2500.00	48.2 AV	54.0	-5.8	1.09 H	53	15.57	32.62
3	*5825.00	106.4 PK			1.07 H	357	66.33	40.02
4	*5825.00	93.5 AV			1.07 H	357	53.45	40.02
5	#5850.00	71.4 PK	86.4	-15.0	1.03 H	286	31.31	40.08
6	#5850.00	47.9 AV	73.5	-25.6	1.03 H	286	7.85	40.08
7	11650.00	60.6 PK	74.0	-13.4	1.59 H	252	10.24	50.34
8	11650.00	47.4 AV	54.0	-6.6	1.59 H	252	-2.98	50.34
ANTENNA POLARITY & TEST DISTANCE: VERTICAL AT 3 M								
NO.	FREQ. (MHz)	EMISSION LEVEL (dBuV/m)	LIMIT (dBuV/m)	MARGIN (dB)	ANTENNA HEIGHT (m)	TABLE ANGLE (Degree)	RAW VALUE (dBuV)	CORRECTION FACTOR (dB/m)
1	2500.00	61.1 PK	74.0	-12.9	1.06 V	256	28.45	32.62
2	2500.00	52.9 AV	54.0	-1.1	1.06 V	256	20.32	32.62
3	*5825.00	106.1 PK			1.09 V	251	66.05	40.02
4	*5825.00	93.0 AV			1.09 V	251	52.99	40.02
5	#5850.00	60.0 PK	86.1	-26.1	1.03 V	257	19.89	40.08
6	#5850.00	45.3 AV	73.0	-27.7	1.03 V	257	5.18	40.08
7	11650.00	59.7 PK	74.0	-14.3	1.23 V	153	9.31	50.34
8	11650.00	46.1 AV	54.0	-7.9	1.23 V	153	-4.21	50.34

- REMARKS:**
1. Emission level (dBuV/m) = Raw Value (dBuV) + Correction Factor (dB/m).
  2. Correction Factor (dB/m) = Antenna Factor (dB/m) + Cable Factor (dB).
  3. The other emission levels were very low against the limit.
  4. Margin value = Emission level – Limit value.
  5. “ \* “: Fundamental frequency.
  6. The limit value is defined as per 15.247.
  7. "#":The radiated frequency is out the restricted band.



A D T

## 802.11a (Antenna B)

EUT TEST CONDITION		MEASUREMENT DETAIL	
CHANNEL	Channel 149	FREQUENCY RANGE	1 ~ 40GHz
INPUT POWER (SYSTEM)	120Vac, 60 Hz	DETECTOR FUNCTION	Peak (PK) Average (AV)
ENVIRONMENTAL CONDITIONS	21deg. C, 65%RH 1020 hPa	TESTED BY	Lori Chiu

ANTENNA POLARITY & TEST DISTANCE: HORIZONTAL AT 3 M								
NO.	FREQ. (MHz)	EMISSION LEVEL (dBuV/m)	LIMIT (dBuV/m)	MARGIN (dB)	ANTENNA HEIGHT (m)	TABLE ANGLE (Degree)	RAW VALUE (dBuV)	CORRECTION FACTOR (dB/m)
1	2500.00	59.2 PK	74.0	-14.8	1.22 H	15	26.55	32.62
2	2500.00	48.2 AV	54.0	-5.8	1.22 H	15	15.60	32.62
3	#5725.00	74.5 PK	81.3	-6.8	1.09 H	262	34.60	39.92
4	#5725.00	52.3 AV	67.4	-15.1	1.09 H	262	12.41	39.92
5	*5745.00	101.3 PK			1.23 H	105	61.39	39.93
6	*5745.00	87.4 AV			1.23 H	105	47.42	39.93
7	11490.00	60.4 PK	74.0	-13.6	1.28 H	206	9.81	50.62
8	11490.00	47.3 AV	54.0	-6.7	1.28 H	206	-3.33	50.62

ANTENNA POLARITY & TEST DISTANCE: VERTICAL AT 3 M								
NO.	FREQ. (MHz)	EMISSION LEVEL (dBuV/m)	LIMIT (dBuV/m)	MARGIN (dB)	ANTENNA HEIGHT (m)	TABLE ANGLE (Degree)	RAW VALUE (dBuV)	CORRECTION FACTOR (dB/m)
1	2500.00	61.5 PK	74.0	-12.5	1.07 V	253	28.91	32.62
2	2500.00	53.0 AV	54.0	-1.0	1.07 V	253	20.34	32.62
3	#5725.00	76.6 PK	87.2	-10.6	1.07 V	248	36.66	39.92
4	#5725.00	54.3 AV	73.3	-19.0	1.07 V	248	14.38	39.92
5	*5745.00	107.2 PK			1.05 V	311	67.30	39.93
6	*5745.00	93.3 AV			1.05 V	311	53.39	39.93
7	11490.00	59.3 PK	74.0	-14.7	1.29 V	104	8.71	50.62
8	11490.00	46.3 AV	54.0	-7.7	1.29 V	104	-4.37	50.62

- REMARKS:**
1. Emission level (dBuV/m) = Raw Value (dBuV) + Correction Factor (dB/m).
  2. Correction Factor (dB/m) = Antenna Factor (dB/m) + Cable Factor (dB).
  3. The other emission levels were very low against the limit.
  4. Margin value = Emission level – Limit value.
  5. “ \* ”: Fundamental frequency.
  6. The limit value is defined as per 15.247.
  7. "#": The radiated frequency is out the restricted band.



A D T

EUT TEST CONDITION		MEASUREMENT DETAIL	
CHANNEL	Channel 157	FREQUENCY RANGE	1 ~ 40GHz
INPUT POWER (SYSTEM)	120Vac, 60 Hz	DETECTOR FUNCTION	Peak (PK) Average (AV)
ENVIRONMENTAL CONDITIONS	21deg. C, 65%RH 1020 hPa	TESTED BY	Lori Chiu

ANTENNA POLARITY & TEST DISTANCE: HORIZONTAL AT 3 M								
NO.	FREQ. (MHz)	EMISSION LEVEL (dBuV/m)	LIMIT (dBuV/m)	MARGIN (dB)	ANTENNA HEIGHT (m)	TABLE ANGLE (Degree)	RAW VALUE (dBuV)	CORRECTION FACTOR (dB/m)
1	2500.00	59.2 PK	74.0	-14.8	1.17 H	23	26.59	32.62
2	2500.00	48.3 AV	54.0	-5.7	1.17 H	23	15.67	32.62
3	*5785.00	101.1 PK			1.18 H	159	61.15	39.96
4	*5785.00	87.2 AV			1.18 H	159	47.27	39.96
5	11570.00	60.5 PK	74.0	-13.5	1.39 H	277	10.02	50.50
6	11570.00	47.6 AV	54.0	-6.4	1.39 H	277	-2.87	50.50
ANTENNA POLARITY & TEST DISTANCE: VERTICAL AT 3 M								
NO.	FREQ. (MHz)	EMISSION LEVEL (dBuV/m)	LIMIT (dBuV/m)	MARGIN (dB)	ANTENNA HEIGHT (m)	TABLE ANGLE (Degree)	RAW VALUE (dBuV)	CORRECTION FACTOR (dB/m)
1	2500.00	61.6 PK	74.0	-12.4	1.12 V	271	29.01	32.62
2	2500.00	52.9 AV	54.0	-1.1	1.12 V	271	20.29	32.62
3	*5785.00	107.0 PK			1.08 V	269	67.07	39.96
4	*5785.00	93.1 AV			1.08 V	269	53.15	39.96
5	11570.00	59.1 PK	74.0	-14.9	1.53 V	152	8.64	50.50
6	11570.00	46.3 AV	54.0	-7.7	1.53 V	152	-4.17	50.50

- REMARKS:**
1. Emission level (dBuV/m) = Raw Value (dBuV) + Correction Factor (dB/m).
  2. Correction Factor (dB/m) = Antenna Factor (dB/m) + Cable Factor (dB).
  3. The other emission levels were very low against the limit.
  4. Margin value = Emission level – Limit value.
  5. “ \* “: Fundamental frequency.
  6. The limit value is defined as per 15.247.



A D T

EUT TEST CONDITION		MEASUREMENT DETAIL	
CHANNEL	Channel 165	FREQUENCY RANGE	1 ~ 40GHz
INPUT POWER (SYSTEM)	120Vac, 60 Hz	DETECTOR FUNCTION	Peak (PK) Average (AV)
ENVIRONMENTAL CONDITIONS	21deg. C, 65%RH 1020 hPa	TESTED BY	Lori Chiu

ANTENNA POLARITY & TEST DISTANCE: HORIZONTAL AT 3 M								
NO.	FREQ. (MHz)	EMISSION LEVEL (dBuV/m)	LIMIT (dBuV/m)	MARGIN (dB)	ANTENNA HEIGHT (m)	TABLE ANGLE (Degree)	RAW VALUE (dBuV)	CORRECTION FACTOR (dB/m)
1	2500.00	57.2 PK	74.0	-16.8	1.29 H	57	24.59	32.62
2	2500.00	48.0 AV	54.0	-6.0	1.29 H	57	15.41	32.62
3	*5825.00	100.9 PK			1.08 H	251	60.91	40.02
4	*5825.00	87.0 AV			1.08 H	251	47.01	40.02
5	#5850.00	74.2 PK	80.9	-6.7	1.11 H	327	34.16	40.08
6	#5850.00	52.3 AV	67.0	-14.7	1.11 H	327	12.17	40.08
7	11650.00	60.2 PK	74.0	-13.8	1.21 H	255	9.83	50.34
8	11650.00	47.5 AV	54.0	-6.5	1.21 H	255	-2.81	50.34
ANTENNA POLARITY & TEST DISTANCE: VERTICAL AT 3 M								
NO.	FREQ. (MHz)	EMISSION LEVEL (dBuV/m)	LIMIT (dBuV/m)	MARGIN (dB)	ANTENNA HEIGHT (m)	TABLE ANGLE (Degree)	RAW VALUE (dBuV)	CORRECTION FACTOR (dB/m)
1	2500.00	61.3 PK	74.0	-12.7	1.18 V	217	28.70	32.62
2	2500.00	52.9 AV	54.0	-1.1	1.18 V	217	20.30	32.62
3	*5825.00	106.7 PK			1.07 V	246	66.69	40.02
4	*5825.00	92.9 AV			1.07 V	246	52.83	40.02
5	#5850.00	59.7 PK	86.7	-27.0	1.09 V	277	19.57	40.08
6	#5850.00	45.5 AV	72.9	-27.4	1.09 V	277	5.39	40.08
7	11650.00	59.1 PK	74.0	-14.9	1.22 V	137	8.73	50.34
8	11650.00	46.2 AV	54.0	-7.8	1.22 V	137	-4.13	50.34

- REMARKS:**
1. Emission level (dBuV/m) = Raw Value (dBuV) + Correction Factor (dB/m).
  2. Correction Factor (dB/m) = Antenna Factor (dB/m) + Cable Factor (dB).
  3. The other emission levels were very low against the limit.
  4. Margin value = Emission level – Limit value.
  5. “ \* “: Fundamental frequency.
  6. The limit value is defined as per 15.247.
  7. "#":The radiated frequency is out the restricted band.





A D T

802.11n (20MHz)

EUT TEST CONDITION		MEASUREMENT DETAIL	
CHANNEL	Channel 149	FREQUENCY RANGE	1 ~ 40GHz
INPUT POWER (SYSTEM)	120Vac, 60 Hz	DETECTOR FUNCTION	Peak (PK) Average (AV)
ENVIRONMENTAL CONDITIONS	21deg. C, 65%RH 1020 hPa	TESTED BY	Lori Chiu

ANTENNA POLARITY & TEST DISTANCE: HORIZONTAL AT 3 M								
NO.	FREQ. (MHz)	EMISSION LEVEL (dBuV/m)	LIMIT (dBuV/m)	MARGIN (dB)	ANTENNA HEIGHT (m)	TABLE ANGLE (Degree)	RAW VALUE (dBuV)	CORRECTION FACTOR (dB/m)
1	2500.00	59.2 PK	74.0	-14.8	1.09 H	247	26.61	32.62
2	2500.00	48.7 AV	54.0	-5.3	1.09 H	247	16.07	32.62
3	#5725.00	82.0 PK	88.3	-6.3	1.04 H	353	42.04	39.92
4	#5725.00	58.5 AV	74.9	-16.4	1.04 H	353	18.56	39.92
5	*5745.00	108.3 PK			1.06 H	1	68.36	39.93
6	*5745.00	94.9 AV			1.06 H	1	54.93	39.93
7	11490.00	60.9 PK	74.0	-13.1	1.35 H	255	10.25	50.62
8	11490.00	47.2 AV	54.0	-6.8	1.35 H	255	-3.42	50.62

ANTENNA POLARITY & TEST DISTANCE: VERTICAL AT 3 M								
NO.	FREQ. (MHz)	EMISSION LEVEL (dBuV/m)	LIMIT (dBuV/m)	MARGIN (dB)	ANTENNA HEIGHT (m)	TABLE ANGLE (Degree)	RAW VALUE (dBuV)	CORRECTION FACTOR (dB/m)
1	2500.00	61.5 PK	74.0	-12.5	1.33 V	17	28.90	32.62
2	2500.00	53.0 AV	54.0	-1.0	1.33 V	17	20.36	32.62
3	#5725.00	77.0 PK	87.9	-10.9	1.00 V	272	37.10	39.92
4	#5725.00	55.2 AV	73.8	-18.6	1.00 V	272	15.27	39.92
5	*5745.00	107.9 PK			1.06 V	19	67.98	39.93
6	*5745.00	93.8 AV			1.06 V	19	53.85	39.93
7	11490.00	58.6 PK	74.0	-15.4	1.25 V	332	7.98	50.62
8	11490.00	47.0 AV	54.0	-7.0	1.25 V	332	-3.58	50.62

- REMARKS:**
1. Emission level (dBuV/m) = Raw Value (dBuV) + Correction Factor (dB/m).
  2. Correction Factor (dB/m) = Antenna Factor (dB/m) + Cable Factor (dB).
  3. The other emission levels were very low against the limit.
  4. Margin value = Emission level – Limit value.
  5. “ \* “: Fundamental frequency.
  6. The limit value is defined as per 15.247.
  7. “#”:The radiated frequency is out the restricted band.



A D T

EUT TEST CONDITION		MEASUREMENT DETAIL	
CHANNEL	Channel 157	FREQUENCY RANGE	1 ~ 40GHz
INPUT POWER (SYSTEM)	120Vac, 60 Hz	DETECTOR FUNCTION	Peak (PK) Average (AV)
ENVIRONMENTAL CONDITIONS	21deg. C, 65%RH 1020 hPa	TESTED BY	Lori Chiu

ANTENNA POLARITY & TEST DISTANCE: HORIZONTAL AT 3 M								
NO.	FREQ. (MHz)	EMISSION LEVEL (dBuV/m)	LIMIT (dBuV/m)	MARGIN (dB)	ANTENNA HEIGHT (m)	TABLE ANGLE (Degree)	RAW VALUE (dBuV)	CORRECTION FACTOR (dB/m)
1	2500.00	59.6 PK	74.0	-14.4	1.12 H	251	27.01	32.62
2	2500.00	48.5 AV	54.0	-5.5	1.12 H	251	15.85	32.62
3	*5785.00	108.1 PK			1.13 H	3	68.17	39.96
4	*5785.00	94.7 AV			1.13 H	3	54.76	39.96
5	11570.00	60.6 PK	74.0	-13.4	1.24 H	269	10.09	50.50
6	11570.00	47.2 AV	54.0	-6.8	1.24 H	269	-3.33	50.50
ANTENNA POLARITY & TEST DISTANCE: VERTICAL AT 3 M								
NO.	FREQ. (MHz)	EMISSION LEVEL (dBuV/m)	LIMIT (dBuV/m)	MARGIN (dB)	ANTENNA HEIGHT (m)	TABLE ANGLE (Degree)	RAW VALUE (dBuV)	CORRECTION FACTOR (dB/m)
1	2500.00	61.2 PK	74.0	-12.8	1.25 V	33	28.60	32.62
2	2500.00	52.9 AV	54.0	-1.1	1.25 V	33	20.32	32.62
3	*5785.00	107.7 PK			1.05 V	53	67.72	39.96
4	*5785.00	93.5 AV			1.05 V	53	53.55	39.96
5	11570.00	58.5 PK	74.0	-15.6	1.18 V	236	7.95	50.50
6	11570.00	46.9 AV	54.0	-7.1	1.18 V	236	-3.57	50.50

- REMARKS:**
1. Emission level (dBuV/m) = Raw Value (dBuV) + Correction Factor (dB/m).
  2. Correction Factor (dB/m) = Antenna Factor (dB/m) + Cable Factor (dB).
  3. The other emission levels were very low against the limit.
  4. Margin value = Emission level – Limit value.
  5. “ \* “: Fundamental frequency.
  6. The limit value is defined as per 15.247.



**A D T**

EUT TEST CONDITION		MEASUREMENT DETAIL	
CHANNEL	Channel 165	FREQUENCY RANGE	1 ~ 40GHz
INPUT POWER (SYSTEM)	120Vac, 60 Hz	DETECTOR FUNCTION	Peak (PK) Average (AV)
ENVIRONMENTAL CONDITIONS	21deg. C, 65%RH 1020 hPa	TESTED BY	Lori Chiu

ANTENNA POLARITY & TEST DISTANCE: HORIZONTAL AT 3 M								
NO.	FREQ. (MHz)	EMISSION LEVEL (dBuV/m)	LIMIT (dBuV/m)	MARGIN (dB)	ANTENNA HEIGHT (m)	TABLE ANGLE (Degree)	RAW VALUE (dBuV)	CORRECTION FACTOR (dB/m)
1	2500.00	59.5 PK	74.0	-14.5	1.32 H	267	26.91	32.62
2	2500.00	48.8 AV	54.0	-5.2	1.32 H	267	16.15	32.62
3	*5825.00	107.9 PK			1.05 H	18	67.90	40.02
4	*5825.00	94.2 AV			1.05 H	18	54.21	40.02
5	#5850.00	80.4 PK	87.9	-7.5	1.09 H	296	40.27	40.08
6	#5850.00	57.4 AV	74.2	-16.8	1.09 H	296	17.35	40.08
7	11650.00	60.3 PK	74.0	-13.7	1.27 H	58	9.97	50.34
8	11650.00	46.9 AV	54.0	-7.1	1.27 H	58	-3.46	50.34
ANTENNA POLARITY & TEST DISTANCE: VERTICAL AT 3 M								
NO.	FREQ. (MHz)	EMISSION LEVEL (dBuV/m)	LIMIT (dBuV/m)	MARGIN (dB)	ANTENNA HEIGHT (m)	TABLE ANGLE (Degree)	RAW VALUE (dBuV)	CORRECTION FACTOR (dB/m)
1	2500.00	61.4 PK	74.0	-12.6	1.17 V	23	28.77	32.62
2	2500.00	53.0 AV	54.0	-1.0	1.17 V	23	20.35	32.62
3	*5825.00	107.3 PK			1.03 V	211	67.23	40.02
4	*5825.00	93.1 AV			1.03 V	211	53.09	40.02
5	#5850.00	76.2 PK	87.3	-11.1	1.05 V	239	36.11	40.08
6	#5850.00	54.7 AV	73.1	-18.4	1.05 V	239	14.64	40.08
7	11650.00	58.2 PK	74.0	-15.8	1.35 V	307	7.89	50.34
8	11650.00	46.4 AV	54.0	-7.6	1.35 V	307	-3.97	50.34

- REMARKS:**
1. Emission level (dBuV/m) = Raw Value (dBuV) + Correction Factor (dB/m).
  2. Correction Factor (dB/m) = Antenna Factor (dB/m) + Cable Factor (dB).
  3. The other emission levels were very low against the limit.
  4. Margin value = Emission level – Limit value.
  5. “ \* “: Fundamental frequency.
  6. The limit value is defined as per 15.247.
  7. “#”:The radiated frequency is out the restricted band.



A D T

802.11n (40MHz)

EUT TEST CONDITION		MEASUREMENT DETAIL	
CHANNEL	Channel 151	FREQUENCY RANGE	1 ~ 40GHz
INPUT POWER (SYSTEM)	120Vac, 60 Hz	DETECTOR FUNCTION	Peak (PK) Average (AV)
ENVIRONMENTAL CONDITIONS	21deg. C, 65%RH 1020 hPa	TESTED BY	Lori Chiu

ANTENNA POLARITY & TEST DISTANCE: HORIZONTAL AT 3 M								
NO.	FREQ. (MHz)	EMISSION LEVEL (dBuV/m)	LIMIT (dBuV/m)	MARGIN (dB)	ANTENNA HEIGHT (m)	TABLE ANGLE (Degree)	RAW VALUE (dBuV)	CORRECTION FACTOR (dB/m)
1	2500.00	60.3 PK	74.0	-13.7	1.01 H	110	27.72	32.62
2	2500.00	48.6 AV	54.0	-5.4	1.01 H	110	16.01	32.62
3	#5725.00	76.7 PK	87.4	-10.7	1.09 H	359	36.73	39.92
4	#5725.00	56.7 AV	74.3	-17.6	1.09 H	359	16.74	39.92
5	*5755.00	107.4 PK			1.09 H	359	67.49	39.94
6	*5755.00	94.3 AV			1.09 H	359	54.34	39.94
7	11510.00	57.7 PK	74.0	-16.3	1.01 H	287	7.06	50.63
8	11510.00	46.1 AV	54.0	-7.9	1.01 H	287	-4.52	50.63
ANTENNA POLARITY & TEST DISTANCE: VERTICAL AT 3 M								
NO.	FREQ. (MHz)	EMISSION LEVEL (dBuV/m)	LIMIT (dBuV/m)	MARGIN (dB)	ANTENNA HEIGHT (m)	TABLE ANGLE (Degree)	RAW VALUE (dBuV)	CORRECTION FACTOR (dB/m)
1	2500.00	61.6 PK	74.0	-12.4	1.00 V	140	28.96	32.62
2	2500.00	53.0 AV	54.0	-1.0	1.00 V	140	20.34	32.62
3	#5725.00	72.6 PK	85.5	-12.9	1.00 V	255	32.68	39.92
4	#5725.00	53.7 AV	72.4	-18.7	1.00 V	255	13.77	39.92
5	*5755.00	105.5 PK			1.00 V	255	65.60	39.94
6	*5755.00	92.4 AV			1.00 V	255	52.43	39.94
7	11510.00	58.4 PK	74.0	-15.6	1.23 V	61	7.73	50.63
8	11510.00	45.5 AV	54.0	-8.5	1.23 V	61	-5.18	50.63

- REMARKS:**
1. Emission level (dBuV/m) = Raw Value (dBuV) + Correction Factor (dB/m).
  2. Correction Factor (dB/m) = Antenna Factor (dB/m) + Cable Factor (dB).
  3. The other emission levels were very low against the limit.
  4. Margin value = Emission level – Limit value.
  5. “ \* “: Fundamental frequency.
  6. The limit value is defined as per 15.247.
  7. “#“:The radiated frequency is out the restricted band.



A D T

EUT TEST CONDITION		MEASUREMENT DETAIL	
CHANNEL	Channel 159	FREQUENCY RANGE	1 ~ 40GHz
INPUT POWER (SYSTEM)	120Vac, 60 Hz	DETECTOR FUNCTION	Peak (PK) Average (AV)
ENVIRONMENTAL CONDITIONS	21deg. C, 65%RH 1020 hPa	TESTED BY	Lori Chiu

ANTENNA POLARITY & TEST DISTANCE: HORIZONTAL AT 3 M								
NO.	FREQ. (MHz)	EMISSION LEVEL (dBuV/m)	LIMIT (dBuV/m)	MARGIN (dB)	ANTENNA HEIGHT (m)	TABLE ANGLE (Degree)	RAW VALUE (dBuV)	CORRECTION FACTOR (dB/m)
1	2500.00	60.4 PK	74.0	-13.6	1.11 H	123	27.79	32.62
2	2500.00	48.7 AV	54.0	-5.3	1.11 H	123	16.08	32.62
3	*5795.00	106.9 PK			1.10 H	255	66.92	39.97
4	*5795.00	93.8 AV			1.10 H	255	53.78	39.97
5	#5850.00	73.4 PK	86.9	-13.5	1.10 H	255	33.34	40.08
6	#5850.00	53.5 AV	73.8	-20.3	1.10 H	255	13.42	40.08
7	11590.00	57.7 PK	74.0	-16.3	1.00 H	158	7.26	50.45
8	11590.00	46.3 AV	54.0	-7.7	1.00 H	158	-4.20	50.45
ANTENNA POLARITY & TEST DISTANCE: VERTICAL AT 3 M								
NO.	FREQ. (MHz)	EMISSION LEVEL (dBuV/m)	LIMIT (dBuV/m)	MARGIN (dB)	ANTENNA HEIGHT (m)	TABLE ANGLE (Degree)	RAW VALUE (dBuV)	CORRECTION FACTOR (dB/m)
1	2500.00	61.7 PK	74.0	-12.3	1.01 V	115	29.12	32.62
2	2500.00	53.0 AV	54.0	-1.0	1.01 V	115	20.37	32.62
3	*5795.00	104.8 PK			1.01 V	256	64.80	39.97
4	*5795.00	91.7 AV			1.01 V	256	51.71	39.97
5	#5850.00	70.0 PK	84.8	-14.8	1.01 V	256	29.95	40.08
6	#5850.00	51.4 AV	71.7	-20.3	1.01 V	256	11.31	40.08
7	11590.00	58.6 PK	74.0	-15.4	1.22 V	150	8.11	50.45
8	11590.00	45.6 AV	54.0	-8.4	1.22 V	150	-4.84	50.45

- REMARKS:**
1. Emission level (dBuV/m) = Raw Value (dBuV) + Correction Factor (dB/m).
  2. Correction Factor (dB/m) = Antenna Factor (dB/m) + Cable Factor (dB).
  3. The other emission levels were very low against the limit.
  4. Margin value = Emission level – Limit value.
  5. “ \* “: Fundamental frequency.
  6. The limit value is defined as per 15.247.
  7. "#":The radiated frequency is out the restricted band.



A D T

**BELOW 1GHz WORST-CASE DATA : 802.11n (20MHz)**

EUT TEST CONDITION		MEASUREMENT DETAIL	
CHANNEL	Channel 149	FREQUENCY RANGE	Below 1000MHz
INPUT POWER (SYSTEM)	120Vac, 60 Hz	DETECTOR FUNCTION	Quasi-Peak
ENVIRONMENTAL CONDITIONS	15deg. C, 63%RH 1020 hPa	TESTED BY	Lori Chiu

ANTENNA POLARITY & TEST DISTANCE: HORIZONTAL AT 3 M								
NO.	FREQ. (MHz)	EMISSION LEVEL (dBuV/m)	LIMIT (dBuV/m)	MARGIN (dB)	ANTENNA HEIGHT (m)	TABLE ANGLE (Degree)	RAW VALUE (dBuV)	CORRECTION FACTOR (dB/m)
1	61.01	30.3 QP	40.0	-9.7	2.00 H	172	17.05	13.20
2	201.00	37.6 QP	43.5	-5.9	1.25 H	136	26.96	10.63
3	333.21	36.5 QP	46.0	-9.5	1.00 H	106	22.07	14.45
4	498.47	38.5 QP	46.0	-7.5	2.00 H	154	19.33	19.19
5	753.18	42.1 QP	46.0	-3.9	2.00 H	313	18.06	24.03
6	877.61	38.4 QP	46.0	-7.6	1.25 H	145	12.51	25.90
ANTENNA POLARITY & TEST DISTANCE: VERTICAL AT 3 M								
NO.	FREQ. (MHz)	EMISSION LEVEL (dBuV/m)	LIMIT (dBuV/m)	MARGIN (dB)	ANTENNA HEIGHT (m)	TABLE ANGLE (Degree)	RAW VALUE (dBuV)	CORRECTION FACTOR (dB/m)
1	31.84	36.6 QP	40.0	-3.4	1.25 V	127	24.41	12.22
2	72.67	35.9 QP	40.0	-4.1	1.00 V	295	25.30	10.62
3	166.00	35.7 QP	43.5	-7.8	1.25 V	172	22.45	13.25
4	467.36	37.7 QP	46.0	-8.3	1.25 V	355	19.50	18.25
5	667.63	37.9 QP	46.0	-8.1	1.25 V	142	15.41	22.46
6	753.18	38.3 QP	46.0	-7.7	1.50 V	235	14.25	24.03

- REMARKS:**
1. Emission level (dBuV/m) = Raw Value (dBuV) + Correction Factor (dB/m).
  2. Correction Factor (dB/m) = Antenna Factor (dB/m) + Cable Factor (dB).
  3. The other emission levels were very low against the limit.
  4. Margin value = Emission level – Limit value.



## 5.2 CONDUCTED EMISSION MEASUREMENT

### 5.2.1 LIMITS OF CONDUCTED EMISSION MEASUREMENT

FREQUENCY OF EMISSION (MHz)	CONDUCTED LIMIT (dBµV)	
	Quasi-peak	Average
0.15 ~ 0.5	66 to 56	56 to 46
0.5 ~ 5	56	46
5 ~ 30	60	50

- NOTE:** 1. The lower limit shall apply at the transition frequencies.  
 2. The limit decreases in line with the logarithm of the frequency in the range of 0.15 to 0.50MHz.  
 3. All emanations from a class A/B digital device or system, including any network of conductors and apparatus connected thereto, shall not exceed the level of field strengths specified above.

### 5.2.2 TEST INSTRUMENTS

DESCRIPTION & MANUFACTURER	MODEL NO.	SERIAL NO.	DATE OF CALIBRATION	DUE DATE OF CALIBRATION
Test Receiver ROHDE & SCHWARZ	ESCS30	100289	Nov. 23, 2009	Nov. 22, 2010
RF signal cable Woken	5D-FB	Cable-HYC01-01	Dec. 31, 2008	Dec. 30, 2009
LISN ROHDE & SCHWARZ	ESH3-Z5	100312	Jun. 18, 2009	Jun. 17, 2010
LISN ROHDE & SCHWARZ	ESH3-Z5	835239/001	Feb. 24, 2009	Feb. 23, 2010
Software ADT	ADT_Cond_ V7.3.7	NA	NA	NA

- NOTE:** 1. The calibration interval of the above test instruments is 12 months and the calibrations are traceable to NML/ROC and NIST/USA.  
 2. The test was performed in HwaYa Shielded Room 1.  
 3. The VCCI Site Registration No. is C-2040.



A D T

### 5.2.3 TEST PROCEDURES

- a. The EUT was placed 0.4 meters from the conducting wall of the shielded room with EUT being connected to the power mains through a line impedance stabilization network (LISN). Other support units were connected to the power mains through another LISN. The two LISNs provide 50 ohm/ 50uH of coupling impedance for the measuring instrument.
- b. Both lines of the power mains connected to the EUT were checked for maximum conducted interference.
- c. The frequency range from 150kHz to 30MHz was searched. Emission levels under (Limit - 20dB) was not recorded.

### 5.2.4 DEVIATION FROM TEST STANDARD

No deviation



## 5.2.5 TEST SETUP

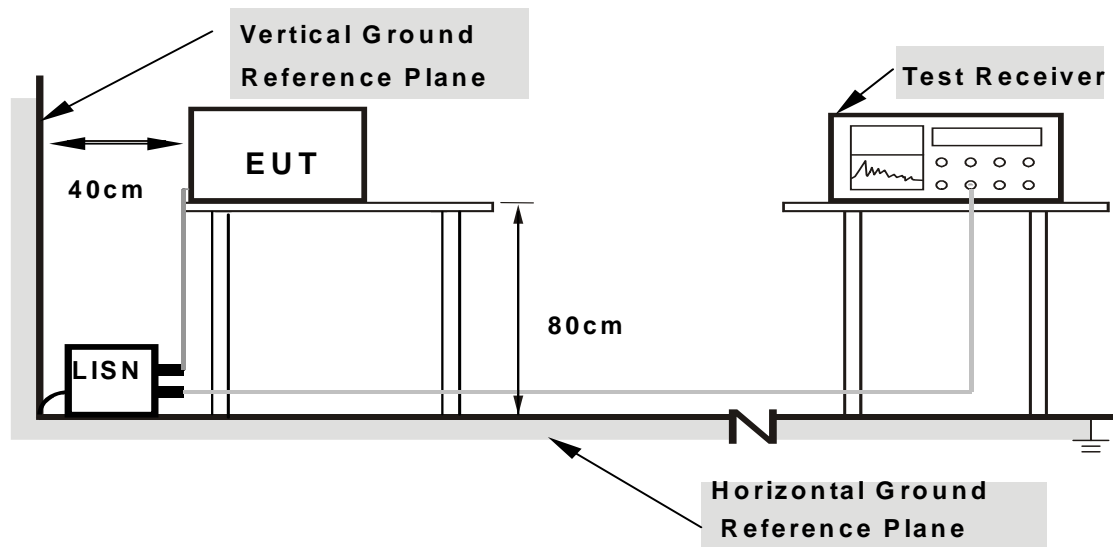

- Note:**
1. Support units were connected to second LISN.
  2. Both of LISNs (AMN) are 80 cm from EUT and at least 80 cm from other units and other metal planes

For the actual test configuration, please refer to the attached file (Test Setup Photo).

## 5.2.6 EUT OPERATING CONDITIONS

Same as 4.1.6



A D T

### 5.2.7 TEST RESULTS

CONDUCTED WORST-CASE DATA : 802.11n (20MHz)

PHASE	Line 1	6dB BANDWIDTH	9kHz
-------	--------	---------------	------

No	Freq. [MHz]	Corr. Factor (dB)	Reading Value		Emission Level		Limit		Margin	
			[dB (uV)]		[dB (uV)]		[dB (uV)]		(dB)	
			Q.P.	AV.	Q.P.	AV.	Q.P.	AV.	Q.P.	AV.
1	0.150	0.13	51.14	-	51.27	-	66.00	56.00	-14.73	-
2	0.220	0.13	43.96	-	44.09	-	62.81	52.81	-18.72	-
3	0.291	0.13	37.89	-	38.02	-	60.51	50.51	-22.48	-
4	0.673	0.14	36.52	-	36.66	-	56.00	46.00	-19.34	-
5	7.699	0.59	36.66	-	37.25	-	60.00	50.00	-22.75	-
6	18.746	1.29	34.39	-	35.68	-	60.00	50.00	-24.32	-

- REMARKS:**
1. Q.P. and AV. are abbreviations of quasi-peak and average individually.
  2. "-": The Quasi-peak reading value also meets average limit and measurement with the average detector is unnecessary.
  3. The emission levels of other frequencies were very low against the limit.
  4. Margin value = Emission level - Limit value
  5. Correction factor = Insertion loss + Cable loss
  6. Emission Level = Correction Factor + Reading Value.

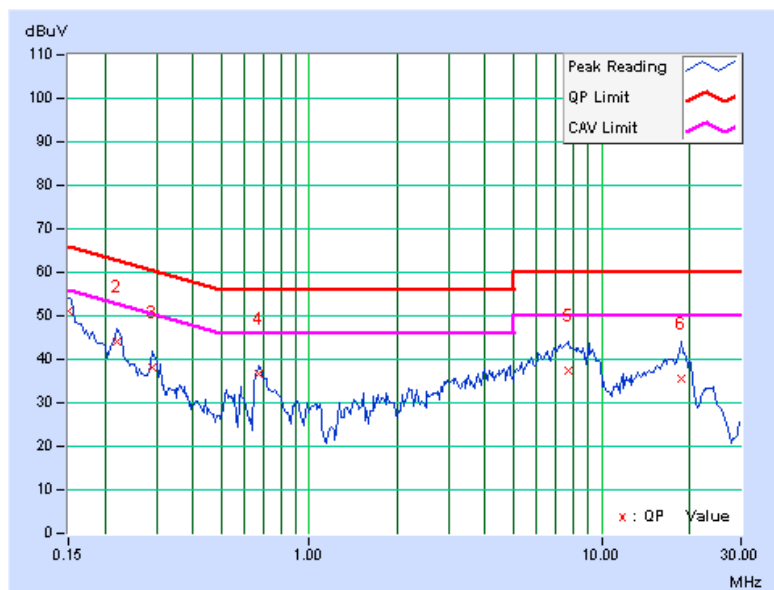

PHASE	Line 2	6dB BANDWIDTH	9kHz
-------	--------	---------------	------

No	Freq.	Corr.	Reading Value		Emission Level		Limit		Margin	
	[MHz]	Factor (dB)	[dB (uV)]		[dB (uV)]		[dB (uV)]		(dB)	
			Q.P.	AV.	Q.P.	AV.	Q.P.	AV.	Q.P.	AV.
1	0.150	0.09	51.12	-	51.21	-	66.00	56.00	-14.79	-
2	0.224	0.09	43.09	-	43.18	-	62.66	52.66	-19.48	-
3	0.298	0.09	37.51	-	37.60	-	60.29	50.29	-22.68	-
4	0.670	0.10	35.94	-	36.04	-	56.00	46.00	-19.96	-
5	8.133	0.47	35.39	-	35.86	-	60.00	50.00	-24.14	-
6	18.949	0.89	32.92	-	33.81	-	60.00	50.00	-26.19	-

- REMARKS:**
1. Q.P. and AV. are abbreviations of quasi-peak and average individually.
  2. "-": The Quasi-peak reading value also meets average limit and measurement with the average detector is unnecessary.
  3. The emission levels of other frequencies were very low against the limit.
  4. Margin value = Emission level - Limit value
  5. Correction factor = Insertion loss + Cable loss
  6. Emission Level = Correction Factor + Reading Value.

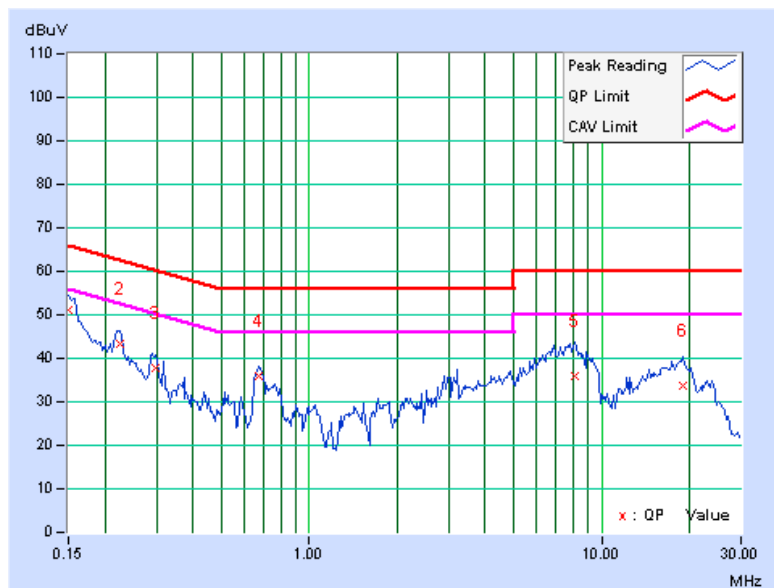



A D T

### 5.3 6dB BANDWIDTH MEASUREMENT

#### 5.3.1 LIMITS OF 6dB BANDWIDTH MEASUREMENT

The minimum of 6dB Bandwidth Measurement is 0.5MHz.

#### 5.3.2 TEST INSTRUMENTS

DESCRIPTION & MANUFACTURER	MODEL NO.	SERIAL NO.	DATE OF CALIBRATION	DUE DATE OF CALIBRATION
R&S SPECTRUM ANALYZER	FSP40	100040	Jul. 07, 2009	Jul. 06, 2010

**NOTE:** The calibration interval of the above test instruments is 12 months and the calibrations are traceable to NML/ROC and NIST/USA.

#### 5.3.3 TEST PROCEDURE

The transmitter output was connected to the spectrum analyzer through an attenuator. The bandwidth of the fundamental frequency was measured by spectrum analyzer with 100kHz RBW and 300kHz VBW. The 6dB bandwidth is defined as the total spectrum the power of which is higher than peak power minus 6dB.

### 5.3.4 DEVIATION FROM TEST STANDARD

No deviation

### 5.3.5 TEST SETUP

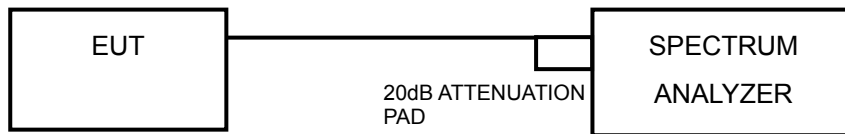

### 5.3.6 EUT OPERATING CONDITIONS

The software provided by client to enable the EUT under transmission condition continuously at lowest, middle and highest channel frequencies individually.



A D T

### 5.3.7 TEST RESULTS

#### 802.11a (Antenna A)

CHANNEL	CHANNEL FREQUENCY (MHz)	6dB BANDWIDTH (MHz)	MINIMUM LIMIT (MHz)	PASS / FAIL
149	5745	15.14	0.5	PASS
157	5785	15.37	0.5	PASS
165	5825	15.13	0.5	PASS

#### CH 157

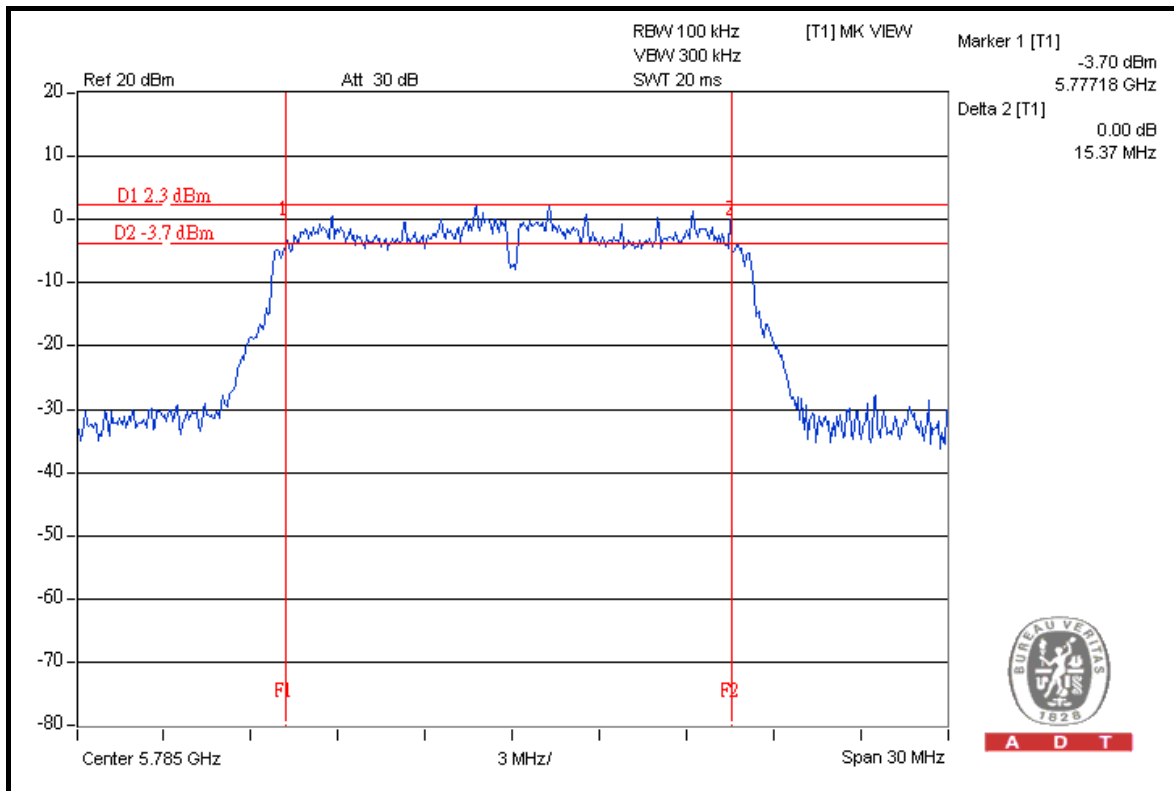



A D T

### 802.11a (Antenna B)

CHANNEL	CHANNEL FREQUENCY (MHz)	6dB BANDWIDTH (MHz)	MINIMUM LIMIT (MHz)	PASS / FAIL
149	5745	15.65	0.5	PASS
157	5785	15.68	0.5	PASS
165	5825	15.12	0.5	PASS

### CH 157

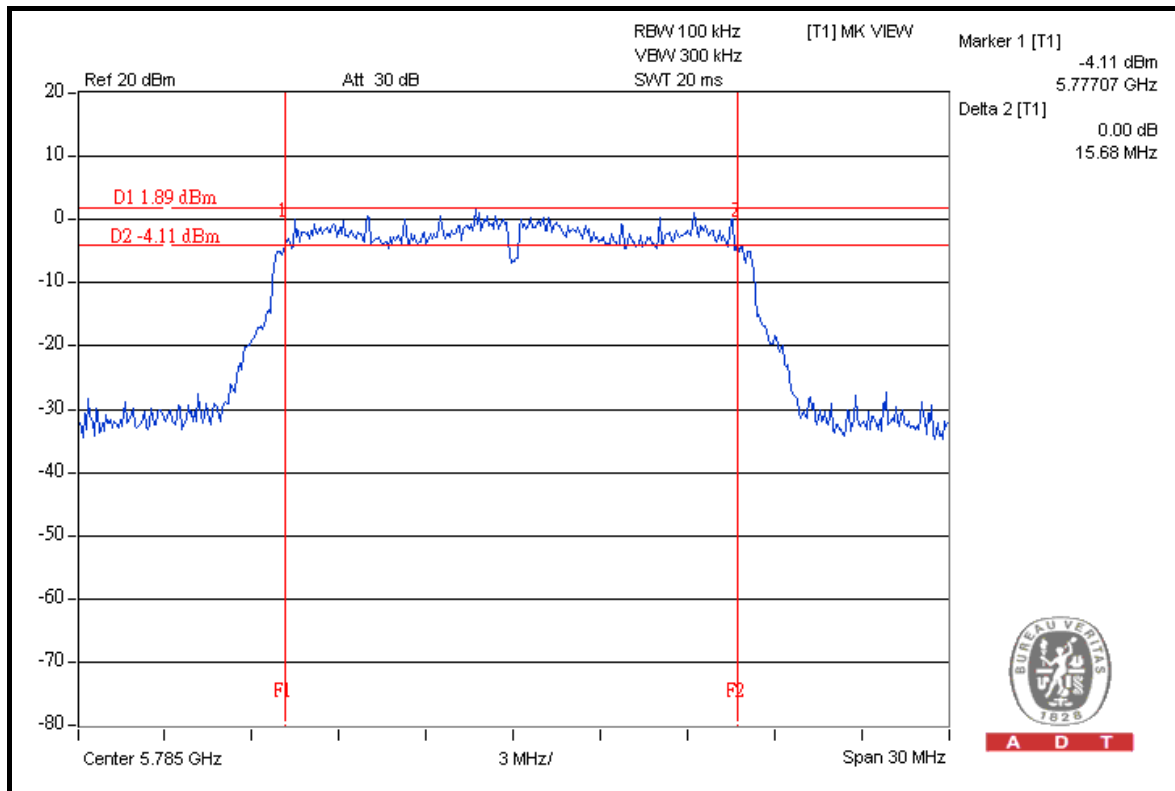



A D T

### 802.11n (20MHz)

CHANNEL	CHANNEL FREQUENCY (MHz)	6dB BANDWIDTH (MHz)		MINIMUM LIMIT (MHz)	PASS / FAIL
		CHAIN 0	CHAIN 1		
149	5745	15.40	15.90	0.5	PASS
157	5785	15.12	17.04	0.5	PASS
165	5825	15.28	17.00	0.5	PASS

### FOR CHAIN 1: CH 157

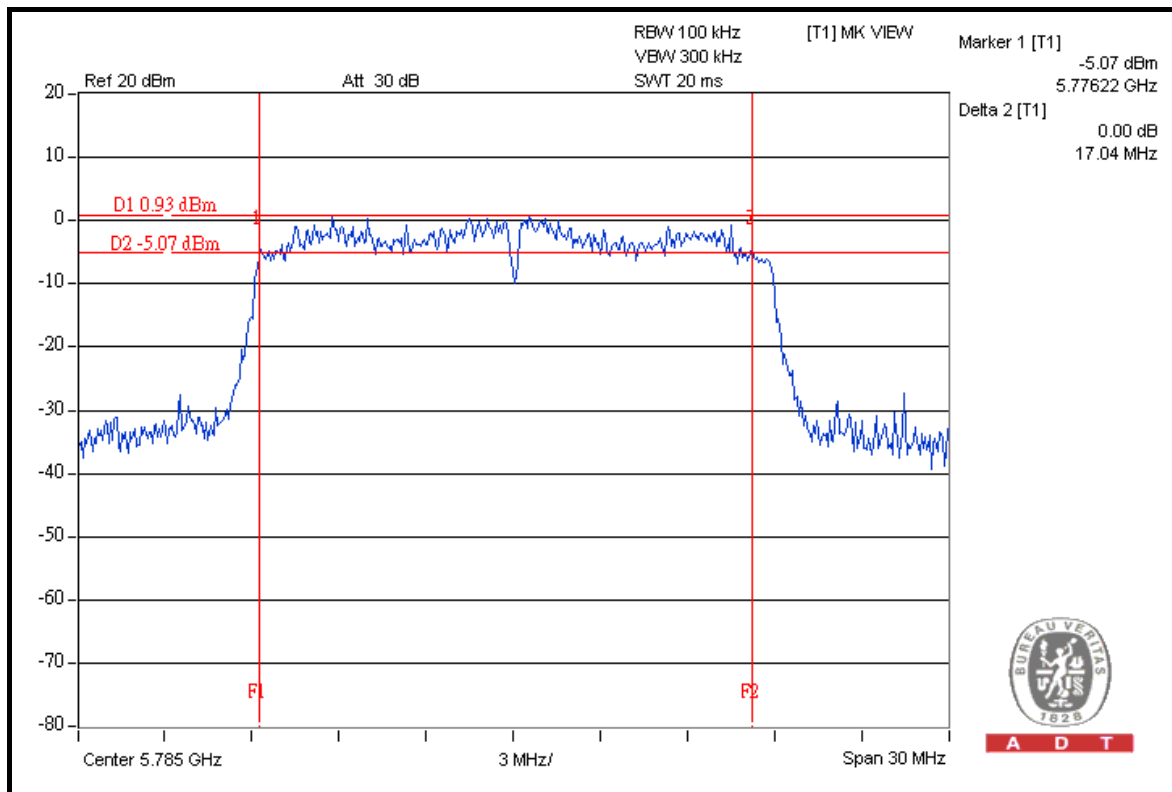



**802.11n (40MHz)**

CHANNEL	CHANNEL FREQUENCY (MHz)	6dB BANDWIDTH (MHz)		MINIMUM LIMIT (MHz)	PASS / FAIL
		CHAIN 0	CHAIN 1		
151	5755	35.82	36.41	0.5	PASS
159	5795	35.85	36.47	0.5	PASS

**FOR CHAIN 1: CH 159**

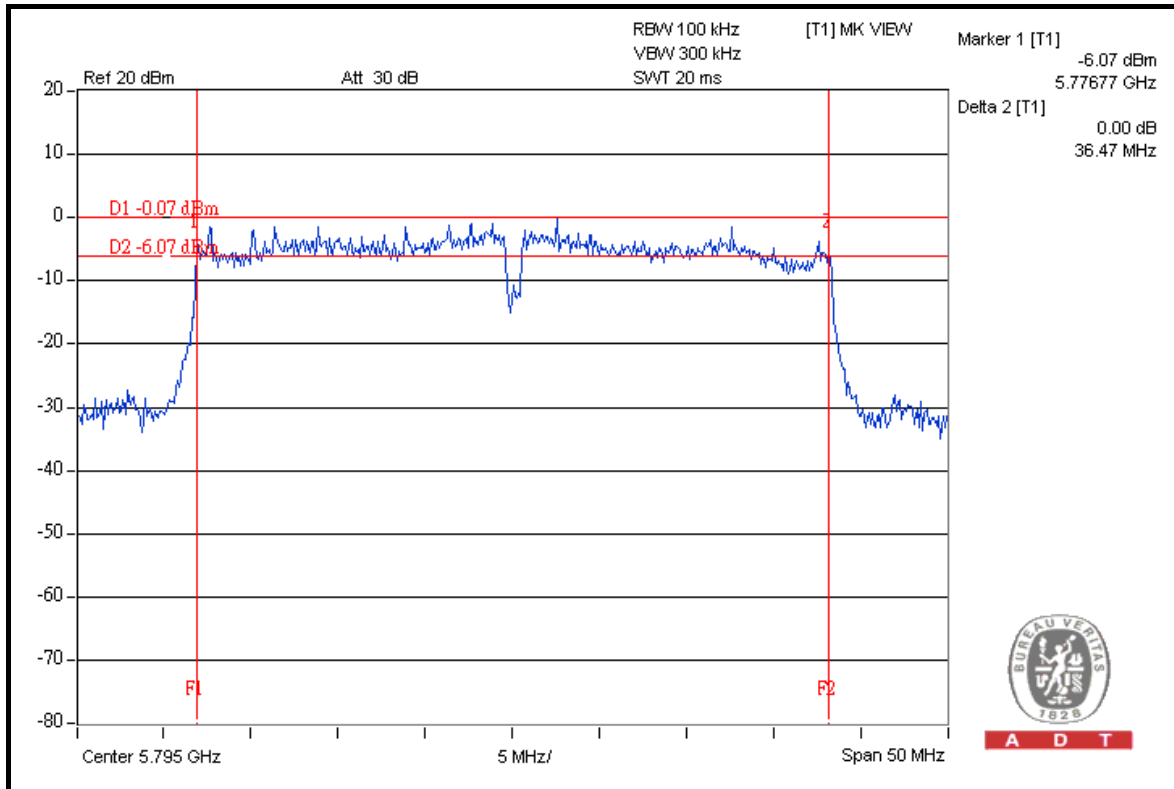



A D T

## 5.4 MAXIMUM OUTPUT POWER

### 5.4.1 LIMITS OF MAXIMUM OUTPUT POWER MEASUREMENT

The Maximum Peak Output Power Measurement is 30dBm.

### 5.4.2 INSTRUMENTS

DESCRIPTION & MANUFACTURER	MODEL NO.	SERIAL NO.	DATE OF CALIBRATION	DUE DATE OF CALIBRATION
High Speed Peak Power Meter	ML2495A	0824012	Aug. 10, 2009	Aug. 09, 2010
Power Sensor	MA2411B	0738138	Aug. 10, 2009	Aug. 09, 2010

**Note:**

1. The calibration interval of the above test instruments is 12 months and the calibrations are traceable to NML/ROC and NIST/USA.
2. Measurement Bandwidth of ML2495A is 65MHz greater than 6dB bandwidth of emission.

### 5.4.3 TEST PROCEDURES

A power sensor was used on the output port of the EUT. A power meter was used to read the response of the power sensor. Record the power level.

#### 5.4.4 DEVIATION FROM TEST STANDARD

No deviation

#### 5.4.5 TEST SETUP

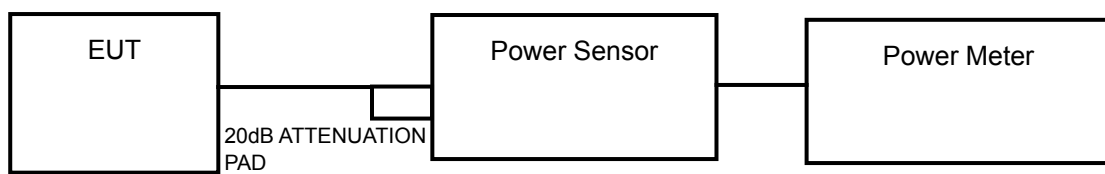

#### 5.4.6 EUT OPERATING CONDITIONS

Same as Item 5.3.6



A D T

## 5.4.7 TEST RESULTS

### 802.11a (Antenna A)

CHAN	CHANNEL FREQUENCY (MHz)	POWER OUTPUT (mW)	POWER OUTPUT (dBm)	POWER LIMIT (dBm)	PASS/FAIL
149	5745	166.0	22.2	30	PASS
157	5785	169.8	22.3	30	PASS
165	5825	177.8	22.5	30	PASS

### 802.11a (Antenna B)

CHAN	CHANNEL FREQUENCY (MHz)	POWER OUTPUT (mW)	POWER OUTPUT (dBm)	POWER LIMIT (dBm)	PASS/FAIL
149	5745	162.2	22.1	30	PASS
157	5785	162.2	22.1	30	PASS
165	5825	144.5	21.6	30	PASS

### 802.11n (20MHz)

CHAN.	CHAN. FREQ. (MHz)	POWER OUTPUT (dBm)		TOTAL POWER (mW)	TOTAL POWER (dBm)	POWER LIMIT (dBm)	PASS / FAIL
		CHAIN 0	CHAIN 1				
149	5745	22.3	23.2	378.8	25.8	30	PASS
157	5785	22.3	22.5	347.7	25.4	30	PASS
165	5825	22.4	22.2	339.7	25.3	30	PASS

### 802.11n (40MHz)

CHAN.	CHAN. FREQ. (MHz)	POWER OUTPUT (dBm)		TOTAL POWER (mW)	TOTAL POWER (dBm)	POWER LIMIT (dBm)	PASS / FAIL
		CHAIN 0	CHAIN 1				
151	5755	21.3	22.5	312.7	25.0	30	PASS
159	5795	21.8	21.9	306.2	24.9	30	PASS



A D T

## 5.5 POWER SPECTRAL DENSITY MEASUREMENT

### 5.5.1 LIMITS OF POWER SPECTRAL DENSITY MEASUREMENT

The Maximum of Power Spectral Density Measurement is 8dBm.

### 5.5.2 TEST INSTRUMENTS

DESCRIPTION & MANUFACTURER	MODEL NO.	SERIAL NO.	DATE OF CALIBRATION	DUE DATE OF CALIBRATION
R&S SPECTRUM ANALYZER	FSP40	100040	Jul. 07, 2009	Jul. 06, 2010

**NOTE:** The calibration interval of the above test instruments is 12 months and the calibrations are traceable to NML/ROC and NIST/USA.

### 5.5.3 TEST PROCEDURE

The transmitter output was connected to the spectrum analyzer through an attenuator, the bandwidth of the fundamental frequency was measured with the spectrum analyzer using 3kHz RBW and 30kHz VBW, set sweep time = span/3kHz. The power spectral density was measured and recorded.

The sweep time is allowed to be longer than span/3kHz for a full response of the mixer in the spectrum analyzer.



A D T

#### 5.5.4 DEVIATION FROM TEST STANDARD

No deviation

#### 5.5.5 TEST SETUP

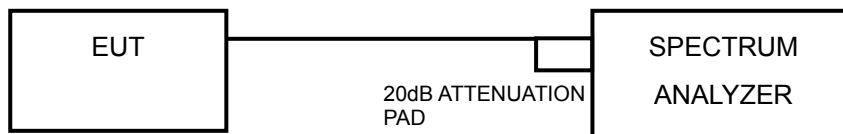

#### 5.5.6 EUT OPERATING CONDITION

Same as Item 5.3.6



A D T

### 5.5.7 TEST RESULTS

#### 802.11a (Antenna A)

CHANNEL	CHANNEL FREQUENCY (MHz)	RF POWER LEVEL IN 3 kHz BW (dBm)	MAXIMUM LIMIT (dBm)	PASS/FAIL
149	5745	-11.9	8	PASS
157	5785	-11.5	8	PASS
165	5825	-11.5	8	PASS

#### CH 165

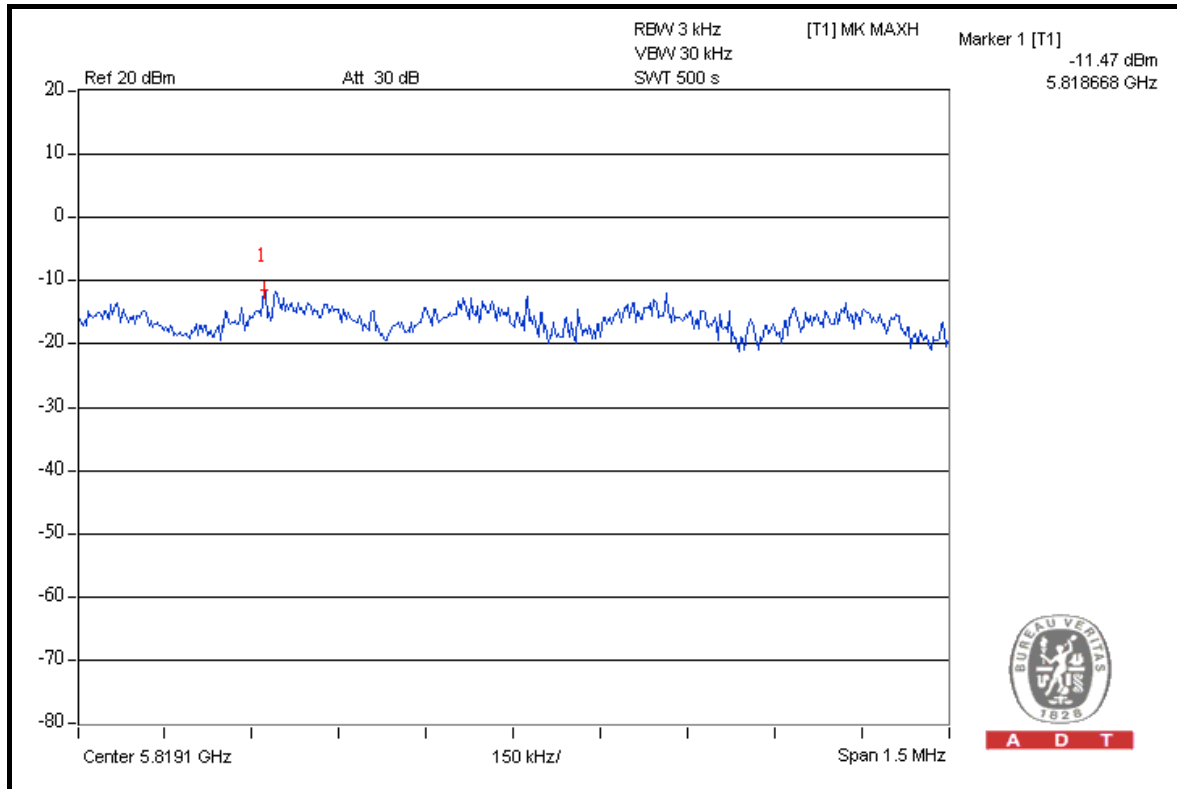



A D T

### 802.11a (Antenna B)

CHANNEL	CHANNEL FREQUENCY (MHz)	RF POWER LEVEL IN 3 kHz BW (dBm)	MAXIMUM LIMIT (dBm)	PASS/FAIL
149	5745	-9.8	8	PASS
157	5785	-9.6	8	PASS
165	5825	-10.1	8	PASS

### CH 157

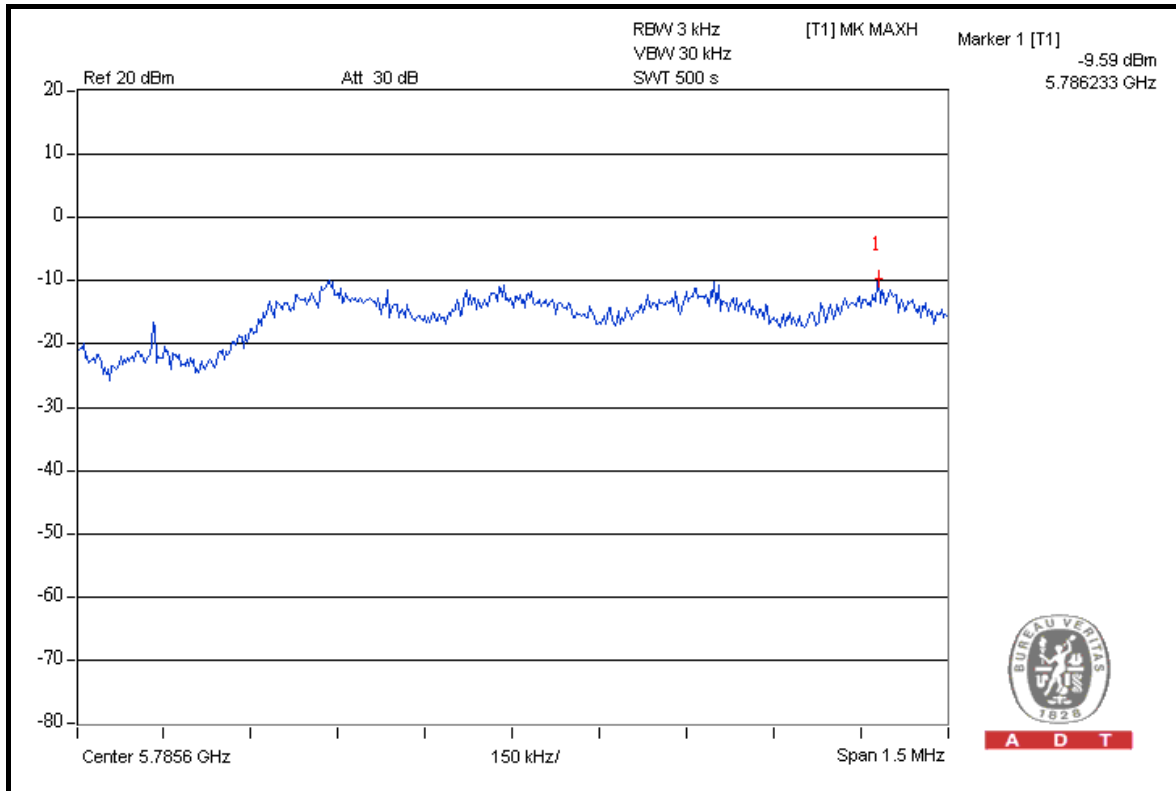





A D T

### 802.11n (20MHz)

CHANNEL	CHAN. FREQ. (MHz)	RF POWER LEVEL IN 3 kHz BW (dBm)		TOTAL POWER DENSITY (dBm)	MAXIMUM LIMIT (dBm)	PASS/FAIL
		CHAIN 0	CHAIN 1			
149	5745	-12.6	-12.8	-9.7	8	PASS
157	5785	-12.4	-13.2	-9.8	8	PASS
165	5825	-12.3	-13.5	-9.9	8	PASS

### FOR CHAIN 0: CH 165

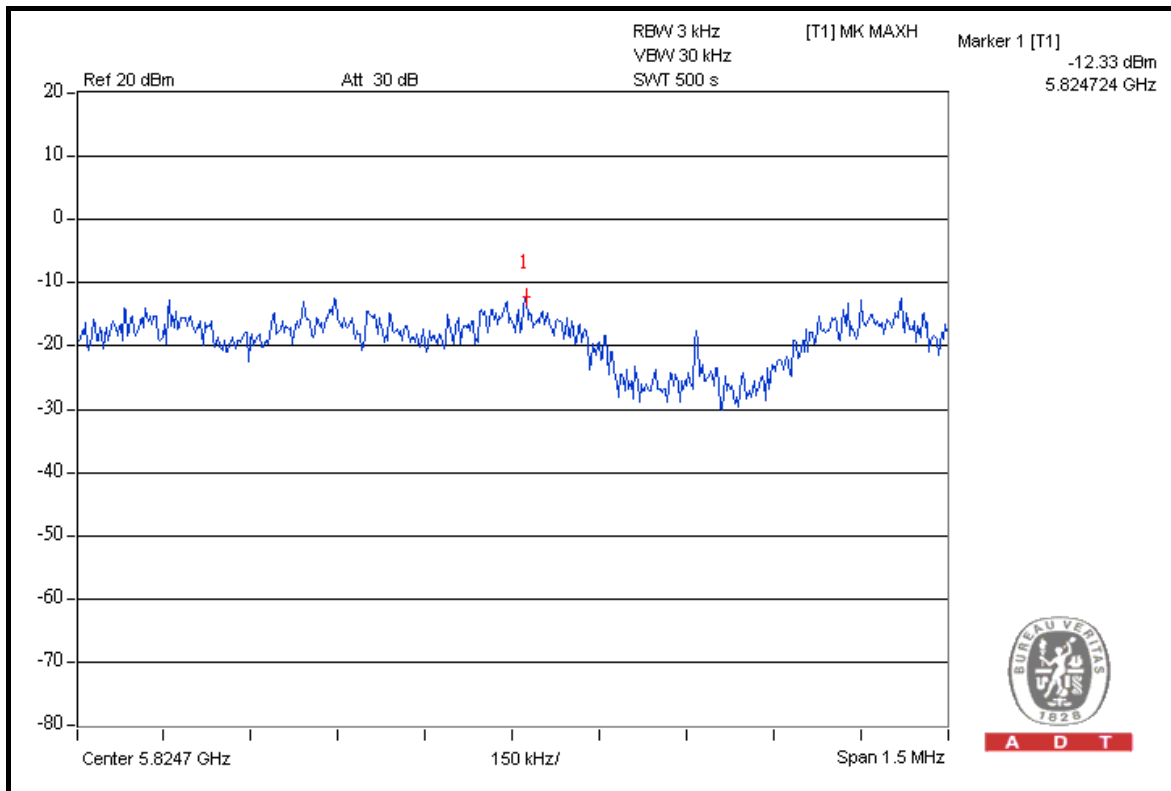



A D T

### 802.11n (40MHz)

CHANNEL	CHAN. FREQ. (MHz)	RF POWER LEVEL IN 3 kHz BW (dBm)		TOTAL POWER DENSITY (dBm)	MAXIMUM LIMIT (dBm)	PASS/FAIL
		CHAIN 0	CHAIN 1			
151	5755	-13.2	-13.9	-10.6	8	PASS
159	5795	-12.6	-14.3	-10.3	8	PASS

### FOR CHAIN 1: CH 159

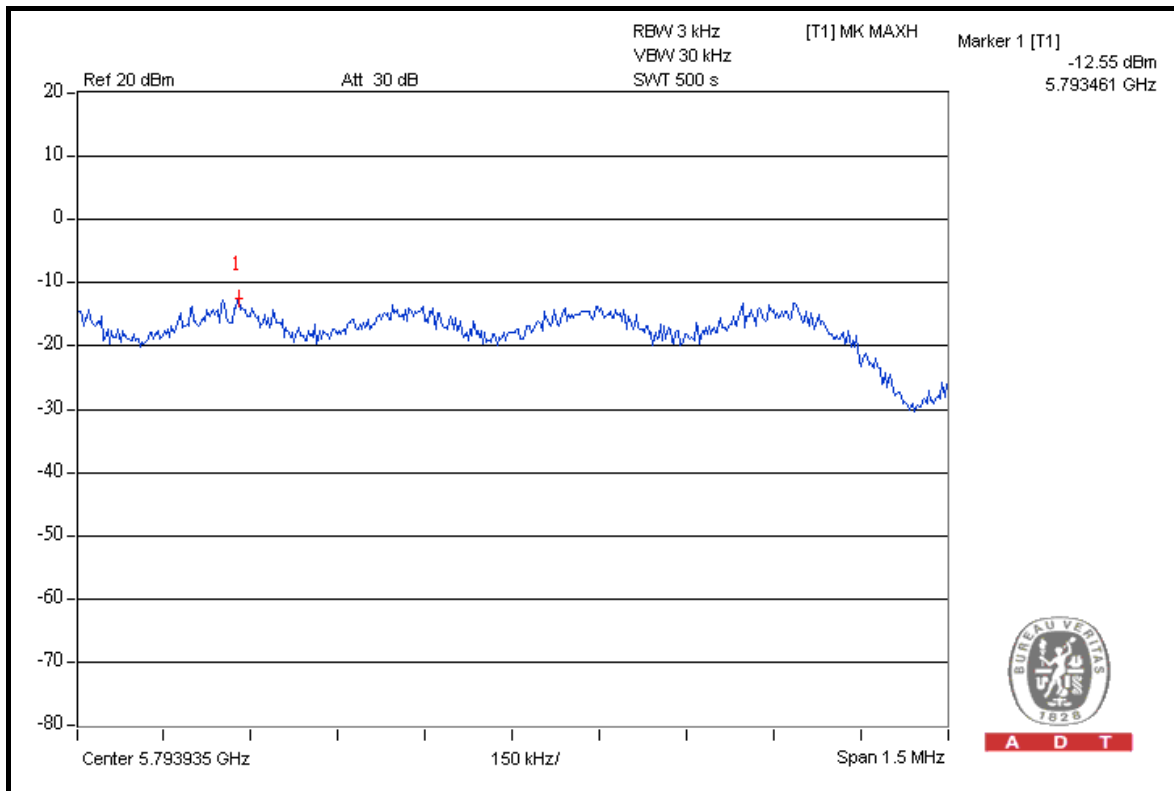



A D T

## 5.6 BAND EDGES MEASUREMENT

### 5.6.1 LIMITS OF BAND EDGES MEASUREMENT

Below -20dB of the highest emission level of operating band (in 100kHz Resolution Bandwidth).

### 5.6.2 TEST INSTRUMENTS

DESCRIPTION & MANUFACTURER	MODEL NO.	SERIAL NO.	DATE OF CALIBRATION	DUE DATE OF CALIBRATION
<b>FOR CONDUCTED MEASUREMENT</b>				
R&S SPECTRUM ANALYZER	FSP40	100040	Jul. 07, 2009	Jul. 06, 2010
<b>FOR RADIATED MEASUREMENT</b>				
Test Receiver ROHDE & SCHWARZ	ESIB7	100212	May 25, 2009	May 24, 2010
Spectrum Analyzer ROHDE & SCHWARZ	FSP40	100040	Jul. 07, 2009	Jul. 06, 2010
BILOG Antenna SCHWARZBECK	VULB9168	9168-156	Apr. 30, 2009	Apr. 29, 2010
HORN Antenna SCHWARZBECK	BBHA 9120 D	9120D-563	Aug. 10, 2009	Aug. 09, 2010
HORN Antenna SCHWARZBECK	BBHA 9170	BBHA9170242	Jan. 06, 2009	Jan. 05, 2010
Preamplifier Agilent	8449B	3008A01910	Sep. 11, 2009	Sep. 10, 2010
Preamplifier Agilent	8447D	2944A10738	Nov. 04, 2009	Nov. 03, 2010
RF signal cable HUBER+SUHNNER	SUCOFLEX 104	218190/4 231241/4	May 13, 2009	May 12, 2010
RF signal cable Worken	8D-FB	Cable-HYCH9-01	Aug. 17, 2009	Aug. 16, 2010
Software	ADT_Radiated_V7.6.15.9.2	NA	NA	NA
Antenna Tower EMCO	2070/2080	512.835.4684	NA	NA
Turn Table EMCO	2087-2.03	NA	NA	NA
Antenna Tower & Turn Table Controller EMCO	2090	NA	NA	NA
26GHz ~ 40GHz Amplifier	EM26400	07026401	Aug. 27, 2009	Aug. 26, 2010

**NOTE:** The calibration interval of the above test instruments is 12 months and the calibrations are traceable to NML/ROC and NIST/USA.

### 5.6.3 TEST PROCEDURE

#### FOR CONDUCTED MEASUREMENT

The transmitter output was connected to the spectrum analyzer via a low loss cable. Set both RBW and VBW of spectrum analyzer to 100kHz and 300kHz with suitable frequency span including 100MHz bandwidth from band edge. The band edges was measured and recorded.

The spectrum plots (Peak RBW = 100kHz, VBW = 300kHz; Average RBW = 1MHz, VBW = 10Hz) are attached on the following pages.

#### FOR RADIATED MEASUREMENT

- a. The EUT was placed on the top of a rotating table 0.8 meters above the ground at a 3 meter semi-anechoic chamber. The table was rotated 360 degrees to determine the position of the highest radiation.
- b. The EUT was set 3 meters away from the interference-receiving antenna, which was mounted on the top of a variable-height antenna tower.
- c. The antenna is a broadband antenna, and its height is varied from one meter to four meters above the ground to determine the maximum value of the field strength. Both horizontal and vertical polarizations of the antenna are set to make the measurement.
- d. For each suspected emission, the EUT was arranged to its worst case and then the antenna was tuned to heights from 1 meter to 4 meters and the rotatable table was turned from 0 degrees to 360 degrees to find the maximum reading.
- e. Set both RBW and VBW of spectrum analyzer to 100kHz and 300kHz with suitable frequency span including 100MHz bandwidth from band edge. The band edges was measured and recorded.

**NOTE:** The resolution bandwidth of test receiver/spectrum analyzer is 1MHz and the video bandwidth is 10Hz for Average detection (AV) at frequency above 1GHz.

### 5.6.4 DEVIATION FROM TEST STANDARD

No deviation

### 5.6.5 EUT OPERATING CONDITION

Same as Item 5.3.6



A D T

## 5.6.6 TEST RESULTS

The spectrum plots are attached on the following pages. D1 line indicates the highest level, D2 line indicates the 20dB offset below D1. It shows compliance with the requirement in part 15.247(d).



A D T

### 802.11a (Antenna A)

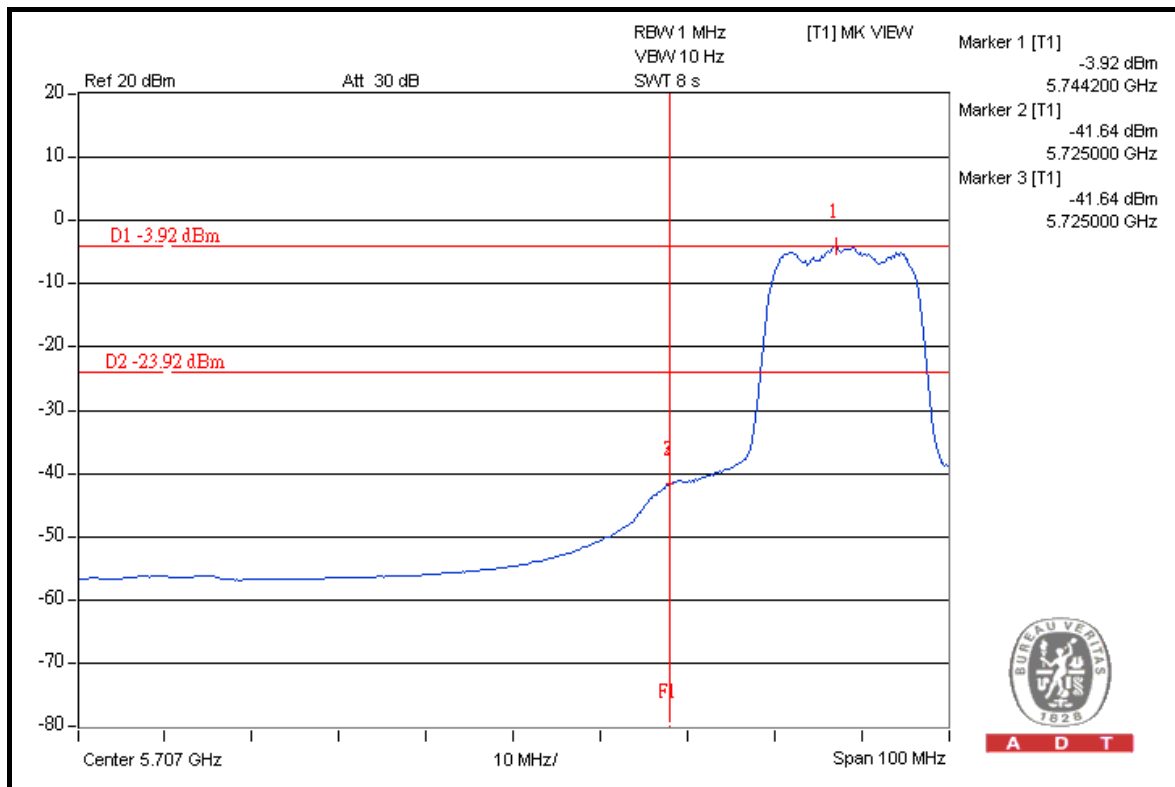
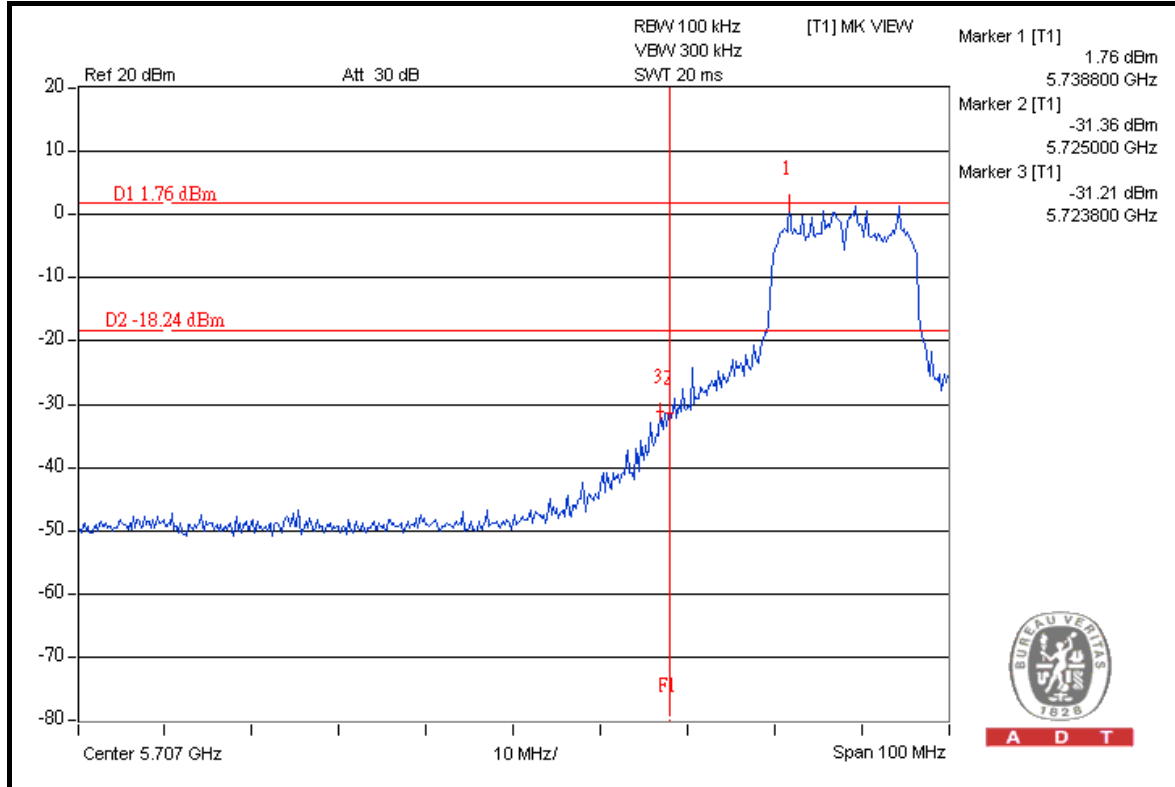



A D T

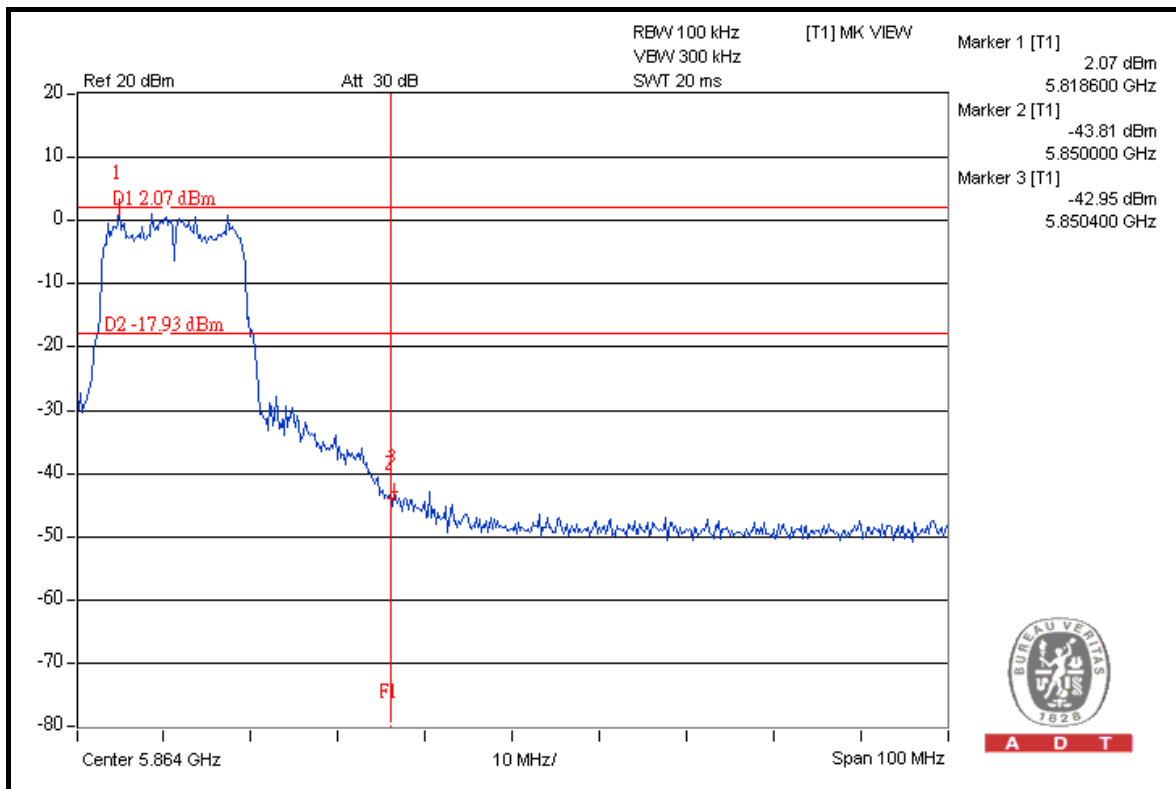
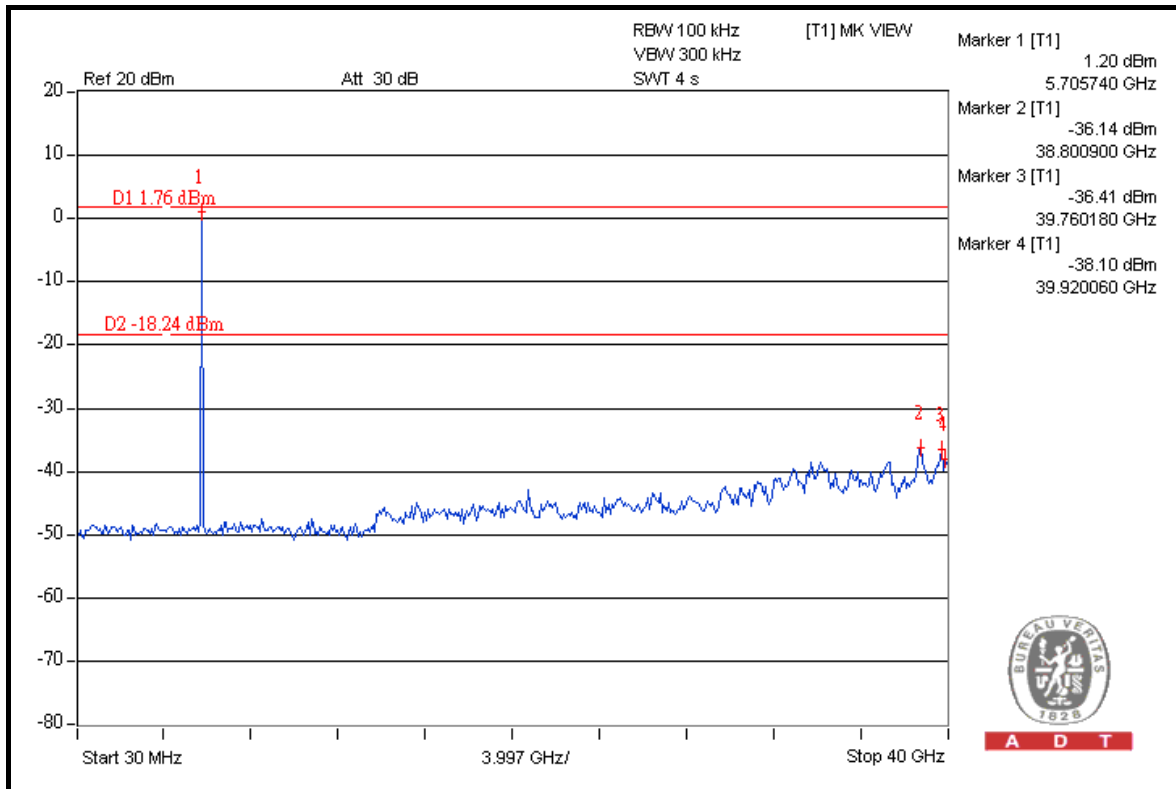



A D T

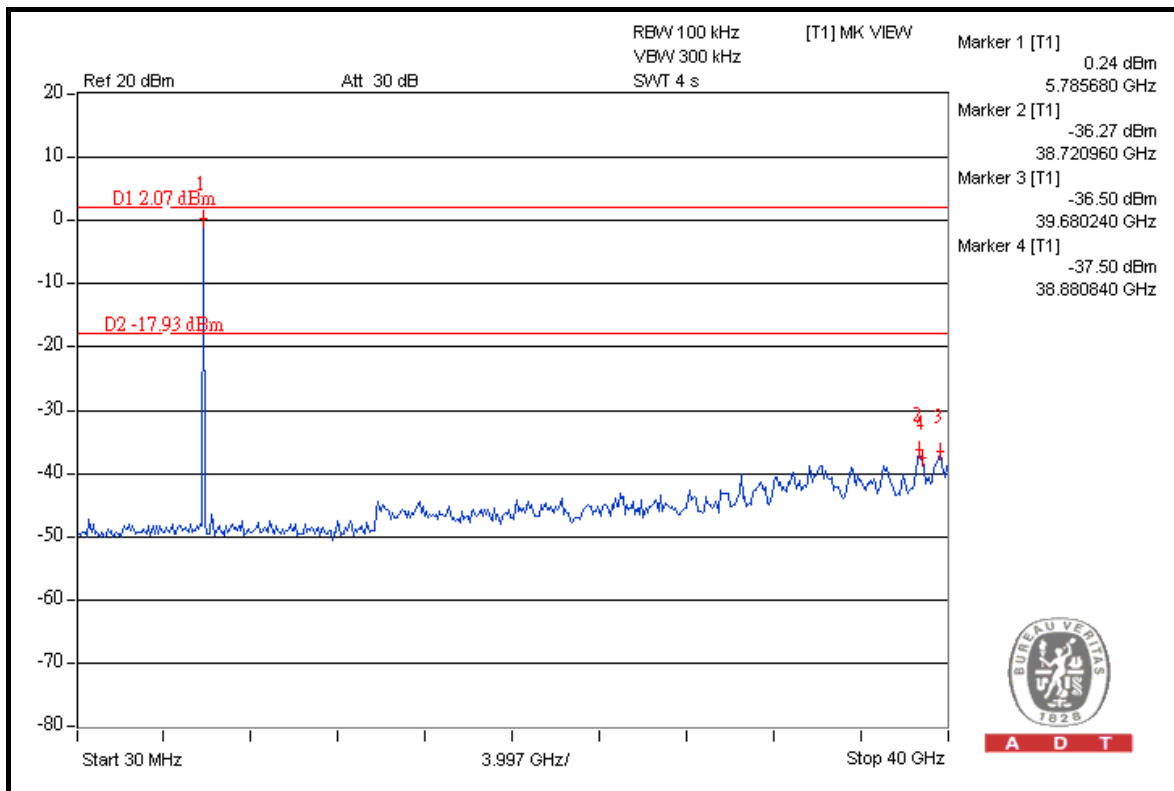
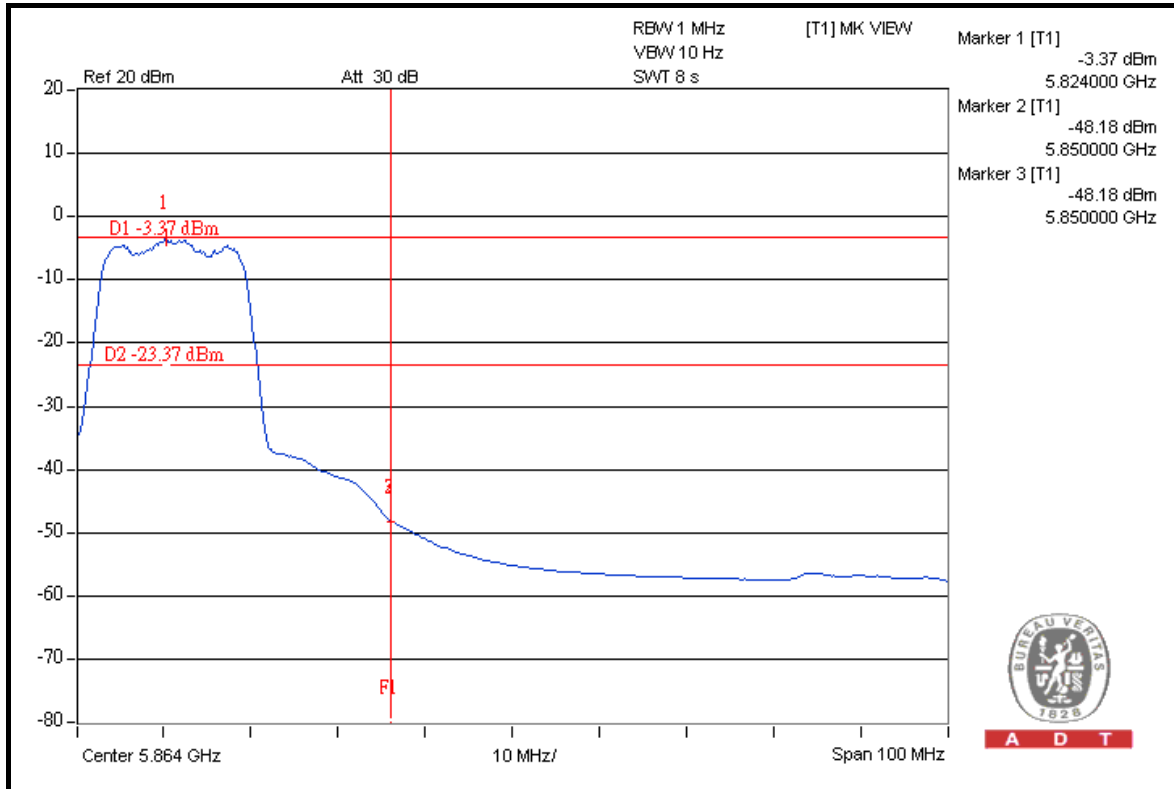





A D T

### 802.11a (Antenna B)

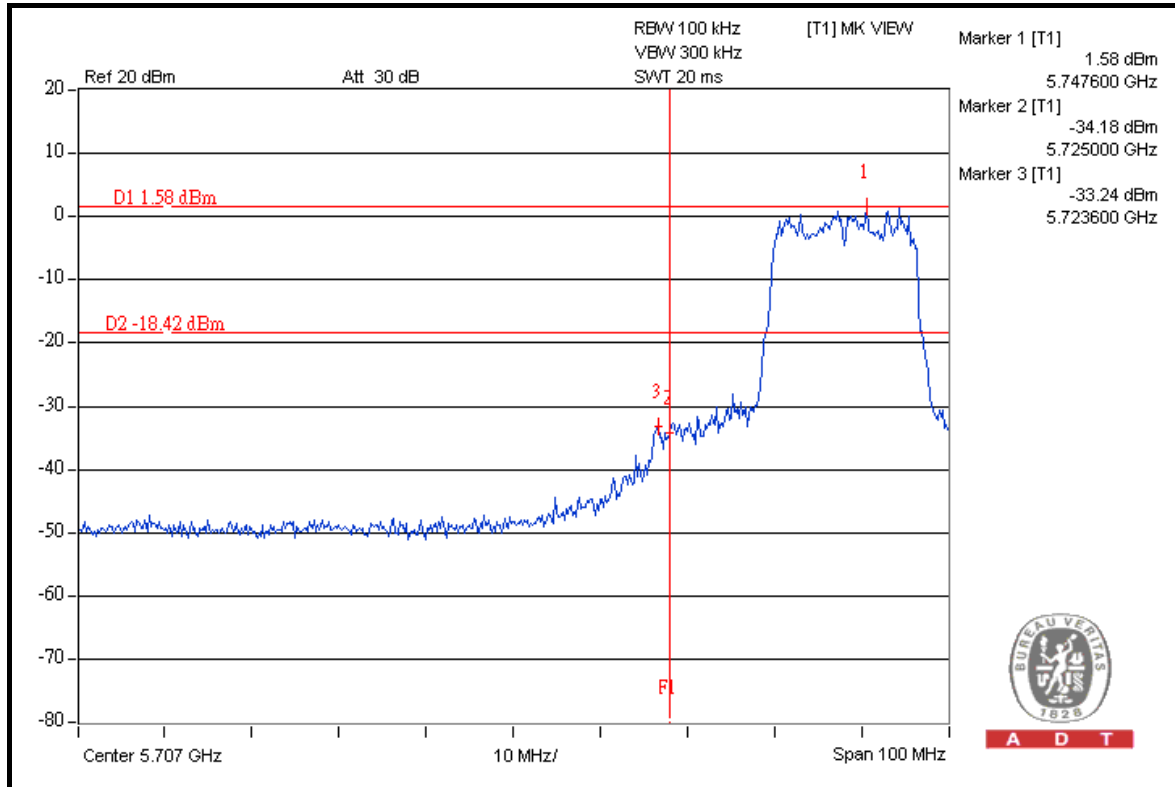

A D T

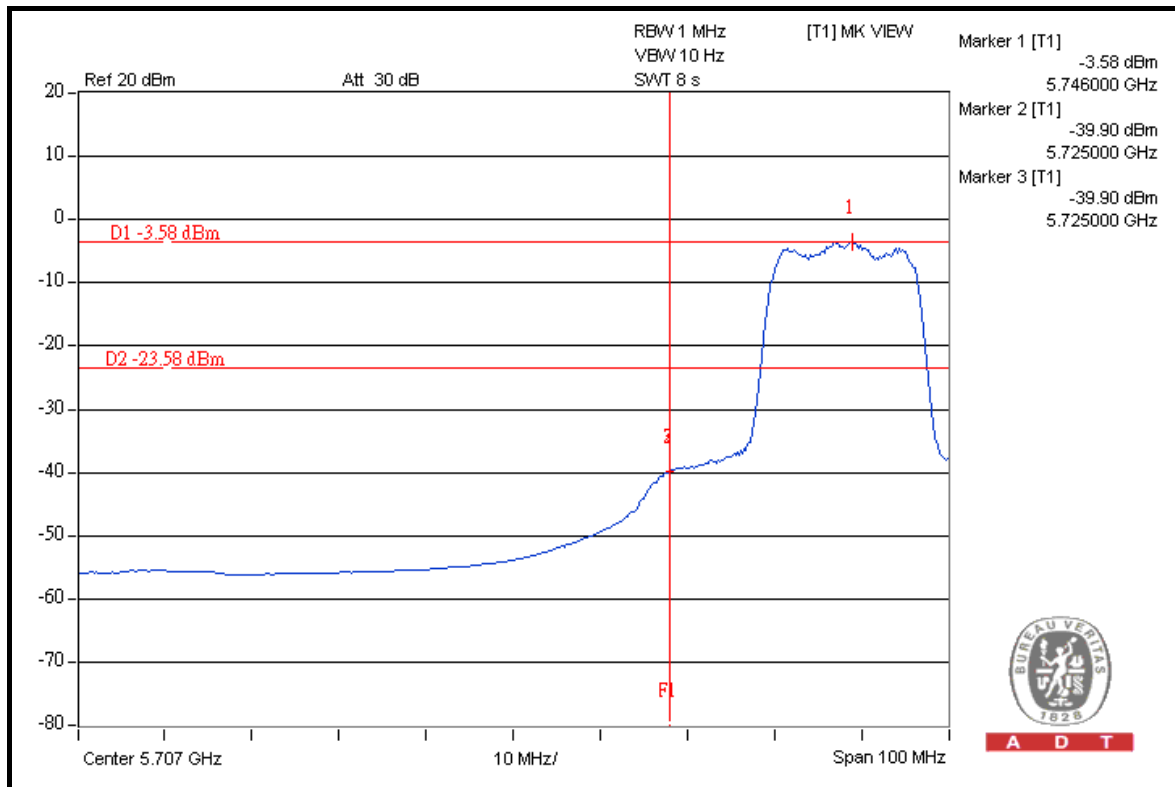

A D T



A D T

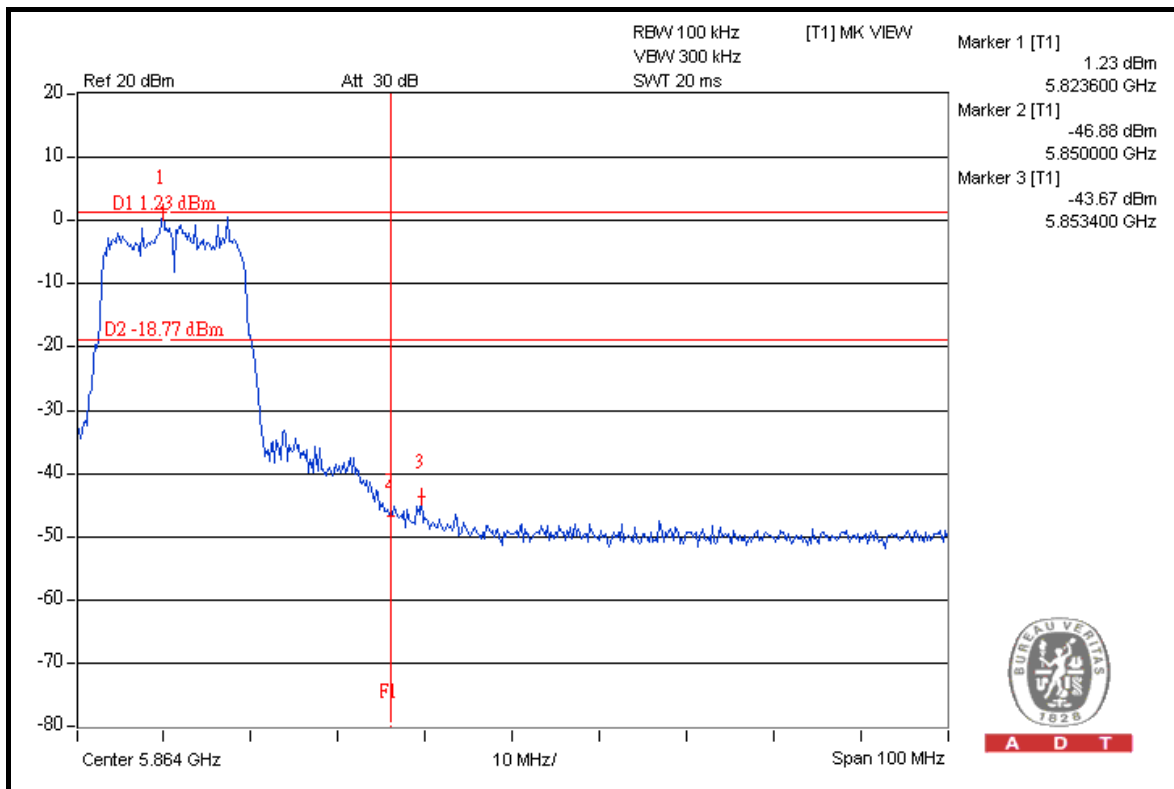
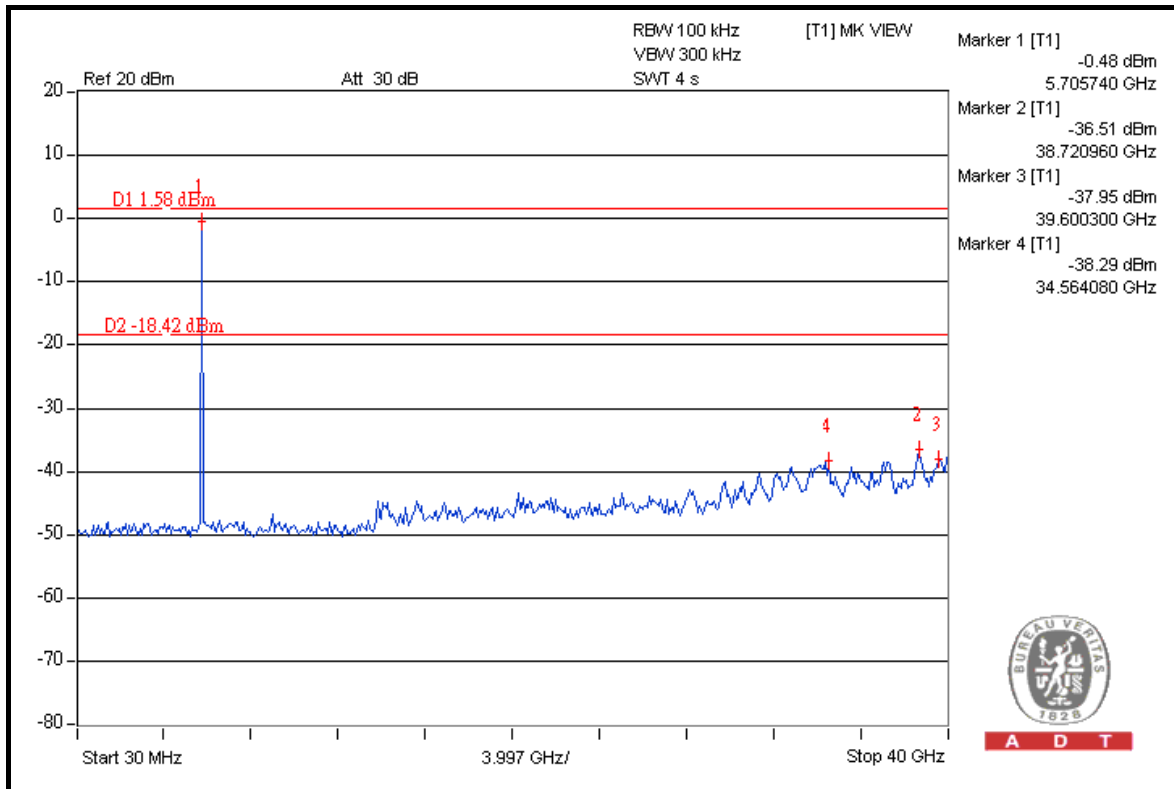



A D T

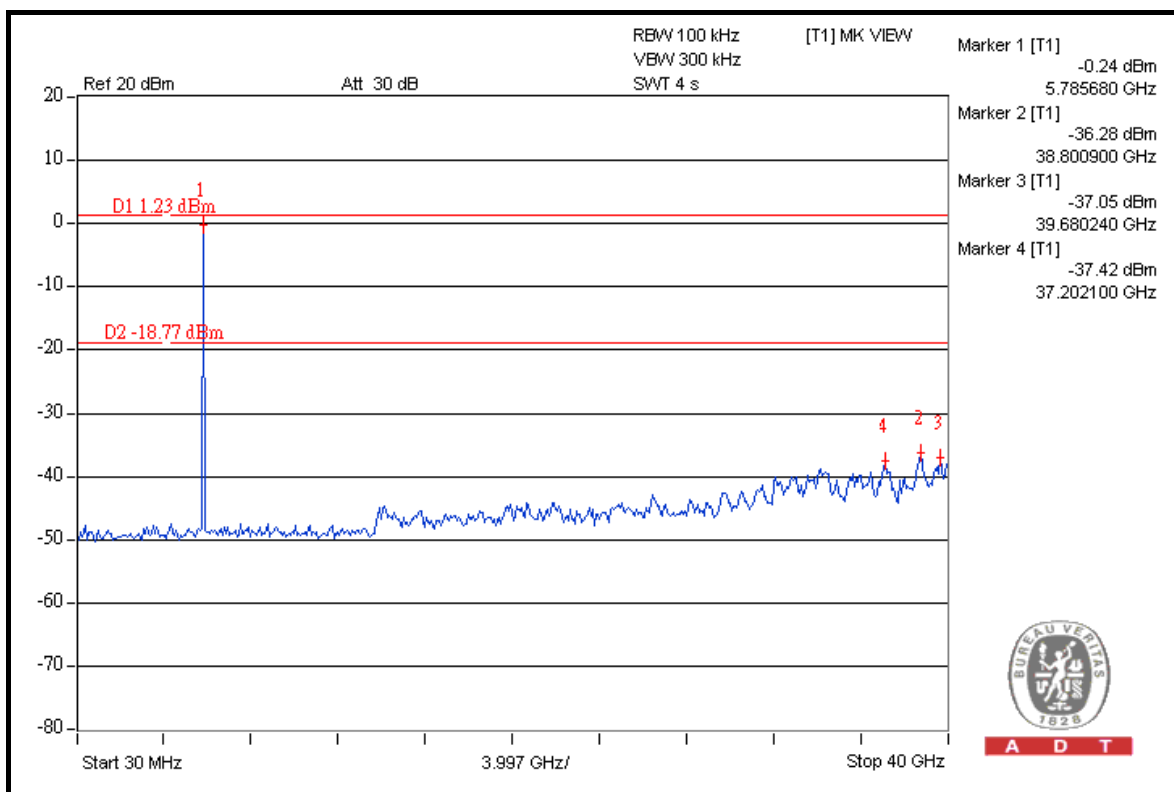
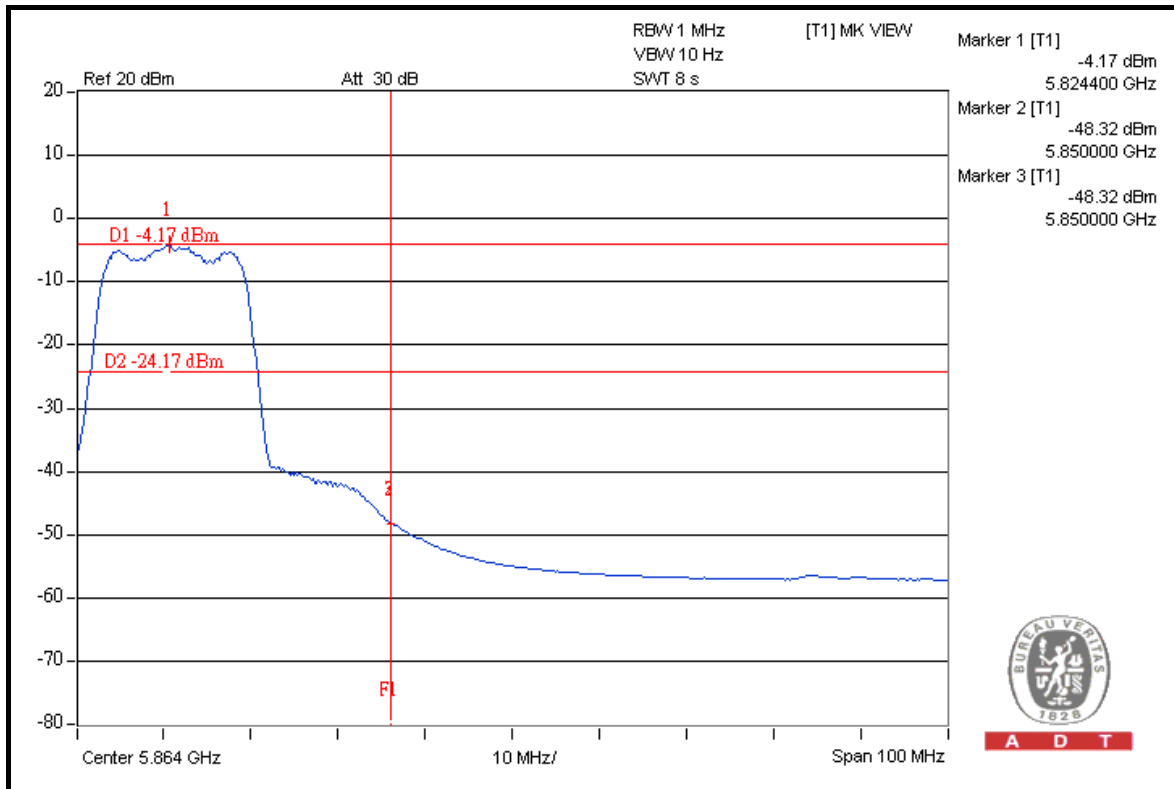



A D T

### 802.11n (20MHz)

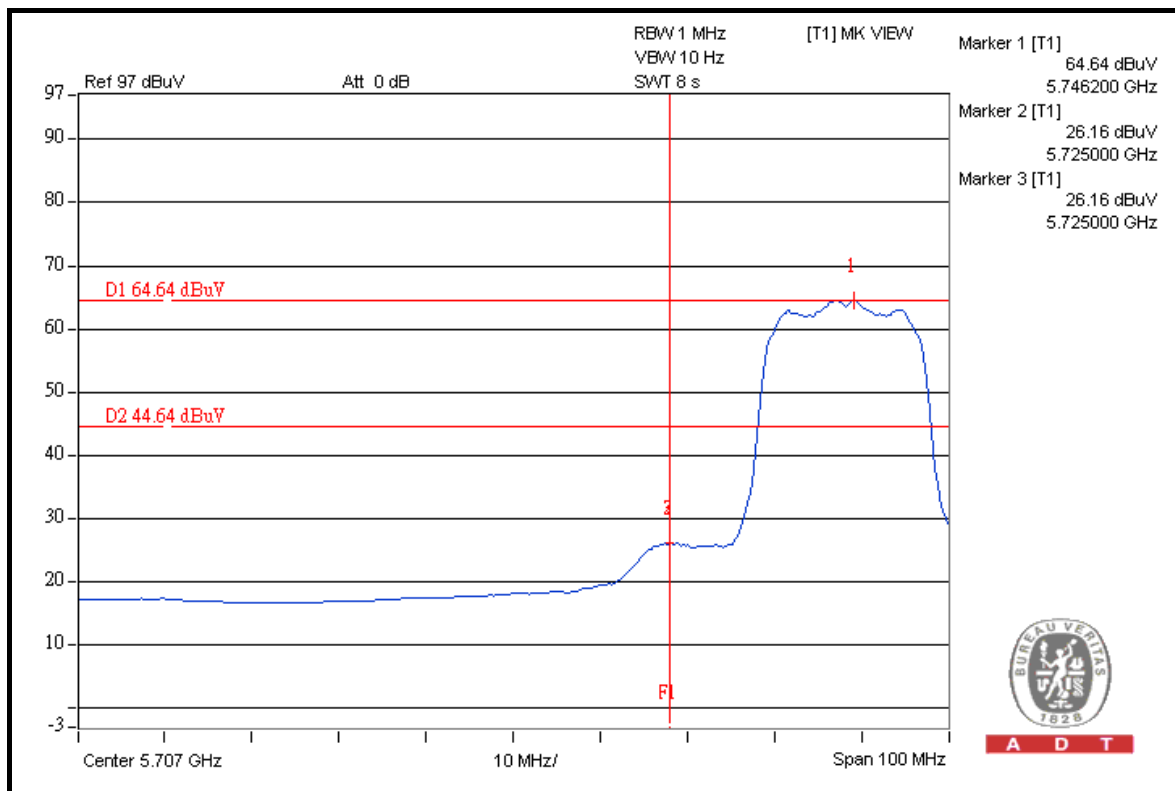
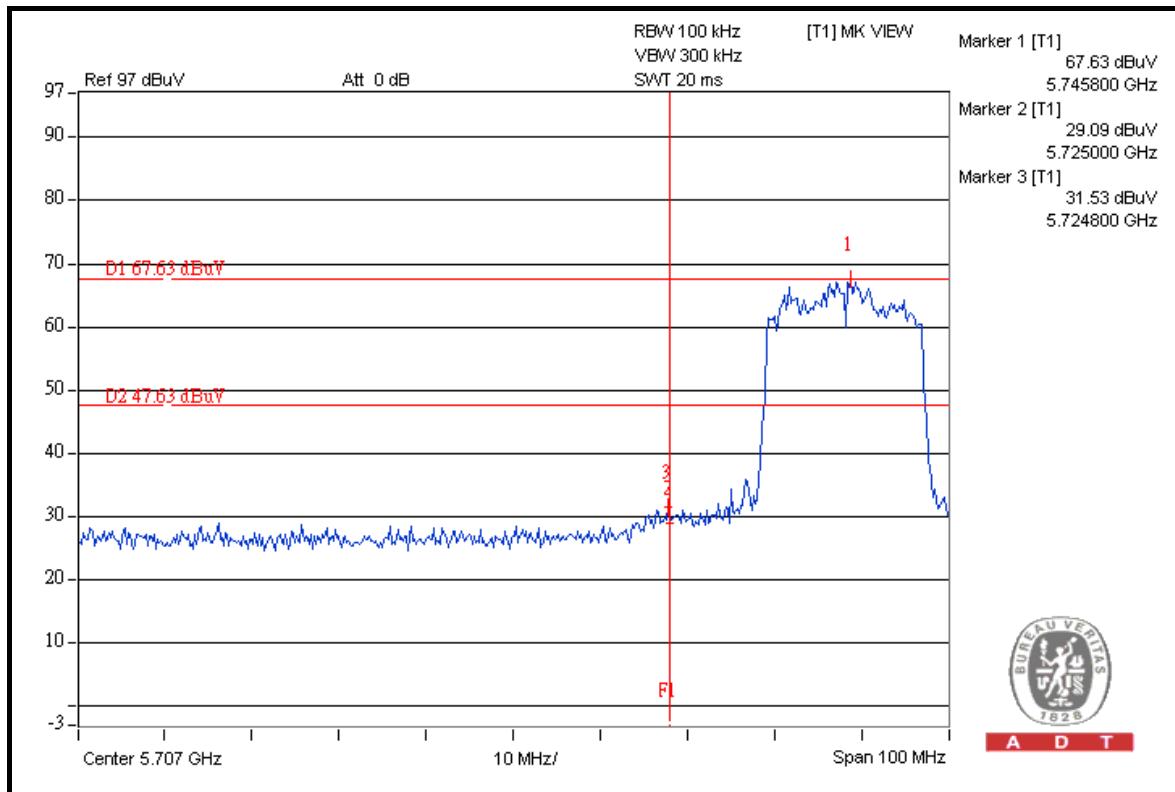



A D T

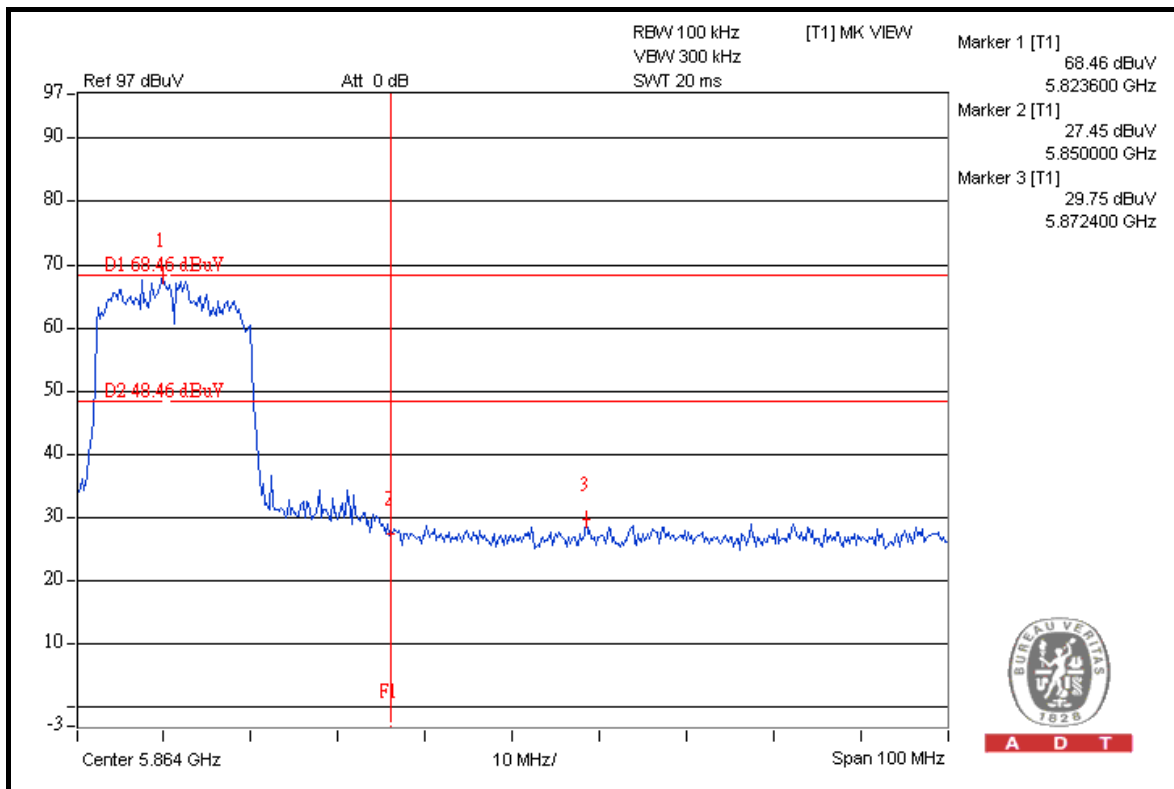
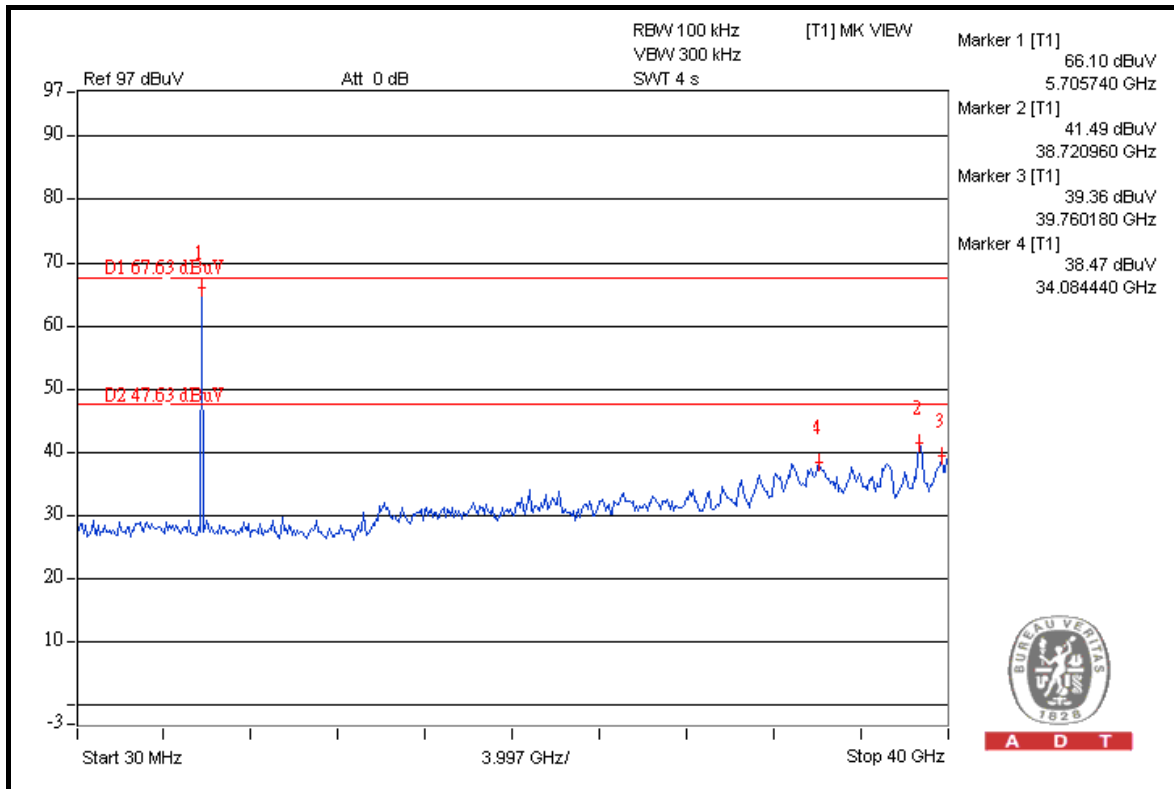



A D T

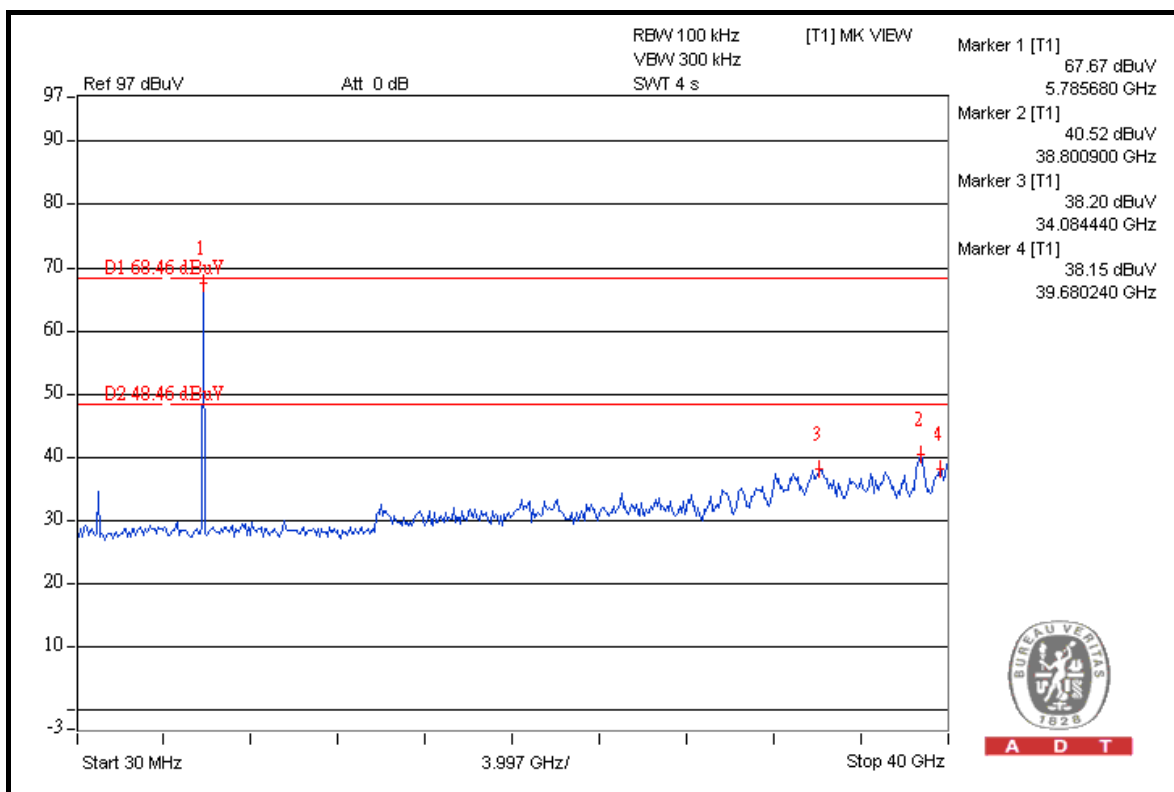
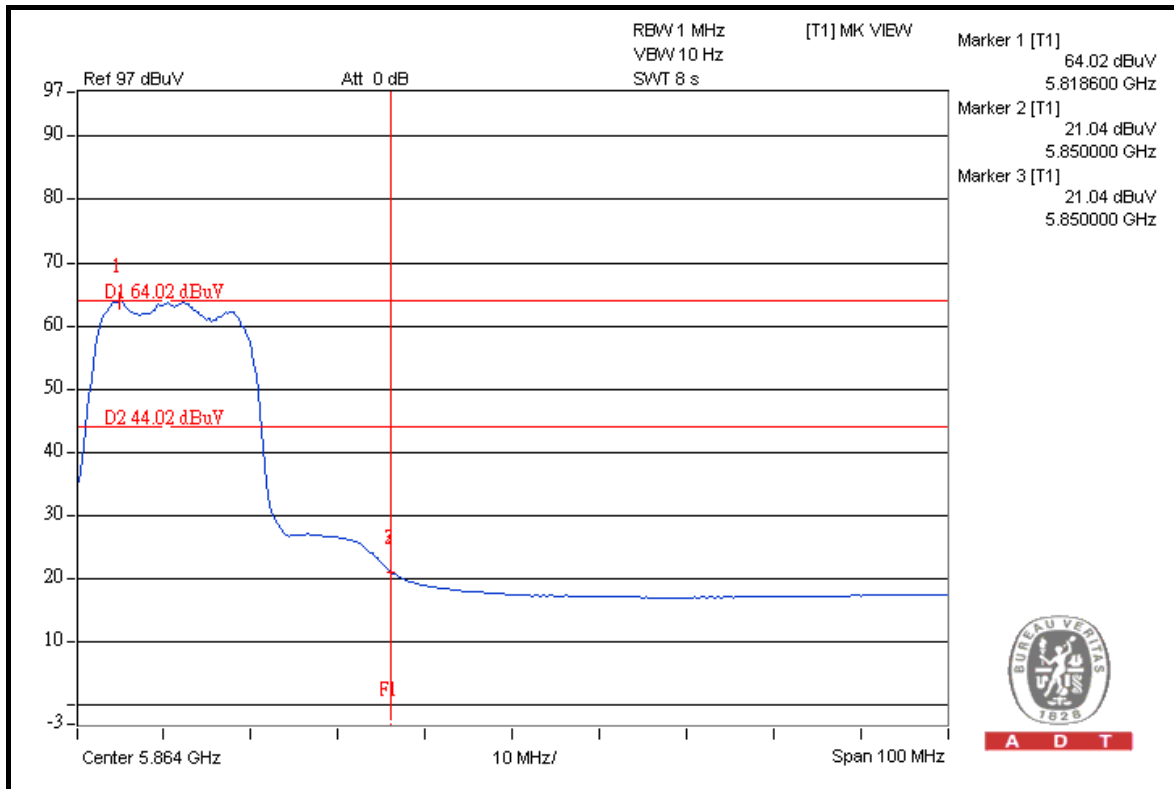



A D T

### 802.11n (40MHz)

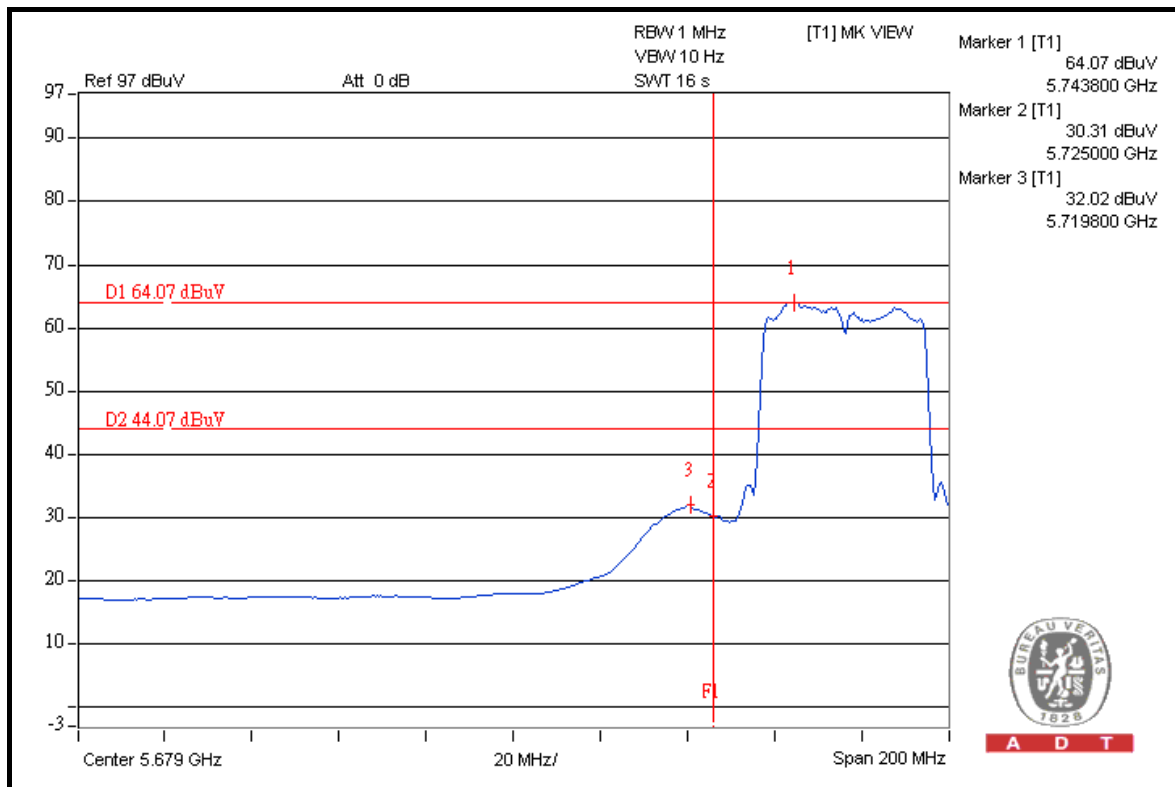
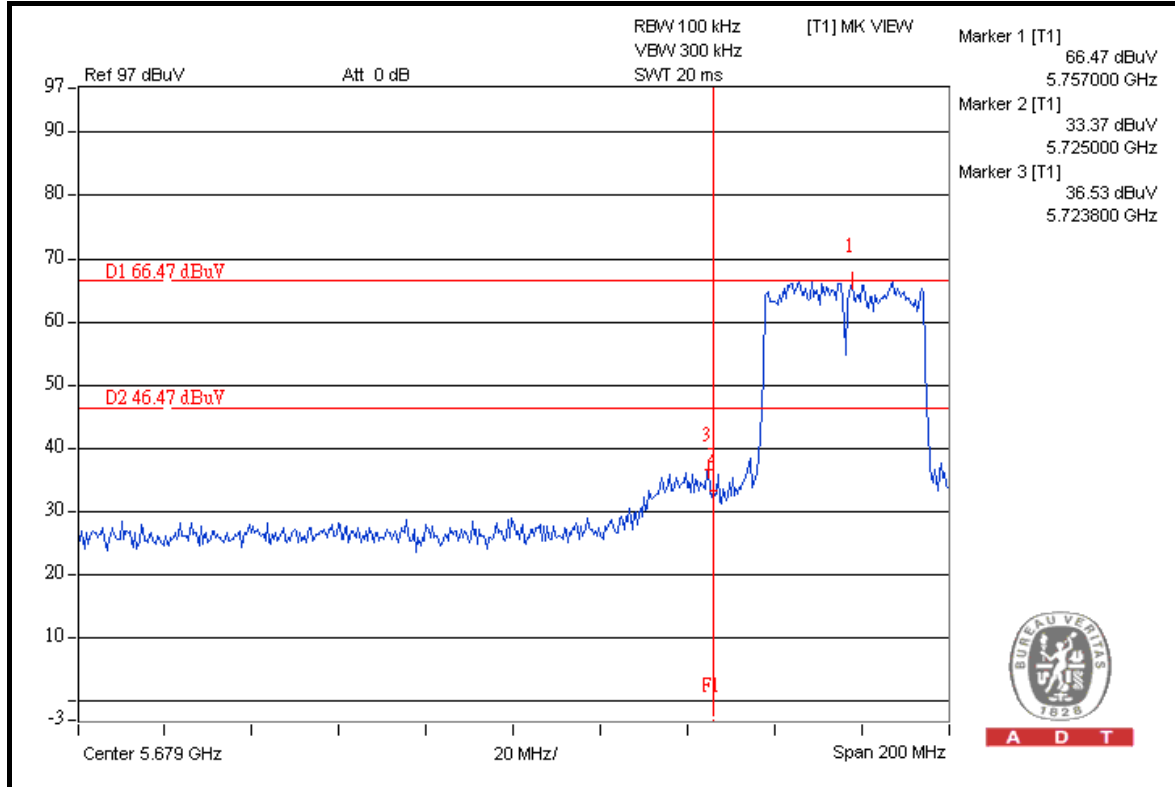



A D T

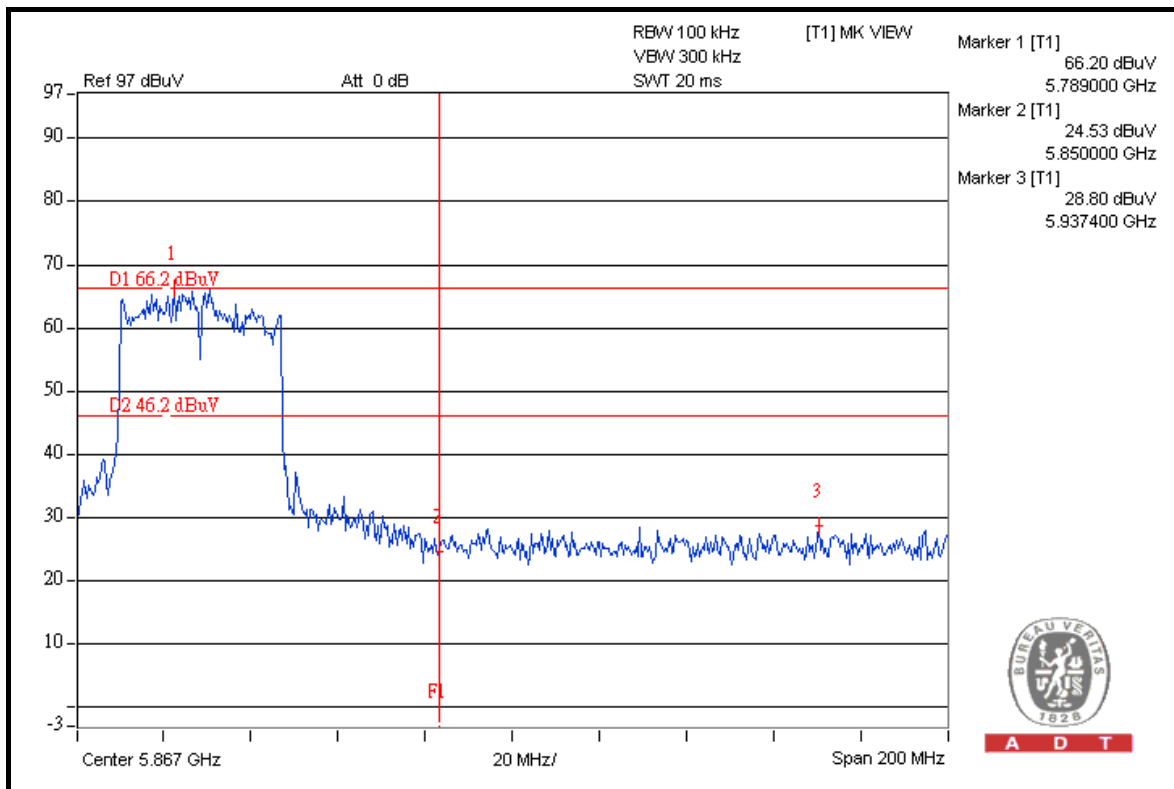
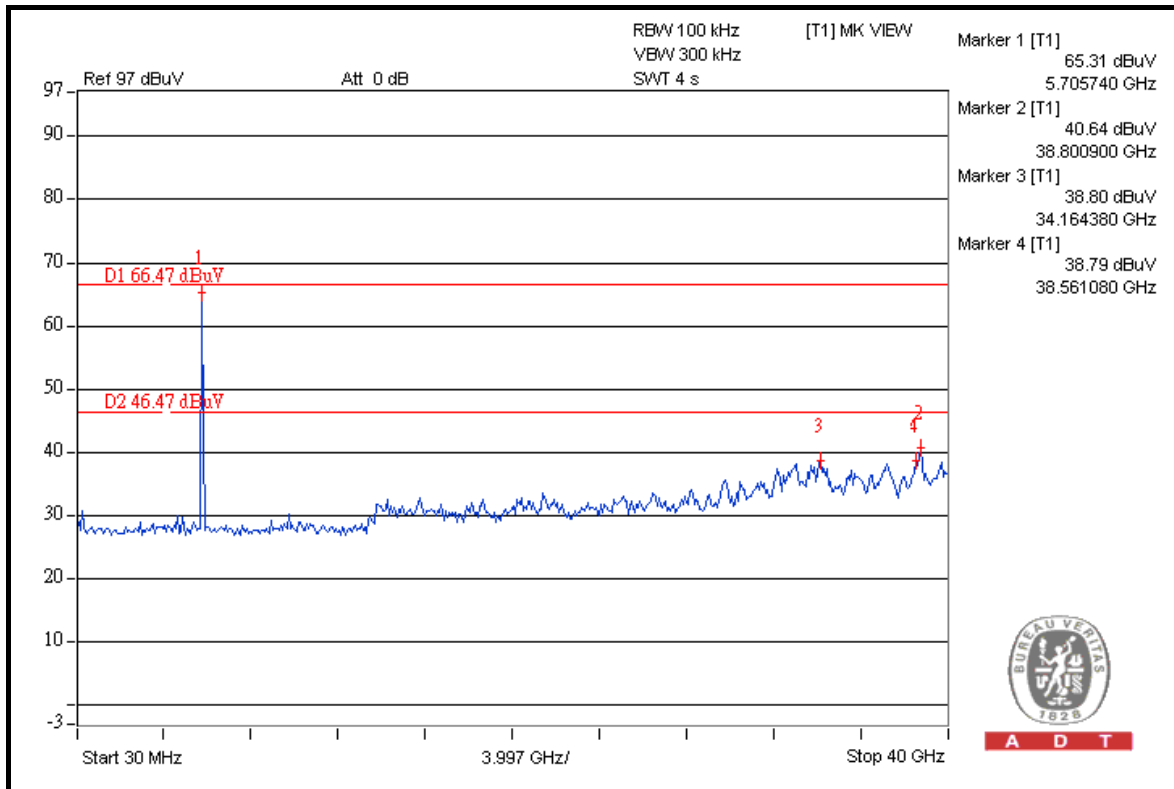





A D T

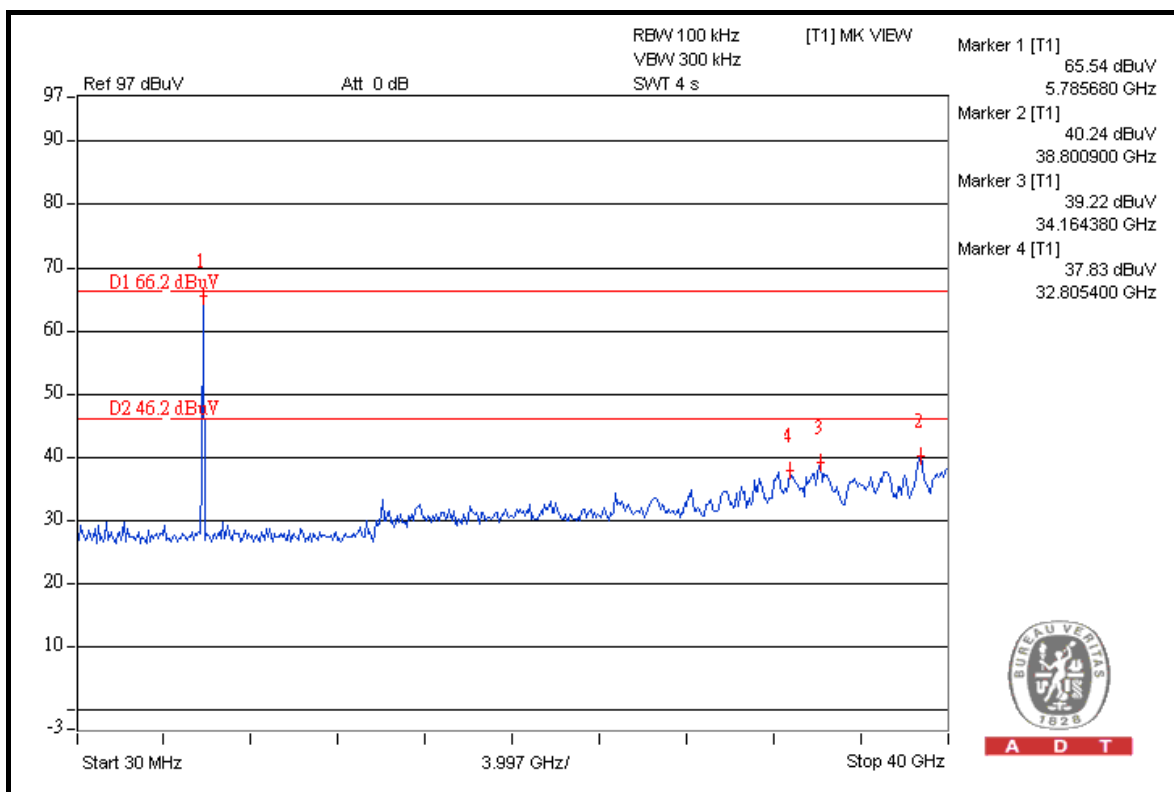
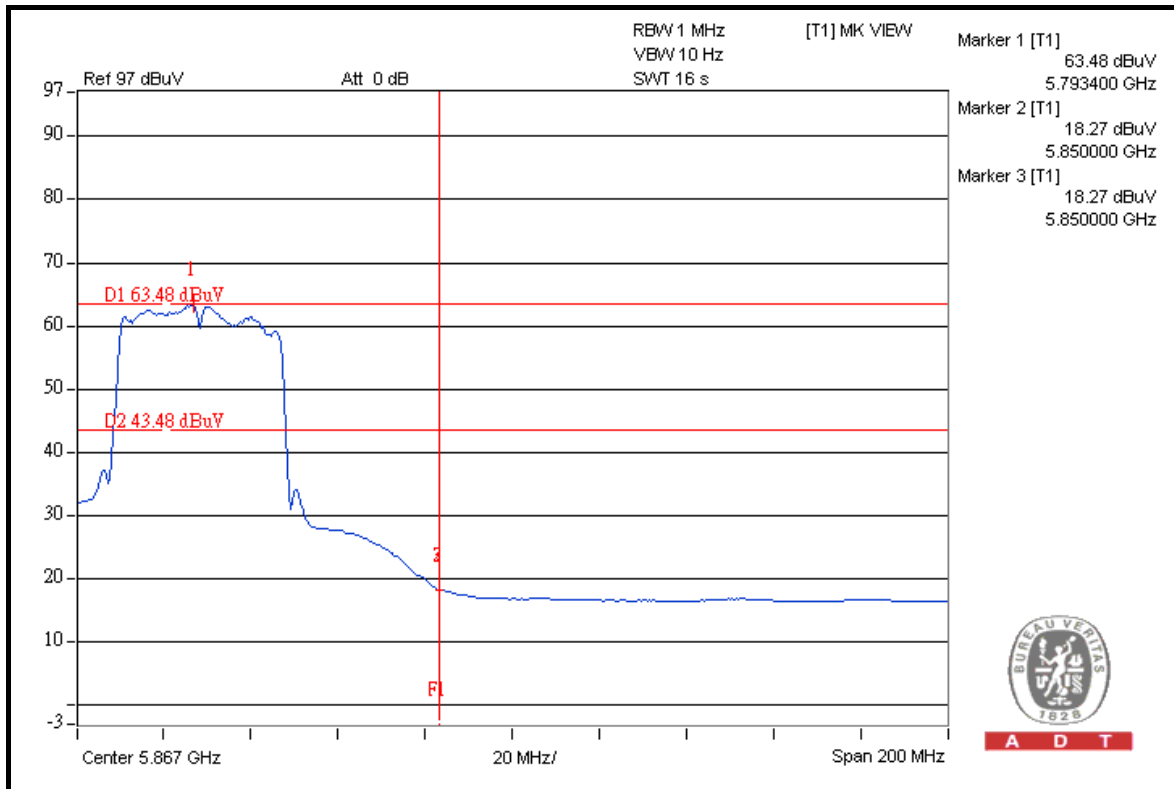



A D T

## 6. PHOTOGRAPHS OF THE TEST CONFIGURATION

Please refer to the attached file (Test Setup Photo).



A D T

## 7. INFORMATION ON THE TESTING LABORATORIES

We, Bureau Veritas Consumer Products Services (H.K.) Ltd., Taoyuan Branch, were founded in 1988 to provide our best service in EMC, Radio, Telecom and Safety consultation. Our laboratories are accredited and approved according to ISO/IEC 17025.

Copies of accreditation certificates of our laboratories obtained from approval agencies can be downloaded from our web site:

[www.adt.com.tw/index.5/phtml](http://www.adt.com.tw/index.5/phtml). If you have any comments, please feel free to contact us at the following:

**Linko EMC/RF Lab:**

Tel: 886-2-26052180

Fax: 886-2-26051924

**Hsin Chu EMC/RF Lab:**

Tel: 886-3-5935343

Fax: 886-3-5935342

**Hwa Ya EMC/RF/Safety Telecom Lab:**

Tel: 886-3-3183232

Fax: 886-3-3185050

**Web Site:** [www.adt.com.tw](http://www.adt.com.tw)

The address and road map of all our labs can be found in our web site also.



A D T

## **8. APPENDIX A - MODIFICATIONS RECORDERS FOR ENGINEERING CHANGES TO THE EUT BY THE LAB**

No any modifications are made to the EUT by the lab during the test.

---END---