

FCC Test Report

Report No.: RF160629E03-1

FCC ID: W59XWR3100

Test Model: XWR-3100

Received Date: June 29,2016

Test Date: July 07 to 19, 2016

Issued Date: Aug. 09, 2016

Applicant: Luxul Wireless

Address: 14203 Minuteman Dr Suite 201 Draper UT 84020 USA

Issued By: Bureau Veritas Consumer Products Services (H.K.) Ltd., Taoyuan Branch
Hsin Chu Laboratory

Lab Address: E-2, No.1, Li Hsin 1st Road, Hsinchu Science Park, Hsinchu City 300,
Taiwan R.O.C.

Test Location (1): E-2, No.1, Li Hsin 1st Road, Hsinchu Science Park, Hsinchu City 300,
Taiwan R.O.C.

Test Location (2): No. 49, Ln. 206, Wende Rd., Shangshan Tsuen, Chiung Lin Hsiang, Hsin
Chu Hsien 307, Taiwan R.O.C.



This report is for your exclusive use. Any copying or replication of this report to or for any other person or entity, or use of our name or trademark, is permitted only with our prior written permission. This report sets forth our findings solely with respect to the test samples identified herein. The results set forth in this report are not indicative or representative of the quality or characteristics of the lot from which a test sample was taken or any similar or identical product unless specifically and expressly noted. Our report includes all of the tests requested by you and the results thereof based upon the information that you provided to us. You have 60 days from date of issuance of this report to notify us of any material error or omission caused by our negligence, provided, however, that such notice shall be in writing and shall specifically address the issue you wish to raise. A failure to raise such issue within the prescribed time shall constitute your unqualified acceptance of the completeness of this report, the tests conducted and the correctness of the report contents. Unless specific mention, the uncertainty of measurement has been explicitly taken into account to declare the compliance or non-compliance to the specification. The report must not be used by the client to claim product certification, approval, or endorsement by TAF or any government agencies.

Table of Contents

Release Control Record	4
1 Certificate of Conformity	5
2 Summary of Test Results	6
2.1 Measurement Uncertainty	6
2.2 Modification Record	6
3 General Information	7
3.1 General Description of EUT	7
3.2 Description of Test Modes	10
3.2.1 Test Mode Applicability and Tested Channel Detail	11
3.3 Duty Cycle of Test Signal	13
3.4 Description of Support Units	14
3.4.1 Configuration of System under Test	15
3.5 General Description of Applied Standard	16
4 Test Types and Results	17
4.1 Radiated Emission and Bandedge Measurement	17
4.1.1 Limits of Radiated Emission and Bandedge Measurement	17
4.1.2 Test Instruments	18
4.1.3 Test Procedure	19
4.1.4 Deviation from Test Standard	19
4.1.5 Test Setup	20
4.1.6 EUT Operating Condition	20
4.1.7 Test Results (Mode 1)	21
4.1.8 Test Results (Mode 2)	40
4.2 Conducted Emission Measurement	59
4.2.1 Limits of Conducted Emission Measurement	59
4.2.2 Test Instruments	59
4.2.3 Test Procedure	60
4.2.4 Deviation from Test Standard	60
4.2.5 Test Setup	60
4.2.6 EUT Operating Condition	60
4.2.7 Test Results (Mode 1)	61
4.2.8 Test Results (Mode 2)	63
4.3 Transmit Power Measurement	65
4.3.1 Limits of Transmit Power Measurement	65
4.3.2 Test Setup	65
4.3.3 Test Instruments	65
4.3.4 Test Procedure	65
4.3.5 Deviation from Test Standard	65
4.3.6 EUT Operating Condition	65
4.3.7 Test Result	66
4.4 Occupied Bandwidth Measurement	68
4.4.1 Test Setup	68
4.4.2 Test Instruments	68
4.4.3 Test Procedure	68
4.5 Peak Power Spectral Density Measurement	72
4.5.1 Limits of Peak Power Spectral Density Measurement	72
4.5.2 Test Setup	72
4.5.3 Test Instruments	72
4.5.4 Test Procedure	73
4.5.5 Deviation from Test Standard	73
4.5.6 EUT Operating Condition	73
4.5.7 Test Results	74
4.6 Frequency Stability Measurement	80

4.6.1	Limits of Frequency Stability Measurement	80
4.6.2	Test Setup.....	80
4.6.3	Test Instruments	80
4.6.4	Test Procedure	80
4.6.5	Deviation from Test Standard	80
4.6.6	EUT Operating Condition	80
4.6.7	Test Results	81
4.7	6dB Bandwidth Measurement	82
4.7.1	Limits of 6dB Bandwidth Measurement.....	82
4.7.2	Test Setup.....	82
4.7.3	Test Instruments	82
4.7.4	Test Procedure	82
4.7.5	Deviation from Test Standard	82
4.7.6	EUT Operating Condition	82
4.7.7	Test Results	83
5	Pictures of Test Arrangements.....	85
	Annex A- Radiated Out of Band Emission (OOBE) Measurement (For U-NII-3 band)	86
	Appendix – Information on the Testing Laboratories	92

Release Control Record

Issue No.	Description	Date Issued
RF160629E03-1	Original release.	Aug. 09, 2016

1 Certificate of Conformity

Product: Dual-Band AC3100 Gigabit Router

Brand: Luxul

Test Model: XWR-3100

Sample Status: ENGINEERING SAMPLE

Applicant: Luxul Wireless

Test Date: July 07 to 19, 2016

Standard: 47 CFR FCC Part 15, Subpart E (Section 15.407)
ANSI C63.10: 2013

The above equipment has been tested by **Bureau Veritas Consumer Products Services (H.K.) Ltd., Taoyuan Branch**, and found compliance with the requirement of the above standards. The test record, data evaluation & Equipment Under Test (EUT) configurations represented herein are true and accurate accounts of the measurements of the sample's EMC characteristics under the conditions specified in this report.

Prepared by : Wendy Wu , **Date:** Aug. 09, 2016
Wendy Wu / Specialist

Approved by : May Chen , **Date:** Aug. 09, 2016
May Chen / Manager

2 Summary of Test Results

47 CFR FCC Part 15, Subpart E (Section 15.407)			
FCC Clause	Test Item	Result	Remarks
15.407(b)(6)	AC Power Conducted Emissions	Pass	Meet the requirement of limit. Minimum passing margin is -5.64dB at 0.35703MHz.
15.407(b) (1/2/3/4(i/ii)/6)	Radiated Emissions & Band Edge Measurement*	Pass	Meet the requirement of limit. Minimum passing margin is -0.10dB at 5150.00MHz.
15.407(a)(1/2/3)	Max Average Transmit Power	Pass	Meet the requirement of limit.
---	Occupied Bandwidth Measurement	Pass	Meet the requirement of limit.
15.407(a)(1/2/3)	Peak Power Spectral Density	Pass	Meet the requirement of limit.
15.407(e)	6dB bandwidth	Pass	Meet the requirement of limit. (U-NII-3 Band only)
15.407(g)	Frequency Stability	Pass	Meet the requirement of limit.
15.203	Antenna Requirement	Pass	Antenna connector is R-SMA not a standard connector.

*For U-NII-3 band compliance with rule part 15.407(b)(4)(i), the OOB test plots were recorded in Annex A.

2.1 Measurement Uncertainty

Where relevant, the following measurement uncertainty levels have been estimated for tests performed on the EUT as specified in CISPR 16-4-2:

Measurement	Frequency	Expanded Uncertainty (k=2) (±)
Conducted Emissions at mains ports	150kHz ~ 30MHz	1.83 dB
Radiated Emissions up to 1 GHz	30MHz ~ 1GHz	5.19 dB
	1GHz ~ 6GHz	3.43 dB
Radiated Emissions above 1 GHz	6GHz ~ 18GHz	3.49 dB
	18GHz ~ 40GHz	4.11 dB

2.2 Modification Record

There were no modifications required for compliance.

3 General Information

3.1 General Description of EUT

Product	Dual-Band AC3100 Gigabit Router
Brand	Luxul
Test Model	XWR-3100
Status of EUT	ENGINEERING SAMPLE
Power Supply Rating	DC 12V from adapter
Modulation Type	CCK, DQPSK, DBPSK for DSSS 64QAM, 16QAM, QPSK, BPSK for OFDM 256QAM for OFDM in 11ac mode only.
Modulation Technology	DSSS, OFDM
Transfer Rate	802.11b: up to 11Mbps 802.11a/g: up to 54Mbps 802.11n: up to 600Mbps 802.11ac: up to 1733.3Mbps
Operating Frequency	2.4GHz: 2.412 ~ 2.462GHz 5GHz: 5.18 ~ 5.24GHz and 5.745 ~ 5.825GHz
Number of Channel	2.4GHz: 802.11b, 802.11g, 802.11n (HT20): 11 802.11n (HT40): 7 5GHz: 802.11a, 802.11n (HT20), 802.11ac (VHT20): 9 802.11n (HT40), 802.11ac (VHT40): 4 802.11ac (VHT80): 2
Output Power	2.4GHz: CDD Mode: 920.645mW Beamforming Mode: 400.875mW 5GHz: 5.18GHz ~ 5.24GHz: CDD Mode: 851.538mW Beamforming Mode: 429.856mW 5.745GHz ~ 5.825GHz: CDD Mode: 984.837mW Beamforming Mode: 576.38mW
Antenna Type	Refer to Note
Antenna Connector	Refer to Note
Accessory Device	Adapter x 1
Data Cable Supplied	RJ45 cable x 1 (Unshielded, 31cm)

Note:

1. The EUT must be supplied from power adapter and following different models could be chosen as following table:

No.	Brand	Model No.	Spec.
1	LEI	MU42-3120300-A1	Input: 100-240Vac, 1.5A, 50-60Hz Output: 12V, 3.0A DC output cable: Unshielded 1.2m
2	CWT	2ABN036F US	Input: 100-240Vac, 1.0A, 50-60Hz Output: 12V, 3.0A DC output cable: Unshielded 1.2m

2. 2.4GHz and 5GHz technology can not transmit at same time.

3. The antennas provided to the EUT, please refer to the following table:

Antenna No	Brand	Model	Antenna Net Gain (dBi)	Frequency range (MHz ~ MHz)	Antenna Type	Connecter Type	Cable Length	Cable Loss
1	NA	290-20268	3.88	2.4~2.4835	Dipole	R-SMA	200mm	0.53
			3.62	5.15~5.25				0.83
			2.9	5.25~5.35				0.83
			2.34	5.47~5.850				0.83
2	NA	290-20268	3.88	2.4~2.4835	Dipole	R-SMA	200mm	0.53
			3.62	5.15~5.25				0.83
			2.9	5.25~5.35				0.83
			2.34	5.47~5.850				0.83
3	NA	290-20268	3.88	2.4~2.4835	Dipole	R-SMA	200mm	0.53
			3.62	5.15~5.25				0.83
			2.9	5.25~5.35				0.83
			2.34	5.47~5.850				0.83
4	NA	290-20268	3.88	2.4~2.4835	Dipole	R-SMA	200mm	0.53
			3.62	5.15~5.25				0.83
			2.9	5.25~5.35				0.83
			2.34	5.47~5.850				0.83

4. The EUT incorporates a MIMO function.

2.4GHz Band			
MODULATION MODE	DATA RATE (MCS)	TX & RX CONFIGURATION	
802.11b	1 ~ 11Mbps	4TX	4RX
802.11g	6 ~ 54Mbps	4TX	4RX
802.11n (HT20)	MCS 0~7	4TX	4RX
	MCS 8~15	4TX	4RX
	MCS 16~23	4TX	4RX
	MCS 24~31	4TX	4RX
802.11n (HT40)	MCS 0~7	4TX	4RX
	MCS 8~15	4TX	4RX
	MCS 16~23	4TX	4RX
	MCS 24~31	4TX	4RX
5GHz Band			
MODULATION MODE	DATA RATE (MCS)	TX & RX CONFIGURATION	
802.11a	6 ~ 54Mbps	4TX	4RX
802.11n (HT20)	MCS 0~7	4TX	4RX
	MCS 8~15	4TX	4RX
	MCS 16~23	4TX	4RX
	MCS 24~31	4TX	4RX
802.11n (HT40)	MCS 0~7	4TX	4RX
	MCS 8~15	4TX	4RX
	MCS 16~23	4TX	4RX
	MCS 24~31	4TX	4RX
802.11ac (VHT20)	MCS 0~8, NSS=1	4TX	4RX
	MCS 0~8, NSS=2	4TX	4RX
	MCS 0~9, NSS=3	4TX	4RX
	MCS 0~8, NSS=4	4TX	4RX
802.11ac (VHT40)	MCS 0~9, NSS=1	4TX	4RX
	MCS 0~9, NSS=2	4TX	4RX
	MCS 0~9, NSS=3	4TX	4RX
	MCS 0~9, NSS=4	4TX	4RX
802.11ac (VHT80)	MCS 0~9, NSS=1	4TX	4RX
	MCS 0~9, NSS=2	4TX	4RX
	MCS 0~9, NSS=3	4TX	4RX
	MCS 0~9, NSS=4	4TX	4RX

Note:

1. The modulation and bandwidth are similar for 802.11n mode for 20MHz (40MHz) and 802.11ac mode for 20MHz (40MHz), therefore investigated worst case to representative mode in test report. (Final test mode refer section 3.2.1)

2. All of modulation mode support beamforming function except 802.11a/b/g modulation mode.

5. The above EUT information is declared by manufacturer and for more detailed features description, please refer to the manufacturer's specifications or user's manual.

3.2 Description of Test Modes

FOR 5180 ~ 5240MHz

4 channels are provided for 802.11a, 802.11n (HT20), 802.11ac (VHT20):

Channel	Frequency	Channel	Frequency
36	5180 MHz	44	5220 MHz
40	5200 MHz	48	5240 MHz

2 channels are provided for 802.11n (HT40), 802.11ac (VHT40):

Channel	Frequency	Channel	Frequency
38	5190 MHz	46	5230 MHz

1 channel is provided for 802.11ac (VHT80):

Channel	Frequency
42	5210MHz

FOR 5745 ~ 5825MHz:

5 channels are provided for 802.11a, 802.11n (HT20), 802.11ac (VHT20):

Channel	Frequency	Channel	Frequency
149	5745MHz	161	5805MHz
153	5765MHz	165	5825MHz
157	5785MHz		

2 channels are provided for 802.11n (HT40), 802.11ac (VHT40):

Channel	Frequency	Channel	Frequency
151	5755MHz	159	5795MHz

1 channel is provided for 802.11ac (VHT80):

Channel	Frequency
155	5775MHz

3.2.1 Test Mode Applicability and Tested Channel Detail

EUT Configure Mode	Applicable To				Description
	RE \geq 1G	RE<1G	PLC	APCM	
A	√	√	√	√	Power from adapter 1
B	-	√	√	-	Power from adapter 2

Where **RE \geq 1G**: Radiated Emission above 1GHz **RE<1G**: Radiated Emission below 1GHz
PLC: Power Line Conducted Emission **APCM**: Antenna Port Conducted Measurement

NOTE:

- The EUT had been pre-tested on the positioned of each 3 axis. The worst case was found when positioned on **Y-plane** (Above 1GHz) & **X-plane** (Below 1GHz).
- "-" means no effect.

Radiated Emission Test (Above 1GHz):

- Pre-Scan has been conducted to determine the worst-case mode from all possible combinations between available modulations, data rates and antenna ports (if EUT with antenna diversity architecture).
- Following channel(s) was (were) selected for the final test as listed below.

CDD Mode						
Mode	FREQ. Band (MHz)	Available Channel	Tested Channel	Modulation Technology	Modulation Type	Data Rate (Mbps)
802.11a	5180-5240	36 to 48	36, 40, 48	OFDM	BPSK	6
802.11ac (VHT20)		36 to 48	36, 40, 48	OFDM	BPSK	6.5
802.11ac (VHT40)		38 to 46	38, 46	OFDM	BPSK	13.5
802.11ac (VHT80)		42	42	OFDM	BPSK	29.3
802.11a	5745-5825	149 to 165	149, 157, 165	OFDM	BPSK	6
802.11ac (VHT20)		149 to 165	149, 157, 165	OFDM	BPSK	6.5
802.11ac (VHT40)		151 to 159	151, 159	OFDM	BPSK	13.5
802.11ac (VHT80)		155	155	OFDM	BPSK	29.3

Radiated Emission Test (Below 1GHz):

- Pre-Scan has been conducted to determine the worst-case mode from all possible combinations between available modulations, data rates and antenna ports (if EUT with antenna diversity architecture).
- Following channel(s) was (were) selected for the final test as listed below.

CDD Mode						
Mode	FREQ. Band (MHz)	Available Channel	Tested Channel	Modulation Technology	Modulation Type	Data Rate (Mbps)
802.11ac (VHT40)	5745-5825	151 to 159	159	OFDM	BPSK	13.5

Power Line Conducted Emission Test:

- Pre-Scan has been conducted to determine the worst-case mode from all possible combinations between available modulations, data rates and antenna ports (if EUT with antenna diversity architecture).
- Following channel(s) was (were) selected for the final test as listed below.

CDD Mode						
Mode	FREQ. Band (MHz)	Available Channel	Tested Channel	Modulation Technology	Modulation Type	Data Rate (Mbps)
802.11ac (VHT40)	5745-5825	151 to 159	159	OFDM	BPSK	13.5

Antenna Port Conducted Measurement:

- This item includes all test value of each mode, but only includes spectrum plot of worst value of each mode.
- Pre-Scan has been conducted to determine the worst-case mode from all possible combinations between available modulations, data rates and antenna ports (if EUT with antenna diversity architecture).
- Following channel(s) was (were) selected for the final test as listed below.

CDD Mode						
Mode	FREQ. Band (MHz)	Available Channel	Tested Channel	Modulation Technology	Modulation Type	Data Rate (Mbps)
802.11a	5180-5240	36 to 48	36, 40, 48	OFDM	BPSK	6
802.11ac (VHT20)		36 to 48	36, 40, 48	OFDM	BPSK	6.5
802.11ac (VHT40)		38 to 46	38, 46	OFDM	BPSK	13.5
802.11ac (VHT80)		42	42	OFDM	BPSK	29.3
802.11a	5745-5825	149 to 165	149, 157, 165	OFDM	BPSK	6
802.11ac (VHT20)		149 to 165	149, 157, 165	OFDM	BPSK	6.5
802.11ac (VHT40)		151 to 159	151, 159	OFDM	BPSK	13.5
802.11ac (VHT80)		155	155	OFDM	BPSK	29.3
Beamforming Mode (Output power only)						
Mode	FREQ. Band (MHz)	Available Channel	Tested Channel	Modulation Technology	Modulation Type	Data Rate (Mbps)
802.11ac (VHT20)	5180-5240	36 to 48	36, 40, 48	OFDM	BPSK	6.5
802.11ac (VHT40)		38 to 46	38, 46	OFDM	BPSK	13.5
802.11ac (VHT80)		42	42	OFDM	BPSK	29.3
802.11ac (VHT20)	5745-5825	149 to 165	149, 157, 165	OFDM	BPSK	6.5
802.11ac (VHT40)		151 to 159	151, 159	OFDM	BPSK	13.5
802.11ac (VHT80)		155	155	OFDM	BPSK	29.3

Test Condition:

APPLICABLE TO	ENVIRONMENTAL CONDITIONS	INPUT POWER	TESTED BY
RE \geq 1G	22deg. C, 67%RH	120Vac, 60Hz	Russell Yeh
RE $<$ 1G	23deg. C, 65%RH	120Vac, 60Hz	Robert Teng
PLC	24deg. C, 61%RH	120Vac, 60Hz	Jyunchun Lin
APCM	25deg. C, 60%RH	120Vac, 60Hz	Gary Teng

3.3 Duty Cycle of Test Signal

If duty cycle of test signal is $\geq 98\%$, duty factor is not required.

If duty cycle of test signal is $< 98\%$, duty factor shall be considered.

802.11a: Duty cycle = $2.062 \text{ ms} / 2.084 \text{ ms} = 0.989$

802.11ac (VHT20): Duty cycle = $1.926 \text{ ms} / 1.947 \text{ ms} = 0.989$

802.11ac (VHT40): Duty cycle = $0.953 \text{ ms} / 0.97 \text{ ms} = 0.982$

802.11ac (VHT80): Duty cycle = $0.459 \text{ ms} / 0.478 \text{ ms} = 0.96$, Duty factor = $10 * \log(1/0.96) = 0.18$

802.11a

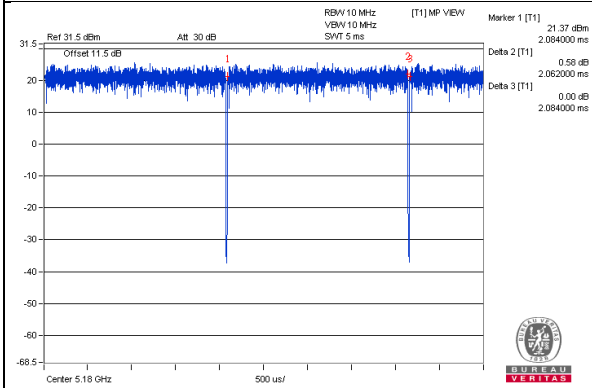

802.11ac (VHT20)

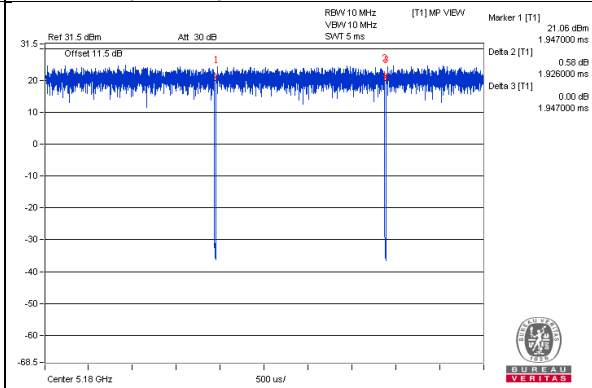

802.11ac (VHT40)

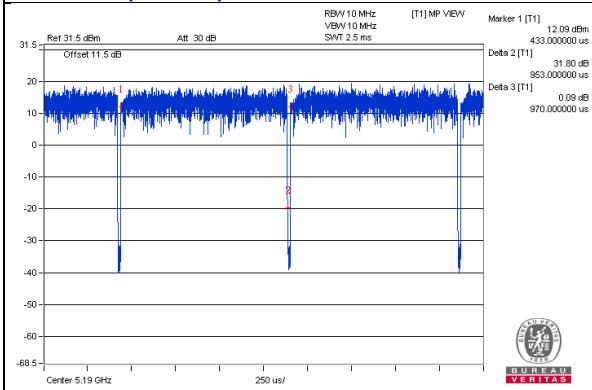

802.11ac (VHT80)

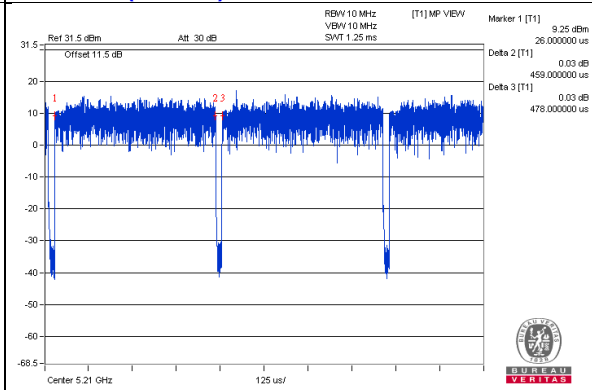

3.4 Description of Support Units

The EUT has been tested as an independent unit together with other necessary accessories or support units. The following support units or accessories were used to form a representative test configuration during the tests.

ID	Product	Brand	Model No.	Serial No.	FCC ID	Remarks
A.	Notebook Computer	DELL	E5430	4YV4VY1	FCC DoC	Provided by Lab
B.	Notebook Computer	DELL	E5430	HYV4VY1	FCC DoC	Provided by Lab
C.	HUB	ZyXEL	ES-116P	S060H02000215	FCC DoC	Provided by Lab
D.	USB 3.0 Dongle	Transcend	NA	NA	NA	Provided by Lab

Note:

1. All power cords of the above support units are non-shielded (1.8m).

ID	Descriptions	Qty.	Length (m)	Shielding (Yes/No)	Cores (Qty.)	Remarks
1.	RJ-45 Cable	1	10	No	0	Provided by Lab
2.	RJ-45 Cable	1	10	No	0	Provided by Lab
3.	RJ-45 Cable	3	10	No	0	Provided by Lab
4.	DC Cable	1	1.2	No	0	Supplied by client

3.4.1 Configuration of System under Test

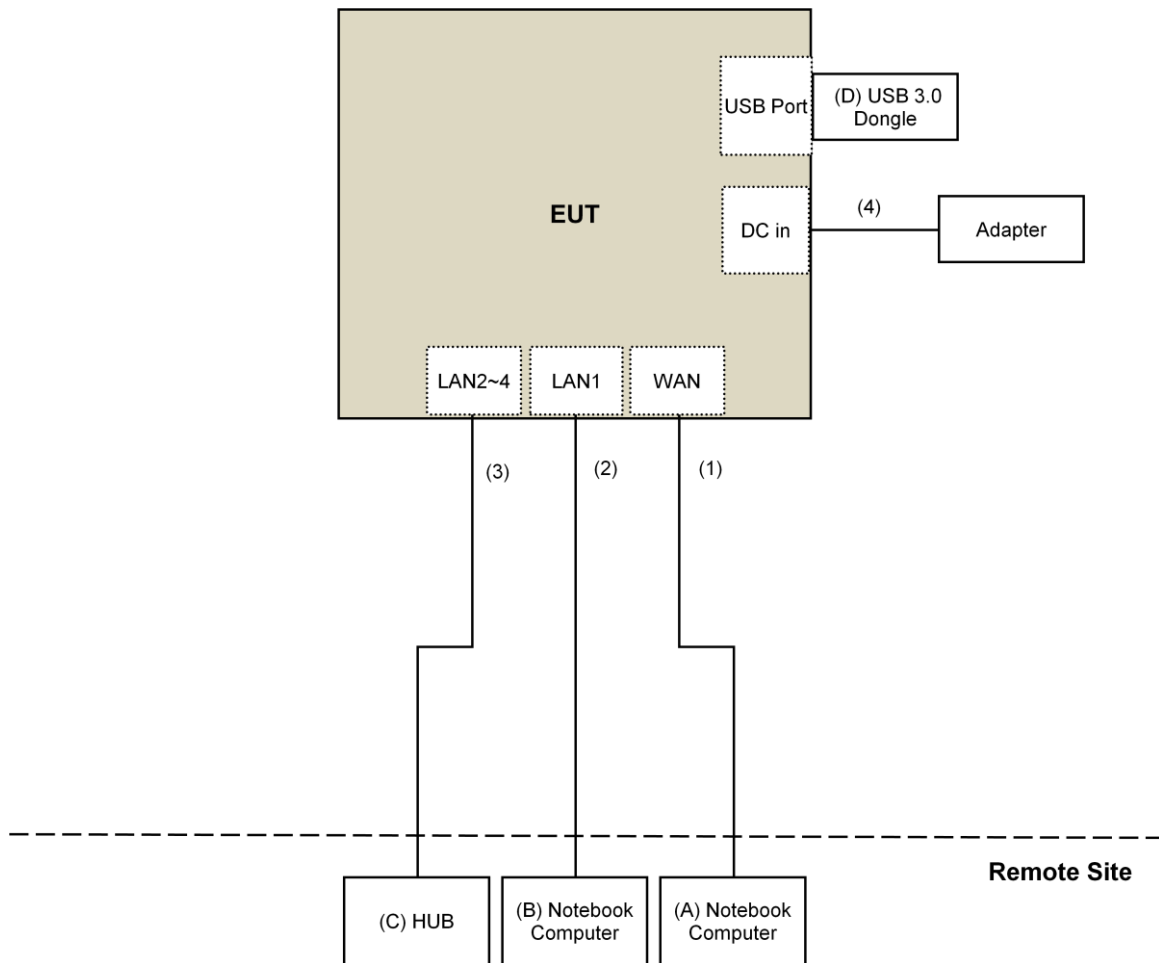

3.5 General Description of Applied Standard

The EUT is a RF Product. According to the specifications of the manufacturer, it must comply with the requirements of the following standards:

FCC Part 15, Subpart E (15.407)
KDB 789033 D02 General UNII Test Procedure New Rules v01r02
KDB 662911 D01 Multiple Transmitter Output v02r01
ANSI C63.10-2013

All test items have been performed and recorded as per the above standards.

NOTE: The EUT has been verified to comply with the requirements of FCC Part 15, Subpart B, Class B (DoC). The test report has been issued separately.

4 Test Types and Results

4.1 Radiated Emission and Bandedge Measurement

4.1.1 Limits of Radiated Emission and Bandedge Measurement

Radiated emissions which fall in the restricted bands must comply with the radiated emission limits specified as below table.

Frequencies (MHz)	Field Strength (microvolts/meter)	Measurement Distance (meters)
0.009 ~ 0.490	2400/F(kHz)	300
0.490 ~ 1.705	24000/F(kHz)	30
1.705 ~ 30.0	30	30
30 ~ 88	100	3
88 ~ 216	150	3
216 ~ 960	200	3
Above 960	500	3

NOTE:

1. The lower limit shall apply at the transition frequencies.
2. Emission level (dBuV/m) = 20 log Emission level (uV/m).
3. For frequencies above 1000MHz, the field strength limits are based on average detector, however, the peak field strength of any emission shall not exceed the maximum permitted average limits, specified above by more than 20dB under any condition of modulation.

Limits of unwanted emission out of the restricted bands

Applicable To		Limit	
789033 D02 General UNII Test Procedure New Rules v01r02		Field Strength at 3m	
		PK:74 (dBμV/m)	AV:54 (dBμV/m)
Frequency Band	Applicable To	EIRP Limit	Equivalent Field Strength at 3m
5150~5250 MHz	15.407(b)(1)	PK:-27 (dBm/MHz)	PK:68.2(dBμV/m)
5250~5350 MHz	15.407(b)(2)		
5470~5725 MHz	15.407(b)(3)		
5725~5850 MHz	<input checked="" type="checkbox"/> 15.407(b)(4)(i)	PK:-27 (dBm/MHz) ^{*1} PK:10 (dBm/MHz) ^{*2} PK:15.6 (dBm/MHz) ^{*3} PK:27 (dBm/MHz) ^{*4}	PK: 68.2(dBμV/m) ^{*1} PK:105.2 (dBμV/m) ^{*2} PK: 110.8(dBμV/m) ^{*3} PK:122.2 (dBμV/m) ^{*4}
	<input type="checkbox"/> 15.407(b)(4)(ii)	Emission limits in section 15.247(d)	
^{*1} beyond 75 MHz or more above of the band edge.		^{*2} below the band edge increasing linearly to 10 dBm/MHz at 25 MHz above.	
^{*3} below the band edge increasing linearly to a level of 15.6 dBm/MHz at 5 MHz above.		^{*4} from 5 MHz above or below the band edge increasing linearly to a level of 27 dBm/MHz at the band edge.	

Note:

The following formula is used to convert the equipment isotropic radiated power (eirp) to field strength:

$$E = \frac{1000000\sqrt{30P}}{3} \mu\text{V/m, where P is the eirp (Watts).}$$

4.1.2 Test Instruments

DESCRIPTION & MANUFACTURER	MODEL NO.	SERIAL NO.	CALIBRATED DATE	CALIBRATED UNTIL
Test Receiver Agilent	N9038A	MY54450088	July 24, 2015	July 23, 2016
Pre-Amplifier ^(*) EMCI	EMC001340	980142	Jan. 20, 2016	Jan. 19, 2018
Loop Antenna ^(*) Electro-Metrics	EM-6879	264	Dec. 16, 2014	Dec. 15, 2016
RF Cable	NA	LOOPCAB-001 LOOPCAB-002	Jan. 18, 2016	Jan. 17, 2017
Pre-Amplifier Mini-Circuits	ZFL-1000VH2B	AMP-ZFL-01	Nov. 11, 2015	Nov. 10, 2016
Trilog Broadband Antenna SCHWARZBECK	VULB 9168	9168-406	Jan. 04, 2016	Jan. 03, 2017
RF Cable	8D	966-4-1 966-4-2 966-4-3	Apr. 02, 2016	Apr. 01, 2017
Horn Antenna SCHWARZBECK	BBHA 9120D	9120D-783	Jan. 19, 2016	Jan. 18, 2017
Pre-Amplifier Agilent	8449B	3008A01922	Sep. 19, 2015	Sep. 18, 2016
RF Cable	EMC104-SM-SM-2000 EMC104-SM-SM-5000 EMC104-SM-SM-5000	150318 150323 150324	Mar. 30, 2016	Mar. 29, 2017
Pre-Amplifier EMCI	EMC184045	980143	Jan. 15, 2016	Jan. 14, 2017
Horn Antenna SCHWARZBECK	BBHA 9170	BBHA9170608	Jan. 08, 2016	Jan. 07, 2017
RF Cable	SUCOFLEX 102	36432/2 36441/2	Jan. 16, 2016	Jan. 15, 2017
Software	ADT_Radiated_V8.7.07	NA	NA	NA
Antenna Tower & Turn Table Max-Full	MF-7802	MF780208410	NA	NA
Boresight Antenna Fixture	FBA-01	FBA-SIP02	NA	NA
Spectrum Analyzer R&S	FSP40	100060	May 11, 2016	May 10, 2017
Power meter Anritsu	ML2495A	1014008	May 05, 2016	May 04, 2017
Power sensor Anritsu	MA2411B	0917122	May 05, 2016	May 04, 2017
Temperature & Humidity Chamber Giant Force	GTH-150-40-SP-AR	MAA0812-008	Jan. 15, 2016	Jan. 14, 2017
AC Power Source Extech Electronics	6205	1440452	NA	NA
Digital Multimeter FLUKE	87III	73680266	Nov. 10, 2015	Nov. 09, 2016

Note:

1. The calibration interval of the above test instruments is 12 months and the calibrations are traceable to NML/ROC and NIST/USA.
2. *The calibration interval of the above test instruments is 24 months and the calibrations are traceable to NML/ROC and NIST/USA.
3. The test was performed in 966 Chamber No. 4.
4. The FCC Site Registration No. is 292998
5. The CANADA Site Registration No. is 20331-2
- 6 Loop antenna was used for all emissions below 30 MHz.
7. Tested Date: July 14 to 15, 2016

4.1.3 Test Procedure

- a. The EUT was placed on the top of a rotating table 0.8 meters (for below 1GHz) / 1.5 meters (for above 1GHz) above the ground at 3 meter chamber room for test. The table was rotated 360 degrees to determine the position of the highest radiation.
- b. The EUT was set 3 meters away from the interference-receiving antenna, which was mounted on the top of a variable-height antenna tower.
- c. The height of antenna is varied from one meter to four meters above the ground to determine the maximum value of the field strength. Both horizontal and vertical polarizations of the antenna are set to make the measurement.
- d. For each suspected emission, the EUT was arranged to its worst case and then the antenna was tuned to heights from 1 meter to 4 meters and the rotatable table was turned from 0 degrees to 360 degrees to find the maximum reading.
- e. The test-receiver system was set to quasi-peak detect function and specified bandwidth with maximum hold mode when the test frequency is below 1 GHz.
- f. The test-receiver system was set to peak and average detect function and specified bandwidth with maximum hold mode when the test frequency is above 1 GHz. If the peak reading value also meets average limit, measurement with the average detector is unnecessary.

Note:

1. The resolution bandwidth and video bandwidth of test receiver/spectrum analyzer is 120kHz for Quasi-peak detection (QP) at frequency below 1GHz.
2. The resolution bandwidth of test receiver/spectrum analyzer is 1 MHz and the video bandwidth is 3 MHz for Peak detection (PK) at frequency above 1GHz.
3. The resolution bandwidth of test receiver/spectrum analyzer is 1MHz and the video bandwidth is 3MHz for RMS Average (Duty cycle < 98%) for Average detection (AV) at frequency above 1GHz, then the measurement results was added to a correction factor ($10 \log(1/\text{duty cycle})$).
4. The resolution bandwidth of test receiver/spectrum analyzer is 1MHz and the video bandwidth is 10Hz (Duty cycle $\geq 98\%$) for Average detection (AV) at frequency above 1GHz.
5. All modes of operation were investigated and the worst-case emissions are reported.

4.1.4 Deviation from Test Standard

No deviation.

4.1.5 Test Setup

<Frequency Range below 1GHz>

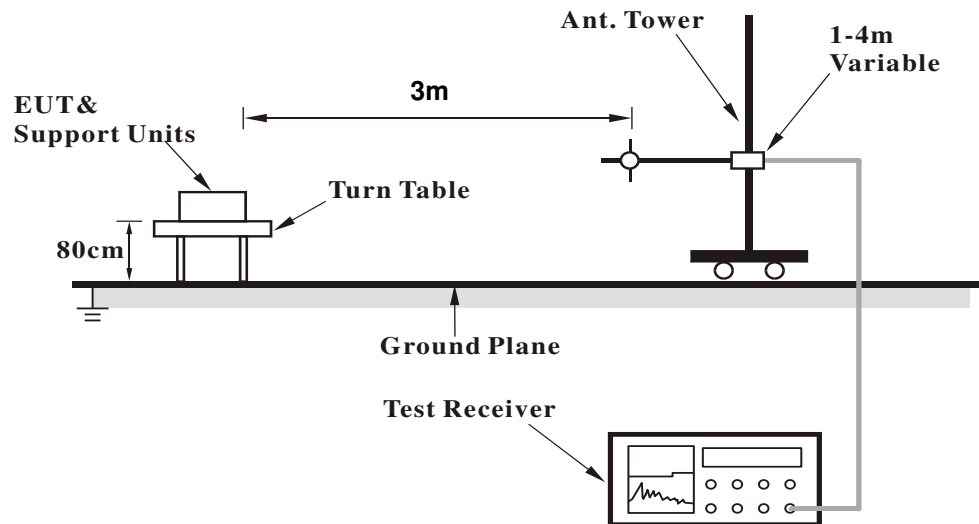

<Frequency Range above 1GHz>

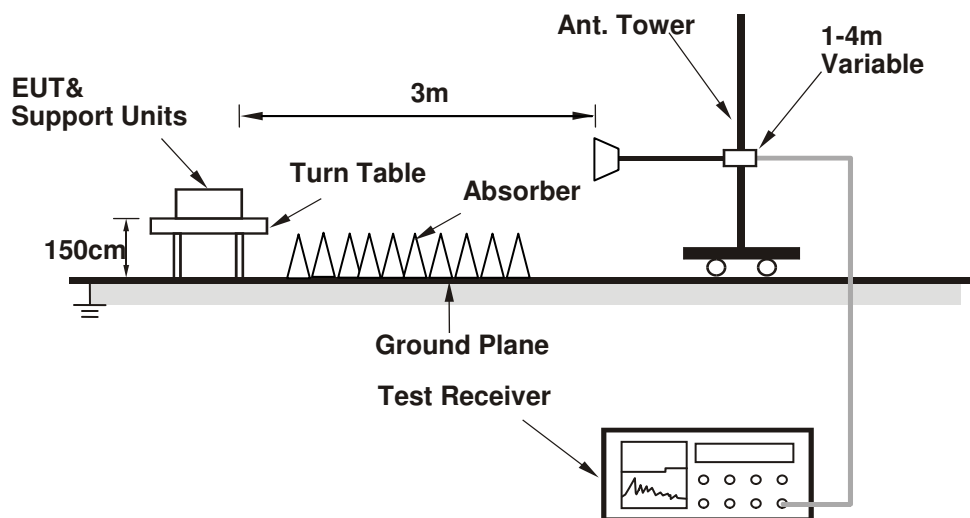

For the actual test configuration, please refer to the attached file (Test Setup Photo).

4.1.6 EUT Operating Condition

- a. Connected the EUT with the Notebook Computer which is placed on remote site.
- b. Controlling software (M_Tool_2.0.3.2.exe) has been activated to set the EUT on specific status.

4.1.7 Test Results (Mode 1)

Above 1GHz Data:

802.11a

CHANNEL	TX Channel 36	DETECTOR FUNCTION	Peak (PK)
FREQUENCY RANGE	1GHz ~ 40GHz		Average (AV)

ANTENNA POLARITY & TEST DISTANCE: HORIZONTAL AT 3 M

NO.	FREQ. (MHz)	EMISSION LEVEL (dBuV/m)	LIMIT (dBuV/m)	MARGIN (dB)	ANTENNA HEIGHT (m)	TABLE ANGLE (Degree)	RAW VALUE (dBuV)	CORRECTION FACTOR (dB/m)
1	5147.30	52.0 PK	74.0	-22.0	1.63 H	323	50.4	1.6
2	5147.30	40.8 AV	54.0	-13.2	1.63 H	323	39.2	1.6
3	*5180.00	109.0 PK			1.63 H	323	107.3	1.7
4	*5180.00	98.5 AV			1.63 H	323	96.8	1.7
5	#10360.00	56.4 PK	74.0	-17.6	1.80 H	257	44.7	11.7
6	#10360.00	43.3 AV	54.0	-10.7	1.80 H	257	31.6	11.7
7	15540.00	56.6 PK	74.0	-17.4	1.89 H	135	43.3	13.3
8	15540.00	42.8 AV	54.0	-11.2	1.89 H	135	29.5	13.3

ANTENNA POLARITY & TEST DISTANCE: VERTICAL AT 3 M

NO.	FREQ. (MHz)	EMISSION LEVEL (dBuV/m)	LIMIT (dBuV/m)	MARGIN (dB)	ANTENNA HEIGHT (m)	TABLE ANGLE (Degree)	RAW VALUE (dBuV)	CORRECTION FACTOR (dB/m)
1	5147.30	67.9 PK	74.0	-6.1	1.56 V	340	66.3	1.6
2	5147.30	52.4 AV	54.0	-1.6	1.56 V	340	50.8	1.6
3	*5180.00	120.1 PK			1.56 V	340	118.4	1.7
4	*5180.00	110.6 AV			1.56 V	340	108.9	1.7
5	#10360.00	57.9 PK	74.0	-16.1	1.16 V	144	46.2	11.7
6	#10360.00	44.2 AV	54.0	-9.8	1.16 V	144	32.5	11.7
7	15540.00	57.3 PK	74.0	-16.7	1.55 V	0	44.0	13.3
8	15540.00	43.4 AV	54.0	-10.6	1.55 V	0	30.1	13.3

REMARKS:

1. Emission Level(dBuV/m) = Raw Value(dBuV) + Correction Factor(dB/m)
2. Correction Factor(dB/m) = Antenna Factor(dB/m) + Cable Factor(dB) – Pre-Amplifier Factor(dB)
3. The other emission levels were very low against the limit.
4. Margin value = Emission Level – Limit value
5. " * ": Fundamental frequency.
6. " # ": The radiated frequency is out of the restricted band.

CHANNEL	TX Channel 40	DETECTOR FUNCTION	Peak (PK)
FREQUENCY RANGE	1GHz ~ 40GHz		Average (AV)

ANTENNA POLARITY & TEST DISTANCE: HORIZONTAL AT 3 M

NO.	FREQ. (MHz)	EMISSION LEVEL (dBuV/m)	LIMIT (dBuV/m)	MARGIN (dB)	ANTENNA HEIGHT (m)	TABLE ANGLE (Degree)	RAW VALUE (dBuV)	CORRECTION FACTOR (dB/m)
1	*5200.00	108.3 PK			1.68 H	296	106.5	1.8
2	*5200.00	97.8 AV			1.68 H	296	96.0	1.8
3	#10400.00	55.7 PK	74.0	-18.3	1.73 H	268	43.8	11.9
4	#10400.00	42.4 AV	54.0	-11.6	1.73 H	268	30.5	11.9
5	15600.00	56.1 PK	74.0	-17.9	1.78 H	156	42.8	13.3
6	15600.00	42.3 AV	54.0	-11.7	1.78 H	156	29.0	13.3

ANTENNA POLARITY & TEST DISTANCE: VERTICAL AT 3 M

NO.	FREQ. (MHz)	EMISSION LEVEL (dBuV/m)	LIMIT (dBuV/m)	MARGIN (dB)	ANTENNA HEIGHT (m)	TABLE ANGLE (Degree)	RAW VALUE (dBuV)	CORRECTION FACTOR (dB/m)
1	*5200.00	120.0 PK			1.46 V	347	118.2	1.8
2	*5200.00	110.2 AV			1.46 V	347	108.4	1.8
3	#10400.00	57.8 PK	74.0	-16.2	1.27 V	128	45.9	11.9
4	#10400.00	44.0 AV	54.0	-10.0	1.27 V	128	32.1	11.9
5	15600.00	56.4 PK	74.0	-17.6	1.54 V	23	43.1	13.3
6	15600.00	42.8 AV	54.0	-11.2	1.54 V	23	29.5	13.3

REMARKS:

1. Emission Level(dBuV/m) = Raw Value(dBuV) + Correction Factor(dB/m)
2. Correction Factor(dB/m) = Antenna Factor(dB/m) + Cable Factor(dB) – Pre-Amplifier Factor(dB)
3. The other emission levels were very low against the limit.
4. Margin value = Emission Level – Limit value
5. " * ": Fundamental frequency.
6. " # ": The radiated frequency is out of the restricted band.

CHANNEL	TX Channel 48	DETECTOR FUNCTION	Peak (PK)
FREQUENCY RANGE	1GHz ~ 40GHz		Average (AV)

ANTENNA POLARITY & TEST DISTANCE: HORIZONTAL AT 3 M

NO.	FREQ. (MHz)	EMISSION LEVEL (dBuV/m)	LIMIT (dBuV/m)	MARGIN (dB)	ANTENNA HEIGHT (m)	TABLE ANGLE (Degree)	RAW VALUE (dBuV)	CORRECTION FACTOR (dB/m)
1	5150.00	52.9 PK	74.0	-21.1	1.68 H	325	51.3	1.6
2	5150.00	39.8 AV	54.0	-14.2	1.68 H	325	38.2	1.6
3	*5240.00	108.5 PK			1.68 H	325	106.7	1.8
4	*5240.00	98.6 AV			1.68 H	325	96.8	1.8
5	5350.00	52.5 PK	74.0	-21.5	1.68 H	325	50.4	2.1
6	5350.00	39.9 AV	54.0	-14.1	1.68 H	325	37.8	2.1
7	#10480.00	56.2 PK	74.0	-17.8	1.89 H	256	44.0	12.2
8	#10480.00	43.5 AV	54.0	-10.5	1.89 H	256	31.3	12.2
9	15720.00	55.7 PK	74.0	-18.3	1.75 H	141	42.5	13.2
10	15720.00	42.0 AV	54.0	-12.0	1.75 H	141	28.8	13.2

ANTENNA POLARITY & TEST DISTANCE: VERTICAL AT 3 M

NO.	FREQ. (MHz)	EMISSION LEVEL (dBuV/m)	LIMIT (dBuV/m)	MARGIN (dB)	ANTENNA HEIGHT (m)	TABLE ANGLE (Degree)	RAW VALUE (dBuV)	CORRECTION FACTOR (dB/m)
1	5150.00	56.3 PK	74.0	-17.7	1.52 V	338	54.7	1.6
2	5150.00	45.4 AV	54.0	-8.6	1.52 V	338	43.8	1.6
3	*5240.00	119.3 PK			1.52 V	338	117.5	1.8
4	*5240.00	110.0 AV			1.52 V	338	108.2	1.8
5	5350.00	54.0 PK	74.0	-20.0	1.52 V	338	51.9	2.1
6	5350.00	43.0 AV	54.0	-11.0	1.52 V	338	40.9	2.1
7	#10480.00	58.2 PK	74.0	-15.8	1.18 V	146	46.0	12.2
8	#10480.00	44.4 AV	54.0	-9.6	1.18 V	146	32.2	12.2
9	15720.00	56.6 PK	74.0	-17.4	1.46 V	22	43.4	13.2
10	15720.00	42.9 AV	54.0	-11.1	1.46 V	22	29.7	13.2

REMARKS:

1. Emission Level(dBuV/m) = Raw Value(dBuV) + Correction Factor(dB/m)
2. Correction Factor(dB/m) = Antenna Factor(dB/m) + Cable Factor(dB) – Pre-Amplifier Factor(dB)
3. The other emission levels were very low against the limit.
4. Margin value = Emission Level – Limit value
5. " * ": Fundamental frequency.
6. " # ": The radiated frequency is out of the restricted band.

CHANNEL	TX Channel 149	DETECTOR FUNCTION	Peak (PK)
FREQUENCY RANGE	1GHz ~ 40GHz		Average (AV)

ANTENNA POLARITY & TEST DISTANCE: HORIZONTAL AT 3 M

NO.	FREQ. (MHz)	EMISSION LEVEL (dBuV/m)	LIMIT (dBuV/m)	MARGIN (dB)	ANTENNA HEIGHT (m)	TABLE ANGLE (Degree)	RAW VALUE (dBuV)	CORRECTION FACTOR (dB/m)
1	#5610.80	60.1 PK	68.2	-8.1	1.72 H	329	57.5	2.6
2	*5745.00	113.4 PK			1.72 H	329	110.6	2.8
3	*5745.00	101.5 AV			1.72 H	329	98.7	2.8
4	#5991.27	60.6 PK	68.2	-7.6	1.72 H	329	57.2	3.4
5	11490.00	52.1 PK	74.0	-21.9	2.48 H	173	38.6	13.5
6	11490.00	39.8 AV	54.0	-14.2	2.48 H	173	26.3	13.5
7	#17235.00	57.6 PK	74.0	-16.4	1.98 H	86	39.2	18.4
8	#17235.00	44.5 AV	54.0	-9.5	1.98 H	86	26.1	18.4

ANTENNA POLARITY & TEST DISTANCE: VERTICAL AT 3 M

NO.	FREQ. (MHz)	EMISSION LEVEL (dBuV/m)	LIMIT (dBuV/m)	MARGIN (dB)	ANTENNA HEIGHT (m)	TABLE ANGLE (Degree)	RAW VALUE (dBuV)	CORRECTION FACTOR (dB/m)
1	#5616.50	62.7 PK	68.2	-5.5	1.59 V	143	60.1	2.6
2	*5745.00	123.1 PK			1.59 V	143	120.3	2.8
3	*5745.00	113.8 AV			1.59 V	143	111.0	2.8
4	#5989.37	63.7 PK	68.2	-4.5	1.59 V	143	60.3	3.4
5	11490.00	56.9 PK	74.0	-17.1	3.30 V	198	43.4	13.5
6	11490.00	43.8 AV	54.0	-10.2	3.30 V	198	30.3	13.5
7	#17235.00	56.9 PK	74.0	-17.1	1.72 V	17	38.5	18.4
8	#17235.00	45.1 AV	54.0	-8.9	1.72 V	17	26.7	18.4

REMARKS:

1. Emission Level(dBuV/m) = Raw Value(dBuV) + Correction Factor(dB/m)
2. Correction Factor(dB/m) = Antenna Factor(dB/m) + Cable Factor(dB) – Pre-Amplifier Factor(dB)
3. The other emission levels were very low against the limit.
4. Margin value = Emission Level – Limit value
5. " * ": Fundamental frequency.
6. " # ": The radiated frequency is out of the restricted band.

CHANNEL	TX Channel 157	DETECTOR FUNCTION	Peak (PK)
FREQUENCY RANGE	1GHz ~ 40GHz		Average (AV)

ANTENNA POLARITY & TEST DISTANCE: HORIZONTAL AT 3 M

NO.	FREQ. (MHz)	EMISSION LEVEL (dBuV/m)	LIMIT (dBuV/m)	MARGIN (dB)	ANTENNA HEIGHT (m)	TABLE ANGLE (Degree)	RAW VALUE (dBuV)	CORRECTION FACTOR (dB/m)
1	#5621.25	60.7 PK	68.2	-7.5	1.71 H	326	58.1	2.6
2	*5785.00	113.5 PK			1.71 H	326	110.6	2.9
3	*5785.00	101.7 AV			1.71 H	326	98.8	2.9
4	#5967.05	62.0 PK	68.2	-6.2	1.71 H	326	58.8	3.2
5	11570.00	52.6 PK	74.0	-21.4	2.46 H	185	39.4	13.2
6	11570.00	40.0 AV	54.0	-14.0	2.46 H	185	26.8	13.2
7	#17355.00	57.3 PK	74.0	-16.7	1.97 H	84	38.2	19.1
8	#17355.00	44.6 AV	54.0	-9.4	1.97 H	84	25.5	19.1

ANTENNA POLARITY & TEST DISTANCE: VERTICAL AT 3 M

NO.	FREQ. (MHz)	EMISSION LEVEL (dBuV/m)	LIMIT (dBuV/m)	MARGIN (dB)	ANTENNA HEIGHT (m)	TABLE ANGLE (Degree)	RAW VALUE (dBuV)	CORRECTION FACTOR (dB/m)
1	#5625.05	62.0 PK	68.2	-6.2	1.62 V	119	59.4	2.6
2	*5785.00	124.4 PK			1.62 V	119	121.5	2.9
3	*5785.00	114.0 AV			1.62 V	119	111.1	2.9
4	#5941.87	61.8 PK	68.2	-6.4	1.62 V	119	58.7	3.1
5	11570.00	57.7 PK	74.0	-16.3	3.21 V	206	44.5	13.2
6	11570.00	44.0 AV	54.0	-10.0	3.21 V	206	30.8	13.2
7	#17355.00	57.2 PK	74.0	-16.8	1.66 V	5	38.1	19.1
8	#17355.00	45.2 AV	54.0	-8.8	1.66 V	5	26.1	19.1

REMARKS:

1. Emission Level(dBuV/m) = Raw Value(dBuV) + Correction Factor(dB/m)
2. Correction Factor(dB/m) = Antenna Factor(dB/m) + Cable Factor(dB) – Pre-Amplifier Factor(dB)
3. The other emission levels were very low against the limit.
4. Margin value = Emission Level – Limit value
5. " * ": Fundamental frequency.
6. " # ": The radiated frequency is out of the restricted band.

CHANNEL	TX Channel 165	DETECTOR FUNCTION	Peak (PK)
FREQUENCY RANGE	1GHz ~ 40GHz		Average (AV)

ANTENNA POLARITY & TEST DISTANCE: HORIZONTAL AT 3 M

NO.	FREQ. (MHz)	EMISSION LEVEL (dBuV/m)	LIMIT (dBuV/m)	MARGIN (dB)	ANTENNA HEIGHT (m)	TABLE ANGLE (Degree)	RAW VALUE (dBuV)	CORRECTION FACTOR (dB/m)
1	#5624.10	60.9 PK	68.2	-7.3	1.72 H	301	58.3	2.6
2	*5825.00	113.2 PK			1.72 H	301	110.3	2.9
3	*5825.00	101.3 AV			1.72 H	301	98.4	2.9
4	#5963.25	62.4 PK	68.2	-5.8	1.72 H	301	59.2	3.2
5	11650.00	52.1 PK	74.0	-21.9	2.37 H	208	38.9	13.2
6	11650.00	39.1 AV	54.0	-14.9	2.37 H	208	25.9	13.2
7	#17475.00	57.1 PK	74.0	-16.9	1.92 H	58	37.7	19.4
8	#17475.00	44.2 AV	54.0	-9.8	1.92 H	58	24.8	19.4

ANTENNA POLARITY & TEST DISTANCE: VERTICAL AT 3 M

NO.	FREQ. (MHz)	EMISSION LEVEL (dBuV/m)	LIMIT (dBuV/m)	MARGIN (dB)	ANTENNA HEIGHT (m)	TABLE ANGLE (Degree)	RAW VALUE (dBuV)	CORRECTION FACTOR (dB/m)
1	#5590.37	64.3 PK	68.2	-3.9	1.59 V	144	61.8	2.5
2	*5825.00	124.1 PK			1.59 V	144	121.2	2.9
3	*5825.00	113.6 AV			1.59 V	144	110.7	2.9
4	#5964.20	61.8 PK	68.2	-6.4	1.59 V	144	58.6	3.2
5	11650.00	57.1 PK	74.0	-16.9	3.23 V	198	43.9	13.2
6	11650.00	44.1 AV	54.0	-9.9	3.23 V	198	30.9	13.2
7	#17475.00	57.2 PK	74.0	-16.8	1.69 V	8	37.8	19.4
8	#17475.00	45.1 AV	54.0	-8.9	1.69 V	8	25.7	19.4

REMARKS:

1. Emission Level(dBuV/m) = Raw Value(dBuV) + Correction Factor(dB/m)
2. Correction Factor(dB/m) = Antenna Factor(dB/m) + Cable Factor(dB) – Pre-Amplifier Factor(dB)
3. The other emission levels were very low against the limit.
4. Margin value = Emission Level – Limit value
5. " * ": Fundamental frequency.
6. " # ": The radiated frequency is out of the restricted band.

802.11ac (VHT20)

CHANNEL	TX Channel 36	DETECTOR FUNCTION	Peak (PK)
FREQUENCY RANGE	1GHz ~ 40GHz		Average (AV)

ANTENNA POLARITY & TEST DISTANCE: HORIZONTAL AT 3 M

NO.	FREQ. (MHz)	EMISSION LEVEL (dBuV/m)	LIMIT (dBuV/m)	MARGIN (dB)	ANTENNA HEIGHT (m)	TABLE ANGLE (Degree)	RAW VALUE (dBuV)	CORRECTION FACTOR (dB/m)
1	5150.00	53.1 PK	74.0	-20.9	1.55 H	340	51.5	1.6
2	5150.00	41.5 AV	54.0	-12.5	1.55 H	340	39.9	1.6
3	*5180.00	108.5 PK			1.58 H	319	106.8	1.7
4	*5180.00	98.3 AV			1.58 H	319	96.6	1.7
5	#10360.00	56.5 PK	74.0	-17.5	1.87 H	252	44.8	11.7
6	#10360.00	43.4 AV	54.0	-10.6	1.87 H	252	31.7	11.7
7	15540.00	55.4 PK	74.0	-18.6	1.85 H	149	42.1	13.3
8	15540.00	41.8 AV	54.0	-12.2	1.85 H	149	28.5	13.3

ANTENNA POLARITY & TEST DISTANCE: VERTICAL AT 3 M

NO.	FREQ. (MHz)	EMISSION LEVEL (dBuV/m)	LIMIT (dBuV/m)	MARGIN (dB)	ANTENNA HEIGHT (m)	TABLE ANGLE (Degree)	RAW VALUE (dBuV)	CORRECTION FACTOR (dB/m)
1	5150.00	68.4 PK	74.0	-5.6	1.54 V	336	66.8	1.6
2	5150.00	52.7 AV	54.0	-1.3	1.54 V	336	51.1	1.6
3	*5180.00	120.4 PK			1.49 V	343	118.7	1.7
4	*5180.00	110.7 AV			1.49 V	343	109.0	1.7
5	#10360.00	57.4 PK	74.0	-16.6	1.20 V	164	45.7	11.7
6	#10360.00	44.3 AV	54.0	-9.7	1.20 V	164	32.6	11.7
7	15540.00	56.8 PK	74.0	-17.2	1.55 V	36	43.5	13.3
8	15540.00	43.2 AV	54.0	-10.8	1.55 V	36	29.9	13.3

REMARKS:

- Emission Level(dBuV/m) = Raw Value(dBuV) + Correction Factor(dB/m)
- Correction Factor(dB/m) = Antenna Factor(dB/m) + Cable Factor(dB) – Pre-Amplifier Factor(dB)
- The other emission levels were very low against the limit.
- Margin value = Emission Level – Limit value
- " * ": Fundamental frequency.
- " # ": The radiated frequency is out of the restricted band.

CHANNEL	TX Channel 40	DETECTOR FUNCTION	Peak (PK)
FREQUENCY RANGE	1GHz ~ 40GHz		Average (AV)

ANTENNA POLARITY & TEST DISTANCE: HORIZONTAL AT 3 M

NO.	FREQ. (MHz)	EMISSION LEVEL (dBuV/m)	LIMIT (dBuV/m)	MARGIN (dB)	ANTENNA HEIGHT (m)	TABLE ANGLE (Degree)	RAW VALUE (dBuV)	CORRECTION FACTOR (dB/m)
1	*5200.00	109.5 PK			1.62 H	323	107.7	1.8
2	*5200.00	99.1 AV			1.62 H	323	97.3	1.8
3	#10400.00	55.8 PK	74.0	-18.2	1.79 H	252	43.9	11.9
4	#10400.00	42.9 AV	54.0	-11.1	1.79 H	252	31.0	11.9
5	15600.00	56.2 PK	74.0	-17.8	1.93 H	159	42.9	13.3
6	15600.00	42.3 AV	54.0	-11.7	1.93 H	159	29.0	13.3

ANTENNA POLARITY & TEST DISTANCE: VERTICAL AT 3 M

NO.	FREQ. (MHz)	EMISSION LEVEL (dBuV/m)	LIMIT (dBuV/m)	MARGIN (dB)	ANTENNA HEIGHT (m)	TABLE ANGLE (Degree)	RAW VALUE (dBuV)	CORRECTION FACTOR (dB/m)
1	*5200.00	120.4 PK			1.52 V	353	118.6	1.8
2	*5200.00	110.7 AV			1.52 V	353	108.9	1.8
3	#10400.00	58.3 PK	74.0	-15.7	1.26 V	149	46.4	11.9
4	#10400.00	44.3 AV	54.0	-9.7	1.26 V	149	32.4	11.9
5	15600.00	56.6 PK	74.0	-17.4	1.51 V	24	43.3	13.3
6	15600.00	42.9 AV	54.0	-11.1	1.51 V	24	29.6	13.3

REMARKS:

- Emission Level(dBuV/m) = Raw Value(dBuV) + Correction Factor(dB/m)
- Correction Factor(dB/m) = Antenna Factor(dB/m) + Cable Factor(dB) – Pre-Amplifier Factor(dB)
- The other emission levels were very low against the limit.
- Margin value = Emission Level – Limit value
- " * ": Fundamental frequency.
- " # ": The radiated frequency is out of the restricted band.

CHANNEL	TX Channel 48	DETECTOR FUNCTION	Peak (PK)
FREQUENCY RANGE	1GHz ~ 40GHz		Average (AV)

ANTENNA POLARITY & TEST DISTANCE: HORIZONTAL AT 3 M

NO.	FREQ. (MHz)	EMISSION LEVEL (dBuV/m)	LIMIT (dBuV/m)	MARGIN (dB)	ANTENNA HEIGHT (m)	TABLE ANGLE (Degree)	RAW VALUE (dBuV)	CORRECTION FACTOR (dB/m)
1	5150.00	53.1 PK	74.0	-20.9	1.66 H	312	51.5	1.6
2	5150.00	40.2 AV	54.0	-13.8	1.66 H	312	38.6	1.6
3	*5240.00	108.7 PK			1.69 H	303	106.9	1.8
4	*5240.00	98.3 AV			1.69 H	303	96.5	1.8
5	5350.00	51.8 PK	74.0	-22.2	1.68 H	315	49.7	2.1
6	5350.00	39.6 AV	54.0	-14.4	1.68 H	315	37.5	2.1
7	#10480.00	56.1 PK	74.0	-17.9	1.81 H	258	43.9	12.2
8	#10480.00	43.4 AV	54.0	-10.6	1.81 H	258	31.2	12.2
9	15720.00	56.3 PK	74.0	-17.7	1.81 H	141	43.1	13.2
10	15720.00	42.2 AV	54.0	-11.8	1.81 H	141	29.0	13.2

ANTENNA POLARITY & TEST DISTANCE: VERTICAL AT 3 M

NO.	FREQ. (MHz)	EMISSION LEVEL (dBuV/m)	LIMIT (dBuV/m)	MARGIN (dB)	ANTENNA HEIGHT (m)	TABLE ANGLE (Degree)	RAW VALUE (dBuV)	CORRECTION FACTOR (dB/m)
1	5150.00	56.4 PK	74.0	-17.6	1.43 V	305	54.8	1.6
2	5150.00	45.3 AV	54.0	-8.7	1.43 V	305	43.7	1.6
3	*5240.00	120.6 PK			1.46 V	315	118.8	1.8
4	*5240.00	111.0 AV			1.46 V	315	109.2	1.8
5	5350.00	54.4 PK	74.0	-19.6	1.40 V	316	52.3	2.1
6	5350.00	42.9 AV	54.0	-11.1	1.40 V	316	40.8	2.1
7	#10480.00	58.2 PK	74.0	-15.8	1.15 V	136	46.0	12.2
8	#10480.00	44.3 AV	54.0	-9.7	1.15 V	136	32.1	12.2
9	15720.00	56.4 PK	74.0	-17.6	1.46 V	32	43.2	13.2
10	15720.00	42.3 AV	54.0	-11.7	1.46 V	32	29.1	13.2

REMARKS:

1. Emission Level(dBuV/m) = Raw Value(dBuV) + Correction Factor(dB/m)
2. Correction Factor(dB/m) = Antenna Factor(dB/m) + Cable Factor(dB) – Pre-Amplifier Factor(dB)
3. The other emission levels were very low against the limit.
4. Margin value = Emission Level – Limit value
5. " * ": Fundamental frequency.
6. " # ": The radiated frequency is out of the restricted band.

CHANNEL	TX Channel 149	DETECTOR FUNCTION	Peak (PK)
FREQUENCY RANGE	1GHz ~ 40GHz		Average (AV)

ANTENNA POLARITY & TEST DISTANCE: HORIZONTAL AT 3 M

NO.	FREQ. (MHz)	EMISSION LEVEL (dBuV/m)	LIMIT (dBuV/m)	MARGIN (dB)	ANTENNA HEIGHT (m)	TABLE ANGLE (Degree)	RAW VALUE (dBuV)	CORRECTION FACTOR (dB/m)
1	#5610.80	60.5 PK	68.2	-7.7	1.75 H	332	57.9	2.6
2	*5745.00	112.1 PK			1.75 H	332	109.3	2.8
3	*5745.00	99.7 AV			1.75 H	332	96.9	2.8
4	#5961.35	61.2 PK	68.2	-7.0	1.75 H	332	58.0	3.2
5	11490.00	52.3 PK	74.0	-21.7	2.37 H	179	38.8	13.5
6	11490.00	39.7 AV	54.0	-14.3	2.37 H	179	26.2	13.5
7	#17235.00	57.0 PK	74.0	-17.0	1.86 H	81	38.6	18.4
8	#17235.00	43.9 AV	54.0	-10.1	1.86 H	81	25.5	18.4

ANTENNA POLARITY & TEST DISTANCE: VERTICAL AT 3 M

NO.	FREQ. (MHz)	EMISSION LEVEL (dBuV/m)	LIMIT (dBuV/m)	MARGIN (dB)	ANTENNA HEIGHT (m)	TABLE ANGLE (Degree)	RAW VALUE (dBuV)	CORRECTION FACTOR (dB/m)
1	#5627.90	63.1 PK	68.2	-5.1	1.65 V	144	60.5	2.6
2	*5745.00	124.9 PK			1.65 V	144	122.1	2.8
3	*5745.00	112.8 AV			1.65 V	144	110.0	2.8
4	#5976.55	64.5 PK	68.2	-3.7	1.65 V	144	61.3	3.2
5	11490.00	57.5 PK	74.0	-16.5	3.27 V	192	44.0	13.5
6	11490.00	44.0 AV	54.0	-10.0	3.27 V	192	30.5	13.5
7	#17235.00	56.8 PK	74.0	-17.2	1.88 V	5	38.4	18.4
8	#17235.00	44.9 AV	54.0	-9.1	1.88 V	5	26.5	18.4

REMARKS:

1. Emission Level(dBuV/m) = Raw Value(dBuV) + Correction Factor(dB/m)
2. Correction Factor(dB/m) = Antenna Factor(dB/m) + Cable Factor(dB) – Pre-Amplifier Factor(dB)
3. The other emission levels were very low against the limit.
4. Margin value = Emission Level – Limit value
5. " * ": Fundamental frequency.
6. " # ": The radiated frequency is out of the restricted band.

CHANNEL	TX Channel 157	DETECTOR FUNCTION	Peak (PK)
FREQUENCY RANGE	1GHz ~ 40GHz		Average (AV)

ANTENNA POLARITY & TEST DISTANCE: HORIZONTAL AT 3 M

NO.	FREQ. (MHz)	EMISSION LEVEL (dBuV/m)	LIMIT (dBuV/m)	MARGIN (dB)	ANTENNA HEIGHT (m)	TABLE ANGLE (Degree)	RAW VALUE (dBuV)	CORRECTION FACTOR (dB/m)
1	#5640.73	62.3 PK	68.2	-5.9	1.74 H	345	59.7	2.6
2	*5785.00	112.6 PK			1.74 H	345	109.7	2.9
3	*5785.00	100.1 AV			1.74 H	345	97.2	2.9
4	#5979.87	61.8 PK	68.2	-6.4	1.74 H	345	58.5	3.3
5	11570.00	53.1 PK	74.0	-20.9	2.40 H	190	39.9	13.2
6	11570.00	40.3 AV	54.0	-13.7	2.40 H	190	27.1	13.2
7	#17355.00	57.0 PK	74.0	-17.0	1.93 H	79	37.9	19.1
8	#17355.00	44.1 AV	54.0	-9.9	1.93 H	79	25.0	19.1

ANTENNA POLARITY & TEST DISTANCE: VERTICAL AT 3 M

NO.	FREQ. (MHz)	EMISSION LEVEL (dBuV/m)	LIMIT (dBuV/m)	MARGIN (dB)	ANTENNA HEIGHT (m)	TABLE ANGLE (Degree)	RAW VALUE (dBuV)	CORRECTION FACTOR (dB/m)
1	#5587.52	62.3 PK	68.2	-5.9	1.66 V	147	59.8	2.5
2	*5785.00	124.0 PK			1.66 V	147	121.1	2.9
3	*5785.00	112.2 AV			1.66 V	147	109.3	2.9
4	#6006.48	61.9 PK	68.2	-6.3	1.66 V	147	58.5	3.4
5	11570.00	56.5 PK	74.0	-17.5	3.32 V	232	43.3	13.2
6	11570.00	43.4 AV	54.0	-10.6	3.32 V	232	30.2	13.2
7	#17355.00	57.1 PK	74.0	-16.9	1.81 V	35	38.0	19.1
8	#17355.00	45.3 AV	54.0	-8.7	1.81 V	35	26.2	19.1

REMARKS:

1. Emission Level(dBuV/m) = Raw Value(dBuV) + Correction Factor(dB/m)
2. Correction Factor(dB/m) = Antenna Factor(dB/m) + Cable Factor(dB) – Pre-Amplifier Factor(dB)
3. The other emission levels were very low against the limit.
4. Margin value = Emission Level – Limit value
5. " * ": Fundamental frequency.
6. " # ": The radiated frequency is out of the restricted band.

CHANNEL	TX Channel 165	DETECTOR FUNCTION	Peak (PK)
FREQUENCY RANGE	1GHz ~ 40GHz		Average (AV)

ANTENNA POLARITY & TEST DISTANCE: HORIZONTAL AT 3 M

NO.	FREQ. (MHz)	EMISSION LEVEL (dBuV/m)	LIMIT (dBuV/m)	MARGIN (dB)	ANTENNA HEIGHT (m)	TABLE ANGLE (Degree)	RAW VALUE (dBuV)	CORRECTION FACTOR (dB/m)
1	#5613.65	61.3 PK	68.2	-6.9	1.70 H	296	58.7	2.6
2	*5825.00	112.5 PK			1.70 H	296	109.6	2.9
3	*5825.00	100.2 AV			1.70 H	296	97.3	2.9
4	#5975.60	61.0 PK	68.2	-7.2	1.70 H	296	57.8	3.2
5	11650.00	52.3 PK	74.0	-21.7	2.46 H	179	39.1	13.2
6	11650.00	39.9 AV	54.0	-14.1	2.46 H	179	26.7	13.2
7	#17475.00	56.4 PK	74.0	-17.6	1.90 H	87	37.0	19.4
8	#17475.00	43.1 AV	54.0	-10.9	1.90 H	87	23.7	19.4

ANTENNA POLARITY & TEST DISTANCE: VERTICAL AT 3 M

NO.	FREQ. (MHz)	EMISSION LEVEL (dBuV/m)	LIMIT (dBuV/m)	MARGIN (dB)	ANTENNA HEIGHT (m)	TABLE ANGLE (Degree)	RAW VALUE (dBuV)	CORRECTION FACTOR (dB/m)
1	#5577.07	63.6 PK	68.2	-4.6	1.62 V	153	61.1	2.5
2	*5825.00	124.3 PK			1.62 V	153	121.4	2.9
3	*5825.00	112.4 AV			1.62 V	153	109.5	2.9
4	#5926.20	62.2 PK	68.2	-6.0	1.62 V	153	59.1	3.1
5	11650.00	57.3 PK	74.0	-16.7	3.26 V	226	44.1	13.2
6	11650.00	44.1 AV	54.0	-9.9	3.26 V	226	30.9	13.2
7	#17475.00	56.5 PK	74.0	-17.5	1.87 V	44	37.1	19.4
8	#17475.00	44.7 AV	54.0	-9.3	1.87 V	44	25.3	19.4

REMARKS:

1. Emission Level(dBuV/m) = Raw Value(dBuV) + Correction Factor(dB/m)
2. Correction Factor(dB/m) = Antenna Factor(dB/m) + Cable Factor(dB) – Pre-Amplifier Factor(dB)
3. The other emission levels were very low against the limit.
4. Margin value = Emission Level – Limit value
5. " * ": Fundamental frequency.
6. " # ": The radiated frequency is out of the restricted band.

802.11ac (VHT40)

CHANNEL	TX Channel 38	DETECTOR FUNCTION	Peak (PK)
FREQUENCY RANGE	1GHz ~ 40GHz		Average (AV)

ANTENNA POLARITY & TEST DISTANCE: HORIZONTAL AT 3 M

NO.	FREQ. (MHz)	EMISSION LEVEL (dBuV/m)	LIMIT (dBuV/m)	MARGIN (dB)	ANTENNA HEIGHT (m)	TABLE ANGLE (Degree)	RAW VALUE (dBuV)	CORRECTION FACTOR (dB/m)
1	5150.00	57.1 PK	74.0	-16.9	1.80 H	326	55.5	1.6
2	5150.00	45.2 AV	54.0	-8.8	1.80 H	326	43.6	1.6
3	*5190.00	101.0 PK			1.81 H	344	99.2	1.8
4	*5190.00	89.2 AV			1.81 H	344	87.4	1.8
5	5350.00	52.1 PK	74.0	-21.9	1.79 H	327	50.0	2.1
6	5350.00	39.5 AV	54.0	-14.5	1.79 H	327	37.4	2.1
7	#10380.00	51.3 PK	74.0	-22.7	1.78 H	250	39.5	11.8
8	#10380.00	38.1 AV	54.0	-15.9	1.78 H	250	26.3	11.8
9	15570.00	52.8 PK	74.0	-21.2	1.82 H	151	39.5	13.3
10	15570.00	39.8 AV	54.0	-14.2	1.82 H	151	26.5	13.3

ANTENNA POLARITY & TEST DISTANCE: VERTICAL AT 3 M

NO.	FREQ. (MHz)	EMISSION LEVEL (dBuV/m)	LIMIT (dBuV/m)	MARGIN (dB)	ANTENNA HEIGHT (m)	TABLE ANGLE (Degree)	RAW VALUE (dBuV)	CORRECTION FACTOR (dB/m)
1	5150.00	65.2 PK	74.0	-8.8	1.20 V	155	63.6	1.6
2	5150.00	53.8 AV	54.0	-0.2	1.20 V	155	52.2	1.6
3	*5190.00	112.4 PK			1.19 V	156	110.6	1.8
4	*5190.00	101.3 AV			1.19 V	156	99.5	1.8
5	5350.00	55.2 PK	74.0	-18.8	1.16 V	135	53.1	2.1
6	5350.00	44.2 AV	54.0	-9.8	1.16 V	135	42.1	2.1
7	#10380.00	50.6 PK	74.0	-23.4	1.19 V	131	38.8	11.8
8	#10380.00	37.7 AV	54.0	-16.3	1.19 V	131	25.9	11.8
9	15570.00	53.2 PK	74.0	-20.8	1.50 V	0	39.9	13.3
10	15570.00	40.2 AV	54.0	-13.8	1.50 V	0	26.9	13.3

REMARKS:

- Emission Level(dBuV/m) = Raw Value(dBuV) + Correction Factor(dB/m)
- Correction Factor(dB/m) = Antenna Factor(dB/m) + Cable Factor(dB) – Pre-Amplifier Factor(dB)
- The other emission levels were very low against the limit.
- Margin value = Emission Level – Limit value
- " * ": Fundamental frequency.
- " # ": The radiated frequency is out of the restricted band.

CHANNEL	TX Channel 46	DETECTOR FUNCTION	Peak (PK)
FREQUENCY RANGE	1GHz ~ 40GHz		Average (AV)

ANTENNA POLARITY & TEST DISTANCE: HORIZONTAL AT 3 M

NO.	FREQ. (MHz)	EMISSION LEVEL (dBuV/m)	LIMIT (dBuV/m)	MARGIN (dB)	ANTENNA HEIGHT (m)	TABLE ANGLE (Degree)	RAW VALUE (dBuV)	CORRECTION FACTOR (dB/m)
1	5150.00	58.2 PK	74.0	-15.8	1.75 H	323	56.6	1.6
2	5150.00	46.1 AV	54.0	-7.9	1.75 H	323	44.5	1.6
3	*5230.00	107.5 PK			1.72 H	328	105.7	1.8
4	*5230.00	96.4 AV			1.72 H	328	94.6	1.8
5	5350.00	55.1 PK	74.0	-18.9	1.80 H	334	53.0	2.1
6	5350.00	43.6 AV	54.0	-10.4	1.80 H	334	41.5	2.1
7	#10460.00	50.6 PK	74.0	-23.4	1.78 H	258	38.5	12.1
8	#10460.00	37.5 AV	54.0	-16.5	1.78 H	258	25.4	12.1
9	15690.00	52.4 PK	74.0	-21.6	1.88 H	166	39.2	13.2
10	15690.00	39.6 AV	54.0	-14.4	1.88 H	166	26.4	13.2

ANTENNA POLARITY & TEST DISTANCE: VERTICAL AT 3 M

NO.	FREQ. (MHz)	EMISSION LEVEL (dBuV/m)	LIMIT (dBuV/m)	MARGIN (dB)	ANTENNA HEIGHT (m)	TABLE ANGLE (Degree)	RAW VALUE (dBuV)	CORRECTION FACTOR (dB/m)
1	5150.00	64.3 PK	74.0	-9.7	1.23 V	149	62.7	1.6
2	5150.00	53.0 AV	54.0	-1.0	1.23 V	149	51.4	1.6
3	*5230.00	119.4 PK			1.23 V	158	117.6	1.8
4	*5230.00	108.1 AV			1.23 V	158	106.3	1.8
5	5350.00	62.0 PK	74.0	-12.0	1.18 V	166	59.9	2.1
6	5350.00	49.5 AV	54.0	-4.5	1.18 V	166	47.4	2.1
7	#10460.00	50.6 PK	74.0	-23.4	1.23 V	115	38.5	12.1
8	#10460.00	37.7 AV	54.0	-16.3	1.23 V	115	25.6	12.1
9	15690.00	53.5 PK	74.0	-20.5	1.54 V	3	40.3	13.2
10	15690.00	40.5 AV	54.0	-13.5	1.54 V	3	27.3	13.2

REMARKS:

- Emission Level(dBuV/m) = Raw Value(dBuV) + Correction Factor(dB/m)
- Correction Factor(dB/m) = Antenna Factor(dB/m) + Cable Factor(dB) – Pre-Amplifier Factor(dB)
- The other emission levels were very low against the limit.
- Margin value = Emission Level – Limit value
- " * ": Fundamental frequency.
- " # ": The radiated frequency is out of the restricted band.

CHANNEL	TX Channel 151	DETECTOR FUNCTION	Peak (PK)
FREQUENCY RANGE	1GHz ~ 40GHz		Average (AV)

ANTENNA POLARITY & TEST DISTANCE: HORIZONTAL AT 3 M

NO.	FREQ. (MHz)	EMISSION LEVEL (dBuV/m)	LIMIT (dBuV/m)	MARGIN (dB)	ANTENNA HEIGHT (m)	TABLE ANGLE (Degree)	RAW VALUE (dBuV)	CORRECTION FACTOR (dB/m)
1	#5609.37	63.0 PK	68.2	-5.2	1.80 H	312	60.4	2.6
2	*5755.00	109.2 PK			1.80 H	312	106.3	2.9
3	*5755.00	97.3 AV			1.80 H	312	94.4	2.9
4	#5959.45	63.3 PK	68.2	-4.9	1.80 H	312	60.1	3.2
5	11510.00	52.4 PK	74.0	-21.6	2.35 H	201	38.9	13.5
6	11510.00	39.9 AV	54.0	-14.1	2.35 H	201	26.4	13.5
7	#17265.00	56.3 PK	74.0	-17.7	1.86 H	69	37.8	18.5
8	#17265.00	43.1 AV	54.0	-10.9	1.86 H	69	24.6	18.5

ANTENNA POLARITY & TEST DISTANCE: VERTICAL AT 3 M

NO.	FREQ. (MHz)	EMISSION LEVEL (dBuV/m)	LIMIT (dBuV/m)	MARGIN (dB)	ANTENNA HEIGHT (m)	TABLE ANGLE (Degree)	RAW VALUE (dBuV)	CORRECTION FACTOR (dB/m)
1	#5579.93	64.3 PK	68.2	-3.9	1.69 V	138	61.8	2.5
2	*5755.00	121.1 PK			1.69 V	138	118.2	2.9
3	*5755.00	109.5 AV			1.69 V	138	106.6	2.9
4	#5945.20	62.8 PK	68.2	-5.4	1.69 V	138	59.7	3.1
5	11510.00	51.8 PK	74.0	-22.2	3.01 V	196	38.3	13.5
6	11510.00	40.0 AV	54.0	-14.0	3.01 V	196	26.5	13.5
7	#17265.00	56.2 PK	74.0	-17.8	1.66 V	68	37.7	18.5
8	#17265.00	42.9 AV	54.0	-11.1	1.66 V	68	24.4	18.5

REMARKS:

1. Emission Level(dBuV/m) = Raw Value(dBuV) + Correction Factor(dB/m)
2. Correction Factor(dB/m) = Antenna Factor(dB/m) + Cable Factor(dB) – Pre-Amplifier Factor(dB)
3. The other emission levels were very low against the limit.
4. Margin value = Emission Level – Limit value
5. " * ": Fundamental frequency.
6. " # ": The radiated frequency is out of the restricted band.

CHANNEL	TX Channel 159	DETECTOR FUNCTION	Peak (PK)
FREQUENCY RANGE	1GHz ~ 40GHz		Average (AV)

ANTENNA POLARITY & TEST DISTANCE: HORIZONTAL AT 3 M

NO.	FREQ. (MHz)	EMISSION LEVEL (dBuV/m)	LIMIT (dBuV/m)	MARGIN (dB)	ANTENNA HEIGHT (m)	TABLE ANGLE (Degree)	RAW VALUE (dBuV)	CORRECTION FACTOR (dB/m)
1	#5578.98	61.8 PK	68.2	-6.4	1.77 H	314	59.3	2.5
2	*5795.00	109.6 PK			1.77 H	314	106.7	2.9
3	*5795.00	97.2 AV			1.77 H	314	94.3	2.9
4	#5949.48	61.4 PK	68.2	-6.8	1.77 H	314	58.2	3.2
5	11590.00	52.4 PK	74.0	-21.6	2.50 H	214	39.3	13.1
6	11590.00	39.6 AV	54.0	-14.4	2.50 H	214	26.5	13.1
7	#17385.00	56.3 PK	74.0	-17.7	1.87 H	91	37.0	19.3
8	#17385.00	43.9 AV	54.0	-10.1	1.87 H	91	24.6	19.3

ANTENNA POLARITY & TEST DISTANCE: VERTICAL AT 3 M

NO.	FREQ. (MHz)	EMISSION LEVEL (dBuV/m)	LIMIT (dBuV/m)	MARGIN (dB)	ANTENNA HEIGHT (m)	TABLE ANGLE (Degree)	RAW VALUE (dBuV)	CORRECTION FACTOR (dB/m)
1	#5630.27	65.9 PK	68.2	-2.3	1.71 V	153	63.3	2.6
2	*5795.00	120.4 PK			1.71 V	153	117.5	2.9
3	*5795.00	109.1 AV			1.71 V	153	106.2	2.9
4	#5941.40	65.8 PK	68.2	-2.4	1.71 V	153	62.7	3.1
5	11590.00	52.8 PK	74.0	-21.2	3.06 V	219	39.7	13.1
6	11590.00	40.8 AV	54.0	-13.2	3.06 V	219	27.7	13.1
7	#17385.00	56.0 PK	74.0	-18.0	1.61 V	52	36.7	19.3
8	#17385.00	43.0 AV	54.0	-11.0	1.61 V	52	23.7	19.3

REMARKS:

1. Emission Level(dBuV/m) = Raw Value(dBuV) + Correction Factor(dB/m)
2. Correction Factor(dB/m) = Antenna Factor(dB/m) + Cable Factor(dB) – Pre-Amplifier Factor(dB)
3. The other emission levels were very low against the limit.
4. Margin value = Emission Level – Limit value
5. " * ": Fundamental frequency.
6. " # ": The radiated frequency is out of the restricted band.

802.11ac (VHT80)

CHANNEL	TX Channel 42	DETECTOR FUNCTION	Peak (PK)
FREQUENCY RANGE	1GHz ~ 40GHz		Average (AV)

ANTENNA POLARITY & TEST DISTANCE: HORIZONTAL AT 3 M

NO.	FREQ. (MHz)	EMISSION LEVEL (dBuV/m)	LIMIT (dBuV/m)	MARGIN (dB)	ANTENNA HEIGHT (m)	TABLE ANGLE (Degree)	RAW VALUE (dBuV)	CORRECTION FACTOR (dB/m)
1	5150.00	57.3 PK	74.0	-16.7	1.75 H	317	55.7	1.6
2	5150.00	45.0 AV	54.0	-9.0	1.75 H	317	43.4	1.6
3	*5210.00	96.8 PK			1.77 H	325	95.0	1.8
4	*5210.00	84.0 AV			1.77 H	325	82.2	1.8
5	5350.00	51.0 PK	74.0	-23.0	1.78 H	327	48.9	2.1
6	5350.00	38.4 AV	54.0	-15.6	1.78 H	327	36.3	2.1
7	#10420.00	51.4 PK	74.0	-22.6	1.82 H	217	39.4	12.0
8	#10420.00	38.2 AV	54.0	-15.8	1.82 H	217	26.2	12.0
9	15630.00	54.1 PK	74.0	-19.9	1.76 H	121	40.8	13.3
10	15630.00	40.6 AV	54.0	-13.4	1.76 H	121	27.3	13.3

ANTENNA POLARITY & TEST DISTANCE: VERTICAL AT 3 M

NO.	FREQ. (MHz)	EMISSION LEVEL (dBuV/m)	LIMIT (dBuV/m)	MARGIN (dB)	ANTENNA HEIGHT (m)	TABLE ANGLE (Degree)	RAW VALUE (dBuV)	CORRECTION FACTOR (dB/m)
1	5150.00	66.1 PK	74.0	-7.9	1.08 V	162	64.5	1.6
2	5150.00	53.5 AV	54.0	-0.5	1.08 V	162	51.9	1.6
3	*5210.00	110.2 PK			1.04 V	137	108.4	1.8
4	*5210.00	97.0 AV			1.04 V	137	95.2	1.8
5	5350.00	54.9 PK	74.0	-19.1	1.06 V	135	52.8	2.1
6	5350.00	43.6 AV	54.0	-10.4	1.06 V	135	41.5	2.1
7	#10420.00	50.8 PK	74.0	-23.2	1.19 V	132	38.8	12.0
8	#10420.00	37.8 AV	54.0	-16.2	1.19 V	132	25.8	12.0
9	15630.00	53.6 PK	74.0	-20.4	1.57 V	0	40.3	13.3
10	15630.00	40.2 AV	54.0	-13.8	1.57 V	0	26.9	13.3

REMARKS:

- Emission Level(dBuV/m) = Raw Value(dBuV) + Correction Factor(dB/m)
- Correction Factor(dB/m) = Antenna Factor(dB/m) + Cable Factor(dB) – Pre-Amplifier Factor(dB)
- The other emission levels were very low against the limit.
- Margin value = Emission Level – Limit value
- " * ": Fundamental frequency.
- " # ": The radiated frequency is out of the restricted band.

CHANNEL	TX Channel 155	DETECTOR FUNCTION	Peak (PK)
FREQUENCY RANGE	1GHz ~ 40GHz		Average (AV)

ANTENNA POLARITY & TEST DISTANCE: HORIZONTAL AT 3 M

NO.	FREQ. (MHz)	EMISSION LEVEL (dBuV/m)	LIMIT (dBuV/m)	MARGIN (dB)	ANTENNA HEIGHT (m)	TABLE ANGLE (Degree)	RAW VALUE (dBuV)	CORRECTION FACTOR (dB/m)
1	#5626.48	62.6 PK	68.2	-5.6	1.80 H	328	60.0	2.6
2	*5775.00	105.8 PK			1.80 H	328	102.9	2.9
3	*5775.00	94.0 AV			1.80 H	328	91.1	2.9
4	#5949.95	63.2 PK	68.2	-5.0	1.80 H	328	60.0	3.2
5	11550.00	53.1 PK	74.0	-20.9	2.38 H	223	39.8	13.3
6	11550.00	40.5 AV	54.0	-13.5	2.38 H	223	27.2	13.3
7	#17325.00	57.2 PK	74.0	-16.8	1.97 H	96	38.3	18.9
8	#17325.00	44.0 AV	54.0	-10.0	1.97 H	96	25.1	18.9

ANTENNA POLARITY & TEST DISTANCE: VERTICAL AT 3 M

NO.	FREQ. (MHz)	EMISSION LEVEL (dBuV/m)	LIMIT (dBuV/m)	MARGIN (dB)	ANTENNA HEIGHT (m)	TABLE ANGLE (Degree)	RAW VALUE (dBuV)	CORRECTION FACTOR (dB/m)
1	#5638.82	67.1 PK	68.2	-1.1	1.38 V	159	64.5	2.6
2	*5775.00	117.3 PK			1.38 V	159	114.4	2.9
3	*5775.00	106.2 AV			1.38 V	159	103.3	2.9
4	#5921.45	64.7 PK	70.8	-6.1	1.38 V	159	61.6	3.1
5	11550.00	52.5 PK	74.0	-21.5	2.91 V	217	39.2	13.3
6	11550.00	40.4 AV	54.0	-13.6	2.91 V	217	27.1	13.3
7	#17325.00	57.0 PK	74.0	-17.0	1.71 V	55	38.1	18.9
8	#17325.00	43.6 AV	54.0	-10.4	1.71 V	55	24.7	18.9

REMARKS:

1. Emission Level(dBuV/m) = Raw Value(dBuV) + Correction Factor(dB/m)
2. Correction Factor(dB/m) = Antenna Factor(dB/m) + Cable Factor(dB) – Pre-Amplifier Factor(dB)
3. The other emission levels were very low against the limit.
4. Margin value = Emission Level – Limit value
5. " * ": Fundamental frequency.
6. " # ": The radiated frequency is out of the restricted band.

Below 1GHz Data:

802.11ac (VHT40)

CHANNEL	TX Channel 159	DETECTOR FUNCTION	Quasi-Peak (QP)
FREQUENCY RANGE	below 1GHz		

ANTENNA POLARITY & TEST DISTANCE: HORIZONTAL AT 3 M

NO.	FREQ. (MHz)	EMISSION LEVEL (dBuV/m)	LIMIT (dBuV/m)	MARGIN (dB)	ANTENNA HEIGHT (m)	TABLE ANGLE (Degree)	RAW VALUE (dBuV)	CORRECTION FACTOR (dB/m)
1	30.32	32.59 QP	40.00	-7.41	1.50 H	360	42.44	-9.85
2	130.10	29.37 QP	43.50	-14.13	1.50 H	81	39.19	-9.82
3	251.38	34.77 QP	46.00	-11.23	1.00 H	277	44.67	-9.90
4	276.26	37.06 QP	46.00	-8.94	1.00 H	78	45.67	-8.61
5	613.33	32.04 QP	46.00	-13.96	1.50 H	46	32.33	-0.29
6	713.83	31.90 QP	46.00	-14.10	1.00 H	52	31.02	0.88

ANTENNA POLARITY & TEST DISTANCE: VERTICAL AT 3 M

NO.	FREQ. (MHz)	EMISSION LEVEL (dBuV/m)	LIMIT (dBuV/m)	MARGIN (dB)	ANTENNA HEIGHT (m)	TABLE ANGLE (Degree)	RAW VALUE (dBuV)	CORRECTION FACTOR (dB/m)
1	30.05	31.73 QP	40.00	-8.27	1.00 V	42	41.57	-9.84
2	62.20	29.29 QP	40.00	-10.71	1.00 V	65	38.89	-9.60
3	82.36	29.80 QP	40.00	-10.20	1.00 V	334	43.83	-14.03
4	187.87	32.75 QP	43.50	-10.75	1.00 V	352	44.01	-11.26
5	274.63	33.15 QP	46.00	-12.85	1.50 V	41	41.83	-8.68
6	606.45	30.48 QP	46.00	-15.52	1.00 V	146	30.91	-0.43

REMARKS:

1. Emission Level(dBuV/m) = Raw Value(dBuV) + Correction Factor(dB/m)
2. Correction Factor(dB/m) = Antenna Factor(dB/m) + Cable Factor(dB) – Pre-Amplifier Factor(dB)
3. The other emission levels were very low against the limit.
4. Margin value = Emission Level – Limit value

4.1.8 Test Results (Mode 2)

Above 1GHz Data:

802.11a

CHANNEL	TX Channel 36	DETECTOR FUNCTION	Peak (PK)
FREQUENCY RANGE	1GHz ~ 40GHz		Average (AV)

ANTENNA POLARITY & TEST DISTANCE: HORIZONTAL AT 3 M

NO.	FREQ. (MHz)	EMISSION LEVEL (dBuV/m)	LIMIT (dBuV/m)	MARGIN (dB)	ANTENNA HEIGHT (m)	TABLE ANGLE (Degree)	RAW VALUE (dBuV)	CORRECTION FACTOR (dB/m)
1	5147.30	52.60 PK	74.00	-21.40	1.67 H	315	51.00	1.60
2	5147.30	41.30 AV	54.00	-12.70	1.67 H	315	39.70	1.60
3	*5180.00	108.60 PK			1.67 H	315	106.90	1.70
4	*5180.00	98.30 AV			1.67 H	315	96.60	1.70
5	#10360.00	56.10 PK	74.00	-17.90	1.82 H	248	44.40	11.70
6	#10360.00	43.10 AV	54.00	-10.90	1.82 H	248	31.40	11.70
7	15540.00	56.10 PK	74.00	-17.90	1.84 H	146	42.80	13.30
8	15540.00	42.40 AV	54.00	-11.60	1.84 H	146	29.10	13.30

ANTENNA POLARITY & TEST DISTANCE: VERTICAL AT 3 M

NO.	FREQ. (MHz)	EMISSION LEVEL (dBuV/m)	LIMIT (dBuV/m)	MARGIN (dB)	ANTENNA HEIGHT (m)	TABLE ANGLE (Degree)	RAW VALUE (dBuV)	CORRECTION FACTOR (dB/m)
1	5147.30	67.90 PK	74.00	-6.10	1.52 V	337	66.30	1.60
2	5147.30	52.20 AV	54.00	-1.80	1.52 V	337	50.60	1.60
3	*5180.00	119.50 PK			1.52 V	337	117.80	1.70
4	*5180.00	110.10 AV			1.52 V	337	108.40	1.70
5	#10360.00	57.90 PK	74.00	-16.10	1.22 V	144	46.20	11.70
6	#10360.00	44.20 AV	54.00	-9.80	1.22 V	144	32.50	11.70
7	15540.00	57.00 PK	74.00	-17.00	1.54 V	13	43.70	13.30
8	15540.00	43.20 AV	54.00	-10.80	1.54 V	13	29.90	13.30

REMARKS:

- Emission Level(dBuV/m) = Raw Value(dBuV) + Correction Factor(dB/m)
- Correction Factor(dB/m) = Antenna Factor(dB/m) + Cable Factor(dB) – Pre-Amplifier Factor(dB)
- The other emission levels were very low against the limit.
- Margin value = Emission Level – Limit value
- " * ": Fundamental frequency.
- " # ": The radiated frequency is out of the restricted band.

CHANNEL	TX Channel 40	DETECTOR FUNCTION	Peak (PK)
FREQUENCY RANGE	1GHz ~ 40GHz		Average (AV)

ANTENNA POLARITY & TEST DISTANCE: HORIZONTAL AT 3 M

NO.	FREQ. (MHz)	EMISSION LEVEL (dBuV/m)	LIMIT (dBuV/m)	MARGIN (dB)	ANTENNA HEIGHT (m)	TABLE ANGLE (Degree)	RAW VALUE (dBuV)	CORRECTION FACTOR (dB/m)
1	*5200.00	108.70 PK			1.66 H	300	106.90	1.80
2	*5200.00	98.20 AV			1.66 H	300	96.40	1.80
3	#10400.00	55.80 PK	74.00	-18.20	1.79 H	253	43.90	11.90
4	#10400.00	42.70 AV	54.00	-11.30	1.79 H	253	30.80	11.90
5	15600.00	56.50 PK	74.00	-17.50	1.83 H	144	43.20	13.30
6	15600.00	42.60 AV	54.00	-11.40	1.83 H	144	29.30	13.30

ANTENNA POLARITY & TEST DISTANCE: VERTICAL AT 3 M

NO.	FREQ. (MHz)	EMISSION LEVEL (dBuV/m)	LIMIT (dBuV/m)	MARGIN (dB)	ANTENNA HEIGHT (m)	TABLE ANGLE (Degree)	RAW VALUE (dBuV)	CORRECTION FACTOR (dB/m)
1	*5200.00	120.00 PK			1.51 V	346	118.20	1.80
2	*5200.00	110.40 AV			1.51 V	346	108.60	1.80
3	#10400.00	57.80 PK	74.00	-16.20	1.23 V	136	45.90	11.90
4	#10400.00	44.00 AV	54.00	-10.00	1.23 V	136	32.10	11.90
5	15600.00	56.80 PK	74.00	-17.20	1.57 V	27	43.50	13.30
6	15600.00	43.00 AV	54.00	-11.00	1.57 V	27	29.70	13.30

REMARKS:

1. Emission Level(dBuV/m) = Raw Value(dBuV) + Correction Factor(dB/m)
2. Correction Factor(dB/m) = Antenna Factor(dB/m) + Cable Factor(dB) – Pre-Amplifier Factor(dB)
3. The other emission levels were very low against the limit.
4. Margin value = Emission Level – Limit value
5. " * ": Fundamental frequency.
6. " # ": The radiated frequency is out of the restricted band.

CHANNEL	TX Channel 48	DETECTOR FUNCTION	Peak (PK)
FREQUENCY RANGE	1GHz ~ 40GHz		Average (AV)

ANTENNA POLARITY & TEST DISTANCE: HORIZONTAL AT 3 M

NO.	FREQ. (MHz)	EMISSION LEVEL (dBuV/m)	LIMIT (dBuV/m)	MARGIN (dB)	ANTENNA HEIGHT (m)	TABLE ANGLE (Degree)	RAW VALUE (dBuV)	CORRECTION FACTOR (dB/m)
1	5150.00	52.80 PK	74.00	-21.20	1.67 H	316	51.20	1.60
2	5150.00	39.90 AV	54.00	-14.10	1.67 H	316	38.30	1.60
3	*5240.00	108.50 PK			1.67 H	316	106.70	1.80
4	*5240.00	98.50 AV			1.67 H	316	96.70	1.80
5	5350.00	52.70 PK	74.00	-21.30	1.67 H	316	50.60	2.10
6	5350.00	40.10 AV	54.00	-13.90	1.67 H	316	38.00	2.10
7	#10480.00	56.20 PK	74.00	-17.80	1.88 H	244	44.00	12.20
8	#10480.00	43.30 AV	54.00	-10.70	1.88 H	244	31.10	12.20
9	15720.00	56.00 PK	74.00	-18.00	1.78 H	150	42.80	13.20
10	15720.00	42.10 AV	54.00	-11.90	1.78 H	150	28.90	13.20

ANTENNA POLARITY & TEST DISTANCE: VERTICAL AT 3 M

NO.	FREQ. (MHz)	EMISSION LEVEL (dBuV/m)	LIMIT (dBuV/m)	MARGIN (dB)	ANTENNA HEIGHT (m)	TABLE ANGLE (Degree)	RAW VALUE (dBuV)	CORRECTION FACTOR (dB/m)
1	5150.00	56.30 PK	74.00	-17.70	1.42 V	338	54.70	1.60
2	5150.00	45.20 AV	54.00	-8.80	1.42 V	338	43.60	1.60
3	*5240.00	120.10 PK			1.48 V	325	118.30	1.80
4	*5240.00	110.50 AV			1.48 V	325	108.70	1.80
5	5350.00	54.20 PK	74.00	-19.80	1.42 V	338	52.10	2.10
6	5350.00	43.10 AV	54.00	-10.90	1.42 V	338	41.00	2.10
7	#10480.00	57.80 PK	74.00	-16.20	1.21 V	140	45.60	12.20
8	#10480.00	44.20 AV	54.00	-9.80	1.21 V	140	32.00	12.20
9	15720.00	56.50 PK	74.00	-17.50	1.50 V	28	43.30	13.20
10	15720.00	42.70 AV	54.00	-11.30	1.50 V	28	29.50	13.20

REMARKS:

1. Emission Level(dBuV/m) = Raw Value(dBuV) + Correction Factor(dB/m)
2. Correction Factor(dB/m) = Antenna Factor(dB/m) + Cable Factor(dB) – Pre-Amplifier Factor(dB)
3. The other emission levels were very low against the limit.
4. Margin value = Emission Level – Limit value
5. " * ": Fundamental frequency.
6. " # ": The radiated frequency is out of the restricted band.

CHANNEL	TX Channel 149	DETECTOR FUNCTION	Peak (PK)
FREQUENCY RANGE	1GHz ~ 40GHz		Average (AV)

ANTENNA POLARITY & TEST DISTANCE: HORIZONTAL AT 3 M

NO.	FREQ. (MHz)	EMISSION LEVEL (dBuV/m)	LIMIT (dBuV/m)	MARGIN (dB)	ANTENNA HEIGHT (m)	TABLE ANGLE (Degree)	RAW VALUE (dBuV)	CORRECTION FACTOR (dB/m)
1	#5608.43	59.60 PK	68.20	-8.60	1.76 H	321	57.00	2.60
2	*5745.00	113.50 PK			1.76 H	321	110.70	2.80
3	*5745.00	101.70 AV			1.76 H	321	98.90	2.80
4	#5940.93	59.60 PK	68.20	-8.60	1.76 H	321	56.50	3.10
5	11490.00	52.40 PK	74.00	-21.60	2.43 H	188	38.90	13.50
6	11490.00	40.00 AV	54.00	-14.00	2.43 H	188	26.50	13.50
7	#17235.00	57.20 PK	74.00	-16.80	1.92 H	74	38.80	18.40
8	#17235.00	44.30 AV	54.00	-9.70	1.92 H	74	25.90	18.40

ANTENNA POLARITY & TEST DISTANCE: VERTICAL AT 3 M

NO.	FREQ. (MHz)	EMISSION LEVEL (dBuV/m)	LIMIT (dBuV/m)	MARGIN (dB)	ANTENNA HEIGHT (m)	TABLE ANGLE (Degree)	RAW VALUE (dBuV)	CORRECTION FACTOR (dB/m)
1	#5623.15	62.70 PK	68.20	-5.50	1.58 V	128	60.10	2.60
2	*5745.00	124.30 PK			1.58 V	128	121.50	2.80
3	*5745.00	113.40 AV			1.58 V	128	110.60	2.80
4	#5991.75	64.10 PK	68.20	-4.10	1.58 V	128	60.70	3.40
5	11490.00	57.00 PK	74.00	-17.00	3.26 V	189	43.50	13.50
6	11490.00	43.60 AV	54.00	-10.40	3.26 V	189	30.10	13.50
7	#17235.00	56.90 PK	74.00	-17.10	1.66 V	3	38.50	18.40
8	#17235.00	44.90 AV	54.00	-9.10	1.66 V	3	26.50	18.40

REMARKS:

1. Emission Level(dBuV/m) = Raw Value(dBuV) + Correction Factor(dB/m)
2. Correction Factor(dB/m) = Antenna Factor(dB/m) + Cable Factor(dB) – Pre-Amplifier Factor(dB)
3. The other emission levels were very low against the limit.
4. Margin value = Emission Level – Limit value
5. " * ": Fundamental frequency.
6. " # ": The radiated frequency is out of the restricted band.

CHANNEL	TX Channel 157	DETECTOR FUNCTION	Peak (PK)
FREQUENCY RANGE	1GHz ~ 40GHz		Average (AV)

ANTENNA POLARITY & TEST DISTANCE: HORIZONTAL AT 3 M

NO.	FREQ. (MHz)	EMISSION LEVEL (dBuV/m)	LIMIT (dBuV/m)	MARGIN (dB)	ANTENNA HEIGHT (m)	TABLE ANGLE (Degree)	RAW VALUE (dBuV)	CORRECTION FACTOR (dB/m)
1	#5626.95	61.30 PK	68.20	-6.90	1.72 H	322	58.70	2.60
2	*5785.00	113.10 PK			1.72 H	322	110.20	2.90
3	*5785.00	101.30 AV			1.72 H	322	98.40	2.90
4	#5967.52	62.00 PK	68.20	-6.20	1.72 H	322	58.80	3.20
5	11570.00	52.10 PK	74.00	-21.90	2.49 H	199	38.90	13.20
6	11570.00	39.60 AV	54.00	-14.40	2.49 H	199	26.40	13.20
7	#17355.00	57.20 PK	74.00	-16.80	1.94 H	71	38.10	19.10
8	#17355.00	44.30 AV	54.00	-9.70	1.94 H	71	25.20	19.10

ANTENNA POLARITY & TEST DISTANCE: VERTICAL AT 3 M

NO.	FREQ. (MHz)	EMISSION LEVEL (dBuV/m)	LIMIT (dBuV/m)	MARGIN (dB)	ANTENNA HEIGHT (m)	TABLE ANGLE (Degree)	RAW VALUE (dBuV)	CORRECTION FACTOR (dB/m)
1	#5620.30	61.90 PK	68.20	-6.30	1.56 V	127	59.30	2.60
2	*5785.00	124.30 PK			1.56 V	127	121.40	2.90
3	*5785.00	113.60 AV			1.56 V	127	110.70	2.90
4	#5949.00	62.00 PK	68.20	-6.20	1.56 V	127	58.80	3.20
5	11570.00	57.40 PK	74.00	-16.60	3.21 V	195	44.20	13.20
6	11570.00	43.80 AV	54.00	-10.20	3.21 V	195	30.60	13.20
7	#17355.00	57.10 PK	74.00	-16.90	1.71 V	11	38.00	19.10
8	#17355.00	45.20 AV	54.00	-8.80	1.71 V	11	26.10	19.10

REMARKS:

1. Emission Level(dBuV/m) = Raw Value(dBuV) + Correction Factor(dB/m)
2. Correction Factor(dB/m) = Antenna Factor(dB/m) + Cable Factor(dB) – Pre-Amplifier Factor(dB)
3. The other emission levels were very low against the limit.
4. Margin value = Emission Level – Limit value
5. " * ": Fundamental frequency.
6. " # ": The radiated frequency is out of the restricted band.

CHANNEL	TX Channel 165	DETECTOR FUNCTION	Peak (PK)
FREQUENCY RANGE	1GHz ~ 40GHz		Average (AV)

ANTENNA POLARITY & TEST DISTANCE: HORIZONTAL AT 3 M

NO.	FREQ. (MHz)	EMISSION LEVEL (dBuV/m)	LIMIT (dBuV/m)	MARGIN (dB)	ANTENNA HEIGHT (m)	TABLE ANGLE (Degree)	RAW VALUE (dBuV)	CORRECTION FACTOR (dB/m)
1	#5620.77	60.30 PK	68.20	-7.90	1.77 H	313	57.70	2.60
2	*5825.00	112.80 PK			1.77 H	313	109.90	2.90
3	*5825.00	101.00 AV			1.77 H	313	98.10	2.90
4	#5979.87	62.40 PK	68.20	-5.80	1.77 H	313	59.10	3.30
5	11650.00	52.50 PK	74.00	-21.50	2.40 H	201	39.30	13.20
6	11650.00	39.60 AV	54.00	-14.40	2.40 H	201	26.40	13.20
7	#17475.00	56.80 PK	74.00	-17.20	1.94 H	66	37.40	19.40
8	#17475.00	43.80 AV	54.00	-10.20	1.94 H	66	24.40	19.40

ANTENNA POLARITY & TEST DISTANCE: VERTICAL AT 3 M

NO.	FREQ. (MHz)	EMISSION LEVEL (dBuV/m)	LIMIT (dBuV/m)	MARGIN (dB)	ANTENNA HEIGHT (m)	TABLE ANGLE (Degree)	RAW VALUE (dBuV)	CORRECTION FACTOR (dB/m)
1	#5588.95	64.10 PK	68.20	-4.10	1.62 V	131	61.60	2.50
2	*5825.00	123.70 PK			1.62 V	131	120.80	2.90
3	*5825.00	113.40 AV			1.62 V	131	110.50	2.90
4	#5977.50	62.00 PK	68.20	-6.20	1.62 V	131	58.80	3.20
5	11650.00	57.20 PK	74.00	-16.80	3.18 V	210	44.00	13.20
6	11650.00	44.00 AV	54.00	-10.00	3.18 V	210	30.80	13.20
7	#17475.00	56.90 PK	74.00	-17.10	1.74 V	17	37.50	19.40
8	#17475.00	44.80 AV	54.00	-9.20	1.74 V	17	25.40	19.40

REMARKS:

1. Emission Level(dBuV/m) = Raw Value(dBuV) + Correction Factor(dB/m)
2. Correction Factor(dB/m) = Antenna Factor(dB/m) + Cable Factor(dB) – Pre-Amplifier Factor(dB)
3. The other emission levels were very low against the limit.
4. Margin value = Emission Level – Limit value
5. " * ": Fundamental frequency.
6. " # ": The radiated frequency is out of the restricted band.

802.11ac (VHT20)

CHANNEL	TX Channel 36	DETECTOR FUNCTION	Peak (PK)
FREQUENCY RANGE	1GHz ~ 40GHz		Average (AV)

ANTENNA POLARITY & TEST DISTANCE: HORIZONTAL AT 3 M

NO.	FREQ. (MHz)	EMISSION LEVEL (dBuV/m)	LIMIT (dBuV/m)	MARGIN (dB)	ANTENNA HEIGHT (m)	TABLE ANGLE (Degree)	RAW VALUE (dBuV)	CORRECTION FACTOR (dB/m)
1	5150.00	53.40 PK	74.00	-20.60	1.61 H	327	51.80	1.60
2	5150.00	41.80 AV	54.00	-12.20	1.61 H	327	40.20	1.60
3	*5180.00	108.40 PK			1.61 H	327	106.70	1.70
4	*5180.00	98.10 AV			1.61 H	327	96.40	1.70
5	#10360.00	55.80 PK	74.00	-18.20	1.86 H	239	44.10	11.70
6	#10360.00	42.90 AV	54.00	-11.10	1.86 H	239	31.20	11.70
7	15540.00	56.10 PK	74.00	-17.90	1.84 H	153	42.80	13.30
8	15540.00	42.30 AV	54.00	-11.70	1.84 H	153	29.00	13.30

ANTENNA POLARITY & TEST DISTANCE: VERTICAL AT 3 M

NO.	FREQ. (MHz)	EMISSION LEVEL (dBuV/m)	LIMIT (dBuV/m)	MARGIN (dB)	ANTENNA HEIGHT (m)	TABLE ANGLE (Degree)	RAW VALUE (dBuV)	CORRECTION FACTOR (dB/m)
1	5150.00	68.10 PK	74.00	-5.90	1.51 V	330	66.50	1.60
2	5150.00	52.50 AV	54.00	-1.50	1.51 V	330	50.90	1.60
3	*5180.00	120.00 PK			1.51 V	330	118.30	1.70
4	*5180.00	110.40 AV			1.51 V	330	108.70	1.70
5	#10360.00	57.30 PK	74.00	-16.70	1.26 V	153	45.60	11.70
6	#10360.00	43.90 AV	54.00	-10.10	1.26 V	153	32.20	11.70
7	15540.00	57.10 PK	74.00	-16.90	1.50 V	27	43.80	13.30
8	15540.00	43.20 AV	54.00	-10.80	1.50 V	27	29.90	13.30

REMARKS:

- Emission Level(dBuV/m) = Raw Value(dBuV) + Correction Factor(dB/m)
- Correction Factor(dB/m) = Antenna Factor(dB/m) + Cable Factor(dB) – Pre-Amplifier Factor(dB)
- The other emission levels were very low against the limit.
- Margin value = Emission Level – Limit value
- " * ": Fundamental frequency.
- " # ": The radiated frequency is out of the restricted band.

CHANNEL	TX Channel 40	DETECTOR FUNCTION	Peak (PK)
FREQUENCY RANGE	1GHz ~ 40GHz		Average (AV)

ANTENNA POLARITY & TEST DISTANCE: HORIZONTAL AT 3 M

NO.	FREQ. (MHz)	EMISSION LEVEL (dBuV/m)	LIMIT (dBuV/m)	MARGIN (dB)	ANTENNA HEIGHT (m)	TABLE ANGLE (Degree)	RAW VALUE (dBuV)	CORRECTION FACTOR (dB/m)
1	*5200.00	108.80 PK			1.65 H	324	107.00	1.80
2	*5200.00	98.60 AV			1.65 H	324	96.80	1.80
3	#10400.00	55.90 PK	74.00	-18.10	1.83 H	249	44.00	11.90
4	#10400.00	43.00 AV	54.00	-11.00	1.83 H	249	31.10	11.90
5	15600.00	56.60 PK	74.00	-17.40	1.89 H	153	43.30	13.30
6	15600.00	42.70 AV	54.00	-11.30	1.89 H	153	29.40	13.30

ANTENNA POLARITY & TEST DISTANCE: VERTICAL AT 3 M

NO.	FREQ. (MHz)	EMISSION LEVEL (dBuV/m)	LIMIT (dBuV/m)	MARGIN (dB)	ANTENNA HEIGHT (m)	TABLE ANGLE (Degree)	RAW VALUE (dBuV)	CORRECTION FACTOR (dB/m)
1	*5200.00	119.90 PK			1.52 V	344	118.10	1.80
2	*5200.00	110.40 AV			1.52 V	344	108.60	1.80
3	#10400.00	57.90 PK	74.00	-16.10	1.22 V	159	46.00	11.90
4	#10400.00	44.20 AV	54.00	-9.80	1.22 V	159	32.30	11.90
5	15600.00	56.70 PK	74.00	-17.30	1.49 V	17	43.40	13.30
6	15600.00	43.20 AV	54.00	-10.80	1.49 V	17	29.90	13.30

REMARKS:

1. Emission Level(dBuV/m) = Raw Value(dBuV) + Correction Factor(dB/m)
2. Correction Factor(dB/m) = Antenna Factor(dB/m) + Cable Factor(dB) – Pre-Amplifier Factor(dB)
3. The other emission levels were very low against the limit.
4. Margin value = Emission Level – Limit value
5. " * ": Fundamental frequency.
6. " # ": The radiated frequency is out of the restricted band.

CHANNEL	TX Channel 48	DETECTOR FUNCTION	Peak (PK)
FREQUENCY RANGE	1GHz ~ 40GHz		Average (AV)

ANTENNA POLARITY & TEST DISTANCE: HORIZONTAL AT 3 M

NO.	FREQ. (MHz)	EMISSION LEVEL (dBuV/m)	LIMIT (dBuV/m)	MARGIN (dB)	ANTENNA HEIGHT (m)	TABLE ANGLE (Degree)	RAW VALUE (dBuV)	CORRECTION FACTOR (dB/m)
1	5150.00	52.90 PK	74.00	-21.10	1.71 H	307	51.30	1.60
2	5150.00	40.10 AV	54.00	-13.90	1.71 H	307	38.50	1.60
3	*5240.00	108.20 PK			1.71 H	307	106.40	1.80
4	*5240.00	98.00 AV			1.71 H	307	96.20	1.80
5	5350.00	52.00 PK	74.00	-22.00	1.71 H	307	49.90	2.10
6	5350.00	39.60 AV	54.00	-14.40	1.71 H	307	37.50	2.10
7	#10480.00	56.50 PK	74.00	-17.50	1.82 H	244	44.30	12.20
8	#10480.00	43.50 AV	54.00	-10.50	1.82 H	244	31.30	12.20
9	15720.00	55.90 PK	74.00	-18.10	1.80 H	146	42.70	13.20
10	15720.00	42.10 AV	54.00	-11.90	1.80 H	146	28.90	13.20

ANTENNA POLARITY & TEST DISTANCE: VERTICAL AT 3 M

NO.	FREQ. (MHz)	EMISSION LEVEL (dBuV/m)	LIMIT (dBuV/m)	MARGIN (dB)	ANTENNA HEIGHT (m)	TABLE ANGLE (Degree)	RAW VALUE (dBuV)	CORRECTION FACTOR (dB/m)
1	5150.00	56.20 PK	74.00	-17.80	1.43 V	310	54.60	1.60
2	5150.00	45.10 AV	54.00	-8.90	1.43 V	310	43.50	1.60
3	*5240.00	120.50 PK			1.43 V	310	118.70	1.80
4	*5240.00	110.90 AV			1.43 V	310	109.10	1.80
5	5350.00	54.30 PK	74.00	-19.70	1.43 V	310	52.20	2.10
6	5350.00	42.90 AV	54.00	-11.10	1.43 V	310	40.80	2.10
7	#10480.00	57.80 PK	74.00	-16.20	1.19 V	135	45.60	12.20
8	#10480.00	44.10 AV	54.00	-9.90	1.19 V	135	31.90	12.20
9	15720.00	56.40 PK	74.00	-17.60	1.50 V	39	43.20	13.20
10	15720.00	42.60 AV	54.00	-11.40	1.50 V	39	29.40	13.20

REMARKS:

1. Emission Level(dBuV/m) = Raw Value(dBuV) + Correction Factor(dB/m)
2. Correction Factor(dB/m) = Antenna Factor(dB/m) + Cable Factor(dB) – Pre-Amplifier Factor(dB)
3. The other emission levels were very low against the limit.
4. Margin value = Emission Level – Limit value
5. " * ": Fundamental frequency.
6. " # ": The radiated frequency is out of the restricted band.

CHANNEL	TX Channel 149	DETECTOR FUNCTION	Peak (PK)
FREQUENCY RANGE	1GHz ~ 40GHz		Average (AV)

ANTENNA POLARITY & TEST DISTANCE: HORIZONTAL AT 3 M

NO.	FREQ. (MHz)	EMISSION LEVEL (dBuV/m)	LIMIT (dBuV/m)	MARGIN (dB)	ANTENNA HEIGHT (m)	TABLE ANGLE (Degree)	RAW VALUE (dBuV)	CORRECTION FACTOR (dB/m)
1	#5627.90	60.50 PK	68.20	-7.70	1.80 H	327	57.90	2.60
2	*5745.00	112.40 PK			1.80 H	327	109.60	2.80
3	*5745.00	100.10 AV			1.80 H	327	97.30	2.80
4	#5967.05	61.30 PK	68.20	-6.90	1.80 H	327	58.10	3.20
5	11490.00	51.80 PK	74.00	-22.20	2.40 H	184	38.30	13.50
6	11490.00	39.30 AV	54.00	-14.70	2.40 H	184	25.80	13.50
7	#17235.00	56.90 PK	74.00	-17.10	1.86 H	68	38.50	18.40
8	#17235.00	43.70 AV	54.00	-10.30	1.86 H	68	25.30	18.40

ANTENNA POLARITY & TEST DISTANCE: VERTICAL AT 3 M

NO.	FREQ. (MHz)	EMISSION LEVEL (dBuV/m)	LIMIT (dBuV/m)	MARGIN (dB)	ANTENNA HEIGHT (m)	TABLE ANGLE (Degree)	RAW VALUE (dBuV)	CORRECTION FACTOR (dB/m)
1	#5637.40	63.30 PK	68.20	-4.90	1.70 V	150	60.70	2.60
2	*5745.00	124.30 PK			1.70 V	150	121.50	2.80
3	*5745.00	112.50 AV			1.70 V	150	109.70	2.80
4	#5967.52	64.30 PK	68.20	-3.90	1.70 V	150	61.10	3.20
5	11490.00	57.20 PK	74.00	-16.80	3.27 V	202	43.70	13.50
6	11490.00	43.60 AV	54.00	-10.40	3.27 V	202	30.10	13.50
7	#17235.00	57.00 PK	74.00	-17.00	1.86 V	18	38.60	18.40
8	#17235.00	45.20 AV	54.00	-8.80	1.86 V	18	26.80	18.40

REMARKS:

1. Emission Level(dBuV/m) = Raw Value(dBuV) + Correction Factor(dB/m)
2. Correction Factor(dB/m) = Antenna Factor(dB/m) + Cable Factor(dB) – Pre-Amplifier Factor(dB)
3. The other emission levels were very low against the limit.
4. Margin value = Emission Level – Limit value
5. " * ": Fundamental frequency.
6. " # ": The radiated frequency is out of the restricted band.

CHANNEL	TX Channel 157	DETECTOR FUNCTION	Peak (PK)
FREQUENCY RANGE	1GHz ~ 40GHz		Average (AV)

ANTENNA POLARITY & TEST DISTANCE: HORIZONTAL AT 3 M

NO.	FREQ. (MHz)	EMISSION LEVEL (dBuV/m)	LIMIT (dBuV/m)	MARGIN (dB)	ANTENNA HEIGHT (m)	TABLE ANGLE (Degree)	RAW VALUE (dBuV)	CORRECTION FACTOR (dB/m)
1	#5625.05	61.70 PK	68.20	-6.50	1.76 H	330	59.10	2.60
2	*5785.00	112.90 PK			1.76 H	330	110.00	2.90
3	*5785.00	100.50 AV			1.76 H	330	97.60	2.90
4	#5968.95	62.90 PK	68.20	-5.30	1.76 H	330	59.70	3.20
5	11570.00	52.90 PK	74.00	-21.10	2.45 H	190	39.70	13.20
6	11570.00	40.10 AV	54.00	-13.90	2.45 H	190	26.90	13.20
7	#17355.00	57.30 PK	74.00	-16.70	1.89 H	83	38.20	19.10
8	#17355.00	44.20 AV	54.00	-9.80	1.89 H	83	25.10	19.10

ANTENNA POLARITY & TEST DISTANCE: VERTICAL AT 3 M

NO.	FREQ. (MHz)	EMISSION LEVEL (dBuV/m)	LIMIT (dBuV/m)	MARGIN (dB)	ANTENNA HEIGHT (m)	TABLE ANGLE (Degree)	RAW VALUE (dBuV)	CORRECTION FACTOR (dB/m)
1	#5620.77	62.70 PK	68.20	-5.50	1.61 V	148	60.10	2.60
2	*5785.00	124.30 PK			1.61 V	148	121.40	2.90
3	*5785.00	112.70 AV			1.61 V	148	109.80	2.90
4	#5989.37	62.60 PK	68.20	-5.60	1.61 V	148	59.20	3.40
5	11570.00	56.70 PK	74.00	-17.30	3.27 V	218	43.50	13.20
6	11570.00	43.40 AV	54.00	-10.60	3.27 V	218	30.20	13.20
7	#17355.00	56.80 PK	74.00	-17.20	1.82 V	33	37.70	19.10
8	#17355.00	44.80 AV	54.00	-9.20	1.82 V	33	25.70	19.10

REMARKS:

1. Emission Level(dBuV/m) = Raw Value(dBuV) + Correction Factor(dB/m)
2. Correction Factor(dB/m) = Antenna Factor(dB/m) + Cable Factor(dB) – Pre-Amplifier Factor(dB)
3. The other emission levels were very low against the limit.
4. Margin value = Emission Level – Limit value
5. " * ": Fundamental frequency.
6. " # ": The radiated frequency is out of the restricted band.

CHANNEL	TX Channel 165	DETECTOR FUNCTION	Peak (PK)
FREQUENCY RANGE	1GHz ~ 40GHz		Average (AV)

ANTENNA POLARITY & TEST DISTANCE: HORIZONTAL AT 3 M

NO.	FREQ. (MHz)	EMISSION LEVEL (dBuV/m)	LIMIT (dBuV/m)	MARGIN (dB)	ANTENNA HEIGHT (m)	TABLE ANGLE (Degree)	RAW VALUE (dBuV)	CORRECTION FACTOR (dB/m)
1	#5596.55	61.30 PK	68.20	-6.90	1.72 H	312	58.80	2.50
2	*5825.00	112.40 PK			1.72 H	312	109.50	2.90
3	*5825.00	100.20 AV			1.72 H	312	97.30	2.90
4	#5966.57	60.90 PK	68.20	-7.30	1.72 H	312	57.70	3.20
5	11650.00	52.30 PK	74.00	-21.70	2.40 H	176	39.10	13.20
6	11650.00	40.00 AV	54.00	-14.00	2.40 H	176	26.80	13.20
7	#17475.00	56.50 PK	74.00	-17.50	1.91 H	78	37.10	19.40
8	#17475.00	43.50 AV	54.00	-10.50	1.91 H	78	24.10	19.40

ANTENNA POLARITY & TEST DISTANCE: VERTICAL AT 3 M

NO.	FREQ. (MHz)	EMISSION LEVEL (dBuV/m)	LIMIT (dBuV/m)	MARGIN (dB)	ANTENNA HEIGHT (m)	TABLE ANGLE (Degree)	RAW VALUE (dBuV)	CORRECTION FACTOR (dB/m)
1	#5573.75	63.00 PK	68.20	-5.20	1.66 V	148	60.50	2.50
2	*5825.00	124.50 PK			1.66 V	148	121.60	2.90
3	*5825.00	112.80 AV			1.66 V	148	109.90	2.90
4	#5932.37	62.90 PK	68.20	-5.30	1.66 V	148	59.80	3.10
5	11650.00	57.00 PK	74.00	-17.00	3.24 V	226	43.80	13.20
6	11650.00	43.80 AV	54.00	-10.20	3.24 V	226	30.60	13.20
7	#17475.00	57.10 PK	74.00	-16.90	1.82 V	38	37.70	19.40
8	#17475.00	45.10 AV	54.00	-8.90	1.82 V	38	25.70	19.40

REMARKS:

1. Emission Level(dBuV/m) = Raw Value(dBuV) + Correction Factor(dB/m)
2. Correction Factor(dB/m) = Antenna Factor(dB/m) + Cable Factor(dB) – Pre-Amplifier Factor(dB)
3. The other emission levels were very low against the limit.
4. Margin value = Emission Level – Limit value
5. " * ": Fundamental frequency.
6. " # ": The radiated frequency is out of the restricted band.

802.11ac (VHT40)

CHANNEL	TX Channel 38	DETECTOR FUNCTION	Peak (PK)
FREQUENCY RANGE	1GHz ~ 40GHz		Average (AV)

ANTENNA POLARITY & TEST DISTANCE: HORIZONTAL AT 3 M

NO.	FREQ. (MHz)	EMISSION LEVEL (dBuV/m)	LIMIT (dBuV/m)	MARGIN (dB)	ANTENNA HEIGHT (m)	TABLE ANGLE (Degree)	RAW VALUE (dBuV)	CORRECTION FACTOR (dB/m)
1	5150.00	57.60 PK	74.00	-16.40	1.80 H	332	56.00	1.60
2	5150.00	45.60 AV	54.00	-8.40	1.80 H	332	44.00	1.60
3	*5190.00	101.20 PK			1.80 H	332	99.40	1.80
4	*5190.00	89.30 AV			1.80 H	332	87.50	1.80
5	5350.00	51.70 PK	74.00	-22.30	1.80 H	332	49.60	2.10
6	5350.00	39.20 AV	54.00	-14.80	1.80 H	332	37.10	2.10
7	#10380.00	51.10 PK	74.00	-22.90	1.76 H	243	39.30	11.80
8	#10380.00	38.10 AV	54.00	-15.90	1.76 H	243	26.30	11.80
9	15570.00	53.00 PK	74.00	-21.00	1.82 H	143	39.70	13.30
10	15570.00	39.90 AV	54.00	-14.10	1.82 H	143	26.60	13.30

ANTENNA POLARITY & TEST DISTANCE: VERTICAL AT 3 M

NO.	FREQ. (MHz)	EMISSION LEVEL (dBuV/m)	LIMIT (dBuV/m)	MARGIN (dB)	ANTENNA HEIGHT (m)	TABLE ANGLE (Degree)	RAW VALUE (dBuV)	CORRECTION FACTOR (dB/m)
1	5150.00	65.00 PK	74.00	-9.00	1.20 V	149	63.40	1.60
2	5150.00	53.90 AV	54.00	-0.10	1.20 V	149	52.30	1.60
3	*5190.00	113.10 PK			1.20 V	149	111.30	1.80
4	*5190.00	101.70 AV			1.20 V	149	99.90	1.80
5	5350.00	55.30 PK	74.00	-18.70	1.20 V	149	53.20	2.10
6	5350.00	44.20 AV	54.00	-9.80	1.20 V	149	42.10	2.10
7	#10380.00	50.90 PK	74.00	-23.10	1.19 V	128	39.10	11.80
8	#10380.00	37.80 AV	54.00	-16.20	1.19 V	128	26.00	11.80
9	15570.00	52.70 PK	74.00	-21.30	1.53 V	5	39.40	13.30
10	15570.00	39.80 AV	54.00	-14.20	1.53 V	5	26.50	13.30

REMARKS:

- Emission Level(dBuV/m) = Raw Value(dBuV) + Correction Factor(dB/m)
- Correction Factor(dB/m) = Antenna Factor(dB/m) + Cable Factor(dB) – Pre-Amplifier Factor(dB)
- The other emission levels were very low against the limit.
- Margin value = Emission Level – Limit value
- " * ": Fundamental frequency.
- " # ": The radiated frequency is out of the restricted band.

CHANNEL	TX Channel 46	DETECTOR FUNCTION	Peak (PK)
FREQUENCY RANGE	1GHz ~ 40GHz		Average (AV)

ANTENNA POLARITY & TEST DISTANCE: HORIZONTAL AT 3 M

NO.	FREQ. (MHz)	EMISSION LEVEL (dBuV/m)	LIMIT (dBuV/m)	MARGIN (dB)	ANTENNA HEIGHT (m)	TABLE ANGLE (Degree)	RAW VALUE (dBuV)	CORRECTION FACTOR (dB/m)
1	5150.00	57.60 PK	74.00	-16.40	1.76 H	336	56.00	1.60
2	5150.00	45.60 AV	54.00	-8.40	1.76 H	336	44.00	1.60
3	*5230.00	107.80 PK			1.76 H	336	106.00	1.80
4	*5230.00	96.70 AV			1.76 H	336	94.90	1.80
5	5350.00	54.80 PK	74.00	-19.20	1.76 H	336	52.70	2.10
6	5350.00	43.20 AV	54.00	-10.80	1.76 H	336	41.10	2.10
7	#10460.00	50.50 PK	74.00	-23.50	1.76 H	247	38.40	12.10
8	#10460.00	37.60 AV	54.00	-16.40	1.76 H	247	25.50	12.10
9	15690.00	52.50 PK	74.00	-21.50	1.85 H	158	39.30	13.20
10	15690.00	39.50 AV	54.00	-14.50	1.85 H	158	26.30	13.20

ANTENNA POLARITY & TEST DISTANCE: VERTICAL AT 3 M

NO.	FREQ. (MHz)	EMISSION LEVEL (dBuV/m)	LIMIT (dBuV/m)	MARGIN (dB)	ANTENNA HEIGHT (m)	TABLE ANGLE (Degree)	RAW VALUE (dBuV)	CORRECTION FACTOR (dB/m)
1	5150.00	64.10 PK	74.00	-9.90	1.22 V	150	62.50	1.60
2	5150.00	53.10 AV	54.00	-0.90	1.22 V	150	51.50	1.60
3	*5230.00	120.00 PK			1.22 V	150	118.20	1.80
4	*5230.00	108.50 AV			1.22 V	150	106.70	1.80
5	5350.00	61.50 PK	74.00	-12.50	1.22 V	150	59.40	2.10
6	5350.00	49.10 AV	54.00	-4.90	1.22 V	150	47.00	2.10
7	#10460.00	50.30 PK	74.00	-23.70	1.24 V	121	38.20	12.10
8	#10460.00	37.30 AV	54.00	-16.70	1.24 V	121	25.20	12.10
9	15690.00	52.90 PK	74.00	-21.10	1.49 V	16	39.70	13.20
10	15690.00	40.10 AV	54.00	-13.90	1.49 V	16	26.90	13.20

REMARKS:

1. Emission Level(dBuV/m) = Raw Value(dBuV) + Correction Factor(dB/m)
2. Correction Factor(dB/m) = Antenna Factor(dB/m) + Cable Factor(dB) – Pre-Amplifier Factor(dB)
3. The other emission levels were very low against the limit.
4. Margin value = Emission Level – Limit value
5. " * ": Fundamental frequency.
6. " # ": The radiated frequency is out of the restricted band.

CHANNEL	TX Channel 151	DETECTOR FUNCTION	Peak (PK)
FREQUENCY RANGE	1GHz ~ 40GHz		Average (AV)

ANTENNA POLARITY & TEST DISTANCE: HORIZONTAL AT 3 M

NO.	FREQ. (MHz)	EMISSION LEVEL (dBuV/m)	LIMIT (dBuV/m)	MARGIN (dB)	ANTENNA HEIGHT (m)	TABLE ANGLE (Degree)	RAW VALUE (dBuV)	CORRECTION FACTOR (dB/m)
1	#5615.07	62.20 PK	68.20	-6.00	1.77 H	322	59.60	2.60
2	*5755.00	108.90 PK			1.77 H	322	106.00	2.90
3	*5755.00	96.80 AV			1.77 H	322	93.90	2.90
4	#5935.70	62.00 PK	68.20	-6.20	1.77 H	322	58.90	3.10
5	11510.00	52.40 PK	74.00	-21.60	2.39 H	194	38.90	13.50
6	11510.00	39.60 AV	54.00	-14.40	2.39 H	194	26.10	13.50
7	#17265.00	56.30 PK	74.00	-17.70	1.87 H	78	37.80	18.50
8	#17265.00	43.30 AV	54.00	-10.70	1.87 H	78	24.80	18.50

ANTENNA POLARITY & TEST DISTANCE: VERTICAL AT 3 M

NO.	FREQ. (MHz)	EMISSION LEVEL (dBuV/m)	LIMIT (dBuV/m)	MARGIN (dB)	ANTENNA HEIGHT (m)	TABLE ANGLE (Degree)	RAW VALUE (dBuV)	CORRECTION FACTOR (dB/m)
1	#5610.32	65.10 PK	68.20	-3.10	1.70 V	146	62.50	2.60
2	*5755.00	120.70 PK			1.70 V	146	117.80	2.90
3	*5755.00	109.20 AV			1.70 V	146	106.30	2.90
4	#5980.82	62.70 PK	68.20	-5.50	1.70 V	146	59.40	3.30
5	11510.00	51.80 PK	74.00	-22.20	3.06 V	208	38.30	13.50
6	11510.00	40.00 AV	54.00	-14.00	3.06 V	208	26.50	13.50
7	#17265.00	56.30 PK	74.00	-17.70	1.66 V	59	37.80	18.50
8	#17265.00	43.20 AV	54.00	-10.80	1.66 V	59	24.70	18.50

REMARKS:

1. Emission Level(dBuV/m) = Raw Value(dBuV) + Correction Factor(dB/m)
2. Correction Factor(dB/m) = Antenna Factor(dB/m) + Cable Factor(dB) – Pre-Amplifier Factor(dB)
3. The other emission levels were very low against the limit.
4. Margin value = Emission Level – Limit value
5. " * ": Fundamental frequency.
6. " # ": The radiated frequency is out of the restricted band.

CHANNEL	TX Channel 159	DETECTOR FUNCTION	Peak (PK)
FREQUENCY RANGE	1GHz ~ 40GHz		Average (AV)

ANTENNA POLARITY & TEST DISTANCE: HORIZONTAL AT 3 M

NO.	FREQ. (MHz)	EMISSION LEVEL (dBuV/m)	LIMIT (dBuV/m)	MARGIN (dB)	ANTENNA HEIGHT (m)	TABLE ANGLE (Degree)	RAW VALUE (dBuV)	CORRECTION FACTOR (dB/m)
1	#5602.73	63.00 PK	68.20	-5.20	1.78 H	320	60.50	2.50
2	*5795.00	109.20 PK			1.78 H	320	106.30	2.90
3	*5795.00	97.10 AV			1.78 H	320	94.20	2.90
4	#5933.80	62.80 PK	68.20	-5.40	1.78 H	320	59.70	3.10
5	11590.00	52.40 PK	74.00	-21.60	2.46 H	204	39.30	13.10
6	11590.00	39.60 AV	54.00	-14.40	2.46 H	204	26.50	13.10
7	#17385.00	56.50 PK	74.00	-17.50	1.92 H	87	37.20	19.30
8	#17385.00	43.80 AV	54.00	-10.20	1.92 H	87	24.50	19.30

ANTENNA POLARITY & TEST DISTANCE: VERTICAL AT 3 M

NO.	FREQ. (MHz)	EMISSION LEVEL (dBuV/m)	LIMIT (dBuV/m)	MARGIN (dB)	ANTENNA HEIGHT (m)	TABLE ANGLE (Degree)	RAW VALUE (dBuV)	CORRECTION FACTOR (dB/m)
1	#5635.98	64.30 PK	68.20	-3.90	1.67 V	151	61.70	2.60
2	*5795.00	120.80 PK			1.67 V	151	117.90	2.90
3	*5795.00	109.40 AV			1.67 V	151	106.50	2.90
4	#5971.32	64.60 PK	68.20	-3.60	1.67 V	151	61.40	3.20
5	11590.00	52.90 PK	74.00	-21.10	3.02 V	204	39.80	13.10
6	11590.00	40.70 AV	54.00	-13.30	3.02 V	204	27.60	13.10
7	#17385.00	56.40 PK	74.00	-17.60	1.62 V	64	37.10	19.30
8	#17385.00	43.40 AV	54.00	-10.60	1.62 V	64	24.10	19.30

REMARKS:

1. Emission Level(dBuV/m) = Raw Value(dBuV) + Correction Factor(dB/m)
2. Correction Factor(dB/m) = Antenna Factor(dB/m) + Cable Factor(dB) – Pre-Amplifier Factor(dB)
3. The other emission levels were very low against the limit.
4. Margin value = Emission Level – Limit value
5. " * ": Fundamental frequency.
6. " # ": The radiated frequency is out of the restricted band.

802.11ac (VHT80)

CHANNEL	TX Channel 42	DETECTOR FUNCTION	Peak (PK)
FREQUENCY RANGE	1GHz ~ 40GHz		Average (AV)

ANTENNA POLARITY & TEST DISTANCE: HORIZONTAL AT 3 M

NO.	FREQ. (MHz)	EMISSION LEVEL (dBuV/m)	LIMIT (dBuV/m)	MARGIN (dB)	ANTENNA HEIGHT (m)	TABLE ANGLE (Degree)	RAW VALUE (dBuV)	CORRECTION FACTOR (dB/m)
1	5150.00	57.60 PK	74.00	-16.40	1.81 H	328	56.00	1.60
2	5150.00	45.30 AV	54.00	-8.70	1.81 H	328	43.70	1.60
3	*5210.00	97.30 PK			1.81 H	328	95.50	1.80
4	*5210.00	84.40 AV			1.81 H	328	82.60	1.80
5	5350.00	51.30 PK	74.00	-22.70	1.81 H	328	49.20	2.10
6	5350.00	38.80 AV	54.00	-15.20	1.81 H	328	36.70	2.10
7	#10420.00	51.00 PK	74.00	-23.00	1.76 H	231	39.00	12.00
8	#10420.00	37.90 AV	54.00	-16.10	1.76 H	231	25.90	12.00
9	15630.00	53.50 PK	74.00	-20.50	1.82 H	131	40.20	13.30
10	15630.00	40.20 AV	54.00	-13.80	1.82 H	131	26.90	13.30

ANTENNA POLARITY & TEST DISTANCE: VERTICAL AT 3 M

NO.	FREQ. (MHz)	EMISSION LEVEL (dBuV/m)	LIMIT (dBuV/m)	MARGIN (dB)	ANTENNA HEIGHT (m)	TABLE ANGLE (Degree)	RAW VALUE (dBuV)	CORRECTION FACTOR (dB/m)
1	5150.00	66.20 PK	74.00	-7.80	1.09 V	149	64.60	1.60
2	5150.00	53.80 AV	54.00	-0.20	1.09 V	149	52.20	1.60
3	*5210.00	109.60 PK			1.09 V	149	107.80	1.80
4	*5210.00	96.60 AV			1.09 V	149	94.80	1.80
5	5350.00	55.50 PK	74.00	-18.50	1.09 V	149	53.40	2.10
6	5350.00	44.00 AV	54.00	-10.00	1.09 V	149	41.90	2.10
7	#10420.00	51.40 PK	74.00	-22.60	1.18 V	119	39.40	12.00
8	#10420.00	38.20 AV	54.00	-15.80	1.18 V	119	26.20	12.00
9	15630.00	53.30 PK	74.00	-20.70	1.54 V	0	40.00	13.30
10	15630.00	40.10 AV	54.00	-13.90	1.54 V	0	26.80	13.30

REMARKS:

- Emission Level(dBuV/m) = Raw Value(dBuV) + Correction Factor(dB/m)
- Correction Factor(dB/m) = Antenna Factor(dB/m) + Cable Factor(dB) – Pre-Amplifier Factor(dB)
- The other emission levels were very low against the limit.
- Margin value = Emission Level – Limit value
- " * ": Fundamental frequency.
- " # ": The radiated frequency is out of the restricted band.

CHANNEL	TX Channel 155	DETECTOR FUNCTION	Peak (PK)
FREQUENCY RANGE	1GHz ~ 40GHz		Average (AV)

ANTENNA POLARITY & TEST DISTANCE: HORIZONTAL AT 3 M

NO.	FREQ. (MHz)	EMISSION LEVEL (dBuV/m)	LIMIT (dBuV/m)	MARGIN (dB)	ANTENNA HEIGHT (m)	TABLE ANGLE (Degree)	RAW VALUE (dBuV)	CORRECTION FACTOR (dB/m)
1	#5593.23	61.90 PK	68.20	-6.30	1.75 H	320	59.40	2.50
2	*5775.00	105.80 PK			1.75 H	320	102.90	2.90
3	*5775.00	93.80 AV			1.75 H	320	90.90	2.90
4	#5963.25	62.90 PK	68.20	-5.30	1.75 H	320	59.70	3.20
5	11550.00	52.60 PK	74.00	-21.40	2.41 H	217	39.30	13.30
6	11550.00	40.00 AV	54.00	-14.00	2.41 H	217	26.70	13.30
7	#17325.00	56.70 PK	74.00	-17.30	1.91 H	91	37.80	18.90
8	#17325.00	43.70 AV	54.00	-10.30	1.91 H	91	24.80	18.90

ANTENNA POLARITY & TEST DISTANCE: VERTICAL AT 3 M

NO.	FREQ. (MHz)	EMISSION LEVEL (dBuV/m)	LIMIT (dBuV/m)	MARGIN (dB)	ANTENNA HEIGHT (m)	TABLE ANGLE (Degree)	RAW VALUE (dBuV)	CORRECTION FACTOR (dB/m)
1	#5630.75	66.40 PK	68.20	-1.80	1.42 V	157	63.80	2.60
2	*5775.00	117.40 PK			1.42 V	157	114.50	2.90
3	*5775.00	106.10 AV			1.42 V	157	103.20	2.90
4	#5925.73	66.30 PK	68.20	-1.90	1.42 V	157	63.20	3.10
5	11550.00	52.20 PK	74.00	-21.80	2.97 V	211	38.90	13.30
6	11550.00	40.20 AV	54.00	-13.80	2.97 V	211	26.90	13.30
7	#17325.00	56.70 PK	74.00	-17.30	1.68 V	52	37.80	18.90
8	#17325.00	43.50 AV	54.00	-10.50	1.68 V	52	24.60	18.90

REMARKS:

1. Emission Level(dBuV/m) = Raw Value(dBuV) + Correction Factor(dB/m)
2. Correction Factor(dB/m) = Antenna Factor(dB/m) + Cable Factor(dB) – Pre-Amplifier Factor(dB)
3. The other emission levels were very low against the limit.
4. Margin value = Emission Level – Limit value
5. " * ": Fundamental frequency.
6. " # ": The radiated frequency is out of the restricted band.

Below 1GHz Data:

802.11ac (VHT40)

CHANNEL	TX Channel 159	DETECTOR FUNCTION	Quasi-Peak (QP)
FREQUENCY RANGE	below 1GHz		

ANTENNA POLARITY & TEST DISTANCE: HORIZONTAL AT 3 M

NO.	FREQ. (MHz)	EMISSION LEVEL (dBuV/m)	LIMIT (dBuV/m)	MARGIN (dB)	ANTENNA HEIGHT (m)	TABLE ANGLE (Degree)	RAW VALUE (dBuV)	CORRECTION FACTOR (dB/m)
1	30.00	33.23 QP	40.00	-6.77	1.00 H	32	43.07	-9.84
2	43.77	28.83 QP	40.00	-11.17	1.00 H	167	37.55	-8.72
3	147.20	30.44 QP	43.50	-13.06	1.00 H	239	38.98	-8.54
4	162.57	31.68 QP	43.50	-11.82	1.00 H	287	40.30	-8.62
5	200.04	37.26 QP	43.50	-6.24	1.00 H	82	49.18	-11.92
6	278.85	33.36 QP	46.00	-12.64	1.00 H	17	41.89	-8.53

ANTENNA POLARITY & TEST DISTANCE: VERTICAL AT 3 M

NO.	FREQ. (MHz)	EMISSION LEVEL (dBuV/m)	LIMIT (dBuV/m)	MARGIN (dB)	ANTENNA HEIGHT (m)	TABLE ANGLE (Degree)	RAW VALUE (dBuV)	CORRECTION FACTOR (dB/m)
1	63.47	33.41 QP	40.00	-6.59	1.00 V	5	42.98	-9.57
2	81.75	31.88 QP	40.00	-8.12	1.00 V	222	45.80	-13.92
3	96.57	31.19 QP	43.50	-12.31	1.00 V	342	44.76	-13.57
4	166.21	31.55 QP	43.50	-11.95	1.00 V	357	40.45	-8.90
5	500.01	29.22 QP	46.00	-16.78	1.00 V	96	32.06	-2.84
6	606.37	31.58 QP	46.00	-14.42	1.00 V	128	32.01	-0.43

REMARKS:

1. Emission Level(dBuV/m) = Raw Value(dBuV) + Correction Factor(dB/m)
2. Correction Factor(dB/m) = Antenna Factor(dB/m) + Cable Factor(dB) – Pre-Amplifier Factor(dB)
3. The other emission levels were very low against the limit.
4. Margin value = Emission Level – Limit value

4.2 Conducted Emission Measurement

4.2.1 Limits of Conducted Emission Measurement

Frequency (MHz)	Conducted Limit (dBuV)	
	Quasi-peak	Average
0.15 - 0.5	66 - 56	56 - 46
0.50 - 5.0	56	46
5.0 - 30.0	60	50

Note: 1. The lower limit shall apply at the transition frequencies.

2. The limit decreases in line with the logarithm of the frequency in the range of 0.15 to 0.50MHz.

4.2.2 Test Instruments

DESCRIPTION & MANUFACTURER	MODEL NO.	SERIAL NO.	CALIBRATED DATE	CALIBRATED UNTIL
Test Receiver R&S	ESCS 30	847124/029	Oct. 23, 2015	Oct. 22, 2016
Line-Impedance Stabilization Network (for EUT) R&S	ESH3-Z5	848773/004	Oct. 28, 2015	Oct. 27, 2016
RF Cable	5D-FB	COACAB-002	Mar. 04, 2016	Mar. 03, 2017
10 dB PAD Mini-Circuits	HAT-10+	CONATT-004	June 20, 2016	June 19, 2017
Software BVADT	BVADT_Cond_ V7.3.7.3	NA	NA	NA

Note:

1. The calibration interval of the above test instruments are 12 months and the calibrations are traceable to NML/ROC and NIST/USA.
2. The test was performed in Shielded Room No. 1.
- 3 Tested Date: July 19, 2016

4.2.3 Test Procedure

- The EUT was placed 0.4 meters from the conducting wall of the shielded room with EUT being connected to the power mains through a line impedance stabilization network (LISN). Other support units were connected to the power mains through another LISN. The two LISNs provide 50 ohm/ 50uH of coupling impedance for the measuring instrument.
- Both lines of the power mains connected to the EUT were checked for maximum conducted interference.
- The frequency range from 150kHz to 30MHz was searched. Emission levels under (Limit - 20dB) was not recorded.

NOTE: All modes of operation were investigated and the worst-case emissions are reported.

4.2.4 Deviation from Test Standard

No deviation.

4.2.5 Test Setup

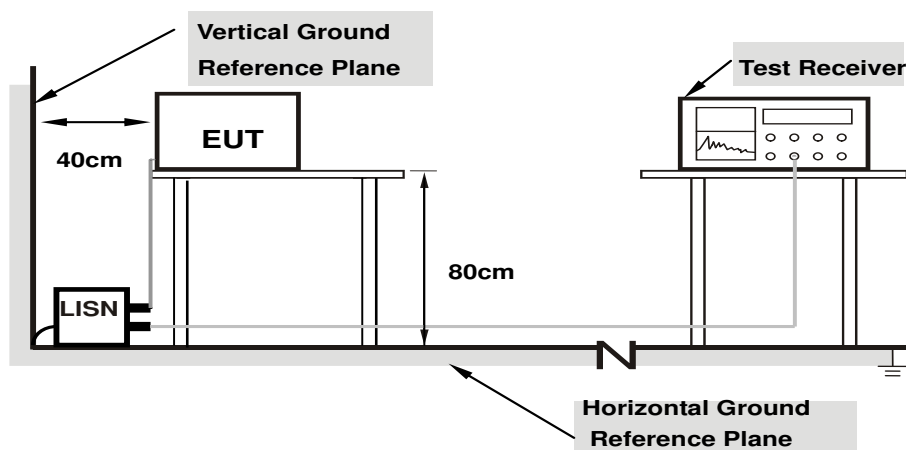

Note: 1.Support units were connected to second LISN.

For the actual test configuration, please refer to the attached file (Test Setup Photo).

4.2.6 EUT Operating Condition

Same as 4.1.6.

4.2.7 Test Results (Mode 1)

Phase	Line (L)	Detector Function	Quasi-Peak (QP) / Average (AV)
-------	----------	-------------------	--------------------------------

No	Freq. [MHz]	Corr. Factor	Reading Value [dB (uV)]		Emission Level [dB (uV)]		Limit [dB (uV)]		Margin (dB)	
		(dB)	Q.P.	AV.	Q.P.	AV.	Q.P.	AV.	Q.P.	AV.
	1	0.15391	10.21	41.09	29.53	51.30	39.74	65.79	55.79	-14.49
2	0.20469	10.22	33.33	25.23	43.55	35.45	63.42	53.42	-19.87	-17.97
3	0.35313	10.22	35.41	31.25	45.63	41.47	58.89	48.89	-13.26	-7.42
4	0.87266	10.25	18.82	14.38	29.07	24.63	56.00	46.00	-26.93	-21.37
5	1.98438	10.31	19.90	15.80	30.21	26.11	56.00	46.00	-25.79	-19.89
6	15.46484	11.09	23.19	18.46	34.28	29.55	60.00	50.00	-25.72	-20.45

REMARKS:

1. Q.P. and AV. are abbreviations of quasi-peak and average individually.
2. The emission levels of other frequencies were very low against the limit.
3. Margin value = Emission level - Limit value
4. Correction factor = Insertion loss + Cable loss
5. Emission Level = Correction Factor + Reading Value.

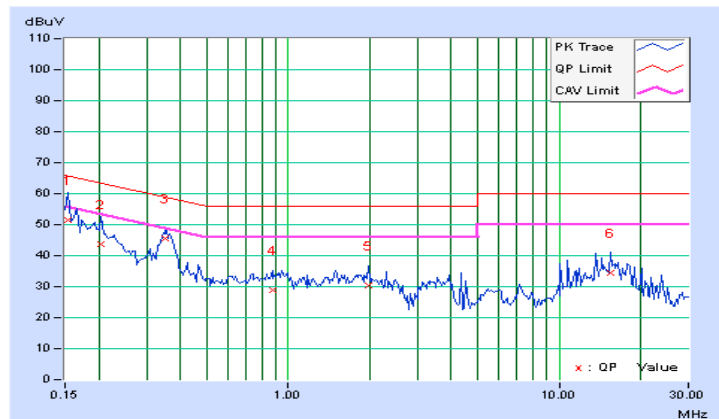

Phase	Neutral (N)	Detector Function	Quasi-Peak (QP) / Average (AV)
-------	-------------	-------------------	--------------------------------

No	Freq.	Corr.	Reading Value		Emission Level		Limit		Margin	
	[MHz]	Factor	[dB (uV)]		[dB (uV)]		[dB (uV)]		(dB)	
		(dB)	Q.P.	AV.	Q.P.	AV.	Q.P.	AV.	Q.P.	AV.
1	0.16172	10.19	38.27	27.55	48.46	37.74	65.38	55.38	-16.91	-17.63
2	0.18906	10.21	35.09	23.76	45.30	33.97	64.08	54.08	-18.78	-20.11
3	0.35703	10.20	35.57	32.96	45.77	43.16	58.80	48.80	-13.03	-5.64
4	0.76719	10.22	19.01	12.82	29.23	23.04	56.00	46.00	-26.77	-22.96
5	1.78516	10.28	21.44	16.29	31.72	26.57	56.00	46.00	-24.28	-19.43
6	15.33594	10.91	21.65	17.60	32.56	28.51	60.00	50.00	-27.44	-21.49

REMARKS:

1. Q.P. and AV. are abbreviations of quasi-peak and average individually.
2. The emission levels of other frequencies were very low against the limit.
3. Margin value = Emission level - Limit value
4. Correction factor = Insertion loss + Cable loss
5. Emission Level = Correction Factor + Reading Value.

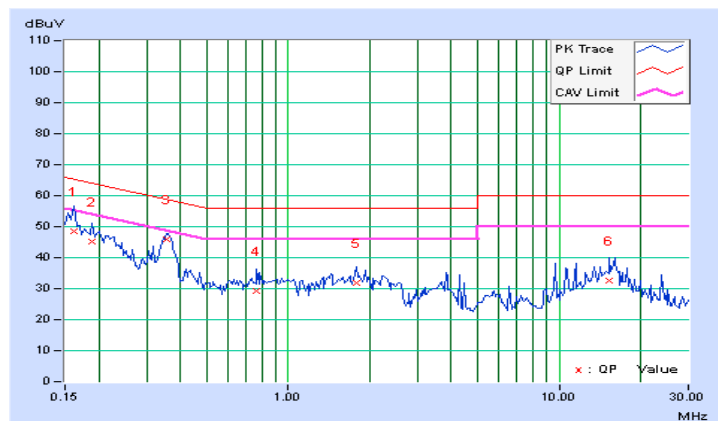

4.2.8 Test Results (Mode 2)

Phase	Line (L)	Detector Function	Quasi-Peak (QP) / Average (AV)
-------	----------	-------------------	--------------------------------

No	Freq. [MHz]	Corr. Factor	Reading Value [dB (uV)]		Emission Level [dB (uV)]		Limit [dB (uV)]		Margin (dB)	
		(dB)	Q.P.	AV.	Q.P.	AV.	Q.P.	AV.	Q.P.	AV.
	1	0.15000	10.21	42.12	29.56	52.33	39.77	66.00	56.00	-13.67
2	0.18906	10.22	31.44	15.09	41.66	25.31	64.08	54.08	-22.42	-28.77
3	0.22422	10.22	32.39	15.82	42.61	26.04	62.66	52.66	-20.05	-26.62
4	0.40781	10.22	33.47	25.00	43.69	35.22	57.69	47.69	-14.00	-12.47
5	0.92734	10.26	20.08	13.86	30.34	24.12	56.00	46.00	-25.66	-21.88
6	24.00000	11.43	25.84	25.19	37.27	36.62	60.00	50.00	-22.73	-13.38

REMARKS:

1. Q.P. and AV. are abbreviations of quasi-peak and average individually.
2. The emission levels of other frequencies were very low against the limit.
3. Margin value = Emission level - Limit value
4. Correction factor = Insertion loss + Cable loss
5. Emission Level = Correction Factor + Reading Value.

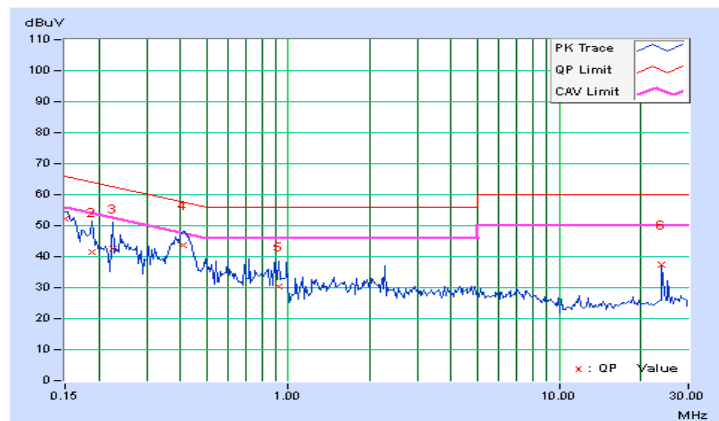

Phase	Neutral (N)	Detector Function	Quasi-Peak (QP) / Average (AV)
-------	-------------	-------------------	--------------------------------

No	Freq.	Corr.	Reading Value		Emission Level		Limit		Margin	
	[MHz]	Factor	[dB (uV)]		[dB (uV)]		[dB (uV)]		(dB)	
		(dB)	Q.P.	AV.	Q.P.	AV.	Q.P.	AV.	Q.P.	AV.
1	0.16953	10.20	37.61	20.66	47.81	30.86	64.98	54.98	-17.18	-24.13
2	0.23594	10.21	32.46	25.93	42.67	36.14	62.24	52.24	-19.57	-16.10
3	0.41172	10.20	37.72	30.82	47.92	41.02	57.61	47.61	-9.69	-6.59
4	0.73594	10.22	20.89	13.00	31.11	23.22	56.00	46.00	-24.89	-22.78
5	2.51953	10.28	17.76	11.73	28.04	22.01	56.00	46.00	-27.96	-23.99
6	24.00000	11.13	24.72	24.35	35.85	35.48	60.00	50.00	-24.15	-14.52

REMARKS:

1. Q.P. and AV. are abbreviations of quasi-peak and average individually.
2. The emission levels of other frequencies were very low against the limit.
3. Margin value = Emission level - Limit value
4. Correction factor = Insertion loss + Cable loss
5. Emission Level = Correction Factor + Reading Value.

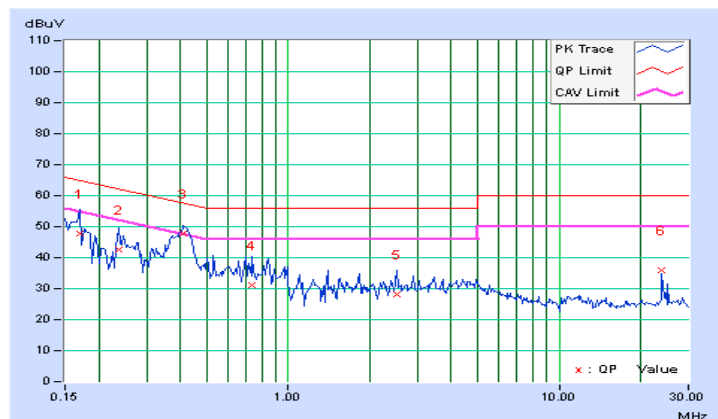

4.3 Transmit Power Measurement

4.3.1 Limits of Transmit Power Measurement

Operation Band	EUT Category		Limit
U-NII-1		Outdoor Access Point	1 Watt (30 dBm) (Max. e.i.r.p \leq 125mW(21 dBm) at any elevation angle above 30 degrees as measured from the horizon)
		Fixed point-to-point Access Point	1 Watt (30 dBm)
	√	Indoor Access Point	1 Watt (30 dBm)
		Mobile and Portable client device	250mW (24 dBm)
U-NII-2A			250mW (24 dBm) or 11 dBm+10 log B*
U-NII-2C			250mW (24 dBm) or 11 dBm+10 log B*
U-NII-3		√	1 Watt (30 dBm)

*B is the 26 dB emission bandwidth in megahertz

Per KDB 662911 Method of conducted output power measurement on IEEE 802.11 devices,

Array Gain = 0 dB (i.e., no array gain) for $N_{ANT} \leq 4$;

Array Gain = 0 dB (i.e., no array gain) for channel widths ≥ 40 MHz for any N_{ANT} ;

Array Gain = $5 \log(N_{ANT}/N_{SS})$ dB or 3 dB, whichever is less for 20-MHz channel widths with $N_{ANT} \geq 5$.

For power measurements on all other devices: Array Gain = $10 \log(N_{ANT}/N_{SS})$ dB.

4.3.2 Test Setup

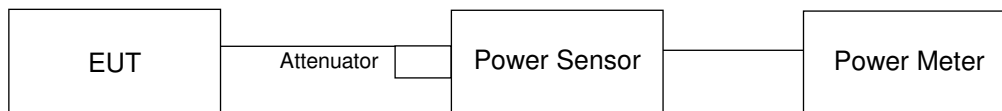

4.3.3 Test Instruments

Refer to section 4.1.2 to get information of above instrument.

4.3.4 Test Procedure

Method PM is used to perform output power measurement, trigger and gating function of wide band power meter is enabled to measure max output power of TX on burst. Duty factor is not added to measured value.

4.3.5 Deviation from Test Standard

No deviation.

4.3.6 EUT Operating Condition

The software provided by client to enable the EUT under transmission condition continuously at lowest, middle and highest channel frequencies individually.

4.3.7 Test Result

CDD Mode
802.11a

Chan.	Chan. Freq. (MHz)	Maximum Conducted Power (dBm)				Total Power (mW)	Total Power (dBm)	Limit (dBm)	Pass / Fail
		Chain 0	Chain 1	Chain 2	Chain 3				
36	5180	20.35	20.04	20.31	20.06	418.108	26.21	30.00	Pass
40	5200	20.31	20.08	20.42	20.02	419.874	26.23	30.00	Pass
48	5240	20.38	20.11	20.37	20.04	421.527	26.25	30.00	Pass
149	5745	22.96	23.94	23.62	24.35	947.853	29.77	30.00	Pass
157	5785	23.12	24.07	23.52	24.33	956.31	29.81	30.00	Pass
165	5825	23.41	24.33	23.42	24.11	967.717	29.86	30.00	Pass

802.11ac (VHT20)

Chan.	Chan. Freq. (MHz)	Maximum Conducted Power (dBm)				Total Power (mW)	Total Power (dBm)	Limit (dBm)	Pass / Fail
		Chain 0	Chain 1	Chain 2	Chain 3				
36	5180	20.38	19.38	20.32	19.42	390.985	25.92	30.00	Pass
40	5200	20.42	19.44	20.45	19.50	398.098	26.00	30.00	Pass
48	5240	20.50	19.32	20.36	19.39	393.248	25.95	30.00	Pass
149	5745	22.94	23.87	23.82	24.41	957.619	29.81	30.00	Pass
157	5785	22.98	23.94	23.62	24.22	940.736	29.73	30.00	Pass
165	5825	23.18	24.29	23.33	24.19	954.204	29.80	30.00	Pass

802.11ac (VHT40)

Chan.	Chan. Freq. (MHz)	Maximum Conducted Power (dBm)				Total Power (mW)	Total Power (dBm)	Limit (dBm)	Pass / Fail
		Chain 0	Chain 1	Chain 2	Chain 3				
38	5190	17.35	17.11	17.22	17.12	209.975	23.22	30.00	Pass
46	5230	23.36	22.88	23.52	23.34	851.538	29.30	30.00	Pass
151	5755	22.94	24.07	23.72	24.22	951.805	29.79	30.00	Pass
159	5795	23.07	24.21	23.58	24.63	984.837	29.93	30.00	Pass

802.11ac (VHT80)

Chan.	Chan. Freq. (MHz)	Maximum Conducted Power (dBm)				Total Power (mW)	Total Power (dBm)	Limit (dBm)	Pass / Fail
		Chain 0	Chain 1	Chain 2	Chain 3				
42	5210	16.40	16.32	16.25	16.59	174.281	22.41	30.00	Pass
155	5775	23.01	24.11	23.96	24.01	958.272	29.81	30.00	Pass

Beamforming Mode

802.11ac (VHT20)

Chan.	Chan. Freq. (MHz)	Maximum Conducted Power (dBm)				Total Power (mW)	Total Power (dBm)	Limit (dBm)	Pass / Fail
		Chain 0	Chain 1	Chain 2	Chain 3				
36	5180	20.38	19.38	20.32	19.42	390.985	25.92	26.36	Pass
40	5200	20.42	19.44	20.45	19.50	398.098	26.00	26.36	Pass
48	5240	20.50	19.32	20.36	19.39	393.248	25.95	26.36	Pass
149	5745	21.73	21.48	21.79	21.33	576.38	27.61	27.64	Pass
157	5785	21.65	21.43	21.81	21.23	569.657	27.56	27.64	Pass
165	5825	21.49	21.58	21.80	21.38	573.569	27.59	27.64	Pass

- Note:** 1. For UNII-1: Directional gain = $3.62\text{dBi} + 10\log(4) = 9.64\text{dBi} > 6\text{dBi}$, so the power limit shall be reduced to $30-(9.64-6) = 29.36\text{dBm}$
 2. For UNII-3: Directional gain = $2.34\text{dBi} + 10\log(4) = 8.36\text{dBi} > 6\text{dBi}$, so the power limit shall be reduced to $30-(8.36-6) = 27.64\text{dBm}$.

802.11ac (VHT40)

Chan.	Chan. Freq. (MHz)	Maximum Conducted Power (dBm)				Total Power (mW)	Total Power (dBm)	Limit (dBm)	Pass / Fail
		Chain 0	Chain 1	Chain 2	Chain 3				
38	5190	17.35	17.11	17.22	17.12	209.975	23.22	26.36	Pass
46	5230	21.23	20.04	20.03	19.80	429.856	26.33	26.36	Pass
151	5755	21.99	21.47	21.67	20.88	567.761	27.54	27.64	Pass
159	5795	21.68	21.34	21.61	20.82	549.033	27.40	27.64	Pass

- Note:** 1. For UNII-1: Directional gain = $3.62\text{dBi} + 10\log(4) = 9.64\text{dBi} > 6\text{dBi}$, so the power limit shall be reduced to $30-(9.64-6) = 29.36\text{dBm}$
 2. For UNII-3: Directional gain = $2.34\text{dBi} + 10\log(4) = 8.36\text{dBi} > 6\text{dBi}$, so the power limit shall be reduced to $30-(8.36-6) = 27.64\text{dBm}$.

802.11ac (VHT80)

Chan.	Chan. Freq. (MHz)	Maximum Conducted Power (dBm)				Total Power (mW)	Total Power (dBm)	Limit (dBm)	Pass / Fail
		Chain 0	Chain 1	Chain 2	Chain 3				
42	5210	16.40	16.32	16.25	16.59	174.281	22.41	26.36	Pass
155	5775	21.75	21.53	21.32	20.94	551.541	27.42	27.64	Pass

- Note:** 1. For UNII-1: Directional gain = $3.62\text{dBi} + 10\log(4) = 9.64\text{dBi} > 6\text{dBi}$, so the power limit shall be reduced to $30-(9.64-6) = 29.36\text{dBm}$
 2. For UNII-3: Directional gain = $2.34\text{dBi} + 10\log(4) = 8.36\text{dBi} > 6\text{dBi}$, so the power limit shall be reduced to $30-(8.36-6) = 27.64\text{dBm}$.

4.4 Occupied Bandwidth Measurement

4.4.1 Test Setup



4.4.2 Test Instruments

Refer to section 4.1.2 to get information of above instrument.

4.4.3 Test Procedure

The transmitter output was connected to the spectrum analyzer through an attenuator. The bandwidth of the fundamental frequency was measured by spectrum analyzer with resolution bandwidth in the range of 1% to 5% of the anticipated emission bandwidth, and a video bandwidth at least 3x the resolution bandwidth and set the detector to SAMPLE. The width of a frequency band such that, below the lower and above the upper frequency limits, the mean powers emitted are each equal to a specified percentage 0.5 %of the total mean power of a given emission.

4.4.4 Test Result

802.11a

Channel	Channel Frequency (MHz)	Occupied Bandwidth (MHz)			
		CHAIN 0	CHAIN 1	CHAIN 2	CHAIN 3
36	5180	17.16	16.92	17.04	17.04
40	5200	17.04	17.04	16.92	17.04
48	5240	16.92	17.04	16.92	16.80
149	5745	17.16	17.16	17.16	17.28
157	5785	17.04	17.40	17.40	17.28
165	5825	17.16	17.04	17.28	17.16

802.11ac (VHT20)

Channel	Channel Frequency (MHz)	Occupied Bandwidth (MHz)			
		CHAIN 0	CHAIN 1	CHAIN 2	CHAIN 3
36	5180	18.12	17.88	18.12	18.12
40	5200	18.12	18.00	18.24	18.12
48	5240	18.12	18.00	18.00	18.12
149	5745	18.24	18.48	18.24	18.36
157	5785	18.24	18.48	18.36	18.48
165	5825	18.12	18.48	18.36	18.24

802.11ac (VHT40)

Channel	Channel Frequency (MHz)	Occupied Bandwidth (MHz)			
		CHAIN 0	CHAIN 1	CHAIN 2	CHAIN 3
38	5190	36.72	36.72	36.72	36.96
46	5230	36.96	36.96	36.96	36.96
151	5755	37.20	37.00	36.96	36.96
159	5795	36.96	38.64	36.96	37.44

802.11ac (VHT80)

Channel	Channel Frequency (MHz)	Occupied Bandwidth (MHz)			
		CHAIN 0	CHAIN 1	CHAIN 2	CHAIN 3
42	5210	76.32	76.32	76.32	75.84
155	5775	76.32	78.24	76.32	76.32

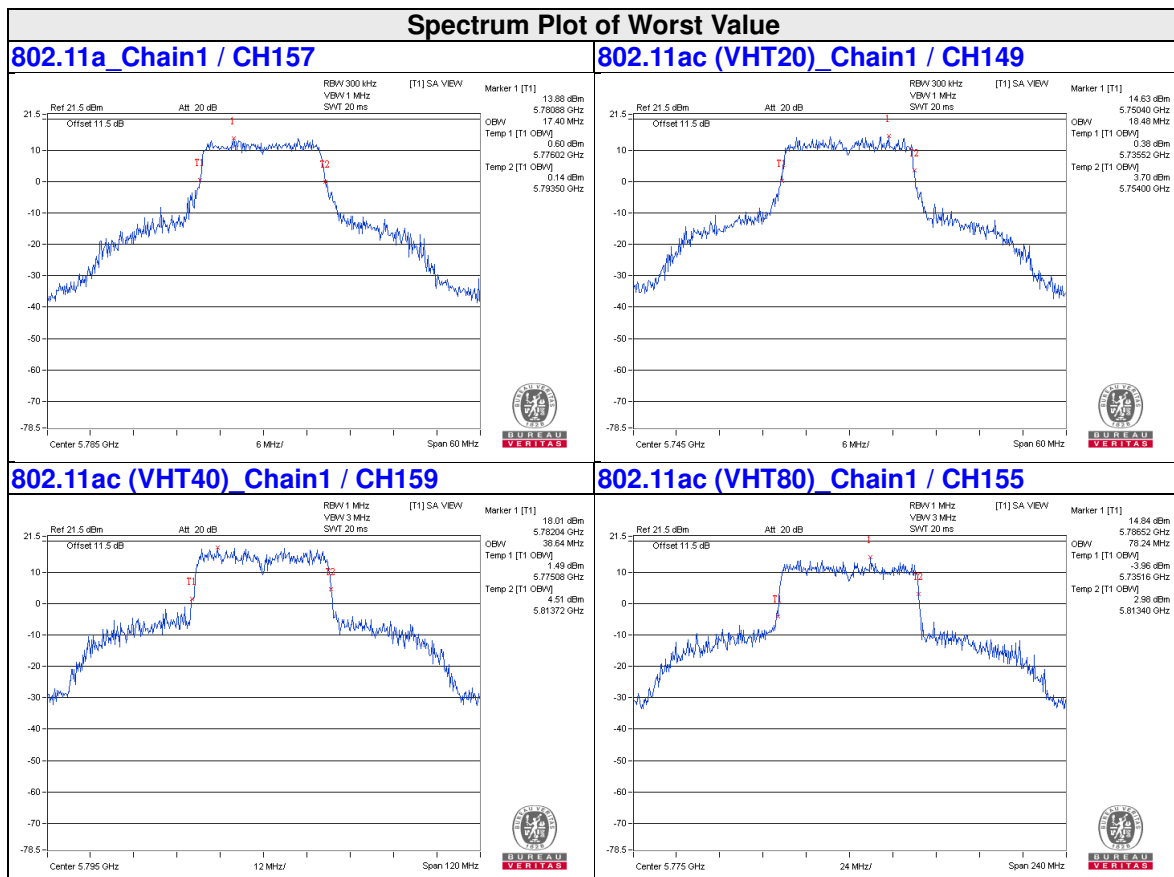

**Spectrum Plot for near by DFS band
(DFS is required, if 99% OCP straddle into U-NII-2A band)**

802.11a_Chain0 / CH48

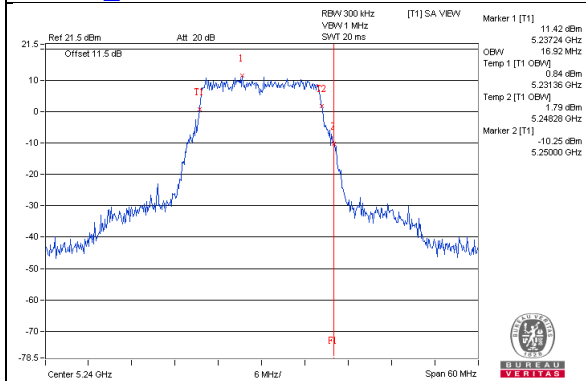

802.11a_Chain1 / CH48

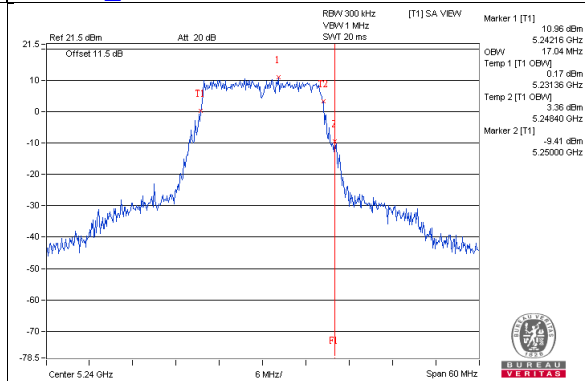

802.11a_Chain2 / CH48

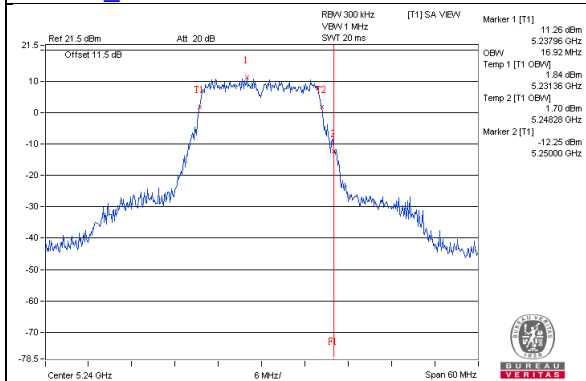

802.11a_Chain3 / CH48

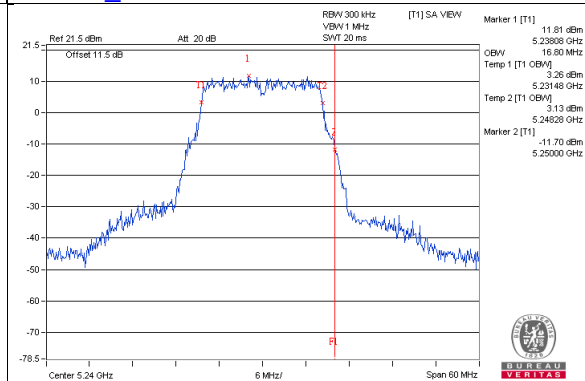

802.11ac(VHT20)_Chain0 / CH48

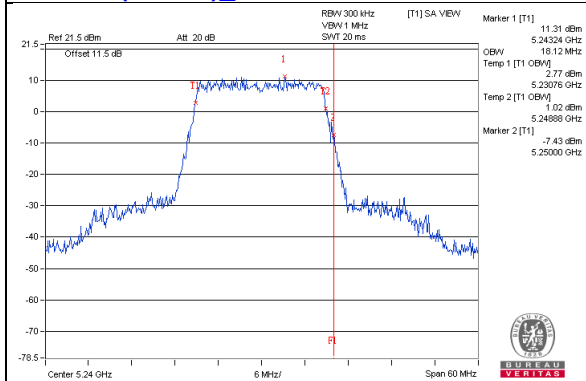

802.11ac(VHT20)_Chain1 / CH48

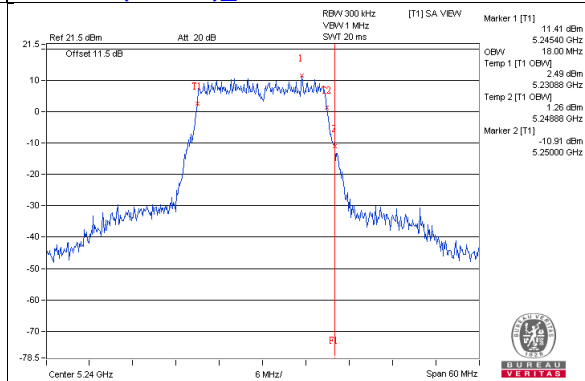

802.11ac(VHT20)_Chain2 / CH48

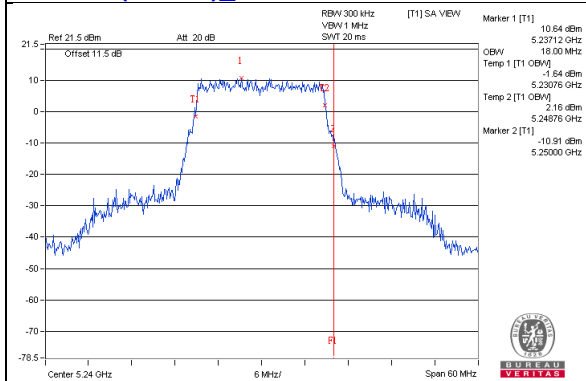

802.11ac(VHT20)_Chain3 / CH48

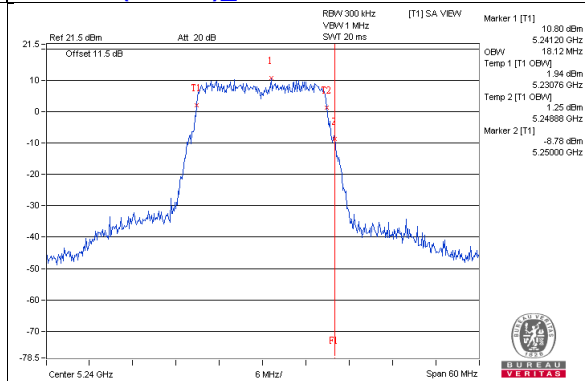

802.11ac(VHT40)_Chain0 / CH46

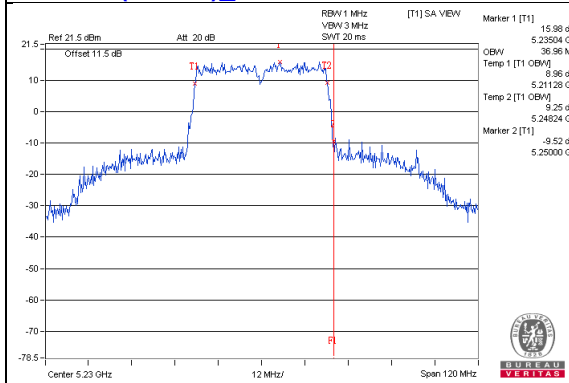

802.11ac(VHT40)_Chain1 / CH46

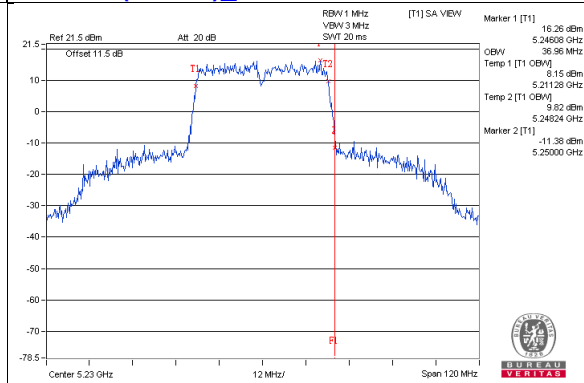

802.11ac(VHT40)_Chain2 / CH46

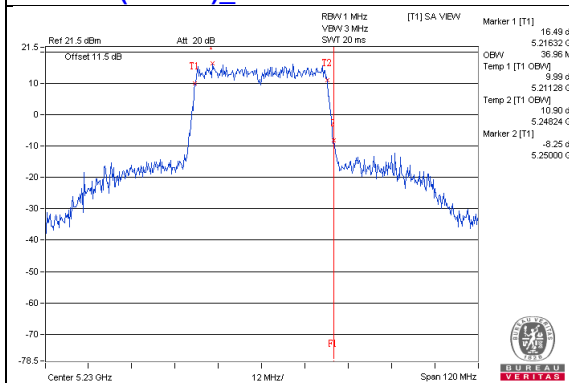

802.11ac(VHT40)_Chain3 / CH46

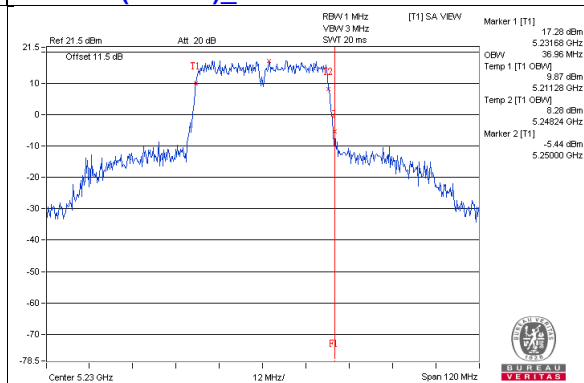

802.11ac(VHT80)_Chain0 / CH42

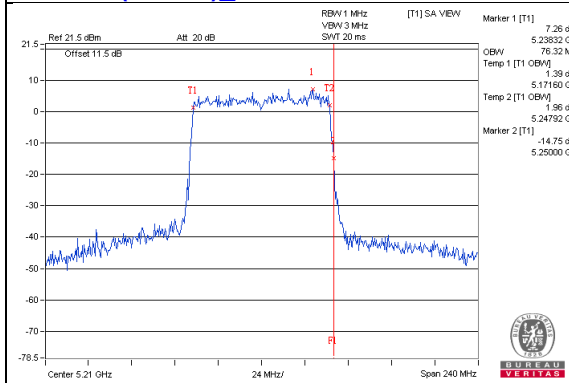

802.11ac(VHT80)_Chain1 / CH42

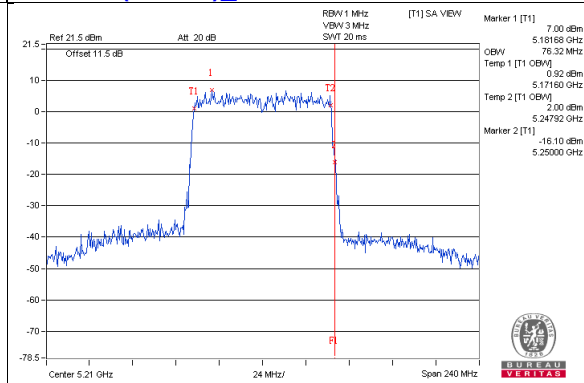

802.11ac(VHT80)_Chain2 / CH42

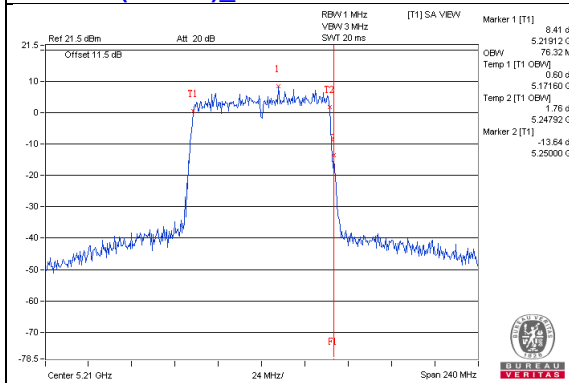

802.11ac(VHT80)_Chain3 / CH42

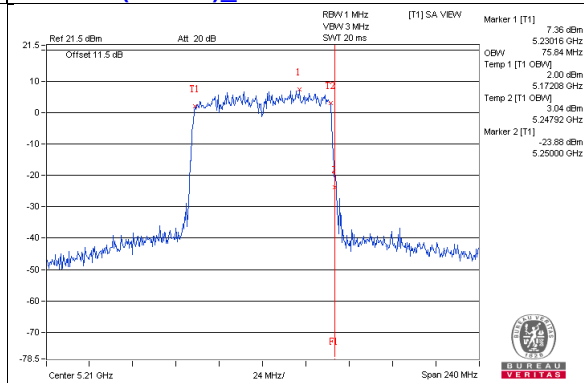

4.5 Peak Power Spectral Density Measurement

4.5.1 Limits of Peak Power Spectral Density Measurement

Operation Band	EUT Category		Limit
U-NII-1		Outdoor Access Point	17dBm/ MHz
		Fixed point-to-point Access Point	
	√	Indoor Access Point	
		Mobile and Portable client device	11dBm/ MHz
U-NII-2A			11dBm/ MHz
U-NII-2C			11dBm/ MHz
U-NII-3	√		30dBm/ 500kHz

4.5.2 Test Setup

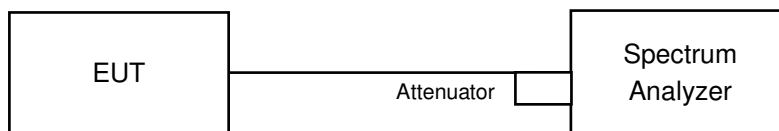

4.5.3 Test Instruments

Refer to section 4.1.2 to get information of above instrument.

4.5.4 Test Procedure

802.11a, 802.11ac (VHT20), 802.11ac (VHT40)

For U-NII-1:

Using method SA-1

1. Set span to encompass the entire emission bandwidth (EBW) of the signal.
2. Set RBW = 1 MHz, Set VBW \geq 3 MHz, Detector = RMS
3. Sweep time = auto, trigger set to "free run".
4. Trace average at least 100 traces in power averaging mode.
5. Record the max value

For U-NII-3:

1. Set span to encompass the entire emission bandwidth (EBW) of the signal.
2. Set RBW = 300 kHz, Set VBW \geq 1 MHz, Detector = RMS
3. Use the peak marker function to determine the maximum power level in any 300 kHz band segment within the fundamental EBW.
4. Scale the observed power level to an equivalent value in 500 kHz by adjusting (reducing) the measured power by a bandwidth correction factor (BWCF) where $BWCF = 10\log(500\text{ kHz}/300\text{kHz})$
5. Sweep time = auto, trigger set to "free run".
6. Trace average at least 100 traces in power averaging mode.
7. Record the max value

802.11ac (VHT80)

For U-NII-1:

Using method SA-2

1. Set span to encompass the entire emission bandwidth (EBW) of the signal.
2. Set RBW = 1 MHz, Set VBW \geq 3 MHz, Detector = RMS
3. Sweep time = auto, trigger set to "free run".
4. Trace average at least 100 traces in power averaging mode.
5. Record the max value and add $10\log(1/\text{duty cycle})$

For U-NII-3:

1. Set span to encompass the entire emission bandwidth (EBW) of the signal.
2. Set RBW = 300 kHz, Set VBW \geq 1 MHz, Detector = RMS
3. Use the peak marker function to determine the maximum power level in any 300 kHz band segment within the fundamental EBW.
4. Scale the observed power level to an equivalent value in 500 kHz by adjusting (reducing) the measured power by a bandwidth correction factor (BWCF) where $BWCF = 10\log(500\text{ kHz}/300\text{kHz})$
5. Sweep time = auto, trigger set to "free run".
6. Trace average at least 100 traces in power averaging mode.
7. Record the max value and add $10\log(1/\text{duty cycle})$

4.5.5 Deviation from Test Standard

No deviation.

4.5.6 EUT Operating Condition

Same as Item 4.3.6.

4.5.7 Test Results

For U-NII-1:

802.11a

Chan.	Chan. Freq. (MHz)	PSD (dBm/MHz)				Total Power Density (dBm/MHz)	MAX. Limit (dBm/MHz)	Pass / Fail
		Chain 0	Chain 1	Chain 2	Chain 3			
36	5180	6.77	6.07	6.70	6.44	12.52	13.36	Pass
40	5200	6.73	6.31	6.26	7.04	12.62	13.36	Pass
48	5240	7.05	6.62	6.74	7.14	12.91	13.36	Pass

- Note:** 1. Method a) of power density measurement of KDB 662911 is using for calculating total power density. Total power density is summing entire spectra across corresponding frequency bins on the various outputs by computer.
2. Directional gain = $3.62\text{dBi} + 10\log(4) = 9.64\text{dBi} > 6\text{dBi}$, so the power density limit shall be reduced to $17 - (9.64 - 6) = 13.36\text{dBm}$.

802.11ac (VHT20)

Chan.	Chan. Freq. (MHz)	PSD (dBm/MHz)				Total Power Density (dBm/MHz)	MAX. Limit (dBm/MHz)	Pass / Fail
		Chain 0	Chain 1	Chain 2	Chain 3			
36	5180	7.12	6.27	6.75	6.35	12.66	13.36	Pass
40	5200	7.36	6.20	6.97	6.00	12.69	13.36	Pass
48	5240	7.36	7.15	7.06	5.97	12.94	13.36	Pass

- Note:** 1. Method a) of power density measurement of KDB 662911 is using for calculating total power density. Total power density is summing entire spectra across corresponding frequency bins on the various outputs by computer.
2. Directional gain = $3.62\text{dBi} + 10\log(4) = 9.64\text{dBi} > 6\text{dBi}$, so the power density limit shall be reduced to $17 - (9.64 - 6) = 13.36\text{dBm}$.

802.11ac (VHT40)

Chan.	Chan. Freq. (MHz)	PSD (dBm/MHz)				Total Power Density (dBm/MHz)	MAX. Limit (dBm/MHz)	Pass / Fail
		Chain 0	Chain 1	Chain 2	Chain 3			
38	5190	0.79	0.59	1.15	0.46	6.78	13.36	Pass
46	5230	6.35	5.75	6.24	7.38	12.49	13.36	Pass

- Note:** 1. Method a) of power density measurement of KDB 662911 is using for calculating total power density. Total power density is summing entire spectra across corresponding frequency bins on the various outputs by computer.
2. Directional gain = $3.62\text{dBi} + 10\log(4) = 9.64\text{dBi} > 6\text{dBi}$, so the power density limit shall be reduced to $17 - (9.64 - 6) = 13.36\text{dBm}$.

802.11ac (VHT80):

Chan.	Chan. Freq. (MHz)	PSD W/O Duty Factor (dBm/MHz)				Duty Factor (dB)	Total PSD With Duty Factor (dBm/MHz)	MAX. Limit (dBm/MHz)	Pass / Fail
		Chain 0	Chain 1	Chain 2	Chain 3				
42	5210	-2.78	-3.15	-2.97	-2.59	0.18	3.33	13.36	Pass

- Note:**
1. Method a) of power density measurement of KDB 662911 is using for calculating total power density. Total power density is summing entire spectra across corresponding frequency bins on the various outputs by computer.
 2. Directional gain = $3.62\text{dBi} + 10\log(4) = 9.64\text{dBi} > 6\text{dBi}$, so the power density limit shall be reduced to $17 - (9.64 - 6) = 13.36\text{dBm}$.
 3. Refer to section 3.3 for duty cycle spectrum plot.

Spectrum Plot of Worst Value

802.11a_Chain 3 / CH48

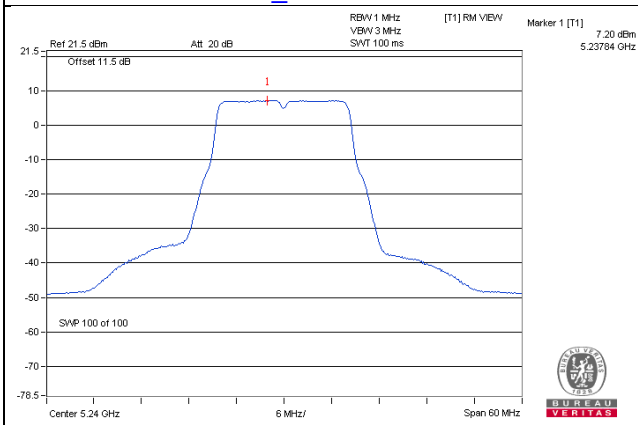

802.11ac (VHT20)_Chain 0 / CH40

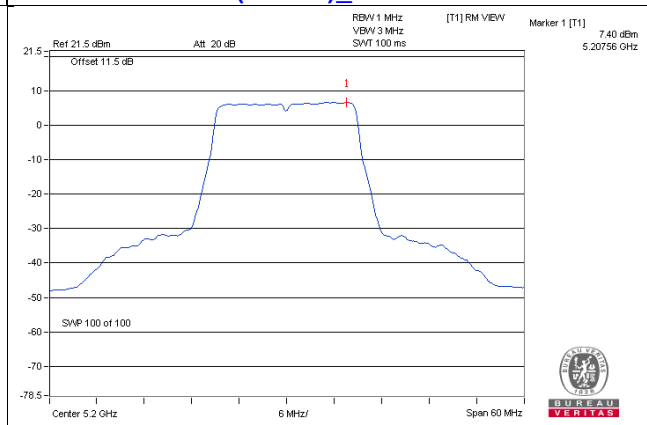

802.11ac (VHT40)_Chain 3 / CH46

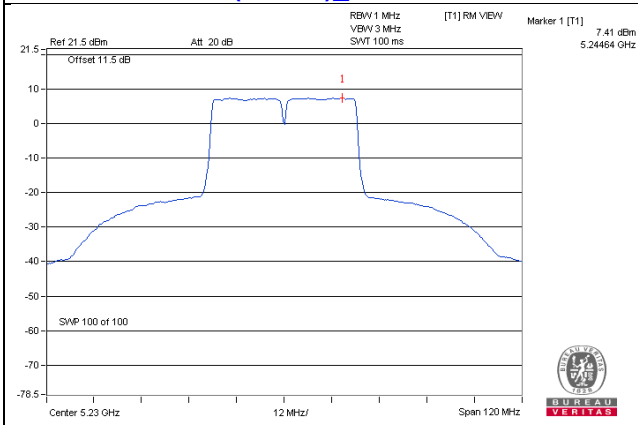

802.11ac (VHT80)_Chain 3 / CH42

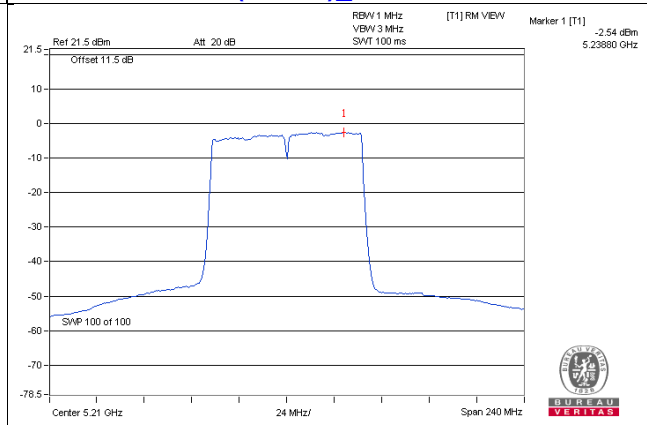

For U-NII-3:

802.11a

TX chain	Channel	Freq. (MHz)	PSD (dBm/300kHz)	PSD (dBm/500kHz)	10 log (N=4) dB	Total PSD (dBm/500kHz)	Limit (dBm/500kHz)	Pass /Fail
0	149	5745	1.72	3.94	6.02	9.96	27.64	Pass
	157	5785	2.06	4.28	6.02	10.30	27.64	Pass
	165	5825	1.97	4.19	6.02	10.21	27.64	Pass
1	149	5745	1.73	3.95	6.02	9.97	27.64	Pass
	157	5785	2.99	5.21	6.02	11.23	27.64	Pass
	165	5825	1.68	3.90	6.02	9.92	27.64	Pass
2	149	5745	2.30	4.52	6.02	10.54	27.64	Pass
	157	5785	2.19	4.41	6.02	10.43	27.64	Pass
	165	5825	2.19	4.41	6.02	10.43	27.64	Pass
3	149	5745	3.19	5.41	6.02	11.43	27.64	Pass
	157	5785	2.89	5.11	6.02	11.13	27.64	Pass
	165	5825	2.92	5.14	6.02	11.16	27.64	Pass

Note: 1. Directional gain = $2.34\text{dBi} + 10\log(4) = 8.36\text{dBi} > 6\text{dBi}$, so the power density limit shall be reduced to $30 - (8.36 - 6) = 27.64\text{dBm}$.

802.11ac (VHT20)

TX chain	Channel	Freq. (MHz)	PSD (dBm/300kHz)	PSD (dBm/500kHz)	10 log (N=4) dB	Total PSD (dBm/500kHz)	Limit (dBm/500kHz)	Pass /Fail
0	149	5745	1.23	3.45	6.02	9.47	27.64	Pass
	157	5785	1.36	3.58	6.02	9.60	27.64	Pass
	165	5825	1.43	3.65	6.02	9.67	27.64	Pass
1	149	5745	1.85	4.07	6.02	10.09	27.64	Pass
	157	5785	1.93	4.15	6.02	10.17	27.64	Pass
	165	5825	1.89	4.11	6.02	10.13	27.64	Pass
2	149	5745	1.66	3.88	6.02	9.90	27.64	Pass
	157	5785	1.78	4.00	6.02	10.02	27.64	Pass
	165	5825	1.58	3.80	6.02	9.82	27.64	Pass
3	149	5745	2.56	4.78	6.02	10.80	27.64	Pass
	157	5785	2.48	4.70	6.02	10.72	27.64	Pass
	165	5825	2.35	4.57	6.02	10.59	27.64	Pass

Note: 1. Directional gain = $2.34\text{dBi} + 10\log(4) = 8.36\text{dBi} > 6\text{dBi}$, so the power density limit shall be reduced to $30 - (8.36 - 6) = 27.64\text{dBm}$.

802.11ac (VHT40)

TX chain	Channel	Freq. (MHz)	PSD (dBm/300kHz)	PSD (dBm/500kHz)	10 log (N=4) dB	Total PSD (dBm/500kHz)	Limit (dBm/500kHz)	Pass /Fail
0	151	5755	-5.55	-3.33	6.02	2.69	27.64	Pass
	159	5795	-2.10	0.12	6.02	6.14	27.64	Pass
1	151	5755	-2.05	0.17	6.02	6.19	27.64	Pass
	159	5795	-0.66	1.56	6.02	7.58	27.64	Pass
2	151	5755	-2.25	-0.03	6.02	5.99	27.64	Pass
	159	5795	-2.36	-0.14	6.02	5.88	27.64	Pass
3	149	5745	-1.03	1.19	6.02	7.21	27.64	Pass
	151	5755	-0.83	1.39	6.02	7.41	27.64	Pass

Note: 1. Directional gain = $2.34\text{dBi} + 10\log(4) = 8.36\text{dBi} > 6\text{dBi}$, so the power density limit shall be reduced to $30 - (8.36 - 6) = 27.64\text{dBm}$.

802.11ac (VHT80)

TX chain	Chan.	Chan. Freq. (MHz)	PSD W/O Duty Factor		10 log (N=4) dB	Duty Factor (dB)	Total PSD With Duty Factor (dBm/500kHz)	Limit (dBm/500kHz)	Pass /Fail
			(dBm/300kHz)	(dBm/500kHz)					
0	155	5775	-5.60	-3.38	6.02	0.18	2.82	27.64	Pass
1	155	5775	-9.56	-7.34	6.02	0.18	-1.14	27.64	Pass
2	155	5775	-4.32	-2.10	6.02	0.18	4.10	27.64	Pass
3	155	5775	-4.46	-2.24	6.02	0.18	3.96	27.64	Pass

Note: 1. Directional gain = $2.34\text{dBi} + 10\log(4) = 8.36\text{dBi} > 6\text{dBi}$, so the power density limit shall be reduced to $30 - (8.36 - 6) = 27.64\text{dBm}$.

2. Refer to section 3.3 for duty cycle spectrum plot.

Spectrum Plot of Worst Value

802.11a_Chain 3 / CH149

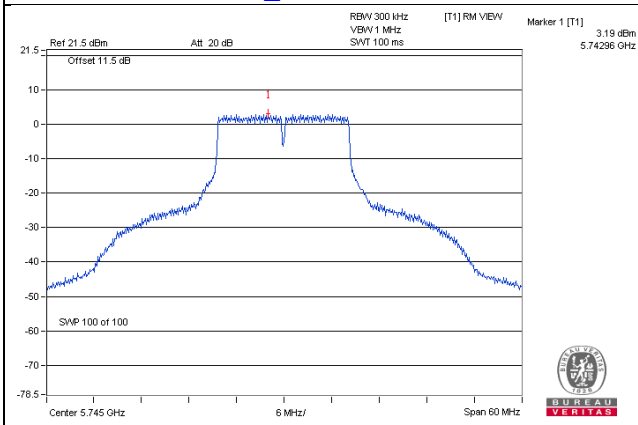

802.11ac (VHT20)_Chain 3 / CH149

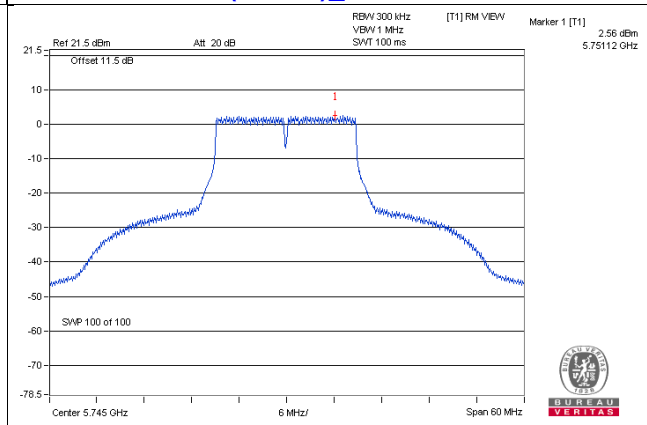

802.11ac (VHT40)_Chain 1 / CH159

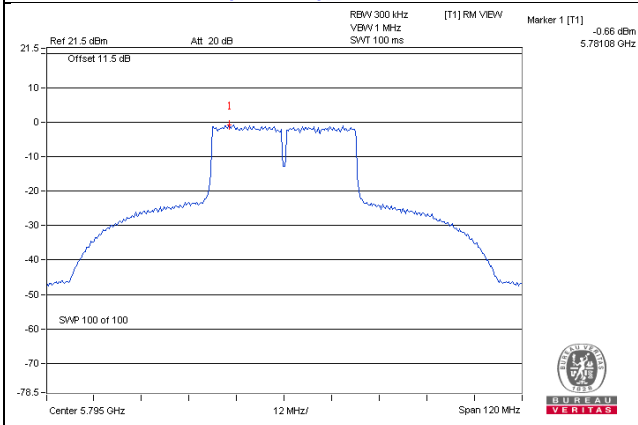

802.11ac (VHT80)_Chain 2 / CH155

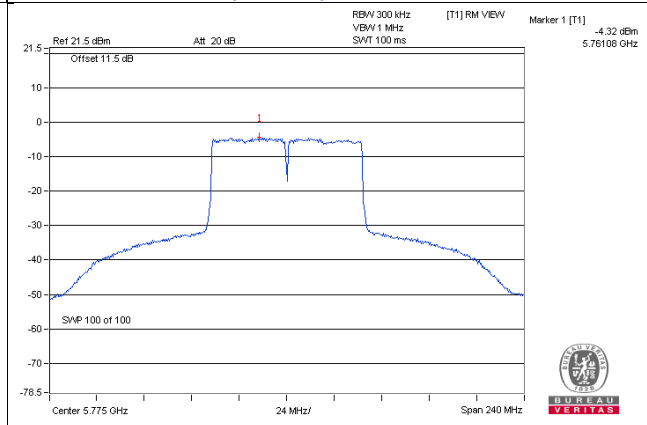

4.6 Frequency Stability Measurement

4.6.1 Limits of Frequency Stability Measurement

The frequency of the carrier signal shall be maintained within band of operation

4.6.2 Test Setup

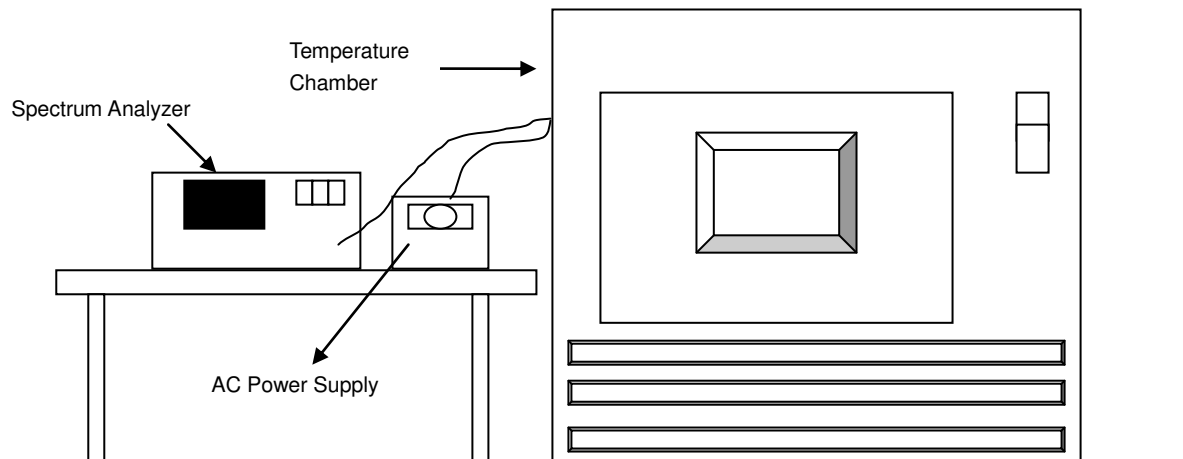

4.6.3 Test Instruments

Refer to section 4.1.2 to get information of above instrument.

4.6.4 Test Procedure

- The EUT was placed inside the environmental test chamber and powered by nominal AC voltage.
- Turn the EUT on and couple its output to a spectrum analyzer.
- Turn the EUT off and set the chamber to the highest temperature specified.
- Allow sufficient time (approximately 30 min) for the temperature of the chamber to stabilize, turn the EUT on and measure the operating frequency after 2, 5, and 10 Minutes.
- Repeat step 2 and 3 with the temperature chamber set to the lowest temperature.
- The test chamber was allowed to stabilize at +20 degree C for a minimum of 30 Minutes. The supply voltage was then adjusted on the EUT from 85% to 115% and the frequency record.

4.6.5 Deviation from Test Standard

No deviation.

4.6.6 EUT Operating Condition

Set the EUT transmit at un-modulation mode to test frequency stability.

4.6.7 Test Results

Frequency Stability Versus Temp.									
Operating Frequency: 5180 MHz									
TEMP. (°C)	Power Supply (Vac)	0 Minute		2 Minute		5 Minute		10 Minute	
		Measured Frequency (MHz)	Pass/Fail	Measured Frequency (MHz)	Pass/Fail	Measured Frequency (MHz)	Pass/Fail	Measured Frequency (MHz)	Pass/Fail
50	120	5180.0099	Pass	5180.0091	Pass	5180.0088	Pass	5180.0059	Pass
40	120	5180.0228	Pass	5180.0233	Pass	5180.0242	Pass	5180.025	Pass
30	120	5179.9923	Pass	5179.9945	Pass	5179.9927	Pass	5179.9901	Pass
20	120	5180.0016	Pass	5179.9986	Pass	5180.0003	Pass	5179.999	Pass
10	120	5180.0054	Pass	5180.0088	Pass	5180.0093	Pass	5180.0057	Pass
0	120	5179.9934	Pass	5179.9939	Pass	5179.9914	Pass	5179.991	Pass
-10	120	5179.9936	Pass	5179.9926	Pass	5179.9921	Pass	5179.9947	Pass
-20	120	5179.9853	Pass	5179.985	Pass	5179.9818	Pass	5179.9848	Pass
-30	120	5180.01	Pass	5180.0113	Pass	5180.0126	Pass	5180.0122	Pass

Frequency Stability Versus Voltage									
Operating Frequency: 5180 MHz									
TEMP. (°C)	Power Supply (Vac)	0 Minute		2 Minute		5 Minute		10 Minute	
		Measured Frequency (MHz)	Pass/Fail	Measured Frequency (MHz)	Pass/Fail	Measured Frequency (MHz)	Pass/Fail	Measured Frequency (MHz)	Pass/Fail
20	138	5180.0025	Pass	5179.9984	Pass	5179.9994	Pass	5179.9993	Pass
	120	5180.0016	Pass	5179.9986	Pass	5180.0003	Pass	5179.999	Pass
	102	5180.0014	Pass	5179.9976	Pass	5180.0004	Pass	5179.9992	Pass

4.7 6dB Bandwidth Measurement

4.7.1 Limits of 6dB Bandwidth Measurement

The minimum of 6dB Bandwidth Measurement is 0.5MHz.

4.7.2 Test Setup

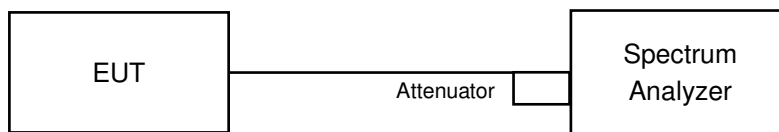

4.7.3 Test Instruments

Refer to section 4.1.2 to get information of above instrument.

4.7.4 Test Procedure

MEASUREMENT PROCEDURE REF

- a. Set resolution bandwidth (RBW) = 100kHz
- b. Set the video bandwidth (VBW) $\geq 3 \times$ RBW, Detector = Peak.
- c. Trace mode = max hold.
- d. Sweep = auto couple.
- e. Measure the maximum width of the emission that is constrained by the frequencies associated with the two amplitude points (upper and lower) that are attenuated by 6 dB relative to the maximum level measured in the fundamental emission

4.7.5 Deviation from Test Standard

No deviation.

4.7.6 EUT Operating Condition

The software provided by client to enable the EUT under transmission condition continuously at lowest, middle and highest channel frequencies individually.

4.7.7 Test Results

802.11a

Channel	Frequency (MHz)	6dB Bandwidth (MHz)				Minimum Limit (MHz)	Pass / Fail
		Chain 0	Chain 1	Chain 2	Chain 3		
149	5745	16.42	16.41	16.38	16.39	0.5	Pass
157	5785	16.40	16.39	16.39	16.41	0.5	Pass
165	5825	16.40	16.38	16.39	16.39	0.5	Pass

802.11ac (VHT20)

Channel	Frequency (MHz)	6dB Bandwidth (MHz)				Minimum Limit (MHz)	Pass / Fail
		Chain 0	Chain 1	Chain 2	Chain 3		
149	5745	17.65	17.67	17.64	17.65	0.5	Pass
157	5785	17.64	17.64	17.65	17.65	0.5	Pass
165	5825	17.66	17.65	17.65	17.67	0.5	Pass

802.11ac (VHT40)

Channel	Frequency (MHz)	6dB Bandwidth (MHz)				Minimum Limit (MHz)	Pass / Fail
		Chain 0	Chain 1	Chain 2	Chain 3		
151	5755	36.46	36.40	36.47	36.48	0.5	Pass
159	5795	36.47	36.48	36.50	36.46	0.5	Pass

802.11ac (VHT80)

Channel	Frequency (MHz)	6dB Bandwidth (MHz)				Minimum Limit (MHz)	Pass / Fail
		Chain 0	Chain 1	Chain 2	Chain 3		
155	5775	76.41	76.07	76.46	76.28	0.5	Pass

Spectrum Plot of Worst Value

802.11a / Chain 2 : CH149

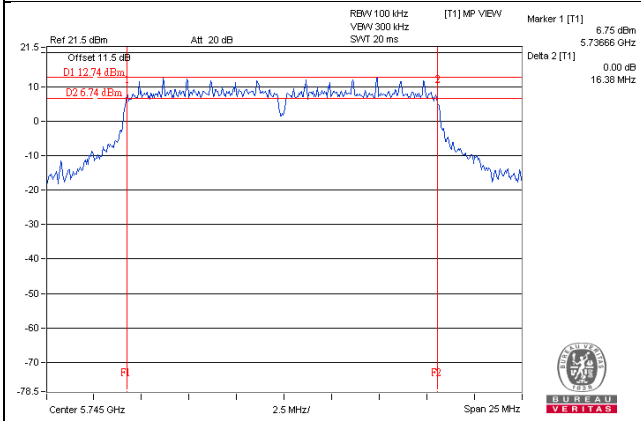

802.11ac(VHT20) / Chain 0 : CH157

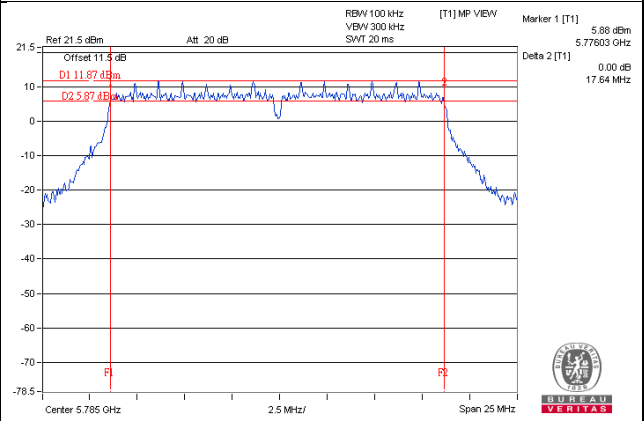

802.11ac(VHT40) / Chain 1 : CH151

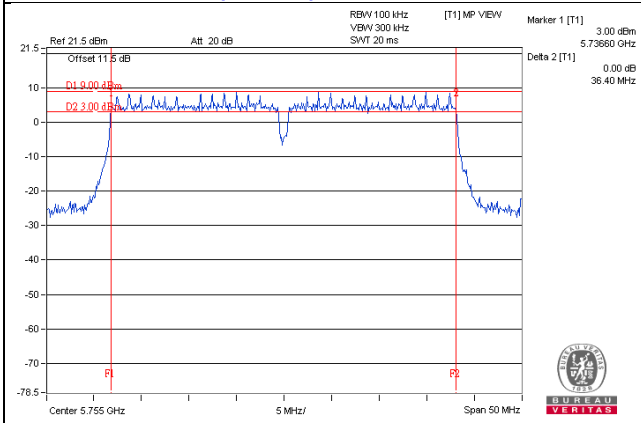

802.11ac(VHT80) / Chain 1 : CH155

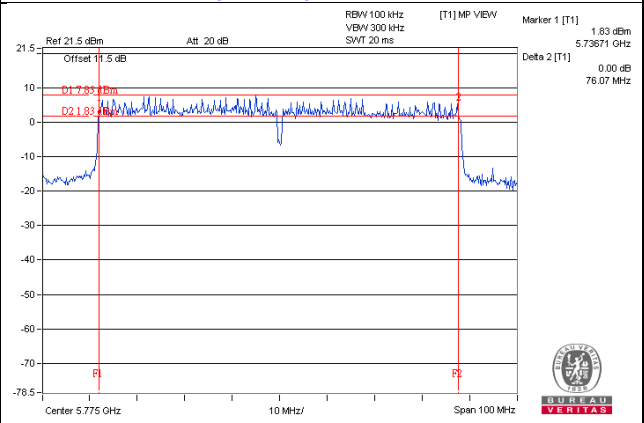

5 Pictures of Test Arrangements

Please refer to the attached file (Test Setup Photo).

Annex A- Radiated Out of Band Emission (OOBE) Measurement (For U-NII-3 band)

Mode 1

802.11a

CH 149 5745 MHz

Horizontal

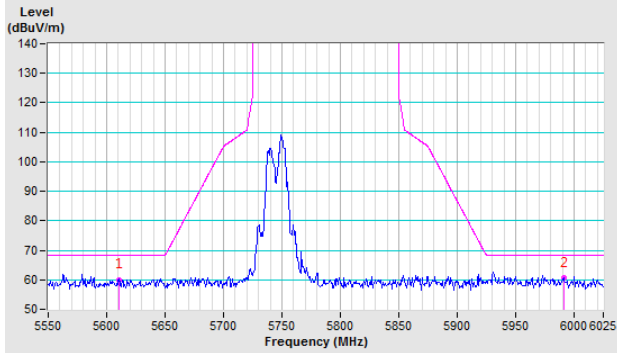

Vertical

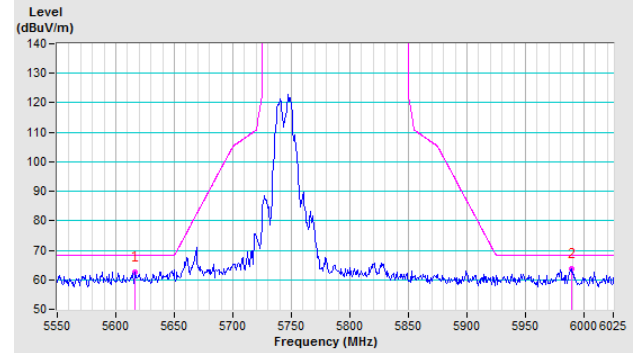

CH 157 5785 MHz

Horizontal

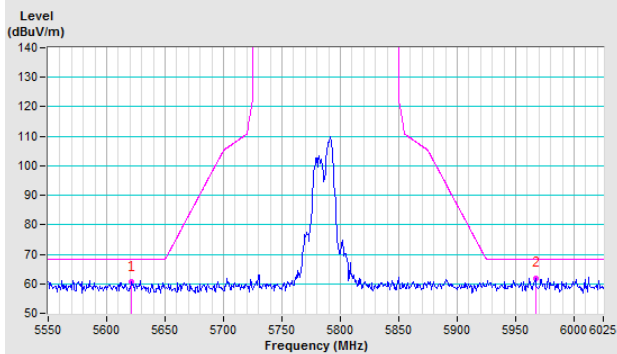

Vertical

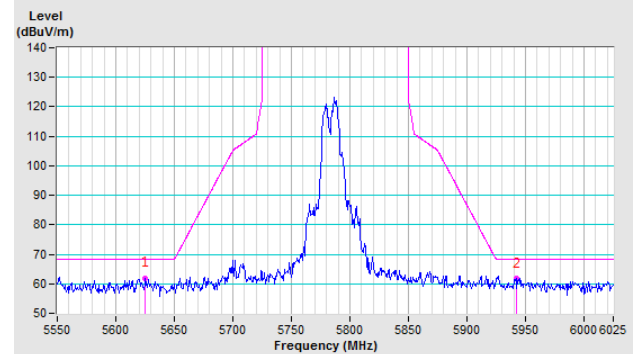

CH 165 5825 MHz

Horizontal

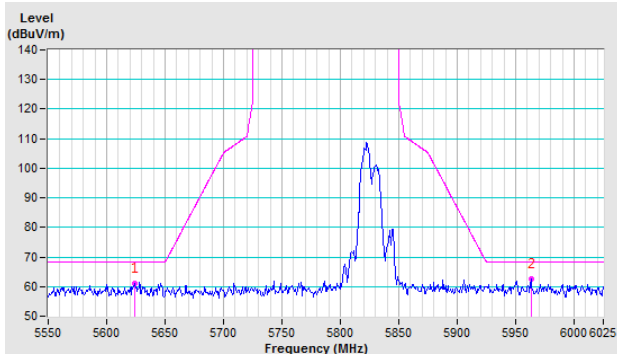

Vertical

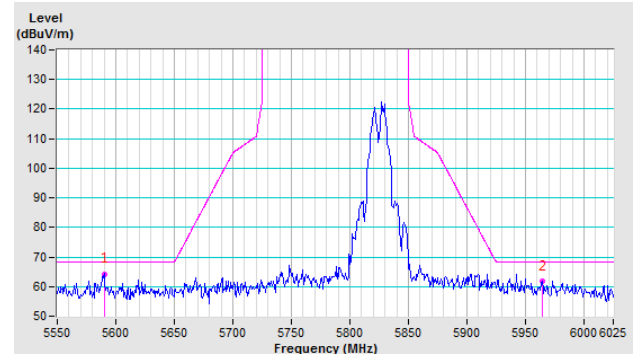

802.11ac (VHT20)

CH 149 5745 MHz

Horizontal

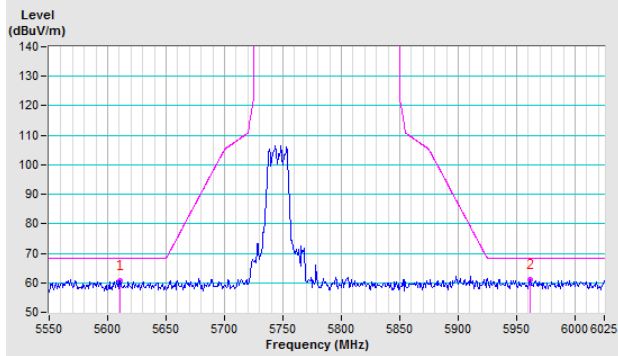

Vertical

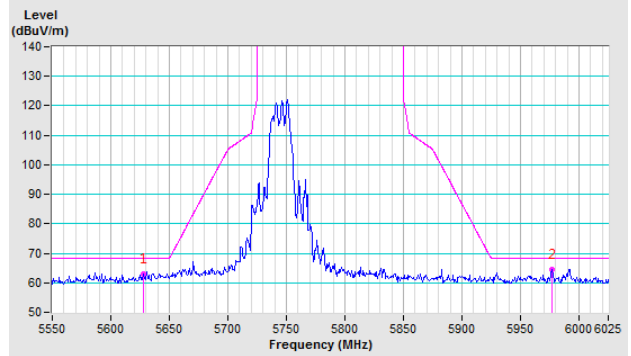

CH 157 5785 MHz

Horizontal

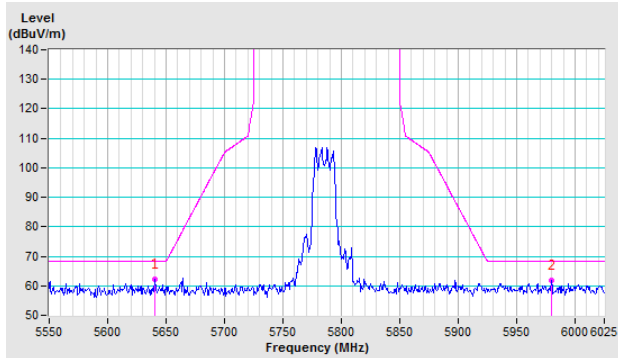

Vertical

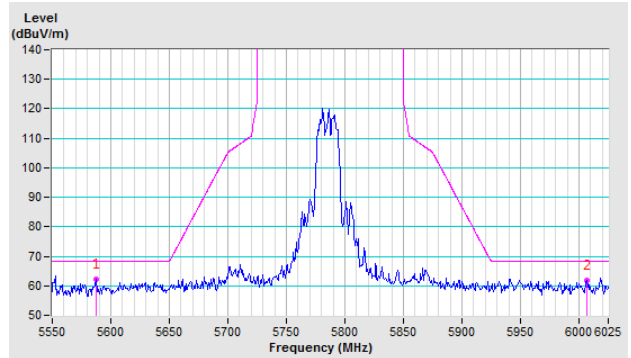

CH 165 5825 MHz

Horizontal

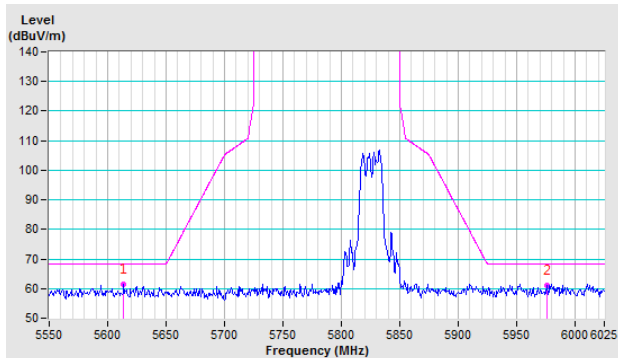

Vertical

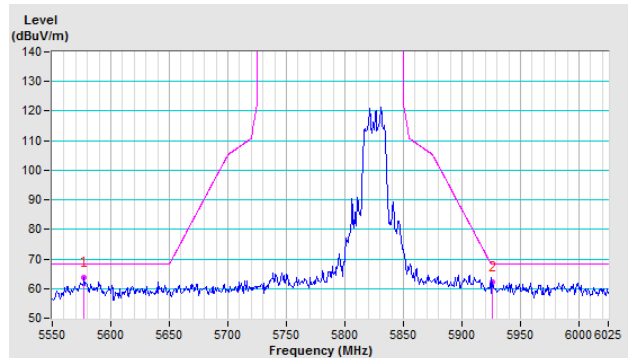

802.11ac (VHT40)

CH 151 5755 MHz

Horizontal

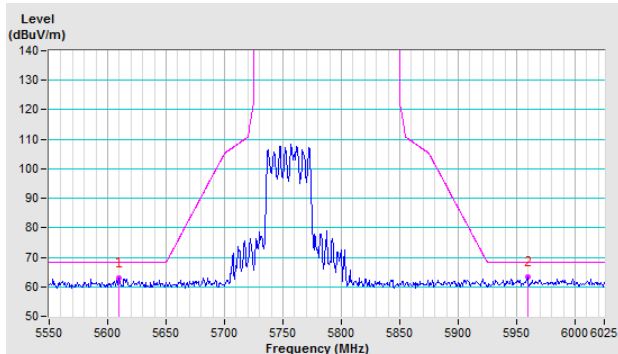

Vertical

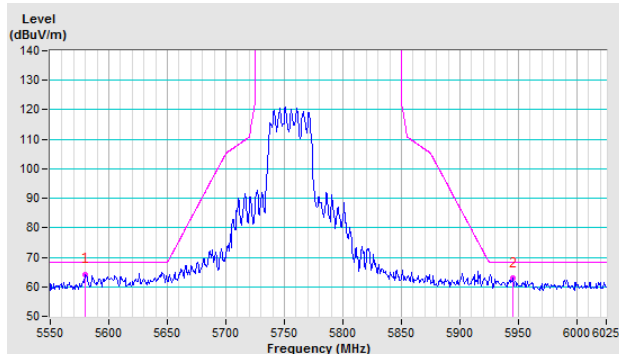

CH 159 5795 MHz

Horizontal

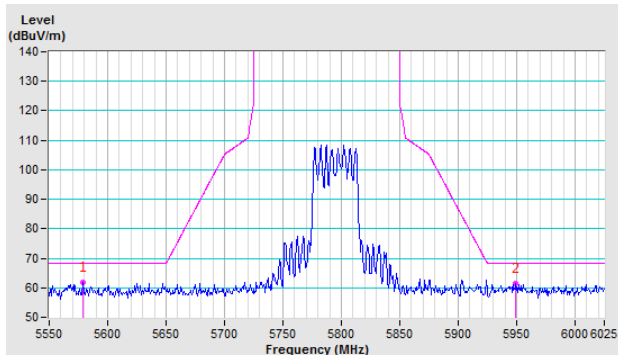

Vertical

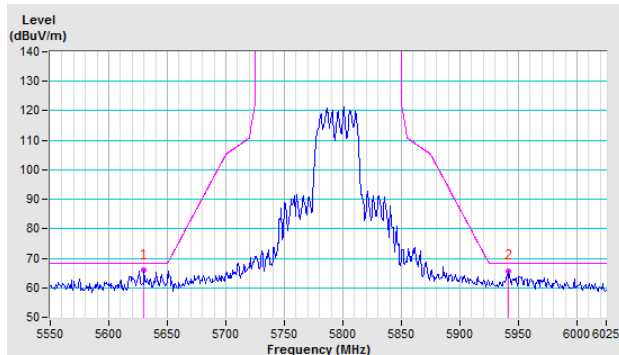

802.11ac (VHT80)

CH 155 5775 MHz

Horizontal

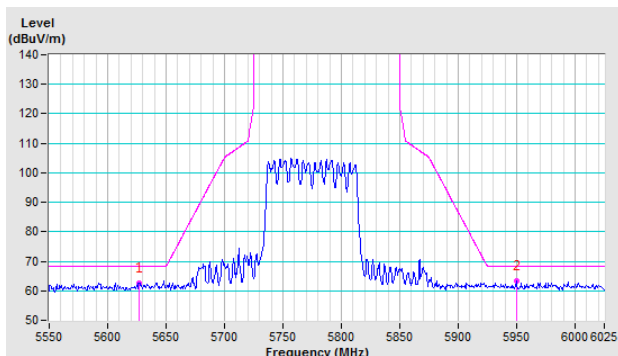

Vertical

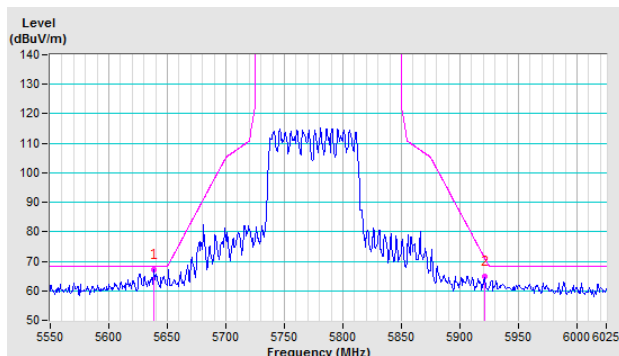

Mode 2

802.11a

CH 149 5745 MHz

Horizontal

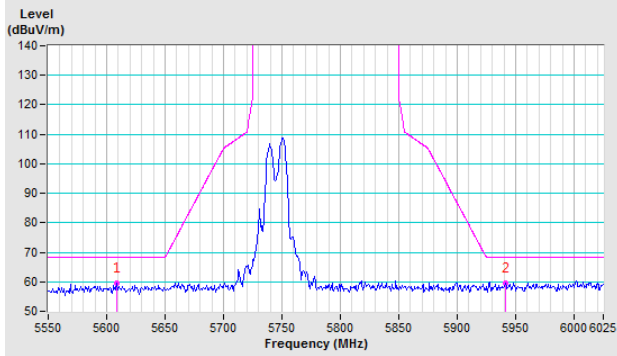

Vertical

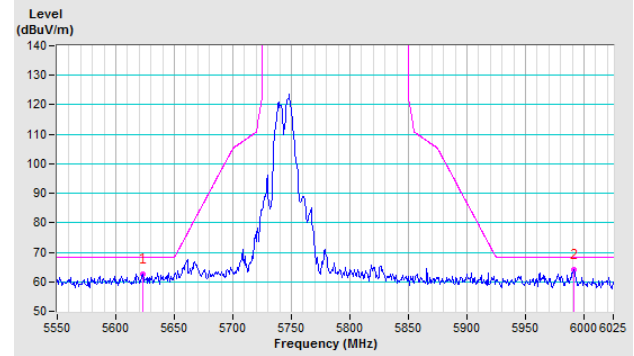

CH 157 5785 MHz

Horizontal

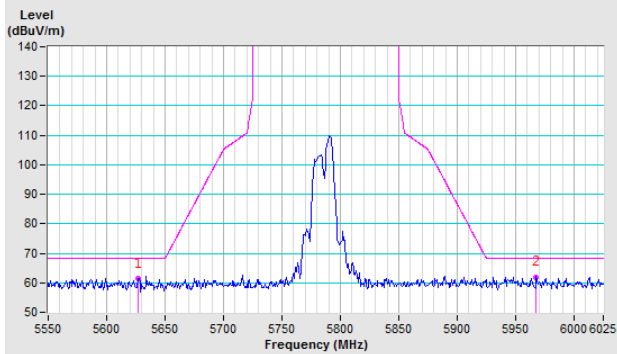

Vertical

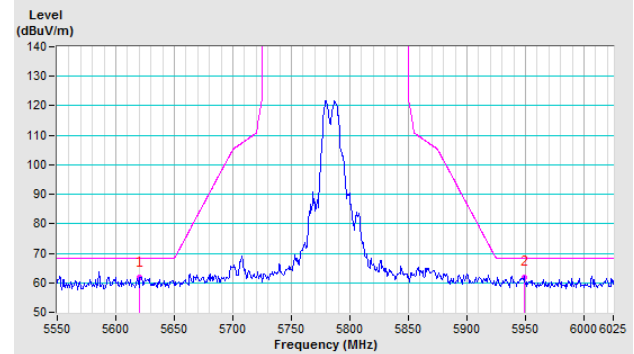

CH 165 5825 MHz

Horizontal

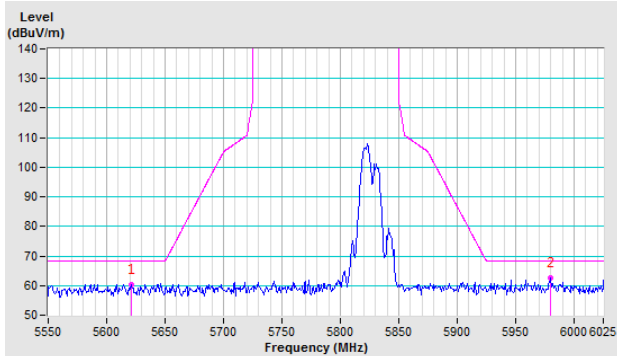

Vertical

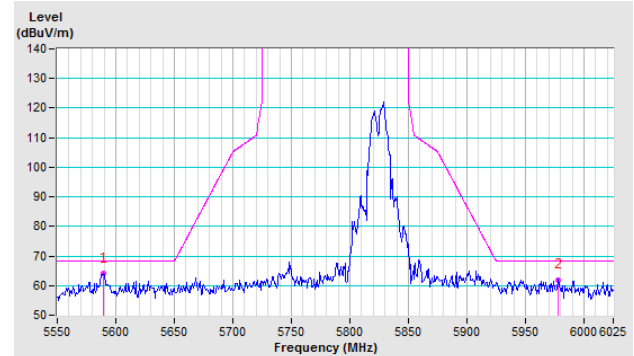

802.11ac (VHT20)

CH 149 5745 MHz

Horizontal

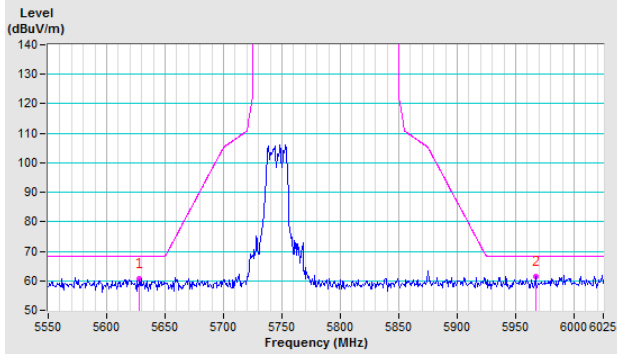

Vertical

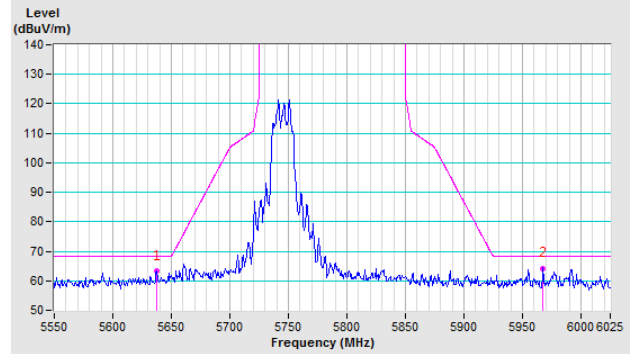

CH 157 5785 MHz

Horizontal

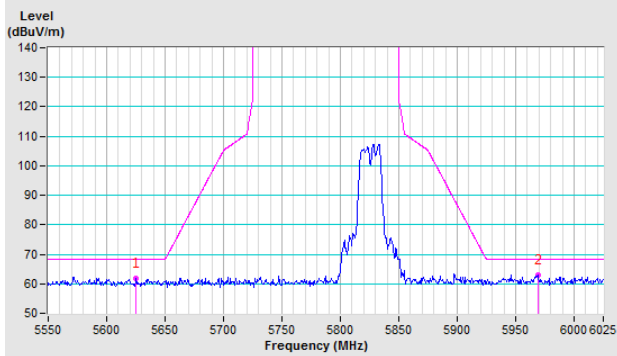

Vertical

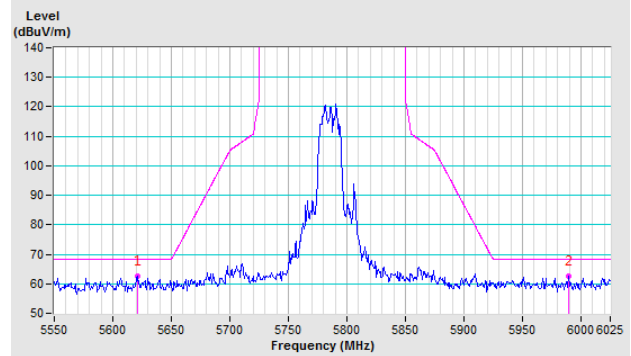

CH 165 5825 MHz

Horizontal

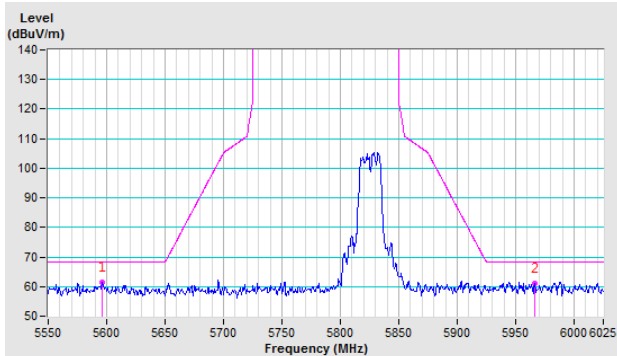

Vertical

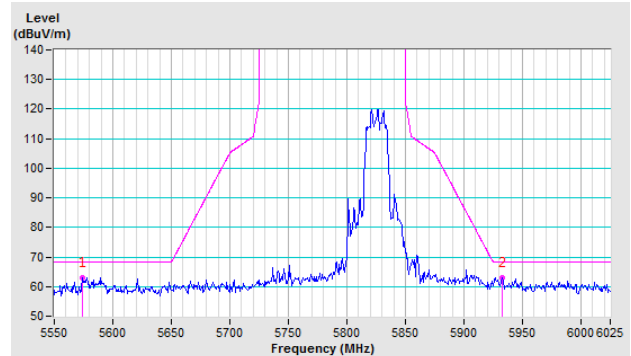

802.11ac (VHT40)

CH 151 5755 MHz

Horizontal

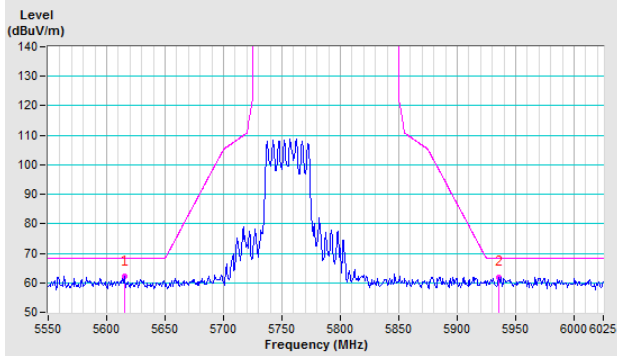

Vertical

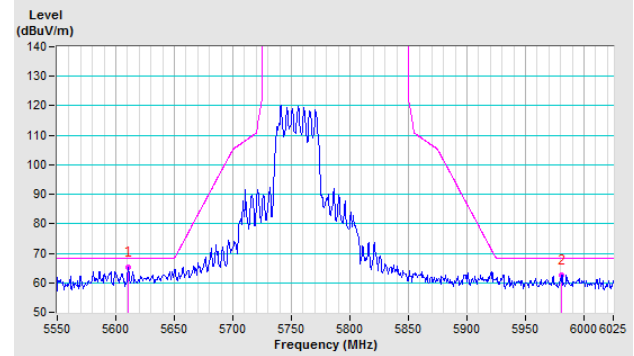

CH 159 5795 MHz

Horizontal

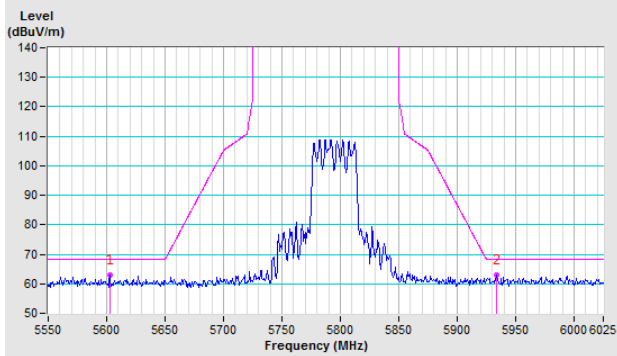

Vertical

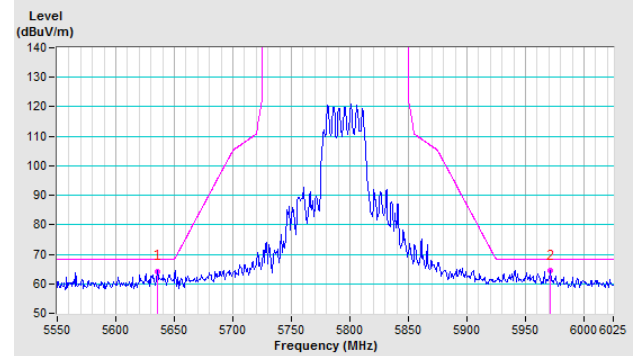

802.11ac (VHT80)

CH 155 5775 MHz

Horizontal

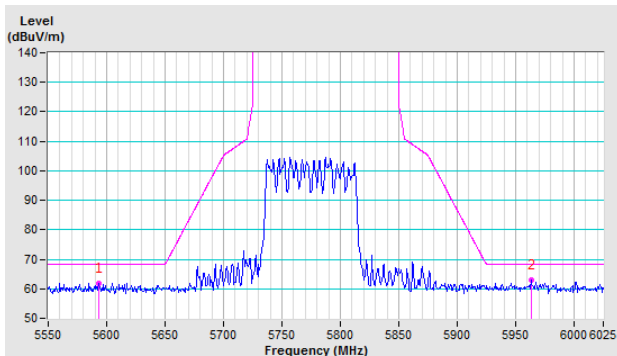

Vertical

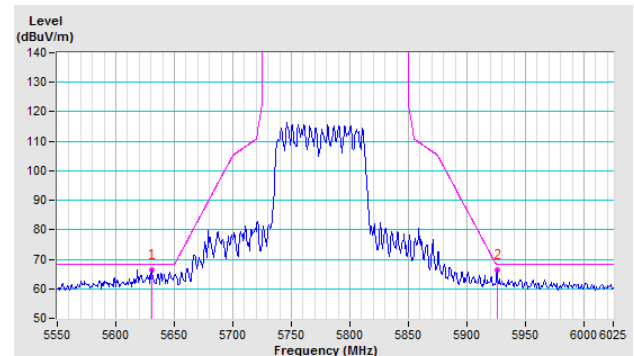

Appendix – Information on the Testing Laboratories

We, Bureau Veritas Consumer Products Services (H.K.) Ltd., Taoyuan Branch, were founded in 1988 to provide our best service in EMC, Radio, Telecom and Safety consultation. Our laboratories are accredited and approved according to ISO/IEC 17025.

If you have any comments, please feel free to contact us at the following:

Linko EMC/RF Lab

Tel: 886-2-26052180

Fax: 886-2-26051924

Hsin Chu EMC/RF/Telecom Lab

Tel: 886-3-6668565

Fax: 886-3-6668323

Hwa Ya EMC/RF/Safety Lab

Tel: 886-3-3183232

Fax: 886-3-3270892

Email: service.adt@tw.bureauveritas.com

Web Site: www.bureauveritas-adt.com

The address and road map of all our labs can be found in our web site also.

--- END ---