

FCC Test Report

Report No.: RF160707E01-1

FCC ID: W59XWR1200

Test Model: XWR-1200

Received Date: July 07, 2016

Test Date: July 25 to Aug. 02, 2016

Issued Date: Aug. 23, 2016

Applicant: Luxul Wireless

Address: 14203 Minuteman Dr Suite 201 Draper UT 84020 USA

Issued By: Bureau Veritas Consumer Products Services (H.K.) Ltd., Taoyuan Branch
Hsin Chu Laboratory

Lab Address: E-2, No.1, Li Hsin 1st Road, Hsinchu Science Park, Hsinchu City 300,
Taiwan R.O.C.

Test Location (1): E-2, No.1, Li Hsin 1st Road, Hsinchu Science Park, Hsinchu City 300,
Taiwan R.O.C.

Test Location (2): No. 49, Ln. 206, Wende Rd., Shangshan Tsuen, Chiung Lin Hsiang, Hsin
Chu Hsien 307, Taiwan R.O.C.



This report is for your exclusive use. Any copying or replication of this report to or for any other person or entity, or use of our name or trademark, is permitted only with our prior written permission. This report sets forth our findings solely with respect to the test samples identified herein. The results set forth in this report are not indicative or representative of the quality or characteristics of the lot from which a test sample was taken or any similar or identical product unless specifically and expressly noted. Our report includes all of the tests requested by you and the results thereof based upon the information that you provided to us. You have 60 days from date of issuance of this report to notify us of any material error or omission caused by our negligence, provided, however, that such notice shall be in writing and shall specifically address the issue you wish to raise. A failure to raise such issue within the prescribed time shall constitute your unqualified acceptance of the completeness of this report, the tests conducted and the correctness of the report contents. Unless specific mention, the uncertainty of measurement has been explicitly taken into account to declare the compliance or non-compliance to the specification. The report must not be used by the client to claim product certification, approval, or endorsement by TAF or any government agencies.

Table of Contents

Release Control Record	4
1 Certificate of Conformity	5
2 Summary of Test Results	6
2.1 Measurement Uncertainty	6
2.2 Modification Record	6
3 General Information	7
3.1 General Description of EUT	7
3.2 Description of Test Modes	9
3.2.1 Test Mode Applicability and Tested Channel Detail	10
3.3 Duty Cycle of Test Signal	12
3.4 Description of Support Units	13
3.4.1 Configuration of System under Test	14
3.5 General Description of Applied Standard	15
4 Test Types and Results	16
4.1 Radiated Emission and Bandedge Measurement	16
4.1.1 Limits of Radiated Emission and Bandedge Measurement	16
4.1.2 Test Instruments	17
4.1.3 Test Procedure	18
4.1.4 Deviation from Test Standard	18
4.1.5 Test Setup	19
4.1.6 EUT Operating Condition	19
4.1.7 Test Results (Mode 1)	20
4.1.8 Test Results (Mode 2)	39
4.2 Conducted Emission Measurement	58
4.2.1 Limits of Conducted Emission Measurement	58
4.2.2 Test Instruments	58
4.2.3 Test Procedure	59
4.2.4 Deviation from Test Standard	59
4.2.5 Test Setup	59
4.2.6 EUT Operating Condition	59
4.2.7 Test Results (Mode 1)	60
4.2.8 Test Results (Mode 2)	62
4.3 Transmit Power Measurement	64
4.3.1 Limits of Transmit Power Measurement	64
4.3.2 Test Setup	64
4.3.3 Test Instruments	64
4.3.4 Test Procedure	64
4.3.5 Deviation from Test Standard	64
4.3.6 EUT Operating Condition	64
4.3.7 Test Result	65
4.4 Occupied Bandwidth Measurement	67
4.4.1 Test Setup	67
4.4.2 Test Instruments	67
4.4.3 Test Procedure	67
4.4.4 Test Result	67
4.5 Peak Power Spectral Density Measurement	71
4.5.1 Limits of Peak Power Spectral Density Measurement	71
4.5.2 Test Setup	71
4.5.3 Test Instruments	71
4.5.4 Test Procedure	72
4.5.5 Deviation from Test Standard	72
4.5.6 EUT Operating Condition	72
4.5.7 Test Results	73

4.6	Frequency Stability Measurement.....	79
4.6.1	Limits of Frequency Stability Measurement	79
4.6.2	Test Setup.....	79
4.6.3	Test Instruments	79
4.6.4	Test Procedure	79
4.6.5	Deviation from Test Standard	79
4.6.6	EUT Operating Condition	79
4.6.7	Test Results	80
4.7	6dB Bandwidth Measurement.....	81
4.7.1	Limits of 6dB Bandwidth Measurement.....	81
4.7.2	Test Setup.....	81
4.7.3	Test Instruments	81
4.7.4	Test Procedure	81
4.7.5	Deviation from Test Standard	81
4.7.6	EUT Operating Condition	81
4.7.7	Test Results	82
5	Pictures of Test Arrangements.....	84
	Annex A- Radiated Out of Band Emission (OOBE) Measurement (For U-NII-3 band).....	85
	Appendix – Information on the Testing Laboratories	91

Release Control Record

Issue No.	Description	Date Issued
RF160707E01-1	Original release.	Aug. 23, 2016

1 Certificate of Conformity

Product: Dual-Band AC1200 Gigabit Router

Brand: Luxul

Test Model: XWR-1200

Sample Status: ENGINEERING SAMPLE

Applicant: Luxul Wireless

Test Date: July 25 to Aug. 02, 2016

Standard: 47 CFR FCC Part 15, Subpart E (Section 15.407)
ANSI C63.10: 2013

The above equipment has been tested by **Bureau Veritas Consumer Products Services (H.K.) Ltd., Taoyuan Branch**, and found compliance with the requirement of the above standards. The test record, data evaluation & Equipment Under Test (EUT) configurations represented herein are true and accurate accounts of the measurements of the sample's EMC characteristics under the conditions specified in this report.

Prepared by : Wendy Wu , **Date:** Aug. 23, 2016
Wendy Wu / Specialist

Approved by : May Chen , **Date:** Aug. 23, 2016
May Chen / Manager

2 Summary of Test Results

47 CFR FCC Part 15, Subpart E (Section 15.407)			
FCC Clause	Test Item	Result	Remarks
15.407(b)(6)	AC Power Conducted Emissions	Pass	Meet the requirement of limit. Minimum passing margin is -3.16dB at 0.41356MHz.
15.407(b) (1/2/3/4(i/ii)/6)	Radiated Emissions & Band Edge Measurement*	Pass	Meet the requirement of limit. Minimum passing margin is -0.1dB at 5725.00MHz.
15.407(a)(1/2/3)	Max Average Transmit Power	Pass	Meet the requirement of limit.
---	Occupied Bandwidth Measurement	-	Reference only.
15.407(a)(1/2/3)	Peak Power Spectral Density	Pass	Meet the requirement of limit.
15.407(e)	6dB bandwidth	Pass	Meet the requirement of limit. (U-NII-3 Band only)
15.407(g)	Frequency Stability	Pass	Meet the requirement of limit.
15.203	Antenna Requirement	Pass	Antenna connector is R-SMA not a standard connector.

*For U-NII-3 band compliance with rule part 15.407(b)(4)(i), the OOB test plots were recorded in Annex A.

2.1 Measurement Uncertainty

Where relevant, the following measurement uncertainty levels have been estimated for tests performed on the EUT as specified in CISPR 16-4-2:

Measurement	Frequency	Expanded Uncertainty (k=2) (±)
Conducted Emissions at mains ports	150kHz ~ 30MHz	1.83 dB
Radiated Emissions up to 1 GHz	30MHz ~ 1GHz	5.19 dB
	1GHz ~ 6GHz	3.43 dB
Radiated Emissions above 1 GHz	6GHz ~ 18GHz	3.49 dB
	18GHz ~ 40GHz	4.11 dB

2.2 Modification Record

There were no modifications required for compliance.

3 General Information

3.1 General Description of EUT

Product	Dual-Band AC1200 Gigabit Router
Brand	Luxul
Test Model	XWR-1200
Status of EUT	ENGINEERING SAMPLE
Power Supply Rating	DC12V from power adapter
Modulation Type	CCK, DQPSK, DBPSK for DSSS 64QAM, 16QAM, QPSK, BPSK for OFDM 256QAM for OFDM in 11ac mode only
Modulation Technology	DSSS, OFDM
Transfer Rate	802.11b: up to 11Mbps 802.11a/g: up to 54Mbps 802.11n: up to 300Mbps 802.11ac: up to 866.7Mbps
Operating Frequency	2.4GHz: 2.412GHz ~ 2.462GHz 5GHz: 5.18GHz ~ 5.24GHz, 5.745GHz ~ 5.825GHz
Number of Channel	2.4GHz: 802.11b, 802.11g, 802.11n (HT20): 11 802.11n (HT40): 7 5GHz: 802.11a, 802.11n (HT20), 802.11ac (VHT20): 9 802.11n (HT40), 802.11ac (VHT40): 4 802.11ac (VHT80): 2
Output Power	2.4GHz: 955.657mW 5.18GHz ~ 5.24GHz: CDD Mode: 481.427mW Beamforming Mode: 481.427mW 5.745GHz ~ 5.825GHz: CDD Mode: 370.019mW Beamforming Mode: 370.019mW
Antenna Type	Refer to Note
Antenna Connector	Refer to Note
Accessory Device	Adapter x 1
Data Cable Supplied	RJ45 cable x 1 (Unshielded, 31cm)

Note:

- The EUT must be supplied from a power adapter and following different models could be chosen as following table:

No.	Brand	Model No.	Spec.
1	LEI	MU24-Y120200-A1	Input: 100-240Vac, 0.7A, 50/60Hz Output: 12V, 2.0A DC output cable: Unshielded 1.2m
2	CWT	2ABL024F US	Input: 100/240Vac, 0.8A, 50/60Hz Output: 12V, 2.0A DC output cable: Unshielded 1.2m

2. Simultaneously transmission condition.

Condition	Technology	
1	WLAN (2.4GHz)	WLAN (5GHz)

Note: The emission of the simultaneous operation has been evaluated and no non-compliance was found.

3. The antennas provided to the EUT, please refer to the following table:

Antenna No.	Brand	Model	Antenna Net Gain(dBi)	Frequency range (GHz ~ GHz)	Antenna Type	Connector Type	Cable Length(mm)	Cable Loss(dB)
1	NA	290-20268	4	2.4~2.4835	Dipole	R-SMA	290	-0.41
			3.44	5.15~5.25				-1.01
			2.72	5.25~5.35				-1.01
			2.16	5.47~5.725				-1.01
			2.16	5.725~5.85				-1.01
2	NA	290-20268	4	2.4~2.4835	Dipole	R-SMA	290	-0.41
			3.44	5.15~5.25				-1.01
			2.72	5.25~5.35				-1.01
			2.16	5.47~5.725				-1.01
			2.16	5.725~5.85				-1.01

4. The EUT incorporates a MIMO function.

2.4GHz Band			
MODULATION MODE	DATA RATE (MCS)	TX & RX CONFIGURATION	
802.11b	1 ~ 11Mbps	1TX Fixed Chain 0	2RX
802.11g	6 ~ 54Mbps	2TX	2RX
802.11n (HT20)	MCS 0~7	2TX	2RX
	MCS 8~15	2TX	2RX
802.11n (HT40)	MCS 0~7	2TX	2RX
	MCS 8~15	2TX	2RX
5GHz Band			
MODULATION MODE	DATA RATE (MCS)	TX & RX CONFIGURATION	
802.11a	6 ~ 54Mbps	2TX	2RX
802.11n (HT20)	MCS 0~7	2TX	2RX
	MCS 8~15	2TX	2RX
802.11n (HT40)	MCS 0~7	2TX	2RX
	MCS 8~15	2TX	2RX
802.11ac (VHT20)	MCS 0~8, NSS=1	2TX	2RX
	MCS 0~8, NSS=2	2TX	2RX
802.11ac (VHT40)	MCS 0~9, NSS=1	2TX	2RX
	MCS 0~9, NSS=2	2TX	2RX
802.11ac (VHT80)	MCS 0~9, NSS=1	2TX	2RX
	MCS 0~9, NSS=2	2TX	2RX

Note:

- All of modulation mode support beamforming function except 802.11a modulation mode and 2.4GHz band.
- The modulation and bandwidth are similar for 802.11n mode for 20MHz (40MHz) and 802.11ac mode for 20MHz (40MHz), therefore investigated worst case to representative mode in test report. (Final test mode refer section 3.2.1)

5. The above EUT information is declared by manufacturer and for more detailed features description, please refer to the manufacturer's specifications or user's manual.

3.2 Description of Test Modes

FOR 5180 ~ 5240MHz

4 channels are provided for 802.11a, 802.11n (HT20), 802.11ac (VHT20):

Channel	Frequency	Channel	Frequency
36	5180 MHz	44	5220 MHz
40	5200 MHz	48	5240 MHz

2 channels are provided for 802.11n (HT40), 802.11ac (VHT40):

Channel	Frequency	Channel	Frequency
38	5190 MHz	46	5230 MHz

1 channel is provided for 802.11ac (VHT80):

Channel	Frequency
42	5210MHz

FOR 5745 ~ 5825MHz:

5 channels are provided for 802.11a, 802.11n (HT20), 802.11ac (VHT20):

Channel	Frequency	Channel	Frequency
149	5745MHz	161	5805MHz
153	5765MHz	165	5825MHz
157	5785MHz		

2 channels are provided for 802.11n (HT40), 802.11ac (VHT40):

Channel	Frequency	Channel	Frequency
151	5755MHz	159	5795MHz

1 channel is provided for 802.11ac (VHT80):

Channel	Frequency
155	5775MHz

3.2.1 Test Mode Applicability and Tested Channel Detail

EUT Configure Mode	Applicable To				Description
	RE \geq 1G	RE<1G	PLC	APCM	
1	√	√	√	-	Power from adapter 1
2	√	√	√	√	Power from adapter 2

Where **RE \geq 1G**: Radiated Emission above 1GHz **RE<1G**: Radiated Emission below 1GHz
PLC: Power Line Conducted Emission **APCM**: Antenna Port Conducted Measurement

NOTE:

1. The EUT had been pre-tested on the positioned of each 2 axis. The worst case was found when positioned on **X-plane**.
2. "-" means no effect.

Radiated Emission Test (Above 1GHz):

- Pre-Scan has been conducted to determine the worst-case mode from all possible combinations between available modulations, data rates and antenna ports (if EUT with antenna diversity architecture).
- Following channel(s) was (were) selected for the final test as listed below.

CDD Mode						
Mode	FREQ. Band (MHz)	Available Channel	Tested Channel	Modulation Technology	Modulation Type	Data Rate (Mbps)
802.11a	5180-5240	36 to 48	36, 40, 48	OFDM	BPSK	6
802.11ac (VHT20)		36 to 48	36, 40, 48	OFDM	BPSK	6.5
802.11ac (VHT40)		38 to 46	38, 46	OFDM	BPSK	13.5
802.11ac (VHT80)		42	42	OFDM	BPSK	29.3
802.11a	5745-5825	149 to 165	149, 157, 165	OFDM	BPSK	6
802.11ac (VHT20)		149 to 165	149, 157, 165	OFDM	BPSK	6.5
802.11ac (VHT40)		151 to 159	151, 159	OFDM	BPSK	13.5
802.11ac (VHT80)		155	155	OFDM	BPSK	29.3

Radiated Emission Test (Below 1GHz):

- Pre-Scan has been conducted to determine the worst-case mode from all possible combinations between available modulations, data rates and antenna ports (if EUT with antenna diversity architecture).
- Following channel(s) was (were) selected for the final test as listed below.

CDD Mode						
Mode	FREQ. Band (MHz)	Available Channel	Tested Channel	Modulation Technology	Modulation Type	Data Rate (Mbps)
802.11ac (VHT20)	5180-5240	36 to 48	40	OFDM	BPSK	6.5

Power Line Conducted Emission Test:

- Pre-Scan has been conducted to determine the worst-case mode from all possible combinations between available modulations, data rates and antenna ports (if EUT with antenna diversity architecture).
- Following channel(s) was (were) selected for the final test as listed below.

CDD Mode						
Mode	FREQ. Band (MHz)	Available Channel	Tested Channel	Modulation Technology	Modulation Type	Data Rate (Mbps)
802.11ac (VHT20)	5180-5240	36 to 48	40	OFDM	BPSK	6.5

Antenna Port Conducted Measurement:

- This item includes all test value of each mode, but only includes spectrum plot of worst value of each mode.
- Pre-Scan has been conducted to determine the worst-case mode from all possible combinations between available modulations, data rates and antenna ports (if EUT with antenna diversity architecture).
- Following channel(s) was (were) selected for the final test as listed below.

CDD Mode						
Mode	FREQ. Band (MHz)	Available Channel	Tested Channel	Modulation Technology	Modulation Type	Data Rate (Mbps)
802.11a	5180-5240	36 to 48	36, 40, 48	OFDM	BPSK	6
802.11ac (VHT20)		36 to 48	36, 40, 48	OFDM	BPSK	6.5
802.11ac (VHT40)		38 to 46	38, 46	OFDM	BPSK	13.5
802.11ac (VHT80)		42	42	OFDM	BPSK	29.3
802.11a	5745-5825	149 to 165	149, 157, 165	OFDM	BPSK	6
802.11ac (VHT20)		149 to 165	149, 157, 165	OFDM	BPSK	6.5
802.11ac (VHT40)		151 to 159	151, 159	OFDM	BPSK	13.5
802.11ac (VHT80)		155	155	OFDM	BPSK	29.3
Beamforming Mode (Output power only)						
Mode	FREQ. Band (MHz)	Available Channel	Tested Channel	Modulation Technology	Modulation Type	Data Rate (Mbps)
802.11ac (VHT20)	5180-5240	36 to 48	36, 40, 48	OFDM	BPSK	6.5
802.11ac (VHT40)		38 to 46	38, 46	OFDM	BPSK	13.5
802.11ac (VHT80)		42	42	OFDM	BPSK	29.3
802.11ac (VHT20)	5745-5825	149 to 165	149, 157, 165	OFDM	BPSK	6.5
802.11ac (VHT40)		151 to 159	151, 159	OFDM	BPSK	13.5
802.11ac (VHT80)		155	155	OFDM	BPSK	29.3

Test Condition:

APPLICABLE TO	ENVIRONMENTAL CONDITIONS	INPUT POWER	TESTED BY
RE \geq 1G	23deg. C, 66%RH	120Vac, 60Hz	Gary Cheng
	25deg. C, 65%RH		Russell Yeh
RE $<$ 1G	22deg. C, 64%RH	120Vac, 60Hz	Russell Yeh
PLC	25deg. C, 62%RH	120Vac, 60Hz	Jyunchun Lin
APCM	25deg. C, 60%RH	120Vac, 60Hz	Anderson Chen

3.3 Duty Cycle of Test Signal

If duty cycle of test signal is $\geq 98\%$, duty factor is not required.

If duty cycle of test signal is $< 98\%$, duty factor shall be considered.

802.11a: Duty cycle = $2.727 \text{ ms} / 2.748 \text{ ms} = 0.992$

802.11ac (VHT20): Duty cycle = $2.543 \text{ ms} / 2.555 \text{ ms} = 0.992$

802.11ac (VHT40): Duty cycle = $1.24 \text{ ms} / 1.259 \text{ ms} = 0.985$

802.11ac (VHT80): Duty cycle = $0.599 \text{ ms} / 0.618 \text{ ms} = 0.969$, Duty factor = $10 * \log(1/0.969) = 0.14$

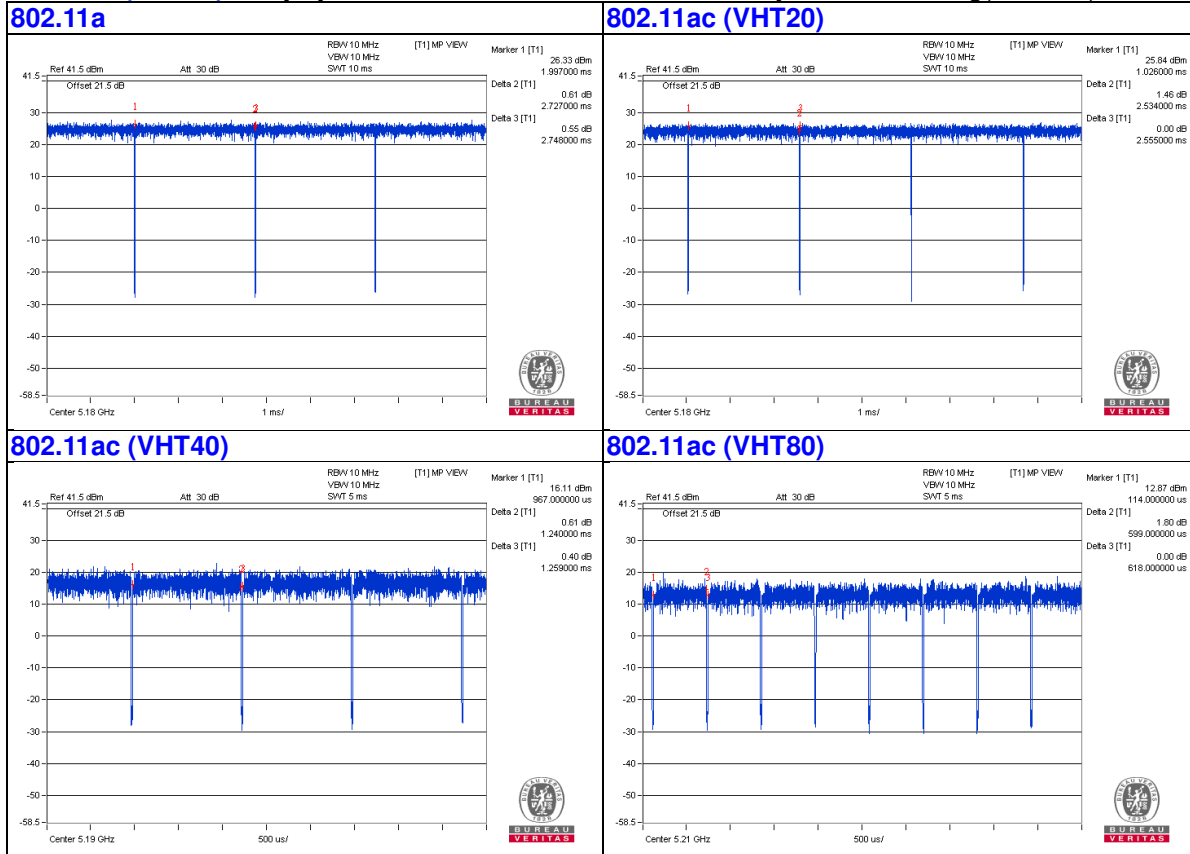

3.4 Description of Support Units

The EUT has been tested as an independent unit together with other necessary accessories or support units. The following support units or accessories were used to form a representative test configuration during the tests.

ID	Product	Brand	Model No.	Serial No.	FCC ID	Remarks
A.	Notebook Computer	DELL	E5430	4YV4VY1	FCC DoC	Provided by Lab
B.	Notebook Computer	DELL	E5430	HYV4VY1	FCC DoC	Provided by Lab
C.	HUB	ZyXEL	ES-116P	S060H02000215	FCC DoC	Provided by Lab
D.	iPod	Apple	MC749TA/A	CC4DMFJUDFDM	NA	Provided by Lab

Note:

1. All power cords of the above support units are non-shielded (1.8m).

ID	Descriptions	Qty.	Length (m)	Shielding (Yes/No)	Cores (Qty.)	Remarks
1.	USB Cable	1	0.1	Yes	0	Provided by Lab
2.	RJ-45 Cable	1	10	No	0	Provided by Lab
3.	RJ-45 Cable	1	10	No	0	Provided by Lab
4.	RJ-45 Cable	3	10	No	0	Provided by Lab
5.	DC Cable	1	1.8	No	0	Supplied by client

3.4.1 Configuration of System under Test

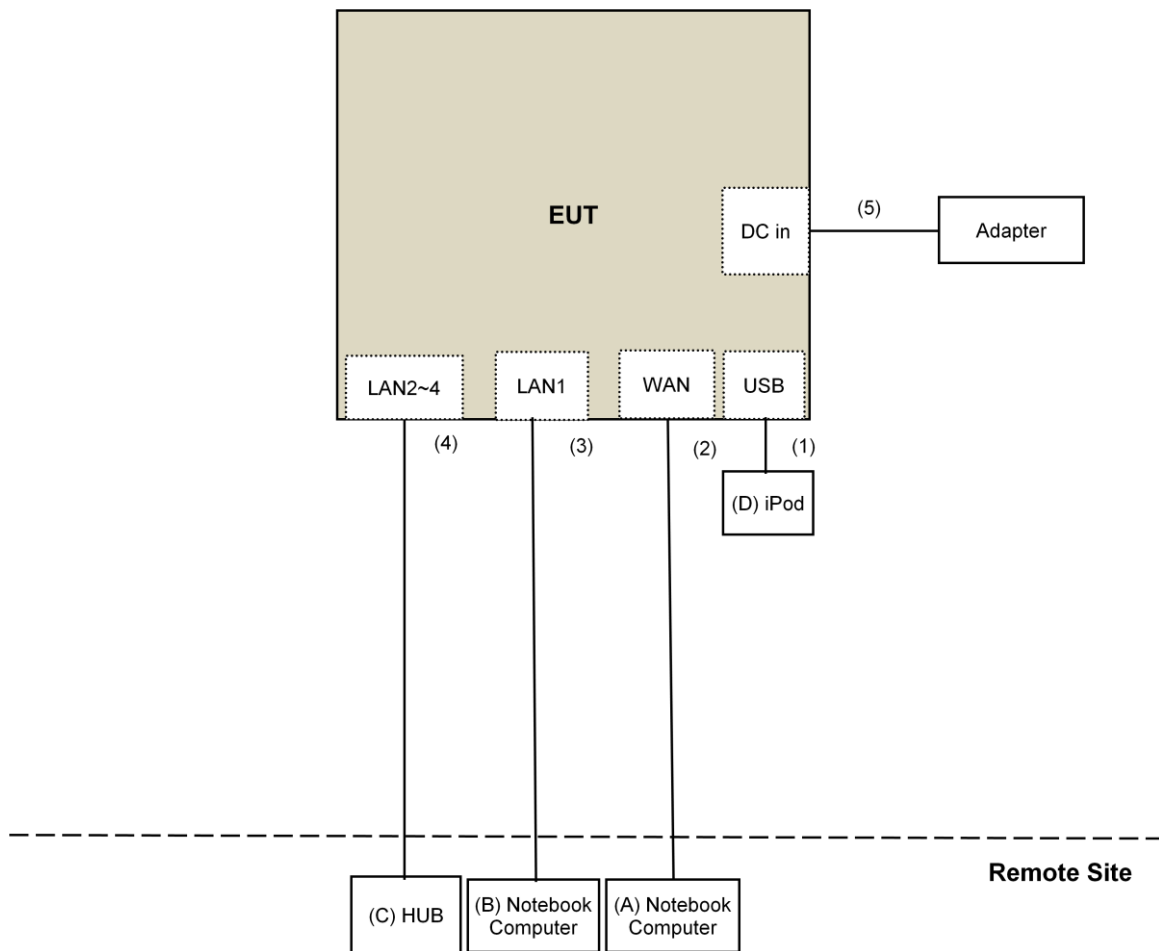

3.5 General Description of Applied Standard

The EUT is a RF Product. According to the specifications of the manufacturer, it must comply with the requirements of the following standards:

FCC Part 15, Subpart E (15.407)
KDB 789033 D02 General UNII Test Procedure New Rules v01r03
KDB 662911 D01 Multiple Transmitter Output v02r01
ANSI C63.10-2013

All test items have been performed and recorded as per the above standards.

NOTE: The EUT has been verified to comply with the requirements of FCC Part 15, Subpart B, Class B (DoC). The test report has been issued separately.

4 Test Types and Results

4.1 Radiated Emission and Bandedge Measurement

4.1.1 Limits of Radiated Emission and Bandedge Measurement

Radiated emissions which fall in the restricted bands must comply with the radiated emission limits specified as below table.

Frequencies (MHz)	Field Strength (microvolts/meter)	Measurement Distance (meters)
0.009 ~ 0.490	2400/F(kHz)	300
0.490 ~ 1.705	24000/F(kHz)	30
1.705 ~ 30.0	30	30
30 ~ 88	100	3
88 ~ 216	150	3
216 ~ 960	200	3
Above 960	500	3

NOTE:

1. The lower limit shall apply at the transition frequencies.
2. Emission level (dBuV/m) = 20 log Emission level (uV/m).
3. For frequencies above 1000MHz, the field strength limits are based on average detector, however, the peak field strength of any emission shall not exceed the maximum permitted average limits, specified above by more than 20dB under any condition of modulation.

Limits of unwanted emission out of the restricted bands

Applicable To		Limit	
789033 D02 General UNII Test Procedure New Rules v01r03		Field Strength at 3m	
		PK:74 (dBμV/m)	AV:54 (dBμV/m)
Frequency Band	Applicable To	EIRP Limit	Equivalent Field Strength at 3m
5150~5250 MHz	15.407(b)(1)	PK:-27 (dBm/MHz)	PK:68.2(dBμV/m)
5250~5350 MHz	15.407(b)(2)		
5470~5725 MHz	15.407(b)(3)		
5725~5850 MHz	<input checked="" type="checkbox"/> 15.407(b)(4)(i)	PK:-27 (dBm/MHz) ^{*1} PK:10 (dBm/MHz) ^{*2} PK:15.6 (dBm/MHz) ^{*3} PK:27 (dBm/MHz) ^{*4}	PK: 68.2(dBμV/m) ^{*1} PK:105.2 (dBμV/m) ^{*2} PK: 110.8(dBμV/m) ^{*3} PK:122.2 (dBμV/m) ^{*4}
	<input type="checkbox"/> 15.407(b)(4)(ii)	Emission limits in section 15.247(d)	
^{*1} beyond 75 MHz or more above of the band edge.		^{*2} below the band edge increasing linearly to 10 dBm/MHz at 25 MHz above.	
^{*3} below the band edge increasing linearly to a level of 15.6 dBm/MHz at 5 MHz above.		^{*4} from 5 MHz above or below the band edge increasing linearly to a level of 27 dBm/MHz at the band edge.	

Note:

The following formula is used to convert the equipment isotropic radiated power (eirp) to field strength:

$$E = \frac{1000000\sqrt{30P}}{3} \mu\text{V/m, where } P \text{ is the eirp (Watts).}$$

4.1.2 Test Instruments

DESCRIPTION & MANUFACTURER	MODEL NO.	SERIAL NO.	CALIBRATED DATE	CALIBRATED UNTIL
Test Receiver Keysight	N9038A	MY54450088	July 20, 2016	July 19, 2017
Pre-Amplifier ^(*) EMCI	EMC001340	980142	Jan. 20, 2016	Jan. 19, 2018
Loop Antenna ^(*) Electro-Metrics	EM-6879	264	Dec. 16, 2014	Dec. 15, 2016
RF Cable	NA	LOOPCAB-001 LOOPCAB-002	Jan. 18, 2016	Jan. 17, 2017
Pre-Amplifier Mini-Circuits	ZFL-1000VH2B	AMP-ZFL-01	Nov. 11, 2015	Nov. 10, 2016
Trilog Broadband Antenna SCHWARZBECK	VULB 9168	9168-406	Jan. 04, 2016	Jan. 03, 2017
RF Cable	8D	966-4-1 966-4-2 966-4-3	Apr. 02, 2016	Apr. 01, 2017
Horn Antenna SCHWARZBECK	BBHA 9120D	9120D-783	Jan. 19, 2016	Jan. 18, 2017
Pre-Amplifier Agilent	8449B	3008A01922	Sep. 19, 2015	Sep. 18, 2016
RF Cable	EMC104-SM-SM-2000 EMC104-SM-SM-5000 EMC104-SM-SM-5000	150318 150323 150324	Mar. 30, 2016	Mar. 29, 2017
Pre-Amplifier EMCI	EMC184045	980143	Jan. 15, 2016	Jan. 14, 2017
Horn Antenna SCHWARZBECK	BBHA 9170	BBHA9170608	Jan. 08, 2016	Jan. 07, 2017
RF Cable	SUCOFLEX 102	36432/2 36441/2	Jan. 16, 2016	Jan. 15, 2017
Software	ADT_Radiated_V8.7.07	NA	NA	NA
Antenna Tower & Turn Table Max-Full	MF-7802	MF780208410	NA	NA
Boresight Antenna Fixture	FBA-01	FBA-SIP02	NA	NA
Spectrum Analyzer R&S	FSP40	100060	May 11, 2016	May 10, 2017
Power meter Anritsu	ML2495A	1014008	May 05, 2016	May 04, 2017
Power sensor Anritsu	MA2411B	0917122	May 05, 2016	May 04, 2017
AC Power Source Extech Electronics	6205	1440452	NA	NA
Temperature & Humidity Chamber Giant Force	GTH-150-40-SP-AR	MAA0812-008	Jan. 15, 2016	Jan. 14, 2017
Digital Multimeter FLUKE	87III	73680266	Nov. 10, 2015	Nov. 09, 2016

Note:

1. The calibration interval of the above test instruments is 12 months and the calibrations are traceable to NML/ROC and NIST/USA.
2. *The calibration interval of the above test instruments is 24 months and the calibrations are traceable to NML/ROC and NIST/USA.
3. Loop antenna was used for all emissions below 30 MHz.
4. The test was performed in 966 Chamber No. 4.
5. The FCC Site Registration No. is 292998
6. The CANADA Site Registration No. is 20331-2
- 7 Tested Date: July 25 to Aug. 02, 2016

4.1.3 Test Procedure

- a. The EUT was placed on the top of a rotating table 0.8 meters (for below 1GHz) / 1.5 meters (for above 1GHz) above the ground at 3 meter chamber room for test. The table was rotated 360 degrees to determine the position of the highest radiation.
- b. The EUT was set 3 meters away from the interference-receiving antenna, which was mounted on the top of a variable-height antenna tower.
- c. The height of antenna is varied from one meter to four meters above the ground to determine the maximum value of the field strength. Both horizontal and vertical polarizations of the antenna are set to make the measurement.
- d. For each suspected emission, the EUT was arranged to its worst case and then the antenna was tuned to heights from 1 meter to 4 meters and the rotatable table was turned from 0 degrees to 360 degrees to find the maximum reading.
- e. The test-receiver system was set to quasi-peak detect function and specified bandwidth with maximum hold mode when the test frequency is below 1 GHz.
- f. The test-receiver system was set to peak and average detect function and specified bandwidth with maximum hold mode when the test frequency is above 1 GHz. If the peak reading value also meets average limit, measurement with the average detector is unnecessary.

Note:

1. The resolution bandwidth and video bandwidth of test receiver/spectrum analyzer is 120kHz for Quasi-peak detection (QP) at frequency below 1GHz.
2. The resolution bandwidth of test receiver/spectrum analyzer is 1 MHz and the video bandwidth is 3 MHz for Peak detection (PK) at frequency above 1GHz.
3. The resolution bandwidth of test receiver/spectrum analyzer is 1MHz and the video bandwidth is $\geq 1/T$ (Duty cycle < 98%) or 10Hz (Duty cycle $\geq 98\%$) for Average detection (AV) at frequency above 1GHz.
4. All modes of operation were investigated and the worst-case emissions are reported.

4.1.4 Deviation from Test Standard

No deviation.

4.1.5 Test Setup

<Frequency Range below 1GHz>

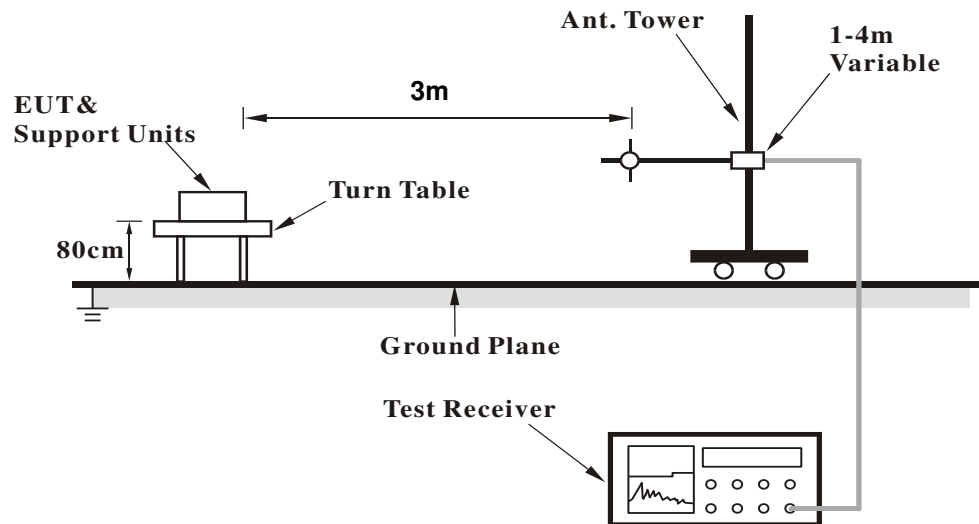

<Frequency Range above 1GHz>

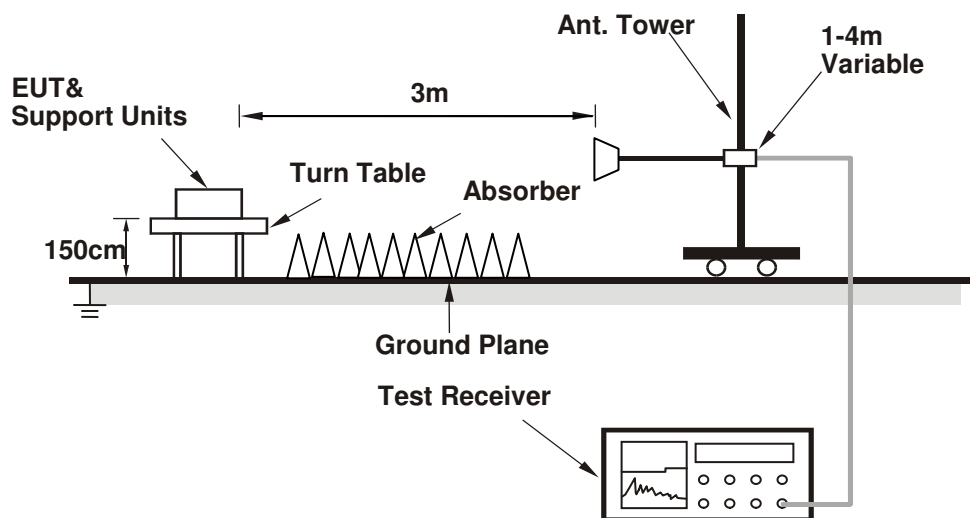

For the actual test configuration, please refer to the attached file (Test Setup Photo).

4.1.6 EUT Operating Condition

- a. Connected the EUT with the Notebook Computer which is placed on remote site.
- b. Controlling software (Mtool 2.0.2.7.exe) has been activated to set the EUT on specific status.

4.1.7 Test Results (Mode 1)

Above 1GHz Data:

802.11a

CHANNEL	TX Channel 36	DETECTOR FUNCTION	Peak (PK)
FREQUENCY RANGE	1GHz ~ 40GHz		Average (AV)

ANTENNA POLARITY & TEST DISTANCE: HORIZONTAL AT 3 M

NO.	FREQ. (MHz)	EMISSION LEVEL (dBuV/m)	LIMIT (dBuV/m)	MARGIN (dB)	ANTENNA HEIGHT (m)	TABLE ANGLE (Degree)	RAW VALUE (dBuV)	CORRECTION FACTOR (dB/m)
1	5098.40	55.3 PK	74.0	-18.7	1.02 H	47	53.8	1.5
2	5098.40	43.5 AV	54.0	-10.5	1.02 H	47	42.0	1.5
3	5150.00	68.1 PK	74.0	-5.9	1.02 H	47	66.5	1.6
4	5150.00	50.2 AV	54.0	-3.8	1.02 H	47	48.6	1.6
5	*5180.00	106.2 PK			1.02 H	47	104.5	1.7
6	*5180.00	96.2 AV			1.02 H	47	94.5	1.7
7	#10360.00	51.5 PK	74.0	-22.5	1.82 H	193	39.8	11.7
8	#10360.00	38.2 AV	54.0	-15.8	1.82 H	193	26.5	11.7
9	15540.00	51.6 PK	74.0	-22.4	1.46 H	187	38.3	13.3
10	15540.00	41.4 AV	54.0	-12.6	1.46 H	187	28.1	13.3

ANTENNA POLARITY & TEST DISTANCE: VERTICAL AT 3 M

NO.	FREQ. (MHz)	EMISSION LEVEL (dBuV/m)	LIMIT (dBuV/m)	MARGIN (dB)	ANTENNA HEIGHT (m)	TABLE ANGLE (Degree)	RAW VALUE (dBuV)	CORRECTION FACTOR (dB/m)
1	5098.40	60.7 PK	74.0	-13.3	1.02 V	291	59.2	1.5
2	5098.40	48.7 AV	54.0	-5.3	1.02 V	291	47.2	1.5
3	5150.00	70.1 PK	74.0	-3.9	1.02 V	291	68.5	1.6
4	5150.00	52.8 AV	54.0	-1.2	1.02 V	291	51.2	1.6
5	*5180.00	114.6 PK			1.02 V	291	112.9	1.7
6	*5180.00	103.4 AV			1.02 V	291	101.7	1.7
7	#10360.00	51.2 PK	74.0	-22.8	2.29 V	311	39.5	11.7
8	#10360.00	38.5 AV	54.0	-15.5	2.29 V	311	26.8	11.7
9	15540.00	57.0 PK	74.0	-17.0	2.80 V	163	43.7	13.3
10	15540.00	43.2 AV	54.0	-10.8	2.80 V	163	29.9	13.3

REMARKS:

- Emission Level(dBuV/m) = Raw Value(dBuV) + Correction Factor(dB/m)
- Correction Factor(dB/m) = Antenna Factor(dB/m) + Cable Factor(dB) – Pre-Amplifier Factor(dB)
- The other emission levels were very low against the limit.
- Margin value = Emission Level – Limit value
- " * ": Fundamental frequency.
- " # ": The radiated frequency is out of the restricted band.

CHANNEL	TX Channel 40	DETECTOR FUNCTION	Peak (PK)
FREQUENCY RANGE	1GHz ~ 40GHz		Average (AV)

ANTENNA POLARITY & TEST DISTANCE: HORIZONTAL AT 3 M

NO.	FREQ. (MHz)	EMISSION LEVEL (dBuV/m)	LIMIT (dBuV/m)	MARGIN (dB)	ANTENNA HEIGHT (m)	TABLE ANGLE (Degree)	RAW VALUE (dBuV)	CORRECTION FACTOR (dB/m)
1	5119.00	58.3 PK	74.0	-15.7	1.30 H	61	56.8	1.5
2	5119.00	45.9 AV	54.0	-8.1	1.30 H	61	44.4	1.5
3	5150.00	55.7 PK	74.0	-18.3	1.30 H	61	54.1	1.6
4	5150.00	40.9 AV	54.0	-13.1	1.30 H	61	39.3	1.6
5	*5200.00	105.2 PK			1.30 H	61	103.4	1.8
6	*5200.00	95.7 AV			1.30 H	61	93.9	1.8
7	#10400.00	51.0 PK	74.0	-23.0	1.74 H	209	39.1	11.9
8	#10400.00	37.8 AV	54.0	-16.2	1.74 H	209	25.9	11.9
9	15600.00	51.3 PK	74.0	-22.7	1.49 H	167	38.0	13.3
10	15600.00	40.9 AV	54.0	-13.1	1.49 H	167	27.6	13.3

ANTENNA POLARITY & TEST DISTANCE: VERTICAL AT 3 M

NO.	FREQ. (MHz)	EMISSION LEVEL (dBuV/m)	LIMIT (dBuV/m)	MARGIN (dB)	ANTENNA HEIGHT (m)	TABLE ANGLE (Degree)	RAW VALUE (dBuV)	CORRECTION FACTOR (dB/m)
1	5119.00	61.2 PK	74.0	-12.8	1.05 V	251	59.7	1.5
2	5119.00	48.1 AV	54.0	-5.9	1.05 V	251	46.6	1.5
3	5150.00	63.3 PK	74.0	-10.7	1.05 V	251	61.7	1.6
4	5150.00	48.6 AV	54.0	-5.4	1.05 V	251	47.0	1.6
5	*5200.00	114.9 PK			1.05 V	251	113.1	1.8
6	*5200.00	104.0 AV			1.05 V	251	102.2	1.8
7	#10400.00	51.4 PK	74.0	-22.6	2.34 V	324	39.5	11.9
8	#10400.00	38.5 AV	54.0	-15.5	2.34 V	324	26.6	11.9
9	15600.00	57.2 PK	74.0	-16.8	2.81 V	165	43.9	13.3
10	15600.00	43.1 AV	54.0	-10.9	2.81 V	165	29.8	13.3

REMARKS:

1. Emission Level(dBuV/m) = Raw Value(dBuV) + Correction Factor(dB/m)
2. Correction Factor(dB/m) = Antenna Factor(dB/m) + Cable Factor(dB) – Pre-Amplifier Factor(dB)
3. The other emission levels were very low against the limit.
4. Margin value = Emission Level – Limit value
5. " * ": Fundamental frequency.
6. " # ": The radiated frequency is out of the restricted band.

CHANNEL	TX Channel 48	DETECTOR FUNCTION	Peak (PK)
FREQUENCY RANGE	1GHz ~ 40GHz		Average (AV)

ANTENNA POLARITY & TEST DISTANCE: HORIZONTAL AT 3 M

NO.	FREQ. (MHz)	EMISSION LEVEL (dBuV/m)	LIMIT (dBuV/m)	MARGIN (dB)	ANTENNA HEIGHT (m)	TABLE ANGLE (Degree)	RAW VALUE (dBuV)	CORRECTION FACTOR (dB/m)
1	*5240.00	104.2 PK			1.27 H	90	102.4	1.8
2	*5240.00	94.6 AV			1.27 H	90	92.8	1.8
3	5350.00	50.5 PK	74.0	-23.5	1.27 H	90	48.4	2.1
4	5350.00	40.3 AV	54.0	-13.7	1.27 H	90	38.2	2.1
5	5398.00	56.4 PK	74.0	-17.6	1.27 H	90	54.2	2.2
6	5398.00	45.2 AV	54.0	-8.8	1.27 H	90	43.0	2.2
7	#10480.00	51.1 PK	74.0	-22.9	1.67 H	223	38.9	12.2
8	#10480.00	37.5 AV	54.0	-16.5	1.67 H	223	25.3	12.2
9	15720.00	51.6 PK	74.0	-22.4	1.49 H	194	38.4	13.2
10	15720.00	41.4 AV	54.0	-12.6	1.49 H	194	28.2	13.2

ANTENNA POLARITY & TEST DISTANCE: VERTICAL AT 3 M

NO.	FREQ. (MHz)	EMISSION LEVEL (dBuV/m)	LIMIT (dBuV/m)	MARGIN (dB)	ANTENNA HEIGHT (m)	TABLE ANGLE (Degree)	RAW VALUE (dBuV)	CORRECTION FACTOR (dB/m)
1	*5240.00	115.6 PK			1.11 V	272	113.8	1.8
2	*5240.00	104.1 AV			1.11 V	272	102.3	1.8
3	5350.00	57.0 PK	74.0	-17.0	1.11 V	272	54.9	2.1
4	5350.00	42.4 AV	54.0	-11.6	1.11 V	272	40.3	2.1
5	5398.00	63.0 PK	74.0	-11.0	1.11 V	272	60.8	2.2
6	5398.00	51.3 AV	54.0	-2.7	1.11 V	272	49.1	2.2
7	#10480.00	52.0 PK	74.0	-22.0	2.35 V	311	39.8	12.2
8	#10480.00	39.4 AV	54.0	-14.6	2.35 V	311	27.2	12.2
9	15720.00	57.4 PK	74.0	-16.6	2.83 V	172	44.2	13.2
10	15720.00	43.7 AV	54.0	-10.3	2.83 V	172	30.5	13.2

REMARKS:

1. Emission Level(dBuV/m) = Raw Value(dBuV) + Correction Factor(dB/m)
2. Correction Factor(dB/m) = Antenna Factor(dB/m) + Cable Factor(dB) – Pre-Amplifier Factor(dB)
3. The other emission levels were very low against the limit.
4. Margin value = Emission Level – Limit value
5. " * ": Fundamental frequency.
6. " # ": The radiated frequency is out of the restricted band.

CHANNEL	TX Channel 149	DETECTOR FUNCTION	Peak (PK)
FREQUENCY RANGE	1GHz ~ 40GHz		Average (AV)

ANTENNA POLARITY & TEST DISTANCE: HORIZONTAL AT 3 M

NO.	FREQ. (MHz)	EMISSION LEVEL (dBuV/m)	LIMIT (dBuV/m)	MARGIN (dB)	ANTENNA HEIGHT (m)	TABLE ANGLE (Degree)	RAW VALUE (dBuV)	CORRECTION FACTOR (dB/m)
1	#5587.62	57.8 PK	68.2	-10.4	1.14 H	193	55.3	2.5
2	*5745.00	106.6 PK			1.14 H	193	103.8	2.8
3	*5745.00	96.7 AV			1.14 H	193	93.9	2.8
4	#5976.10	58.2 PK	68.2	-10.0	1.14 H	193	55.0	3.2
5	11490.00	52.1 PK	74.0	-21.9	1.81 H	208	38.6	13.5
6	11490.00	39.5 AV	54.0	-14.5	1.81 H	208	26.0	13.5
7	#17235.00	57.5 PK	74.0	-16.5	1.48 H	162	39.1	18.4
8	#17235.00	44.4 AV	54.0	-9.6	1.48 H	162	26.0	18.4

ANTENNA POLARITY & TEST DISTANCE: VERTICAL AT 3 M

NO.	FREQ. (MHz)	EMISSION LEVEL (dBuV/m)	LIMIT (dBuV/m)	MARGIN (dB)	ANTENNA HEIGHT (m)	TABLE ANGLE (Degree)	RAW VALUE (dBuV)	CORRECTION FACTOR (dB/m)
1	#5583.25	64.7 PK	68.2	-3.5	1.05 V	303	62.2	2.5
2	*5745.00	116.9 PK			1.05 V	303	114.1	2.8
3	*5745.00	104.2 AV			1.05 V	303	101.4	2.8
4	#5911.95	64.3 PK	77.8	-13.5	1.05 V	303	23.4	40.9
5	11490.00	58.1 PK	74.0	-15.9	2.24 V	199	44.6	13.5
6	11490.00	45.4 AV	54.0	-8.6	2.24 V	199	31.9	13.5
7	#17235.00	56.5 PK	74.0	-17.5	2.78 V	182	38.1	18.4
8	#17235.00	45.6 AV	54.0	-8.4	2.78 V	182	27.2	18.4

REMARKS:

1. Emission Level(dBuV/m) = Raw Value(dBuV) + Correction Factor(dB/m)
2. Correction Factor(dB/m) = Antenna Factor(dB/m) + Cable Factor(dB) – Pre-Amplifier Factor(dB)
3. The other emission levels were very low against the limit.
4. Margin value = Emission Level – Limit value
5. " * ": Fundamental frequency.
6. " # ": The radiated frequency is out of the restricted band.

CHANNEL	TX Channel 157	DETECTOR FUNCTION	Peak (PK)
FREQUENCY RANGE	1GHz ~ 40GHz		Average (AV)

ANTENNA POLARITY & TEST DISTANCE: HORIZONTAL AT 3 M

NO.	FREQ. (MHz)	EMISSION LEVEL (dBuV/m)	LIMIT (dBuV/m)	MARGIN (dB)	ANTENNA HEIGHT (m)	TABLE ANGLE (Degree)	RAW VALUE (dBuV)	CORRECTION FACTOR (dB/m)
1	#5618.40	57.6 PK	68.2	-10.6	1.14 H	181	55.0	2.6
2	*5785.00	107.3 PK			1.14 H	181	104.4	2.9
3	*5785.00	97.4 AV			1.14 H	181	94.5	2.9
4	#5944.56	60.6 PK	68.2	-7.6	1.14 H	181	57.5	3.1
5	11570.00	52.8 PK	74.0	-21.2	1.74 H	206	39.6	13.2
6	11570.00	39.8 AV	54.0	-14.2	1.74 H	206	26.6	13.2
7	#17355.00	57.2 PK	74.0	-16.8	1.48 H	182	38.1	19.1
8	#17355.00	44.2 AV	54.0	-9.8	1.48 H	182	25.1	19.1

ANTENNA POLARITY & TEST DISTANCE: VERTICAL AT 3 M

NO.	FREQ. (MHz)	EMISSION LEVEL (dBuV/m)	LIMIT (dBuV/m)	MARGIN (dB)	ANTENNA HEIGHT (m)	TABLE ANGLE (Degree)	RAW VALUE (dBuV)	CORRECTION FACTOR (dB/m)
1	#5623.62	65.4 PK	68.2	-2.8	1.02 V	294	62.8	2.6
2	*5785.00	116.1 PK			1.02 V	294	113.2	2.9
3	*5785.00	105.4 AV			1.02 V	294	102.5	2.9
4	#5948.05	65.8 PK	68.2	-2.4	1.02 V	294	62.6	3.2
5	11570.00	58.4 PK	74.0	-15.6	2.20 V	189	45.2	13.2
6	11570.00	45.8 AV	54.0	-8.2	2.20 V	189	32.6	13.2
7	#17355.00	56.6 PK	74.0	-17.4	2.80 V	167	37.5	19.1
8	#17355.00	45.5 AV	54.0	-8.5	2.80 V	167	26.4	19.1

REMARKS:

1. Emission Level(dBuV/m) = Raw Value(dBuV) + Correction Factor(dB/m)
2. Correction Factor(dB/m) = Antenna Factor(dB/m) + Cable Factor(dB) – Pre-Amplifier Factor(dB)
3. The other emission levels were very low against the limit.
4. Margin value = Emission Level – Limit value
5. " * ": Fundamental frequency.
6. " # ": The radiated frequency is out of the restricted band.

CHANNEL	TX Channel 165	DETECTOR FUNCTION	Peak (PK)
FREQUENCY RANGE	1GHz ~ 40GHz		Average (AV)

ANTENNA POLARITY & TEST DISTANCE: HORIZONTAL AT 3 M

NO.	FREQ. (MHz)	EMISSION LEVEL (dBuV/m)	LIMIT (dBuV/m)	MARGIN (dB)	ANTENNA HEIGHT (m)	TABLE ANGLE (Degree)	RAW VALUE (dBuV)	CORRECTION FACTOR (dB/m)
1	#5616.90	56.7 PK	68.2	-11.5	1.12 H	196	54.1	2.6
2	*5825.00	106.4 PK			1.12 H	196	103.5	2.9
3	*5825.00	96.5 AV			1.12 H	196	93.6	2.9
4	#5984.12	59.4 PK	68.2	-8.8	1.12 H	196	56.1	3.3
5	11650.00	52.1 PK	74.0	-21.9	1.81 H	202	38.9	13.2
6	11650.00	39.6 AV	54.0	-14.4	1.81 H	202	26.4	13.2
7	#17475.00	57.6 PK	74.0	-16.4	1.46 H	167	38.2	19.4
8	#17475.00	44.3 AV	54.0	-9.7	1.46 H	167	24.9	19.4

ANTENNA POLARITY & TEST DISTANCE: VERTICAL AT 3 M

NO.	FREQ. (MHz)	EMISSION LEVEL (dBuV/m)	LIMIT (dBuV/m)	MARGIN (dB)	ANTENNA HEIGHT (m)	TABLE ANGLE (Degree)	RAW VALUE (dBuV)	CORRECTION FACTOR (dB/m)
1	#5659.32	52.4 PK	75.1	-22.7	1.00 V	297	49.8	2.6
2	*5825.00	116.7 PK			1.00 V	297	113.8	2.9
3	*5825.00	105.8 AV			1.00 V	297	102.9	2.9
4	#5983.52	53.4 PK	68.2	-14.8	1.00 V	297	50.1	3.3
5	11650.00	58.6 PK	74.0	-15.4	2.20 V	198	45.4	13.2
6	11650.00	45.7 AV	54.0	-8.3	2.20 V	198	32.5	13.2
7	#17475.00	56.1 PK	74.0	-17.9	2.81 V	176	36.7	19.4
8	#17475.00	45.4 AV	54.0	-8.6	2.81 V	176	26.0	19.4

REMARKS:

1. Emission Level(dBuV/m) = Raw Value(dBuV) + Correction Factor(dB/m)
2. Correction Factor(dB/m) = Antenna Factor(dB/m) + Cable Factor(dB) – Pre-Amplifier Factor(dB)
3. The other emission levels were very low against the limit.
4. Margin value = Emission Level – Limit value
5. " * ": Fundamental frequency.
6. " # ": The radiated frequency is out of the restricted band.

802.11ac (VHT20)

CHANNEL	TX Channel 36	DETECTOR FUNCTION	Peak (PK)
FREQUENCY RANGE	1GHz ~ 40GHz		Average (AV)

ANTENNA POLARITY & TEST DISTANCE: HORIZONTAL AT 3 M

NO.	FREQ. (MHz)	EMISSION LEVEL (dBuV/m)	LIMIT (dBuV/m)	MARGIN (dB)	ANTENNA HEIGHT (m)	TABLE ANGLE (Degree)	RAW VALUE (dBuV)	CORRECTION FACTOR (dB/m)
1	5094.80	57.2 PK	74.0	-16.8	1.44 H	171	55.7	1.5
2	5094.80	45.9 AV	54.0	-8.1	1.44 H	171	44.4	1.5
3	5150.00	68.3 PK	74.0	-5.7	1.44 H	171	66.7	1.6
4	5150.00	50.1 AV	54.0	-3.9	1.44 H	171	48.5	1.6
5	*5180.00	107.6 PK			1.44 H	171	105.9	1.7
6	*5180.00	96.9 AV			1.44 H	171	95.2	1.7
7	#10360.00	50.4 PK	74.0	-23.6	1.84 H	209	38.7	11.7
8	#10360.00	37.0 AV	54.0	-17.0	1.84 H	209	25.3	11.7
9	15540.00	51.8 PK	74.0	-22.2	1.26 H	168	38.5	13.3
10	15540.00	39.7 AV	54.0	-14.3	1.26 H	168	26.4	13.3

ANTENNA POLARITY & TEST DISTANCE: VERTICAL AT 3 M

NO.	FREQ. (MHz)	EMISSION LEVEL (dBuV/m)	LIMIT (dBuV/m)	MARGIN (dB)	ANTENNA HEIGHT (m)	TABLE ANGLE (Degree)	RAW VALUE (dBuV)	CORRECTION FACTOR (dB/m)
1	5094.80	60.5 PK	74.0	-13.5	1.06 V	265	59.0	1.5
2	5094.80	48.0 AV	54.0	-6.0	1.06 V	265	46.5	1.5
3	5150.00	72.5 PK	74.0	-1.5	1.06 V	265	70.9	1.6
4	5150.00	52.8 AV	54.0	-1.2	1.06 V	265	51.2	1.6
5	*5180.00	114.9 PK			1.06 V	265	113.2	1.7
6	*5180.00	102.6 AV			1.06 V	265	100.9	1.7
7	#10360.00	50.2 PK	74.0	-23.8	2.21 V	331	38.5	11.7
8	#10360.00	37.4 AV	54.0	-16.6	2.21 V	331	25.7	11.7
9	15540.00	56.4 PK	74.0	-17.6	2.73 V	202	43.1	13.3
10	15540.00	42.5 AV	54.0	-11.5	2.73 V	202	29.2	13.3

REMARKS:

- Emission Level(dBuV/m) = Raw Value(dBuV) + Correction Factor(dB/m)
- Correction Factor(dB/m) = Antenna Factor(dB/m) + Cable Factor(dB) – Pre-Amplifier Factor(dB)
- The other emission levels were very low against the limit.
- Margin value = Emission Level – Limit value
- " * ": Fundamental frequency.
- " # ": The radiated frequency is out of the restricted band.

CHANNEL	TX Channel 40	DETECTOR FUNCTION	Peak (PK)
FREQUENCY RANGE	1GHz ~ 40GHz		Average (AV)

ANTENNA POLARITY & TEST DISTANCE: HORIZONTAL AT 3 M

NO.	FREQ. (MHz)	EMISSION LEVEL (dBuV/m)	LIMIT (dBuV/m)	MARGIN (dB)	ANTENNA HEIGHT (m)	TABLE ANGLE (Degree)	RAW VALUE (dBuV)	CORRECTION FACTOR (dB/m)
1	5119.00	57.7 PK	74.0	-16.3	1.54 H	171	56.2	1.5
2	5119.00	45.6 AV	54.0	-8.4	1.54 H	171	44.1	1.5
3	5150.00	56.2 PK	74.0	-17.8	1.54 H	171	54.6	1.6
4	5150.00	41.2 AV	54.0	-12.8	1.54 H	171	39.6	1.6
5	*5200.00	106.4 PK			1.54 H	171	104.6	1.8
6	*5200.00	96.6 AV			1.54 H	171	94.8	1.8
7	#10400.00	49.8 PK	74.0	-24.2	1.92 H	194	37.9	11.9
8	#10400.00	36.3 AV	54.0	-17.7	1.92 H	194	24.4	11.9
9	15600.00	51.5 PK	74.0	-22.5	1.30 H	189	38.2	13.3
10	15600.00	39.4 AV	54.0	-14.6	1.30 H	189	26.1	13.3

ANTENNA POLARITY & TEST DISTANCE: VERTICAL AT 3 M

NO.	FREQ. (MHz)	EMISSION LEVEL (dBuV/m)	LIMIT (dBuV/m)	MARGIN (dB)	ANTENNA HEIGHT (m)	TABLE ANGLE (Degree)	RAW VALUE (dBuV)	CORRECTION FACTOR (dB/m)
1	5119.00	64.2 PK	74.0	-9.8	1.00 V	230	62.7	1.5
2	5119.00	48.7 AV	54.0	-5.3	1.00 V	230	47.2	1.5
3	5150.00	64.0 PK	74.0	-10.0	1.00 V	230	62.4	1.6
4	5150.00	46.2 AV	54.0	-7.8	1.00 V	230	44.6	1.6
5	*5200.00	115.8 PK			1.00 V	230	114.0	1.8
6	*5200.00	103.0 AV			1.00 V	230	101.2	1.8
7	#10400.00	50.1 PK	74.0	-23.9	2.17 V	337	38.2	11.9
8	#10400.00	37.4 AV	54.0	-16.6	2.17 V	337	25.5	11.9
9	15600.00	56.4 PK	74.0	-17.6	2.72 V	176	43.1	13.3
10	15600.00	42.2 AV	54.0	-11.8	2.72 V	176	28.9	13.3

REMARKS:

1. Emission Level(dBuV/m) = Raw Value(dBuV) + Correction Factor(dB/m)
2. Correction Factor(dB/m) = Antenna Factor(dB/m) + Cable Factor(dB) – Pre-Amplifier Factor(dB)
3. The other emission levels were very low against the limit.
4. Margin value = Emission Level – Limit value
5. " * ": Fundamental frequency.
6. " # ": The radiated frequency is out of the restricted band.

CHANNEL	TX Channel 48	DETECTOR FUNCTION	Peak (PK)
FREQUENCY RANGE	1GHz ~ 40GHz		Average (AV)

ANTENNA POLARITY & TEST DISTANCE: HORIZONTAL AT 3 M

NO.	FREQ. (MHz)	EMISSION LEVEL (dBuV/m)	LIMIT (dBuV/m)	MARGIN (dB)	ANTENNA HEIGHT (m)	TABLE ANGLE (Degree)	RAW VALUE (dBuV)	CORRECTION FACTOR (dB/m)
1	*5240.00	106.7 PK			1.53 H	169	104.9	1.8
2	*5240.00	96.7 AV			1.53 H	169	94.9	1.8
3	5350.00	56.0 PK	74.0	-18.0	1.53 H	169	53.9	2.1
4	5350.00	40.7 AV	54.0	-13.3	1.53 H	169	38.6	2.1
5	5398.00	57.3 PK	74.0	-16.7	1.53 H	169	55.1	2.2
6	5398.00	45.2 AV	54.0	-8.8	1.53 H	169	43.0	2.2
7	#10480.00	49.5 PK	74.0	-24.5	1.96 H	200	37.3	12.2
8	#10480.00	36.0 AV	54.0	-18.0	1.96 H	200	23.8	12.2
9	15720.00	51.5 PK	74.0	-22.5	1.32 H	197	38.3	13.2
10	15720.00	39.2 AV	54.0	-14.8	1.32 H	197	26.0	13.2

ANTENNA POLARITY & TEST DISTANCE: VERTICAL AT 3 M

NO.	FREQ. (MHz)	EMISSION LEVEL (dBuV/m)	LIMIT (dBuV/m)	MARGIN (dB)	ANTENNA HEIGHT (m)	TABLE ANGLE (Degree)	RAW VALUE (dBuV)	CORRECTION FACTOR (dB/m)
1	*5240.00	114.4 PK			1.10 V	277	112.6	1.8
2	*5240.00	102.0 AV			1.10 V	277	100.2	1.8
3	5350.00	62.0 PK	74.0	-12.0	1.10 V	277	59.9	2.1
4	5350.00	42.9 AV	54.0	-11.1	1.10 V	277	40.8	2.1
5	5398.00	62.8 PK	74.0	-11.2	1.10 V	277	60.6	2.2
6	5398.00	50.4 AV	54.0	-3.6	1.10 V	277	48.2	2.2
7	#10480.00	50.6 PK	74.0	-23.4	2.11 V	319	38.4	12.2
8	#10480.00	37.8 AV	54.0	-16.2	2.11 V	319	25.6	12.2
9	15720.00	55.5 PK	74.0	-18.5	2.68 V	176	42.3	13.2
10	15720.00	41.6 AV	54.0	-12.4	2.68 V	176	28.4	13.2

REMARKS:

1. Emission Level(dBuV/m) = Raw Value(dBuV) + Correction Factor(dB/m)
2. Correction Factor(dB/m) = Antenna Factor(dB/m) + Cable Factor(dB) – Pre-Amplifier Factor(dB)
3. The other emission levels were very low against the limit.
4. Margin value = Emission Level – Limit value
5. " * ": Fundamental frequency.
6. " # ": The radiated frequency is out of the restricted band.

CHANNEL	TX Channel 149	DETECTOR FUNCTION	Peak (PK)
FREQUENCY RANGE	1GHz ~ 40GHz		Average (AV)

ANTENNA POLARITY & TEST DISTANCE: HORIZONTAL AT 3 M

NO.	FREQ. (MHz)	EMISSION LEVEL (dBuV/m)	LIMIT (dBuV/m)	MARGIN (dB)	ANTENNA HEIGHT (m)	TABLE ANGLE (Degree)	RAW VALUE (dBuV)	CORRECTION FACTOR (dB/m)
1	#5579.90	58.3 PK	68.2	-9.9	1.41 H	321	55.8	2.5
2	*5745.00	107.9 PK			1.41 H	321	105.1	2.8
3	*5745.00	97.2 AV			1.41 H	321	94.4	2.8
4	#5952.30	56.7 PK	68.2	-11.5	1.41 H	321	53.5	3.2
5	11490.00	53.0 PK	74.0	-21.0	1.72 H	219	39.5	13.5
6	11490.00	40.3 AV	54.0	-13.7	1.72 H	219	26.8	13.5
7	#17235.00	57.5 PK	74.0	-16.5	1.49 H	166	39.1	18.4
8	#17235.00	44.8 AV	54.0	-9.2	1.49 H	166	26.4	18.4

ANTENNA POLARITY & TEST DISTANCE: VERTICAL AT 3 M

NO.	FREQ. (MHz)	EMISSION LEVEL (dBuV/m)	LIMIT (dBuV/m)	MARGIN (dB)	ANTENNA HEIGHT (m)	TABLE ANGLE (Degree)	RAW VALUE (dBuV)	CORRECTION FACTOR (dB/m)
1	#5587.12	63.9 PK	68.2	-4.3	1.07 V	294	61.4	2.5
2	*5745.00	116.2 PK			1.07 V	294	113.4	2.8
3	*5745.00	105.8 AV			1.07 V	294	103.0	2.8
4	#5911.12	63.2 PK	78.4	-15.2	1.07 V	294	60.1	3.1
5	11490.00	58.8 PK	74.0	-15.2	2.20 V	196	45.3	13.5
6	11490.00	46.1 AV	54.0	-7.9	2.20 V	196	32.6	13.5
7	#17235.00	56.1 PK	74.0	-17.9	2.80 V	174	37.7	18.4
8	#17235.00	44.8 AV	54.0	-9.2	2.80 V	174	26.4	18.4

REMARKS:

1. Emission Level(dBuV/m) = Raw Value(dBuV) + Correction Factor(dB/m)
2. Correction Factor(dB/m) = Antenna Factor(dB/m) + Cable Factor(dB) – Pre-Amplifier Factor(dB)
3. The other emission levels were very low against the limit.
4. Margin value = Emission Level – Limit value
5. " * ": Fundamental frequency.
6. " # ": The radiated frequency is out of the restricted band.

CHANNEL	TX Channel 157	DETECTOR FUNCTION	Peak (PK)
FREQUENCY RANGE	1GHz ~ 40GHz		Average (AV)

ANTENNA POLARITY & TEST DISTANCE: HORIZONTAL AT 3 M

NO.	FREQ. (MHz)	EMISSION LEVEL (dBuV/m)	LIMIT (dBuV/m)	MARGIN (dB)	ANTENNA HEIGHT (m)	TABLE ANGLE (Degree)	RAW VALUE (dBuV)	CORRECTION FACTOR (dB/m)
1	#5577.12	56.8 PK	68.2	-11.4	1.42 H	303	54.3	2.5
2	*5785.00	107.0 PK			1.42 H	303	104.1	2.9
3	*5785.00	96.3 AV			1.42 H	303	93.4	2.9
4	#5951.80	58.7 PK	68.2	-9.5	1.42 H	303	55.5	3.2
5	11570.00	53.0 PK	74.0	-21.0	1.72 H	219	39.8	13.2
6	11570.00	40.2 AV	54.0	-13.8	1.72 H	219	27.0	13.2
7	#17355.00	57.0 PK	74.0	-17.0	1.55 H	156	37.9	19.1
8	#17355.00	44.3 AV	54.0	-9.7	1.55 H	156	25.2	19.1

ANTENNA POLARITY & TEST DISTANCE: VERTICAL AT 3 M

NO.	FREQ. (MHz)	EMISSION LEVEL (dBuV/m)	LIMIT (dBuV/m)	MARGIN (dB)	ANTENNA HEIGHT (m)	TABLE ANGLE (Degree)	RAW VALUE (dBuV)	CORRECTION FACTOR (dB/m)
1	#5621.68	64.5 PK	68.2	-3.7	1.15 V	309	61.9	2.6
2	*5785.00	117.2 PK			1.15 V	309	114.3	2.9
3	*5785.00	106.6 AV			1.15 V	309	103.7	2.9
4	#5946.10	64.4 PK	68.2	-3.8	1.15 V	309	61.3	3.1
5	11570.00	58.1 PK	74.0	-15.9	2.19 V	209	44.9	13.2
6	11570.00	45.6 AV	54.0	-8.4	2.19 V	209	32.4	13.2
7	#17355.00	55.8 PK	74.0	-18.2	2.77 V	198	36.7	19.1
8	#17355.00	45.0 AV	54.0	-9.0	2.77 V	198	25.9	19.1

REMARKS:

1. Emission Level(dBuV/m) = Raw Value(dBuV) + Correction Factor(dB/m)
2. Correction Factor(dB/m) = Antenna Factor(dB/m) + Cable Factor(dB) – Pre-Amplifier Factor(dB)
3. The other emission levels were very low against the limit.
4. Margin value = Emission Level – Limit value
5. " * ": Fundamental frequency.
6. " # ": The radiated frequency is out of the restricted band.

CHANNEL	TX Channel 165	DETECTOR FUNCTION	Peak (PK)
FREQUENCY RANGE	1GHz ~ 40GHz		Average (AV)

ANTENNA POLARITY & TEST DISTANCE: HORIZONTAL AT 3 M

NO.	FREQ. (MHz)	EMISSION LEVEL (dBuV/m)	LIMIT (dBuV/m)	MARGIN (dB)	ANTENNA HEIGHT (m)	TABLE ANGLE (Degree)	RAW VALUE (dBuV)	CORRECTION FACTOR (dB/m)
1	#5592.32	56.8 PK	68.2	-11.4	1.36 H	318	54.3	2.5
2	*5825.00	106.7 PK			1.36 H	318	103.8	2.9
3	*5825.00	96.3 AV			1.36 H	318	93.4	2.9
4	#5987.90	58.6 PK	68.2	-9.6	1.36 H	318	55.3	3.3
5	11650.00	52.5 PK	74.0	-21.5	1.68 H	228	39.3	13.2
6	11650.00	39.8 AV	54.0	-14.2	1.68 H	228	26.6	13.2
7	#17475.00	57.5 PK	74.0	-16.5	1.55 H	161	38.1	19.4
8	#17475.00	44.9 AV	54.0	-9.1	1.55 H	161	25.5	19.4

ANTENNA POLARITY & TEST DISTANCE: VERTICAL AT 3 M

NO.	FREQ. (MHz)	EMISSION LEVEL (dBuV/m)	LIMIT (dBuV/m)	MARGIN (dB)	ANTENNA HEIGHT (m)	TABLE ANGLE (Degree)	RAW VALUE (dBuV)	CORRECTION FACTOR (dB/m)
1	#5592.30	59.4 PK	68.2	-8.8	1.09 V	308	56.9	2.5
2	*5825.00	117.5 PK			1.09 V	308	114.6	2.9
3	*5825.00	107.0 AV			1.09 V	308	104.1	2.9
4	#5990.30	63.5 PK	68.2	-4.7	1.00 V	310	60.1	3.4
5	11650.00	57.7 PK	74.0	-16.3	2.24 V	204	44.5	13.2
6	11650.00	45.1 AV	54.0	-8.9	2.24 V	204	31.9	13.2
7	#17475.00	55.9 PK	74.0	-18.1	2.80 V	204	36.5	19.4
8	#17475.00	45.0 AV	54.0	-9.0	2.80 V	204	25.6	19.4

REMARKS:

1. Emission Level(dBuV/m) = Raw Value(dBuV) + Correction Factor(dB/m)
2. Correction Factor(dB/m) = Antenna Factor(dB/m) + Cable Factor(dB) – Pre-Amplifier Factor(dB)
3. The other emission levels were very low against the limit.
4. Margin value = Emission Level – Limit value
5. " * ": Fundamental frequency.
6. " # ": The radiated frequency is out of the restricted band.

802.11ac (VHT40)

CHANNEL	TX Channel 38	DETECTOR FUNCTION	Peak (PK)
FREQUENCY RANGE	1GHz ~ 40GHz		Average (AV)

ANTENNA POLARITY & TEST DISTANCE: HORIZONTAL AT 3 M

NO.	FREQ. (MHz)	EMISSION LEVEL (dBuV/m)	LIMIT (dBuV/m)	MARGIN (dB)	ANTENNA HEIGHT (m)	TABLE ANGLE (Degree)	RAW VALUE (dBuV)	CORRECTION FACTOR (dB/m)
1	5150.00	57.4 PK	74.0	-16.6	1.41 H	177	55.8	1.6
2	5150.00	44.2 AV	54.0	-9.8	1.41 H	177	42.6	1.6
3	*5190.00	98.8 PK			1.41 H	177	97.0	1.8
4	*5190.00	89.0 AV			1.41 H	177	87.2	1.8
5	5352.00	53.5 PK	74.0	-20.5	1.41 H	177	51.4	2.1
6	5352.00	42.1 AV	54.0	-11.9	1.41 H	177	40.0	2.1
7	#10380.00	49.2 PK	74.0	-24.8	1.90 H	234	37.4	11.8
8	#10380.00	35.3 AV	54.0	-18.7	1.90 H	234	23.5	11.8
9	15570.00	51.3 PK	74.0	-22.7	1.29 H	182	38.0	13.3
10	15570.00	39.4 AV	54.0	-14.6	1.29 H	182	26.1	13.3

ANTENNA POLARITY & TEST DISTANCE: VERTICAL AT 3 M

NO.	FREQ. (MHz)	EMISSION LEVEL (dBuV/m)	LIMIT (dBuV/m)	MARGIN (dB)	ANTENNA HEIGHT (m)	TABLE ANGLE (Degree)	RAW VALUE (dBuV)	CORRECTION FACTOR (dB/m)
1	5150.00	72.9 PK	74.0	-1.1	1.03 V	229	71.3	1.6
2	5150.00	53.1 AV	54.0	-0.9	1.03 V	229	51.5	1.6
3	*5190.00	108.1 PK			1.03 V	229	106.3	1.8
4	*5190.00	95.8 AV			1.03 V	229	94.0	1.8
5	5352.00	58.5 PK	74.0	-15.5	1.03 V	229	56.4	2.1
6	5352.00	46.8 AV	54.0	-7.2	1.03 V	229	44.7	2.1
7	#10380.00	49.3 PK	74.0	-24.7	2.23 V	319	37.5	11.8
8	#10380.00	36.1 AV	54.0	-17.9	2.23 V	319	24.3	11.8
9	15570.00	54.4 PK	74.0	-19.6	2.82 V	183	41.1	13.3
10	15570.00	40.8 AV	54.0	-13.2	2.82 V	183	27.5	13.3

REMARKS:

- Emission Level(dBuV/m) = Raw Value(dBuV) + Correction Factor(dB/m)
- Correction Factor(dB/m) = Antenna Factor(dB/m) + Cable Factor(dB) – Pre-Amplifier Factor(dB)
- The other emission levels were very low against the limit.
- Margin value = Emission Level – Limit value
- " * ": Fundamental frequency.
- " # ": The radiated frequency is out of the restricted band.

CHANNEL	TX Channel 46	DETECTOR FUNCTION	Peak (PK)
FREQUENCY RANGE	1GHz ~ 40GHz		Average (AV)

ANTENNA POLARITY & TEST DISTANCE: HORIZONTAL AT 3 M

NO.	FREQ. (MHz)	EMISSION LEVEL (dBuV/m)	LIMIT (dBuV/m)	MARGIN (dB)	ANTENNA HEIGHT (m)	TABLE ANGLE (Degree)	RAW VALUE (dBuV)	CORRECTION FACTOR (dB/m)
1	*5230.00	103.5 PK			1.41 H	186	101.7	1.8
2	*5230.00	92.5 AV			1.41 H	186	90.7	1.8
3	5350.00	50.1 PK	74.0	-23.9	1.41 H	186	48.0	2.1
4	5350.00	40.3 AV	54.0	-13.7	1.41 H	186	38.2	2.1
5	5384.00	56.3 PK	74.0	-17.7	1.41 H	186	54.1	2.2
6	5384.00	44.9 AV	54.0	-9.1	1.41 H	186	42.7	2.2
7	#10460.00	49.7 PK	74.0	-24.3	1.94 H	207	37.6	12.1
8	#10460.00	36.0 AV	54.0	-18.0	1.94 H	207	23.9	12.1
9	15690.00	51.8 PK	74.0	-22.2	1.18 H	203	38.6	13.2
10	15690.00	39.8 AV	54.0	-14.2	1.18 H	203	26.6	13.2

ANTENNA POLARITY & TEST DISTANCE: VERTICAL AT 3 M

NO.	FREQ. (MHz)	EMISSION LEVEL (dBuV/m)	LIMIT (dBuV/m)	MARGIN (dB)	ANTENNA HEIGHT (m)	TABLE ANGLE (Degree)	RAW VALUE (dBuV)	CORRECTION FACTOR (dB/m)
1	*5230.00	112.1 PK			1.02 V	229	110.3	1.8
2	*5230.00	99.8 AV			1.02 V	229	98.0	1.8
3	5350.00	56.9 PK	74.0	-17.1	1.02 V	229	54.8	2.1
4	5350.00	43.3 AV	54.0	-10.7	1.02 V	229	41.2	2.1
5	5384.00	61.1 PK	74.0	-12.9	1.02 V	229	58.9	2.2
6	5384.00	40.9 AV	54.0	-13.1	1.02 V	229	38.7	2.2
7	#10460.00	50.2 PK	74.0	-23.8	2.15 V	313	38.1	12.1
8	#10460.00	36.5 AV	54.0	-17.5	2.15 V	313	24.4	12.1
9	15690.00	54.7 PK	74.0	-19.3	2.75 V	175	41.5	13.2
10	15690.00	41.3 AV	54.0	-12.7	2.75 V	175	28.1	13.2

REMARKS:

1. Emission Level(dBuV/m) = Raw Value(dBuV) + Correction Factor(dB/m)
2. Correction Factor(dB/m) = Antenna Factor(dB/m) + Cable Factor(dB) – Pre-Amplifier Factor(dB)
3. The other emission levels were very low against the limit.
4. Margin value = Emission Level – Limit value
5. " * ": Fundamental frequency.
6. " # ": The radiated frequency is out of the restricted band.

CHANNEL	TX Channel 151	DETECTOR FUNCTION	Peak (PK)
FREQUENCY RANGE	1GHz ~ 40GHz		Average (AV)

ANTENNA POLARITY & TEST DISTANCE: HORIZONTAL AT 3 M

NO.	FREQ. (MHz)	EMISSION LEVEL (dBuV/m)	LIMIT (dBuV/m)	MARGIN (dB)	ANTENNA HEIGHT (m)	TABLE ANGLE (Degree)	RAW VALUE (dBuV)	CORRECTION FACTOR (dB/m)
1	#5589.77	58.3 PK	68.2	-9.9	1.10 H	321	55.8	2.5
2	*5755.00	104.2 PK			1.10 H	321	101.3	2.9
3	*5755.00	93.6 AV			1.10 H	321	90.7	2.9
4	#5964.60	58.1 PK	68.2	-10.1	1.10 H	321	54.9	3.2
5	11510.00	51.4 PK	74.0	-22.6	1.69 H	230	37.9	13.5
6	11510.00	37.9 AV	54.0	-16.1	1.69 H	230	24.4	13.5
7	#17265.00	57.0 PK	74.0	-17.0	1.46 H	170	38.5	18.5
8	#17265.00	43.7 AV	54.0	-10.3	1.46 H	170	25.2	18.5

ANTENNA POLARITY & TEST DISTANCE: VERTICAL AT 3 M

NO.	FREQ. (MHz)	EMISSION LEVEL (dBuV/m)	LIMIT (dBuV/m)	MARGIN (dB)	ANTENNA HEIGHT (m)	TABLE ANGLE (Degree)	RAW VALUE (dBuV)	CORRECTION FACTOR (dB/m)
1	#5659.70	69.3 PK	75.4	-6.1	1.17 V	319	66.7	2.6
2	*5755.00	113.3 PK			1.17 V	319	110.4	2.9
3	*5755.00	102.3 AV			1.17 V	319	99.4	2.9
4	#5930.40	61.6 PK	68.2	-6.6	1.17 V	319	58.5	3.1
5	11510.00	55.4 PK	74.0	-18.6	2.20 V	208	41.9	13.5
6	11510.00	43.2 AV	54.0	-10.8	2.20 V	208	29.7	13.5
7	#17265.00	53.0 PK	74.0	-21.0	2.83 V	205	34.5	18.5
8	#17265.00	42.0 AV	54.0	-12.0	2.83 V	205	23.5	18.5

REMARKS:

1. Emission Level(dBuV/m) = Raw Value(dBuV) + Correction Factor(dB/m)
2. Correction Factor(dB/m) = Antenna Factor(dB/m) + Cable Factor(dB) – Pre-Amplifier Factor(dB)
3. The other emission levels were very low against the limit.
4. Margin value = Emission Level – Limit value
5. " * ": Fundamental frequency.
6. " # ": The radiated frequency is out of the restricted band.

CHANNEL	TX Channel 159	DETECTOR FUNCTION	Peak (PK)
FREQUENCY RANGE	1GHz ~ 40GHz		Average (AV)

ANTENNA POLARITY & TEST DISTANCE: HORIZONTAL AT 3 M

NO.	FREQ. (MHz)	EMISSION LEVEL (dBuV/m)	LIMIT (dBuV/m)	MARGIN (dB)	ANTENNA HEIGHT (m)	TABLE ANGLE (Degree)	RAW VALUE (dBuV)	CORRECTION FACTOR (dB/m)
1	#5649.70	58.8 PK	68.2	-9.4	1.05 H	317	56.2	2.6
2	*5795.00	104.2 PK			1.05 H	317	101.3	2.9
3	*5795.00	93.7 AV			1.05 H	317	90.8	2.9
4	#5959.40	58.2 PK	68.2	-10.0	1.05 H	317	55.0	3.2
5	11590.00	51.1 PK	74.0	-22.9	1.73 H	233	38.0	13.1
6	11590.00	37.7 AV	54.0	-16.3	1.73 H	233	24.6	13.1
7	#17385.00	57.0 PK	74.0	-17.0	1.44 H	155	37.7	19.3
8	#17385.00	43.7 AV	54.0	-10.3	1.44 H	155	24.4	19.3

ANTENNA POLARITY & TEST DISTANCE: VERTICAL AT 3 M

NO.	FREQ. (MHz)	EMISSION LEVEL (dBuV/m)	LIMIT (dBuV/m)	MARGIN (dB)	ANTENNA HEIGHT (m)	TABLE ANGLE (Degree)	RAW VALUE (dBuV)	CORRECTION FACTOR (dB/m)
1	#5637.80	61.3 PK	68.2	-6.9	1.20 V	325	58.7	2.6
2	*5795.00	113.5 PK			1.20 V	325	110.6	2.9
3	*5795.00	102.7 AV			1.20 V	325	99.8	2.9
4	#5937.52	62.7 PK	68.2	-5.5	1.20 V	325	59.6	3.1
5	11590.00	55.7 PK	74.0	-18.3	2.15 V	200	42.6	13.1
6	11590.00	43.2 AV	54.0	-10.8	2.15 V	200	30.1	13.1
7	#17385.00	53.6 PK	74.0	-20.4	2.87 V	209	34.3	19.3
8	#17385.00	42.3 AV	54.0	-11.7	2.87 V	209	23.0	19.3

REMARKS:

1. Emission Level(dBuV/m) = Raw Value(dBuV) + Correction Factor(dB/m)
2. Correction Factor(dB/m) = Antenna Factor(dB/m) + Cable Factor(dB) – Pre-Amplifier Factor(dB)
3. The other emission levels were very low against the limit.
4. Margin value = Emission Level – Limit value
5. " * ": Fundamental frequency.
6. " # ": The radiated frequency is out of the restricted band.

802.11ac (VHT80)

CHANNEL	TX Channel 42	DETECTOR FUNCTION	Peak (PK)
FREQUENCY RANGE	1GHz ~ 40GHz		Average (AV)

ANTENNA POLARITY & TEST DISTANCE: HORIZONTAL AT 3 M

NO.	FREQ. (MHz)	EMISSION LEVEL (dBuV/m)	LIMIT (dBuV/m)	MARGIN (dB)	ANTENNA HEIGHT (m)	TABLE ANGLE (Degree)	RAW VALUE (dBuV)	CORRECTION FACTOR (dB/m)
1	5150.00	60.2 PK	74.0	-13.8	1.65 H	185	58.6	1.6
2	5150.00	44.8 AV	54.0	-9.2	1.65 H	185	43.2	1.6
3	*5210.00	97.9 PK			1.65 H	185	96.1	1.8
4	*5210.00	85.6 AV			1.65 H	185	83.8	1.8
5	5350.00	53.5 PK	74.0	-20.5	1.65 H	185	51.4	2.1
6	5350.00	41.3 AV	54.0	-12.7	1.65 H	185	39.2	2.1
7	#10420.00	50.2 PK	74.0	-23.8	1.90 H	195	38.2	12.0
8	#10420.00	38.9 AV	54.0	-15.1	1.90 H	195	26.9	12.0
9	15630.00	51.9 PK	74.0	-22.1	1.39 H	219	38.6	13.3
10	15630.00	40.3 AV	54.0	-13.7	1.39 H	219	27.0	13.3

ANTENNA POLARITY & TEST DISTANCE: VERTICAL AT 3 M

NO.	FREQ. (MHz)	EMISSION LEVEL (dBuV/m)	LIMIT (dBuV/m)	MARGIN (dB)	ANTENNA HEIGHT (m)	TABLE ANGLE (Degree)	RAW VALUE (dBuV)	CORRECTION FACTOR (dB/m)
1	5150.00	68.4 PK	74.0	-5.6	1.02 V	269	66.8	1.6
2	5150.00	53.2 AV	54.0	-0.8	1.02 V	269	51.6	1.6
3	*5210.00	105.1 PK			1.02 V	269	103.3	1.8
4	*5210.00	92.1 AV			1.02 V	269	90.3	1.8
5	5350.00	56.9 PK	74.0	-17.1	1.02 V	269	54.8	2.1
6	5350.00	43.5 AV	54.0	-10.5	1.02 V	269	41.4	2.1
7	#10420.00	49.7 PK	74.0	-24.3	2.03 V	337	37.7	12.0
8	#10420.00	41.3 AV	54.0	-12.7	2.03 V	337	29.3	12.0
9	15630.00	51.4 PK	74.0	-22.6	2.52 V	187	38.1	13.3
10	15630.00	38.3 AV	54.0	-15.7	2.52 V	187	25.0	13.3

REMARKS:

- Emission Level(dBuV/m) = Raw Value(dBuV) + Correction Factor(dB/m)
- Correction Factor(dB/m) = Antenna Factor(dB/m) + Cable Factor(dB) – Pre-Amplifier Factor(dB)
- The other emission levels were very low against the limit.
- Margin value = Emission Level – Limit value
- " * ": Fundamental frequency.
- " # ": The radiated frequency is out of the restricted band.

CHANNEL	TX Channel 155	DETECTOR FUNCTION	Peak (PK)
FREQUENCY RANGE	1GHz ~ 40GHz		Average (AV)

ANTENNA POLARITY & TEST DISTANCE: HORIZONTAL AT 3 M

NO.	FREQ. (MHz)	EMISSION LEVEL (dBuV/m)	LIMIT (dBuV/m)	MARGIN (dB)	ANTENNA HEIGHT (m)	TABLE ANGLE (Degree)	RAW VALUE (dBuV)	CORRECTION FACTOR (dB/m)
1	#5627.76	58.4 PK	68.2	-9.8	1.19 H	171	55.8	2.6
2	*5775.00	100.6 PK			1.19 H	171	97.7	2.9
3	*5775.00	87.6 AV			1.19 H	171	84.7	2.9
4	#5924.70	58.7 PK	68.4	-9.7	1.19 H	171	55.6	3.1
5	11550.00	52.6 PK	74.0	-21.4	1.66 H	219	39.3	13.3
6	11550.00	40.1 AV	54.0	-13.9	1.66 H	219	26.8	13.3
7	#17325.00	56.1 PK	74.0	-17.9	1.40 H	204	37.2	18.9
8	#17325.00	44.0 AV	54.0	-10.0	1.40 H	204	25.1	18.9

ANTENNA POLARITY & TEST DISTANCE: VERTICAL AT 3 M

NO.	FREQ. (MHz)	EMISSION LEVEL (dBuV/m)	LIMIT (dBuV/m)	MARGIN (dB)	ANTENNA HEIGHT (m)	TABLE ANGLE (Degree)	RAW VALUE (dBuV)	CORRECTION FACTOR (dB/m)
1	#5643.12	66.8 PK	68.2	-1.4	1.05 V	306	64.2	2.6
2	*5775.00	108.1 PK			1.05 V	306	105.2	2.9
3	*5775.00	94.9 AV			1.05 V	306	92.0	2.9
4	#5920.40	68.3 PK	71.6	-3.3	1.05 V	306	65.2	3.1
5	11550.00	53.4 PK	74.0	-20.6	2.37 V	198	40.1	13.3
6	11550.00	40.8 AV	54.0	-13.2	2.37 V	198	27.5	13.3
7	#17325.00	55.7 PK	74.0	-18.3	2.65 V	170	36.8	18.9
8	#17325.00	43.9 AV	54.0	-10.1	2.65 V	170	25.0	18.9

REMARKS:

1. Emission Level(dBuV/m) = Raw Value(dBuV) + Correction Factor(dB/m)
2. Correction Factor(dB/m) = Antenna Factor(dB/m) + Cable Factor(dB) – Pre-Amplifier Factor(dB)
3. The other emission levels were very low against the limit.
4. Margin value = Emission Level – Limit value
5. " * ": Fundamental frequency.
6. " # ": The radiated frequency is out of the restricted band.

Below 1GHz Data:

802.11ac (VHT20)

CHANNEL	TX Channel 40	DETECTOR FUNCTION	Quasi-Peak (QP)
FREQUENCY RANGE	below 1GHz		

ANTENNA POLARITY & TEST DISTANCE: HORIZONTAL AT 3 M

NO.	FREQ. (MHz)	EMISSION LEVEL (dBuV/m)	LIMIT (dBuV/m)	MARGIN (dB)	ANTENNA HEIGHT (m)	TABLE ANGLE (Degree)	RAW VALUE (dBuV)	CORRECTION FACTOR (dB/m)
1	39.36	32.3 QP	40.0	-7.7	1.50 H	255	41.3	-9.0
2	83.87	31.3 QP	40.0	-8.7	2.00 H	88	45.5	-14.2
3	159.15	28.8 QP	43.5	-14.7	1.50 H	274	37.3	-8.5
4	250.12	26.1 QP	46.0	-19.9	1.00 H	69	36.1	-10.0
5	385.15	30.3 QP	46.0	-15.7	1.00 H	332	36.2	-5.9
6	799.24	35.7 QP	46.0	-10.3	1.00 H	133	33.2	2.5

ANTENNA POLARITY & TEST DISTANCE: VERTICAL AT 3 M

NO.	FREQ. (MHz)	EMISSION LEVEL (dBuV/m)	LIMIT (dBuV/m)	MARGIN (dB)	ANTENNA HEIGHT (m)	TABLE ANGLE (Degree)	RAW VALUE (dBuV)	CORRECTION FACTOR (dB/m)
1	59.46	35.2 QP	40.0	-4.8	1.00 V	174	44.2	-9.0
2	156.76	33.2 QP	43.5	-10.3	1.00 V	116	41.8	-8.6
3	196.54	30.1 QP	43.5	-13.4	1.50 V	107	42.0	-11.9
4	391.15	31.5 QP	46.0	-14.5	1.50 V	305	37.1	-5.6
5	658.33	31.4 QP	46.0	-14.6	2.50 V	123	31.3	0.1
6	799.53	40.5 QP	46.0	-5.5	2.00 V	165	38.0	2.5

REMARKS:

1. Emission Level(dBuV/m) = Raw Value(dBuV) + Correction Factor(dB/m)
2. Correction Factor(dB/m) = Antenna Factor(dB/m) + Cable Factor(dB) – Pre-Amplifier Factor(dB)
3. The other emission levels were very low against the limit.
4. Margin value = Emission Level – Limit value

4.1.8 Test Results (Mode 2)

Above 1GHz Data:

802.11a

CHANNEL	TX Channel 36	DETECTOR FUNCTION	Peak (PK)
FREQUENCY RANGE	1GHz ~ 40GHz		Average (AV)

ANTENNA POLARITY & TEST DISTANCE: HORIZONTAL AT 3 M

NO.	FREQ. (MHz)	EMISSION LEVEL (dBuV/m)	LIMIT (dBuV/m)	MARGIN (dB)	ANTENNA HEIGHT (m)	TABLE ANGLE (Degree)	RAW VALUE (dBuV)	CORRECTION FACTOR (dB/m)
1	5098.40	55.2 PK	74.0	-18.8	1.00 H	50	53.7	1.5
2	5098.40	43.7 AV	54.0	-10.3	1.00 H	50	42.2	1.5
3	5150.00	68.4 PK	74.0	-5.6	1.00 H	55	66.8	1.6
4	5150.00	50.2 AV	54.0	-3.8	1.00 H	55	48.6	1.6
5	*5180.00	106.2 PK			1.00 H	55	104.5	1.7
6	*5180.00	96.1 AV			1.00 H	55	94.4	1.7
7	#10360.00	51.2 PK	74.0	-22.8	1.77 H	200	39.5	11.7
8	#10360.00	37.8 AV	54.0	-16.2	1.77 H	200	26.1	11.7
9	15540.00	51.9 PK	74.0	-22.1	1.50 H	177	38.6	13.3
10	15540.00	41.4 AV	54.0	-12.6	1.50 H	177	28.1	13.3

ANTENNA POLARITY & TEST DISTANCE: VERTICAL AT 3 M

NO.	FREQ. (MHz)	EMISSION LEVEL (dBuV/m)	LIMIT (dBuV/m)	MARGIN (dB)	ANTENNA HEIGHT (m)	TABLE ANGLE (Degree)	RAW VALUE (dBuV)	CORRECTION FACTOR (dB/m)
1	5098.40	60.2 PK	74.0	-13.8	1.04 V	277	58.7	1.5
2	5098.40	48.5 AV	54.0	-5.5	1.04 V	277	47.0	1.5
3	5150.00	70.0 PK	74.0	-4.0	1.03 V	277	68.4	1.6
4	5150.00	53.2 AV	54.0	-0.8	1.03 V	277	51.6	1.6
5	*5180.00	114.0 PK			1.03 V	277	112.3	1.7
6	*5180.00	103.0 AV			1.03 V	277	101.3	1.7
7	#10360.00	52.0 PK	74.0	-22.0	2.30 V	315	40.3	11.7
8	#10360.00	39.0 AV	54.0	-15.0	2.30 V	315	27.3	11.7
9	15540.00	57.1 PK	74.0	-16.9	2.76 V	176	43.8	13.3
10	15540.00	43.1 AV	54.0	-10.9	2.76 V	176	29.8	13.3

REMARKS:

- Emission Level(dBuV/m) = Raw Value(dBuV) + Correction Factor(dB/m)
- Correction Factor(dB/m) = Antenna Factor(dB/m) + Cable Factor(dB) – Pre-Amplifier Factor(dB)
- The other emission levels were very low against the limit.
- Margin value = Emission Level – Limit value
- " * ": Fundamental frequency.
- " # ": The radiated frequency is out of the restricted band.

CHANNEL	TX Channel 40	DETECTOR FUNCTION	Peak (PK)
FREQUENCY RANGE	1GHz ~ 40GHz		Average (AV)

ANTENNA POLARITY & TEST DISTANCE: HORIZONTAL AT 3 M

NO.	FREQ. (MHz)	EMISSION LEVEL (dBuV/m)	LIMIT (dBuV/m)	MARGIN (dB)	ANTENNA HEIGHT (m)	TABLE ANGLE (Degree)	RAW VALUE (dBuV)	CORRECTION FACTOR (dB/m)
1	5119.00	57.8 PK	74.0	-16.2	1.29 H	67	56.3	1.5
2	5119.00	45.5 AV	54.0	-8.5	1.29 H	67	44.0	1.5
3	5150.00	55.5 PK	74.0	-18.5	1.29 H	67	53.9	1.6
4	5150.00	40.7 AV	54.0	-13.3	1.29 H	67	39.1	1.6
5	*5200.00	104.7 PK			1.29 H	67	102.9	1.8
6	*5200.00	95.2 AV			1.29 H	67	93.4	1.8
7	#10400.00	51.0 PK	74.0	-23.0	1.74 H	216	39.1	11.9
8	#10400.00	37.6 AV	54.0	-16.4	1.74 H	216	25.7	11.9
9	15600.00	51.6 PK	74.0	-22.4	1.44 H	171	38.3	13.3
10	15600.00	41.4 AV	54.0	-12.6	1.44 H	171	28.1	13.3

ANTENNA POLARITY & TEST DISTANCE: VERTICAL AT 3 M

NO.	FREQ. (MHz)	EMISSION LEVEL (dBuV/m)	LIMIT (dBuV/m)	MARGIN (dB)	ANTENNA HEIGHT (m)	TABLE ANGLE (Degree)	RAW VALUE (dBuV)	CORRECTION FACTOR (dB/m)
1	5119.00	61.4 PK	74.0	-12.6	1.00 V	242	59.9	1.5
2	5119.00	48.3 AV	54.0	-5.7	1.00 V	242	46.8	1.5
3	5150.00	63.1 PK	74.0	-10.9	1.00 V	240	61.5	1.6
4	5150.00	49.4 AV	54.0	-4.6	1.00 V	240	47.8	1.6
5	*5200.00	114.8 PK			1.00 V	240	113.0	1.8
6	*5200.00	103.7 AV			1.00 V	240	101.9	1.8
7	#10400.00	51.5 PK	74.0	-22.5	2.34 V	330	39.6	11.9
8	#10400.00	38.7 AV	54.0	-15.3	2.34 V	330	26.8	11.9
9	15600.00	57.6 PK	74.0	-16.4	2.78 V	162	44.3	13.3
10	15600.00	43.5 AV	54.0	-10.5	2.78 V	162	30.2	13.3

REMARKS:

- Emission Level(dBuV/m) = Raw Value(dBuV) + Correction Factor(dB/m)
- Correction Factor(dB/m) = Antenna Factor(dB/m) + Cable Factor(dB) – Pre-Amplifier Factor(dB)
- The other emission levels were very low against the limit.
- Margin value = Emission Level – Limit value
- " * ": Fundamental frequency.
- " # ": The radiated frequency is out of the restricted band.

CHANNEL	TX Channel 48	DETECTOR FUNCTION	Peak (PK)
FREQUENCY RANGE	1GHz ~ 40GHz		Average (AV)

ANTENNA POLARITY & TEST DISTANCE: HORIZONTAL AT 3 M

NO.	FREQ. (MHz)	EMISSION LEVEL (dBuV/m)	LIMIT (dBuV/m)	MARGIN (dB)	ANTENNA HEIGHT (m)	TABLE ANGLE (Degree)	RAW VALUE (dBuV)	CORRECTION FACTOR (dB/m)
1	*5240.00	104.3 PK			1.31 H	75	102.5	1.8
2	*5240.00	94.5 AV			1.31 H	75	92.7	1.8
3	5350.00	50.5 PK	74.0	-23.5	1.31 H	75	48.4	2.1
4	5350.00	40.2 AV	54.0	-13.8	1.31 H	75	38.1	2.1
5	5398.00	56.7 PK	74.0	-17.3	1.31 H	75	54.5	2.2
6	5398.00	45.6 AV	54.0	-8.4	1.31 H	75	43.4	2.2
7	#10480.00	51.1 PK	74.0	-22.9	1.73 H	210	38.9	12.2
8	#10480.00	37.4 AV	54.0	-16.6	1.73 H	210	25.2	12.2
9	15720.00	51.9 PK	74.0	-22.1	1.48 H	187	38.7	13.2
10	15720.00	41.7 AV	54.0	-12.3	1.48 H	187	28.5	13.2

ANTENNA POLARITY & TEST DISTANCE: VERTICAL AT 3 M

NO.	FREQ. (MHz)	EMISSION LEVEL (dBuV/m)	LIMIT (dBuV/m)	MARGIN (dB)	ANTENNA HEIGHT (m)	TABLE ANGLE (Degree)	RAW VALUE (dBuV)	CORRECTION FACTOR (dB/m)
1	*5240.00	115.5 PK			1.12 V	284	113.7	1.8
2	*5240.00	104.1 AV			1.12 V	284	102.3	1.8
3	5350.00	57.2 PK	74.0	-16.8	1.12 V	284	55.1	2.1
4	5350.00	42.6 AV	54.0	-11.4	1.12 V	284	40.5	2.1
5	5398.00	62.8 PK	74.0	-11.2	1.10 V	290	60.6	2.2
6	5398.00	51.1 AV	54.0	-2.9	1.10 V	290	48.9	2.2
7	#10480.00	52.0 PK	74.0	-22.0	2.29 V	320	39.8	12.2
8	#10480.00	39.1 AV	54.0	-14.9	2.29 V	320	26.9	12.2
9	15720.00	57.2 PK	74.0	-16.8	2.79 V	177	44.0	13.2
10	15720.00	43.3 AV	54.0	-10.7	2.79 V	177	30.1	13.2

REMARKS:

- Emission Level(dBuV/m) = Raw Value(dBuV) + Correction Factor(dB/m)
- Correction Factor(dB/m) = Antenna Factor(dB/m) + Cable Factor(dB) – Pre-Amplifier Factor(dB)
- The other emission levels were very low against the limit.
- Margin value = Emission Level – Limit value
- " * ": Fundamental frequency.
- " # ": The radiated frequency is out of the restricted band.

CHANNEL	TX Channel 149	DETECTOR FUNCTION	Peak (PK)
FREQUENCY RANGE	1GHz ~ 40GHz		Average (AV)

ANTENNA POLARITY & TEST DISTANCE: HORIZONTAL AT 3 M

NO.	FREQ. (MHz)	EMISSION LEVEL (dBuV/m)	LIMIT (dBuV/m)	MARGIN (dB)	ANTENNA HEIGHT (m)	TABLE ANGLE (Degree)	RAW VALUE (dBuV)	CORRECTION FACTOR (dB/m)
1	#5587.52	57.9 PK	68.2	-10.3	1.09 H	187	55.4	2.5
2	#5715.00	62.3 PK	74.0	-11.7	1.37 H	182	59.5	2.8
3	#5715.00	41.9 AV	54.0	-12.1	1.37 H	182	39.1	2.8
4	#5725.00	73.3 PK	78.2	-4.9	1.37 H	182	70.5	2.8
5	*5745.00	100.5 PK			1.37 H	182	97.7	2.8
6	*5745.00	89.7 AV			1.37 H	182	86.9	2.8
7	#5976.07	58.3 PK	68.2	-9.9	1.09 H	187	55.1	3.2
8	11490.00	52.0 PK	74.0	-22.0	1.79 H	216	38.5	13.5
9	11490.00	38.2 AV	54.0	-15.8	1.79 H	216	24.7	13.5
10	#17235.00	52.2 PK	74.0	-21.8	1.51 H	195	33.8	18.4
11	#17235.00	41.9 AV	54.0	-12.1	1.51 H	195	23.5	18.4

ANTENNA POLARITY & TEST DISTANCE: VERTICAL AT 3 M

NO.	FREQ. (MHz)	EMISSION LEVEL (dBuV/m)	LIMIT (dBuV/m)	MARGIN (dB)	ANTENNA HEIGHT (m)	TABLE ANGLE (Degree)	RAW VALUE (dBuV)	CORRECTION FACTOR (dB/m)
1	#5583.25	64.6 PK	68.2	-3.6	1.06 V	296	62.1	2.5
2	#5715.00	65.7 PK	74.0	-8.3	1.00 V	202	62.9	2.8
3	#5715.00	45.5 AV	54.0	-8.5	1.00 V	202	42.7	2.8
4	#5725.00	77.9 PK	78.2	-0.3	1.00 V	202	75.1	2.8
5	*5745.00	110.2 PK			1.00 V	202	107.4	2.8
6	*5745.00	99.6 AV			1.00 V	202	96.8	2.8
7	#5911.95	64.8 PK	77.8	-13.0	1.06 V	296	61.7	3.1
8	11490.00	51.9 PK	74.0	-22.1	2.31 V	317	38.4	13.5
9	11490.00	38.6 AV	54.0	-15.4	2.31 V	317	25.1	13.5
10	#17235.00	57.0 PK	74.0	-17.0	2.74 V	204	38.6	18.4
11	#17235.00	43.1 AV	54.0	-10.9	2.74 V	204	24.7	18.4

REMARKS:

1. Emission Level(dBuV/m) = Raw Value(dBuV) + Correction Factor(dB/m)
2. Correction Factor(dB/m) = Antenna Factor(dB/m) + Cable Factor(dB) – Pre-Amplifier Factor(dB)
3. The other emission levels were very low against the limit.
4. Margin value = Emission Level – Limit value
5. " * ": Fundamental frequency.
6. " # ": The radiated frequency is out of the restricted band.

CHANNEL	TX Channel 157	DETECTOR FUNCTION	Peak (PK)
FREQUENCY RANGE	1GHz ~ 40GHz		Average (AV)

ANTENNA POLARITY & TEST DISTANCE: HORIZONTAL AT 3 M

NO.	FREQ. (MHz)	EMISSION LEVEL (dBuV/m)	LIMIT (dBuV/m)	MARGIN (dB)	ANTENNA HEIGHT (m)	TABLE ANGLE (Degree)	RAW VALUE (dBuV)	CORRECTION FACTOR (dB/m)
1	#5618.40	57.4 PK	68.2	-10.8	1.01 H	186	54.8	2.6
2	#5705.90	58.7 PK	74.0	-15.3	1.38 H	190	55.9	2.8
3	#5705.90	47.3 AV	54.0	-6.7	1.38 H	190	44.5	2.8
4	#5725.00	62.7 PK	78.2	-15.5	1.38 H	190	59.9	2.8
5	*5785.00	108.9 PK			1.38 H	190	106.0	2.9
6	*5785.00	93.1 AV			1.38 H	190	90.2	2.9
7	#5850.00	58.3 PK	78.2	-19.9	1.38 H	190	55.3	3.0
8	#5860.00	63.6 PK	74.0	-10.4	1.38 H	190	60.6	3.0
9	#5860.00	46.9 AV	54.0	-7.1	1.38 H	190	43.9	3.0
10	#5944.25	60.4 PK	68.2	-7.8	1.01 H	186	57.3	3.1
11	11570.00	51.2 PK	74.0	-22.8	1.77 H	201	38.0	13.2
12	11570.00	37.7 AV	54.0	-16.3	1.77 H	201	24.5	13.2
13	#17355.00	51.8 PK	74.0	-22.2	1.50 H	181	32.7	19.1
14	#17355.00	41.4 AV	54.0	-12.6	1.50 H	181	22.3	19.1

ANTENNA POLARITY & TEST DISTANCE: VERTICAL AT 3 M

NO.	FREQ. (MHz)	EMISSION LEVEL (dBuV/m)	LIMIT (dBuV/m)	MARGIN (dB)	ANTENNA HEIGHT (m)	TABLE ANGLE (Degree)	RAW VALUE (dBuV)	CORRECTION FACTOR (dB/m)
1	#5623.62	65.2 PK	68.2	-3.0	1.04 V	298	62.6	2.6
2	#5705.90	62.8 PK	74.0	-11.2	1.00 V	203	60.0	2.8
3	#5705.90	51.3 AV	54.0	-2.7	1.00 V	203	48.5	2.8
4	#5725.00	66.5 PK	78.2	-11.7	1.00 V	200	63.7	2.8
5	*5785.00	114.4 PK			1.00 V	200	111.5	2.9
6	*5785.00	103.4 AV			1.00 V	200	100.5	2.9
7	#5850.00	62.9 PK	78.2	-15.3	1.00 V	200	59.9	3.0
8	#5860.00	67.3 PK	74.0	-6.7	1.00 V	205	64.3	3.0
9	#5860.00	50.5 AV	54.0	-3.5	1.00 V	205	47.5	3.0
10	#5948.05	65.8 PK	68.2	-2.4	1.04 V	298	62.6	3.2
11	11570.00	52.3 PK	74.0	-21.7	2.26 V	329	39.1	13.2
12	11570.00	39.0 AV	54.0	-15.0	2.26 V	329	25.8	13.2
13	#17355.00	57.1 PK	74.0	-16.9	2.76 V	188	38.0	19.1
14	#17355.00	43.1 AV	54.0	-10.9	2.76 V	188	24.0	19.1

REMARKS:

1. Emission Level(dBuV/m) = Raw Value(dBuV) + Correction Factor(dB/m)
2. Correction Factor(dB/m) = Antenna Factor(dB/m) + Cable Factor(dB) – Pre-Amplifier Factor(dB)
3. The other emission levels were very low against the limit.
4. Margin value = Emission Level – Limit value
5. " * ": Fundamental frequency.
6. " # ": The radiated frequency is out of the restricted band.

CHANNEL	TX Channel 165	DETECTOR FUNCTION	Peak (PK)
FREQUENCY RANGE	1GHz ~ 40GHz		Average (AV)

ANTENNA POLARITY & TEST DISTANCE: HORIZONTAL AT 3 M

NO.	FREQ. (MHz)	EMISSION LEVEL (dBuV/m)	LIMIT (dBuV/m)	MARGIN (dB)	ANTENNA HEIGHT (m)	TABLE ANGLE (Degree)	RAW VALUE (dBuV)	CORRECTION FACTOR (dB/m)
1	#5616.98	56.7 PK	68.2	-11.5	1.05 H	187	54.1	2.6
2	*5825.00	102.1 PK			1.41 H	200	99.2	2.9
3	*5825.00	91.8 AV			1.41 H	200	88.9	2.9
4	#5850.00	73.0 PK	78.2	-5.2	1.41 H	200	70.0	3.0
5	#5860.00	65.5 PK	74.0	-8.5	1.41 H	200	62.5	3.0
6	#5860.00	49.4 AV	54.0	-4.6	1.41 H	200	46.4	3.0
7	#5900.00	57.2 PK	74.0	-16.8	1.41 H	200	54.3	2.9
8	#5900.00	45.6 AV	54.0	-8.4	1.41 H	200	42.7	2.9
9	#5984.15	59.3 PK	68.2	-8.9	1.05 H	187	56.0	3.3
10	11650.00	51.1 PK	74.0	-22.9	1.71 H	194	37.9	13.2
11	11650.00	37.7 AV	54.0	-16.3	1.71 H	194	24.5	13.2
12	#17475.00	51.3 PK	74.0	-22.7	1.54 H	178	31.9	19.4
13	#17475.00	41.1 AV	54.0	-12.9	1.54 H	178	21.7	19.4

ANTENNA POLARITY & TEST DISTANCE: VERTICAL AT 3 M

NO.	FREQ. (MHz)	EMISSION LEVEL (dBuV/m)	LIMIT (dBuV/m)	MARGIN (dB)	ANTENNA HEIGHT (m)	TABLE ANGLE (Degree)	RAW VALUE (dBuV)	CORRECTION FACTOR (dB/m)
1	#5659.25	52.4 PK	75.1	-22.7	1.03 V	332	49.8	2.6
2	*5825.00	112.6 PK			1.00 V	210	109.7	2.9
3	*5825.00	102.1 AV			1.00 V	210	99.2	2.9
4	#5850.00	77.5 PK	78.2	-0.7	1.00 V	210	74.5	3.0
5	#5860.00	69.6 PK	74.0	-4.4	1.00 V	210	66.6	3.0
6	#5860.00	53.1 AV	54.0	-0.9	1.00 V	210	50.1	3.0
7	#5900.00	61.4 PK	74.0	-12.6	1.00 V	213	58.5	2.9
8	#5900.00	49.6 AV	54.0	-4.4	1.00 V	213	46.7	2.9
9	#5983.68	53.4 PK	68.2	-14.8	1.03 V	332	50.1	3.3
10	11650.00	52.1 PK	74.0	-21.9	2.21 V	318	38.9	13.2
11	11650.00	38.6 AV	54.0	-15.4	2.21 V	318	25.4	13.2
12	#17475.00	56.4 PK	74.0	-17.6	2.72 V	194	37.0	19.4
13	#17475.00	42.6 AV	54.0	-11.4	2.72 V	194	23.2	19.4

REMARKS:

1. Emission Level(dBuV/m) = Raw Value(dBuV) + Correction Factor(dB/m)
2. Correction Factor(dB/m) = Antenna Factor(dB/m) + Cable Factor(dB) – Pre-Amplifier Factor(dB)
3. The other emission levels were very low against the limit.
4. Margin value = Emission Level – Limit value
5. " * ": Fundamental frequency.
6. " # ": The radiated frequency is out of the restricted band.

802.11ac (VHT20)

CHANNEL	TX Channel 36	DETECTOR FUNCTION	Peak (PK)
FREQUENCY RANGE	1GHz ~ 40GHz		Average (AV)

ANTENNA POLARITY & TEST DISTANCE: HORIZONTAL AT 3 M

NO.	FREQ. (MHz)	EMISSION LEVEL (dBuV/m)	LIMIT (dBuV/m)	MARGIN (dB)	ANTENNA HEIGHT (m)	TABLE ANGLE (Degree)	RAW VALUE (dBuV)	CORRECTION FACTOR (dB/m)
1	5094.80	57.1 PK	74.0	-16.9	1.42 H	186	55.6	1.5
2	5094.80	46.0 AV	54.0	-8.0	1.42 H	186	44.5	1.5
3	5150.00	67.8 PK	74.0	-6.2	1.42 H	186	66.2	1.6
4	5150.00	49.8 AV	54.0	-4.2	1.42 H	186	48.2	1.6
5	*5180.00	107.3 PK			1.42 H	186	105.6	1.7
6	*5180.00	96.5 AV			1.42 H	186	94.8	1.7
7	#10360.00	50.1 PK	74.0	-23.9	1.89 H	216	38.4	11.7
8	#10360.00	36.5 AV	54.0	-17.5	1.89 H	216	24.8	11.7
9	15540.00	51.2 PK	74.0	-22.8	1.30 H	179	37.9	13.3
10	15540.00	39.3 AV	54.0	-14.7	1.30 H	179	26.0	13.3

ANTENNA POLARITY & TEST DISTANCE: VERTICAL AT 3 M

NO.	FREQ. (MHz)	EMISSION LEVEL (dBuV/m)	LIMIT (dBuV/m)	MARGIN (dB)	ANTENNA HEIGHT (m)	TABLE ANGLE (Degree)	RAW VALUE (dBuV)	CORRECTION FACTOR (dB/m)
1	5094.80	61.1 PK	74.0	-12.9	1.00 V	240	59.6	1.5
2	5094.80	48.5 AV	54.0	-5.5	1.00 V	240	47.0	1.5
3	5150.00	72.9 PK	74.0	-1.1	1.01 V	280	71.3	1.6
4	5150.00	53.2 AV	54.0	-0.8	1.01 V	280	51.6	1.6
5	*5180.00	114.6 PK			1.01 V	280	112.9	1.7
6	*5180.00	102.2 AV			1.01 V	280	100.5	1.7
7	#10360.00	50.3 PK	74.0	-23.7	2.15 V	318	38.6	11.7
8	#10360.00	37.6 AV	54.0	-16.4	2.15 V	318	25.9	11.7
9	15540.00	56.6 PK	74.0	-17.4	2.74 V	186	43.3	13.3
10	15540.00	42.5 AV	54.0	-11.5	2.74 V	186	29.2	13.3

REMARKS:

- Emission Level(dBuV/m) = Raw Value(dBuV) + Correction Factor(dB/m)
- Correction Factor(dB/m) = Antenna Factor(dB/m) + Cable Factor(dB) – Pre-Amplifier Factor(dB)
- The other emission levels were very low against the limit.
- Margin value = Emission Level – Limit value
- " * ": Fundamental frequency.
- " # ": The radiated frequency is out of the restricted band.

CHANNEL	TX Channel 40	DETECTOR FUNCTION	Peak (PK)
FREQUENCY RANGE	1GHz ~ 40GHz		Average (AV)

ANTENNA POLARITY & TEST DISTANCE: HORIZONTAL AT 3 M

NO.	FREQ. (MHz)	EMISSION LEVEL (dBuV/m)	LIMIT (dBuV/m)	MARGIN (dB)	ANTENNA HEIGHT (m)	TABLE ANGLE (Degree)	RAW VALUE (dBuV)	CORRECTION FACTOR (dB/m)
1	5119.00	57.2 PK	74.0	-16.8	1.57 H	182	55.7	1.5
2	5119.00	45.2 AV	54.0	-8.8	1.57 H	182	43.7	1.5
3	5150.00	55.8 PK	74.0	-18.2	1.57 H	182	54.2	1.6
4	5150.00	40.9 AV	54.0	-13.1	1.57 H	182	39.3	1.6
5	*5200.00	106.8 PK			1.57 H	182	105.0	1.8
6	*5200.00	96.7 AV			1.57 H	182	94.9	1.8
7	#10400.00	49.7 PK	74.0	-24.3	1.91 H	202	37.8	11.9
8	#10400.00	36.2 AV	54.0	-17.8	1.91 H	202	24.3	11.9
9	15600.00	51.1 PK	74.0	-22.9	1.33 H	177	37.8	13.3
10	15600.00	38.9 AV	54.0	-15.1	1.33 H	177	25.6	13.3

ANTENNA POLARITY & TEST DISTANCE: VERTICAL AT 3 M

NO.	FREQ. (MHz)	EMISSION LEVEL (dBuV/m)	LIMIT (dBuV/m)	MARGIN (dB)	ANTENNA HEIGHT (m)	TABLE ANGLE (Degree)	RAW VALUE (dBuV)	CORRECTION FACTOR (dB/m)
1	5119.00	64.5 PK	74.0	-9.5	1.02 V	241	63.0	1.5
2	5119.00	48.7 AV	54.0	-5.3	1.02 V	241	47.2	1.5
3	5150.00	64.0 PK	74.0	-10.0	1.02 V	241	62.4	1.6
4	5150.00	46.2 AV	54.0	-7.8	1.02 V	241	44.6	1.6
5	*5200.00	115.8 PK			1.02 V	241	114.0	1.8
6	*5200.00	103.2 AV			1.02 V	241	101.4	1.8
7	#10400.00	50.2 PK	74.0	-23.8	2.16 V	333	38.3	11.9
8	#10400.00	37.5 AV	54.0	-16.5	2.16 V	333	25.6	11.9
9	15600.00	56.2 PK	74.0	-17.8	2.76 V	180	42.9	13.3
10	15600.00	42.2 AV	54.0	-11.8	2.76 V	180	28.9	13.3

REMARKS:

1. Emission Level(dBuV/m) = Raw Value(dBuV) + Correction Factor(dB/m)
2. Correction Factor(dB/m) = Antenna Factor(dB/m) + Cable Factor(dB) – Pre-Amplifier Factor(dB)
3. The other emission levels were very low against the limit.
4. Margin value = Emission Level – Limit value
5. " * ": Fundamental frequency.
6. " # ": The radiated frequency is out of the restricted band.

CHANNEL	TX Channel 48	DETECTOR FUNCTION	Peak (PK)
FREQUENCY RANGE	1GHz ~ 40GHz		Average (AV)

ANTENNA POLARITY & TEST DISTANCE: HORIZONTAL AT 3 M

NO.	FREQ. (MHz)	EMISSION LEVEL (dBuV/m)	LIMIT (dBuV/m)	MARGIN (dB)	ANTENNA HEIGHT (m)	TABLE ANGLE (Degree)	RAW VALUE (dBuV)	CORRECTION FACTOR (dB/m)
1	*5240.00	106.2 PK			1.38 H	181	104.4	1.8
2	*5240.00	95.4 AV			1.38 H	181	93.6	1.8
3	5350.00	50.1 PK	74.0	-23.9	1.38 H	181	48.0	2.1
4	5350.00	40.2 AV	54.0	-13.8	1.38 H	181	38.1	2.1
5	5398.00	57.1 PK	74.0	-16.9	1.38 H	181	54.9	2.2
6	5398.00	46.8 AV	54.0	-7.2	1.38 H	181	44.6	2.2
7	#10480.00	49.7 PK	74.0	-24.3	1.91 H	190	37.5	12.2
8	#10480.00	36.3 AV	54.0	-17.7	1.91 H	190	24.1	12.2
9	15720.00	50.5 PK	74.0	-23.5	1.35 H	193	37.3	13.2
10	15720.00	38.4 AV	54.0	-15.6	1.35 H	193	25.2	13.2

ANTENNA POLARITY & TEST DISTANCE: VERTICAL AT 3 M

NO.	FREQ. (MHz)	EMISSION LEVEL (dBuV/m)	LIMIT (dBuV/m)	MARGIN (dB)	ANTENNA HEIGHT (m)	TABLE ANGLE (Degree)	RAW VALUE (dBuV)	CORRECTION FACTOR (dB/m)
1	*5240.00	114.6 PK			1.08 V	281	112.8	1.8
2	*5240.00	102.2 AV			1.08 V	281	100.4	1.8
3	5350.00	62.0 PK	74.0	-12.0	1.08 V	281	59.9	2.1
4	5350.00	43.0 AV	54.0	-11.0	1.08 V	281	40.9	2.1
5	5398.00	63.3 PK	74.0	-10.7	1.21 V	289	61.1	2.2
6	5398.00	50.8 AV	54.0	-3.2	1.21 V	289	48.6	2.2
7	#10480.00	50.1 PK	74.0	-23.9	2.17 V	326	37.9	12.2
8	#10480.00	37.4 AV	54.0	-16.6	2.17 V	326	25.2	12.2
9	15720.00	55.4 PK	74.0	-18.6	2.73 V	180	42.2	13.2
10	15720.00	41.7 AV	54.0	-12.3	2.73 V	180	28.5	13.2

REMARKS:

1. Emission Level(dBuV/m) = Raw Value(dBuV) + Correction Factor(dB/m)
2. Correction Factor(dB/m) = Antenna Factor(dB/m) + Cable Factor(dB) – Pre-Amplifier Factor(dB)
3. The other emission levels were very low against the limit.
4. Margin value = Emission Level – Limit value
5. " * ": Fundamental frequency.
6. " # ": The radiated frequency is out of the restricted band.

CHANNEL	TX Channel 149	DETECTOR FUNCTION	Peak (PK)
FREQUENCY RANGE	1GHz ~ 40GHz		Average (AV)

ANTENNA POLARITY & TEST DISTANCE: HORIZONTAL AT 3 M

NO.	FREQ. (MHz)	EMISSION LEVEL (dBuV/m)	LIMIT (dBuV/m)	MARGIN (dB)	ANTENNA HEIGHT (m)	TABLE ANGLE (Degree)	RAW VALUE (dBuV)	CORRECTION FACTOR (dB/m)
1	#5579.93	58.2 PK	68.2	-10.0	1.41 H	318	55.7	2.5
2	#5715.00	64.0 PK	74.0	-10.0	1.42 H	197	61.2	2.8
3	#5715.00	40.3 AV	54.0	-13.7	1.42 H	197	37.5	2.8
4	#5725.00	73.7 PK	78.2	-4.5	1.42 H	197	70.9	2.8
5	*5745.00	98.8 PK			1.42 H	197	96.0	2.8
6	*5745.00	87.8 AV			1.42 H	197	85.0	2.8
7	#5952.32	56.7 PK	68.2	-11.5	1.41 H	318	53.5	3.2
8	11490.00	51.4 PK	74.0	-22.6	1.76 H	188	37.9	13.5
9	11490.00	37.7 AV	54.0	-16.3	1.76 H	188	24.2	13.5
10	#17235.00	52.0 PK	74.0	-22.0	1.54 H	171	33.6	18.4
11	#17235.00	41.3 AV	54.0	-12.7	1.54 H	171	22.9	18.4

ANTENNA POLARITY & TEST DISTANCE: VERTICAL AT 3 M

NO.	FREQ. (MHz)	EMISSION LEVEL (dBuV/m)	LIMIT (dBuV/m)	MARGIN (dB)	ANTENNA HEIGHT (m)	TABLE ANGLE (Degree)	RAW VALUE (dBuV)	CORRECTION FACTOR (dB/m)
1	#5587.05	63.9 PK	68.2	-4.3	1.07 V	294	61.4	2.5
2	#5715.00	68.0 PK	74.0	-6.0	1.00 V	204	65.2	2.8
3	#5715.00	44.3 AV	54.0	-9.7	1.00 V	204	41.5	2.8
4	#5725.00	78.1 PK	78.2	-0.1	1.00 V	204	75.3	2.8
5	*5745.00	109.2 PK			1.00 V	204	106.4	2.8
6	*5745.00	98.1 AV			1.00 V	204	95.3	2.8
7	#5911.00	63.1 PK	78.5	-15.4	1.07 V	294	60.0	3.1
8	11490.00	52.0 PK	74.0	-22.0	2.28 V	313	38.5	13.5
9	11490.00	38.7 AV	54.0	-15.3	2.28 V	313	25.2	13.5
10	#17235.00	57.5 PK	74.0	-16.5	2.81 V	191	39.1	18.4
11	#17235.00	43.2 AV	54.0	-10.8	2.81 V	191	24.8	18.4

REMARKS:

1. Emission Level(dBuV/m) = Raw Value(dBuV) + Correction Factor(dB/m)
2. Correction Factor(dB/m) = Antenna Factor(dB/m) + Cable Factor(dB) – Pre-Amplifier Factor(dB)
3. The other emission levels were very low against the limit.
4. Margin value = Emission Level – Limit value
5. " * ": Fundamental frequency.
6. " # ": The radiated frequency is out of the restricted band.

CHANNEL	TX Channel 157	DETECTOR FUNCTION	Peak (PK)
FREQUENCY RANGE	1GHz ~ 40GHz		Average (AV)

ANTENNA POLARITY & TEST DISTANCE: HORIZONTAL AT 3 M

NO.	FREQ. (MHz)	EMISSION LEVEL (dBuV/m)	LIMIT (dBuV/m)	MARGIN (dB)	ANTENNA HEIGHT (m)	TABLE ANGLE (Degree)	RAW VALUE (dBuV)	CORRECTION FACTOR (dB/m)
1	#5577.07	56.8 PK	68.2	-11.4	1.08 H	187	54.3	2.5
2	#5708.00	58.4 PK	74.0	-15.6	1.34 H	185	55.6	2.8
3	#5708.00	46.7 AV	54.0	-7.3	1.34 H	185	43.9	2.8
4	#5725.00	62.5 PK	78.2	-15.7	1.34 H	185	59.7	2.8
5	*5785.00	104.8 PK			1.34 H	185	101.9	2.9
6	*5785.00	93.5 AV			1.34 H	185	90.6	2.9
7	#5850.00	62.8 PK	78.2	-15.4	1.34 H	185	59.8	3.0
8	#5860.00	63.7 PK	74.0	-10.3	1.34 H	185	60.7	3.0
9	#5860.00	46.5 AV	54.0	-7.5	1.34 H	185	43.5	3.0
10	#5951.85	58.8 PK	68.2	-9.4	1.08 H	187	55.6	3.2
11	11570.00	51.8 PK	74.0	-22.2	1.78 H	205	38.6	13.2
12	11570.00	38.1 AV	54.0	-15.9	1.78 H	205	24.9	13.2
13	#17355.00	51.9 PK	74.0	-22.1	1.53 H	184	32.8	19.1
14	#17355.00	41.7 AV	54.0	-12.3	1.53 H	184	22.6	19.1

ANTENNA POLARITY & TEST DISTANCE: VERTICAL AT 3 M

NO.	FREQ. (MHz)	EMISSION LEVEL (dBuV/m)	LIMIT (dBuV/m)	MARGIN (dB)	ANTENNA HEIGHT (m)	TABLE ANGLE (Degree)	RAW VALUE (dBuV)	CORRECTION FACTOR (dB/m)
1	#5621.73	64.5 PK	68.2	-3.7	1.12 V	298	61.9	2.6
2	#5708.00	62.7 PK	74.0	-11.3	1.01 V	203	59.9	2.8
3	#5708.00	51.0 AV	54.0	-3.0	1.01 V	203	48.2	2.8
4	#5725.00	66.5 PK	78.2	-11.7	1.00 V	200	63.7	2.8
5	*5785.00	114.4 PK			1.00 V	200	111.5	2.9
6	*5785.00	103.3 AV			1.00 V	200	100.4	2.9
7	#5850.00	66.5 PK	78.2	-11.7	1.00 V	200	63.5	3.0
8	#5860.00	67.7 PK	74.0	-6.3	1.04 V	209	64.7	3.0
9	#5860.00	50.8 AV	54.0	-3.2	1.04 V	209	47.8	3.0
10	#5946.15	64.2 PK	68.2	-4.0	1.12 V	298	61.1	3.1
11	11570.00	52.2 PK	74.0	-21.8	2.29 V	321	39.0	13.2
12	11570.00	38.7 AV	54.0	-15.3	2.29 V	321	25.5	13.2
13	#17355.00	56.9 PK	74.0	-17.1	2.78 V	184	37.8	19.1
14	#17355.00	43.0 AV	54.0	-11.0	2.78 V	184	23.9	19.1

REMARKS:

1. Emission Level(dBuV/m) = Raw Value(dBuV) + Correction Factor(dB/m)
2. Correction Factor(dB/m) = Antenna Factor(dB/m) + Cable Factor(dB) – Pre-Amplifier Factor(dB)
3. The other emission levels were very low against the limit.
4. Margin value = Emission Level – Limit value
5. " * ": Fundamental frequency.
6. " # ": The radiated frequency is out of the restricted band.

CHANNEL	TX Channel 165	DETECTOR FUNCTION	Peak (PK)
FREQUENCY RANGE	1GHz ~ 40GHz		Average (AV)

ANTENNA POLARITY & TEST DISTANCE: HORIZONTAL AT 3 M

NO.	FREQ. (MHz)	EMISSION LEVEL (dBuV/m)	LIMIT (dBuV/m)	MARGIN (dB)	ANTENNA HEIGHT (m)	TABLE ANGLE (Degree)	RAW VALUE (dBuV)	CORRECTION FACTOR (dB/m)
1	#5592.27	56.7 PK	68.2	-11.5	1.07 H	201	54.2	2.5
2	*5825.00	103.1 PK			1.33 H	185	100.2	2.9
3	*5825.00	91.2 AV			1.33 H	185	88.3	2.9
4	#5850.00	73.5 PK	78.2	-4.7	1.33 H	185	70.5	3.0
5	#5860.00	64.3 PK	74.0	-9.7	1.33 H	185	61.3	3.0
6	#5860.00	46.6 AV	54.0	-7.4	1.33 H	185	43.6	3.0
7	#5987.95	58.6 PK	68.2	-9.6	1.07 H	201	55.3	3.3
8	11650.00	51.6 PK	74.0	-22.4	1.73 H	185	38.4	13.2
9	11650.00	38.1 AV	54.0	-15.9	1.73 H	185	24.9	13.2
10	#17475.00	51.9 PK	74.0	-22.1	1.52 H	177	32.5	19.4
11	#17475.00	41.4 AV	54.0	-12.6	1.52 H	177	22.0	19.4

ANTENNA POLARITY & TEST DISTANCE: VERTICAL AT 3 M

NO.	FREQ. (MHz)	EMISSION LEVEL (dBuV/m)	LIMIT (dBuV/m)	MARGIN (dB)	ANTENNA HEIGHT (m)	TABLE ANGLE (Degree)	RAW VALUE (dBuV)	CORRECTION FACTOR (dB/m)
1	#5592.27	59.4 PK	68.2	-8.8	1.02 V	314	56.9	2.5
2	*5825.00	112.7 PK			1.00 V	206	109.8	2.9
3	*5825.00	100.8 AV			1.00 V	206	97.9	2.9
4	#5850.00	77.9 PK	78.2	-0.3	1.00 V	206	74.9	3.0
5	#5860.00	67.9 PK	74.0	-6.1	1.00 V	206	64.9	3.0
6	#5860.00	50.3 AV	54.0	-3.7	1.00 V	206	47.3	3.0
7	#5990.32	63.5 PK	68.2	-4.7	1.02 V	314	60.1	3.4
8	11650.00	52.0 PK	74.0	-22.0	2.28 V	343	38.8	13.2
9	11650.00	38.7 AV	54.0	-15.3	2.28 V	343	25.5	13.2
10	#17475.00	57.0 PK	74.0	-17.0	2.81 V	175	37.6	19.4
11	#17475.00	42.9 AV	54.0	-11.1	2.81 V	175	23.5	19.4

REMARKS:

- Emission Level(dBuV/m) = Raw Value(dBuV) + Correction Factor(dB/m)
- Correction Factor(dB/m) = Antenna Factor(dB/m) + Cable Factor(dB) – Pre-Amplifier Factor(dB)
- The other emission levels were very low against the limit.
- Margin value = Emission Level – Limit value
- " * ": Fundamental frequency.
- " # ": The radiated frequency is out of the restricted band.

802.11ac (VHT40)

CHANNEL	TX Channel 38	DETECTOR FUNCTION	Peak (PK)
FREQUENCY RANGE	1GHz ~ 40GHz		Average (AV)

ANTENNA POLARITY & TEST DISTANCE: HORIZONTAL AT 3 M

NO.	FREQ. (MHz)	EMISSION LEVEL (dBuV/m)	LIMIT (dBuV/m)	MARGIN (dB)	ANTENNA HEIGHT (m)	TABLE ANGLE (Degree)	RAW VALUE (dBuV)	CORRECTION FACTOR (dB/m)
1	5150.00	57.2 PK	74.0	-16.8	1.44 H	179	55.6	1.6
2	5150.00	43.7 AV	54.0	-10.3	1.44 H	179	42.1	1.6
3	*5190.00	98.3 PK			1.44 H	179	96.5	1.8
4	*5190.00	88.6 AV			1.44 H	179	86.8	1.8
5	5352.00	54.1 PK	74.0	-19.9	1.44 H	179	52.0	2.1
6	5352.00	42.5 AV	54.0	-11.5	1.44 H	179	40.4	2.1
7	#10380.00	49.2 PK	74.0	-24.8	1.91 H	218	37.4	11.8
8	#10380.00	35.3 AV	54.0	-18.7	1.91 H	218	23.5	11.8
9	15570.00	50.9 PK	74.0	-23.1	1.30 H	198	37.6	13.3
10	15570.00	39.1 AV	54.0	-14.9	1.30 H	198	25.8	13.3

ANTENNA POLARITY & TEST DISTANCE: VERTICAL AT 3 M

NO.	FREQ. (MHz)	EMISSION LEVEL (dBuV/m)	LIMIT (dBuV/m)	MARGIN (dB)	ANTENNA HEIGHT (m)	TABLE ANGLE (Degree)	RAW VALUE (dBuV)	CORRECTION FACTOR (dB/m)
1	5150.00	73.8 PK	74.0	-0.2	1.00 V	239	72.2	1.6
2	5150.00	53.6 AV	54.0	-0.4	1.00 V	239	52.0	1.6
3	*5190.00	108.5 PK			1.00 V	239	106.7	1.8
4	*5190.00	96.0 AV			1.00 V	239	94.2	1.8
5	5352.00	58.3 PK	74.0	-15.7	1.03 V	288	56.2	2.1
6	5352.00	46.4 AV	54.0	-7.6	1.03 V	288	44.3	2.1
7	#10380.00	49.6 PK	74.0	-24.4	2.18 V	320	37.8	11.8
8	#10380.00	36.4 AV	54.0	-17.6	2.18 V	320	24.6	11.8
9	15570.00	54.7 PK	74.0	-19.3	2.79 V	187	41.4	13.3
10	15570.00	41.2 AV	54.0	-12.8	2.79 V	187	27.9	13.3

REMARKS:

1. Emission Level(dBuV/m) = Raw Value(dBuV) + Correction Factor(dB/m)
2. Correction Factor(dB/m) = Antenna Factor(dB/m) + Cable Factor(dB) – Pre-Amplifier Factor(dB)
3. The other emission levels were very low against the limit.
4. Margin value = Emission Level – Limit value
5. " * ": Fundamental frequency.
6. " # ": The radiated frequency is out of the restricted band.

CHANNEL	TX Channel 46	DETECTOR FUNCTION	Peak (PK)
FREQUENCY RANGE	1GHz ~ 40GHz		Average (AV)

ANTENNA POLARITY & TEST DISTANCE: HORIZONTAL AT 3 M

NO.	FREQ. (MHz)	EMISSION LEVEL (dBuV/m)	LIMIT (dBuV/m)	MARGIN (dB)	ANTENNA HEIGHT (m)	TABLE ANGLE (Degree)	RAW VALUE (dBuV)	CORRECTION FACTOR (dB/m)
1	*5230.00	103.4 PK			1.41 H	183	101.6	1.8
2	*5230.00	92.6 AV			1.41 H	183	90.8	1.8
3	5350.00	50.1 PK	74.0	-23.9	1.41 H	183	48.0	2.1
4	5350.00	40.1 AV	54.0	-13.9	1.41 H	183	38.0	2.1
5	5384.00	55.6 PK	74.0	-18.4	1.41 H	183	53.4	2.2
6	5384.00	44.5 AV	54.0	-9.5	1.41 H	183	42.3	2.2
7	#10460.00	49.4 PK	74.0	-24.6	1.95 H	204	37.3	12.1
8	#10460.00	35.6 AV	54.0	-18.4	1.95 H	204	23.5	12.1
9	15690.00	51.3 PK	74.0	-22.7	1.24 H	209	38.1	13.2
10	15690.00	39.4 AV	54.0	-14.6	1.24 H	209	26.2	13.2

ANTENNA POLARITY & TEST DISTANCE: VERTICAL AT 3 M

NO.	FREQ. (MHz)	EMISSION LEVEL (dBuV/m)	LIMIT (dBuV/m)	MARGIN (dB)	ANTENNA HEIGHT (m)	TABLE ANGLE (Degree)	RAW VALUE (dBuV)	CORRECTION FACTOR (dB/m)
1	*5230.00	112.0 PK			1.00 V	242	110.2	1.8
2	*5230.00	99.6 AV			1.00 V	242	97.8	1.8
3	5350.00	57.1 PK	74.0	-16.9	1.00 V	242	55.0	2.1
4	5350.00	43.3 AV	54.0	-10.7	1.00 V	242	41.2	2.1
5	5384.00	60.7 PK	74.0	-13.3	1.00 V	292	58.5	2.2
6	5384.00	40.7 AV	54.0	-13.3	1.00 V	292	38.5	2.2
7	#10460.00	49.8 PK	74.0	-24.2	2.13 V	323	37.7	12.1
8	#10460.00	36.4 AV	54.0	-17.6	2.13 V	323	24.3	12.1
9	15690.00	54.9 PK	74.0	-19.1	2.75 V	180	41.7	13.2
10	15690.00	41.4 AV	54.0	-12.6	2.75 V	180	28.2	13.2

REMARKS:

- Emission Level(dBuV/m) = Raw Value(dBuV) + Correction Factor(dB/m)
- Correction Factor(dB/m) = Antenna Factor(dB/m) + Cable Factor(dB) – Pre-Amplifier Factor(dB)
- The other emission levels were very low against the limit.
- Margin value = Emission Level – Limit value
- " * ": Fundamental frequency.
- " # ": The radiated frequency is out of the restricted band.

CHANNEL	TX Channel 151	DETECTOR FUNCTION	Peak (PK)
FREQUENCY RANGE	1GHz ~ 40GHz		Average (AV)

ANTENNA POLARITY & TEST DISTANCE: HORIZONTAL AT 3 M

NO.	FREQ. (MHz)	EMISSION LEVEL (dBuV/m)	LIMIT (dBuV/m)	MARGIN (dB)	ANTENNA HEIGHT (m)	TABLE ANGLE (Degree)	RAW VALUE (dBuV)	CORRECTION FACTOR (dB/m)
1	#5589.90	58.4 PK	68.2	-9.8	1.15 H	318	55.9	2.5
2	#5715.00	69.0 PK	74.0	-5.0	1.35 H	191	66.2	2.8
3	#5715.00	48.3 AV	54.0	-5.7	1.35 H	191	45.5	2.8
4	#5725.00	74.2 PK	78.2	-4.0	1.35 H	191	71.4	2.8
5	*5755.00	96.7 PK			1.35 H	191	93.8	2.9
6	*5755.00	84.9 AV			1.35 H	191	82.0	2.9
7	#5964.68	58.0 PK	68.2	-10.2	1.15 H	318	54.8	3.2
8	11510.00	51.2 PK	74.0	-22.8	1.76 H	210	37.7	13.5
9	11510.00	37.6 AV	54.0	-16.4	1.76 H	210	24.1	13.5
10	#17265.00	51.0 PK	74.0	-23.0	1.52 H	169	32.5	18.5
11	#17265.00	40.9 AV	54.0	-13.1	1.52 H	169	22.4	18.5

ANTENNA POLARITY & TEST DISTANCE: VERTICAL AT 3 M

NO.	FREQ. (MHz)	EMISSION LEVEL (dBuV/m)	LIMIT (dBuV/m)	MARGIN (dB)	ANTENNA HEIGHT (m)	TABLE ANGLE (Degree)	RAW VALUE (dBuV)	CORRECTION FACTOR (dB/m)
1	#5659.73	69.2 PK	75.4	-6.2	1.12 V	314	66.6	2.6
2	#5715.00	73.3 PK	74.0	-0.7	1.01 V	205	70.5	2.8
3	#5715.00	52.8 AV	54.0	-1.2	1.01 V	205	50.0	2.8
4	#5725.00	77.8 PK	78.2	-0.4	1.01 V	205	75.0	2.8
5	*5755.00	107.1 PK			1.01 V	205	104.2	2.9
6	*5755.00	95.1 AV			1.01 V	205	92.2	2.9
7	#5930.48	61.7 PK	68.2	-6.5	1.12 V	314	58.6	3.1
8	11510.00	52.0 PK	74.0	-22.0	2.31 V	333	38.5	13.5
9	11510.00	38.9 AV	54.0	-15.1	2.31 V	333	25.4	13.5
10	#17265.00	57.5 PK	74.0	-16.5	2.82 V	174	39.0	18.5
11	#17265.00	43.4 AV	54.0	-10.6	2.82 V	174	24.9	18.5

REMARKS:

1. Emission Level(dBuV/m) = Raw Value(dBuV) + Correction Factor(dB/m)
2. Correction Factor(dB/m) = Antenna Factor(dB/m) + Cable Factor(dB) – Pre-Amplifier Factor(dB)
3. The other emission levels were very low against the limit.
4. Margin value = Emission Level – Limit value
5. " * ": Fundamental frequency.
6. " # ": The radiated frequency is out of the restricted band.

CHANNEL	TX Channel 159	DETECTOR FUNCTION	Peak (PK)
FREQUENCY RANGE	1GHz ~ 40GHz		Average (AV)

ANTENNA POLARITY & TEST DISTANCE: HORIZONTAL AT 3 M

NO.	FREQ. (MHz)	EMISSION LEVEL (dBuV/m)	LIMIT (dBuV/m)	MARGIN (dB)	ANTENNA HEIGHT (m)	TABLE ANGLE (Degree)	RAW VALUE (dBuV)	CORRECTION FACTOR (dB/m)
1	#5649.75	58.8 PK	68.2	-9.4	1.01 H	318	56.2	2.6
2	*5795.00	100.2 PK			1.37 H	176	97.3	2.9
3	*5795.00	88.6 AV			1.37 H	176	85.7	2.9
4	#5850.00	73.8 PK	78.2	-4.4	1.37 H	176	70.8	3.0
5	#5860.00	65.1 PK	74.0	-8.9	1.37 H	176	62.1	3.0
6	#5860.00	48.9 AV	54.0	-5.1	1.37 H	176	45.9	3.0
7	#5959.45	58.1 PK	68.2	-10.1	1.01 H	318	54.9	3.2
8	11590.00	51.3 PK	74.0	-22.7	1.71 H	209	38.2	13.1
9	11590.00	37.8 AV	54.0	-16.2	1.71 H	209	24.7	13.1
10	#17385.00	51.6 PK	74.0	-22.4	1.48 H	179	32.3	19.3
11	#17385.00	41.0 AV	54.0	-13.0	1.48 H	179	21.7	19.3

ANTENNA POLARITY & TEST DISTANCE: VERTICAL AT 3 M

NO.	FREQ. (MHz)	EMISSION LEVEL (dBuV/m)	LIMIT (dBuV/m)	MARGIN (dB)	ANTENNA HEIGHT (m)	TABLE ANGLE (Degree)	RAW VALUE (dBuV)	CORRECTION FACTOR (dB/m)
1	#5637.87	61.2 PK	68.2	-7.0	1.08 V	314	58.6	2.6
2	*5795.00	110.9 PK			1.05 V	204	108.0	2.9
3	*5795.00	99.0 AV			1.05 V	204	96.1	2.9
4	#5850.00	77.4 PK	78.2	-0.8	1.05 V	204	74.4	3.0
5	#5860.00	69.3 PK	74.0	-4.7	1.05 V	204	66.3	3.0
6	#5860.00	53.3 AV	54.0	-0.7	1.05 V	204	50.3	3.0
7	#5937.60	62.6 PK	68.2	-5.6	1.08 V	314	59.5	3.1
8	11590.00	52.4 PK	74.0	-21.6	2.29 V	316	39.3	13.1
9	11590.00	39.1 AV	54.0	-14.9	2.29 V	316	26.0	13.1
10	#17385.00	57.0 PK	74.0	-17.0	2.81 V	172	37.7	19.3
11	#17385.00	43.0 AV	54.0	-11.0	2.81 V	172	23.7	19.3

REMARKS:

1. Emission Level(dBuV/m) = Raw Value(dBuV) + Correction Factor(dB/m)
2. Correction Factor(dB/m) = Antenna Factor(dB/m) + Cable Factor(dB) – Pre-Amplifier Factor(dB)
3. The other emission levels were very low against the limit.
4. Margin value = Emission Level – Limit value
5. " * ": Fundamental frequency.
6. " # ": The radiated frequency is out of the restricted band.

802.11ac (VHT80)

CHANNEL	TX Channel 42	DETECTOR FUNCTION	Peak (PK)
FREQUENCY RANGE	1GHz ~ 40GHz		Average (AV)

ANTENNA POLARITY & TEST DISTANCE: HORIZONTAL AT 3 M

NO.	FREQ. (MHz)	EMISSION LEVEL (dBuV/m)	LIMIT (dBuV/m)	MARGIN (dB)	ANTENNA HEIGHT (m)	TABLE ANGLE (Degree)	RAW VALUE (dBuV)	CORRECTION FACTOR (dB/m)
1	5150.00	60.2 PK	74.0	-13.8	1.61 H	182	58.6	1.6
2	5150.00	44.5 AV	54.0	-9.5	1.61 H	182	42.9	1.6
3	*5210.00	97.8 PK			1.61 H	182	96.0	1.8
4	*5210.00	85.7 AV			1.61 H	182	83.9	1.8
5	5350.00	53.2 PK	74.0	-20.8	1.61 H	182	51.1	2.1
6	5350.00	41.2 AV	54.0	-12.8	1.61 H	182	39.1	2.1
7	#10420.00	50.4 PK	74.0	-23.6	1.87 H	199	38.4	12.0
8	#10420.00	39.2 AV	54.0	-14.8	1.87 H	199	27.2	12.0
9	15630.00	51.4 PK	74.0	-22.6	1.40 H	204	38.1	13.3
10	15630.00	40.0 AV	54.0	-14.0	1.40 H	204	26.7	13.3

ANTENNA POLARITY & TEST DISTANCE: VERTICAL AT 3 M

NO.	FREQ. (MHz)	EMISSION LEVEL (dBuV/m)	LIMIT (dBuV/m)	MARGIN (dB)	ANTENNA HEIGHT (m)	TABLE ANGLE (Degree)	RAW VALUE (dBuV)	CORRECTION FACTOR (dB/m)
1	5150.00	68.1 PK	74.0	-5.9	1.00 V	280	66.5	1.6
2	5150.00	53.8 AV	54.0	-0.2	1.00 V	280	52.2	1.6
3	*5210.00	104.7 PK			1.00 V	280	102.9	1.8
4	*5210.00	91.8 AV			1.00 V	280	90.0	1.8
5	5350.00	56.7 PK	74.0	-17.3	1.00 V	280	54.6	2.1
6	5350.00	43.1 AV	54.0	-10.9	1.00 V	280	41.0	2.1
7	#10420.00	49.8 PK	74.0	-24.2	2.07 V	328	37.8	12.0
8	#10420.00	41.2 AV	54.0	-12.8	2.07 V	328	29.2	12.0
9	15630.00	51.9 PK	74.0	-22.1	2.58 V	173	38.6	13.3
10	15630.00	38.7 AV	54.0	-15.3	2.58 V	173	25.4	13.3

REMARKS:

- Emission Level(dBuV/m) = Raw Value(dBuV) + Correction Factor(dB/m)
- Correction Factor(dB/m) = Antenna Factor(dB/m) + Cable Factor(dB) – Pre-Amplifier Factor(dB)
- The other emission levels were very low against the limit.
- Margin value = Emission Level – Limit value
- " * ": Fundamental frequency.
- " # ": The radiated frequency is out of the restricted band.

CHANNEL	TX Channel 155	DETECTOR FUNCTION	Peak (PK)
FREQUENCY RANGE	1GHz ~ 40GHz		Average (AV)

ANTENNA POLARITY & TEST DISTANCE: HORIZONTAL AT 3 M

NO.	FREQ. (MHz)	EMISSION LEVEL (dBuV/m)	LIMIT (dBuV/m)	MARGIN (dB)	ANTENNA HEIGHT (m)	TABLE ANGLE (Degree)	RAW VALUE (dBuV)	CORRECTION FACTOR (dB/m)
1	#5627.90	58.4 PK	68.2	-9.8	1.20 H	187	55.8	2.6
2	#5715.00	68.3 PK	74.0	-5.7	1.42 H	187	65.5	2.8
3	#5715.00	49.3 AV	54.0	-4.7	1.42 H	187	46.5	2.8
4	#5725.00	70.2 PK	78.2	-8.0	1.42 H	187	67.4	2.8
5	*5775.00	93.3 PK			1.42 H	187	90.4	2.9
6	*5775.00	80.4 AV			1.42 H	187	77.5	2.9
7	#5850.00	65.1 PK	78.2	-13.1	1.42 H	187	62.1	3.0
8	#5860.00	62.5 PK	74.0	-11.5	1.42 H	187	59.5	3.0
9	#5860.00	44.3 AV	54.0	-9.7	1.42 H	187	41.3	3.0
10	#5924.77	58.7 PK	68.4	-9.7	1.20 H	187	55.6	3.1
11	11550.00	50.9 PK	74.0	-23.1	1.72 H	213	37.6	13.3
12	11550.00	37.3 AV	54.0	-16.7	1.72 H	213	24.0	13.3
13	#17325.00	52.4 PK	74.0	-21.6	1.45 H	183	33.5	18.9
14	#17325.00	41.8 AV	54.0	-12.2	1.45 H	183	22.9	18.9

ANTENNA POLARITY & TEST DISTANCE: VERTICAL AT 3 M

NO.	FREQ. (MHz)	EMISSION LEVEL (dBuV/m)	LIMIT (dBuV/m)	MARGIN (dB)	ANTENNA HEIGHT (m)	TABLE ANGLE (Degree)	RAW VALUE (dBuV)	CORRECTION FACTOR (dB/m)
1	#5643.10	67.0 PK	68.2	-1.2	1.10 V	314	64.4	2.6
2	#5715.00	72.6 PK	74.0	-1.4	1.03 V	203	69.8	2.8
3	#5715.00	53.6 AV	54.0	-0.4	1.03 V	203	50.8	2.8
4	#5725.00	74.4 PK	78.2	-3.8	1.03 V	203	71.6	2.8
5	*5775.00	103.6 PK			1.03 V	203	100.7	2.9
6	*5775.00	90.9 AV			1.03 V	203	88.0	2.9
7	#5850.00	69.4 PK	78.2	-8.8	1.03 V	203	66.4	3.0
8	#5860.00	66.1 PK	74.0	-7.9	1.03 V	203	63.1	3.0
9	#5860.00	47.8 AV	54.0	-6.2	1.03 V	203	44.8	3.0
10	#5920.50	68.2 PK	71.5	-3.3	1.10 V	314	65.1	3.1
11	11550.00	52.9 PK	74.0	-21.1	2.29 V	331	39.6	13.3
12	11550.00	39.4 AV	54.0	-14.6	2.29 V	331	26.1	13.3
13	#17325.00	56.8 PK	74.0	-17.2	2.80 V	187	37.9	18.9
14	#17325.00	43.0 AV	54.0	-11.0	2.80 V	187	24.1	18.9

REMARKS:

1. Emission Level(dBuV/m) = Raw Value(dBuV) + Correction Factor(dB/m)
2. Correction Factor(dB/m) = Antenna Factor(dB/m) + Cable Factor(dB) – Pre-Amplifier Factor(dB)
3. The other emission levels were very low against the limit.
4. Margin value = Emission Level – Limit value
5. " * ": Fundamental frequency.
6. " # ": The radiated frequency is out of the restricted band.

Below 1GHz Data:

802.11ac (VHT20)

CHANNEL	TX Channel 40	DETECTOR FUNCTION	Quasi-Peak (QP)
FREQUENCY RANGE	below 1GHz		

ANTENNA POLARITY & TEST DISTANCE: HORIZONTAL AT 3 M

NO.	FREQ. (MHz)	EMISSION LEVEL (dBuV/m)	LIMIT (dBuV/m)	MARGIN (dB)	ANTENNA HEIGHT (m)	TABLE ANGLE (Degree)	RAW VALUE (dBuV)	CORRECTION FACTOR (dB/m)
1	39.41	32.3 QP	40.0	-7.7	1.50 H	266	41.3	-9.0
2	83.98	31.4 QP	40.0	-8.6	2.00 H	69	45.6	-14.2
3	159.08	28.9 QP	43.5	-14.6	1.50 H	286	37.4	-8.5
4	250.00	26.2 QP	46.0	-19.8	1.00 H	51	36.2	-10.0
5	385.07	30.4 QP	46.0	-15.6	1.00 H	341	36.3	-5.9
6	799.14	35.7 QP	46.0	-10.3	1.00 H	156	33.2	2.5

ANTENNA POLARITY & TEST DISTANCE: VERTICAL AT 3 M

NO.	FREQ. (MHz)	EMISSION LEVEL (dBuV/m)	LIMIT (dBuV/m)	MARGIN (dB)	ANTENNA HEIGHT (m)	TABLE ANGLE (Degree)	RAW VALUE (dBuV)	CORRECTION FACTOR (dB/m)
1	39.49	32.5 QP	40.0	-7.5	1.50 V	288	41.5	-9.0
2	84.11	31.7 QP	40.0	-8.3	2.00 V	189	45.9	-14.2
3	159.19	29.4 QP	43.5	-14.1	1.50 V	360	37.9	-8.5
4	250.22	26.3 QP	46.0	-19.7	1.00 V	69	36.3	-10.0
5	385.20	30.7 QP	46.0	-15.3	1.00 V	326	36.6	-5.9
6	799.06	35.3 QP	46.0	-10.7	1.00 V	137	32.8	2.5

REMARKS:

1. Emission Level(dBuV/m) = Raw Value(dBuV) + Correction Factor(dB/m)
2. Correction Factor(dB/m) = Antenna Factor(dB/m) + Cable Factor(dB) – Pre-Amplifier Factor(dB)
3. The other emission levels were very low against the limit.
4. Margin value = Emission Level – Limit value

4.2 Conducted Emission Measurement

4.2.1 Limits of Conducted Emission Measurement

Frequency (MHz)	Conducted Limit (dBuV)	
	Quasi-peak	Average
0.15 - 0.5	66 - 56	56 - 46
0.50 - 5.0	56	46
5.0 - 30.0	60	50

Note: 1. The lower limit shall apply at the transition frequencies.

2. The limit decreases in line with the logarithm of the frequency in the range of 0.15 to 0.50MHz.

4.2.2 Test Instruments

DESCRIPTION & MANUFACTURER	MODEL NO.	SERIAL NO.	CALIBRATED DATE	CALIBRATED UNTIL
Test Receiver R&S	ESCS 30	847124/029	Oct. 23, 2015	Oct. 22, 2016
Line-Impedance Stabilization Network (for EUT) R&S	ESH3-Z5	848773/004	Oct. 28, 2015	Oct. 27, 2016
RF Cable	5D-FB	COACAB-002	Mar. 04, 2016	Mar. 03, 2017
10 dB PAD Mini-Circuits	HAT-10+	CONATT-004	Jun. 20, 2016	Jun. 19, 2017
Software BVADT	BVADT_Cond_ V7.3.7.3	NA	NA	NA

Note:

1. The calibration interval of the above test instruments are 12 months and the calibrations are traceable to NML/ROC and NIST/USA.
2. The test was performed in Shielded Room No. 1.
- 3 Tested Date: July 27, 2016

4.2.3 Test Procedure

- The EUT was placed 0.4 meters from the conducting wall of the shielded room with EUT being connected to the power mains through a line impedance stabilization network (LISN). Other support units were connected to the power mains through another LISN. The two LISNs provide 50 ohm/ 50uH of coupling impedance for the measuring instrument.
- Both lines of the power mains connected to the EUT were checked for maximum conducted interference.
- The frequency range from 150kHz to 30MHz was searched. Emission levels under (Limit - 20dB) was not recorded.

NOTE: All modes of operation were investigated and the worst-case emissions are reported.

4.2.4 Deviation from Test Standard

No deviation.

4.2.5 Test Setup

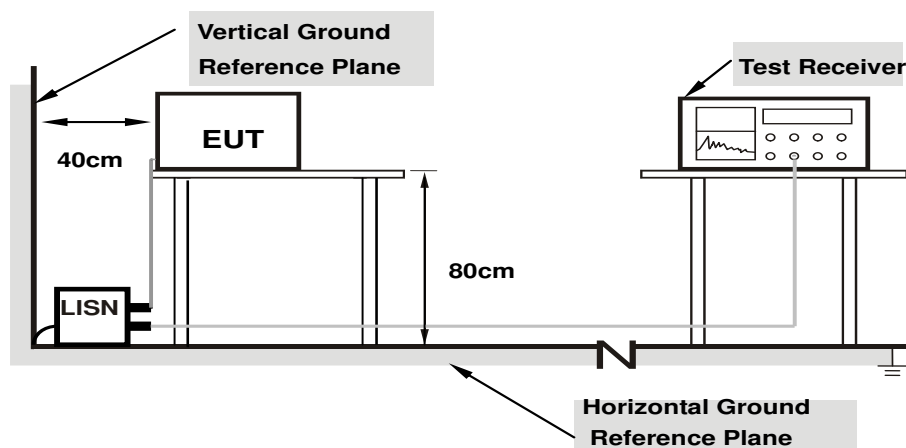

Note: 1.Support units were connected to second LISN.

For the actual test configuration, please refer to the attached file (Test Setup Photo).

4.2.6 EUT Operating Condition

Same as 4.1.6.

4.2.7 Test Results (Mode 1)

Phase	Line (L)	Detector Function	Quasi-Peak (QP) / Average (AV)
-------	----------	-------------------	--------------------------------

No	Freq. [MHz]	Corr. Factor	Reading Value [dB (uV)]		Emission Level [dB (uV)]		Limit [dB (uV)]		Margin (dB)	
		(dB)	Q.P.	AV.	Q.P.	AV.	Q.P.	AV.	Q.P.	AV.
	1	0.15000	10.21	40.96	27.11	51.17	37.32	66.00	56.00	-14.83
2	0.25156	10.22	31.03	23.22	41.25	33.44	61.71	51.71	-20.46	-18.27
3	0.41172	10.22	36.16	32.50	46.38	42.72	57.61	47.61	-11.23	-4.89
4	0.88047	10.25	18.94	12.89	29.19	23.14	56.00	46.00	-26.81	-22.86
5	1.37500	10.28	17.88	12.33	28.16	22.61	56.00	46.00	-27.84	-23.39
6	12.07031	10.80	20.20	15.07	31.00	25.87	60.00	50.00	-29.00	-24.13

REMARKS:

1. Q.P. and AV. are abbreviations of quasi-peak and average individually.
2. The emission levels of other frequencies were very low against the limit.
3. Margin value = Emission level - Limit value
4. Correction factor = Insertion loss + Cable loss
5. Emission Level = Correction Factor + Reading Value.

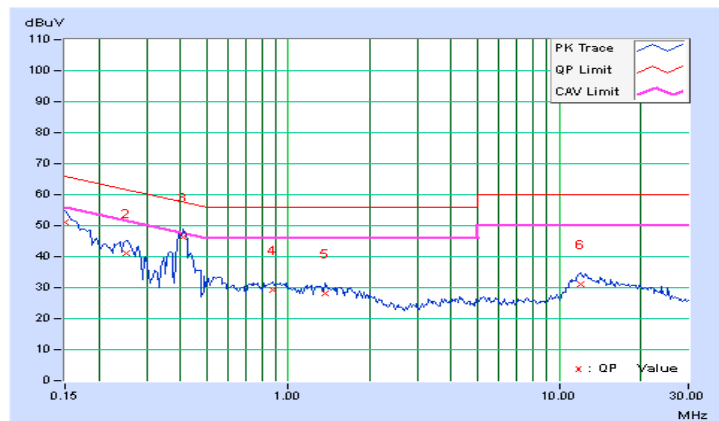

Phase	Neutral (N)	Detector Function	Quasi-Peak (QP) / Average (AV)
-------	-------------	-------------------	--------------------------------

No	Freq. [MHz]	Corr. Factor	Reading Value [dB (uV)]		Emission Level [dB (uV)]		Limit [dB (uV)]		Margin (dB)	
		(dB)	Q.P.	AV.	Q.P.	AV.	Q.P.	AV.	Q.P.	AV.
	1	0.15391	10.19	41.07	27.27	51.26	37.46	65.79	55.79	-14.52
2	0.18516	10.20	34.89	21.36	45.09	31.56	64.25	54.25	-19.16	-22.69
3	0.41356	10.20	37.42	34.22	47.62	44.42	57.58	47.58	-9.96	-3.16
4	0.88047	10.23	13.03	6.77	23.26	17.00	56.00	46.00	-32.74	-29.00
5	1.77734	10.28	14.82	9.09	25.10	19.37	56.00	46.00	-30.90	-26.63
6	14.82422	10.88	19.26	14.25	30.14	25.13	60.00	50.00	-29.86	-24.87

REMARKS:

1. Q.P. and AV. are abbreviations of quasi-peak and average individually.
2. The emission levels of other frequencies were very low against the limit.
3. Margin value = Emission level - Limit value
4. Correction factor = Insertion loss + Cable loss
5. Emission Level = Correction Factor + Reading Value.

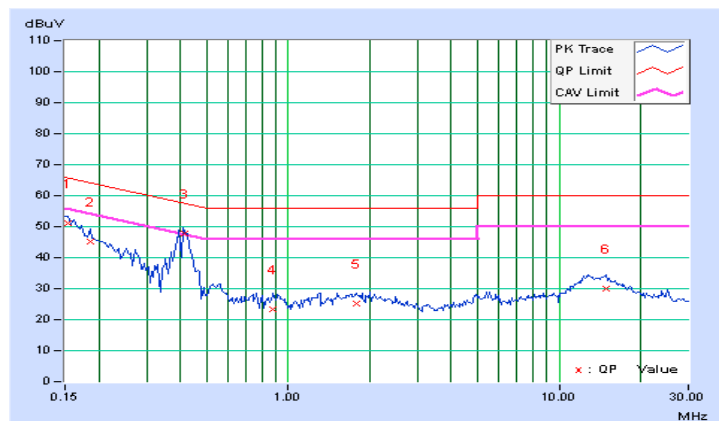

4.2.8 Test Results (Mode 2)

Phase	Line (L)	Detector Function	Quasi-Peak (QP) / Average (AV)
-------	----------	-------------------	--------------------------------

No	Freq. [MHz]	Corr. Factor	Reading Value [dB (uV)]		Emission Level [dB (uV)]		Limit [dB (uV)]		Margin (dB)	
		(dB)	Q.P.	AV.	Q.P.	AV.	Q.P.	AV.	Q.P.	AV.
	1	0.15000	10.21	43.67	30.80	53.88	41.01	66.00	56.00	-12.12
2	0.18906	10.22	37.01	23.55	47.23	33.77	64.08	54.08	-16.85	-20.31
3	0.32969	10.22	39.66	33.68	49.88	43.90	59.46	49.46	-9.58	-5.56
4	0.85313	10.25	16.01	11.37	26.26	21.62	56.00	46.00	-29.74	-24.38
5	1.57422	10.29	14.96	8.39	25.25	18.68	56.00	46.00	-30.75	-27.32
6	5.82031	10.39	17.99	10.84	28.38	21.23	60.00	50.00	-31.62	-28.77

REMARKS:

1. Q.P. and AV. are abbreviations of quasi-peak and average individually.
2. The emission levels of other frequencies were very low against the limit.
3. Margin value = Emission level - Limit value
4. Correction factor = Insertion loss + Cable loss
5. Emission Level = Correction Factor + Reading Value.

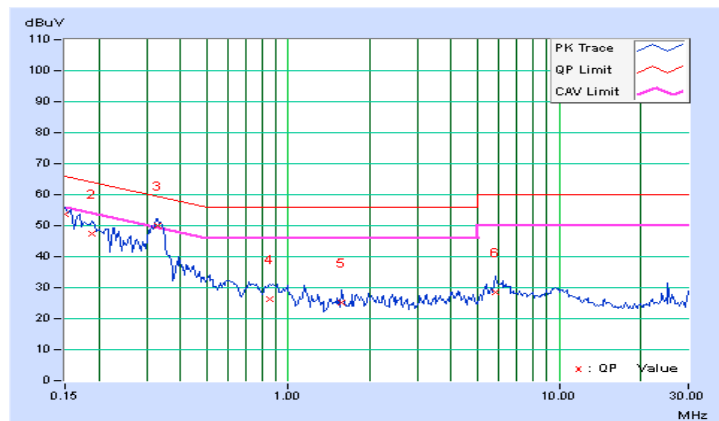

Phase	Neutral (N)	Detector Function	Quasi-Peak (QP) / Average (AV)
-------	-------------	-------------------	--------------------------------

No	Freq. [MHz]	Corr. Factor	Reading Value [dB (uV)]		Emission Level [dB (uV)]		Limit [dB (uV)]		Margin (dB)	
		(dB)	Q.P.	AV.	Q.P.	AV.	Q.P.	AV.	Q.P.	AV.
	1	0.15391	10.19	42.87	28.86	53.06	39.05	65.79	55.79	-12.72
2	0.22812	10.21	35.38	25.10	45.59	35.31	62.52	52.52	-16.93	-17.21
3	0.32969	10.20	40.96	35.14	51.16	45.34	59.46	49.46	-8.30	-4.12
4	0.60703	10.21	19.59	13.94	29.80	24.15	56.00	46.00	-26.20	-21.85
5	1.65234	10.27	13.78	8.38	24.05	18.65	56.00	46.00	-31.95	-27.35
6	10.24609	10.52	13.79	9.29	24.31	19.81	60.00	50.00	-35.69	-30.19

REMARKS:

1. Q.P. and AV. are abbreviations of quasi-peak and average individually.
2. The emission levels of other frequencies were very low against the limit.
3. Margin value = Emission level - Limit value
4. Correction factor = Insertion loss + Cable loss
5. Emission Level = Correction Factor + Reading Value.

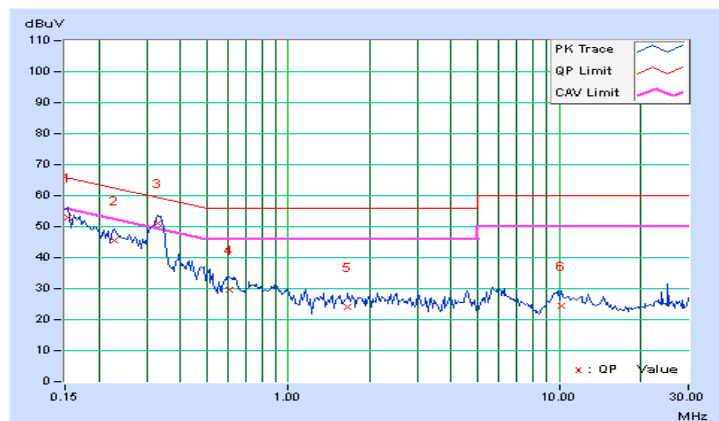

4.3 Transmit Power Measurement

4.3.1 Limits of Transmit Power Measurement

Operation Band	EUT Category		Limit
U-NII-1		Outdoor Access Point	1 Watt (30 dBm) (Max. e.i.r.p \leq 125mW(21 dBm) at any elevation angle above 30 degrees as measured from the horizon)
		Fixed point-to-point Access Point	1 Watt (30 dBm)
	√	Indoor Access Point	1 Watt (30 dBm)
		Mobile and Portable client device	250mW (24 dBm)
U-NII-2A			250mW (24 dBm) or 11 dBm+10 log B*
U-NII-2C			250mW (24 dBm) or 11 dBm+10 log B*
U-NII-3		√	1 Watt (30 dBm)

*B is the 26 dB emission bandwidth in megahertz

Per KDB 662911 Method of conducted output power measurement on IEEE 802.11 devices,

Array Gain = 0 dB (i.e., no array gain) for $N_{ANT} \leq 4$;

Array Gain = 0 dB (i.e., no array gain) for channel widths ≥ 40 MHz for any N_{ANT} ;

Array Gain = $5 \log(N_{ANT}/N_{SS})$ dB or 3 dB, whichever is less for 20-MHz channel widths with $N_{ANT} \geq 5$.

For power measurements on all other devices: Array Gain = $10 \log(N_{ANT}/N_{SS})$ dB.

4.3.2 Test Setup

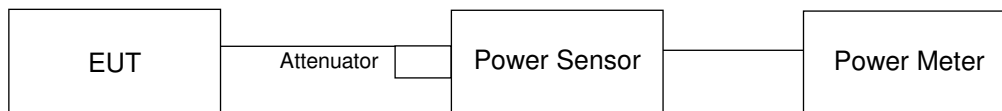

4.3.3 Test Instruments

Refer to section 4.1.2 to get information of above instrument.

4.3.4 Test Procedure

Method PM is used to perform output power measurement, trigger and gating function of wide band power meter is enabled to measure max output power of TX on burst. Duty factor is not added to measured value.

4.3.5 Deviation from Test Standard

No deviation.

4.3.6 EUT Operating Condition

The software provided by client to enable the EUT under transmission condition continuously at lowest, middle and highest channel frequencies individually.

4.3.7 Test Result

CDD Mode
802.11a

Chan.	Chan. Freq. (MHz)	Maximum Conducted Power (dBm)		Total Power (mW)	Total Power (dBm)	Limit (dBm)	Pass / Fail
		Chain 0	Chain 1				
36	5180	23.78	23.64	469.987	26.72	30	Pass
40	5200	23.70	23.60	463.51	26.66	30	Pass
48	5240	22.19	22.91	361.011	25.58	30	Pass
149	5745	22.52	22.68	364.002	25.61	30	Pass
157	5785	22.49	22.79	367.527	25.65	30	Pass
165	5825	22.44	22.56	355.69	25.51	30	Pass

802.11ac (VHT20)

Chan.	Chan. Freq. (MHz)	Maximum Conducted Power (dBm)		Total Power (mW)	Total Power (dBm)	Limit (dBm)	Pass / Fail
		Chain 0	Chain 1				
36	5180	23.77	23.79	477.564	26.79	30	Pass
40	5200	23.82	23.81	481.427	26.83	30	Pass
48	5240	22.12	23.18	370.9	25.69	30	Pass
149	5745	22.49	22.76	366.218	25.64	30	Pass
157	5785	22.54	22.80	370.019	25.68	30	Pass
165	5825	22.52	22.76	367.448	25.65	30	Pass

802.11ac (VHT40)

Chan.	Chan. Freq. (MHz)	Maximum Conducted Power (dBm)		Total Power (mW)	Total Power (dBm)	Limit (dBm)	Pass / Fail
		Chain 0	Chain 1				
38	5190	18.56	19.30	156.893	21.96	30	Pass
46	5230	21.87	22.96	351.512	25.46	30	Pass
151	5755	21.79	21.87	304.823	24.84	30	Pass
159	5795	22.54	22.69	365.253	25.63	30	Pass

802.11ac (VHT80)

Chan.	Chan. Freq. (MHz)	Maximum Conducted Power (dBm)		Total Power (mW)	Total Power (dBm)	Limit (dBm)	Pass / Fail
		Chain 0	Chain 1				
42	5210	18.25	18.90	144.459	21.60	30	Pass
155	5775	21.32	21.65	281.737	24.50	30	Pass

Beamforming Mode

802.11ac (VHT20)

Chan.	Chan. Freq. (MHz)	Maximum Conducted Power (dBm)		Total Power (mW)	Total Power (dBm)	Limit (dBm)	Pass / Fail
		Chain 0	Chain 1				
36	5180	23.77	23.79	477.564	26.79	29.55	Pass
40	5200	23.82	23.81	481.427	26.83	29.55	Pass
48	5240	22.12	23.18	370.9	25.69	29.55	Pass
149	5745	22.49	22.76	366.218	25.64	30.00	Pass
157	5785	22.54	22.80	370.019	25.68	30.00	Pass
165	5825	22.52	22.76	367.448	25.65	30.00	Pass

- Note:** 1. For UNII-1: Directional gain = $3.44\text{dBi} + 10\log(2) = 6.45\text{dBi} > 6\text{dBi}$, so the power limit shall be reduced to $30 - (6.45 - 6) = 29.55\text{dBm}$
 2. For UNII-3: Directional gain = $2.16\text{dBi} + 10\log(2) = 5.17\text{dBi} < 6\text{dBi}$, so the power limit shall not to be reduced.

802.11ac (VHT40)

Chan.	Chan. Freq. (MHz)	Maximum Conducted Power (dBm)		Total Power (mW)	Total Power (dBm)	Limit (dBm)	Pass / Fail
		Chain 0	Chain 1				
38	5190	18.56	19.30	156.893	21.96	29.55	Pass
46	5230	21.87	22.96	351.512	25.46	29.55	Pass
151	5755	21.79	21.87	304.823	24.84	30.00	Pass
159	5795	22.54	22.69	365.253	25.63	30.00	Pass

- Note:** 1. For UNII-1: Directional gain = $3.44\text{dBi} + 10\log(2) = 6.45\text{dBi} > 6\text{dBi}$, so the power limit shall be reduced to $30 - (6.45 - 6) = 29.55\text{dBm}$
 2. For UNII-3: Directional gain = $2.16\text{dBi} + 10\log(2) = 5.17\text{dBi} < 6\text{dBi}$, so the power limit shall not to be reduced.

802.11ac (VHT80)

Chan.	Chan. Freq. (MHz)	Maximum Conducted Power (dBm)		Total Power (mW)	Total Power (dBm)	Limit (dBm)	Pass / Fail
		Chain 0	Chain 1				
42	5210	18.25	18.90	144.459	21.60	29.55	Pass
155	5775	21.32	21.65	281.737	24.50	30.00	Pass

- Note:** 1. For UNII-1: Directional gain = $3.44\text{dBi} + 10\log(2) = 6.45\text{dBi} > 6\text{dBi}$, so the power limit shall be reduced to $30 - (6.45 - 6) = 29.55\text{dBm}$
 2. For UNII-3: Directional gain = $2.16\text{dBi} + 10\log(2) = 5.17\text{dBi} < 6\text{dBi}$, so the power limit shall not to be reduced.

4.4 Occupied Bandwidth Measurement

4.4.1 Test Setup

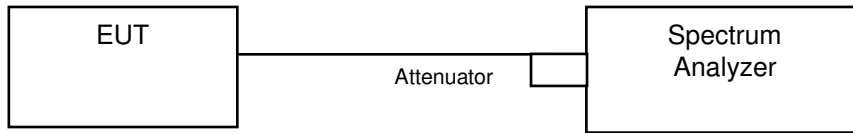

4.4.2 Test Instruments

Refer to section 4.1.2 to get information of above instrument.

4.4.3 Test Procedure

The transmitter output was connected to the spectrum analyzer through an attenuator. The bandwidth of the fundamental frequency was measured by spectrum analyzer with resolution bandwidth in the range of 1% to 5% of the anticipated emission bandwidth, and a video bandwidth at least 3x the resolution bandwidth and set the detector to SAMPLE. The width of a frequency band such that, below the lower and above the upper frequency limits, the mean powers emitted are each equal to a specified percentage 0.5 %of the total mean power of a given emission.

4.4.4 Test Result

802.11a

Channel	Channel Frequency (MHz)	Occupied Bandwidth (MHz)	
		Chain 0	Chain 1
36	5180	23.76	25.32
40	5200	24.24	24.60
48	5240	18.96	17.64
149	5745	31.44	33.84
157	5785	30.24	34.68
165	5825	30.72	34.20

802.11ac (VHT20)

Channel	Channel Frequency (MHz)	Occupied Bandwidth (MHz)	
		Chain 0	Chain 1
36	5180	24.00	26.52
40	5200	25.44	25.92
48	5240	18.72	18.60
149	5745	33.24	36.48
157	5785	33.24	36.24
165	5825	33.36	37.92

802.11ac (VHT40)

Channel	Channel Frequency (MHz)	Occupied Bandwidth (MHz)	
		Chain 0	Chain 1
38	5190	36.72	36.72
46	5230	37.92	38.16
151	5755	52.80	49.92
159	5795	66.96	73.92

802.11ac (VHT80)

Channel	Channel Frequency (MHz)	Occupied Bandwidth (MHz)	
		Chain 0	Chain 1
42	5210	75.84	75.84
155	5775	77.28	76.80

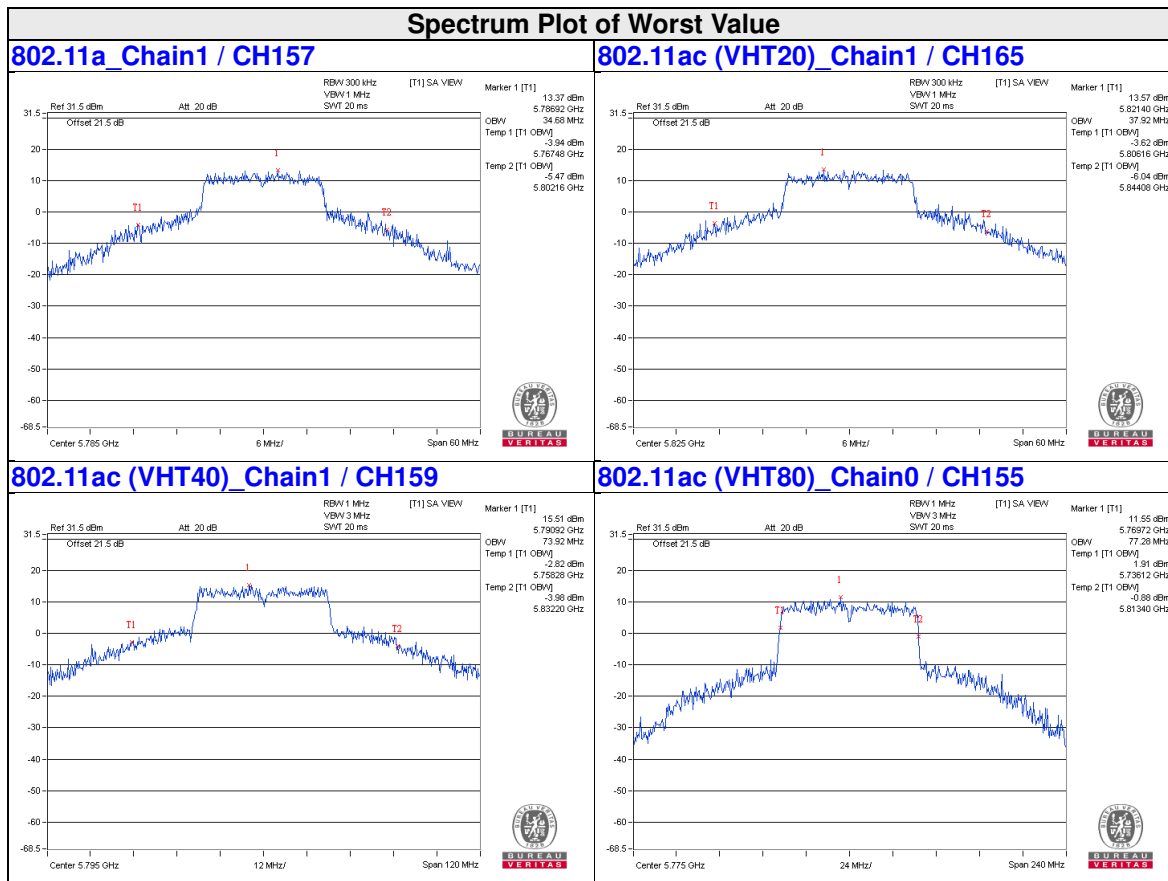

Spectrum Plot for near by DFS band (DFS is required, if 99% OCP straddle into U-NII-2A band)

802.11a_Chain0 / CH48

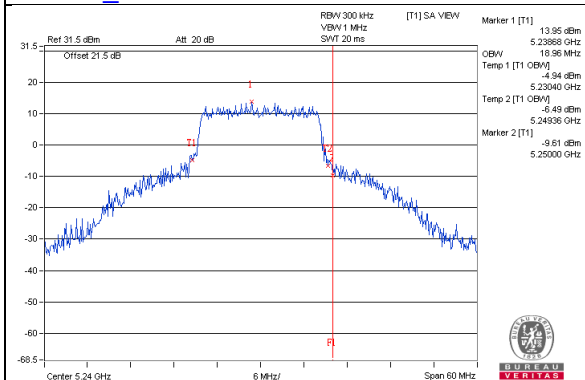

802.11a_Chain1 / CH48

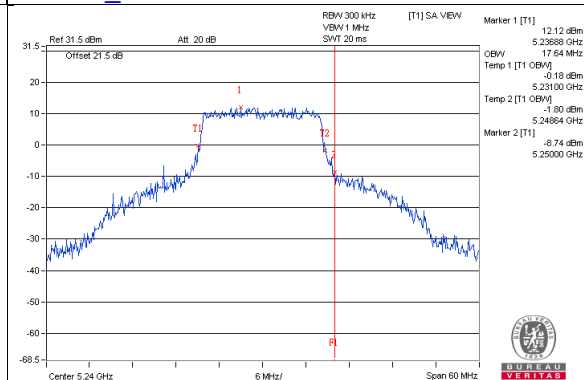

802.11ac(VHT20)_Chain0 / CH48

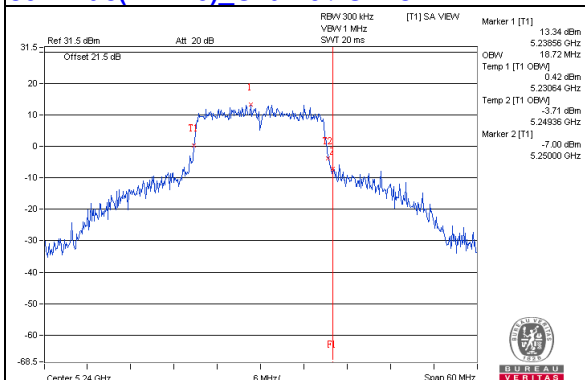

802.11ac(VHT20)_Chain1 / CH48

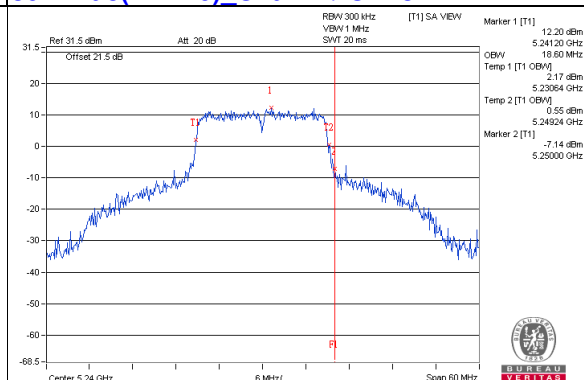

802.11ac(VHT40)_Chain0 / CH46

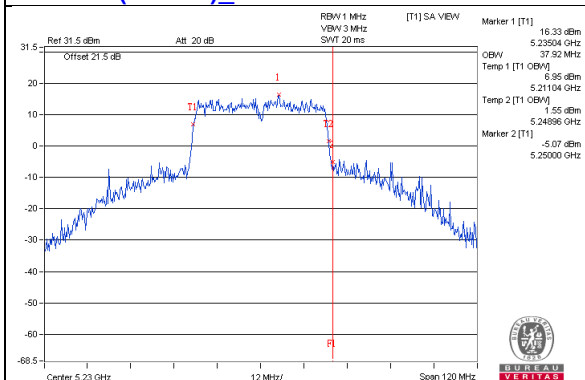

802.11ac(VHT40)_Chain1 / CH46

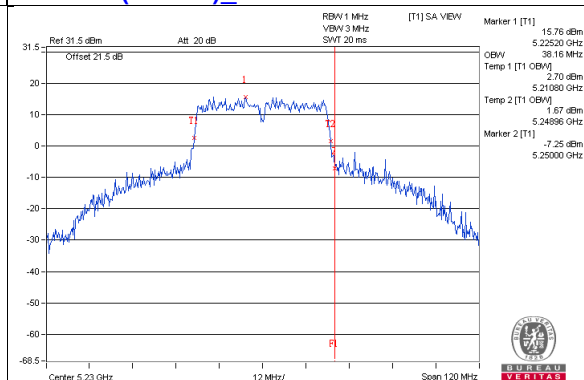

802.11ac(VHT80)_Chain0 / CH42

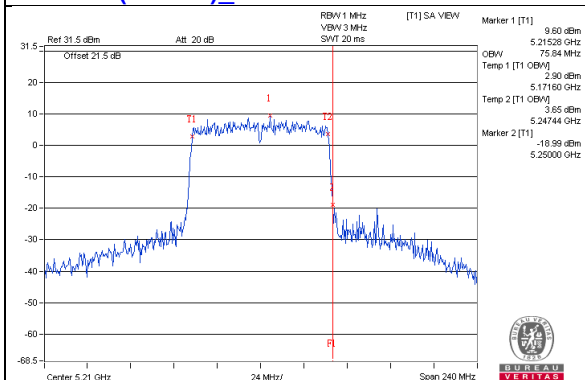

802.11ac(VHT80)_Chain1 / CH42

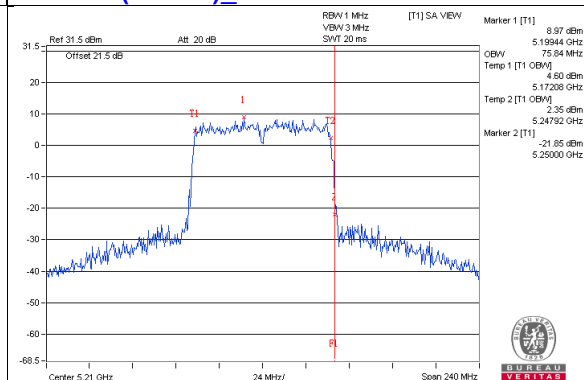

Spectrum Plot for near by DFS band (DFS is required, if 99% OCP straddle into U-NII-2C band)

802.11a_Chain0 / CH149

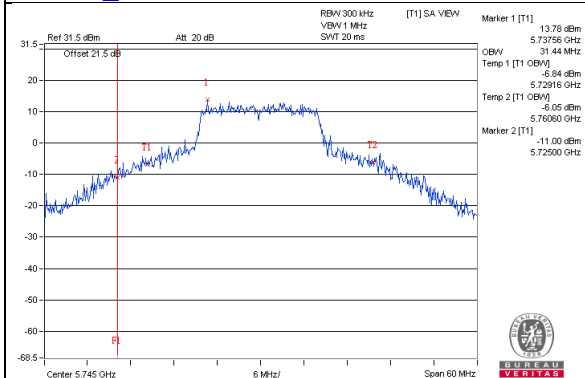

802.11a_Chain1 / CH149

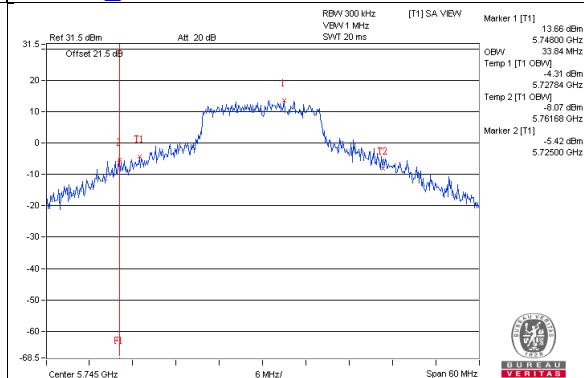

802.11ac(VHT20)_Chain0 / CH149

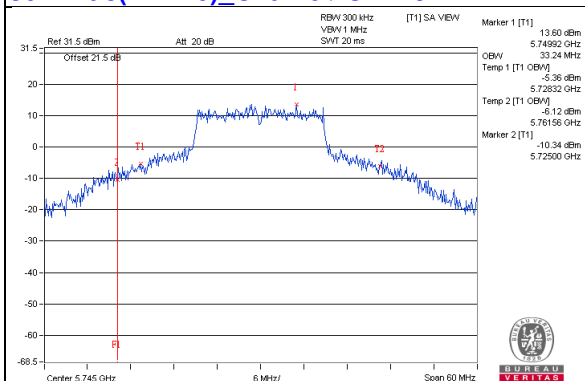

802.11ac(VHT20)_Chain1 / CH149

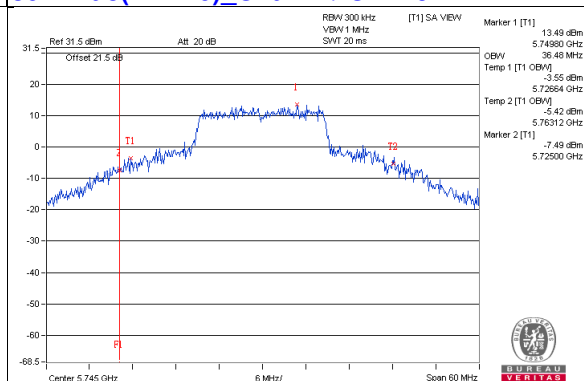

802.11ac(VHT40)_Chain0 / CH151

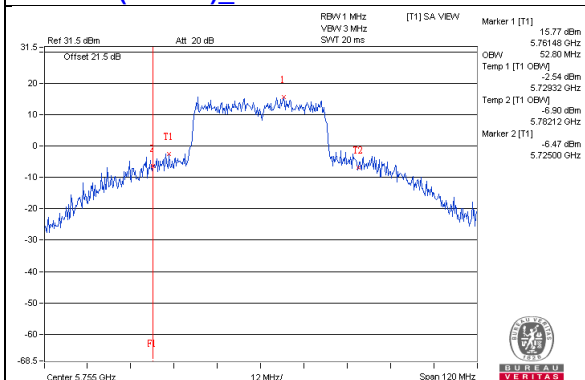

802.11ac(VHT40)_Chain1 / CH151

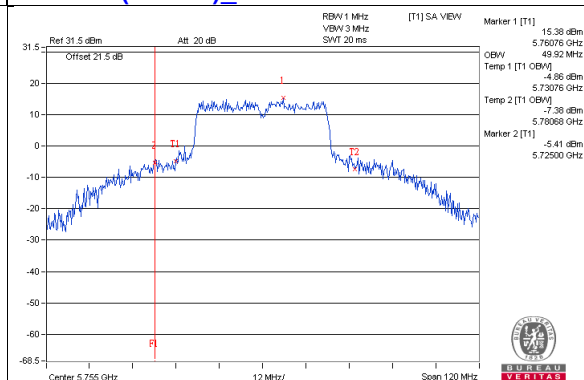

802.11ac(VHT80)_Chain0 / CH155

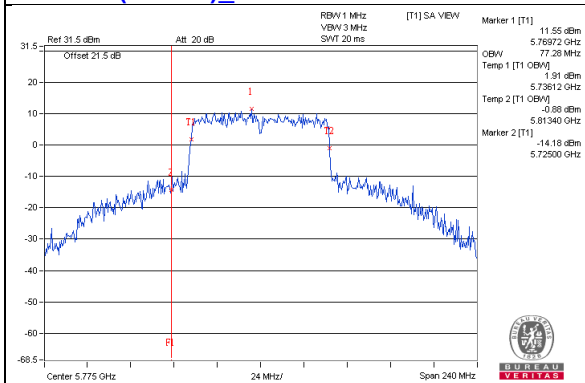

802.11ac(VHT80)_Chain1 / CH155

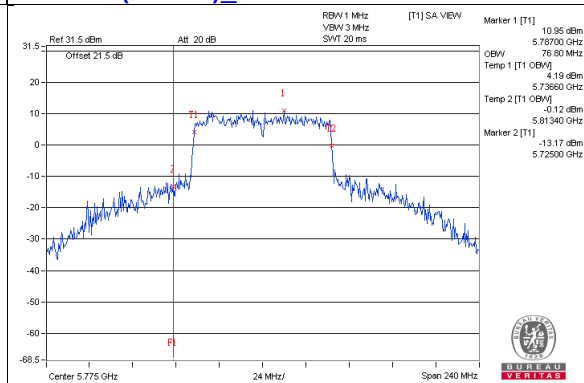

4.5 Peak Power Spectral Density Measurement

4.5.1 Limits of Peak Power Spectral Density Measurement

Operation Band	EUT Category		Limit
U-NII-1		Outdoor Access Point	17dBm/ MHz
		Fixed point-to-point Access Point	
	√	Indoor Access Point	
		Mobile and Portable client device	11dBm/ MHz
U-NII-2A			11dBm/ MHz
U-NII-2C			11dBm/ MHz
U-NII-3	√		30dBm/ 500kHz

4.5.2 Test Setup

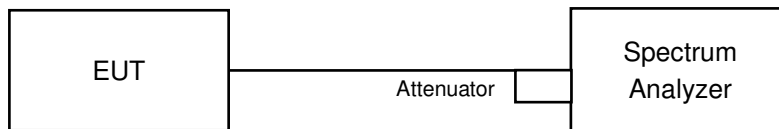

4.5.3 Test Instruments

Refer to section 4.1.2 to get information of above instrument.

4.5.4 Test Procedure

802.11a, 802.11ac (VHT20), 802.11ac (VHT40)

For U-NII-1:

Using method SA-1

1. Set span to encompass the entire emission bandwidth (EBW) of the signal.
2. Set RBW = 1 MHz, Set VBW \geq 3 MHz, Detector = RMS
3. Sweep time = auto, trigger set to "free run".
4. Trace average at least 100 traces in power averaging mode.
5. Record the max value

For U-NII-3:

1. Set span to encompass the entire emission bandwidth (EBW) of the signal.
2. Set RBW = 300 kHz, Set VBW \geq 1 MHz, Detector = RMS
3. Use the peak marker function to determine the maximum power level in any 300 kHz band segment within the fundamental EBW.
4. Scale the observed power level to an equivalent value in 500 kHz by adjusting (reducing) the measured power by a bandwidth correction factor (BWCF) where $BWCF = 10\log(500 \text{ kHz}/300\text{kHz})$
5. Sweep time = auto, trigger set to "free run".
6. Trace average at least 100 traces in power averaging mode.
7. Record the max value

802.11ac (VHT80)

For U-NII-1:

Using method SA-2

1. Set span to encompass the entire emission bandwidth (EBW) of the signal.
2. Set RBW = 1 MHz, Set VBW \geq 3 MHz, Detector = RMS
3. Sweep time = auto, trigger set to "free run".
4. Trace average at least 100 traces in power averaging mode.
5. Record the max value and add $10 \log (1/\text{duty cycle})$

For U-NII-3:

1. Set span to encompass the entire emission bandwidth (EBW) of the signal.
2. Set RBW = 300 kHz, Set VBW \geq 1 MHz, Detector = RMS
3. Use the peak marker function to determine the maximum power level in any 300 kHz band segment within the fundamental EBW.
4. Scale the observed power level to an equivalent value in 500 kHz by adjusting (reducing) the measured power by a bandwidth correction factor (BWCF) where $BWCF = 10\log(500 \text{ kHz}/300\text{kHz})$
5. Sweep time = auto, trigger set to "free run".
6. Trace average at least 100 traces in power averaging mode.
7. Record the max value and add $10 \log (1/\text{duty cycle})$

4.5.5 Deviation from Test Standard

No deviation.

4.5.6 EUT Operating Condition

Same as Item 4.3.6.

4.5.7 Test Results

For U-NII-1:

802.11a

Chan.	Chan. Freq. (MHz)	PSD (dBm/MHz)		Total Power Density (dBm/MHz)	MAX. Limit (dBm/MHz)	Pass / Fail
		Chain 0	Chain 1			
36	5180	10.26	10.07	13.18	16.55	Pass
40	5200	10.38	10.19	13.30	16.55	Pass
48	5240	9.30	8.61	11.98	16.55	Pass

- Note:** 1. Method a) of power density measurement of KDB 662911 is using for calculating total power density. Total power density is summing entire spectra across corresponding frequency bins on the various outputs by computer.
2. Directional gain = $3.44\text{dBi} + 10\log(2) = 6.45\text{dBi} > 6\text{dBi}$, so the power density limit shall be reduced to $17 - (6.45 - 6) = 16.55\text{dBm}$.

802.11ac (VHT20)

Chan.	Chan. Freq. (MHz)	PSD (dBm/MHz)		Total Power Density (dBm/MHz)	MAX. Limit (dBm/MHz)	Pass / Fail
		Chain 0	Chain 1			
36	5180	9.57	9.82	12.71	16.55	Pass
40	5200	9.79	9.92	12.87	16.55	Pass
48	5240	8.63	8.40	11.53	16.55	Pass

- Note:** 1. Method a) of power density measurement of KDB 662911 is using for calculating total power density. Total power density is summing entire spectra across corresponding frequency bins on the various outputs by computer.
2. Directional gain = $3.44\text{dBi} + 10\log(2) = 6.45\text{dBi} > 6\text{dBi}$, so the power density limit shall be reduced to $17 - (6.45 - 6) = 16.55\text{dBm}$.

802.11ac (VHT40)

Chan.	Chan. Freq. (MHz)	PSD (dBm/MHz)		Total Power Density (dBm/MHz)	MAX. Limit (dBm/MHz)	Pass / Fail
		Chain 0	Chain 1			
38	5190	2.50	2.96	5.75	16.55	Pass
46	5230	5.93	5.95	8.95	16.55	Pass

- Note:** 1. Method a) of power density measurement of KDB 662911 is using for calculating total power density. Total power density is summing entire spectra across corresponding frequency bins on the various outputs by computer.
2. Directional gain = $3.44\text{dBi} + 10\log(2) = 6.45\text{dBi} > 6\text{dBi}$, so the power density limit shall be reduced to $17 - (6.45 - 6) = 16.55\text{dBm}$.

802.11ac (VHT80):

Chan.	Chan. Freq. (MHz)	PSD W/O Duty Factor (dBm/MHz)		Duty Factor (dB)	Total PSD With Duty Factor (dBm/MHz)	MAX. Limit (dBm/MHz)	Pass / Fail
		Chain 0	Chain 1				
42	5210	-0.90	-0.82	0.14	2.29	16.55	Pass

- Note:**
- Method a) of power density measurement of KDB 662911 is using for calculating total power density. Total power density is summing entire spectra across corresponding frequency bins on the various outputs by computer.
 - Directional gain = $3.44\text{dBi} + 10\log(2) = 6.45\text{dBi} > 6\text{dBi}$, so the power density limit shall be reduced to $17 - (6.45 - 6) = 16.55\text{dBm}$.
 - Refer to section 3.3 for duty cycle spectrum plot.

Spectrum Plot of Worst Value

802.11a_Chain 0 / CH40

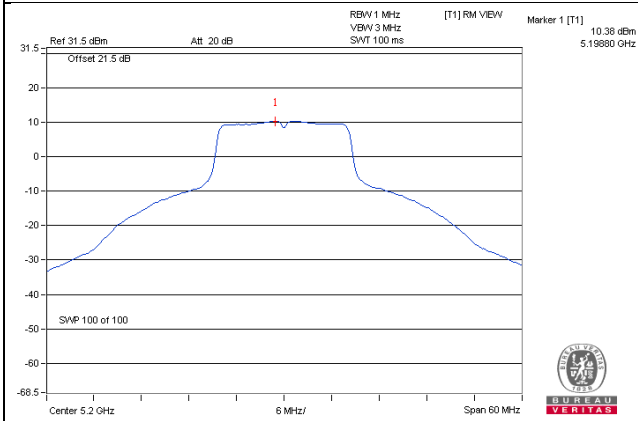

802.11ac (VHT20)_Chain 1 / CH40

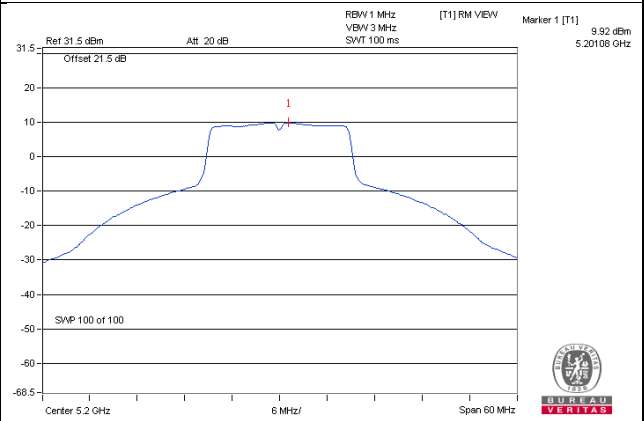

802.11ac (VHT40)_Chain 1 / CH46

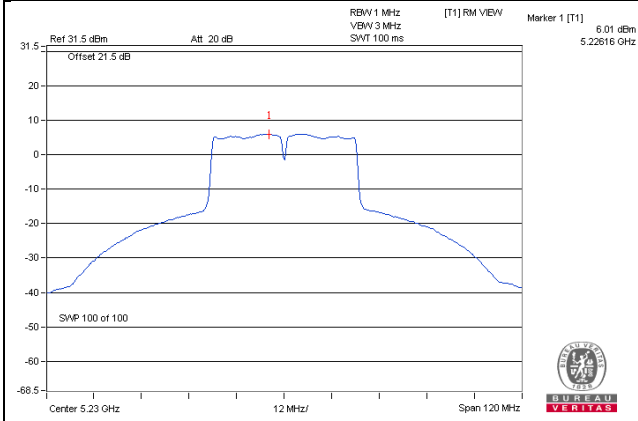

802.11ac (VHT80)_Chain 1 / CH42

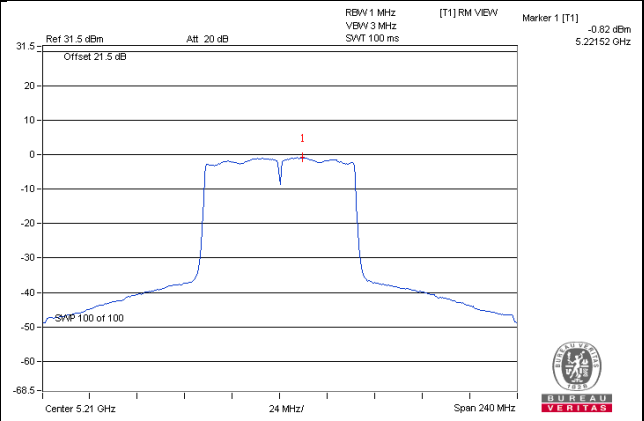

For U-NII-3:

802.11a

TX chain	Channel	Freq. (MHz)	PSD (dBm/300kHz)	PSD (dBm/500kHz)	10 log (N=2) dB	Total PSD (dBm/500kHz)	Limit (dBm/500kHz)	Pass /Fail
0	149	5745	1.34	3.56	3.01	6.57	30.00	Pass
	157	5785	1.11	3.33	3.01	6.34	30.00	Pass
	165	5825	1.35	3.57	3.01	6.58	30.00	Pass
1	149	5745	1.38	3.60	3.01	6.61	30.00	Pass
	157	5785	1.21	3.43	3.01	6.44	30.00	Pass
	165	5825	1.53	3.75	3.01	6.76	30.00	Pass

Note: 1. Directional gain = $2.16\text{dBi} + 10\log(2) = 5.17\text{dBi} < 6\text{dBi}$, so the power density limit shall not be reduced.

802.11ac (VHT20)

TX chain	Channel	Freq. (MHz)	PSD (dBm/300kHz)	PSD (dBm/500kHz)	10 log (N=2) dB	Total PSD (dBm/500kHz)	Limit (dBm/500kHz)	Pass /Fail
0	149	5745	1.15	3.37	3.01	6.38	30.00	Pass
	157	5785	0.81	3.03	3.01	6.04	30.00	Pass
	165	5825	0.79	3.01	3.01	6.02	30.00	Pass
1	149	5745	0.94	3.16	3.01	6.17	30.00	Pass
	157	5785	0.84	3.06	3.01	6.07	30.00	Pass
	165	5825	1.29	3.51	3.01	6.52	30.00	Pass

Note: 1. Directional gain = $2.16\text{dBi} + 10\log(2) = 5.17\text{dBi} < 6\text{dBi}$, so the power density limit shall not be reduced.

802.11ac (VHT40)

TX chain	Channel	Freq. (MHz)	PSD (dBm/300kHz)	PSD (dBm/500kHz)	10 log (N=2) dB	Total PSD (dBm/500kHz)	Limit (dBm/500kHz)	Pass /Fail
0	151	5755	-2.47	-0.25	3.01	2.76	30.00	Pass
	159	5795	-2.67	-0.45	3.01	2.56	30.00	Pass
1	151	5755	-2.44	-0.22	3.01	2.79	30.00	Pass
	159	5795	-2.41	-0.19	3.01	2.82	30.00	Pass

Note: 1. Directional gain = $2.16\text{dBi} + 10\log(2) = 5.17\text{dBi} < 6\text{dBi}$, so the power density limit shall not be reduced.

802.11ac (VHT80)

TX chain	Chan.	Chan. Freq. (MHz)	PSD W/O Duty Factor		10 log (N=2) dB	Duty Factor (dB)	Total PSD With Duty Factor (dBm/500kHz)	Limit (dBm/500kHz)	Pass /Fail
			(dBm/300kHz)	(dBm/500kHz)					
0	155	5775	-7.06	-4.84	3.01	0.14	-1.69	30.00	Pass
1	155	5775	-7.19	-4.97	3.01	0.14	-1.82	30.00	Pass

Note: 1. Directional gain = $2.16\text{dBi} + 10\log(2) = 5.17\text{dBi} < 6\text{dBi}$, so the power density limit shall not be reduced.

Spectrum Plot of Worst Value

802.11a_Chain 1 / CH165

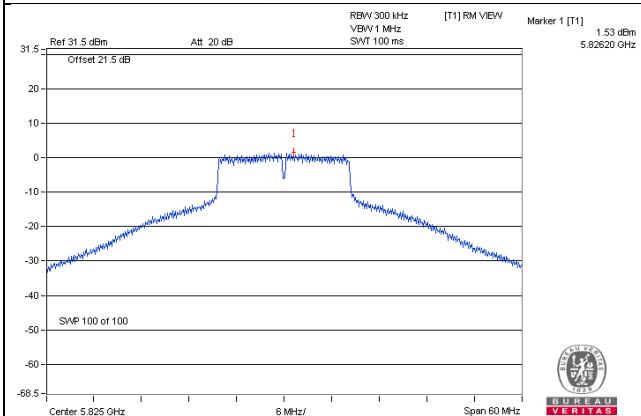

802.11ac (VHT20)_Chain 1 / CH165

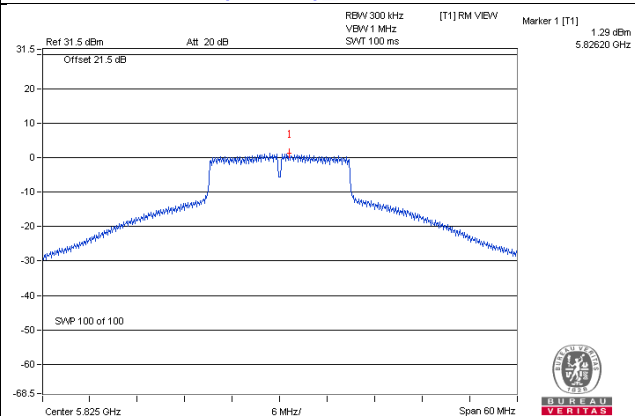

802.11ac (VHT40)_Chain 1 / CH159

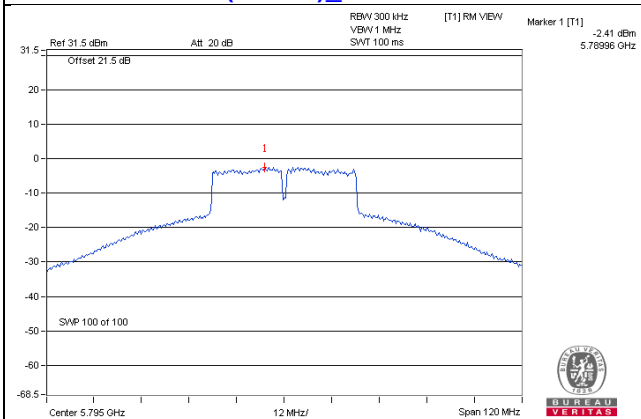

802.11ac (VHT80)_Chain 0 / CH155

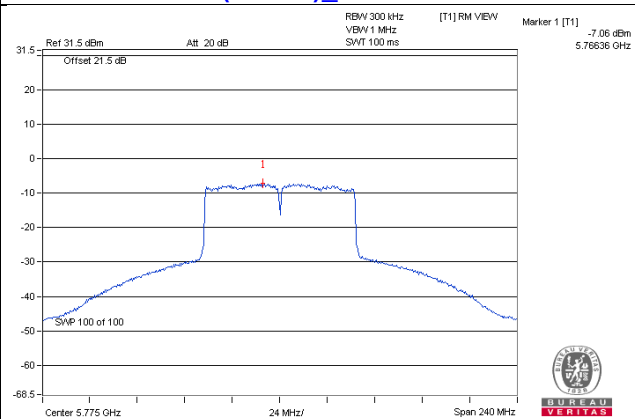

4.6 Frequency Stability Measurement

4.6.1 Limits of Frequency Stability Measurement

The frequency of the carrier signal shall be maintained within band of operation

4.6.2 Test Setup

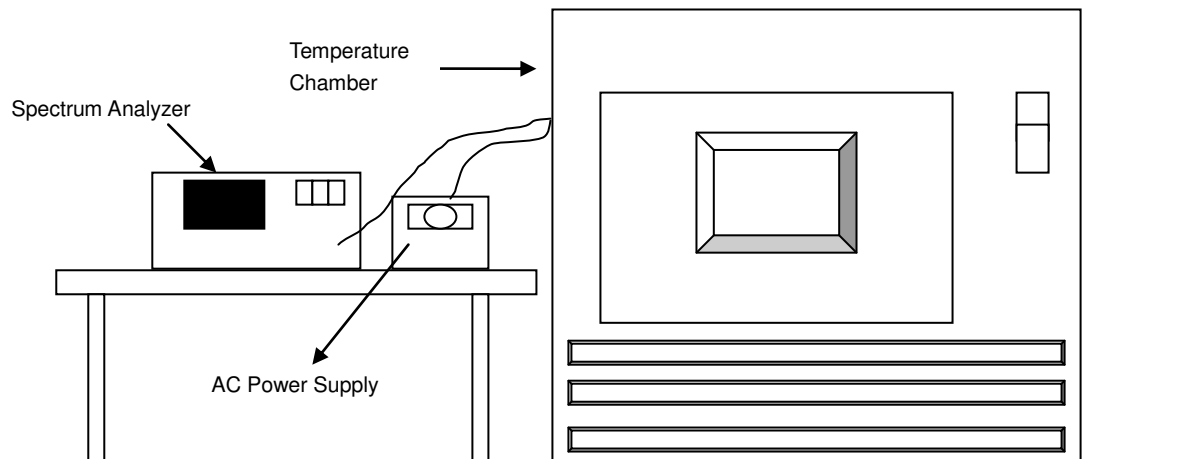

4.6.3 Test Instruments

Refer to section 4.1.2 to get information of above instrument.

4.6.4 Test Procedure

- The EUT was placed inside the environmental test chamber and powered by nominal AC voltage.
- Turn the EUT on and couple its output to a spectrum analyzer.
- Turn the EUT off and set the chamber to the highest temperature specified.
- Allow sufficient time (approximately 30 min) for the temperature of the chamber to stabilize, turn the EUT on and measure the operating frequency after 2, 5, and 10 Minutes.
- Repeat step 2 and 3 with the temperature chamber set to the lowest temperature.
- The test chamber was allowed to stabilize at +20 degree C for a minimum of 30 Minutes. The supply voltage was then adjusted on the EUT from 85% to 115% and the frequency record.

4.6.5 Deviation from Test Standard

No deviation.

4.6.6 EUT Operating Condition

Set the EUT transmit at un-modulation mode to test frequency stability.

4.6.7 Test Results

Frequency Stability Versus Temp.									
Operating Frequency: 5180 MHz									
TEMP. (°C)	Power Supply (Vac)	0 Minute		2 Minute		5 Minute		10 Minute	
		Measured Frequency (MHz)	Pass/Fail	Measured Frequency (MHz)	Pass/Fail	Measured Frequency (MHz)	Pass/Fail	Measured Frequency (MHz)	Pass/Fail
50	120	5179.9981	Pass	5179.9976	Pass	5179.9988	Pass	5179.9948	Pass
40	120	5179.9989	Pass	5179.999	Pass	5179.9994	Pass	5180.0015	Pass
30	120	5180.0193	Pass	5180.0233	Pass	5180.0208	Pass	5180.0214	Pass
20	120	5180.006	Pass	5180.0037	Pass	5180.0042	Pass	5180.0035	Pass
10	120	5179.9758	Pass	5179.9774	Pass	5179.975	Pass	5179.9787	Pass
0	120	5180.0148	Pass	5180.0168	Pass	5180.0133	Pass	5180.0155	Pass
-10	120	5179.9835	Pass	5179.979	Pass	5179.9836	Pass	5179.9823	Pass
-20	120	5180.0045	Pass	5180.0088	Pass	5180.0086	Pass	5180.0047	Pass
-30	120	5180.0063	Pass	5180.0097	Pass	5180.0071	Pass	5180.0066	Pass

Frequency Stability Versus Voltage									
Operating Frequency: 5180 MHz									
TEMP. (°C)	Power Supply (Vac)	0 Minute		2 Minute		5 Minute		10 Minute	
		Measured Frequency (MHz)	Pass/Fail	Measured Frequency (MHz)	Pass/Fail	Measured Frequency (MHz)	Pass/Fail	Measured Frequency (MHz)	Pass/Fail
20	138	5180.0057	Pass	5180.0034	Pass	5180.0033	Pass	5180.0027	Pass
	120	5180.006	Pass	5180.0037	Pass	5180.0042	Pass	5180.0035	Pass
	102	5180.0055	Pass	5180.0035	Pass	5180.0052	Pass	5180.0041	Pass

4.7 6dB Bandwidth Measurement

4.7.1 Limits of 6dB Bandwidth Measurement

The minimum of 6dB Bandwidth Measurement is 0.5MHz.

4.7.2 Test Setup

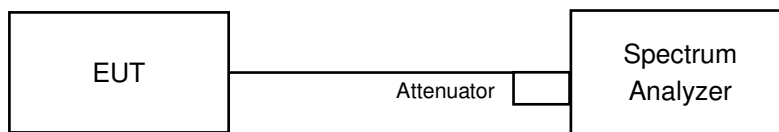

4.7.3 Test Instruments

Refer to section 4.1.2 to get information of above instrument.

4.7.4 Test Procedure

MEASUREMENT PROCEDURE REF

- Set resolution bandwidth (RBW) = 100kHz
- Set the video bandwidth (VBW) $\geq 3 \times$ RBW, Detector = Peak.
- Trace mode = max hold.
- Sweep = auto couple.
- Measure the maximum width of the emission that is constrained by the frequencies associated with the two amplitude points (upper and lower) that are attenuated by 6 dB relative to the maximum level measured in the fundamental emission

4.7.5 Deviation from Test Standard

No deviation.

4.7.6 EUT Operating Condition

The software provided by client to enable the EUT under transmission condition continuously at lowest, middle and highest channel frequencies individually.

4.7.7 Test Results

802.11a

Channel	Frequency (MHz)	6dB Bandwidth (MHz)		Minimum Limit (MHz)	Pass / Fail
		Chain 0	Chain 1		
149	5745	16.39	16.41	0.5	Pass
157	5785	16.39	16.40	0.5	Pass
165	5825	16.38	16.39	0.5	Pass

802.11ac (VHT20)

Channel	Frequency (MHz)	6dB Bandwidth (MHz)		Minimum Limit (MHz)	Pass / Fail
		Chain 0	Chain 1		
149	5745	17.64	17.64	0.5	Pass
157	5785	17.66	17.62	0.5	Pass
165	5825	17.67	17.62	0.5	Pass

802.11ac (VHT40)

Channel	Frequency (MHz)	6dB Bandwidth (MHz)		Minimum Limit (MHz)	Pass / Fail
		Chain 0	Chain 1		
151	5755	36.37	36.29	0.5	Pass
159	5795	36.14	36.42	0.5	Pass

802.11ac (VHT80)

Channel	Frequency (MHz)	6dB Bandwidth (MHz)		Minimum Limit (MHz)	Pass / Fail
		Chain 0	Chain 1		
155	5775	75.51	75.82	0.5	Pass

Spectrum Plot of Worst Value

802.11a / Chain 0 : CH165

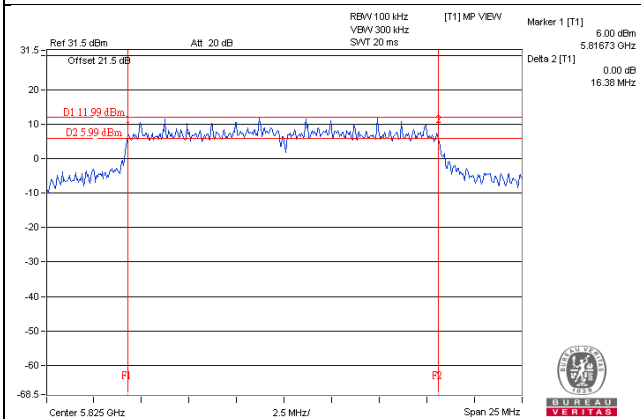

802.11ac(VHT20) / Chain 1 : CH157

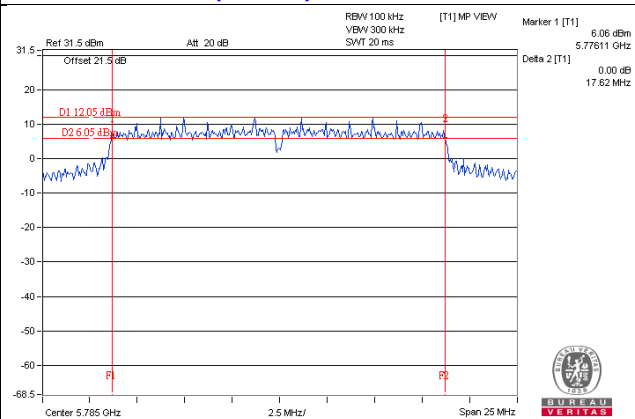

802.11ac(VHT40) / Chain 0 : CH159

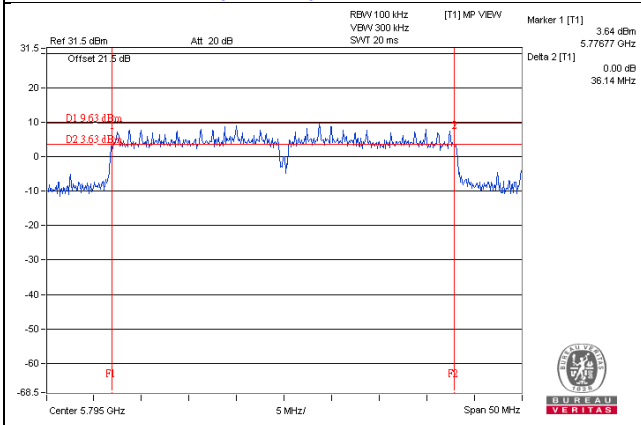

802.11ac(VHT80) / Chain 0 : CH155

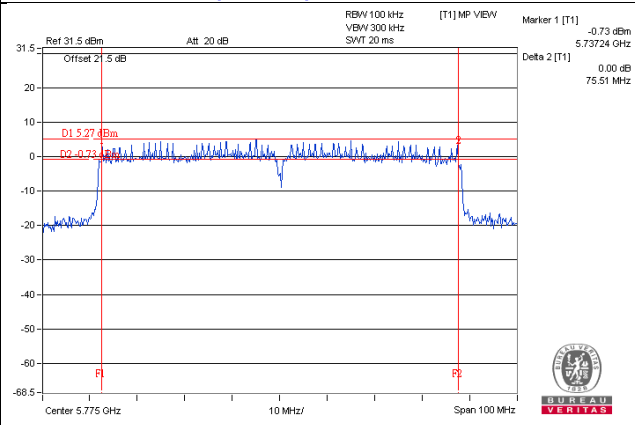

5 Pictures of Test Arrangements

Please refer to the attached file (Test Setup Photo).

Annex A- Radiated Out of Band Emission (OOBE) Measurement (For U-NII-3 band)

Mode 1

802.11a

CH 149 5745 MHz

Horizontal

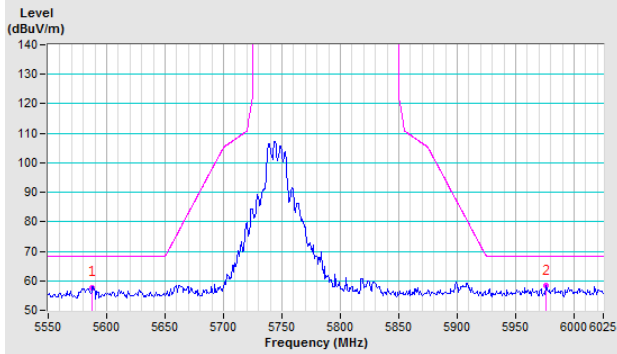

Vertical

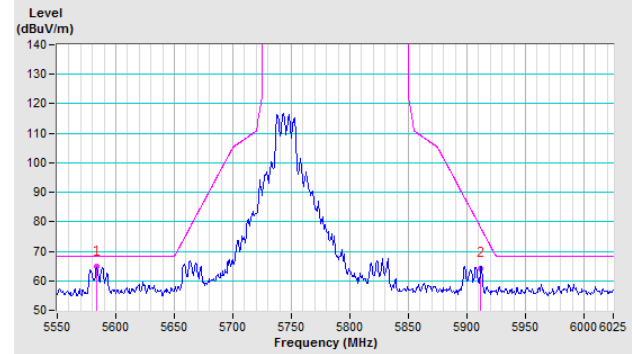

CH 157 5785 MHz

Horizontal

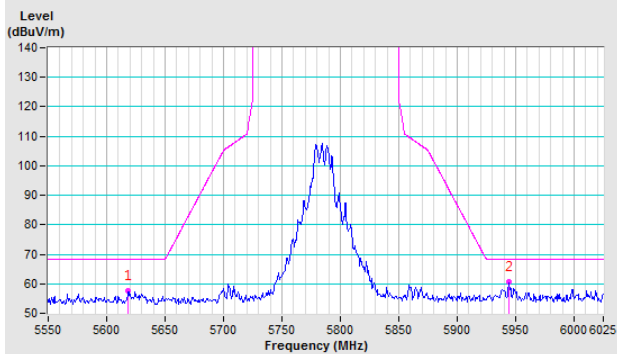

Vertical

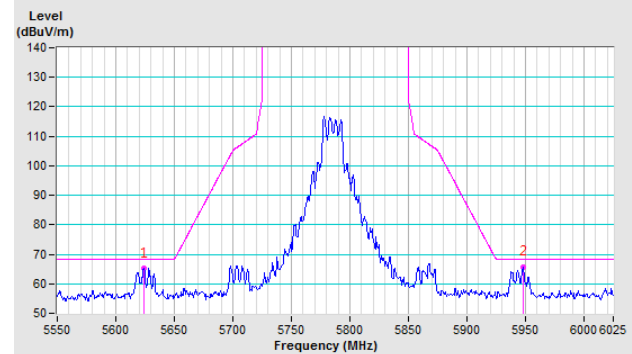

CH 165 5825 MHz

Horizontal

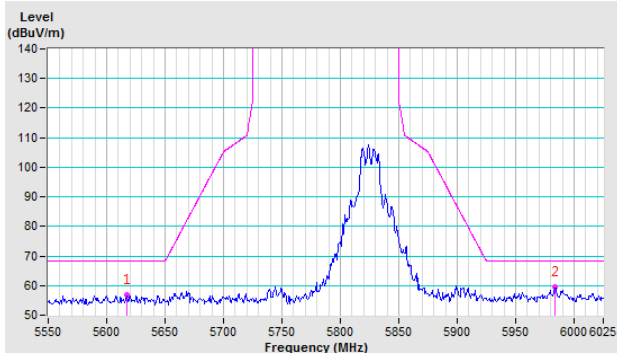

Vertical

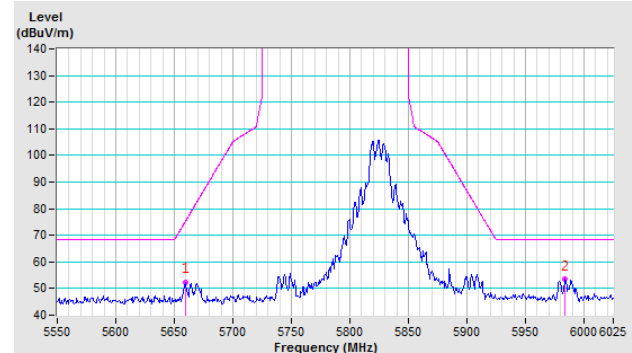

802.11ac (VHT20)

CH 149 5745 MHz

Horizontal

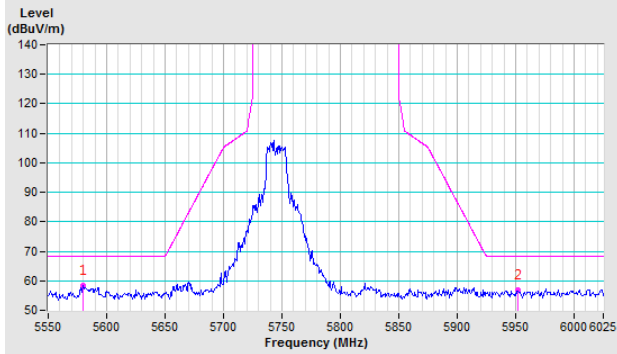

Vertical

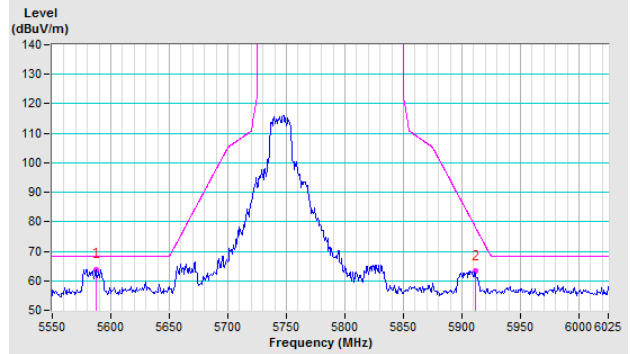

CH 157 5785 MHz

Horizontal

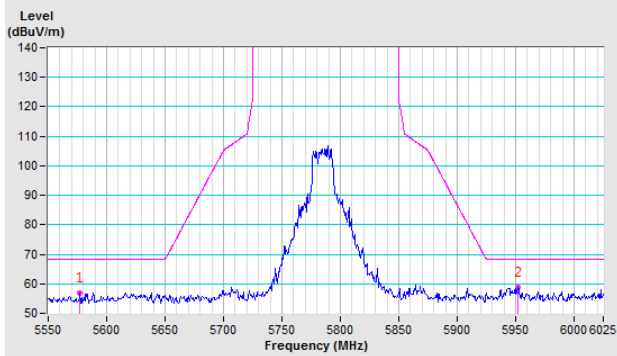

Vertical

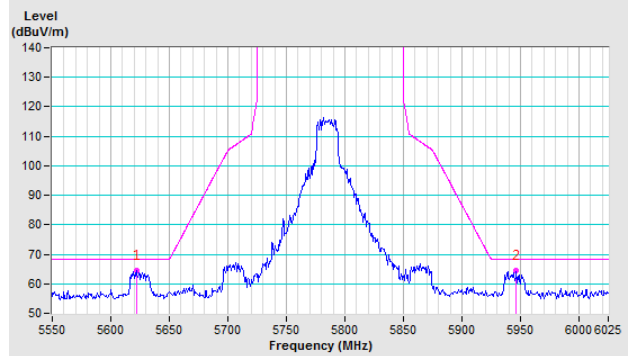

CH 165 5825 MHz

Horizontal

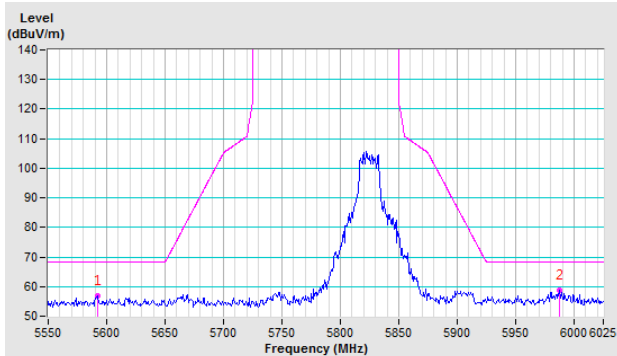

Vertical

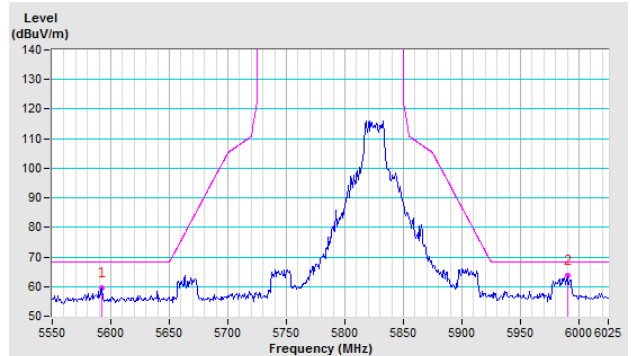

802.11ac (VHT40)

CH 151 5755 MHz

Horizontal

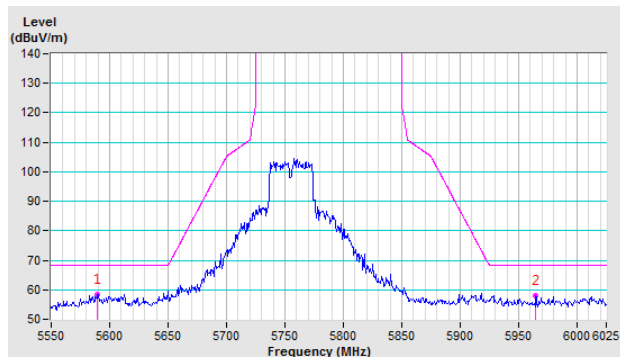

Vertical

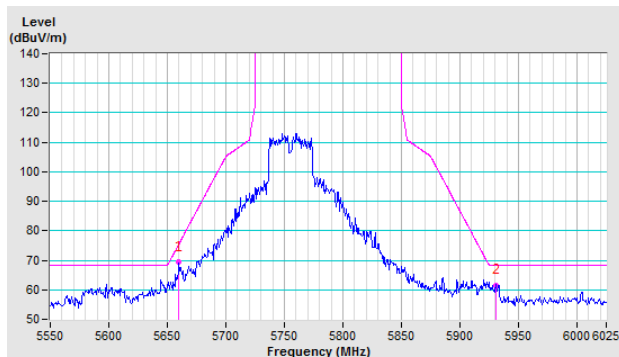

CH 159 5795 MHz

Horizontal

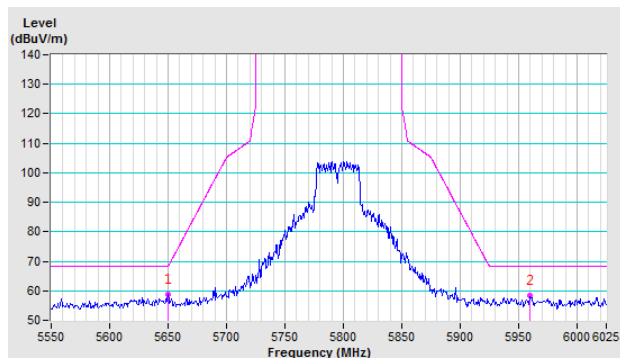

Vertical

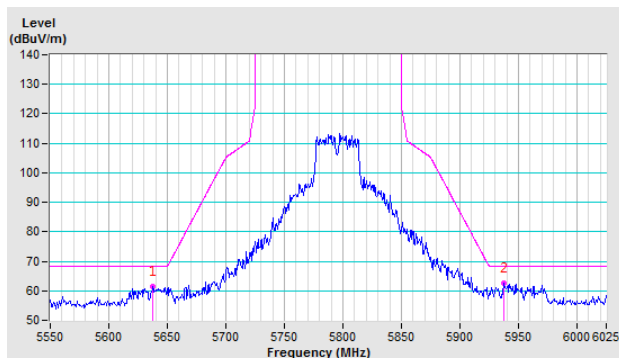

802.11ac (VHT80)

CH 155 5775 MHz

Horizontal

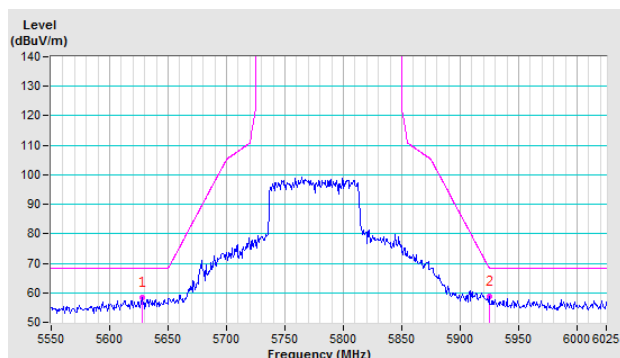

Vertical

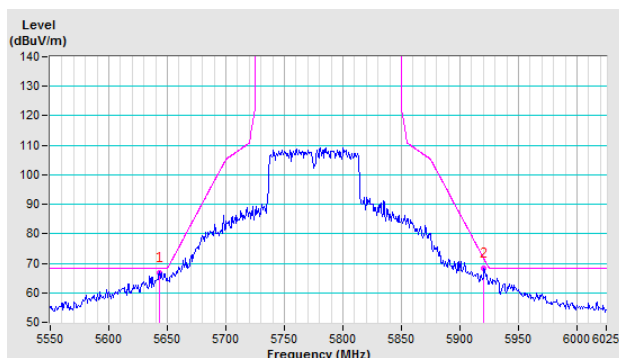

Mode 2

802.11a

CH 149 5745 MHz

Horizontal

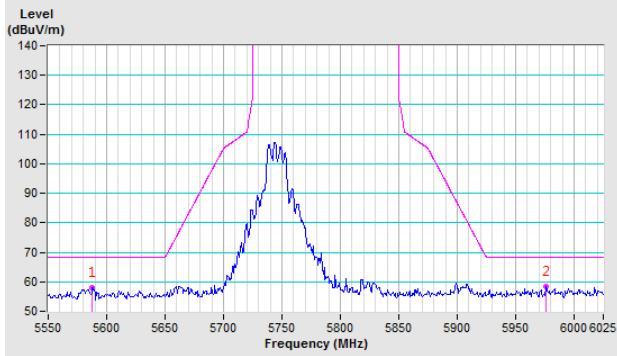

Vertical

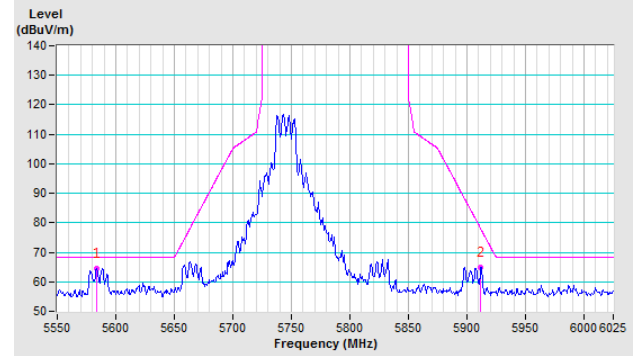

CH 157 5785 MHz

Horizontal

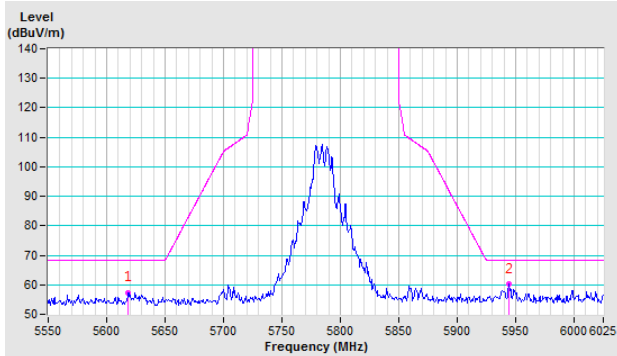

Vertical

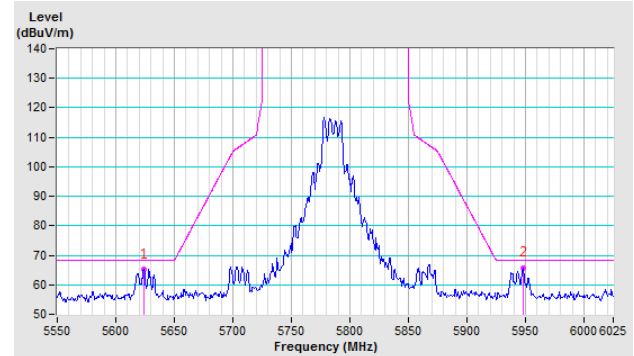

CH 165 5825 MHz

Horizontal

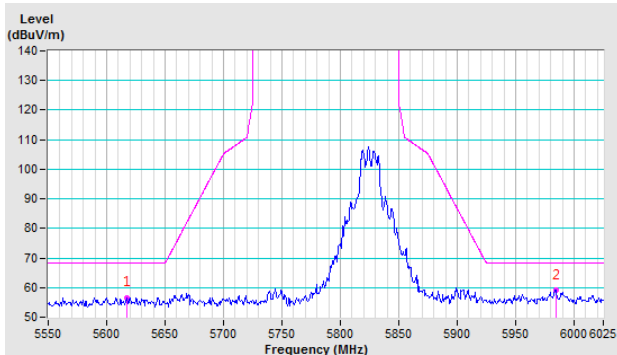

Vertical

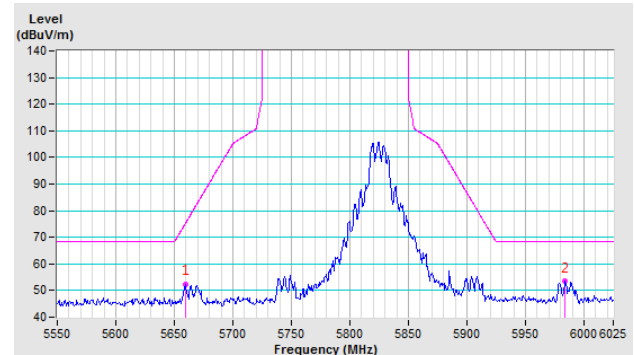

802.11ac (VHT20)

CH 149 5745 MHz

Horizontal

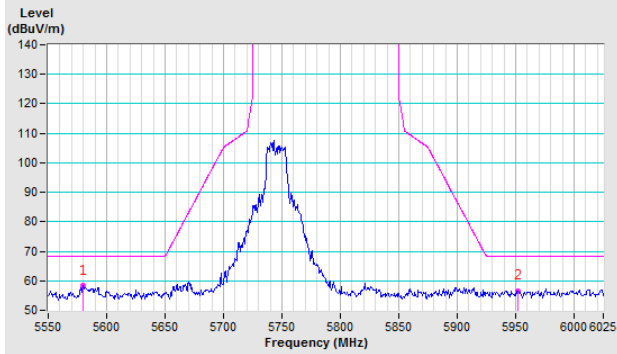

Vertical

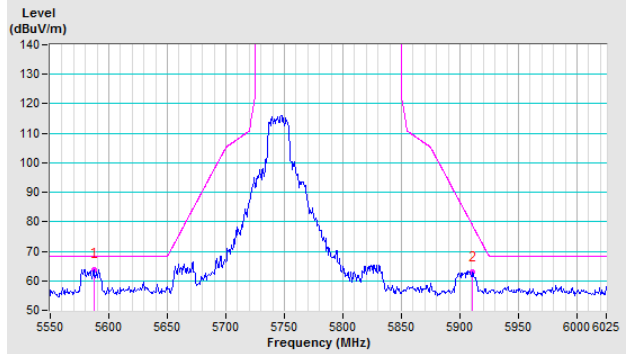

CH 157 5785 MHz

Horizontal

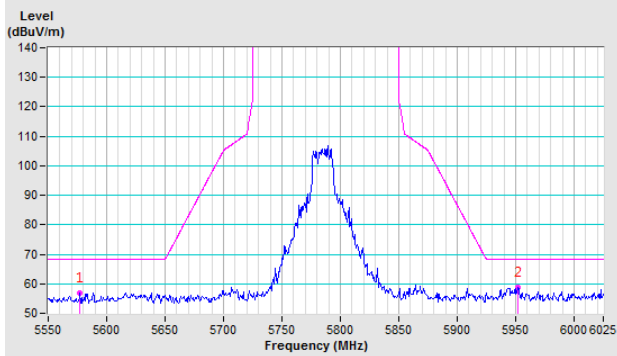

Vertical

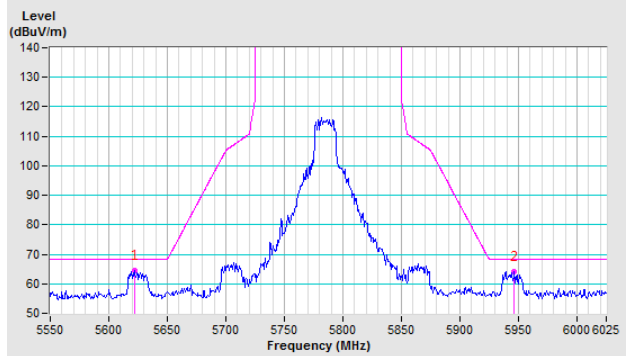

CH 165 5825 MHz

Horizontal

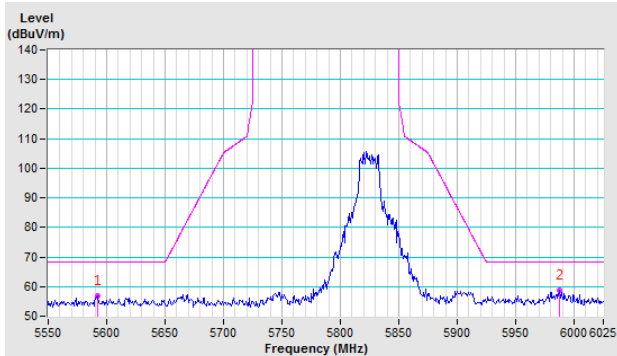

Vertical

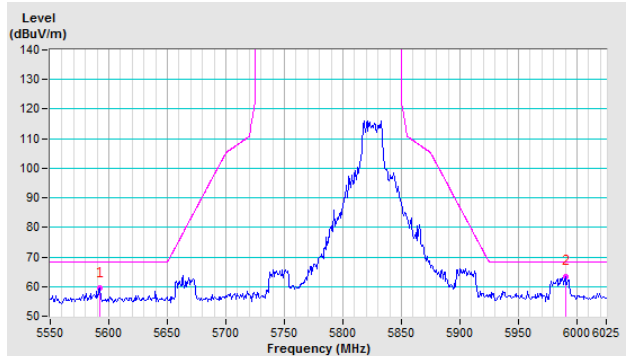

802.11ac (VHT40)

CH 151 5755 MHz

Horizontal

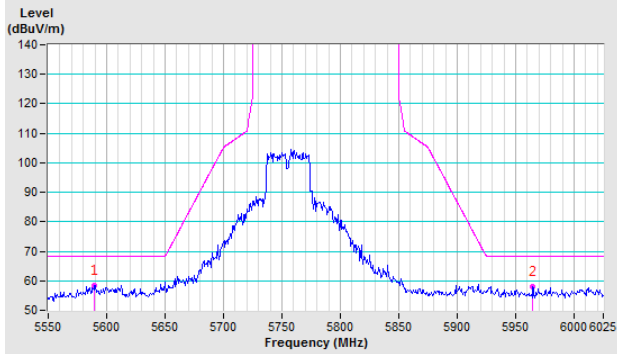

Vertical

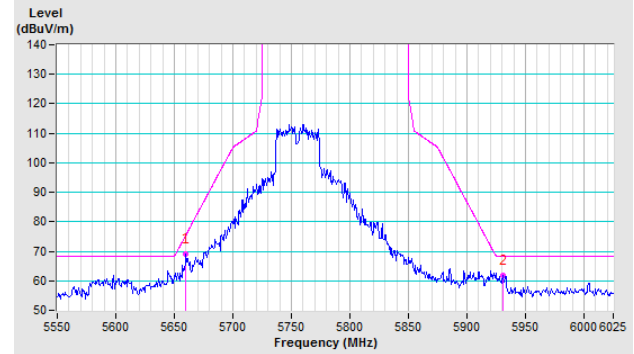

CH 159 5795 MHz

Horizontal

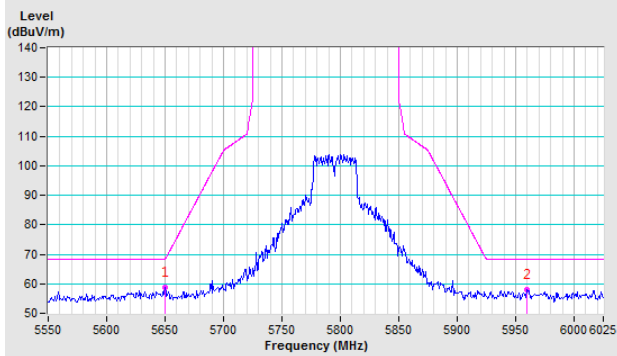

Vertical

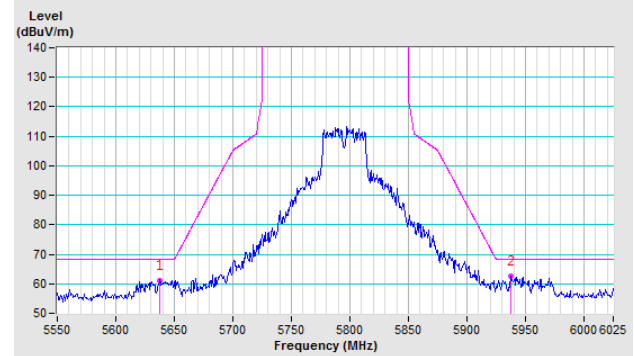

802.11ac (VHT80)

CH 155 5775 MHz

Horizontal

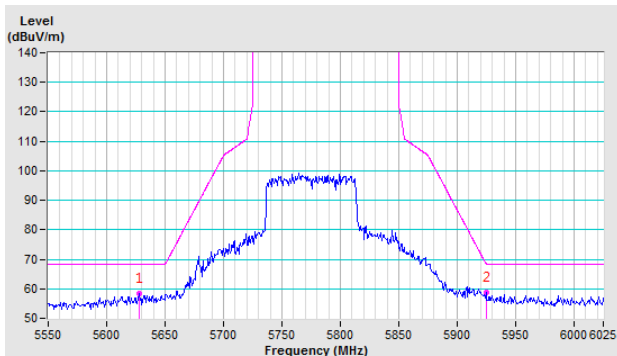

Vertical

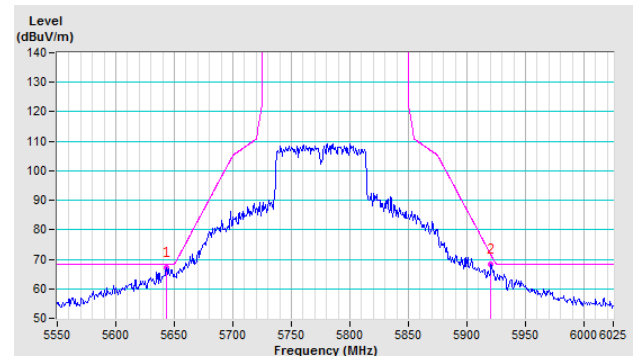

Appendix – Information on the Testing Laboratories

We, Bureau Veritas Consumer Products Services (H.K.) Ltd., Taoyuan Branch, were founded in 1988 to provide our best service in EMC, Radio, Telecom and Safety consultation. Our laboratories are accredited and approved according to ISO/IEC 17025.

If you have any comments, please feel free to contact us at the following:

Linko EMC/RF Lab

Tel: 886-2-26052180

Fax: 886-2-26051924

Hsin Chu EMC/RF/Telecom Lab

Tel: 886-3-6668565

Fax: 886-3-6668323

Hwa Ya EMC/RF/Safety Lab

Tel: 886-3-3183232

Fax: 886-3-3270892

Email: service.adt@tw.bureauveritas.com

Web Site: www.bureauveritas-adt.com

The address and road map of all our labs can be found in our web site also.

--- END ---