

## FCC Test Report

**Report No.:** RF160606E02-1

**FCC ID:** W59XWOBAP1

**Test Model:** XWO-BAP1

**Received Date:** June 06, 2016

**Test Date:** June 22 to 30, 2016

**Issued Date:** July 26, 2016

**Applicant:** Luxul Wireless

**Address:** 14203 Minuteman Dr Suite 201 Draper UT 84020 USA

**Issued By:** Bureau Veritas Consumer Products Services (H.K.) Ltd., Taoyuan Branch  
Hsin Chu Laboratory

**Lab Address:** E-2, No.1, Li Hsin 1st Road, Hsinchu Science Park, Hsinchu City 300,  
Taiwan R.O.C.

**Test Location (1):** E-2, No.1, Li Hsin 1st Road, Hsinchu Science Park, Hsinchu City 300,  
Taiwan R.O.C.

**Test Location (2):** No. 49, Ln. 206, Wende Rd., Shangshan Tsuen, Chiung Lin Hsiang, Hsin  
Chu Hsien 307, Taiwan R.O.C.



This report is for your exclusive use. Any copying or replication of this report to or for any other person or entity, or use of our name or trademark, is permitted only with our prior written permission. This report sets forth our findings solely with respect to the test samples identified herein. The results set forth in this report are not indicative or representative of the quality or characteristics of the lot from which a test sample was taken or any similar or identical product unless specifically and expressly noted. Our report includes all of the tests requested by you and the results thereof based upon the information that you provided to us. You have 60 days from date of issuance of this report to notify us of any material error or omission caused by our negligence, provided, however, that such notice shall be in writing and shall specifically address the issue you wish to raise. A failure to raise such issue within the prescribed time shall constitute your unqualified acceptance of the completeness of this report, the tests conducted and the correctness of the report contents. Unless specific mention, the uncertainty of measurement has been explicitly taken into account to declare the compliance or non-compliance to the specification. The report must not be used by the client to claim product certification, approval, or endorsement by TAF or any government agencies.

## Table of Contents

<b>Release Control Record .....</b>	<b>4</b>
<b>1 Certificate of Conformity .....</b>	<b>5</b>
<b>2 Summary of Test Results .....</b>	<b>6</b>
2.1 Measurement Uncertainty .....	6
2.2 Modification Record .....	6
<b>3 General Information .....</b>	<b>7</b>
3.1 General Description of EUT .....	7
3.2 Description of Test Modes .....	10
3.2.1 Test Mode Applicability and Tested Channel Detail .....	11
3.3 Duty Cycle of Test Signal .....	13
3.4 Description of Support Units .....	14
3.4.1 Configuration of System under Test .....	15
3.5 General Description of Applied Standard .....	16
<b>4 Test Types and Results .....</b>	<b>17</b>
4.1 Radiated Emission and Bandedge Measurement .....	17
4.1.1 Limits of Radiated Emission and Bandedge Measurement .....	17
4.1.2 Test Instruments .....	18
4.1.3 Test Procedure .....	19
4.1.4 Deviation from Test Standard .....	19
4.1.5 Test Setup .....	20
4.1.6 EUT Operating Condition .....	20
4.1.7 Test Results .....	21
4.2 Conducted Emission Measurement .....	40
4.2.1 Limits of Conducted Emission Measurement .....	40
4.2.2 Test Instruments .....	40
4.2.3 Test Procedure .....	41
4.2.4 Deviation from Test Standard .....	41
4.2.5 Test Setup .....	41
4.2.6 EUT Operating Condition .....	41
4.2.7 Test Results .....	42
4.3 Transmit Power Measurement .....	44
4.3.1 Limits of Transmit Power Measurement .....	44
4.3.2 Test Setup .....	44
4.3.3 Test Instruments .....	44
4.3.4 Test Procedure .....	44
4.3.5 Deviation from Test Standard .....	44
4.3.6 EUT Operating Condition .....	45
4.3.7 Test Result .....	46
4.4 Occupied Bandwidth Measurement .....	50
4.4.1 Test Setup .....	50
4.4.2 Test Instruments .....	50
4.4.3 Test Procedure .....	50
4.4.4 Test Results .....	50
4.5 Peak Power Spectral Density Measurement .....	54
4.5.1 Limits of Peak Power Spectral Density Measurement .....	54
4.5.2 Test Setup .....	54
4.5.3 Test Instruments .....	54
4.5.4 Test Procedure .....	55
4.5.5 Deviation from Test Standard .....	55
4.5.6 EUT Operating Condition .....	55
4.5.7 Test Results .....	56
4.6 Frequency Stability Measurement .....	62
4.6.1 Limits of Frequency Stability Measurement .....	62

4.6.2	Test Setup.....	62
4.6.3	Test Instruments .....	62
4.6.4	Test Procedure .....	62
4.6.5	Deviation from Test Standard .....	62
4.6.6	EUT Operating Condition .....	62
4.6.7	Test Results .....	63
4.7	6dB Bandwidth Measurement .....	64
4.7.1	Limits of 6dB Bandwidth Measurement.....	64
4.7.2	Test Setup.....	64
4.7.3	Test Instruments .....	64
4.7.4	Test Procedure .....	64
4.7.5	Deviation from Test Standard .....	64
4.7.6	EUT Operating Condition .....	64
4.7.7	Test Results .....	65
<b>5</b>	<b>Pictures of Test Arrangements.....</b>	<b>67</b>
	<b>Annex A- Radiated Out of Band Emisison (OOBE) Measurement (For U-NII-3 band) .....</b>	<b>68</b>
	<b>Appendix – Information on the Testing Laboratories .....</b>	<b>71</b>

### Release Control Record

Issue No.	Description	Date Issued
RF160606E02-1	Original release.	July 26, 2016

## 1 Certificate of Conformity

**Product:** High Power AC1200 Dual-Band Outdoor Bridging AP

**Brand:** Luxul

**Test Model:** XWO-BAP1

**Sample Status:** ENGINEERING SAMPLE

**Applicant:** Luxul Wireless

**Test Date:** June 22 to 30, 2016

**Standard:** 47 CFR FCC Part 15, Subpart E (Section 15.407)  
ANSI C63.10: 2013

The above equipment has been tested by **Bureau Veritas Consumer Products Services (H.K.) Ltd., Taoyuan Branch**, and found compliance with the requirement of the above standards. The test record, data evaluation & Equipment Under Test (EUT) configurations represented herein are true and accurate accounts of the measurements of the sample's EMC characteristics under the conditions specified in this report.

**Prepared by :** Wendy Wu , **Date:** July 26, 2016  
Wendy Wu / Specialist

**Approved by :** May Chen , **Date:** July 26, 2016  
May Chen / Manager

## 2 Summary of Test Results

47 CFR FCC Part 15, Subpart E (Section 15.407)			
FCC Clause	Test Item	Result	Remarks
15.407(b)(6)	AC Power Conducted Emissions	Pass	Meet the requirement of limit. Minimum passing margin is -10.75dB at 0.37656MHz.
15.407(b) (1/2/3/4(i/ii)/6)	Radiated Emissions & Band Edge Measurement*	Pass	Meet the requirement of limit. Minimum passing margin is -0.3dB at 5649.75MHz.
15.407(a)(1/2/3)	Max Average Transmit Power	Pass	Meet the requirement of limit.
---	Occupied Bandwidth Measurement	Pass	Meet the requirement of limit.
15.407(a)(1/2/3)	Peak Power Spectral Density	Pass	Meet the requirement of limit.
15.407(e)	6dB bandwidth	Pass	Meet the requirement of limit. (U-NII-3 Band only)
15.407(g)	Frequency Stability	Pass	Meet the requirement of limit.
15.203	Antenna Requirement	Pass	Antenna connector is i-pex(MHF) not a standard connector.

\*For U-NII-3 band compliance with rule part 15.407(b)(4)(i), the OOB test plots were recorded in Annex A.

### 2.1 Measurement Uncertainty

Where relevant, the following measurement uncertainty levels have been estimated for tests performed on the EUT as specified in CISPR 16-4-2:

Measurement	Frequency	Expanded Uncertainty (k=2) (±)
Conducted Emissions at mains ports	150kHz ~ 30MHz	1.83 dB
Radiated Emissions up to 1 GHz	30MHz ~ 1GHz	5.19 dB
Radiated Emissions above 1 GHz	1GHz ~ 6GHz	3.43 dB
	6GHz ~ 18GHz	3.49 dB
	18GHz ~ 40GHz	4.11 dB

### 2.2 Modification Record

There were no modifications required for compliance.

### 3 General Information

#### 3.1 General Description of EUT

Product	High Power AC1200 Dual-Band Outdoor Bridging AP
Brand	Luxul
Test Model	XWO-BAP1
Status of EUT	ENGINEERING SAMPLE
Power Supply Rating	DC 56V from POE
Modulation Type	CCK, DQPSK, DBPSK for DSSS 64QAM, 16QAM, QPSK, BPSK for OFDM 256QAM for OFDM in 11ac mode
Modulation Technology	DSSS, OFDM
Transfer Rate	802.11b: up to 11Mbps 802.11a/g: up to 54Mbps 802.11n: up to 300Mbps 802.11ac: up to 866.7Mbps
Operating Frequency	<b>2.4GHz:</b> 2.412 ~ 2.462GHz <b>5GHz:</b> 5.18 ~ 5.24GHz and 5.745 ~ 5.825GHz
Number of Channel	<b>2.4GHz:</b> 802.11b, 802.11g, 802.11n (HT20): 11 802.11n (HT40): 7 <b>5GHz:</b> 802.11a, 802.11n (HT20), 802.11ac (VHT20): 9 802.11n (HT40), 802.11ac (VHT40): 4 802.11ac (VHT80): 2
Output Power	<b>2.4GHz:</b> 747.622mW <b>5GHz:</b> <b>5.18GHz ~ 5.24GHz:</b> 97.338mW <b>5.745GHz ~ 5.825GHz:</b> 395.908mW
Antenna Type	Refer to Note
Antenna Connector	Refer to Note
Accessory Device	POE x 1
Cable Supplied	Ethernet cable x1 (unshielded, 1m) Power cable x1 (unshielded, 1.8 m) grounding cable x1 (unshielded, 1.4m)

Note:

1. Simultaneously transmission condition.

Condition	Technology	
1	WLAN (2.4GHz)	WLAN (5GHz)

**Note:** The emission of the simultaneous operation has been evaluated and no non-compliance was found.

2. The antennas provided to the EUT, please refer to the following table:

2.4GHz				
Transmitter Circuit	Antenna Gain(dBi)	Frequency range (MHz ~ MHz)	Antenna Type	Connector Type
Chain (0)	6	2400~2483.5	Patch	i-pex(MHF)
Chain (1)	6			
5GHz				
Transmitter Circuit	Antenna Gain(dBi)	Frequency range (MHz ~ MHz)	Antenna Type	Connector Type
Chain (0)	10	5150~5875	Patch	i-pex(MHF)
Chain (1)	10			

3. The EUT must be supplied with a POE as following table:

Brand	Model No.	Spec.
PHIHONG	POE29U-560	Input: 100-240V, 0.8A, 50-60Hz Output: 56V, 0.536A



4. The EUT incorporates a MIMO function.

2.4GHz			
Modulation Mode	Data Rate (MCS)	TX & RX Configuration	
802.11b	1 ~ 11Mbps	2TX	2RX
802.11g	6 ~ 54Mbps	2TX	2RX
802.11n (HT20) & 802.11n (HT40)	MCS 0~7	2TX	2RX
	MCS 8~15	2TX	2RX
5GHz			
Modulation Mode	Data Rate (MCS)	TX & RX Configuration	
802.11a	6 ~ 54Mbps	2TX	2RX
802.11n (HT20)	MCS 0~7	2TX	2RX
	MCS 8~15	2TX	2RX
802.11n (HT40)	MCS 0~7	2TX	2RX
	MCS 8~15	2TX	2RX
802.11ac (VHT20)	MCS0~8 Nss= 1	2TX	2RX
	MCS0~8 Nss= 2	2TX	2RX
802.11ac (VHT40) & 802.11ac (VHT80)	MCS0~9 Nss= 1	2TX	2RX
	MCS0~9 Nss= 2	2TX	2RX

Note: 1. The modulation and bandwidth are similar for 802.11n mode for 20MHz (40MHz) and 802.11ac mode for 20MHz (40MHz), therefore investigated worst case to representative mode in test report. (Final test mode refer section 3.2.1)

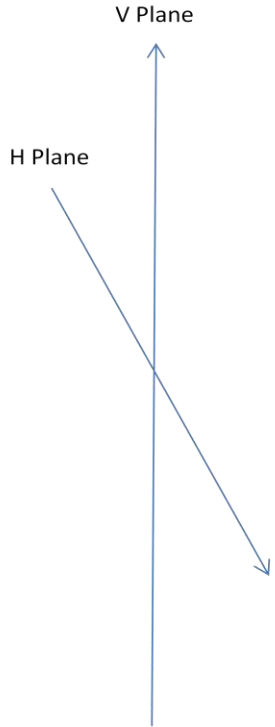

5. The EUT will install at outdoor area, the highest antenna gain from the horizon above 30 degrees as below, for more detail information please refer to antenna specification and user manual.

Antenna	Antenna gain	Antenna install degree	
Patch	0.94 dBi		

6. The above EUT information is declared by manufacturer and for more detailed features description, please refer to the manufacturer's specifications or user's manual.

### 3.2 Description of Test Modes

#### FOR 5180 ~ 5240MHz

4 channels are provided for 802.11a, 802.11n (HT20), 802.11ac (VHT20):

Channel	Frequency	Channel	Frequency
36	5180 MHz	44	5220 MHz
40	5200 MHz	48	5240 MHz

2 channels are provided for 802.11n (HT40), 802.11ac (VHT40):

Channel	Frequency	Channel	Frequency
38	5190 MHz	46	5230 MHz

1 channel is provided for 802.11ac (VHT80):

Channel	Frequency
42	5210MHz

#### FOR 5745 ~ 5825MHz:

5 channels are provided for 802.11a, 802.11n (HT20), 802.11ac (VHT20):

Channel	Frequency	Channel	Frequency
149	5745MHz	161	5805MHz
153	5765MHz	165	5825MHz
157	5785MHz		

2 channels are provided for 802.11n (HT40), 802.11ac (VHT40):

Channel	Frequency	Channel	Frequency
151	5755MHz	159	5795MHz

1 channel is provided for 802.11ac (VHT80):

Channel	Frequency
155	5775MHz

### 3.2.1 Test Mode Applicability and Tested Channel Detail

EUT Configure Mode	Applicable To				Description
	RE≥1G	RE<1G	PLC	APCM	
-	√	√	√	√	

Where **RE≥1G**: Radiated Emission above 1GHz      **RE<1G**: Radiated Emission below 1GHz  
**PLC**: Power Line Conducted Emission      **APCM**: Antenna Port Conducted Measurement

#### **Radiated Emission Test (Above 1GHz):**

- Pre-Scan has been conducted to determine the worst-case mode from all possible combinations between available modulations, data rates and antenna ports (if EUT with antenna diversity architecture).
- Following channel(s) was (were) selected for the final test as listed below.

Mode	FREQ. Band (MHz)	Available Channel	Tested Channel	Modulation Technology	Modulation Type	Data Rate (Mbps)
802.11a	5180-5240	36 to 48	36, 40, 48	OFDM	BPSK	6
802.11ac (VHT20)		36 to 48	36, 40, 48	OFDM	BPSK	6.5
802.11ac (VHT40)		38 to 46	38, 46	OFDM	BPSK	13.5
802.11ac (VHT80)		42	42	OFDM	BPSK	29.3
802.11a	5745-5825	149 to 165	149, 157, 165	OFDM	BPSK	6
802.11ac (VHT20)		149 to 165	149, 157, 165	OFDM	BPSK	6.5
802.11ac (VHT40)		151 to 159	151, 159	OFDM	BPSK	13.5
802.11ac (VHT80)		155	155	OFDM	BPSK	29.3

#### **Radiated Emission Test (Below 1GHz):**

- Pre-Scan has been conducted to determine the worst-case mode from all possible combinations between available modulations, data rates and antenna ports (if EUT with antenna diversity architecture).
- Following channel(s) was (were) selected for the final test as listed below.

Mode	FREQ. Band (MHz)	Available Channel	Tested Channel	Modulation Technology	Modulation Type	Data Rate (Mbps)
802.11ac (VHT20)	5745-5825	149 to 165	157	OFDM	BPSK	6.5

#### **Power Line Conducted Emission Test:**

- Pre-Scan has been conducted to determine the worst-case mode from all possible combinations between available modulations, data rates and antenna ports (if EUT with antenna diversity architecture).
- Following channel(s) was (were) selected for the final test as listed below.

Mode	FREQ. Band (MHz)	Available Channel	Tested Channel	Modulation Technology	Modulation Type	Data Rate (Mbps)
802.11ac (VHT20)	5745-5825	149 to 165	157	OFDM	BPSK	6.5

### Antenna Port Conducted Measurement:

- This item includes all test value of each mode, but only includes spectrum plot of worst value of each mode.
- Pre-Scan has been conducted to determine the worst-case mode from all possible combinations between available modulations, data rates and antenna ports (if EUT with antenna diversity architecture).
- Following channel(s) was (were) selected for the final test as listed below.

Mode	FREQ. Band (MHz)	Available Channel	Tested Channel	Modulation Technology	Modulation Type	Data Rate (Mbps)
802.11a	5180-5240	36 to 48	36, 40, 48	OFDM	BPSK	6
802.11ac (VHT20)		36 to 48	36, 40, 48	OFDM	BPSK	6.5
802.11ac (VHT40)		38 to 46	38, 46	OFDM	BPSK	13.5
802.11ac (VHT80)		42	42	OFDM	BPSK	29.3
802.11a	5745-5825	149 to 165	149, 157, 165	OFDM	BPSK	6
802.11ac (VHT20)		149 to 165	149, 157, 165	OFDM	BPSK	6.5
802.11ac (VHT40)		151 to 159	151, 159	OFDM	BPSK	13.5
802.11ac (VHT80)		155	155	OFDM	BPSK	29.3

### Test Condition:

Applicable To	Environmental Conditions	Input Power	Tested By
RE $\geq$ 1G	25deg. C, 60%RH	120Vac, 60Hz	Russell Yeh
RE $<$ 1G	25deg. C, 60%RH	120Vac, 60Hz	Russell Yeh
PLC	24deg. C, 61%RH	120Vac, 60Hz	Jyunchun Lin
APCM	25deg. C, 60%RH	120Vac, 60Hz	Jyunchun Lin

### 3.3 Duty Cycle of Test Signal

If duty cycle of test signal is  $\geq 98\%$ , duty factor is not required.

If duty cycle of test signal is  $< 98\%$ , duty factor shall be considered.

**802.11a:** Duty cycle =  $5.348 \text{ ms} / 5.438 \text{ ms} = 0.983$

**802.11ac (VHT20):** Duty cycle =  $4.965 \text{ ms} / 5.04 \text{ ms} = 0.985$

**802.11ac (VHT40):** Duty cycle =  $2.413 \text{ ms} / 2.596 \text{ ms} = 0.93$ , Duty factor =  $10 * \log(1/0.93) = 0.32$

**802.11ac (VHT80):** Duty cycle =  $1.134 \text{ ms} / 1.208 \text{ ms} = 0.939$ , Duty factor =  $10 * \log(1/0.939) = 0.27$

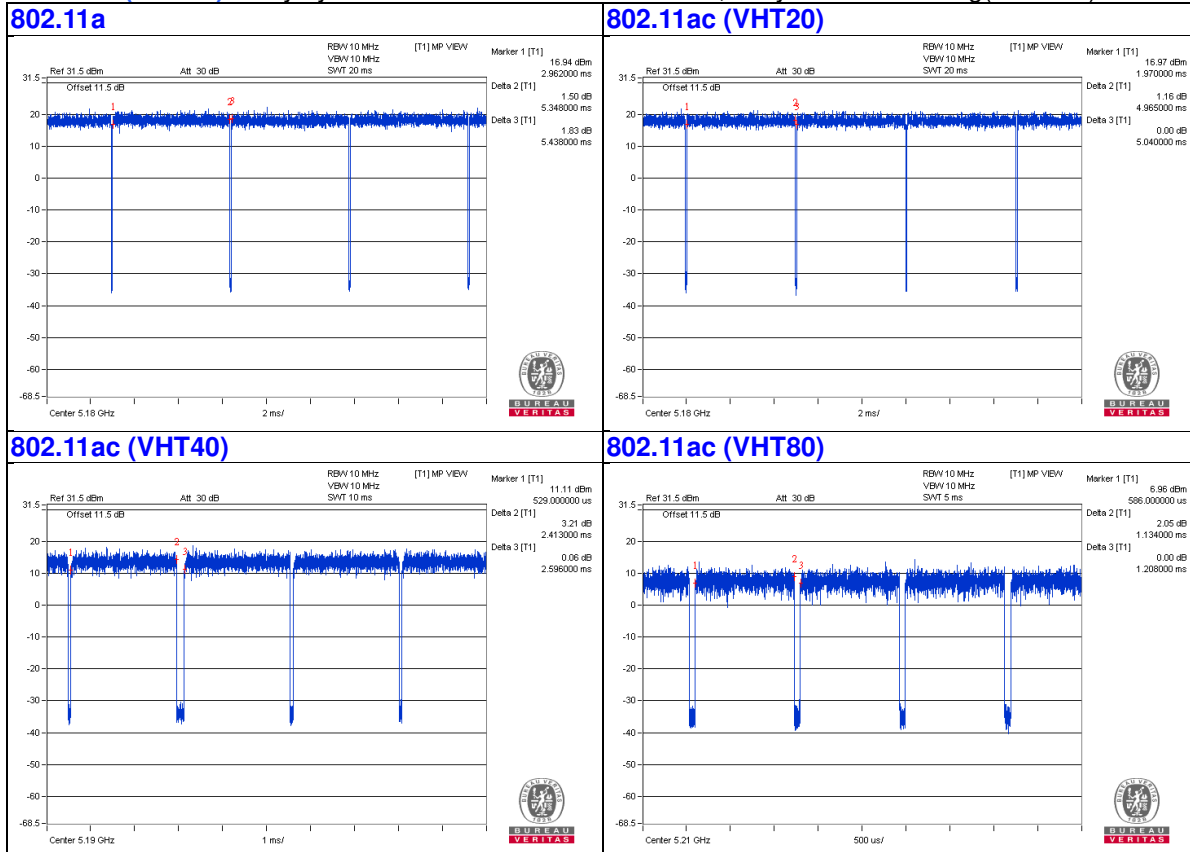

### 3.4 Description of Support Units

The EUT has been tested as an independent unit together with other necessary accessories or support units. The following support units or accessories were used to form a representative test configuration during the tests.

ID	Product	Brand	Model No.	Serial No.	FCC ID	Remarks
A.	Notebook Computer	DELL	E5430	HYV4VY1	FCC DoC	Provided by Lab

Note:

1. All power cords of the above support units are non-shielded (1.8m).

ID	Descriptions	Qty.	Length (m)	Shielding (Yes/No)	Cores (Qty.)	Remarks
1.	RJ-45 Cable	1	10	No	0	Provided by Lab
2.	RJ-45 Cable	1	1	No	0	Supplied by client
3.	AC Cable	1	1.8	No	0	Supplied by client
4.	Ground Cable	1	1.4	No	0	Supplied by client
5.	Ground Cable	1	2	No	0	Provided by Lab

### 3.4.1 Configuration of System under Test

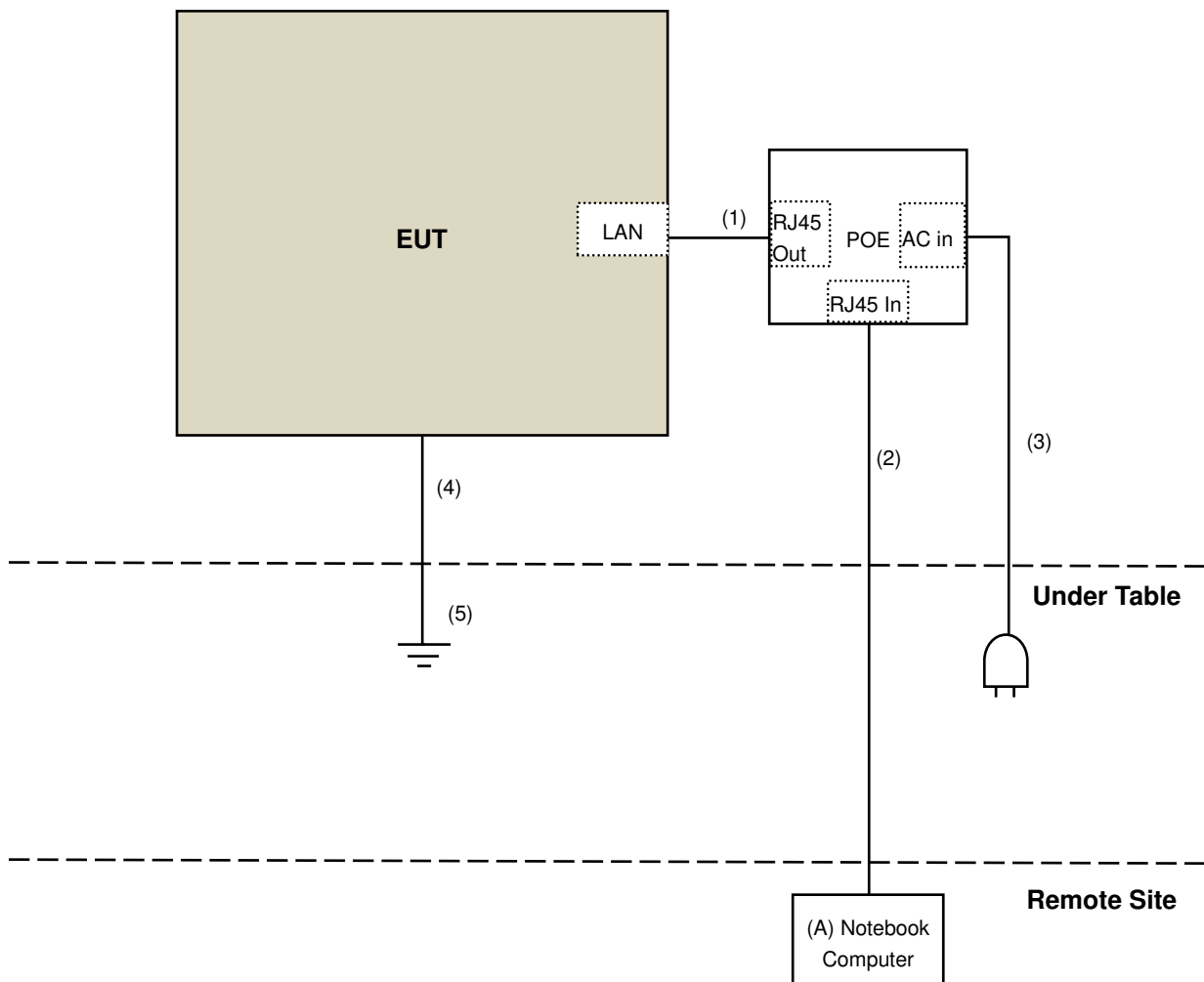

### 3.5 General Description of Applied Standard

The EUT is a RF Product. According to the specifications of the manufacturer, it must comply with the requirements of the following standards:

**FCC Part 15, Subpart E (15.407)**  
**KDB 789033 D02 General UNII Test Procedure New Rules v01r02**  
**KDB 662911 D01 Multiple Transmitter Output v02r01**  
**ANSI C63.10-2013**

All test items have been performed and recorded as per the above standards.

**NOTE:** The EUT has been verified to comply with the requirements of FCC Part 15, Subpart B, Class B (DoC). The test report has been issued separately.



## 4 Test Types and Results

### 4.1 Radiated Emission and Bandedge Measurement

#### 4.1.1 Limits of Radiated Emission and Bandedge Measurement

Radiated emissions which fall in the restricted bands must comply with the radiated emission limits specified as below table.

Frequencies (MHz)	Field Strength (microvolts/meter)	Measurement Distance (meters)
0.009 ~ 0.490	2400/F(kHz)	300
0.490 ~ 1.705	24000/F(kHz)	30
1.705 ~ 30.0	30	30
30 ~ 88	100	3
88 ~ 216	150	3
216 ~ 960	200	3
Above 960	500	3

#### NOTE:

- The lower limit shall apply at the transition frequencies.
- Emission level (dBuV/m) = 20 log Emission level (uV/m).
- For frequencies above 1000MHz, the field strength limits are based on average detector, however, the peak field strength of any emission shall not exceed the maximum permitted average limits, specified above by more than 20dB under any condition of modulation.

Limits of unwanted emission out of the restricted bands

Applicable To		Limit	
789033 D02 General UNII Test Procedure New Rules v01r02		Field Strength at 3m	
		PK:74 (dBμV/m)	AV:54 (dBμV/m)
Frequency Band	Applicable To	EIRP Limit	Equivalent Field Strength at 3m
5150~5250 MHz	15.407(b)(1)	PK:-27 (dBm/MHz)	PK:68.2(dBμV/m)
5250~5350 MHz	15.407(b)(2)		
5470~5725 MHz	15.407(b)(3)		
5725~5850 MHz	<input checked="" type="checkbox"/> 15.407(b)(4)(i)	PK:-27 (dBm/MHz) <sup>*1</sup> PK:10 (dBm/MHz) <sup>*2</sup> PK:15.6 (dBm/MHz) <sup>*3</sup> PK:27 (dBm/MHz) <sup>*4</sup>	PK: 68.2(dBμV/m) <sup>*1</sup> PK:105.2 (dBμV/m) <sup>*2</sup> PK: 110.8(dBμV/m) <sup>*3</sup> PK:122.2 (dBμV/m) <sup>*4</sup>
	<input type="checkbox"/> 15.407(b)(4)(ii)	Emission limits in section 15.247(d)	
<sup>*1</sup> beyond 75 MHz or more above of the band edge.		<sup>*2</sup> below the band edge increasing linearly to 10 dBm/MHz at 25 MHz above.	
<sup>*3</sup> below the band edge increasing linearly to a level of 15.6 dBm/MHz at 5 MHz above.		<sup>*4</sup> from 5 MHz above or below the band edge increasing linearly to a level of 27 dBm/MHz at the band edge.	

#### Note:

The following formula is used to convert the equipment isotropic radiated power (eirp) to field strength:

$$E = \frac{1000000\sqrt{30P}}{3} \mu\text{V/m, where P is the eirp (Watts).}$$

## 4.1.2 Test Instruments

DESCRIPTION & MANUFACTURER	MODEL NO.	SERIAL NO.	CALIBRATED DATE	CALIBRATED UNTIL
Test Receiver Agilent	N9038A	MY54450088	July 24, 2015	July 23, 2016
Pre-Amplifier <sup>(*)</sup> EMCI	EMC001340	980142	Jan. 20, 2016	Jan. 19, 2018
Loop Antenna <sup>(*)</sup> Electro-Metrics	EM-6879	264	Dec. 16, 2014	Dec. 15, 2016
RF Cable	NA	LOOPCAB-001 LOOPCAB-002	Jan. 18, 2016	Jan. 17, 2017
Pre-Amplifier Mini-Circuits	ZFL-1000VH2B	AMP-ZFL-01	Nov. 11, 2015	Nov. 10, 2016
Trilog Broadband Antenna SCHWARZBECK	VULB 9168	9168-406	Jan. 04, 2016	Jan. 03, 2017
RF Cable	8D	966-4-1 966-4-2 966-4-3	Apr. 02, 2016	Apr. 01, 2017
Horn_Antenna SCHWARZBECK	BBHA 9120D	9120D-783	Jan. 19, 2016	Jan. 18, 2017
Pre-Amplifier Agilent	8449B	3008A01922	Sep. 19, 2015	Sep. 18, 2016
RF Cable	EMC104-SM-SM-2000 EMC104-SM-SM-5000 EMC104-SM-SM-5000	150318 150323 150324	Mar. 30, 2016	Mar. 29, 2017
Pre-Amplifier EMCI	EMC184045	980143	Jan. 15, 2016	Jan. 14, 2017
Horn_Antenna SCHWARZBECK	BBHA 9170	BBHA9170608	Jan. 08, 2016	Jan. 07, 2017
RF Cable	SUCOFLEX 102	36432/2 36441/2	Jan. 16, 2016	Jan. 15, 2017
Software	ADT_Radiated_V8.7.07	NA	NA	NA
Antenna Tower & Turn Table Max-Full	MF-7802	MF780208410	NA	NA
Boresight Antenna Fixture	FBA-01	FBA-SIP02	NA	NA
Spectrum Analyzer R&S	FSP40	100060	May 11, 2016	May 10, 2017
Power meter Anritsu	ML2495A	1014008	May 5, 2016	May 4, 2017
Power sensor Anritsu	MA2411B	0917122	May 5, 2016	May 4, 2017
AC Power Source Extech Electronics	6205	1440452	NA	NA
Temperature & Humidity Chamber Giant Force	GTH-150-40-SP-AR	MAA0812-008	Jan. 15, 2016	Jan. 14, 2017
Digital Multimeter FLUKE	87III	73680266	Nov. 10, 2015	Nov. 09, 2016

**Note:**

1. The calibration interval of the above test instruments is 12 months and the calibrations are traceable to NML/ROC and NIST/USA.
2. \*The calibration interval of the above test instruments is 24 months and the calibrations are traceable to NML/ROC and NIST/USA.
3. Loop antenna was used for all emissions below 30 MHz.
4. The test was performed in 966 Chamber No. 4.
5. The FCC Site Registration No. is 292998
6. The CANADA Site Registration No. is 20331-2
7. Tested Date: June 22 to 30, 2016

#### 4.1.3 Test Procedure

- a. The EUT was placed on the top of a rotating table 0.8 meters (for below 1GHz) / 1.5 meters (for above 1GHz) above the ground at 3 meter chamber room for test. The table was rotated 360 degrees to determine the position of the highest radiation.
- b. The EUT was set 3 meters away from the interference-receiving antenna, which was mounted on the top of a variable-height antenna tower.
- c. The height of antenna is varied from one meter to four meters above the ground to determine the maximum value of the field strength. Both horizontal and vertical polarizations of the antenna are set to make the measurement.
- d. For each suspected emission, the EUT was arranged to its worst case and then the antenna was tuned to heights from 1 meter to 4 meters and the rotatable table was turned from 0 degrees to 360 degrees to find the maximum reading.
- e. The test-receiver system was set to quasi-peak detect function and specified bandwidth with maximum hold mode when the test frequency is below 1 GHz.
- f. The test-receiver system was set to peak and average detect function and specified bandwidth with maximum hold mode when the test frequency is above 1 GHz. If the peak reading value also meets average limit, measurement with the average detector is unnecessary.

**Note:**

1. The resolution bandwidth and video bandwidth of test receiver/spectrum analyzer is 120kHz for Quasi-peak detection (QP) at frequency below 1GHz.
2. The resolution bandwidth of test receiver/spectrum analyzer is 1 MHz and the video bandwidth is 3 MHz for Peak detection (PK) at frequency above 1GHz.
3. The resolution bandwidth of test receiver/spectrum analyzer is 1MHz and the video bandwidth is 3MHz for RMS Average (Duty cycle < 98%) for Average detection (AV) at frequency above 1GHz, then the measurement results was added to a correction factor ( $10 \log(1/\text{duty cycle})$ ).
4. The resolution bandwidth of test receiver/spectrum analyzer is 1MHz and the video bandwidth is 10Hz (Duty cycle  $\geq 98\%$ ) for Average detection (AV) at frequency above 1GHz.
5. All modes of operation were investigated and the worst-case emissions are reported.

#### 4.1.4 Deviation from Test Standard

No deviation.

#### 4.1.5 Test Setup

##### <Frequency Range below 1GHz>

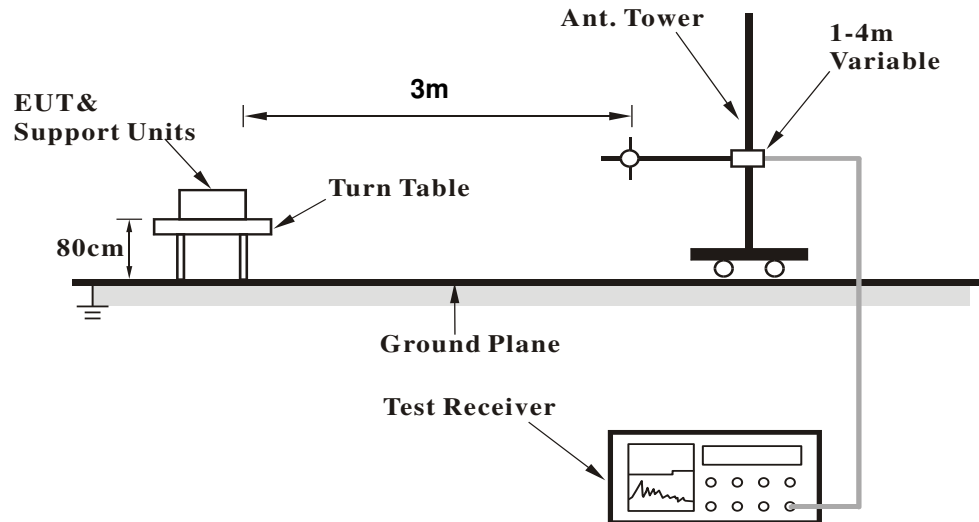

##### <Frequency Range above 1GHz>

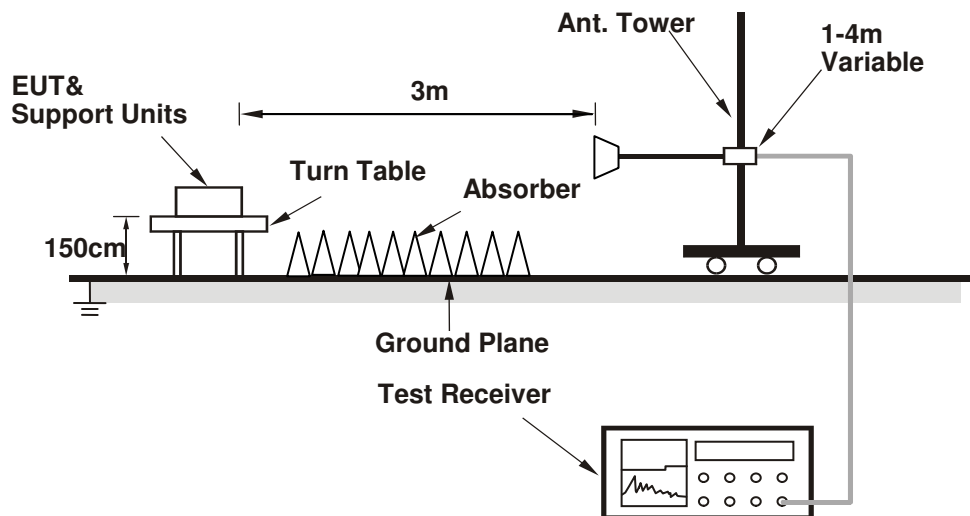

For the actual test configuration, please refer to the attached file (Test Setup Photo).

#### 4.1.6 EUT Operating Condition

1. Connect the EUT with the Notebook Computer which is placed on remote site.
2. Controlling software (artgui.exe[art2 ver 4 9 802 1]) has been activated to set the EUT on specific status.

## 4.1.7 Test Results

## Above 1GHz Data:

## 802.11a

<b>CHANNEL</b>	TX Channel 36	<b>DETECTOR FUNCTION</b>	Peak (PK)
<b>FREQUENCY RANGE</b>	1GHz ~ 40GHz		Average (AV)

**ANTENNA POLARITY & TEST DISTANCE: HORIZONTAL AT 3 M**

NO.	FREQ. (MHz)	EMISSION LEVEL (dBuV/m)	LIMIT (dBuV/m)	MARGIN (dB)	ANTENNA HEIGHT (m)	TABLE ANGLE (Degree)	RAW VALUE (dBuV)	CORRECTION FACTOR (dB/m)
1	5150.00	66.8 PK	74.0	-7.2	1.91 H	8	65.2	1.6
2	5150.00	53.2 AV	54.0	-0.8	1.91 H	8	51.6	1.6
3	*5180.00	122.2 PK			1.91 H	8	120.5	1.7
4	*5180.00	110.1 AV			1.91 H	8	108.4	1.7
5	#10360.00	51.3 PK	74.0	-22.7	1.80 H	74	39.6	11.7
6	#10360.00	37.2 AV	54.0	-16.8	1.80 H	74	25.5	11.7
7	15540.00	52.7 PK	74.0	-21.3	2.59 H	213	39.4	13.3
8	15540.00	40.2 AV	54.0	-13.8	2.59 H	213	26.9	13.3

**ANTENNA POLARITY & TEST DISTANCE: VERTICAL AT 3 M**

NO.	FREQ. (MHz)	EMISSION LEVEL (dBuV/m)	LIMIT (dBuV/m)	MARGIN (dB)	ANTENNA HEIGHT (m)	TABLE ANGLE (Degree)	RAW VALUE (dBuV)	CORRECTION FACTOR (dB/m)
1	5150.00	64.3 PK	74.0	-9.7	1.77 V	10	62.7	1.6
2	5150.00	49.6 AV	54.0	-4.4	1.77 V	10	48.0	1.6
3	*5180.00	120.4 PK			1.77 V	10	118.7	1.7
4	*5180.00	108.2 AV			1.77 V	10	106.5	1.7
5	#10360.00	51.8 PK	74.0	-22.2	2.70 V	162	40.1	11.7
6	#10360.00	39.3 AV	54.0	-14.7	2.70 V	162	27.6	11.7
7	15540.00	54.4 PK	74.0	-19.6	2.47 V	148	41.1	13.3
8	15540.00	41.6 AV	54.0	-12.4	2.47 V	148	28.3	13.3

**REMARKS:**

1. Emission Level(dBuV/m) = Raw Value(dBuV) + Correction Factor(dB/m)
2. Correction Factor(dB/m) = Antenna Factor(dB/m) + Cable Factor(dB) – Pre-Amplifier Factor(dB)
3. The other emission levels were very low against the limit.
4. Margin value = Emission Level – Limit value
5. " \* ": Fundamental frequency.
6. " # ": The radiated frequency is out of the restricted band.

<b>CHANNEL</b>	TX Channel 40	<b>DETECTOR FUNCTION</b>	Peak (PK)
<b>FREQUENCY RANGE</b>	1GHz ~ 40GHz		Average (AV)

**ANTENNA POLARITY & TEST DISTANCE: HORIZONTAL AT 3 M**

NO.	FREQ. (MHz)	EMISSION LEVEL (dBuV/m)	LIMIT (dBuV/m)	MARGIN (dB)	ANTENNA HEIGHT (m)	TABLE ANGLE (Degree)	RAW VALUE (dBuV)	CORRECTION FACTOR (dB/m)
1	5150.00	70.0 PK	74.0	-4.0	2.16 H	3	68.4	1.6
2	5150.00	53.3 AV	54.0	-0.7	2.16 H	3	51.7	1.6
3	*5200.00	125.7 PK			2.16 H	3	123.9	1.8
4	*5200.00	113.8 AV			2.16 H	3	112.0	1.8
5	5350.00	65.3 PK	74.0	-8.7	2.16 H	3	63.2	2.1
6	5350.00	51.6 AV	54.0	-2.4	2.16 H	3	49.5	2.1
7	#10400.00	51.5 PK	74.0	-22.5	1.99 H	54	39.6	11.9
8	#10400.00	38.6 AV	54.0	-15.4	1.99 H	54	26.7	11.9
9	15600.00	52.8 PK	74.0	-21.2	2.04 H	200	39.5	13.3
10	15600.00	39.9 AV	54.0	-14.1	2.04 H	200	26.6	13.3

**ANTENNA POLARITY & TEST DISTANCE: VERTICAL AT 3 M**

NO.	FREQ. (MHz)	EMISSION LEVEL (dBuV/m)	LIMIT (dBuV/m)	MARGIN (dB)	ANTENNA HEIGHT (m)	TABLE ANGLE (Degree)	RAW VALUE (dBuV)	CORRECTION FACTOR (dB/m)
1	5150.00	68.8 PK	74.0	-5.2	1.82 V	15	67.2	1.6
2	5150.00	49.2 AV	54.0	-4.8	1.82 V	15	47.6	1.6
3	*5200.00	122.6 PK			1.82 V	15	120.8	1.8
4	*5200.00	111.4 AV			1.82 V	15	109.6	1.8
5	5350.00	62.3 PK	74.0	-11.7	1.82 V	15	60.2	2.1
6	5350.00	47.3 AV	54.0	-6.7	1.82 V	15	45.2	2.1
7	#10400.00	52.4 PK	74.0	-21.6	2.79 V	159	40.5	11.9
8	#10400.00	39.8 AV	54.0	-14.2	2.79 V	159	27.9	11.9
9	15600.00	54.8 PK	74.0	-19.2	2.38 V	141	41.5	13.3
10	15600.00	41.9 AV	54.0	-12.1	2.38 V	141	28.6	13.3

**REMARKS:**

1. Emission Level(dBuV/m) = Raw Value(dBuV) + Correction Factor(dB/m)
2. Correction Factor(dB/m) = Antenna Factor(dB/m) + Cable Factor(dB) – Pre-Amplifier Factor(dB)
3. The other emission levels were very low against the limit.
4. Margin value = Emission Level – Limit value
5. " \* ": Fundamental frequency.
6. " # ": The radiated frequency is out of the restricted band.

<b>CHANNEL</b>	TX Channel 48	<b>DETECTOR FUNCTION</b>	Peak (PK)
<b>FREQUENCY RANGE</b>	1GHz ~ 40GHz		Average (AV)

**ANTENNA POLARITY & TEST DISTANCE: HORIZONTAL AT 3 M**

NO.	FREQ. (MHz)	EMISSION LEVEL (dBuV/m)	LIMIT (dBuV/m)	MARGIN (dB)	ANTENNA HEIGHT (m)	TABLE ANGLE (Degree)	RAW VALUE (dBuV)	CORRECTION FACTOR (dB/m)
1	*5240.00	127.1 PK			2.14 H	5	125.3	1.8
2	*5240.00	115.2 AV			2.14 H	5	113.4	1.8
3	5350.00	64.3 PK	74.0	-9.7	2.14 H	5	62.2	2.1
4	5350.00	51.5 AV	54.0	-2.5	2.14 H	5	49.4	2.1
5	#10480.00	52.8 PK	74.0	-21.2	2.06 H	66	40.6	12.2
6	#10480.00	39.2 AV	54.0	-14.8	2.06 H	66	27.0	12.2
7	15720.00	53.3 PK	74.0	-20.7	2.04 H	200	40.1	13.2
8	15720.00	41.8 AV	54.0	-12.2	2.04 H	200	28.6	13.2

**ANTENNA POLARITY & TEST DISTANCE: VERTICAL AT 3 M**

NO.	FREQ. (MHz)	EMISSION LEVEL (dBuV/m)	LIMIT (dBuV/m)	MARGIN (dB)	ANTENNA HEIGHT (m)	TABLE ANGLE (Degree)	RAW VALUE (dBuV)	CORRECTION FACTOR (dB/m)
1	*5240.00	124.3 PK			1.73 V	18	122.5	1.8
2	*5240.00	112.4 AV			1.73 V	18	110.6	1.8
3	5350.00	62.4 PK	74.0	-11.6	1.73 V	18	60.3	2.1
4	5350.00	48.1 AV	54.0	-5.9	1.73 V	18	46.0	2.1
5	#10480.00	52.5 PK	74.0	-21.5	2.62 V	168	40.3	12.2
6	#10480.00	38.8 AV	54.0	-15.2	2.62 V	168	26.6	12.2
7	15720.00	53.1 PK	74.0	-20.9	2.55 V	153	39.9	13.2
8	15720.00	41.5 AV	54.0	-12.5	2.55 V	153	28.3	13.2

**REMARKS:**

1. Emission Level(dBuV/m) = Raw Value(dBuV) + Correction Factor(dB/m)
2. Correction Factor(dB/m) = Antenna Factor(dB/m) + Cable Factor(dB) – Pre-Amplifier Factor(dB)
3. The other emission levels were very low against the limit.
4. Margin value = Emission Level – Limit value
5. " \* ": Fundamental frequency.
6. " # ": The radiated frequency is out of the restricted band.

<b>CHANNEL</b>	TX Channel 149	<b>DETECTOR FUNCTION</b>	Peak (PK)
<b>FREQUENCY RANGE</b>	1GHz ~ 40GHz		Average (AV)

**ANTENNA POLARITY & TEST DISTANCE: HORIZONTAL AT 3 M**

NO.	FREQ. (MHz)	EMISSION LEVEL (dBuV/m)	LIMIT (dBuV/m)	MARGIN (dB)	ANTENNA HEIGHT (m)	TABLE ANGLE (Degree)	RAW VALUE (dBuV)	CORRECTION FACTOR (dB/m)
1	#5629.32	63.1 PK	68.2	-5.1	2.05 H	2	60.5	2.6
2	*5745.00	124.7 PK			2.05 H	2	121.9	2.8
3	*5745.00	112.8 AV			2.05 H	2	110.0	2.8
4	#5954.23	61.4 PK	68.2	-6.8	2.05 H	2	58.2	3.2
5	11490.00	66.9 PK	74.0	-7.1	1.65 H	63	53.4	13.5
6	11490.00	53.5 AV	54.0	-0.5	1.65 H	63	40.0	13.5
7	#17235.00	60.2 PK	74.0	-13.8	2.50 H	203	41.8	18.4
8	#17235.00	46.8 AV	54.0	-7.2	2.50 H	203	28.4	18.4

**ANTENNA POLARITY & TEST DISTANCE: VERTICAL AT 3 M**

NO.	FREQ. (MHz)	EMISSION LEVEL (dBuV/m)	LIMIT (dBuV/m)	MARGIN (dB)	ANTENNA HEIGHT (m)	TABLE ANGLE (Degree)	RAW VALUE (dBuV)	CORRECTION FACTOR (dB/m)
1	#5641.20	62.7 PK	68.2	-5.5	2.18 V	6	60.1	2.6
2	*5745.00	123.1 PK			2.18 V	6	120.3	2.8
3	*5745.00	112.0 AV			2.18 V	6	109.2	2.8
4	#5957.55	61.0 PK	68.2	-7.2	2.18 V	6	57.8	3.2
5	11490.00	67.8 PK	74.0	-6.2	1.39 V	23	54.3	13.5
6	11490.00	52.2 AV	54.0	-1.8	1.39 V	23	38.7	13.5
7	#17235.00	57.1 PK	74.0	-16.9	2.66 V	173	38.7	18.4
8	#17235.00	44.4 AV	54.0	-9.6	2.66 V	173	26.0	18.4

**REMARKS:**

1. Emission Level(dBuV/m) = Raw Value(dBuV) + Correction Factor(dB/m)
2. Correction Factor(dB/m) = Antenna Factor(dB/m) + Cable Factor(dB) – Pre-Amplifier Factor(dB)
3. The other emission levels were very low against the limit.
4. Margin value = Emission Level – Limit value
5. " \* ": Fundamental frequency.
6. " # ": The radiated frequency is out of the restricted band.



<b>CHANNEL</b>	TX Channel 157	<b>DETECTOR FUNCTION</b>	Peak (PK)
<b>FREQUENCY RANGE</b>	1GHz ~ 40GHz		Average (AV)

**ANTENNA POLARITY & TEST DISTANCE: HORIZONTAL AT 3 M**

NO.	FREQ. (MHz)	EMISSION LEVEL (dBuV/m)	LIMIT (dBuV/m)	MARGIN (dB)	ANTENNA HEIGHT (m)	TABLE ANGLE (Degree)	RAW VALUE (dBuV)	CORRECTION FACTOR (dB/m)
1	#5631.70	65.9 PK	68.2	-2.3	2.14 H	1	63.3	2.6
2	*5785.00	126.0 PK			2.14 H	1	123.1	2.9
3	*5785.00	113.9 AV			2.14 H	1	111.0	2.9
4	#5965.62	66.5 PK	68.2	-1.7	2.14 H	1	63.3	3.2
5	11570.00	65.6 PK	74.0	-8.4	1.56 H	65	52.4	13.2
6	11570.00	52.6 AV	54.0	-1.4	1.56 H	65	39.4	13.2
7	#17355.00	58.8 PK	74.0	-15.2	2.55 H	208	39.7	19.1
8	#17355.00	46.2 AV	54.0	-7.8	2.55 H	208	27.1	19.1

**ANTENNA POLARITY & TEST DISTANCE: VERTICAL AT 3 M**

NO.	FREQ. (MHz)	EMISSION LEVEL (dBuV/m)	LIMIT (dBuV/m)	MARGIN (dB)	ANTENNA HEIGHT (m)	TABLE ANGLE (Degree)	RAW VALUE (dBuV)	CORRECTION FACTOR (dB/m)
1	#5622.68	63.9 PK	68.2	-4.3	2.14 V	7	61.3	2.6
2	*5785.00	125.1 PK			2.14 V	7	122.2	2.9
3	*5785.00	113.2 AV			2.14 V	7	110.3	2.9
4	#5939.50	61.7 PK	68.2	-6.5	2.14 V	7	58.6	3.1
5	11570.00	64.4 PK	74.0	-9.6	1.43 V	21	51.2	13.2
6	11570.00	50.0 AV	54.0	-4.0	1.43 V	21	36.8	13.2
7	#17355.00	56.7 PK	74.0	-17.3	2.55 V	170	37.6	19.1
8	#17355.00	44.2 AV	54.0	-9.8	2.55 V	170	25.1	19.1

**REMARKS:**

1. Emission Level(dBuV/m) = Raw Value(dBuV) + Correction Factor(dB/m)
2. Correction Factor(dB/m) = Antenna Factor(dB/m) + Cable Factor(dB) – Pre-Amplifier Factor(dB)
3. The other emission levels were very low against the limit.
4. Margin value = Emission Level – Limit value
5. " \* ": Fundamental frequency.
6. " # ": The radiated frequency is out of the restricted band.

<b>CHANNEL</b>	TX Channel 165	<b>DETECTOR FUNCTION</b>	Peak (PK)
<b>FREQUENCY RANGE</b>	1GHz ~ 40GHz		Average (AV)

**ANTENNA POLARITY & TEST DISTANCE: HORIZONTAL AT 3 M**

NO.	FREQ. (MHz)	EMISSION LEVEL (dBuV/m)	LIMIT (dBuV/m)	MARGIN (dB)	ANTENNA HEIGHT (m)	TABLE ANGLE (Degree)	RAW VALUE (dBuV)	CORRECTION FACTOR (dB/m)
1	#5649.75	67.9 PK	68.2	-0.3	2.10 H	2	65.3	2.6
2	*5825.00	126.3 PK			2.10 H	2	123.4	2.9
3	*5825.00	114.0 AV			2.10 H	2	111.1	2.9
4	#5934.27	67.0 PK	68.2	-1.2	2.10 H	2	63.9	3.1
5	11650.00	63.3 PK	74.0	-10.7	1.58 H	65	50.1	13.2
6	11650.00	49.5 AV	54.0	-4.5	1.58 H	65	36.3	13.2
7	#17475.00	56.2 PK	74.0	-17.8	2.46 H	211	36.8	19.4
8	#17475.00	46.1 AV	54.0	-7.9	2.46 H	211	26.7	19.4

**ANTENNA POLARITY & TEST DISTANCE: VERTICAL AT 3 M**

NO.	FREQ. (MHz)	EMISSION LEVEL (dBuV/m)	LIMIT (dBuV/m)	MARGIN (dB)	ANTENNA HEIGHT (m)	TABLE ANGLE (Degree)	RAW VALUE (dBuV)	CORRECTION FACTOR (dB/m)
1	#5616.50	64.7 PK	68.2	-3.5	2.18 V	10	62.1	2.6
2	*5825.00	125.3 PK			2.18 V	10	122.4	2.9
3	*5825.00	113.7 AV			2.18 V	10	110.8	2.9
4	#5941.40	62.7 PK	68.2	-5.5	2.18 V	10	59.6	3.1
5	11650.00	62.4 PK	74.0	-11.6	1.55 V	22	49.2	13.2
6	11650.00	48.2 AV	54.0	-5.8	1.55 V	22	35.0	13.2
7	#17475.00	55.8 PK	74.0	-18.2	2.46 V	178	36.4	19.4
8	#17475.00	44.0 AV	54.0	-10.0	2.46 V	178	24.6	19.4

**REMARKS:**

1. Emission Level(dBuV/m) = Raw Value(dBuV) + Correction Factor(dB/m)
2. Correction Factor(dB/m) = Antenna Factor(dB/m) + Cable Factor(dB) – Pre-Amplifier Factor(dB)
3. The other emission levels were very low against the limit.
4. Margin value = Emission Level – Limit value
5. " \* ": Fundamental frequency.
6. " # ": The radiated frequency is out of the restricted band.

802.11ac (VHT20)

<b>CHANNEL</b>	TX Channel 36	<b>DETECTOR FUNCTION</b>	Peak (PK)
<b>FREQUENCY RANGE</b>	1GHz ~ 40GHz		Average (AV)

ANTENNA POLARITY & TEST DISTANCE: HORIZONTAL AT 3 M								
NO.	FREQ. (MHz)	EMISSION LEVEL (dBuV/m)	LIMIT (dBuV/m)	MARGIN (dB)	ANTENNA HEIGHT (m)	TABLE ANGLE (Degree)	RAW VALUE (dBuV)	CORRECTION FACTOR (dB/m)
1	5150.00	69.0 PK	74.0	-5.0	1.71 H	2	67.4	1.6
2	5150.00	53.4 AV	54.0	-0.6	1.71 H	2	51.8	1.6
3	*5180.00	120.9 PK			1.71 H	2	119.2	1.7
4	*5180.00	110.7 AV			1.71 H	2	109.0	1.7
5	#10360.00	51.5 PK	74.0	-22.5	1.78 H	72	39.8	11.7
6	#10360.00	37.8 AV	54.0	-16.2	1.78 H	72	26.1	11.7
7	15540.00	52.4 PK	74.0	-21.6	2.55 H	214	39.1	13.3
8	15540.00	39.6 AV	54.0	-14.4	2.55 H	214	26.3	13.3

ANTENNA POLARITY & TEST DISTANCE: VERTICAL AT 3 M								
NO.	FREQ. (MHz)	EMISSION LEVEL (dBuV/m)	LIMIT (dBuV/m)	MARGIN (dB)	ANTENNA HEIGHT (m)	TABLE ANGLE (Degree)	RAW VALUE (dBuV)	CORRECTION FACTOR (dB/m)
1	5150.00	63.0 PK	74.0	-11.0	1.52 V	4	61.4	1.6
2	5150.00	51.3 AV	54.0	-2.7	1.52 V	4	49.7	1.6
3	*5180.00	117.8 PK			1.69 V	4	116.1	1.7
4	*5180.00	107.7 AV			1.69 V	4	106.0	1.7
5	#10360.00	49.6 PK	74.0	-24.4	2.78 V	157	37.9	11.7
6	#10360.00	37.2 AV	54.0	-16.8	2.78 V	157	25.5	11.7
7	15540.00	52.7 PK	74.0	-21.3	2.44 V	150	39.4	13.3
8	15540.00	39.3 AV	54.0	-14.7	2.44 V	150	26.0	13.3

**REMARKS:**

1. Emission Level(dBuV/m) = Raw Value(dBuV) + Correction Factor(dB/m)
2. Correction Factor(dB/m) = Antenna Factor(dB/m) + Cable Factor(dB) – Pre-Amplifier Factor(dB)
3. The other emission levels were very low against the limit.
4. Margin value = Emission Level – Limit value
5. " \* ": Fundamental frequency.
6. " # ": The radiated frequency is out of the restricted band.

<b>CHANNEL</b>	TX Channel 40	<b>DETECTOR FUNCTION</b>	Peak (PK)
<b>FREQUENCY RANGE</b>	1GHz ~ 40GHz		Average (AV)

**ANTENNA POLARITY & TEST DISTANCE: HORIZONTAL AT 3 M**

NO.	FREQ. (MHz)	EMISSION LEVEL (dBuV/m)	LIMIT (dBuV/m)	MARGIN (dB)	ANTENNA HEIGHT (m)	TABLE ANGLE (Degree)	RAW VALUE (dBuV)	CORRECTION FACTOR (dB/m)
1	5150.00	67.5 PK	74.0	-6.5	2.08 H	1	65.9	1.6
2	5150.00	53.0 AV	54.0	-1.0	2.08 H	1	51.4	1.6
3	*5200.00	124.2 PK			2.08 H	1	122.4	1.8
4	*5200.00	113.0 AV			2.08 H	1	111.2	1.8
5	#10400.00	51.2 PK	74.0	-22.8	1.96 H	62	39.3	11.9
6	#10400.00	38.8 AV	54.0	-15.2	1.96 H	62	26.9	11.9
7	15600.00	52.5 PK	74.0	-21.5	2.71 H	207	39.2	13.3
8	15600.00	39.5 AV	54.0	-14.5	2.71 H	207	26.2	13.3

**ANTENNA POLARITY & TEST DISTANCE: VERTICAL AT 3 M**

NO.	FREQ. (MHz)	EMISSION LEVEL (dBuV/m)	LIMIT (dBuV/m)	MARGIN (dB)	ANTENNA HEIGHT (m)	TABLE ANGLE (Degree)	RAW VALUE (dBuV)	CORRECTION FACTOR (dB/m)
1	5150.00	60.2 PK	74.0	-13.8	1.70 V	3	58.6	1.6
2	5150.00	48.7 AV	54.0	-5.3	1.70 V	3	47.1	1.6
3	*5200.00	121.3 PK			1.70 V	3	119.5	1.8
4	*5200.00	109.8 AV			1.70 V	3	108.0	1.8
5	#10400.00	51.2 PK	74.0	-22.8	2.02 V	237	39.3	11.9
6	#10400.00	39.0 AV	54.0	-15.0	2.02 V	237	27.1	11.9
7	15600.00	52.5 PK	74.0	-21.5	2.05 V	191	39.2	13.3
8	15600.00	39.4 AV	54.0	-14.6	2.05 V	191	26.1	13.3

**REMARKS:**

1. Emission Level(dBuV/m) = Raw Value(dBuV) + Correction Factor(dB/m)
2. Correction Factor(dB/m) = Antenna Factor(dB/m) + Cable Factor(dB) – Pre-Amplifier Factor(dB)
3. The other emission levels were very low against the limit.
4. Margin value = Emission Level – Limit value
5. " \* ": Fundamental frequency.
6. " # ": The radiated frequency is out of the restricted band.

<b>CHANNEL</b>	TX Channel 48	<b>DETECTOR FUNCTION</b>	Peak (PK)
<b>FREQUENCY RANGE</b>	1GHz ~ 40GHz		Average (AV)

**ANTENNA POLARITY & TEST DISTANCE: HORIZONTAL AT 3 M**

NO.	FREQ. (MHz)	EMISSION LEVEL (dBuV/m)	LIMIT (dBuV/m)	MARGIN (dB)	ANTENNA HEIGHT (m)	TABLE ANGLE (Degree)	RAW VALUE (dBuV)	CORRECTION FACTOR (dB/m)
1	*5240.00	125.5 PK			1.77 H	3	123.7	1.8
2	*5240.00	115.1 AV			1.77 H	3	113.3	1.8
3	5350.00	64.6 PK	74.0	-9.4	1.77 H	3	62.5	2.1
4	5350.00	51.8 AV	54.0	-2.2	1.77 H	3	49.7	2.1
5	#10480.00	51.4 PK	74.0	-22.6	1.55 H	85	39.2	12.2
6	#10480.00	39.2 AV	54.0	-14.8	1.55 H	85	27.0	12.2
7	15720.00	53.2 PK	74.0	-20.8	2.78 H	199	40.0	13.2
8	15720.00	41.1 AV	54.0	-12.9	2.78 H	199	27.9	13.2

**ANTENNA POLARITY & TEST DISTANCE: VERTICAL AT 3 M**

NO.	FREQ. (MHz)	EMISSION LEVEL (dBuV/m)	LIMIT (dBuV/m)	MARGIN (dB)	ANTENNA HEIGHT (m)	TABLE ANGLE (Degree)	RAW VALUE (dBuV)	CORRECTION FACTOR (dB/m)
1	*5240.00	123.0 PK			1.61 V	2	121.2	1.8
2	*5240.00	112.3 AV			1.61 V	2	110.5	1.8
3	5350.00	61.3 PK	74.0	-12.7	1.61 V	2	59.2	2.1
4	5350.00	48.0 AV	54.0	-6.0	1.61 V	2	45.9	2.1
5	#10480.00	51.4 PK	74.0	-22.6	2.59 V	187	39.2	12.2
6	#10480.00	39.3 AV	54.0	-14.7	2.59 V	187	27.1	12.2
7	15720.00	52.8 PK	74.0	-21.2	2.80 V	205	39.6	13.2
8	15720.00	41.0 AV	54.0	-13.0	2.80 V	205	27.8	13.2

**REMARKS:**

1. Emission Level(dBuV/m) = Raw Value(dBuV) + Correction Factor(dB/m)
2. Correction Factor(dB/m) = Antenna Factor(dB/m) + Cable Factor(dB) – Pre-Amplifier Factor(dB)
3. The other emission levels were very low against the limit.
4. Margin value = Emission Level – Limit value
5. " \* ": Fundamental frequency.
6. " # ": The radiated frequency is out of the restricted band.

<b>CHANNEL</b>	TX Channel 149	<b>DETECTOR FUNCTION</b>	Peak (PK)
<b>FREQUENCY RANGE</b>	1GHz ~ 40GHz		Average (AV)

**ANTENNA POLARITY & TEST DISTANCE: HORIZONTAL AT 3 M**

NO.	FREQ. (MHz)	EMISSION LEVEL (dBuV/m)	LIMIT (dBuV/m)	MARGIN (dB)	ANTENNA HEIGHT (m)	TABLE ANGLE (Degree)	RAW VALUE (dBuV)	CORRECTION FACTOR (dB/m)
1	#5635.50	64.6 PK	68.2	-3.6	2.00 H	2	62.0	2.6
2	*5745.00	123.3 PK			2.00 H	2	120.5	2.8
3	*5745.00	111.2 AV			2.00 H	2	108.4	2.8
4	#5931.43	61.1 PK	68.2	-7.1	2.00 H	2	58.0	3.1
5	11490.00	69.0 PK	74.0	-5.0	1.54 H	65	55.5	13.5
6	11490.00	53.6 AV	54.0	-0.4	1.54 H	65	40.1	13.5
7	#17235.00	56.9 PK	74.0	-17.1	2.35 H	291	38.5	18.4
8	#17235.00	44.2 AV	54.0	-9.8	2.35 H	291	25.8	18.4

**ANTENNA POLARITY & TEST DISTANCE: VERTICAL AT 3 M**

NO.	FREQ. (MHz)	EMISSION LEVEL (dBuV/m)	LIMIT (dBuV/m)	MARGIN (dB)	ANTENNA HEIGHT (m)	TABLE ANGLE (Degree)	RAW VALUE (dBuV)	CORRECTION FACTOR (dB/m)
1	#5629.80	62.5 PK	68.2	-5.7	2.21 V	3	59.9	2.6
2	*5745.00	121.0 PK			2.21 V	3	118.2	2.8
3	*5745.00	110.2 AV			2.21 V	3	107.4	2.8
4	#5936.18	60.4 PK	68.2	-7.8	2.21 V	3	57.3	3.1
5	11490.00	63.9 PK	74.0	-10.1	1.07 V	350	50.4	13.5
6	11490.00	49.8 AV	54.0	-4.2	1.07 V	350	36.3	13.5
7	#17235.00	56.8 PK	74.0	-17.2	1.34 V	277	38.4	18.4
8	#17235.00	44.2 AV	54.0	-9.8	1.34 V	277	25.8	18.4

**REMARKS:**

1. Emission Level(dBuV/m) = Raw Value(dBuV) + Correction Factor(dB/m)
2. Correction Factor(dB/m) = Antenna Factor(dB/m) + Cable Factor(dB) – Pre-Amplifier Factor(dB)
3. The other emission levels were very low against the limit.
4. Margin value = Emission Level – Limit value
5. " \* ": Fundamental frequency.
6. " # ": The radiated frequency is out of the restricted band.

<b>CHANNEL</b>	TX Channel 157	<b>DETECTOR FUNCTION</b>	Peak (PK)
<b>FREQUENCY RANGE</b>	1GHz ~ 40GHz		Average (AV)

**ANTENNA POLARITY & TEST DISTANCE: HORIZONTAL AT 3 M**

NO.	FREQ. (MHz)	EMISSION LEVEL (dBuV/m)	LIMIT (dBuV/m)	MARGIN (dB)	ANTENNA HEIGHT (m)	TABLE ANGLE (Degree)	RAW VALUE (dBuV)	CORRECTION FACTOR (dB/m)
1	#5625.05	64.5 PK	68.2	-3.7	2.18 H	2	61.9	2.6
2	*5785.00	124.3 PK			2.18 H	2	121.4	2.9
3	*5785.00	113.6 AV			2.18 H	2	110.7	2.9
4	#5940.93	60.4 PK	68.2	-7.8	2.18 H	2	57.3	3.1
5	11570.00	67.6 PK	74.0	-6.4	1.69 H	69	54.4	13.2
6	11570.00	53.4 AV	54.0	-0.6	1.69 H	69	40.2	13.2
7	#17355.00	56.8 PK	74.0	-17.2	1.80 H	300	37.7	19.1
8	#17355.00	44.0 AV	54.0	-10.0	1.80 H	300	24.9	19.1

**ANTENNA POLARITY & TEST DISTANCE: VERTICAL AT 3 M**

NO.	FREQ. (MHz)	EMISSION LEVEL (dBuV/m)	LIMIT (dBuV/m)	MARGIN (dB)	ANTENNA HEIGHT (m)	TABLE ANGLE (Degree)	RAW VALUE (dBuV)	CORRECTION FACTOR (dB/m)
1	#5595.12	63.8 PK	68.2	-4.4	2.22 V	2	61.3	2.5
2	*5785.00	123.2 PK			2.22 V	2	120.3	2.9
3	*5785.00	112.3 AV			2.22 V	2	109.4	2.9
4	#5949.95	60.8 PK	68.2	-7.4	2.22 V	2	57.6	3.2
5	11570.00	63.4 PK	74.0	-10.6	2.46 V	338	50.2	13.2
6	11570.00	50.3 AV	54.0	-3.7	2.46 V	338	37.1	13.2
7	#17355.00	56.5 PK	74.0	-17.5	1.55 V	280	37.4	19.1
8	#17355.00	44.0 AV	54.0	-10.0	1.55 V	280	24.9	19.1

**REMARKS:**

1. Emission Level(dBuV/m) = Raw Value(dBuV) + Correction Factor(dB/m)
2. Correction Factor(dB/m) = Antenna Factor(dB/m) + Cable Factor(dB) – Pre-Amplifier Factor(dB)
3. The other emission levels were very low against the limit.
4. Margin value = Emission Level – Limit value
5. " \* ": Fundamental frequency.
6. " # ": The radiated frequency is out of the restricted band.

<b>CHANNEL</b>	TX Channel 165	<b>DETECTOR FUNCTION</b>	Peak (PK)
<b>FREQUENCY RANGE</b>	1GHz ~ 40GHz		Average (AV)

**ANTENNA POLARITY & TEST DISTANCE: HORIZONTAL AT 3 M**

NO.	FREQ. (MHz)	EMISSION LEVEL (dBuV/m)	LIMIT (dBuV/m)	MARGIN (dB)	ANTENNA HEIGHT (m)	TABLE ANGLE (Degree)	RAW VALUE (dBuV)	CORRECTION FACTOR (dB/m)
1	#5640.25	64.9 PK	68.2	-3.3	2.17 H	2	62.3	2.6
2	*5825.00	125.2 PK			2.17 H	2	122.3	2.9
3	*5825.00	114.8 AV			2.17 H	2	111.9	2.9
4	#5947.10	62.3 PK	68.2	-5.9	2.17 H	2	59.2	3.1
5	11650.00	64.6 PK	74.0	-9.4	1.39 H	63	51.4	13.2
6	11650.00	51.6 AV	54.0	-2.4	1.39 H	63	38.4	13.2
7	#17475.00	61.5 PK	74.0	-12.5	2.29 H	35	42.1	19.4
8	#17475.00	47.8 AV	54.0	-6.2	2.29 H	35	28.4	19.4

**ANTENNA POLARITY & TEST DISTANCE: VERTICAL AT 3 M**

NO.	FREQ. (MHz)	EMISSION LEVEL (dBuV/m)	LIMIT (dBuV/m)	MARGIN (dB)	ANTENNA HEIGHT (m)	TABLE ANGLE (Degree)	RAW VALUE (dBuV)	CORRECTION FACTOR (dB/m)
1	#5626.95	63.7 PK	68.2	-4.5	2.19 V	1	61.1	2.6
2	*5825.00	123.8 PK			2.19 V	1	120.9	2.9
3	*5825.00	113.4 AV			2.19 V	1	110.5	2.9
4	#5943.30	61.1 PK	68.2	-7.1	2.19 V	1	58.0	3.1
5	11650.00	64.2 PK	74.0	-9.8	2.47 V	336	51.0	13.2
6	11650.00	50.2 AV	54.0	-3.8	2.47 V	336	37.0	13.2
7	#17475.00	56.8 PK	74.0	-17.2	1.44 V	276	37.4	19.4
8	#17475.00	44.6 AV	54.0	-9.4	1.44 V	276	25.2	19.4

**REMARKS:**

1. Emission Level(dBuV/m) = Raw Value(dBuV) + Correction Factor(dB/m)
2. Correction Factor(dB/m) = Antenna Factor(dB/m) + Cable Factor(dB) – Pre-Amplifier Factor(dB)
3. The other emission levels were very low against the limit.
4. Margin value = Emission Level – Limit value
5. " \* ": Fundamental frequency.
6. " # ": The radiated frequency is out of the restricted band.



**802.11ac (VHT40)**

<b>CHANNEL</b>	TX Channel 38	<b>DETECTOR FUNCTION</b>	Peak (PK)
<b>FREQUENCY RANGE</b>	1GHz ~ 40GHz		Average (AV)

**ANTENNA POLARITY & TEST DISTANCE: HORIZONTAL AT 3 M**

NO.	FREQ. (MHz)	EMISSION LEVEL (dBuV/m)	LIMIT (dBuV/m)	MARGIN (dB)	ANTENNA HEIGHT (m)	TABLE ANGLE (Degree)	RAW VALUE (dBuV)	CORRECTION FACTOR (dB/m)
1	5150.00	68.5 PK	74.0	-5.5	1.83 H	3	66.9	1.6
2	5150.00	53.4 AV	54.0	-0.6	1.83 H	3	51.8	1.6
3	*5190.00	113.7 PK			1.83 H	3	111.9	1.8
4	*5190.00	101.3 AV			1.83 H	3	99.5	1.8
5	5350.00	57.9 PK	74.0	-16.1	1.83 H	3	55.8	2.1
6	5350.00	44.8 AV	54.0	-9.2	1.83 H	3	42.7	2.1
7	#10380.00	48.7 PK	74.0	-25.3	1.95 H	58	36.9	11.8
8	#10380.00	36.5 AV	54.0	-17.5	1.95 H	58	24.7	11.8
9	15570.00	50.3 PK	74.0	-23.7	2.74 H	202	37.0	13.3
10	15570.00	37.8 AV	54.0	-16.2	2.74 H	202	24.5	13.3

**ANTENNA POLARITY & TEST DISTANCE: VERTICAL AT 3 M**

NO.	FREQ. (MHz)	EMISSION LEVEL (dBuV/m)	LIMIT (dBuV/m)	MARGIN (dB)	ANTENNA HEIGHT (m)	TABLE ANGLE (Degree)	RAW VALUE (dBuV)	CORRECTION FACTOR (dB/m)
1	5150.00	64.1 PK	74.0	-9.9	1.24 V	5	62.5	1.6
2	5150.00	51.3 AV	54.0	-2.7	1.24 V	5	49.7	1.6
3	*5190.00	110.7 PK			1.24 V	5	108.9	1.8
4	*5190.00	98.8 AV			1.24 V	5	97.0	1.8
5	5350.00	56.7 PK	74.0	-17.3	1.24 V	5	54.6	2.1
6	5350.00	43.2 AV	54.0	-10.8	1.24 V	5	41.1	2.1
7	#10380.00	47.5 PK	74.0	-26.5	2.88 V	145	35.7	11.8
8	#10380.00	36.1 AV	54.0	-17.9	2.88 V	145	24.3	11.8
9	15570.00	50.6 PK	74.0	-23.4	2.34 V	146	37.3	13.3
10	15570.00	37.8 AV	54.0	-16.2	2.34 V	146	24.5	13.3

**REMARKS:**

1. Emission Level(dBuV/m) = Raw Value(dBuV) + Correction Factor(dB/m)
2. Correction Factor(dB/m) = Antenna Factor(dB/m) + Cable Factor(dB) – Pre-Amplifier Factor(dB)
3. The other emission levels were very low against the limit.
4. Margin value = Emission Level – Limit value
5. " \* ": Fundamental frequency.
6. " # ": The radiated frequency is out of the restricted band.

<b>CHANNEL</b>	TX Channel 46	<b>DETECTOR FUNCTION</b>	Peak (PK)
<b>FREQUENCY RANGE</b>	1GHz ~ 40GHz		Average (AV)

**ANTENNA POLARITY & TEST DISTANCE: HORIZONTAL AT 3 M**

NO.	FREQ. (MHz)	EMISSION LEVEL (dBuV/m)	LIMIT (dBuV/m)	MARGIN (dB)	ANTENNA HEIGHT (m)	TABLE ANGLE (Degree)	RAW VALUE (dBuV)	CORRECTION FACTOR (dB/m)
1	*5230.00	122.1 PK			1.94 H	4	120.3	1.8
2	*5230.00	110.3 AV			1.94 H	4	108.5	1.8
3	5350.00	66.2 PK	74.0	-7.8	1.94 H	4	64.1	2.1
4	5350.00	52.3 AV	54.0	-1.7	1.94 H	4	50.2	2.1
5	#10460.00	49.6 PK	74.0	-24.4	1.89 H	62	37.5	12.1
6	#10460.00	37.1 AV	54.0	-16.9	1.89 H	62	25.0	12.1
7	15690.00	52.5 PK	74.0	-21.5	2.66 H	218	39.3	13.2
8	15690.00	39.5 AV	54.0	-14.5	2.66 H	218	26.3	13.2

**ANTENNA POLARITY & TEST DISTANCE: VERTICAL AT 3 M**

NO.	FREQ. (MHz)	EMISSION LEVEL (dBuV/m)	LIMIT (dBuV/m)	MARGIN (dB)	ANTENNA HEIGHT (m)	TABLE ANGLE (Degree)	RAW VALUE (dBuV)	CORRECTION FACTOR (dB/m)
1	*5230.00	119.8 PK			1.32 V	9	118.0	1.8
2	*5230.00	108.4 AV			1.32 V	9	106.6	1.8
3	5350.00	64.8 PK	74.0	-9.2	1.32 V	9	62.7	2.1
4	5350.00	50.1 AV	54.0	-3.9	1.32 V	9	48.0	2.1
5	#10460.00	49.4 PK	74.0	-24.6	2.60 V	167	37.3	12.1
6	#10460.00	38.2 AV	54.0	-15.8	2.60 V	167	26.1	12.1
7	15690.00	51.3 PK	74.0	-22.7	2.77 V	201	38.1	13.2
8	15690.00	39.5 AV	54.0	-14.5	2.77 V	201	26.3	13.2

**REMARKS:**

1. Emission Level(dBuV/m) = Raw Value(dBuV) + Correction Factor(dB/m)
2. Correction Factor(dB/m) = Antenna Factor(dB/m) + Cable Factor(dB) – Pre-Amplifier Factor(dB)
3. The other emission levels were very low against the limit.
4. Margin value = Emission Level – Limit value
5. " \* ": Fundamental frequency.
6. " # ": The radiated frequency is out of the restricted band.

<b>CHANNEL</b>	TX Channel 151	<b>DETECTOR FUNCTION</b>	Peak (PK)
<b>FREQUENCY RANGE</b>	1GHz ~ 40GHz		Average (AV)

**ANTENNA POLARITY & TEST DISTANCE: HORIZONTAL AT 3 M**

NO.	FREQ. (MHz)	EMISSION LEVEL (dBuV/m)	LIMIT (dBuV/m)	MARGIN (dB)	ANTENNA HEIGHT (m)	TABLE ANGLE (Degree)	RAW VALUE (dBuV)	CORRECTION FACTOR (dB/m)
1	#5647.37	66.8 PK	68.2	-1.4	2.18 H	3	64.2	2.6
2	*5755.00	122.2 PK			2.18 H	3	119.3	2.9
3	*5755.00	110.2 AV			2.18 H	3	107.3	2.9
4	#5990.80	66.4 PK	68.2	-1.8	2.18 H	3	63.0	3.4
5	11510.00	66.4 PK	74.0	-7.6	1.51 H	66	52.9	13.5
6	11510.00	52.5 AV	54.0	-1.5	1.51 H	66	39.0	13.5
7	#17265.00	56.7 PK	74.0	-17.3	2.34 H	118	38.2	18.5
8	#17265.00	44.3 AV	54.0	-9.7	2.34 H	118	25.8	18.5

**ANTENNA POLARITY & TEST DISTANCE: VERTICAL AT 3 M**

NO.	FREQ. (MHz)	EMISSION LEVEL (dBuV/m)	LIMIT (dBuV/m)	MARGIN (dB)	ANTENNA HEIGHT (m)	TABLE ANGLE (Degree)	RAW VALUE (dBuV)	CORRECTION FACTOR (dB/m)
1	#5646.90	65.6 PK	68.2	-2.6	2.09 V	2	63.0	2.6
2	*5755.00	121.1 PK			2.09 V	2	118.2	2.9
3	*5755.00	109.2 AV			2.09 V	2	106.3	2.9
4	#5933.32	61.5 PK	68.2	-6.7	2.09 V	2	58.4	3.1
5	11510.00	61.7 PK	74.0	-12.3	1.53 V	316	48.2	13.5
6	11510.00	48.3 AV	54.0	-5.7	1.53 V	316	34.8	13.5
7	#17265.00	56.8 PK	74.0	-17.2	1.78 V	284	38.3	18.5
8	#17265.00	44.2 AV	54.0	-9.8	1.78 V	284	25.7	18.5

**REMARKS:**

1. Emission Level(dBuV/m) = Raw Value(dBuV) + Correction Factor(dB/m)
2. Correction Factor(dB/m) = Antenna Factor(dB/m) + Cable Factor(dB) – Pre-Amplifier Factor(dB)
3. The other emission levels were very low against the limit.
4. Margin value = Emission Level – Limit value
5. " \* ": Fundamental frequency.
6. " # ": The radiated frequency is out of the restricted band.

<b>CHANNEL</b>	TX Channel 159	<b>DETECTOR FUNCTION</b>	Peak (PK)
<b>FREQUENCY RANGE</b>	1GHz ~ 40GHz		Average (AV)

**ANTENNA POLARITY & TEST DISTANCE: HORIZONTAL AT 3 M**

NO.	FREQ. (MHz)	EMISSION LEVEL (dBuV/m)	LIMIT (dBuV/m)	MARGIN (dB)	ANTENNA HEIGHT (m)	TABLE ANGLE (Degree)	RAW VALUE (dBuV)	CORRECTION FACTOR (dB/m)
1	#5607.48	65.7 PK	68.2	-2.5	2.11 H	0	63.1	2.6
2	*5795.00	121.8 PK			2.11 H	0	118.9	2.9
3	*5795.00	109.6 AV			2.11 H	0	106.7	2.9
4	#5967.52	65.4 PK	68.2	-2.8	2.11 H	0	62.2	3.2
5	11590.00	62.6 PK	74.0	-11.4	1.54 H	66	49.5	13.1
6	11590.00	48.8 AV	54.0	-5.2	1.54 H	66	35.7	13.1
7	#17385.00	57.2 PK	74.0	-16.8	2.20 H	121	37.9	19.3
8	#17385.00	44.7 AV	54.0	-9.3	2.20 H	121	25.4	19.3

**ANTENNA POLARITY & TEST DISTANCE: VERTICAL AT 3 M**

NO.	FREQ. (MHz)	EMISSION LEVEL (dBuV/m)	LIMIT (dBuV/m)	MARGIN (dB)	ANTENNA HEIGHT (m)	TABLE ANGLE (Degree)	RAW VALUE (dBuV)	CORRECTION FACTOR (dB/m)
1	#5625.52	64.5 PK	68.2	-3.7	2.05 V	4	61.9	2.6
2	*5795.00	120.5 PK			2.05 V	4	117.6	2.9
3	*5795.00	108.7 AV			2.05 V	4	105.8	2.9
4	#5962.30	61.9 PK	68.2	-6.3	2.05 V	4	58.7	3.2
5	11590.00	61.0 PK	74.0	-13.0	1.58 V	304	47.9	13.1
6	11590.00	47.5 AV	54.0	-6.5	1.58 V	304	34.4	13.1
7	#17385.00	57.2 PK	74.0	-16.8	1.71 V	290	37.9	19.3
8	#17385.00	44.4 AV	54.0	-9.6	1.71 V	290	25.1	19.3

**REMARKS:**

1. Emission Level(dBuV/m) = Raw Value(dBuV) + Correction Factor(dB/m)
2. Correction Factor(dB/m) = Antenna Factor(dB/m) + Cable Factor(dB) – Pre-Amplifier Factor(dB)
3. The other emission levels were very low against the limit.
4. Margin value = Emission Level – Limit value
5. " \* ": Fundamental frequency.
6. " # ": The radiated frequency is out of the restricted band.

**802.11ac (VHT80)**

<b>CHANNEL</b>	TX Channel 42	<b>DETECTOR FUNCTION</b>	Peak (PK)
<b>FREQUENCY RANGE</b>	1GHz ~ 40GHz		Average (AV)

**ANTENNA POLARITY & TEST DISTANCE: HORIZONTAL AT 3 M**

NO.	FREQ. (MHz)	EMISSION LEVEL (dBuV/m)	LIMIT (dBuV/m)	MARGIN (dB)	ANTENNA HEIGHT (m)	TABLE ANGLE (Degree)	RAW VALUE (dBuV)	CORRECTION FACTOR (dB/m)
1	5150.00	67.4 PK	74.0	-6.6	1.87 H	2	65.8	1.6
2	5150.00	53.5 AV	54.0	-0.5	1.87 H	2	51.9	1.6
3	*5210.00	108.4 PK			1.87 H	2	106.6	1.8
4	*5210.00	94.7 AV			1.87 H	2	92.9	1.8
5	5350.00	57.2 PK	74.0	-16.8	1.87 H	2	55.1	2.1
6	5350.00	44.5 AV	54.0	-9.5	1.87 H	2	42.4	2.1
7	#10420.00	47.4 PK	74.0	-26.6	2.02 H	66	35.4	12.0
8	#10420.00	35.3 AV	54.0	-18.7	2.02 H	66	23.3	12.0
9	15630.00	49.8 PK	74.0	-24.2	2.60 H	208	36.5	13.3
10	15630.00	36.9 AV	54.0	-17.1	2.60 H	208	23.6	13.3

**ANTENNA POLARITY & TEST DISTANCE: VERTICAL AT 3 M**

NO.	FREQ. (MHz)	EMISSION LEVEL (dBuV/m)	LIMIT (dBuV/m)	MARGIN (dB)	ANTENNA HEIGHT (m)	TABLE ANGLE (Degree)	RAW VALUE (dBuV)	CORRECTION FACTOR (dB/m)
1	5150.00	63.7 PK	74.0	-10.3	1.89 V	9	62.1	1.6
2	5150.00	51.4 AV	54.0	-2.6	1.89 V	9	49.8	1.6
3	*5210.00	105.6 PK			1.89 V	9	103.8	1.8
4	*5210.00	93.2 AV			1.89 V	9	91.4	1.8
5	5350.00	55.8 PK	74.0	-18.2	1.89 V	9	53.7	2.1
6	5350.00	42.9 AV	54.0	-11.1	1.89 V	9	40.8	2.1
7	#10420.00	46.9 PK	74.0	-27.1	3.01 V	138	34.9	12.0
8	#10420.00	35.4 AV	54.0	-18.6	3.01 V	138	23.4	12.0
9	15630.00	50.0 PK	74.0	-24.0	2.44 V	140	36.7	13.3
10	15630.00	37.2 AV	54.0	-16.8	2.44 V	140	23.9	13.3

**REMARKS:**

- Emission Level(dBuV/m) = Raw Value(dBuV) + Correction Factor(dB/m)
- Correction Factor(dB/m) = Antenna Factor(dB/m) + Cable Factor(dB) – Pre-Amplifier Factor(dB)
- The other emission levels were very low against the limit.
- Margin value = Emission Level – Limit value
- " \* ": Fundamental frequency.
- " # ": The radiated frequency is out of the restricted band.

<b>CHANNEL</b>	TX Channel 155	<b>DETECTOR FUNCTION</b>	Peak (PK)
<b>FREQUENCY RANGE</b>	1GHz ~ 40GHz		Average (AV)

**ANTENNA POLARITY & TEST DISTANCE: HORIZONTAL AT 3 M**

NO.	FREQ. (MHz)	EMISSION LEVEL (dBuV/m)	LIMIT (dBuV/m)	MARGIN (dB)	ANTENNA HEIGHT (m)	TABLE ANGLE (Degree)	RAW VALUE (dBuV)	CORRECTION FACTOR (dB/m)
1	#5631.70	67.8 PK	68.2	-0.4	2.10 H	0	65.2	2.6
2	*5775.00	117.7 PK			2.10 H	0	114.8	2.9
3	*5775.00	103.8 AV			2.10 H	0	100.9	2.9
4	#5936.65	66.0 PK	68.2	-2.2	2.10 H	0	62.9	3.1
5	11550.00	60.7 PK	74.0	-13.3	1.59 H	65	47.4	13.3
6	11550.00	46.8 AV	54.0	-7.2	1.59 H	65	33.5	13.3
7	#17325.00	57.4 PK	74.0	-16.6	2.27 H	125	38.5	18.9
8	#17325.00	44.8 AV	54.0	-9.2	2.27 H	125	25.9	18.9

**ANTENNA POLARITY & TEST DISTANCE: VERTICAL AT 3 M**

NO.	FREQ. (MHz)	EMISSION LEVEL (dBuV/m)	LIMIT (dBuV/m)	MARGIN (dB)	ANTENNA HEIGHT (m)	TABLE ANGLE (Degree)	RAW VALUE (dBuV)	CORRECTION FACTOR (dB/m)
1	#5639.30	64.7 PK	68.2	-3.5	2.21 V	2	62.1	2.6
2	*5775.00	115.0 PK			2.21 V	2	112.1	2.9
3	*5775.00	101.1 AV			2.21 V	2	98.2	2.9
4	#5970.85	61.3 PK	68.2	-6.9	2.21 V	2	58.1	3.2
5	11550.00	60.3 PK	74.0	-13.7	1.66 V	295	47.0	13.3
6	11550.00	46.8 AV	54.0	-7.2	1.66 V	295	33.5	13.3
7	#17325.00	56.6 PK	74.0	-17.4	1.59 V	300	37.7	18.9
8	#17325.00	43.7 AV	54.0	-10.3	1.59 V	300	24.8	18.9

**REMARKS:**

1. Emission Level(dBuV/m) = Raw Value(dBuV) + Correction Factor(dB/m)
2. Correction Factor(dB/m) = Antenna Factor(dB/m) + Cable Factor(dB) – Pre-Amplifier Factor(dB)
3. The other emission levels were very low against the limit.
4. Margin value = Emission Level – Limit value
5. " \* ": Fundamental frequency.
6. " # ": The radiated frequency is out of the restricted band.

**Below 1GHz Data:**

**802.11ac (VHT20)**

<b>CHANNEL</b>	TX Channel 157	<b>DETECTOR FUNCTION</b>	Quasi-Peak (QP)
<b>FREQUENCY RANGE</b>	below 1GHz		

**ANTENNA POLARITY & TEST DISTANCE: HORIZONTAL AT 3 M**

NO.	FREQ. (MHz)	EMISSION LEVEL (dBuV/m)	LIMIT (dBuV/m)	MARGIN (dB)	ANTENNA HEIGHT (m)	TABLE ANGLE (Degree)	RAW VALUE (dBuV)	CORRECTION FACTOR (dB/m)
1	108.75	35.6 QP	43.5	-7.9	2.50 H	102	47.1	-11.5
2	128.76	24.1 QP	43.5	-19.4	2.50 H	96	34.1	-10.0
3	256.24	21.2 QP	46.0	-24.8	2.50 H	76	30.9	-9.7
4	325.15	22.3 QP	46.0	-23.7	1.00 H	206	29.5	-7.2
5	403.54	22.1 QP	46.0	-23.9	1.00 H	54	27.4	-5.3
6	609.25	24.8 QP	46.0	-21.2	2.50 H	353	25.1	-0.3

**ANTENNA POLARITY & TEST DISTANCE: VERTICAL AT 3 M**

NO.	FREQ. (MHz)	EMISSION LEVEL (dBuV/m)	LIMIT (dBuV/m)	MARGIN (dB)	ANTENNA HEIGHT (m)	TABLE ANGLE (Degree)	RAW VALUE (dBuV)	CORRECTION FACTOR (dB/m)
1	73.84	33.7 QP	40.0	-6.3	1.50 V	34	45.4	-11.7
2	111.41	34.1 QP	43.5	-9.4	1.00 V	28	45.3	-11.2
3	162.45	23.1 QP	43.5	-20.4	1.00 V	233	31.8	-8.7
4	270.15	25.5 QP	46.0	-20.5	1.50 V	166	34.5	-9.0
5	350.15	23.4 QP	46.0	-22.6	1.50 V	125	30.3	-6.9
6	610.23	24.5 QP	46.0	-21.5	2.50 V	163	24.7	-0.2

**REMARKS:**

1. Emission Level(dBuV/m) = Raw Value(dBuV) + Correction Factor(dB/m)
2. Correction Factor(dB/m) = Antenna Factor(dB/m) + Cable Factor(dB) – Pre-Amplifier Factor(dB)
3. The other emission levels were very low against the limit.
4. Margin value = Emission Level – Limit value

## 4.2 Conducted Emission Measurement

### 4.2.1 Limits of Conducted Emission Measurement

Frequency (MHz)	Conducted Limit (dBuV)	
	Quasi-peak	Average
0.15 - 0.5	66 - 56	56 - 46
0.50 - 5.0	56	46
5.0 - 30.0	60	50

Note: 1. The lower limit shall apply at the transition frequencies.

2. The limit decreases in line with the logarithm of the frequency in the range of 0.15 to 0.50MHz.

### 4.2.2 Test Instruments

DESCRIPTION & MANUFACTURER	MODEL NO.	SERIAL NO.	CALIBRATED DATE	CALIBRATED UNTIL
Test Receiver R&S	ESCS 30	847124/029	Oct. 23, 2015	Oct. 22, 2016
Line-Impedance Stabilization Network (for EUT) R&S	ESH3-Z5	848773/004	Oct. 28, 2015	Oct. 27, 2016
RF Cable	5D-FB	COACAB-002	Mar. 04, 2016	Mar. 03, 2017
10 dB PAD Mini-Circuits	HAT-10+	CONATT-004	Jun. 20, 2016	Jun. 19, 2017
Software BVADT	BVADT_Cond_ V7.3.7.3	NA	NA	NA

**Note:**

1. The calibration interval of the above test instruments are 12 months and the calibrations are traceable to NML/ROC and NIST/USA.
2. The test was performed in Shielded Room No. 1.
- 3 Tested Date: June 22, 2016



#### 4.2.3 Test Procedure

- The EUT was placed 0.4 meters from the conducting wall of the shielded room with EUT being connected to the power mains through a line impedance stabilization network (LISN). Other support units were connected to the power mains through another LISN. The two LISNs provide 50 ohm/ 50uH of coupling impedance for the measuring instrument.
- Both lines of the power mains connected to the EUT were checked for maximum conducted interference.
- The frequency range from 150kHz to 30MHz was searched. Emission levels under (Limit - 20dB) was not recorded.

**NOTE:** All modes of operation were investigated and the worst-case emissions are reported.

#### 4.2.4 Deviation from Test Standard

No deviation.

#### 4.2.5 Test Setup

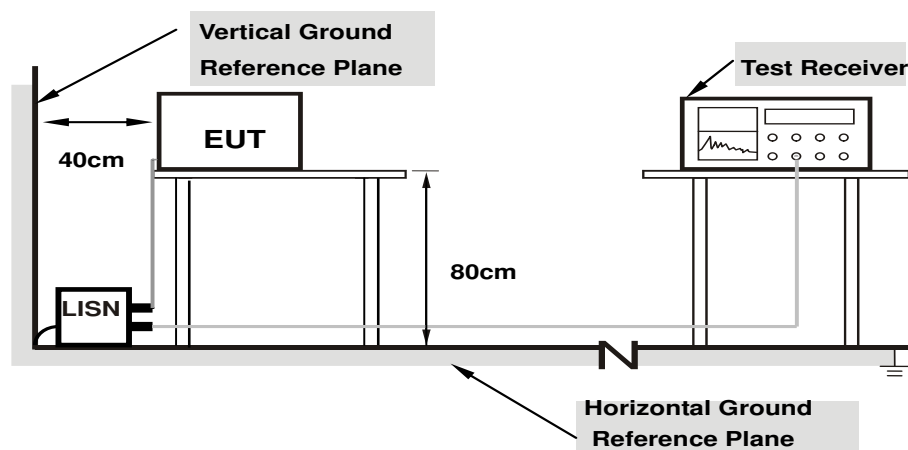

**Note: 1.Support units were connected to second LISN.**

For the actual test configuration, please refer to the attached file (Test Setup Photo).

#### 4.2.6 EUT Operating Condition

Same as 4.1.6.

#### 4.2.7 Test Results

Phase	Line (L)	Detector Function	Quasi-Peak (QP) / Average (AV)
-------	----------	-------------------	--------------------------------

No	Freq. [MHz]	Corr.	Reading Value		Emission Level		Limit		Margin	
		Factor (dB)	[dB (uV)]		[dB (uV)]		[dB (uV)]		(dB)	
			Q.P.	AV.	Q.P.	AV.	Q.P.	AV.	Q.P.	AV.
1	0.16172	10.21	37.34	24.57	47.55	34.78	65.38	55.38	-17.82	-20.59
2	0.23203	10.22	26.96	15.65	37.18	25.87	62.38	52.38	-25.20	-26.51
<b>3</b>	<b>0.37656</b>	<b>10.22</b>	<b>32.27</b>	<b>27.38</b>	<b>42.49</b>	<b>37.60</b>	<b>58.35</b>	<b>48.35</b>	<b>-15.86</b>	<b>-10.75</b>
4	1.80469	10.30	16.91	12.45	27.21	22.75	56.00	46.00	-28.79	-23.25
5	6.20313	10.41	23.72	18.92	34.13	29.33	60.00	50.00	-25.87	-20.67
6	24.00000	11.43	23.51	22.59	34.94	34.02	60.00	50.00	-25.06	-15.98

#### REMARKS:

1. Q.P. and AV. are abbreviations of quasi-peak and average individually.
2. The emission levels of other frequencies were very low against the limit.
3. Margin value = Emission level - Limit value
4. Correction factor = Insertion loss + Cable loss
5. Emission Level = Correction Factor + Reading Value.

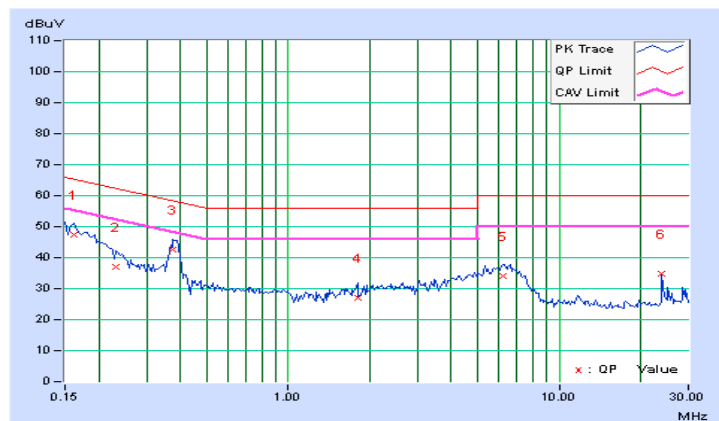

Phase	Neutral (N)	Detector Function	Quasi-Peak (QP) / Average (AV)
-------	-------------	-------------------	--------------------------------

No	Freq. [MHz]	Corr. Factor	Reading Value [dB (uV)]		Emission Level [dB (uV)]		Limit [dB (uV)]		Margin (dB)	
		(dB)	Q.P.	AV.	Q.P.	AV.	Q.P.	AV.	Q.P.	AV.
	1	0.15391	10.19	37.00	20.92	47.19	31.11	65.79	55.79	-18.59
2	0.22031	10.21	28.77	15.56	38.98	25.77	62.81	52.81	-23.83	-27.04
3	0.37656	10.20	32.23	27.22	42.43	37.42	58.35	48.35	-15.92	-10.93
4	2.86328	10.27	19.21	13.53	29.48	23.80	56.00	46.00	-26.52	-22.20
5	5.92578	10.33	24.36	19.65	34.69	29.98	60.00	50.00	-25.31	-20.02
6	24.00000	11.13	24.85	23.95	35.98	35.08	60.00	50.00	-24.02	-14.92

#### REMARKS:

1. Q.P. and AV. are abbreviations of quasi-peak and average individually.
2. The emission levels of other frequencies were very low against the limit.
3. Margin value = Emission level - Limit value
4. Correction factor = Insertion loss + Cable loss
5. Emission Level = Correction Factor + Reading Value.

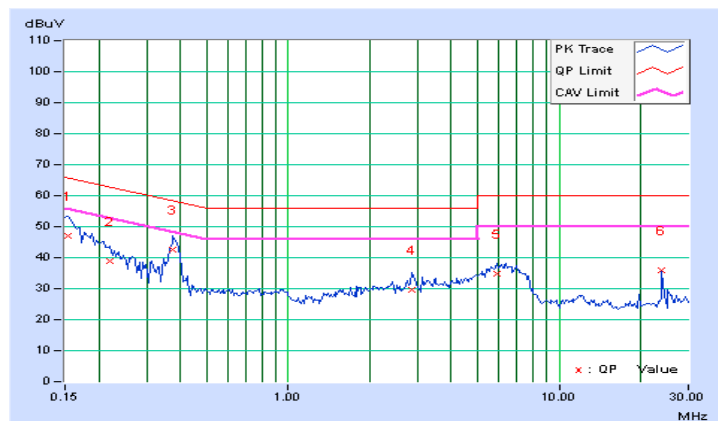

### 4.3 Transmit Power Measurement

#### 4.3.1 Limits of Transmit Power Measurement

Operation Band	EUT Category		Limit
U-NII-1	√	Outdoor Access Point	1 Watt (30 dBm) (Max. e.i.r.p ≤ 125mW(21 dBm) at any elevation angle above 30 degrees as measured from the horizon)
		Fixed point-to-point Access Point	1 Watt (30 dBm)
		Indoor Access Point	1 Watt (30 dBm)
		Mobile and Portable client device	250mW (24 dBm)
U-NII-2A			250mW (24 dBm) or 11 dBm+10 log B*
U-NII-2C			250mW (24 dBm) or 11 dBm+10 log B*
U-NII-3	√		1 Watt (30 dBm)

\*B is the 26 dB emission bandwidth in megahertz

Per KDB 662911 Method of conducted output power measurement on IEEE 802.11 devices,

Array Gain = 0 dB (i.e., no array gain) for  $N_{ANT} \leq 4$ ;

Array Gain = 0 dB (i.e., no array gain) for channel widths  $\geq 40$  MHz for any  $N_{ANT}$ ;

Array Gain =  $5 \log(N_{ANT}/N_{SS})$  dB or 3 dB, whichever is less for 20-MHz channel widths with  $N_{ANT} \geq 5$ .

For power measurements on all other devices: Array Gain =  $10 \log(N_{ANT}/N_{SS})$  dB.

#### 4.3.2 Test Setup

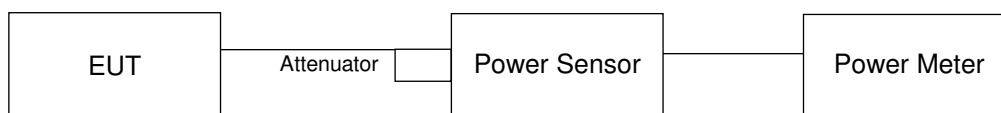

#### 4.3.3 Test Instruments

Refer to section 4.1.2 to get information of above instrument.

#### 4.3.4 Test Procedure

Method PM is used to perform output power measurement, trigger and gating function of wide band power meter is enabled to measure max output power of TX on burst. Duty factor is not added to measured value.

#### 4.3.5 Deviation from Test Standard

No deviation.

#### 4.3.6 EUT Operating Condition

The software provided by client to enable the EUT under transmission condition continuously at lowest, middle and highest channel frequencies individually.

#### 4.3.7 Test Result

##### 802.11a

Chan.	Chan. Freq. (MHz)	Maximum Conducted Power (dBm)		Total Power (mW)	Total Power (dBm)	Limit (dBm)	Pass / Fail
		Chain 0	Chain 1				
36	5180	16.03	16.71	86.968	19.39	26.00	Pass
40	5200	16.39	16.93	92.868	19.68	26.00	Pass
48	5240	16.37	16.82	91.435	19.61	26.00	Pass
149	5745	22.40	22.78	363.451	25.60	26.00	Pass
157	5785	22.54	22.88	373.562	25.72	26.00	Pass
165	5825	22.68	23.02	385.8	25.86	26.00	Pass

**Note:** 1. The directional gain is 10dBi > 6dBi, therefore the limit needs to reduce, so the power limit shall be reduced to  $30 - (10 - 6) = 26\text{dBm}$ .

##### EIRP POWER OUTPUT

Chan.	Chan. Freq. (MHz)	EIRP Power (mW)	EIRP Power (dBm)	Power Limit (dBm)	Pass / Fail
36	5180	107.984	20.33	21.00	Pass
40	5200	115.310	20.62	21.00	Pass
48	5240	113.530	20.55	21.00	Pass

Note: 1. EIRP = Conducted Average Power + Antenna Gain

2. Maximum Antenna Gain = 0.94 (above 30 degrees from the horizon)

### 802.11ac (VHT20)

Chan.	Chan. Freq. (MHz)	Maximum Conducted Power (dBm)		Total Power (mW)	Total Power (dBm)	Limit (dBm)	Pass / Fail
		Chain 0	Chain 1				
36	5180	16.18	16.76	88.919	19.49	26.00	Pass
40	5200	16.53	17.19	97.338	19.88	26.00	Pass
48	5240	16.63	17.06	96.842	19.86	26.00	Pass
149	5745	21.98	22.42	332.343	25.22	26.00	Pass
157	5785	22.89	23.04	395.908	25.98	26.00	Pass
165	5825	22.70	23.08	389.445	25.90	26.00	Pass

**Note:** 1. The directional gain is 10dBi > 6dBi, therefore the limit needs to reduce, so the power limit shall be reduced to  $30 - (10 - 6) = 26\text{dBm}$ .

### EIRP POWER OUTPUT

Chan.	Chan. Freq. (MHz)	EIRP Power (mW)	EIRP Power (dBm)	Power Limit (dBm)	Pass / Fail
36	5180	110.406	20.43	21.00	Pass
40	5200	120.860	20.82	21.00	Pass
48	5240	120.244	20.80	21.00	Pass

Note: 1. EIRP = Conducted Average Power + Antenna Gain  
 2. Maximum Antenna Gain = 0.94 (above 30 degrees from the horizon)

### 802.11ac (VHT40)

Chan.	Chan. Freq. (MHz)	Maximum Conducted Power (dBm)		Total Power (mW)	Total Power (dBm)	Limit (dBm)	Pass / Fail
		Chain 0	Chain 1				
38	5190	15.86	15.89	77.363	18.89	26.00	Pass
46	5230	16.54	16.97	94.856	19.77	26.00	Pass
151	5755	22.70	23.07	388.977	25.90	26.00	Pass
159	5795	22.81	23.09	394.689	25.96	26.00	Pass

**Note:** 1. The directional gain is 10dBi > 6dBi, therefore the limit needs to reduce, so the power limit shall be reduced to  $30 - (10 - 6) = 26$ dBm.

### EIRP POWER OUTPUT

Chan.	Chan. Freq. (MHz)	EIRP Power (mW)	EIRP Power (dBm)	Power Limit (dBm)	Pass / Fail
38	5190	96.058	19.83	21.00	Pass
46	5230	117.778	20.71	21.00	Pass

Note: 1. EIRP = Conducted Average Power + Antenna Gain  
 2. Maximum Antenna Gain = 0.94 (above 30 degrees from the horizon)



### 802.11ac (VHT80)

Chan.	Chan. Freq. (MHz)	Maximum Conducted Power (dBm)		Total Power (mW)	Total Power (dBm)	Limit (dBm)	Pass / Fail
		Chain 0	Chain 1				
42	5210	13.65	13.37	44.901	16.52	26.00	Pass
155	5775	20.95	20.80	244.677	23.89	26.00	Pass

**Note:** 1. The directional gain is 10dBi > 6dBi, therefore the limit needs to reduce, so the power limit shall be reduced to  $30 - (10 - 6) = 26$  dBm.

### EIRP POWER OUTPUT

Chan.	Chan. Freq. (MHz)	EIRP Power (mW)	EIRP Power (dBm)	Power Limit (dBm)	Pass / Fail
42	5210	55.751	17.46	21.00	Pass

Note: 1. EIRP = Conducted Average Power + Antenna Gain

2. Maximum Antenna Gain = 0.94 (above 30 degrees from the horizon)

## 4.4 Occupied Bandwidth Measurement

### 4.4.1 Test Setup



### 4.4.2 Test Instruments

Refer to section 4.1.2 to get information of above instrument.

### 4.4.3 Test Procedure

The transmitter output was connected to the spectrum analyzer through an attenuator. The bandwidth of the fundamental frequency was measured by spectrum analyzer with resolution bandwidth in the range of 1% to 5% of the anticipated emission bandwidth, and a video bandwidth at least 3x the resolution bandwidth and set the detector to SAMPLE. The width of a frequency band such that, below the lower and above the upper frequency limits, the mean powers emitted are each equal to a specified percentage 0.5 %of the total mean power of a given emission.

### 4.4.4 Test Results

#### 802.11a

Channel	Channel Frequency (MHz)	Occupied Bandwidth (MHz)	
		CHAIN 0	CHAIN 1
36	5180	16.68	16.68
40	5200	16.80	16.80
48	5240	16.80	16.68
149	5745	16.80	16.68
157	5785	16.92	16.92
165	5825	16.68	17.04

### 802.11ac (VHT20)

Channel	Channel Frequency (MHz)	Occupied Bandwidth (MHz)	
		CHAIN 0	CHAIN 1
36	5180	18.00	18.00
40	5200	17.88	17.88
48	5240	18.00	17.88
149	5745	18.00	18.00
157	5785	17.88	18.00
165	5825	17.88	18.00

### 802.11ac (VHT40)

Channel	Channel Frequency (MHz)	Occupied Bandwidth (MHz)	
		CHAIN 0	CHAIN 1
38	5190	36.72	36.72
46	5230	36.72	36.72
151	5755	36.96	37.44
159	5795	36.72	36.96

### 802.11ac (VHT80)

Channel	Channel Frequency (MHz)	Occupied Bandwidth (MHz)	
		CHAIN 0	CHAIN 1
42	5210	75.84	75.84
155	5775	76.32	76.32

### Spectrum Plot of Worst Value

**802.11a\_Chain0 / CH36**

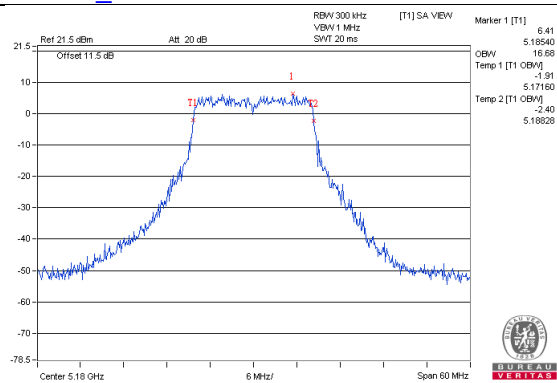

**802.11ac (VHT20)\_Chain0 / CH40**

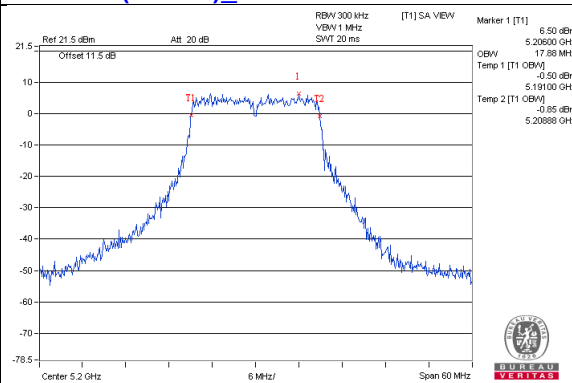

**802.11ac (VHT40)\_Chain0 / CH38**

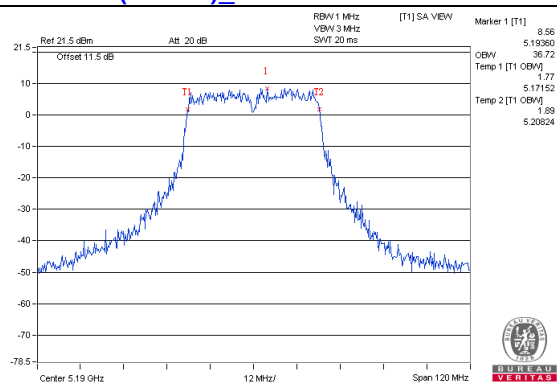

**802.11ac (VHT80)\_Chain0 / CH42**

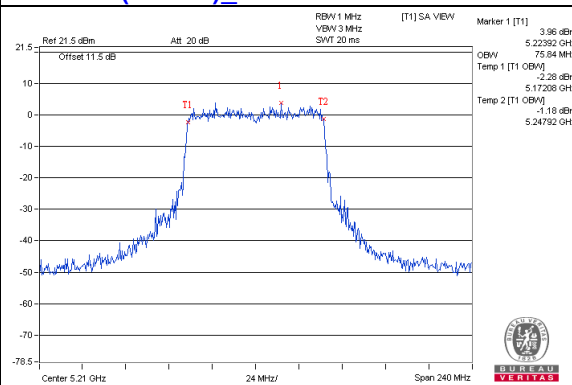

**Spectrum Plot for near by DFS band  
(DFS is required, if 99% OCP straddle into U-NII-2A band)**

**802.11a\_Chain0 / CH48**

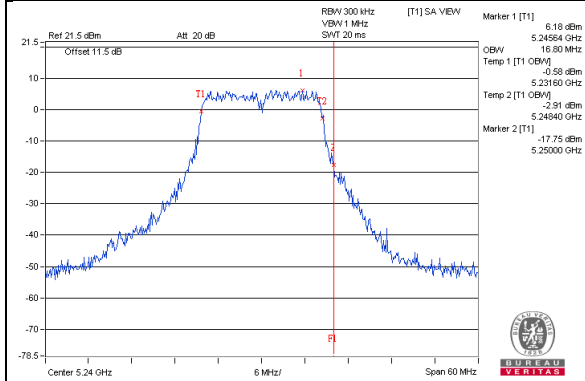

**802.11a\_Chain1 / CH48**

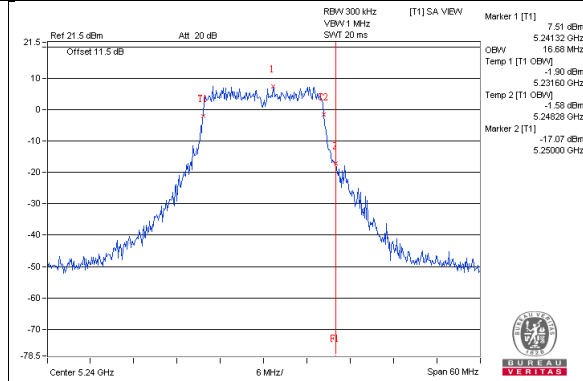

**802.11ac(VHT20)\_Chain0 / CH48**

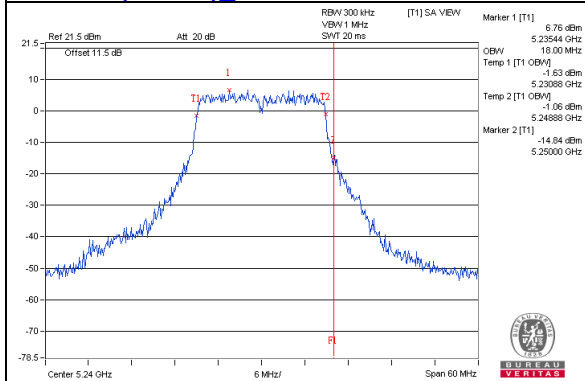

**802.11ac(VHT20)\_Chain1 / CH48**

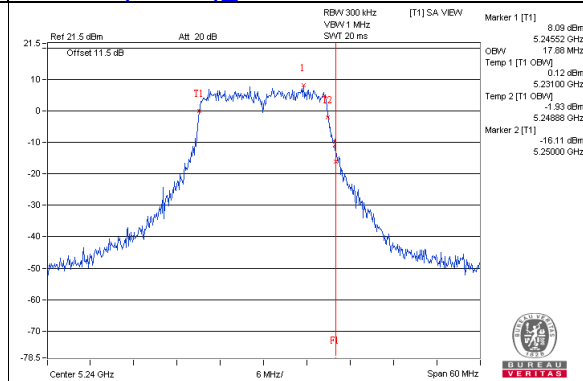

**802.11ac(VHT40)\_Chain0 / CH46**

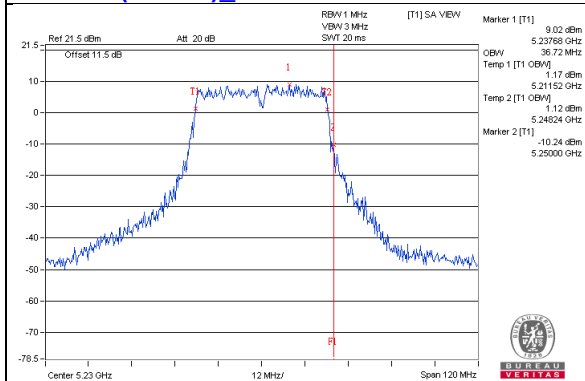

**802.11ac(VHT20)\_Chain1 / CH46**

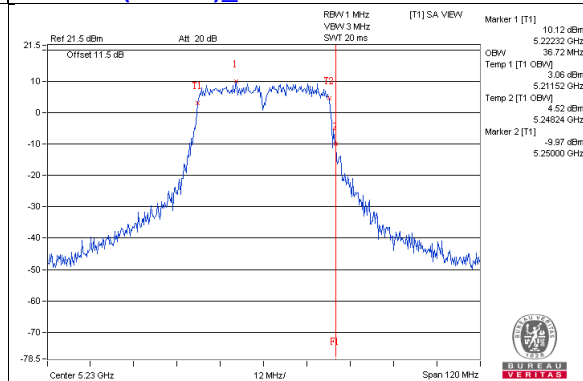

**802.11ac(VHT80)\_Chain0 / CH42**

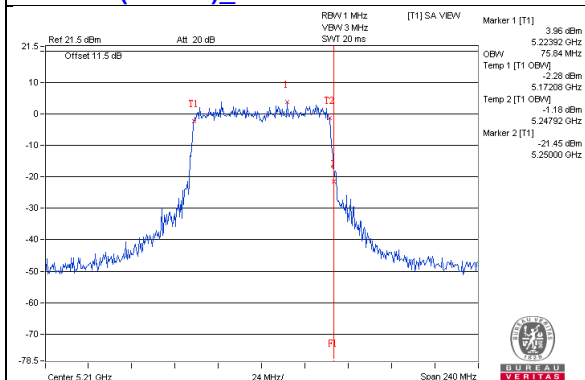

**802.11ac(VHT80)\_Chain1 / CH42**

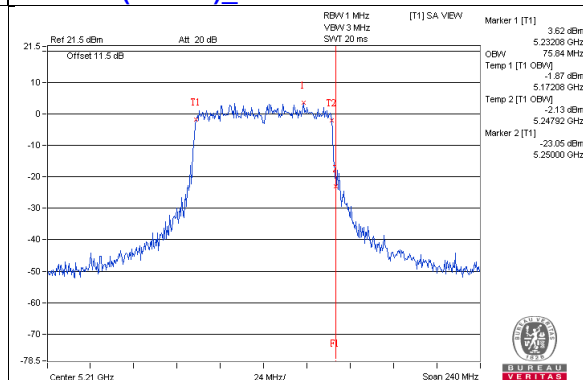

## 4.5 Peak Power Spectral Density Measurement

### 4.5.1 Limits of Peak Power Spectral Density Measurement

Operation Band	EUT Category		Limit
U-NII-1	√	Outdoor Access Point	17dBm/ MHz
		Fixed point-to-point Access Point	
		Indoor Access Point	
		Mobile and Portable client device	11dBm/ MHz
U-NII-2A			11dBm/ MHz
U-NII-2C			11dBm/ MHz
U-NII-3		√	30dBm/ 500kHz

### 4.5.2 Test Setup

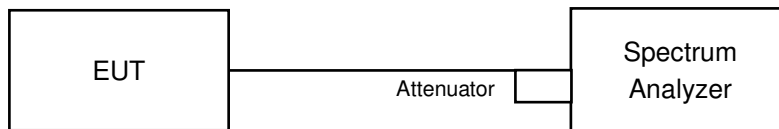

### 4.5.3 Test Instruments

Refer to section 4.1.2 to get information of above instrument.

#### 4.5.4 Test Procedure

##### **802.11a, 802.11ac (VHT20)**

###### **For U-NII-1:**

Using method SA-1

1. Set span to encompass the entire emission bandwidth (EBW) of the signal.
2. Set RBW = 1 MHz, Set VBW  $\geq$  3 MHz, Detector = RMS
3. Sweep time = auto, trigger set to "free run".
4. Trace average at least 100 traces in power averaging mode.
5. Record the max value

###### **For U-NII-3:**

1. Set span to encompass the entire emission bandwidth (EBW) of the signal.
2. Set RBW = 300 kHz, Set VBW  $\geq$  1 MHz, Detector = RMS
3. Use the peak marker function to determine the maximum power level in any 300 kHz band segment within the fundamental EBW.
4. Scale the observed power level to an equivalent value in 500 kHz by adjusting (reducing) the measured power by a bandwidth correction factor (BWCF) where  $BWCF = 10\log(500 \text{ kHz}/300\text{kHz})$
5. Sweep time = auto, trigger set to "free run".
6. Trace average at least 100 traces in power averaging mode.
7. Record the max value

##### **802.11ac (VHT40), 802.11ac (VHT80)**

###### **For U-NII-1:**

Using method SA-2

1. Set span to encompass the entire emission bandwidth (EBW) of the signal.
2. Set RBW = 1 MHz, Set VBW  $\geq$  3 MHz, Detector = RMS
3. Sweep time = auto, trigger set to "free run".
4. Trace average at least 100 traces in power averaging mode.
5. Record the max value and add  $10 \log (1/\text{duty cycle})$

###### **For U-NII-3:**

1. Set span to encompass the entire emission bandwidth (EBW) of the signal.
2. Set RBW = 300 kHz, Set VBW  $\geq$  1 MHz, Detector = RMS
3. Use the peak marker function to determine the maximum power level in any 300 kHz band segment within the fundamental EBW.
4. Scale the observed power level to an equivalent value in 500 kHz by adjusting (reducing) the measured power by a bandwidth correction factor (BWCF) where  $BWCF = 10\log(500 \text{ kHz}/300\text{kHz})$
5. Sweep time = auto, trigger set to "free run".
6. Trace average at least 100 traces in power averaging mode.
7. Record the max value and add  $10 \log (1/\text{duty cycle})$

#### 4.5.5 Deviation from Test Standard

No deviation.

#### 4.5.6 EUT Operating Condition

Same as Item 4.3.6.

#### 4.5.7 Test Results

#### For U-NII-1:

#### 802.11a

Chan.	Chan. Freq. (MHz)	PSD (dBm/MHz)		Total Power Density (dBm/MHz)	MAX. Limit (dBm/MHz)	Pass / Fail
		Chain 0	Chain 1			
36	5180	-4.82	2.86	3.54	9.99	Pass
40	5200	2.43	3.46	5.99	9.99	Pass
48	5240	2.52	3.21	5.89	9.99	Pass

- Note:** 1. Method a) of power density measurement of KDB 662911 is using for calculating total power density. Total power density is summing entire spectra across corresponding frequency bins on the various outputs by computer.
2. Directional gain =  $10\text{dBi} + 10\log(2) = 13.01\text{dBi} > 6\text{dBi}$ , so the power density limit shall be reduced to  $17 - (13.01 - 6) = 9.99\text{dBm}$ .

#### 802.11ac (VHT20)

Chan.	Chan. Freq. (MHz)	PSD (dBm/MHz)		Total Power Density (dBm/MHz)	MAX. Limit (dBm/MHz)	Pass / Fail
		Chain 0	Chain 1			
36	5180	1.81	2.83	5.36	9.99	Pass
40	5200	2.03	3.25	5.69	9.99	Pass
48	5240	2.06	3.47	5.83	9.99	Pass

- Note:** 1. Method a) of power density measurement of KDB 662911 is using for calculating total power density. Total power density is summing entire spectra across corresponding frequency bins on the various outputs by computer.
2. Directional gain =  $10\text{dBi} + 10\log(2) = 13.01\text{dBi} > 6\text{dBi}$ , so the power density limit shall be reduced to  $17 - (13.01 - 6) = 9.99\text{dBm}$ .

#### 802.11ac (VHT40)

Chan.	Chan. Freq. (MHz)	PSD W/O Duty Factor (dBm/MHz)		Duty Factor (dB)	Total PSD With Duty Factor (dBm/MHz)	MAX. Limit (dBm/MHz)	Pass / Fail
		Chain 0	Chain 1				
38	5190	-1.32	-0.93	0.32	2.21	9.99	Pass
46	5230	-0.99	-0.06	0.32	2.83	9.99	Pass

- Note:** 1. Method a) of power density measurement of KDB 662911 is using for calculating total power density. Total power density is summing entire spectra across corresponding frequency bins on the various outputs by computer.
2. Directional gain =  $10\text{dBi} + 10\log(2) = 13.01\text{dBi} > 6\text{dBi}$ , so the power density limit shall be reduced to  $17 - (13.01 - 6) = 9.99\text{dBm}$ .
3. Refer to section 3.3 for duty cycle spectrum plot.



### 802.11ac (VHT80)

Chan.	Chan. Freq. (MHz)	PSD W/O Duty Factor (dBm/MHz)		Duty Factor (dB)	Total PSD With Duty Factor (dBm/MHz)	MAX. Limit (dBm/MHz)	Pass / Fail
		Chain 0	Chain 1				
42	5210	-6.63	-6.49	0.27	-3.27	9.99	Pass

- Note:**
1. Method a) of power density measurement of KDB 662911 is using for calculating total power density. Total power density is summing entire spectra across corresponding frequency bins on the various outputs by computer.
  2. Directional gain =  $10\text{dBi} + 10\log(2) = 13.01\text{dBi} > 6\text{dBi}$  , so the power density limit shall be reduced to  $17 - (13.01 - 6) = 9.99\text{dBm}$ .
  3. Refer to section 3.3 for duty cycle spectrum plot.

Spectrum Plot of Worst Value

802.11a\_Chain 1 / CH40

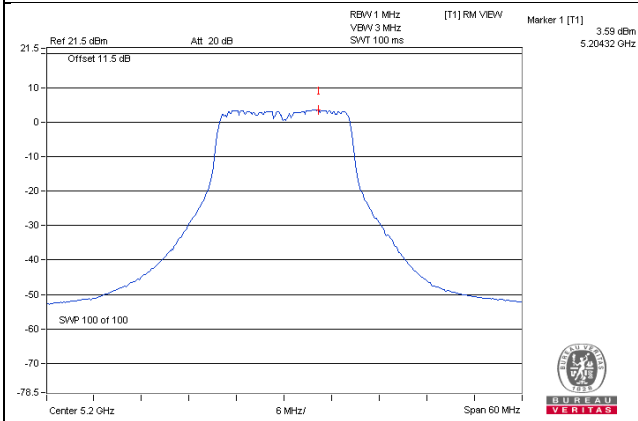

802.11ac (VHT20)\_Chain 1 / CH48

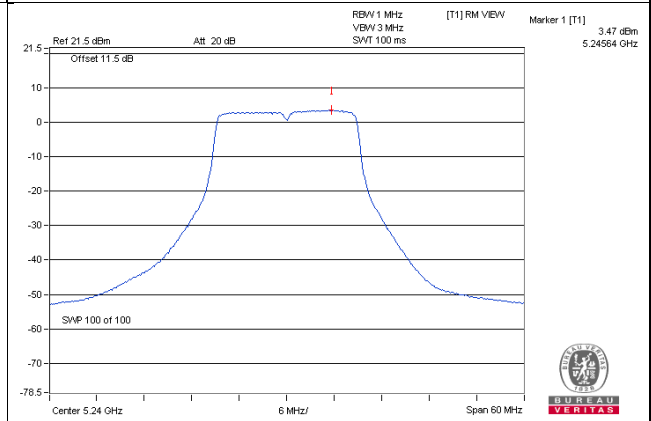

802.11ac (VHT40)\_Chain 1 / CH46

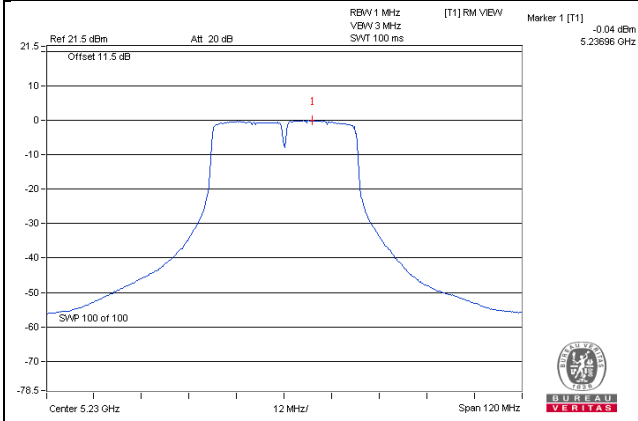

802.11ac (VHT80)\_Chain 1 / CH42

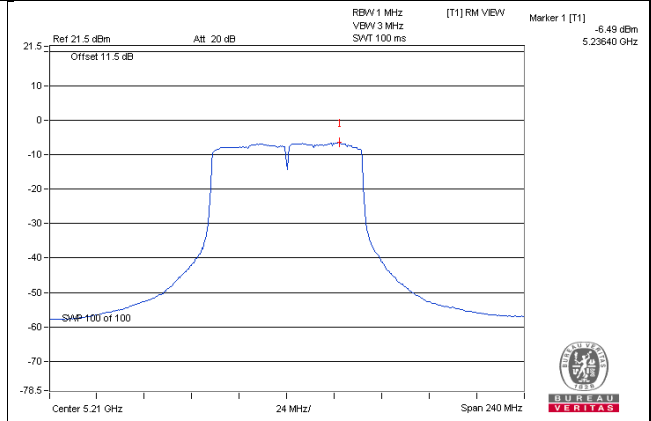

### For U-NII-3:

#### 802.11a

TX chain	Channel	Freq. (MHz)	PSD (dBm/300kHz)	PSD (dBm/500kHz)	10 log (N=2) dB	Total PSD (dBm/500kHz)	Limit (dBm/500kHz)	Pass /Fail
0	149	5745	1.43	3.65	3.01	6.66	22.99	Pass
	157	5785	1.42	3.64	3.01	6.65	22.99	Pass
	165	5825	1.75	3.97	3.01	6.98	22.99	Pass
1	149	5745	1.54	3.76	3.01	6.77	22.99	Pass
	157	5785	1.82	4.04	3.01	7.05	22.99	Pass
	165	5825	1.94	4.16	3.01	7.17	22.99	Pass

**Note:** 1. Directional gain =  $10\text{dBi} + 10\log(2) = 13.01\text{dBi} > 6\text{dBi}$ , so the power density limit shall be reduced to  $30 - (13.01 - 6) = 22.99\text{dBm}$ .

#### 802.11ac (VHT20)

TX chain	Channel	Freq. (MHz)	PSD (dBm/300kHz)	PSD (dBm/500kHz)	10 log (N=2) dB	Total PSD (dBm/500kHz)	Limit (dBm/500kHz)	Pass /Fail
0	149	5745	0.26	2.48	3.01	5.49	22.99	Pass
	157	5785	1.50	3.72	3.01	6.73	22.99	Pass
	165	5825	0.62	2.84	3.01	5.85	22.99	Pass
1	149	5745	0.50	2.72	3.01	5.73	22.99	Pass
	157	5785	1.58	3.80	3.01	6.81	22.99	Pass
	165	5825	1.36	3.58	3.01	6.59	22.99	Pass

**Note:** 1. Directional gain =  $10\text{dBi} + 10\log(2) = 13.01\text{dBi} > 6\text{dBi}$ , so the power density limit shall be reduced to  $30 - (13.01 - 6) = 22.99\text{dBm}$ .

#### 802.11ac (VHT40)

TX chain	Chan.	Chan. Freq. (MHz)	PSD W/O Duty Factor		10 log (N=2) dB	Duty Factor (dB)	Total PSD With Duty Factor (dBm/500kHz)	Limit (dBm/500kHz)	Pass /Fail
			(dBm/300kHz)	(dBm/500kHz)					
0	151	5755	-2.42	-0.20	3.01	0.32	3.13	22.99	Pass
	159	5795	-1.96	0.26	3.01	0.32	3.59	22.99	Pass
1	151	5755	-2.06	0.16	3.01	0.32	3.49	22.99	Pass
	159	5795	-2.28	-0.06	3.01	0.32	3.27	22.99	Pass

**Note:** 1. Directional gain =  $10\text{dBi} + 10\log(2) = 13.01\text{dBi} > 6\text{dBi}$ , so the power density limit shall be reduced to  $30 - (13.01 - 6) = 22.99\text{dBm}$ .

2. Refer to section 3.3 for duty cycle spectrum plot.

### 802.11ac (VHT80)

TX chain	Chan.	Chan. Freq. (MHz)	PSD W/O Duty Factor		10 log (N=2) dB	Duty Factor (dB)	Total PSD With Duty Factor (dBm/500kHz)	Limit (dBm/500kHz)	Pass /Fail
			(dBm/300kHz)	(dBm/500kHz)					
0	155	5775	-7.55	-5.33	3.01	0.27	-2.05	22.99	Pass
1	155	5775	-8.31	-6.09	3.01	0.27	-2.81	22.99	Pass

**Note:** 1. Directional gain =  $10\text{dBi} + 10\log(2) = 13.01\text{dBi} > 6\text{dBi}$  , so the power density limit shall be reduced to  $30 - (13.01 - 6) = 22.99\text{dBm}$ .

2. Refer to section 3.3 for duty cycle spectrum plot.

Spectrum Plot of Worst Value

802.11a\_Chain 1 / CH165

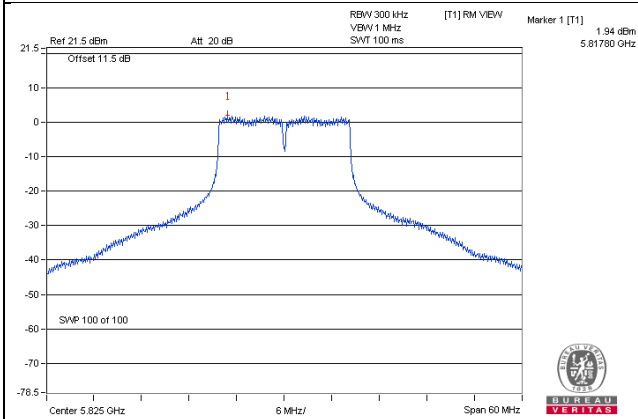

802.11ac (VHT20)\_Chain 1 / CH157

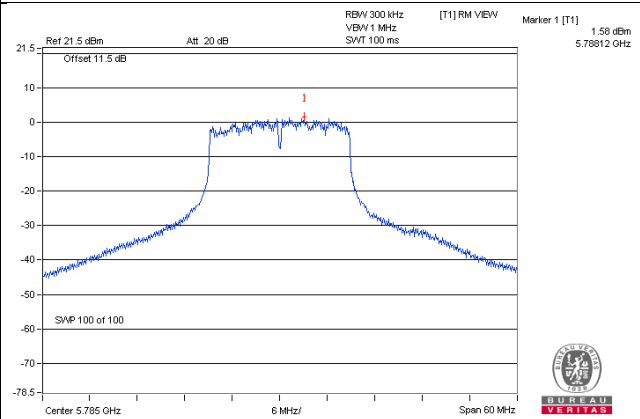

802.11ac (VHT40)\_Chain 0 / CH159

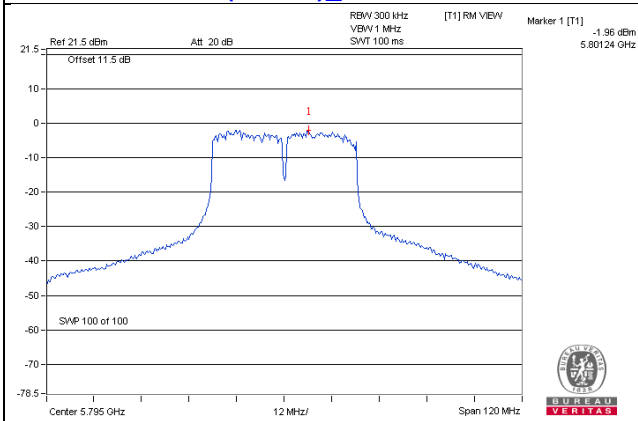

802.11ac (VHT80)\_Chain 0 / CH155

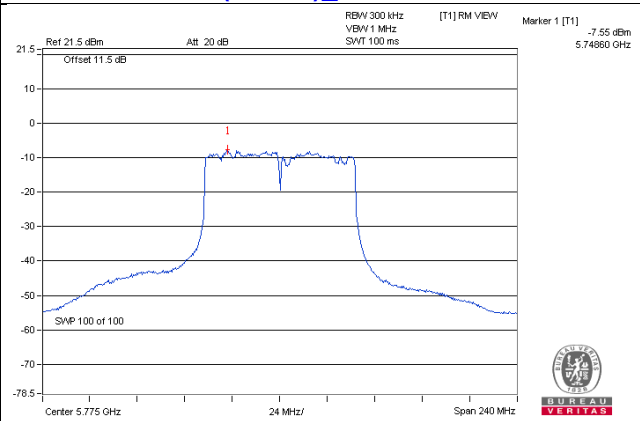

## 4.6 Frequency Stability Measurement

### 4.6.1 Limits of Frequency Stability Measurement

The frequency of the carrier signal shall be maintained within band of operation

### 4.6.2 Test Setup

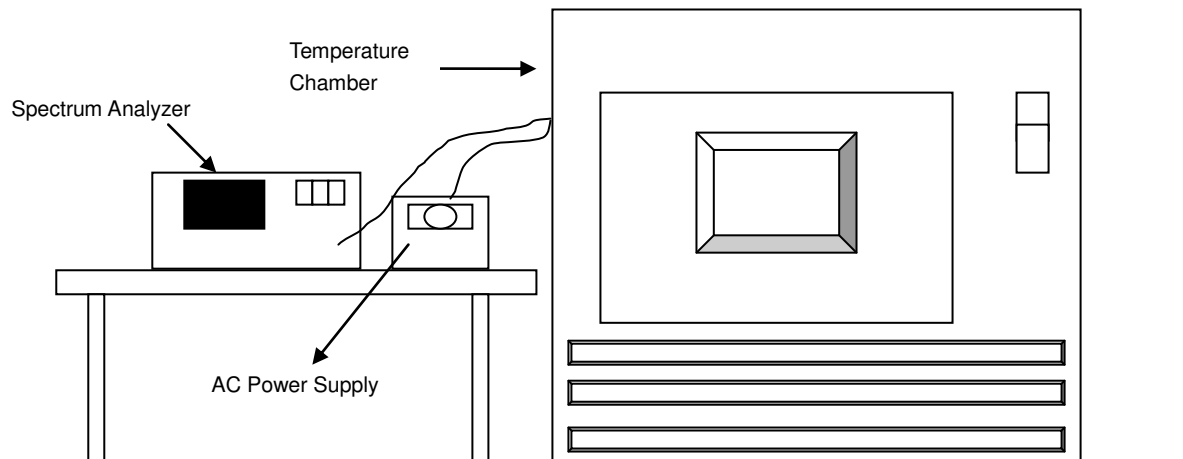

### 4.6.3 Test Instruments

Refer to section 4.1.2 to get information of above instrument.

### 4.6.4 Test Procedure

- The EUT was placed inside the environmental test chamber and powered by nominal AC voltage.
- Turn the EUT on and couple its output to a spectrum analyzer.
- Turn the EUT off and set the chamber to the highest temperature specified.
- Allow sufficient time (approximately 30 min) for the temperature of the chamber to stabilize, turn the EUT on and measure the operating frequency after 2, 5, and 10 Minutes.
- Repeat step 2 and 3 with the temperature chamber set to the lowest temperature.
- The test chamber was allowed to stabilize at +20 degree C for a minimum of 30 Minutes. The supply voltage was then adjusted on the EUT from 85% to 115% and the frequency record.

### 4.6.5 Deviation from Test Standard

No deviation.

### 4.6.6 EUT Operating Condition

Set the EUT transmit at un-modulation mode to test frequency stability.

## 4.6.7 Test Results

Frequency Stability Versus Temp.									
Operating Frequency: 5180 MHz									
TEMP. (°C)	Power Supply (Vac)	0 Minute		2 Minute		5 Minute		10 Minute	
		Measured Frequency (MHz)	Pass/Fail	Measured Frequency (MHz)	Pass/Fail	Measured Frequency (MHz)	Pass/Fail	Measured Frequency (MHz)	Pass/Fail
50	120	5179.9951	Pass	5179.9969	Pass	5179.9945	Pass	5179.9969	Pass
40	120	5179.9854	Pass	5179.9867	Pass	5179.984	Pass	5179.9831	Pass
30	120	5179.9745	Pass	5179.9744	Pass	5179.977	Pass	5179.9735	Pass
20	120	5179.9772	Pass	5179.9751	Pass	5179.9754	Pass	5179.9787	Pass
10	120	5179.9916	Pass	5179.9911	Pass	5179.9878	Pass	5179.9895	Pass
0	120	5179.9782	Pass	5179.9786	Pass	5179.9805	Pass	5179.9802	Pass
-10	120	5180.0221	Pass	5180.0209	Pass	5180.0241	Pass	5180.0225	Pass
-20	120	5179.9907	Pass	5179.9896	Pass	5179.9906	Pass	5179.9916	Pass
-30	120	5180.0047	Pass	5180.0075	Pass	5180.0045	Pass	5180.0059	Pass

Frequency Stability Versus Voltage									
Operating Frequency: 5180 MHz									
TEMP. (°C)	Power Supply (Vac)	0 Minute		2 Minute		5 Minute		10 Minute	
		Measured Frequency (MHz)	Pass/Fail	Measured Frequency (MHz)	Pass/Fail	Measured Frequency (MHz)	Pass/Fail	Measured Frequency (MHz)	Pass/Fail
20	138	5179.9779	Pass	5179.9751	Pass	5179.9757	Pass	5179.9784	Pass
	120	5179.9772	Pass	5179.9751	Pass	5179.9754	Pass	5179.9787	Pass
	102	5179.9766	Pass	5179.9743	Pass	5179.9745	Pass	5179.9788	Pass

## 4.7 6dB Bandwidth Measurement

### 4.7.1 Limits of 6dB Bandwidth Measurement

The minimum of 6dB Bandwidth Measurement is 0.5MHz.

### 4.7.2 Test Setup

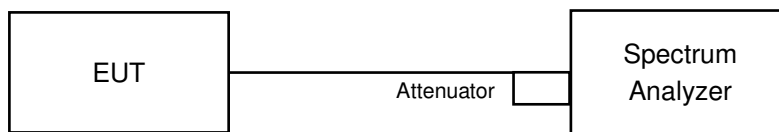

### 4.7.3 Test Instruments

Refer to section 4.1.2 to get information of above instrument.

### 4.7.4 Test Procedure

#### MEASUREMENT PROCEDURE REF

- a. Set resolution bandwidth (RBW) = 100kHz
- b. Set the video bandwidth (VBW)  $\geq 3 \times$  RBW, Detector = Peak.
- c. Trace mode = max hold.
- d. Sweep = auto couple.
- e. Measure the maximum width of the emission that is constrained by the frequencies associated with the two amplitude points (upper and lower) that are attenuated by 6 dB relative to the maximum level measured in the fundamental emission

### 4.7.5 Deviation from Test Standard

No deviation.

### 4.7.6 EUT Operating Condition

The software provided by client to enable the EUT under transmission condition continuously at lowest, middle and highest channel frequencies individually.



#### 4.7.7 Test Results

##### 802.11a

Channel	Frequency (MHz)	6dB Bandwidth (MHz)		Minimum Limit (MHz)	Pass / Fail
		Chain 0	Chain 1		
149	5745	16.40	16.38	0.5	Pass
157	5785	16.42	16.39	0.5	Pass
165	5825	16.42	16.42	0.5	Pass

##### 802.11ac (VHT20)

Channel	Frequency (MHz)	6dB Bandwidth (MHz)		Minimum Limit (MHz)	Pass / Fail
		Chain 0	Chain 1		
149	5745	17.64	17.66	0.5	Pass
157	5785	17.61	17.19	0.5	Pass
165	5825	17.64	17.62	0.5	Pass

##### 802.11ac (VHT40)

Channel	Frequency (MHz)	6dB Bandwidth (MHz)		Minimum Limit (MHz)	Pass / Fail
		Chain 0	Chain 1		
151	5755	35.73	36.42	0.5	Pass
159	5795	36.04	36.42	0.5	Pass

##### 802.11ac (VHT80)

Channel	Frequency (MHz)	6dB Bandwidth (MHz)		Minimum Limit (MHz)	Pass / Fail
		Chain 0	Chain 1		
155	5775	76.31	73.67	0.5	Pass

### Spectrum Plot of Worst Value

**802.11a / Chain 1 : CH149**

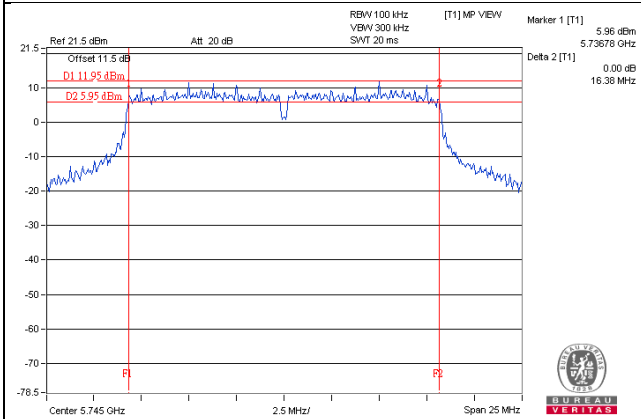

**802.11ac(VHT20) / Chain 1 : CH157**

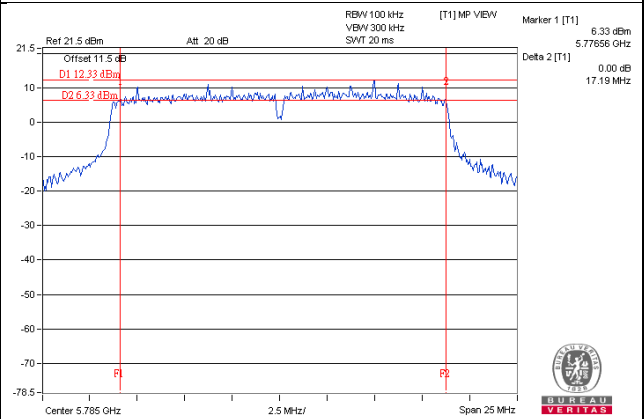

**802.11ac(VHT40) / Chain 0 : CH151**

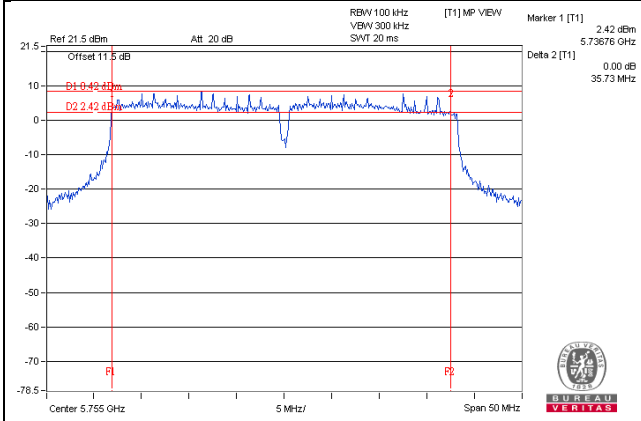

**802.11ac(VHT80) / Chain 1 : CH155**

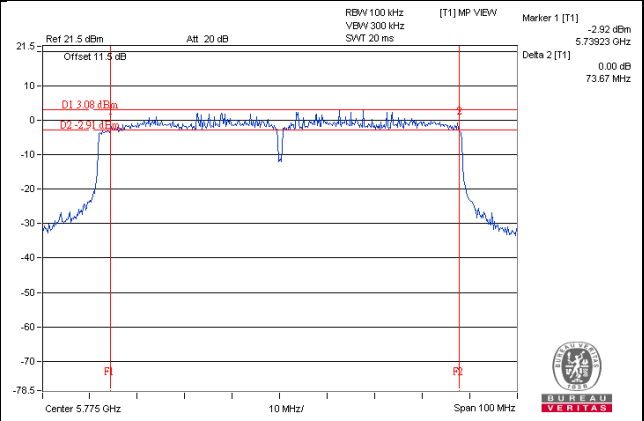

## 5 Pictures of Test Arrangements

Please refer to the attached file (Test Setup Photo).

### Annex A- Radiated Out of Band Emisison (OOBE) Measurement (For U-NII-3 band)

802.11a

**CH 149 5745 MHz**

**Horizontal**

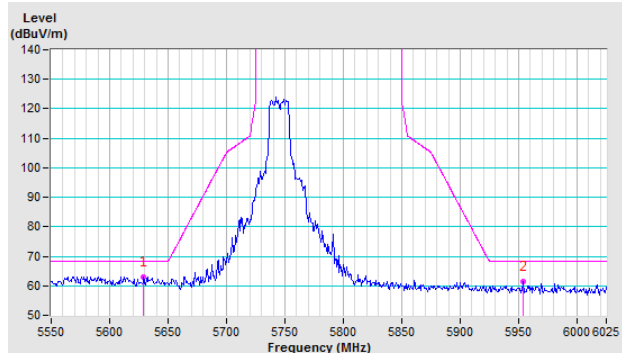

**Vertical**

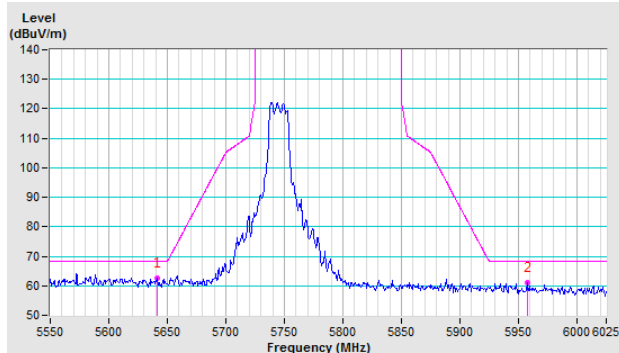

**CH 157 5785 MHz**

**Horizontal**

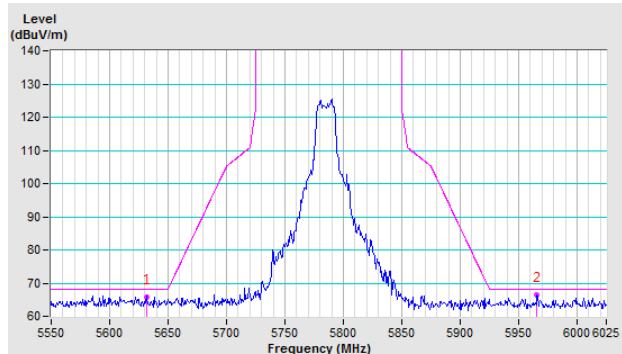

**Vertical**

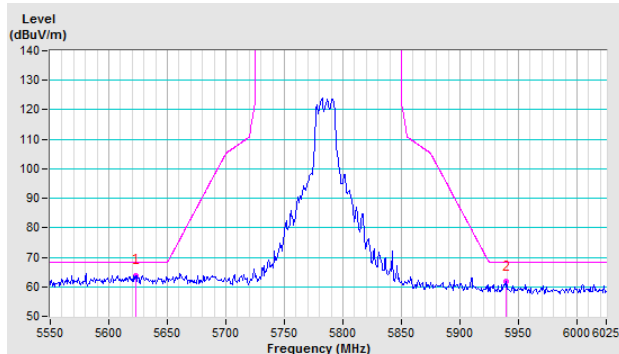

**CH 165 5825 MHz**

**Horizontal**

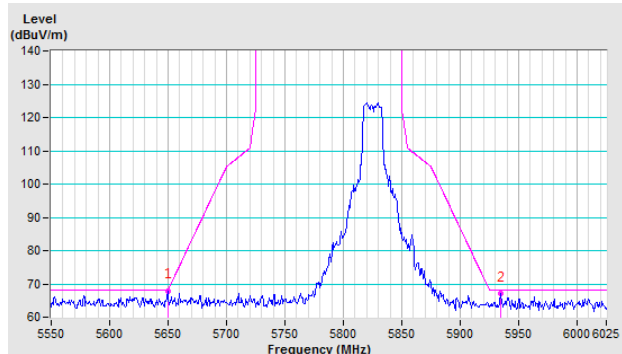

**Vertical**

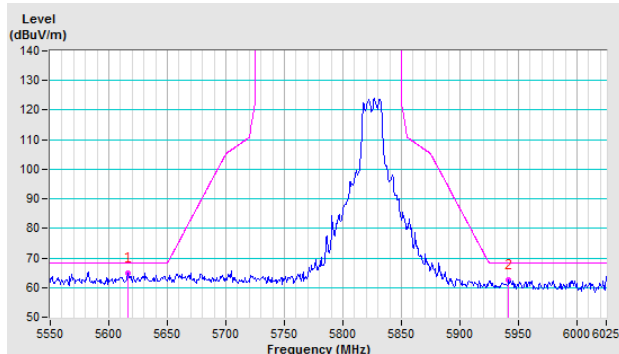

802.11ac (VHT20)

CH 149 5745 MHz

Horizontal

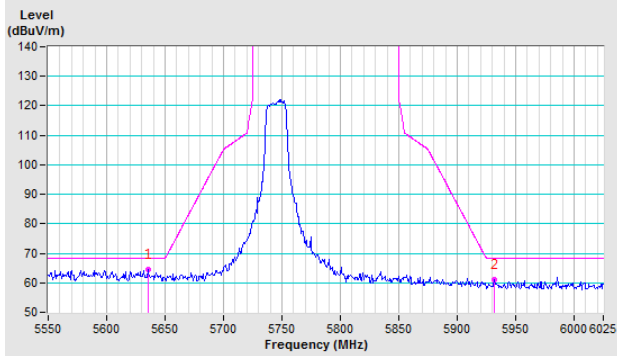

Vertical

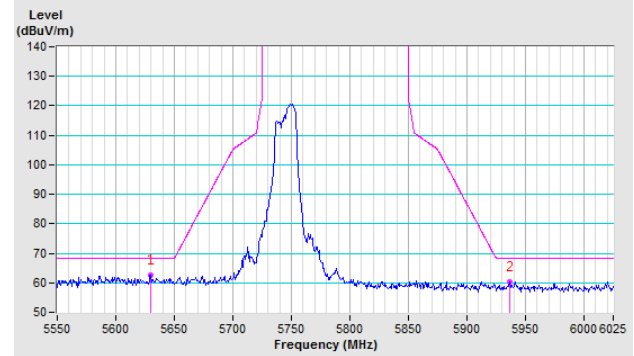

CH 157 5785 MHz

Horizontal

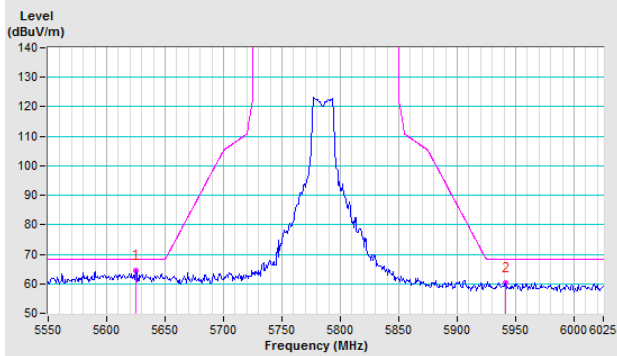

Vertical

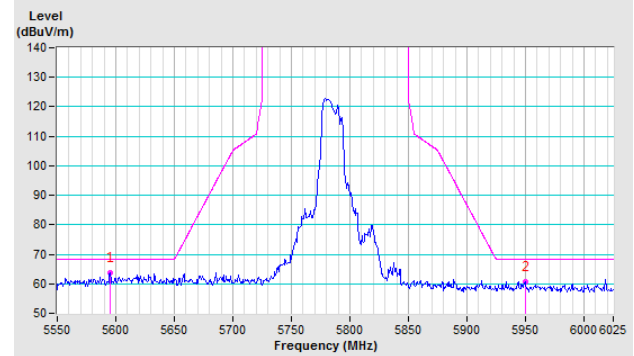

CH 165 5825 MHz

Horizontal

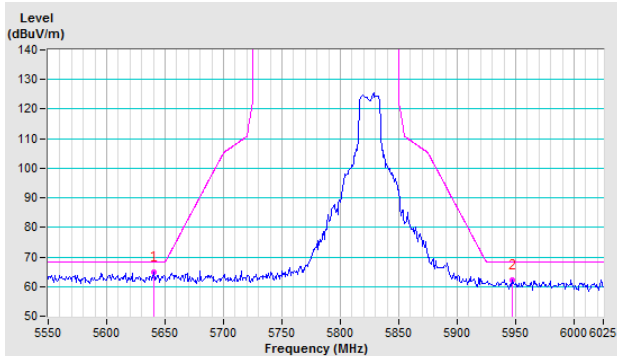

Vertical

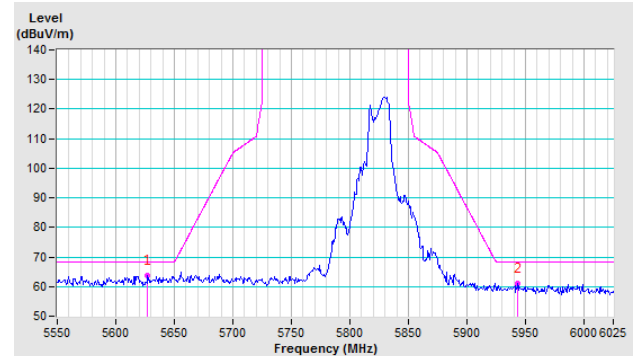

### 802.11ac (VHT40)

CH 151 5755 MHz

Horizontal

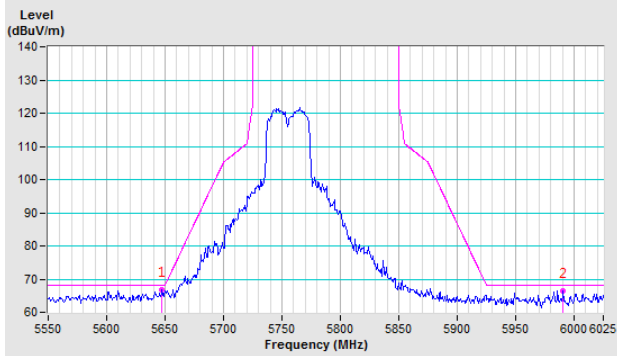

Vertical

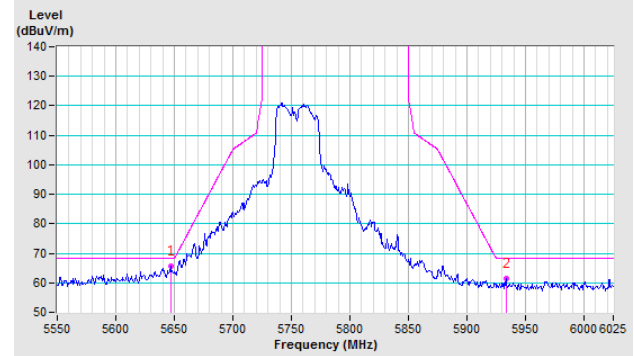

CH 159 5795 MHz

Horizontal

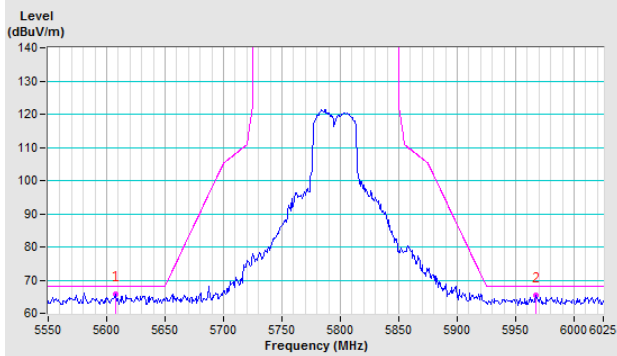

Vertical

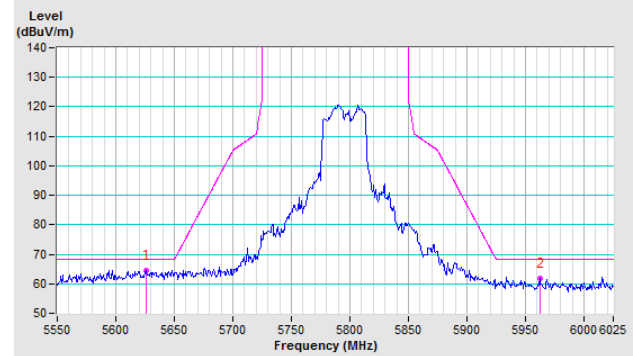

### 802.11ac (VHT80)

CH 155 5775 MHz

Horizontal

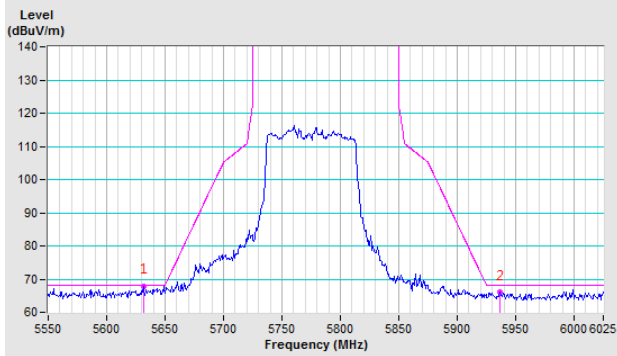

Vertical

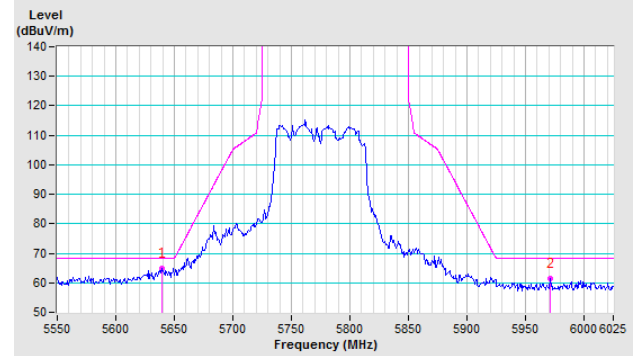

## Appendix – Information on the Testing Laboratories

We, Bureau Veritas Consumer Products Services (H.K.) Ltd., Taoyuan Branch, were founded in 1988 to provide our best service in EMC, Radio, Telecom and Safety consultation. Our laboratories are accredited and approved according to ISO/IEC 17025.

If you have any comments, please feel free to contact us at the following:

**Linko EMC/RF Lab**

Tel: 886-2-26052180

Fax: 886-2-26051924

**Hsin Chu EMC/RF/Telecom Lab**

Tel: 886-3-6668565

Fax: 886-3-6668323

**Hwa Ya EMC/RF/Safety Lab**

Tel: 886-3-3183232

Fax: 886-3-3270892

**Email:** [service.adt@tw.bureauveritas.com](mailto:service.adt@tw.bureauveritas.com)

**Web Site:** [www.bureauveritas-adt.com](http://www.bureauveritas-adt.com)

The address and road map of all our labs can be found in our web site also.

--- END ---