

FCC Test Report

Report No.: RF160606E02

FCC ID: W59XWOBAP1

Test Model: XWO-BAP1

Received Date: June 06, 2016

Test Date: June 17 to 29, 2016

Issued Date: July 26, 2016

Applicant: Luxul Wireless

Address: 14203 Minuteman Dr Suite 201 Draper UT 84020 USA

Issued By: Bureau Veritas Consumer Products Services (H.K.) Ltd., Taoyuan Branch
Hsin Chu Laboratory

Lab Address: E-2, No.1, Li Hsin 1st Road, Hsinchu Science Park, Hsinchu City 300,
Taiwan R.O.C.

Test Location (1): E-2, No.1, Li Hsin 1st Road, Hsinchu Science Park, Hsinchu City 300,
Taiwan R.O.C.

Test Location (2): No. 49, Ln. 206, Wende Rd., Shangshan Tsuen, Chiung Lin Hsiang, Hsin
Chu Hsien 307, Taiwan R.O.C.



This report is for your exclusive use. Any copying or replication of this report to or for any other person or entity, or use of our name or trademark, is permitted only with our prior written permission. This report sets forth our findings solely with respect to the test samples identified herein. The results set forth in this report are not indicative or representative of the quality or characteristics of the lot from which a test sample was taken or any similar or identical product unless specifically and expressly noted. Our report includes all of the tests requested by you and the results thereof based upon the information that you provided to us. You have 60 days from date of issuance of this report to notify us of any material error or omission caused by our negligence, provided, however, that such notice shall be in writing and shall specifically address the issue you wish to raise. A failure to raise such issue within the prescribed time shall constitute your unqualified acceptance of the completeness of this report, the tests conducted and the correctness of the report contents. Unless specific mention, the uncertainty of measurement has been explicitly taken into account to declare the compliance or non-compliance to the specification. The report must not be used by the client to claim product certification, approval, or endorsement by TAF or any government agencies.

Table of Contents

| | |
|------------------------------------------------------------------|-----------|
| Release Control Record | 4 |
| 1 Certificate of Conformity | 5 |
| 2 Summary of Test Results | 6 |
| 2.1 Measurement Uncertainty | 6 |
| 2.2 Modification Record | 6 |
| 3 General Information | 7 |
| 3.1 General Description of EUT | 7 |
| 3.2 Description of Test Modes | 9 |
| 3.2.1 Test Mode Applicability and Tested Channel Detail | 10 |
| 3.3 Duty Cycle of Test Signal | 12 |
| 3.4 Description of Support Units | 13 |
| 3.4.1 Configuration of System under Test | 14 |
| 3.5 General Description of Applied Standards | 15 |
| 4 Test Types and Results | 16 |
| 4.1 Radiated Emission and Bandedge Measurement | 16 |
| 4.1.1 Limits of Radiated Emission and Bandedge Measurement | 16 |
| 4.1.2 Test Instruments | 17 |
| 4.1.3 Test Procedures | 18 |
| 4.1.4 Deviation from Test Standard | 18 |
| 4.1.5 Test Set Up | 19 |
| 4.1.6 EUT Operating Conditions | 19 |
| 4.1.7 Test Results | 20 |
| 4.2 Conducted Emission Measurement | 33 |
| 4.2.1 Limits of Conducted Emission Measurement | 33 |
| 4.2.2 Test Instruments | 33 |
| 4.2.3 Test Procedures | 34 |
| 4.2.4 Deviation from Test Standard | 34 |
| 4.2.5 Test Setup | 34 |
| 4.2.6 EUT Operating Conditions | 34 |
| 4.2.7 Test Results | 35 |
| 4.3 6dB Bandwidth Measurement | 37 |
| 4.3.1 Limits of 6dB Bandwidth Measurement | 37 |
| 4.3.2 Test Setup | 37 |
| 4.3.3 Test Instruments | 37 |
| 4.3.4 Test Procedure | 37 |
| 4.3.5 Deviation from Test Standard | 37 |
| 4.3.6 EUT Operating Conditions | 37 |
| 4.3.7 Test Result | 38 |
| 4.4 Conducted Output Power Measurement | 40 |
| 4.4.1 Limits of Conducted Output Power Measurement | 40 |
| 4.4.2 Test Setup | 40 |
| 4.4.3 Test Instruments | 40 |
| 4.4.4 Test Procedures | 40 |
| 4.4.5 Deviation from Test Standard | 40 |
| 4.4.6 EUT Operating Conditions | 40 |
| 4.4.7 Test Results | 41 |
| 4.5 Power Spectral Density Measurement | 42 |
| 4.5.1 Limits of Power Spectral Density Measurement | 42 |
| 4.5.2 Test Setup | 42 |
| 4.5.3 Test Instruments | 42 |
| 4.5.4 Test Procedure | 42 |
| 4.5.5 Deviation from Test Standard | 42 |
| 4.5.6 EUT Operating Condition | 42 |

| | |
|-----------------------------------------------------------------|-----------|
| 4.5.7 Test Results | 43 |
| 4.6 Conducted Out of Band Emission Measurement | 46 |
| 4.6.1 Limits of Conducted Out of Band Emission Measurement..... | 46 |
| 4.6.2 Test Setup..... | 46 |
| 4.6.3 Test Instruments | 46 |
| 4.6.4 Test Procedure | 46 |
| 4.6.5 Deviation from Test Standard | 46 |
| 4.6.6 EUT Operating Condition | 46 |
| 4.6.7 Test Results | 46 |
| 5 Pictures of Test Arrangements..... | 55 |
| Appendix – Information on the Testing Laboratories | 56 |

Release Control Record

| Issue No. | Description | Date Issued |
|-------------|-------------------|---------------|
| RF160606E02 | Original release. | July 26, 2016 |

1 Certificate of Conformity

Product: High Power AC1200 Dual-Band Outdoor Bridging AP

Brand: Luxul

Test Model: XWO-BAP1

Sample Status: ENGINEERING SAMPLE

Applicant: Luxul Wireless

Test Date: June 17 to 29, 2016

Standards: 47 CFR FCC Part 15, Subpart C (Section 15.247)
ANSI C63.10: 2013

The above equipment has been tested by **Bureau Veritas Consumer Products Services (H.K.) Ltd., Taoyuan Branch**, and found compliance with the requirement of the above standards. The test record, data evaluation & Equipment Under Test (EUT) configurations represented herein are true and accurate accounts of the measurements of the sample's EMC characteristics under the conditions specified in this report.

Prepared by :



Date:

July 26, 2016

Wendy Wu / Specialist

Approved by :



Date:

July 26, 2016

May Chen / Manager

2 Summary of Test Results

| 47 CFR FCC Part 15, Subpart C (SECTION 15.247) | | | |
|------------------------------------------------|----------------------------------------------|--------|-------------------------------------------------------------------------------------|
| FCC Clause | Test Item | Result | Remarks |
| 15.207 | AC Power Conducted Emission | PASS | Meet the requirement of limit. Minimum passing margin is -10.97dB at 0.37656MHz. |
| 15.205 / 15.209 / 15.247(d) | Radiated Emissions and Band Edge Measurement | PASS | Meet the requirement of limit. Minimum passing margin is -0.1dB at 2390.00MHz. |
| 15.247(d) | Antenna Port Emission | PASS | Meet the requirement of limit. |
| 15.247(a)(2) | 6dB bandwidth | PASS | Meet the requirement of limit. |
| 15.247(b) | Conducted power | PASS | Meet the requirement of limit. |
| 15.247(e) | Power Spectral Density | PASS | Meet the requirement of limit. |
| 15.203 | Antenna Requirement | Pass | Antenna connector is i-pex(MHF) not a standard connector. |

2.1 Measurement Uncertainty

Where relevant, the following measurement uncertainty levels have been estimated for tests performed on the EUT as specified in CISPR 16-4-2:

| Measurement | Frequency | Expanded Uncertainty (k=2) (\pm) |
|------------------------------------|----------------|--------------------------------------|
| Conducted Emissions at mains ports | 150kHz ~ 30MHz | 1.83 dB |
| Radiated Emissions up to 1 GHz | 30MHz ~ 1GHz | 5.19 dB |
| Radiated Emissions above 1 GHz | 1GHz ~ 6GHz | 3.43 dB |
| | 6GHz ~ 18GHz | 3.49 dB |
| | 18GHz ~ 40GHz | 4.11 dB |

2.2 Modification Record

There were no modifications required for compliance.

3 General Information

3.1 General Description of EUT

| | |
|-----------------------|-----------------------------------------------------------------------------------------------------------------------------------------------------------------------------------------------------------|
| Product | High Power AC1200 Dual-Band Outdoor Bridging AP |
| Brand | Luxul |
| Test Model | XWO-BAP1 |
| Status of EUT | ENGINEERING SAMPLE |
| Power Supply Rating | DC 56V from POE |
| Modulation Type | CCK, DQPSK, DBPSK for DSSS 64QAM, 16QAM, QPSK, BPSK for OFDM 256QAM for OFDM in 11ac mode |
| Modulation Technology | DSSS, OFDM |
| Transfer Rate | 802.11b: up to 11Mbps 802.11a/g: up to 54Mbps 802.11n: up to 300Mbps 802.11ac: up to 866.7Mbps |
| Operating Frequency | 2.4GHz: 2.412 ~ 2.462GHz 5GHz: 5.18 ~ 5.24GHz and 5.745 ~ 5.825GHz |
| Number of Channel | 2.4GHz: 802.11b, 802.11g, 802.11n (HT20): 11 802.11n (HT40): 7 5GHz: 802.11a, 802.11n (HT20), 802.11ac (VHT20): 9 802.11n (HT40), 802.11ac (VHT40): 4 802.11ac (VHT80): 2 |
| Output Power | 2.4GHz: 747.622mW 5GHz: 5.18GHz ~ 5.24GHz: 97.338mW 5.745GHz ~ 5.825GHz: 395.908mW |
| Antenna Type | Refer to Note |
| Antenna Connector | Refer to Note |
| Accessory Device | POE x 1 |
| Cable Supplied | Ethernet cable x1 (unshielded, 1m) Power cable x1 (unshielded, 1.8 m) grounding cable x1 (unshielded, 1.4m) |

Note:

1. Simultaneously transmission condition.

| Condition | Technology | |
|-----------|---------------|-------------|
| 1 | WLAN (2.4GHz) | WLAN (5GHz) |

Note: The emission of the simultaneous operation has been evaluated and no non-compliance was found.

2. The antennas provided to the EUT, please refer to the following table:

| 2.4GHz | | | | |
|---------------------|-------------------|-----------------------------|--------------|----------------|
| Transmitter Circuit | Antenna Gain(dBi) | Frequency range (MHz ~ MHz) | Antenna Type | Connector Type |
| Chain (0) | 6 | 2400~2483.5 | Patch | i-pex(MHF) |
| Chain (1) | 6 | | | |
| 5GHz | | | | |
| Transmitter Circuit | Antenna Gain(dBi) | Frequency range (MHz ~ MHz) | Antenna Type | Connector Type |
| Chain (0) | 10 | 5150~5875 | Patch | i-pex(MHF) |
| Chain (1) | 10 | | | |

3. The EUT must be supplied with a POE as following table:

| Brand | Model No. | Spec. |
|---------|------------|-------------------------------------------------------|
| PHIHONG | POE29U-560 | Input: 100-240V, 0.8A, 50-60Hz Output: 56V, 0.536A |

4. The EUT incorporates a MIMO function.

| 2.4GHz | | | |
|-------------------------------------------|-----------------|-----------------------|-----|
| Modulation Mode | Data Rate (MCS) | TX & RX Configuration | |
| 802.11b | 1 ~ 11Mbps | 2TX | 2RX |
| 802.11g | 6 ~ 54Mbps | 2TX | 2RX |
| 802.11n (HT20) & 802.11n (HT40) | MCS 0~7 | 2TX | 2RX |
| | MCS 8~15 | 2TX | 2RX |
| 5GHz | | | |
| Modulation Mode | Data Rate (MCS) | TX & RX Configuration | |
| 802.11a | 6 ~ 54Mbps | 2TX | 2RX |
| 802.11n (HT20) | MCS 0~7 | 2TX | 2RX |
| | MCS 8~15 | 2TX | 2RX |
| 802.11n (HT40) | MCS 0~7 | 2TX | 2RX |
| | MCS 8~15 | 2TX | 2RX |
| 802.11ac (VHT20) | MCS0~8 Nss= 1 | 2TX | 2RX |
| | MCS0~8 Nss= 2 | 2TX | 2RX |
| 802.11ac (VHT40) & 802.11ac (VHT80) | MCS0~9 Nss= 1 | 2TX | 2RX |
| | MCS0~9 Nss= 2 | 2TX | 2RX |

5. The above EUT information is declared by manufacturer and for more detailed features description, please refer to the manufacturer's specifications or user's manual.

3.2 Description of Test Modes

11 channels are provided for 802.11b, 802.11g and 802.11n (HT20):

| Channel | Frequency | Channel | Frequency |
|---------|-----------|---------|-----------|
| 1 | 2412MHz | 7 | 2442MHz |
| 2 | 2417MHz | 8 | 2447MHz |
| 3 | 2422MHz | 9 | 2452MHz |
| 4 | 2427MHz | 10 | 2457MHz |
| 5 | 2432MHz | 11 | 2462MHz |
| 6 | 2437MHz | | |

7 channels are provided for 802.11n (HT40):

| Channel | Frequency | Channel | Frequency |
|---------|-----------|---------|-----------|
| 3 | 2422MHz | 7 | 2442MHz |
| 4 | 2427MHz | 8 | 2447MHz |
| 5 | 2432MHz | 9 | 2452MHz |
| 6 | 2437MHz | | |

3.2.1 Test Mode Applicability and Tested Channel Detail

| EUT CONFIGURE MODE | APPLICABLE TO | | | | DESCRIPTION |
|--------------------|---------------|-------|-----|------|-------------|
| | RE \geq 1G | RE<1G | PLC | APCM | |
| - | √ | √ | √ | √ | - |

Where RE \geq 1G: Radiated Emission above 1GHz & Bandedge Measurement
 RE<1G: Radiated Emission below 1GHz
 PLC: Power Line Conducted Emission
 APCM: Antenna Port Conducted Measurement

Radiated Emission Test (Above 1GHz):

- Pre-Scan has been conducted to determine the worst-case mode from all possible combinations between available modulations, data rates and antenna ports (if EUT with antenna diversity architecture).
- Following channel(s) was (were) selected for the final test as listed below.

| MODE | AVAILABLE CHANNEL | TESTED CHANNEL | MODULATION TECHNOLOGY | MODULATION TYPE | DATA RATE (Mbps) |
|----------------|-------------------|----------------|-----------------------|-----------------|------------------|
| 802.11b | 1 to 11 | 1, 6, 11 | DSSS | DBPSK | 1 |
| 802.11g | 1 to 11 | 1, 6, 11 | OFDM | BPSK | 6 |
| 802.11n (HT20) | 1 to 11 | 1, 6, 11 | OFDM | BPSK | 6.5 |
| 802.11n (HT40) | 3 to 9 | 3, 6, 9 | OFDM | BPSK | 13.5 |

Radiated Emission Test (Below 1GHz):

- Pre-Scan has been conducted to determine the worst-case mode from all possible combinations between available modulations, data rates and antenna ports (if EUT with antenna diversity architecture).
- Following channel(s) was (were) selected for the final test as listed below.

| MODE | AVAILABLE CHANNEL | TESTED CHANNEL | MODULATION TECHNOLOGY | MODULATION TYPE | DATA RATE (Mbps) |
|---------|-------------------|----------------|-----------------------|-----------------|------------------|
| 802.11g | 1 to 11 | 6 | OFDM | BPSK | 6 |

Power Line Conducted Emission Test:

- Pre-Scan has been conducted to determine the worst-case mode from all possible combinations between available modulations, data rates and antenna ports (if EUT with antenna diversity architecture).
- Following channel(s) was (were) selected for the final test as listed below.

| MODE | AVAILABLE CHANNEL | TESTED CHANNEL | MODULATION TECHNOLOGY | MODULATION TYPE | DATA RATE (Mbps) |
|---------|-------------------|----------------|-----------------------|-----------------|------------------|
| 802.11g | 1 to 11 | 6 | OFDM | BPSK | 6 |

Antenna Port Conducted Measurement:

- This item includes all test value of each mode, but only includes spectrum plot of worst value of each mode.
- Pre-Scan has been conducted to determine the worst-case mode from all possible combinations between available modulations, data rates and antenna ports (if EUT with antenna diversity architecture).
- Following channel(s) was (were) selected for the final test as listed below.

| MODE | AVAILABLE CHANNEL | TESTED CHANNEL | MODULATION TECHNOLOGY | MODULATION TYPE | DATA RATE (Mbps) |
|----------------|-------------------|----------------|-----------------------|-----------------|------------------|
| 802.11b | 1 to 11 | 1, 6, 11 | DSSS | DBPSK | 1 |
| 802.11g | 1 to 11 | 1, 6, 11 | OFDM | BPSK | 6 |
| 802.11n (HT20) | 1 to 11 | 1, 6, 11 | OFDM | BPSK | 6.5 |
| 802.11n (HT40) | 3 to 9 | 3, 6, 9 | OFDM | BPSK | 13.5 |

Test Condition:

| APPLICABLE TO | ENVIRONMENTAL CONDITIONS | INPUT POWER | TESTED BY |
|---------------|--------------------------|--------------|--------------|
| RE \geq 1G | 26deg. C, 68%RH | 120Vac, 60Hz | Russell Yeh |
| RE<1G | 26deg. C, 72%RH | 120Vac, 60Hz | Russell Yeh |
| PLC | 24deg. C, 61%RH | 120Vac, 60Hz | Jyunchun Lin |
| APCM | 24deg. C, 62%RH | 120Vac, 60Hz | Jyunchun Lin |

3.3 Duty Cycle of Test Signal

If duty cycle of test signal is $\geq 98\%$, duty factor is not required.

802.11b: Duty cycle = $32.263/32.338 = 0.998$

802.11g: Duty cycle = $5.357/5.417 = 0.989$

802.11n (HT20): Duty cycle = $4.966/5.036 = 0.986$

802.11n (HT40): Duty cycle = $2.406/2.451 = 0.982$

802.11b

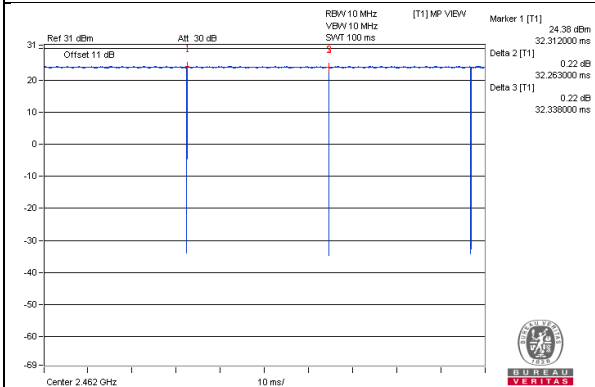

802.11g

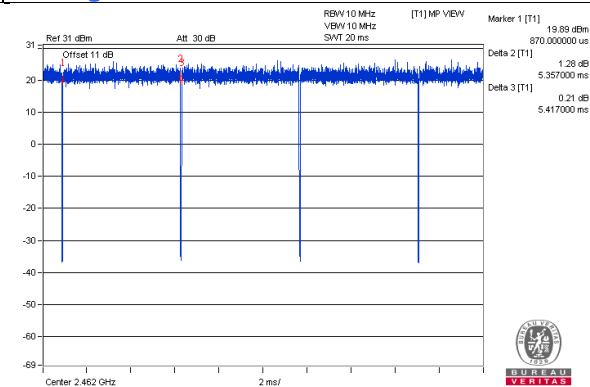

802.11n (HT20)

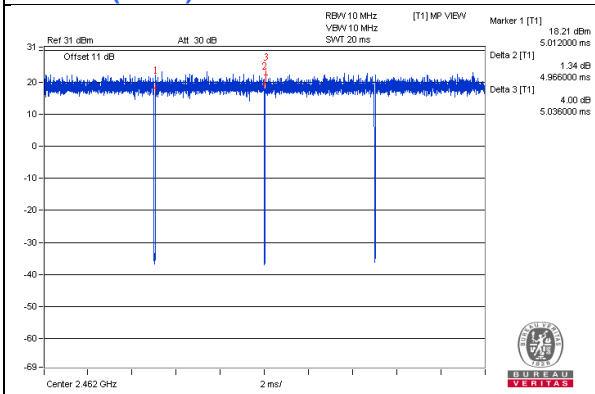

802.11n (HT40)

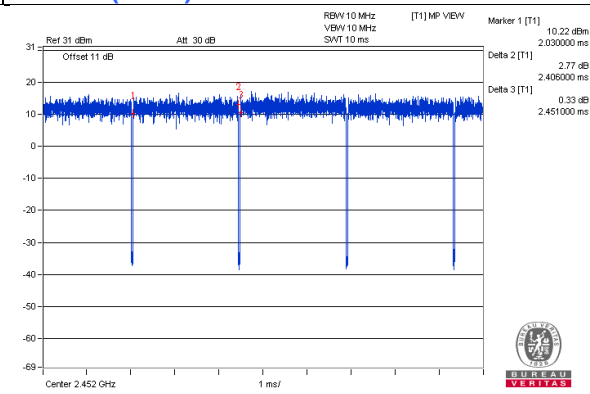

3.4 Description of Support Units

The EUT has been tested as an independent unit together with other necessary accessories or support units. The following support units or accessories were used to form a representative test configuration during the tests.

| ID | Product | Brand | Model No. | Serial No. | FCC ID | Remarks |
|----|-------------------|-------|-----------|------------|---------|-----------------|
| A. | Notebook Computer | DELL | E5430 | HYV4VY1 | FCC DoC | Provided by Lab |

Note:

1. All power cords of the above support units are non-shielded (1.8m).

| ID | Descriptions | Qty. | Length (m) | Shielding (Yes/No) | Cores (Qty.) | Remarks |
|----|--------------|------|------------|--------------------|--------------|--------------------|
| 1. | RJ-45 Cable | 1 | 10 | No | 0 | Provided by Lab |
| 2. | RJ-45 Cable | 1 | 1 | No | 0 | Supplied by client |
| 3. | AC Cable | 1 | 1.8 | No | 0 | Supplied by client |
| 4. | Ground Cable | 1 | 1.4 | No | 0 | Supplied by client |
| 5. | Ground Cable | 1 | 2 | No | 0 | Provided by Lab |

3.4.1 Configuration of System under Test

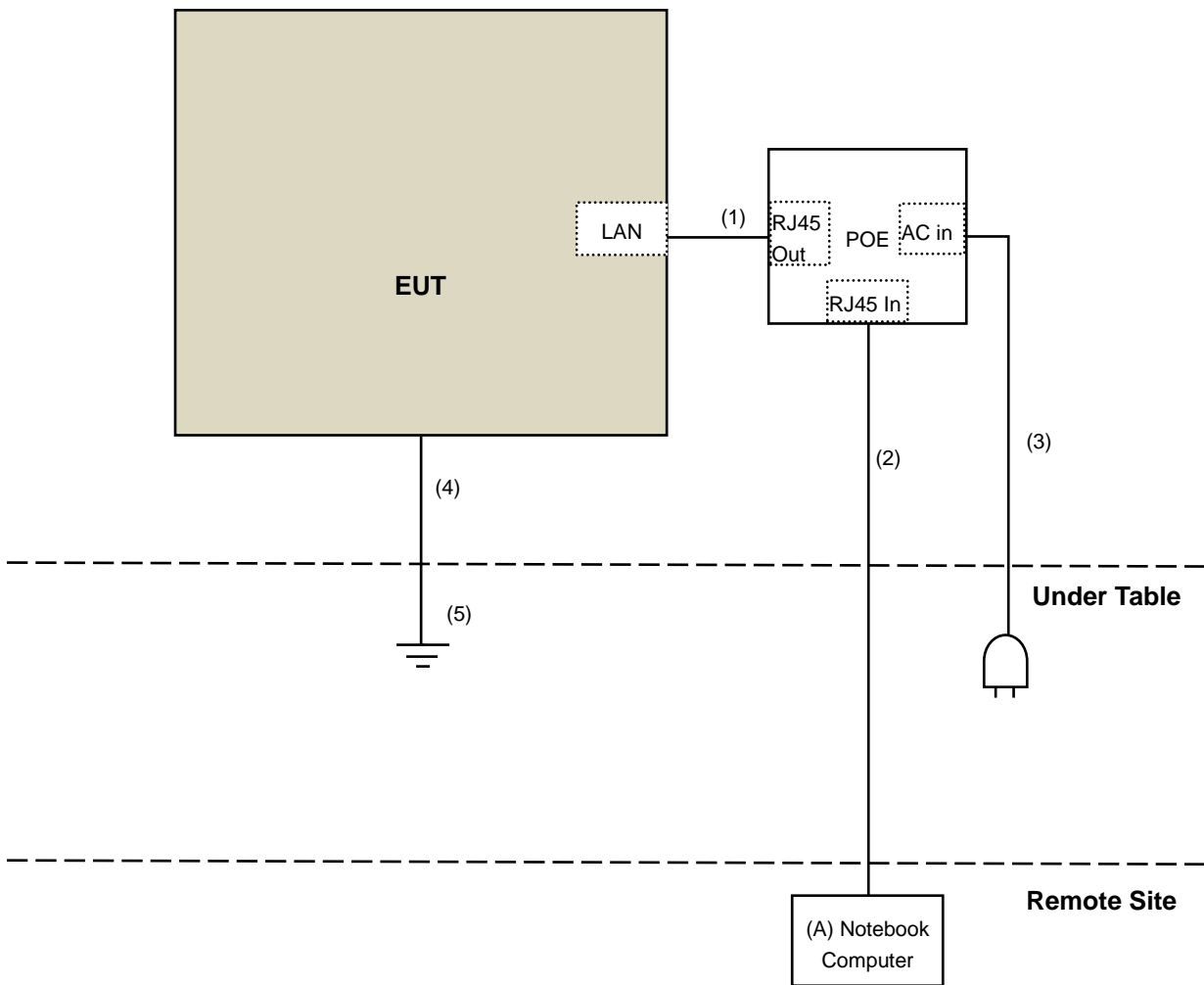

3.5 General Description of Applied Standards

The EUT is a RF Product. According to the specifications of the manufacturer, it must comply with the requirements of the following standards:

FCC Part 15, Subpart C (15.247)
KDB 558074 D01 DTS Meas Guidance v03r05
KDB 662911 D01 Multiple Transmitter Output v02r01
ANSI C63.10-2013

All test items have been performed and recorded as per the above standards.

NOTE: The EUT has been verified to comply with the requirements of FCC Part 15, Subpart B, Class B (DoC). The test report has been issued separately.

4 Test Types and Results

4.1 Radiated Emission and Bandedge Measurement

4.1.1 Limits of Radiated Emission and Bandedge Measurement

Radiated emissions which fall in the restricted bands must comply with the radiated emission limits specified as below table. Other emissions shall be at least 30dB below the highest level of the desired power:

| Frequencies (MHz) | Field Strength (microvolts/meter) | Measurement Distance (meters) |
|-------------------|-----------------------------------|-------------------------------|
| 0.009 ~ 0.490 | 2400/F(kHz) | 300 |
| 0.490 ~ 1.705 | 24000/F(kHz) | 30 |
| 1.705 ~ 30.0 | 30 | 30 |
| 30 ~ 88 | 100 | 3 |
| 88 ~ 216 | 150 | 3 |
| 216 ~ 960 | 200 | 3 |
| Above 960 | 500 | 3 |

NOTE:

1. The lower limit shall apply at the transition frequencies.
2. Emission level (dBuV/m) = 20 log Emission level (uV/m).
3. For frequencies above 1000MHz, the field strength limits are based on average detector, however, the peak field strength of any emission shall not exceed the maximum permitted average limits, specified above by more than 20dB under any condition of modulation.

4.1.2 Test Instruments

| DESCRIPTION & MANUFACTURER | MODEL NO. | SERIAL NO. | CALIBRATED DATE | CALIBRATED UNTIL |
|------------------------------------------------|-------------------------------------------------------------|-------------------------------|-----------------|------------------|
| Test Receiver Agilent | N9038A | MY54450088 | July 24, 2015 | July 23, 2016 |
| Pre-Amplifier ^(*) EMCI | EMC001340 | 980142 | Jan. 20, 2016 | Jan. 19, 2018 |
| Loop Antenna ^(*) Electro-Metrics | EM-6879 | 264 | Dec. 16, 2014 | Dec. 15, 2016 |
| RF Cable | NA | LOOPCAB-001 LOOPCAB-002 | Jan. 18, 2016 | Jan. 17, 2017 |
| Pre-Amplifier Mini-Circuits | ZFL-1000VH2B | AMP-ZFL-01 | Nov. 11, 2015 | Nov. 10, 2016 |
| Trilog Broadband Antenna SCHWARZBECK | VULB 9168 | 9168-406 | Jan. 04, 2016 | Jan. 03, 2017 |
| RF Cable | 8D | 966-4-1 966-4-2 966-4-3 | Apr. 02, 2016 | Apr. 01, 2017 |
| Horn_Antenna SCHWARZBECK | BBHA 9120D | 9120D-783 | Jan. 19, 2016 | Jan. 18, 2017 |
| Pre-Amplifier Agilent | 8449B | 3008A01922 | Sep. 19, 2015 | Sep. 18, 2016 |
| RF Cable | EMC104-SM-SM-2000 EMC104-SM-SM-5000 EMC104-SM-SM-5000 | 150318 150323 150324 | Mar. 30, 2016 | Mar. 29, 2017 |
| Pre-Amplifier EMCI | EMC184045 | 980143 | Jan. 15, 2016 | Jan. 14, 2017 |
| Horn_Antenna SCHWARZBECK | BBHA 9170 | BBHA9170608 | Jan. 08, 2016 | Jan. 07, 2017 |
| RF Cable | SUCOFLEX 102 | 36432/2 36441/2 | Jan. 16, 2016 | Jan. 15, 2017 |
| Software | ADT_Radiated_V8.7.07 | NA | NA | NA |
| Antenna Tower & Turn Table Max-Full | MF-7802 | MF780208410 | NA | NA |
| Boresight Antenna Fixture | FBA-01 | FBA-SIP02 | NA | NA |
| Spectrum Analyzer R&S | FSP40 | 100060 | May 11, 2016 | May 10, 2017 |
| Power meter Anritsu | ML2495A | 1014008 | May 5, 2016 | May 4, 2017 |
| Power sensor Anritsu | MA2411B | 0917122 | May 5, 2016 | May 4, 2017 |

Note:

1. The calibration interval of the above test instruments is 12 months and the calibrations are traceable to NML/ROC and NIST/USA.
2. *The calibration interval of the above test instruments is 24 months and the calibrations are traceable to NML/ROC and NIST/USA.
3. Loop antenna was used for all emissions below 30 MHz.
4. The test was performed in 966 Chamber No. 4.
5. The FCC Site Registration No. is 292998
6. The CANADA Site Registration No. is 20331-2
7. Tested Date: June 17 to 29, 2016

4.1.3 Test Procedures

- a. The EUT was placed on the top of a rotating table 0.8 meters (for below 1GHz) / 1.5 meters (for above 1GHz) above the ground at 3 meter chamber room for test. The table was rotated 360 degrees to determine the position of the highest radiation.
- b. The EUT was set 3 meters away from the interference-receiving antenna, which was mounted on the top of a variable-height antenna tower.
- c. The height of antenna is varied from one meter to four meters above the ground to determine the maximum value of the field strength. Both horizontal and vertical polarizations of the antenna are set to make the measurement.
- d. For each suspected emission, the EUT was arranged to its worst case and then the antenna was tuned to heights from 1 meter to 4 meters and the rotatable table was turned from 0 degrees to 360 degrees to find the maximum reading.
- e. The test-receiver system was set to quasi-peak detect function and specified bandwidth with maximum hold mode when the test frequency is below 1 GHz.
- f. The test-receiver system was set to peak and average detect function and specified bandwidth with maximum hold mode when the test frequency is above 1 GHz. If the peak reading value also meets average limit, measurement with the average detector is unnecessary.

Note:

1. The resolution bandwidth and video bandwidth of test receiver/spectrum analyzer is 120kHz for Quasi-peak detection (QP) at frequency below 1GHz.
2. The resolution bandwidth of test receiver/spectrum analyzer is 1 MHz and the video bandwidth is 3 MHz for Peak detection (PK) at frequency above 1GHz.
3. The resolution bandwidth of test receiver/spectrum analyzer is 1MHz and the video bandwidth is 3MHz for RMS Average (Duty cycle < 98%) for Average detection (AV) at frequency above 1GHz, then the measurement results was added to a correction factor ($10 \log(1/\text{duty cycle})$).
4. The resolution bandwidth of test receiver/spectrum analyzer is 1MHz and the video bandwidth is 10Hz (Duty cycle $\geq 98\%$) for Average detection (AV) at frequency above 1GHz.
5. All modes of operation were investigated and the worst-case emissions are reported.

4.1.4 Deviation from Test Standard

No deviation.

4.1.5 Test Set Up

<Frequency Range below 1GHz>

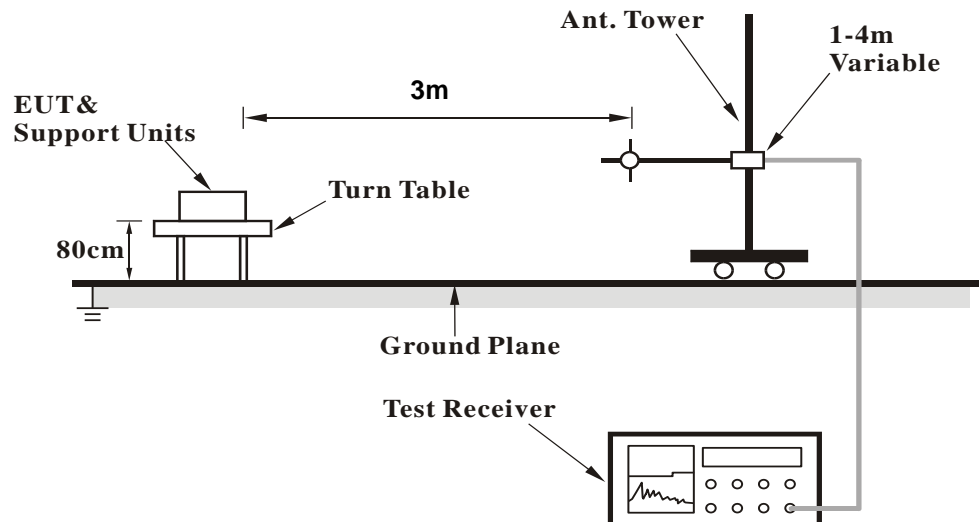

<Frequency Range above 1GHz>

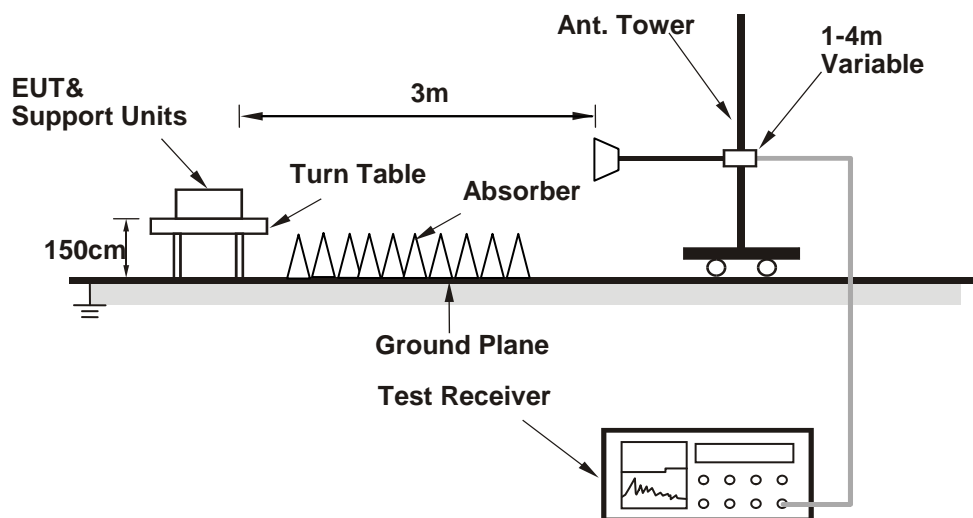

For the actual test configuration, please refer to the attached file (Test Setup Photo).

4.1.6 EUT Operating Conditions

1. Connect the EUT with the Notebook Computer which is placed on remote site.
2. Controlling software (artgui.exe[art2_ver_4_9_802_1]) has been activated to set the EUT on specific status.

4.1.7 Test Results

Above 1GHz Data:

802.11b

| | | | |
|------------------------|--------------|------------------------------|--------------|
| CHANNEL | TX Channel 1 | DETECTOR FUNCTION | Peak (PK) |
| FREQUENCY RANGE | 1GHz ~ 25GHz | | Average (AV) |

ANTENNA POLARITY & TEST DISTANCE: HORIZONTAL AT 3 M

| NO. | FREQ. (MHz) | EMISSION LEVEL (dBuV/m) | LIMIT (dBuV/m) | MARGIN (dB) | ANTENNA HEIGHT (m) | TABLE ANGLE (Degree) | RAW VALUE (dBuV) | CORRECTION FACTOR (dB/m) |
|-----|----------------|-------------------------------|-------------------|----------------|--------------------------|----------------------------|------------------------|--------------------------------|
| 1 | 2390.00 | 71.4 PK | 74.0 | -2.6 | 1.00 H | 46 | 77.00 | -5.60 |
| 2 | 2390.00 | 53.5 AV | 54.0 | -0.5 | 1.00 H | 46 | 59.10 | -5.60 |
| 3 | *2412.00 | 116.2 PK | | | 1.00 H | 46 | 121.70 | -5.50 |
| 4 | *2412.00 | 113.1 AV | | | 1.00 H | 46 | 118.60 | -5.50 |
| 5 | 4824.00 | 43.3 PK | 74.0 | -30.7 | 3.88 H | 360 | 42.40 | 0.90 |
| 6 | 4824.00 | 36.7 AV | 54.0 | -17.3 | 3.88 H | 360 | 35.80 | 0.90 |

ANTENNA POLARITY & TEST DISTANCE: VERTICAL AT 3 M

| NO. | FREQ. (MHz) | EMISSION LEVEL (dBuV/m) | LIMIT (dBuV/m) | MARGIN (dB) | ANTENNA HEIGHT (m) | TABLE ANGLE (Degree) | RAW VALUE (dBuV) | CORRECTION FACTOR (dB/m) |
|-----|----------------|-------------------------------|-------------------|----------------|--------------------------|----------------------------|------------------------|--------------------------------|
| 1 | 2390.00 | 69.4 PK | 74.0 | -4.6 | 1.05 V | 23 | 75.00 | -5.60 |
| 2 | 2390.00 | 50.2 AV | 54.0 | -3.8 | 1.05 V | 23 | 55.80 | -5.60 |
| 3 | *2412.00 | 113.4 PK | | | 1.05 V | 23 | 118.90 | -5.50 |
| 4 | *2412.00 | 110.1 AV | | | 1.05 V | 23 | 115.60 | -5.50 |
| 5 | 4824.00 | 43.7 PK | 74.0 | -30.3 | 1.62 V | 67 | 42.80 | 0.90 |
| 6 | 4824.00 | 37.0 AV | 54.0 | -17.0 | 1.62 V | 67 | 36.10 | 0.90 |

REMARKS:

1. Emission Level(dBuV/m) = Raw Value(dBuV) + Correction Factor(dB/m)
2. Correction Factor(dB/m) = Antenna Factor(dB/m) + Cable Factor(dB) – Pre-Amplifier Factor(dB)
3. The other emission levels were very low against the limit.
4. Margin value = Emission Level – Limit value
5. " * ": Fundamental frequency.

| | | | |
|------------------------|--------------|------------------------------|--------------|
| CHANNEL | TX Channel 6 | DETECTOR FUNCTION | Peak (PK) |
| FREQUENCY RANGE | 1GHz ~ 25GHz | | Average (AV) |

ANTENNA POLARITY & TEST DISTANCE: HORIZONTAL AT 3 M

| NO. | FREQ. (MHz) | EMISSION LEVEL (dBuV/m) | LIMIT (dBuV/m) | MARGIN (dB) | ANTENNA HEIGHT (m) | TABLE ANGLE (Degree) | RAW VALUE (dBuV) | CORRECTION FACTOR (dB/m) |
|-----|----------------|-------------------------------|-------------------|----------------|--------------------------|----------------------------|------------------------|--------------------------------|
| 1 | 2312.00 | 70.7 PK | 74.0 | -3.3 | 1.42 H | 16 | 76.60 | -5.90 |
| 2 | 2312.00 | 53.8 AV | 54.0 | -0.2 | 1.42 H | 16 | 59.70 | -5.90 |
| 3 | 2390.00 | 69.8 PK | 74.0 | -4.2 | 1.42 H | 16 | 75.40 | -5.60 |
| 4 | 2390.00 | 46.8 AV | 54.0 | -7.2 | 1.42 H | 16 | 52.40 | -5.60 |
| 5 | *2437.00 | 113.9 PK | | | 1.42 H | 16 | 119.30 | -5.40 |
| 6 | *2437.00 | 111.5 AV | | | 1.42 H | 16 | 116.90 | -5.40 |
| 7 | 2483.50 | 68.7 PK | 74.0 | -5.3 | 1.42 H | 16 | 74.00 | -5.30 |
| 8 | 2483.50 | 45.6 AV | 54.0 | -8.4 | 1.42 H | 16 | 50.90 | -5.30 |
| 9 | 4874.00 | 42.5 PK | 74.0 | -31.5 | 3.90 H | 360 | 41.50 | 1.00 |
| 10 | 4874.00 | 33.8 AV | 54.0 | -20.2 | 3.90 H | 360 | 32.80 | 1.00 |
| 11 | 7311.00 | 47.6 PK | 74.0 | -26.4 | 1.83 H | 219 | 40.00 | 7.60 |
| 12 | 7311.00 | 37.9 AV | 54.0 | -16.1 | 1.83 H | 219 | 30.30 | 7.60 |

ANTENNA POLARITY & TEST DISTANCE: VERTICAL AT 3 M

| NO. | FREQ. (MHz) | EMISSION LEVEL (dBuV/m) | LIMIT (dBuV/m) | MARGIN (dB) | ANTENNA HEIGHT (m) | TABLE ANGLE (Degree) | RAW VALUE (dBuV) | CORRECTION FACTOR (dB/m) |
|-----|----------------|-------------------------------|-------------------|----------------|--------------------------|----------------------------|------------------------|--------------------------------|
| 1 | 2312.00 | 68.6 PK | 74.0 | -5.4 | 1.16 V | 22 | 74.50 | -5.90 |
| 2 | 2312.00 | 49.8 AV | 54.0 | -4.2 | 1.16 V | 22 | 55.70 | -5.90 |
| 3 | 2390.00 | 58.1 PK | 74.0 | -15.9 | 1.16 V | 22 | 63.70 | -5.60 |
| 4 | 2390.00 | 44.1 AV | 54.0 | -9.9 | 1.16 V | 22 | 49.70 | -5.60 |
| 5 | *2437.00 | 111.1 PK | | | 1.16 V | 22 | 116.50 | -5.40 |
| 6 | *2437.00 | 108.2 AV | | | 1.16 V | 22 | 113.60 | -5.40 |
| 7 | 2483.50 | 67.6 PK | 74.0 | -6.4 | 1.16 V | 22 | 72.90 | -5.30 |
| 8 | 2483.50 | 45.4 AV | 54.0 | -8.6 | 1.16 V | 22 | 50.70 | -5.30 |
| 9 | 4874.00 | 42.8 PK | 74.0 | -31.2 | 1.72 V | 71 | 41.80 | 1.00 |
| 10 | 4874.00 | 32.9 AV | 54.0 | -21.1 | 1.72 V | 71 | 31.90 | 1.00 |
| 11 | 7311.00 | 47.8 PK | 74.0 | -26.2 | 2.50 V | 68 | 40.20 | 7.60 |
| 12 | 7311.00 | 35.0 AV | 54.0 | -19.0 | 2.50 V | 68 | 27.40 | 7.60 |

REMARKS:

1. Emission Level(dBuV/m) = Raw Value(dBuV) + Correction Factor(dB/m)
2. Correction Factor(dB/m) = Antenna Factor(dB/m) + Cable Factor(dB) – Pre-Amplifier Factor(dB)
3. The other emission levels were very low against the limit.
4. Margin value = Emission Level – Limit value
5. " * ": Fundamental frequency.

| | | | |
|------------------------|---------------|------------------------------|--------------|
| CHANNEL | TX Channel 11 | DETECTOR FUNCTION | Peak (PK) |
| FREQUENCY RANGE | 1GHz ~ 25GHz | | Average (AV) |

ANTENNA POLARITY & TEST DISTANCE: HORIZONTAL AT 3 M

| NO. | FREQ. (MHz) | EMISSION LEVEL (dBuV/m) | LIMIT (dBuV/m) | MARGIN (dB) | ANTENNA HEIGHT (m) | TABLE ANGLE (Degree) | RAW VALUE (dBuV) | CORRECTION FACTOR (dB/m) |
|-----|----------------|-------------------------------|-------------------|----------------|--------------------------|----------------------------|------------------------|--------------------------------|
| 1 | *2462.00 | 116.7 PK | | | 1.50 H | 12 | 122.00 | -5.30 |
| 2 | *2462.00 | 114.4 AV | | | 1.50 H | 12 | 119.70 | -5.30 |
| 3 | 2483.50 | 70.6 PK | 74.0 | -3.4 | 1.50 H | 12 | 75.90 | -5.30 |
| 4 | 2483.50 | 53.5 AV | 54.0 | -0.5 | 1.50 H | 12 | 58.80 | -5.30 |
| 5 | 4924.00 | 45.7 PK | 74.0 | -28.3 | 3.94 H | 350 | 44.40 | 1.30 |
| 6 | 4924.00 | 40.0 AV | 54.0 | -14.0 | 3.94 H | 350 | 38.70 | 1.30 |
| 7 | 7386.00 | 48.8 PK | 74.0 | -25.2 | 1.88 H | 222 | 41.10 | 7.70 |
| 8 | 7386.00 | 37.2 AV | 54.0 | -16.8 | 1.88 H | 222 | 29.50 | 7.70 |

ANTENNA POLARITY & TEST DISTANCE: VERTICAL AT 3 M

| NO. | FREQ. (MHz) | EMISSION LEVEL (dBuV/m) | LIMIT (dBuV/m) | MARGIN (dB) | ANTENNA HEIGHT (m) | TABLE ANGLE (Degree) | RAW VALUE (dBuV) | CORRECTION FACTOR (dB/m) |
|-----|----------------|-------------------------------|-------------------|----------------|--------------------------|----------------------------|------------------------|--------------------------------|
| 1 | *2462.00 | 113.8 PK | | | 1.12 V | 35 | 119.10 | -5.30 |
| 2 | *2462.00 | 111.2 AV | | | 1.12 V | 35 | 116.50 | -5.30 |
| 3 | 2483.50 | 69.7 PK | 74.0 | -4.3 | 1.23 V | 15 | 75.00 | -5.30 |
| 4 | 2483.50 | 50.5 AV | 54.0 | -3.5 | 1.23 V | 15 | 55.80 | -5.30 |
| 5 | 4924.00 | 47.8 PK | 74.0 | -26.2 | 1.58 V | 83 | 46.50 | 1.30 |
| 6 | 4924.00 | 37.5 AV | 54.0 | -16.5 | 1.58 V | 83 | 36.20 | 1.30 |
| 7 | 7386.00 | 48.4 PK | 74.0 | -25.6 | 2.58 V | 77 | 40.70 | 7.70 |
| 8 | 7386.00 | 36.3 AV | 54.0 | -17.7 | 2.58 V | 77 | 28.60 | 7.70 |

REMARKS:

1. Emission Level(dBuV/m) = Raw Value(dBuV) + Correction Factor(dB/m)
2. Correction Factor(dB/m) = Antenna Factor(dB/m) + Cable Factor(dB) – Pre-Amplifier Factor(dB)
3. The other emission levels were very low against the limit.
4. Margin value = Emission Level – Limit value
5. " * ": Fundamental frequency.

802.11g

| | | | |
|------------------------|--------------|------------------------------|--------------|
| CHANNEL | TX Channel 1 | DETECTOR FUNCTION | Peak (PK) |
| FREQUENCY RANGE | 1GHz ~ 25GHz | | Average (AV) |

ANTENNA POLARITY & TEST DISTANCE: HORIZONTAL AT 3 M

| NO. | FREQ. (MHz) | EMISSION LEVEL (dBuV/m) | LIMIT (dBuV/m) | MARGIN (dB) | ANTENNA HEIGHT (m) | TABLE ANGLE (Degree) | RAW VALUE (dBuV) | CORRECTION FACTOR (dB/m) |
|-----|----------------|-------------------------------|-------------------|----------------|--------------------------|----------------------------|------------------------|--------------------------------|
| 1 | 2390.00 | 73.8 PK | 74.0 | -0.2 | 1.03 H | 18 | 79.40 | -5.60 |
| 2 | 2390.00 | 53.5 AV | 54.0 | -0.5 | 1.03 H | 18 | 59.10 | -5.60 |
| 3 | *2412.00 | 115.4 PK | | | 1.03 H | 18 | 120.90 | -5.50 |
| 4 | *2412.00 | 103.1 AV | | | 1.03 H | 18 | 108.60 | -5.50 |
| 5 | 4824.00 | 41.1 PK | 74.0 | -32.9 | 3.84 H | 360 | 40.20 | 0.90 |
| 6 | 4824.00 | 34.2 AV | 54.0 | -19.8 | 3.84 H | 360 | 33.30 | 0.90 |

ANTENNA POLARITY & TEST DISTANCE: VERTICAL AT 3 M

| NO. | FREQ. (MHz) | EMISSION LEVEL (dBuV/m) | LIMIT (dBuV/m) | MARGIN (dB) | ANTENNA HEIGHT (m) | TABLE ANGLE (Degree) | RAW VALUE (dBuV) | CORRECTION FACTOR (dB/m) |
|-----|----------------|-------------------------------|-------------------|----------------|--------------------------|----------------------------|------------------------|--------------------------------|
| 1 | 2390.00 | 68.3 PK | 74.0 | -5.7 | 1.24 V | 44 | 73.90 | -5.60 |
| 2 | 2390.00 | 49.8 AV | 54.0 | -4.2 | 1.24 V | 44 | 55.40 | -5.60 |
| 3 | *2412.00 | 113.2 PK | | | 1.24 V | 44 | 118.70 | -5.50 |
| 4 | *2412.00 | 101.3 AV | | | 1.24 V | 44 | 106.80 | -5.50 |
| 5 | 4824.00 | 42.3 PK | 74.0 | -31.7 | 1.68 V | 59 | 41.40 | 0.90 |
| 6 | 4824.00 | 36.2 AV | 54.0 | -17.8 | 1.68 V | 59 | 35.30 | 0.90 |

REMARKS:

1. Emission Level(dBuV/m) = Raw Value(dBuV) + Correction Factor(dB/m)
2. Correction Factor(dB/m) = Antenna Factor(dB/m) + Cable Factor(dB) – Pre-Amplifier Factor(dB)
3. The other emission levels were very low against the limit.
4. Margin value = Emission Level – Limit value
5. " * ": Fundamental frequency.

| | | | |
|------------------------|--------------|------------------------------|--------------|
| CHANNEL | TX Channel 6 | DETECTOR FUNCTION | Peak (PK) |
| FREQUENCY RANGE | 1GHz ~ 25GHz | | Average (AV) |

ANTENNA POLARITY & TEST DISTANCE: HORIZONTAL AT 3 M

| NO. | FREQ. (MHz) | EMISSION LEVEL (dBuV/m) | LIMIT (dBuV/m) | MARGIN (dB) | ANTENNA HEIGHT (m) | TABLE ANGLE (Degree) | RAW VALUE (dBuV) | CORRECTION FACTOR (dB/m) |
|-----|----------------|-------------------------------|-------------------|----------------|--------------------------|----------------------------|------------------------|--------------------------------|
| 1 | 2390.00 | 68.4 PK | 74.0 | -5.6 | 1.16 H | 15 | 74.00 | -5.60 |
| 2 | 2390.00 | 50.0 AV | 54.0 | -4.0 | 1.16 H | 15 | 55.60 | -5.60 |
| 3 | *2437.00 | 121.4 PK | | | 1.16 H | 15 | 126.80 | -5.40 |
| 4 | *2437.00 | 109.8 AV | | | 1.16 H | 15 | 115.20 | -5.40 |
| 5 | 2483.50 | 73.6 PK | 74.0 | -0.4 | 1.16 H | 15 | 78.90 | -5.30 |
| 6 | 2483.50 | 52.6 AV | 54.0 | -1.4 | 1.16 H | 15 | 57.90 | -5.30 |
| 7 | 4874.00 | 40.8 PK | 74.0 | -33.2 | 3.82 H | 355 | 39.80 | 1.00 |
| 8 | 4874.00 | 31.2 AV | 54.0 | -22.8 | 3.82 H | 355 | 30.20 | 1.00 |
| 9 | 7311.00 | 46.2 PK | 74.0 | -27.8 | 1.87 H | 220 | 38.60 | 7.60 |
| 10 | 7311.00 | 35.3 AV | 54.0 | -18.7 | 1.87 H | 220 | 27.70 | 7.60 |

ANTENNA POLARITY & TEST DISTANCE: VERTICAL AT 3 M

| NO. | FREQ. (MHz) | EMISSION LEVEL (dBuV/m) | LIMIT (dBuV/m) | MARGIN (dB) | ANTENNA HEIGHT (m) | TABLE ANGLE (Degree) | RAW VALUE (dBuV) | CORRECTION FACTOR (dB/m) |
|-----|----------------|-------------------------------|-------------------|----------------|--------------------------|----------------------------|------------------------|--------------------------------|
| 1 | 2390.00 | 68.6 PK | 74.0 | -5.4 | 1.31 V | 42 | 74.20 | -5.60 |
| 2 | 2390.00 | 47.5 AV | 54.0 | -6.5 | 1.31 V | 42 | 53.10 | -5.60 |
| 3 | *2437.00 | 118.2 PK | | | 1.31 V | 42 | 123.60 | -5.40 |
| 4 | *2437.00 | 107.6 AV | | | 1.31 V | 42 | 113.00 | -5.40 |
| 5 | 2483.50 | 70.1 PK | 74.0 | -3.9 | 1.31 V | 42 | 75.40 | -5.30 |
| 6 | 2483.50 | 49.4 AV | 54.0 | -4.6 | 1.31 V | 42 | 54.70 | -5.30 |
| 7 | 4874.00 | 40.7 PK | 74.0 | -33.3 | 1.77 V | 65 | 39.70 | 1.00 |
| 8 | 4874.00 | 30.8 AV | 54.0 | -23.2 | 1.77 V | 65 | 29.80 | 1.00 |
| 9 | 7311.00 | 45.8 PK | 74.0 | -28.2 | 2.44 V | 60 | 38.20 | 7.60 |
| 10 | 7311.00 | 33.6 AV | 54.0 | -20.4 | 2.44 V | 60 | 26.00 | 7.60 |

REMARKS:

1. Emission Level(dBuV/m) = Raw Value(dBuV) + Correction Factor(dB/m)
2. Correction Factor(dB/m) = Antenna Factor(dB/m) + Cable Factor(dB) – Pre-Amplifier Factor(dB)
3. The other emission levels were very low against the limit.
4. Margin value = Emission Level – Limit value
5. " * ": Fundamental frequency.

| | | | |
|------------------------|---------------|------------------------------|--------------|
| CHANNEL | TX Channel 11 | DETECTOR FUNCTION | Peak (PK) |
| FREQUENCY RANGE | 1GHz ~ 25GHz | | Average (AV) |

ANTENNA POLARITY & TEST DISTANCE: HORIZONTAL AT 3 M

| NO. | FREQ. (MHz) | EMISSION LEVEL (dBuV/m) | LIMIT (dBuV/m) | MARGIN (dB) | ANTENNA HEIGHT (m) | TABLE ANGLE (Degree) | RAW VALUE (dBuV) | CORRECTION FACTOR (dB/m) |
|-----|----------------|-------------------------------|-------------------|----------------|--------------------------|----------------------------|------------------------|--------------------------------|
| 1 | *2462.00 | 115.5 PK | | | 1.12 H | 11 | 120.80 | -5.30 |
| 2 | *2462.00 | 104.0 AV | | | 1.12 H | 11 | 109.30 | -5.30 |
| 3 | 2483.50 | 71.5 PK | 74.0 | -2.5 | 1.12 H | 11 | 76.80 | -5.30 |
| 4 | 2483.50 | 53.3 AV | 54.0 | -0.7 | 1.12 H | 11 | 58.60 | -5.30 |
| 5 | 4924.00 | 43.7 PK | 74.0 | -30.3 | 3.88 H | 344 | 42.40 | 1.30 |
| 6 | 4924.00 | 38.4 AV | 54.0 | -15.6 | 3.88 H | 344 | 37.10 | 1.30 |
| 7 | 7386.00 | 47.6 PK | 74.0 | -26.4 | 1.74 H | 227 | 39.90 | 7.70 |
| 8 | 7386.00 | 34.8 AV | 54.0 | -19.2 | 1.74 H | 227 | 27.10 | 7.70 |

ANTENNA POLARITY & TEST DISTANCE: VERTICAL AT 3 M

| NO. | FREQ. (MHz) | EMISSION LEVEL (dBuV/m) | LIMIT (dBuV/m) | MARGIN (dB) | ANTENNA HEIGHT (m) | TABLE ANGLE (Degree) | RAW VALUE (dBuV) | CORRECTION FACTOR (dB/m) |
|-----|----------------|-------------------------------|-------------------|----------------|--------------------------|----------------------------|------------------------|--------------------------------|
| 1 | *2462.00 | 113.8 PK | | | 1.38 V | 46 | 119.10 | -5.30 |
| 2 | *2462.00 | 101.7 AV | | | 1.38 V | 46 | 107.00 | -5.30 |
| 3 | 2483.50 | 68.9 PK | 74.0 | -5.1 | 1.38 V | 46 | 74.20 | -5.30 |
| 4 | 2483.50 | 47.3 AV | 54.0 | -6.7 | 1.38 V | 46 | 52.60 | -5.30 |
| 5 | 4924.00 | 45.8 PK | 74.0 | -28.2 | 1.65 V | 87 | 44.50 | 1.30 |
| 6 | 4924.00 | 36.1 AV | 54.0 | -17.9 | 1.65 V | 87 | 34.80 | 1.30 |
| 7 | 7386.00 | 46.5 PK | 74.0 | -27.5 | 2.66 V | 73 | 38.80 | 7.70 |
| 8 | 7386.00 | 34.2 AV | 54.0 | -19.8 | 2.66 V | 73 | 26.50 | 7.70 |

REMARKS:

1. Emission Level(dBuV/m) = Raw Value(dBuV) + Correction Factor(dB/m)
2. Correction Factor(dB/m) = Antenna Factor(dB/m) + Cable Factor(dB) – Pre-Amplifier Factor(dB)
3. The other emission levels were very low against the limit.
4. Margin value = Emission Level – Limit value
5. " * ": Fundamental frequency.

802.11n (HT20)

| | | | |
|------------------------|--------------|------------------------------|--------------|
| CHANNEL | TX Channel 1 | DETECTOR FUNCTION | Peak (PK) |
| FREQUENCY RANGE | 1GHz ~ 25GHz | | Average (AV) |

ANTENNA POLARITY & TEST DISTANCE: HORIZONTAL AT 3 M

| NO. | FREQ. (MHz) | EMISSION LEVEL (dBuV/m) | LIMIT (dBuV/m) | MARGIN (dB) | ANTENNA HEIGHT (m) | TABLE ANGLE (Degree) | RAW VALUE (dBuV) | CORRECTION FACTOR (dB/m) |
|-----|----------------|-------------------------------|-------------------|----------------|--------------------------|----------------------------|------------------------|--------------------------------|
| 1 | 2390.00 | 70.4 PK | 74.0 | -3.6 | 1.65 H | 2 | 76.00 | -5.60 |
| 2 | 2390.00 | 53.3 AV | 54.0 | -0.7 | 1.65 H | 2 | 58.90 | -5.60 |
| 3 | *2412.00 | 116.0 PK | | | 1.65 H | 2 | 121.50 | -5.50 |
| 4 | *2412.00 | 103.7 AV | | | 1.65 H | 2 | 109.20 | -5.50 |
| 5 | 4824.00 | 41.7 PK | 74.0 | -32.3 | 3.89 H | 344 | 40.80 | 0.90 |
| 6 | 4824.00 | 33.5 AV | 54.0 | -20.5 | 3.89 H | 344 | 32.60 | 0.90 |

ANTENNA POLARITY & TEST DISTANCE: VERTICAL AT 3 M

| NO. | FREQ. (MHz) | EMISSION LEVEL (dBuV/m) | LIMIT (dBuV/m) | MARGIN (dB) | ANTENNA HEIGHT (m) | TABLE ANGLE (Degree) | RAW VALUE (dBuV) | CORRECTION FACTOR (dB/m) |
|-----|----------------|-------------------------------|-------------------|----------------|--------------------------|----------------------------|------------------------|--------------------------------|
| 1 | 2390.00 | 68.4 PK | 74.0 | -5.6 | 1.18 V | 62 | 74.00 | -5.60 |
| 2 | 2390.00 | 48.5 AV | 54.0 | -5.5 | 1.18 V | 62 | 54.10 | -5.60 |
| 3 | *2412.00 | 112.4 PK | | | 1.18 V | 62 | 117.90 | -5.50 |
| 4 | *2412.00 | 100.5 AV | | | 1.18 V | 62 | 106.00 | -5.50 |
| 5 | 4824.00 | 41.6 PK | 74.0 | -32.4 | 1.63 V | 67 | 40.70 | 0.90 |
| 6 | 4824.00 | 35.4 AV | 54.0 | -18.6 | 1.63 V | 67 | 34.50 | 0.90 |

REMARKS:

1. Emission Level(dBuV/m) = Raw Value(dBuV) + Correction Factor(dB/m)
2. Correction Factor(dB/m) = Antenna Factor(dB/m) + Cable Factor(dB) – Pre-Amplifier Factor(dB)
3. The other emission levels were very low against the limit.
4. Margin value = Emission Level – Limit value
5. " * ": Fundamental frequency.

| | | | |
|------------------------|--------------|------------------------------|--------------|
| CHANNEL | TX Channel 6 | DETECTOR FUNCTION | Peak (PK) |
| FREQUENCY RANGE | 1GHz ~ 25GHz | | Average (AV) |

ANTENNA POLARITY & TEST DISTANCE: HORIZONTAL AT 3 M

| NO. | FREQ. (MHz) | EMISSION LEVEL (dBuV/m) | LIMIT (dBuV/m) | MARGIN (dB) | ANTENNA HEIGHT (m) | TABLE ANGLE (Degree) | RAW VALUE (dBuV) | CORRECTION FACTOR (dB/m) |
|-----|----------------|-------------------------------|-------------------|----------------|--------------------------|----------------------------|------------------------|--------------------------------|
| 1 | 2390.00 | 70.2 PK | 74.0 | -3.8 | 1.60 H | 2 | 75.80 | -5.60 |
| 2 | 2390.00 | 50.2 AV | 54.0 | -3.8 | 1.60 H | 2 | 55.80 | -5.60 |
| 3 | *2437.00 | 122.4 PK | | | 1.60 H | 2 | 127.80 | -5.40 |
| 4 | *2437.00 | 110.5 AV | | | 1.60 H | 2 | 115.90 | -5.40 |
| 5 | 2483.50 | 73.2 PK | 74.0 | -0.8 | 1.60 H | 2 | 78.50 | -5.30 |
| 6 | 2483.50 | 53.8 AV | 54.0 | -0.2 | 1.60 H | 2 | 59.10 | -5.30 |
| 7 | 4874.00 | 40.1 PK | 74.0 | -33.9 | 3.77 H | 348 | 39.10 | 1.00 |
| 8 | 4874.00 | 30.3 AV | 54.0 | -23.7 | 3.77 H | 348 | 29.30 | 1.00 |
| 9 | 7311.00 | 46.6 PK | 74.0 | -27.4 | 1.80 H | 238 | 39.00 | 7.60 |
| 10 | 7311.00 | 33.7 AV | 54.0 | -20.3 | 1.80 H | 238 | 26.10 | 7.60 |

ANTENNA POLARITY & TEST DISTANCE: VERTICAL AT 3 M

| NO. | FREQ. (MHz) | EMISSION LEVEL (dBuV/m) | LIMIT (dBuV/m) | MARGIN (dB) | ANTENNA HEIGHT (m) | TABLE ANGLE (Degree) | RAW VALUE (dBuV) | CORRECTION FACTOR (dB/m) |
|-----|----------------|-------------------------------|-------------------|----------------|--------------------------|----------------------------|------------------------|--------------------------------|
| 1 | 2390.00 | 68.6 PK | 74.0 | -5.4 | 1.29 V | 56 | 74.20 | -5.60 |
| 2 | 2390.00 | 46.3 AV | 54.0 | -7.7 | 1.29 V | 56 | 51.90 | -5.60 |
| 3 | *2437.00 | 117.3 PK | | | 1.29 V | 56 | 122.70 | -5.40 |
| 4 | *2437.00 | 106.4 AV | | | 1.29 V | 56 | 111.80 | -5.40 |
| 5 | 2483.50 | 70.5 PK | 74.0 | -3.5 | 1.29 V | 56 | 75.80 | -5.30 |
| 6 | 2483.50 | 48.7 AV | 54.0 | -5.3 | 1.29 V | 56 | 54.00 | -5.30 |
| 7 | 4874.00 | 40.0 PK | 74.0 | -34.0 | 1.80 V | 61 | 39.00 | 1.00 |
| 8 | 4874.00 | 30.2 AV | 54.0 | -23.8 | 1.80 V | 61 | 29.20 | 1.00 |
| 9 | 7311.00 | 44.4 PK | 74.0 | -29.6 | 2.53 V | 84 | 36.80 | 7.60 |
| 10 | 7311.00 | 32.3 AV | 54.0 | -21.7 | 2.53 V | 84 | 24.70 | 7.60 |

REMARKS:

1. Emission Level(dBuV/m) = Raw Value(dBuV) + Correction Factor(dB/m)
2. Correction Factor(dB/m) = Antenna Factor(dB/m) + Cable Factor(dB) – Pre-Amplifier Factor(dB)
3. The other emission levels were very low against the limit.
4. Margin value = Emission Level – Limit value
5. " * ": Fundamental frequency.

| | | | |
|------------------------|---------------|------------------------------|--------------|
| CHANNEL | TX Channel 11 | DETECTOR FUNCTION | Peak (PK) |
| FREQUENCY RANGE | 1GHz ~ 25GHz | | Average (AV) |

ANTENNA POLARITY & TEST DISTANCE: HORIZONTAL AT 3 M

| NO. | FREQ. (MHz) | EMISSION LEVEL (dBuV/m) | LIMIT (dBuV/m) | MARGIN (dB) | ANTENNA HEIGHT (m) | TABLE ANGLE (Degree) | RAW VALUE (dBuV) | CORRECTION FACTOR (dB/m) |
|-----|----------------|-------------------------------|-------------------|----------------|--------------------------|----------------------------|------------------------|--------------------------------|
| 1 | *2462.00 | 115.3 PK | | | 1.63 H | 0 | 120.60 | -5.30 |
| 2 | *2462.00 | 103.1 AV | | | 1.63 H | 0 | 108.40 | -5.30 |
| 3 | 2483.50 | 73.2 PK | 74.0 | -0.8 | 1.63 H | 0 | 78.50 | -5.30 |
| 4 | 2483.50 | 53.8 AV | 54.0 | -0.2 | 1.63 H | 0 | 59.10 | -5.30 |
| 5 | 4924.00 | 42.8 PK | 74.0 | -31.2 | 3.73 H | 352 | 41.50 | 1.30 |
| 6 | 4924.00 | 37.5 AV | 54.0 | -16.5 | 3.73 H | 352 | 36.20 | 1.30 |
| 7 | 7386.00 | 46.9 PK | 74.0 | -27.1 | 1.69 H | 225 | 39.20 | 7.70 |
| 8 | 7386.00 | 33.4 AV | 54.0 | -20.6 | 1.69 H | 225 | 25.70 | 7.70 |

ANTENNA POLARITY & TEST DISTANCE: VERTICAL AT 3 M

| NO. | FREQ. (MHz) | EMISSION LEVEL (dBuV/m) | LIMIT (dBuV/m) | MARGIN (dB) | ANTENNA HEIGHT (m) | TABLE ANGLE (Degree) | RAW VALUE (dBuV) | CORRECTION FACTOR (dB/m) |
|-----|----------------|-------------------------------|-------------------|----------------|--------------------------|----------------------------|------------------------|--------------------------------|
| 1 | *2462.00 | 110.3 PK | | | 1.43 V | 39 | 115.60 | -5.30 |
| 2 | *2462.00 | 99.8 AV | | | 1.43 V | 39 | 105.10 | -5.30 |
| 3 | 2483.50 | 67.5 PK | 74.0 | -6.5 | 1.43 V | 39 | 72.80 | -5.30 |
| 4 | 2483.50 | 45.7 AV | 54.0 | -8.3 | 1.43 V | 39 | 51.00 | -5.30 |
| 5 | 4924.00 | 45.1 PK | 74.0 | -28.9 | 1.73 V | 92 | 43.80 | 1.30 |
| 6 | 4924.00 | 35.3 AV | 54.0 | -18.7 | 1.73 V | 92 | 34.00 | 1.30 |
| 7 | 7386.00 | 44.9 PK | 74.0 | -29.1 | 2.77 V | 65 | 37.20 | 7.70 |
| 8 | 7386.00 | 33.5 AV | 54.0 | -20.5 | 2.77 V | 65 | 25.80 | 7.70 |

REMARKS:

1. Emission Level(dBuV/m) = Raw Value(dBuV) + Correction Factor(dB/m)
2. Correction Factor(dB/m) = Antenna Factor(dB/m) + Cable Factor(dB) – Pre-Amplifier Factor(dB)
3. The other emission levels were very low against the limit.
4. Margin value = Emission Level – Limit value
5. " * ": Fundamental frequency.

802.11n (HT40)

| | | | |
|------------------------|--------------|------------------------------|--------------|
| CHANNEL | TX Channel 3 | DETECTOR FUNCTION | Peak (PK) |
| FREQUENCY RANGE | 1GHz ~ 25GHz | | Average (AV) |

ANTENNA POLARITY & TEST DISTANCE: HORIZONTAL AT 3 M

| NO. | FREQ. (MHz) | EMISSION LEVEL (dBuV/m) | LIMIT (dBuV/m) | MARGIN (dB) | ANTENNA HEIGHT (m) | TABLE ANGLE (Degree) | RAW VALUE (dBuV) | CORRECTION FACTOR (dB/m) |
|-----|----------------|-------------------------------|-------------------|----------------|--------------------------|----------------------------|------------------------|--------------------------------|
| 1 | 2390.00 | 71.5 PK | 74.0 | -2.5 | 1.56 H | 3 | 77.10 | -5.60 |
| 2 | 2390.00 | 53.3 AV | 54.0 | -0.7 | 1.56 H | 3 | 58.90 | -5.60 |
| 3 | *2422.00 | 109.8 PK | | | 1.56 H | 3 | 115.20 | -5.40 |
| 4 | *2422.00 | 97.1 AV | | | 1.56 H | 3 | 102.50 | -5.40 |
| 5 | 4844.00 | 39.2 PK | 74.0 | -34.8 | 3.55 H | 332 | 38.30 | 0.90 |
| 6 | 4844.00 | 31.4 AV | 54.0 | -22.6 | 3.55 H | 332 | 30.50 | 0.90 |
| 7 | 7266.00 | 45.0 PK | 74.0 | -29.0 | 1.92 H | 244 | 37.30 | 7.70 |
| 8 | 7266.00 | 31.9 AV | 54.0 | -22.1 | 1.92 H | 244 | 24.20 | 7.70 |

ANTENNA POLARITY & TEST DISTANCE: VERTICAL AT 3 M

| NO. | FREQ. (MHz) | EMISSION LEVEL (dBuV/m) | LIMIT (dBuV/m) | MARGIN (dB) | ANTENNA HEIGHT (m) | TABLE ANGLE (Degree) | RAW VALUE (dBuV) | CORRECTION FACTOR (dB/m) |
|-----|----------------|-------------------------------|-------------------|----------------|--------------------------|----------------------------|------------------------|--------------------------------|
| 1 | 2390.00 | 67.7 PK | 74.0 | -6.3 | 1.43 V | 53 | 73.30 | -5.60 |
| 2 | 2390.00 | 48.8 AV | 54.0 | -5.2 | 1.43 V | 53 | 54.40 | -5.60 |
| 3 | *2422.00 | 107.4 PK | | | 1.43 V | 53 | 112.80 | -5.40 |
| 4 | *2422.00 | 95.3 AV | | | 1.43 V | 53 | 100.70 | -5.40 |
| 5 | 4844.00 | 38.8 PK | 74.0 | -35.2 | 1.78 V | 74 | 37.90 | 0.90 |
| 6 | 4844.00 | 29.3 AV | 54.0 | -24.7 | 1.78 V | 74 | 28.40 | 0.90 |
| 7 | 7266.00 | 42.7 PK | 74.0 | -31.3 | 2.53 V | 84 | 35.00 | 7.70 |
| 8 | 7266.00 | 31.2 AV | 54.0 | -22.8 | 2.53 V | 84 | 23.50 | 7.70 |

REMARKS:

- Emission Level(dBuV/m) = Raw Value(dBuV) + Correction Factor(dB/m)
- Correction Factor(dB/m) = Antenna Factor(dB/m) + Cable Factor(dB) – Pre-Amplifier Factor(dB)
- The other emission levels were very low against the limit.
- Margin value = Emission Level – Limit value
- " * ": Fundamental frequency.

| | | | |
|------------------------|--------------|------------------------------|--------------|
| CHANNEL | TX Channel 6 | DETECTOR FUNCTION | Peak (PK) |
| FREQUENCY RANGE | 1GHz ~ 25GHz | | Average (AV) |

ANTENNA POLARITY & TEST DISTANCE: HORIZONTAL AT 3 M

| NO. | FREQ. (MHz) | EMISSION LEVEL (dBuV/m) | LIMIT (dBuV/m) | MARGIN (dB) | ANTENNA HEIGHT (m) | TABLE ANGLE (Degree) | RAW VALUE (dBuV) | CORRECTION FACTOR (dB/m) |
|-----|----------------|-------------------------------|-------------------|----------------|--------------------------|----------------------------|------------------------|--------------------------------|
| 1 | 2390.00 | 71.2 PK | 74.0 | -2.8 | 1.67 H | 3 | 76.80 | -5.60 |
| 2 | 2390.00 | 53.9 AV | 54.0 | -0.1 | 1.67 H | 3 | 59.50 | -5.60 |
| 3 | *2437.00 | 112.8 PK | | | 1.67 H | 3 | 118.20 | -5.40 |
| 4 | *2437.00 | 100.3 AV | | | 1.67 H | 3 | 105.70 | -5.40 |
| 5 | 2483.50 | 68.0 PK | 74.0 | -6.0 | 1.67 H | 3 | 73.30 | -5.30 |
| 6 | 2483.50 | 49.4 AV | 54.0 | -4.6 | 1.67 H | 3 | 54.70 | -5.30 |
| 7 | 4874.00 | 38.1 PK | 74.0 | -35.9 | 3.58 H | 341 | 37.10 | 1.00 |
| 8 | 4874.00 | 29.6 AV | 54.0 | -24.4 | 3.58 H | 341 | 28.60 | 1.00 |
| 9 | 7311.00 | 44.7 PK | 74.0 | -29.3 | 1.80 H | 238 | 37.10 | 7.60 |
| 10 | 7311.00 | 31.7 AV | 54.0 | -22.3 | 1.80 H | 238 | 24.10 | 7.60 |

ANTENNA POLARITY & TEST DISTANCE: VERTICAL AT 3 M

| NO. | FREQ. (MHz) | EMISSION LEVEL (dBuV/m) | LIMIT (dBuV/m) | MARGIN (dB) | ANTENNA HEIGHT (m) | TABLE ANGLE (Degree) | RAW VALUE (dBuV) | CORRECTION FACTOR (dB/m) |
|-----|----------------|-------------------------------|-------------------|----------------|--------------------------|----------------------------|------------------------|--------------------------------|
| 1 | 2390.00 | 69.2 PK | 74.0 | -4.8 | 1.68 V | 41 | 74.80 | -5.60 |
| 2 | 2390.00 | 50.4 AV | 54.0 | -3.6 | 1.68 V | 41 | 56.00 | -5.60 |
| 3 | *2437.00 | 110.0 PK | | | 1.68 V | 41 | 115.40 | -5.40 |
| 4 | *2437.00 | 98.2 AV | | | 1.68 V | 41 | 103.60 | -5.40 |
| 5 | 2483.50 | 68.4 PK | 74.0 | -5.6 | 1.68 V | 41 | 73.70 | -5.30 |
| 6 | 2483.50 | 48.7 AV | 54.0 | -5.3 | 1.68 V | 41 | 54.00 | -5.30 |
| 7 | 4874.00 | 39.3 PK | 74.0 | -34.7 | 1.81 V | 69 | 38.30 | 1.00 |
| 8 | 4874.00 | 29.4 AV | 54.0 | -24.6 | 1.81 V | 69 | 28.40 | 1.00 |
| 9 | 7311.00 | 43.3 PK | 74.0 | -30.7 | 2.54 V | 86 | 35.70 | 7.60 |
| 10 | 7311.00 | 31.5 AV | 54.0 | -22.5 | 2.54 V | 86 | 23.90 | 7.60 |

REMARKS:

1. Emission Level(dBuV/m) = Raw Value(dBuV) + Correction Factor(dB/m)
2. Correction Factor(dB/m) = Antenna Factor(dB/m) + Cable Factor(dB) – Pre-Amplifier Factor(dB)
3. The other emission levels were very low against the limit.
4. Margin value = Emission Level – Limit value
5. " * ": Fundamental frequency.

| | | | |
|------------------------|--------------|------------------------------|--------------|
| CHANNEL | TX Channel 9 | DETECTOR FUNCTION | Peak (PK) |
| FREQUENCY RANGE | 1GHz ~ 25GHz | | Average (AV) |

ANTENNA POLARITY & TEST DISTANCE: HORIZONTAL AT 3 M

| NO. | FREQ. (MHz) | EMISSION LEVEL (dBuV/m) | LIMIT (dBuV/m) | MARGIN (dB) | ANTENNA HEIGHT (m) | TABLE ANGLE (Degree) | RAW VALUE (dBuV) | CORRECTION FACTOR (dB/m) |
|-----|----------------|-------------------------------|-------------------|----------------|--------------------------|----------------------------|------------------------|--------------------------------|
| 1 | *2452.00 | 110.2 PK | | | 1.72 H | 0 | 115.60 | -5.40 |
| 2 | *2452.00 | 97.2 AV | | | 1.72 H | 0 | 102.60 | -5.40 |
| 3 | 2483.50 | 71.3 PK | 74.0 | -2.7 | 1.72 H | 0 | 76.60 | -5.30 |
| 4 | 2483.50 | 53.7 AV | 54.0 | -0.3 | 1.72 H | 0 | 59.00 | -5.30 |
| 5 | 4904.00 | 40.7 PK | 74.0 | -33.3 | 3.51 H | 339 | 39.50 | 1.20 |
| 6 | 4904.00 | 35.8 AV | 54.0 | -18.2 | 3.51 H | 339 | 34.60 | 1.20 |
| 7 | 7356.00 | 44.4 PK | 74.0 | -29.6 | 1.63 H | 218 | 36.70 | 7.70 |
| 8 | 7356.00 | 31.4 AV | 54.0 | -22.6 | 1.63 H | 218 | 23.70 | 7.70 |

ANTENNA POLARITY & TEST DISTANCE: VERTICAL AT 3 M

| NO. | FREQ. (MHz) | EMISSION LEVEL (dBuV/m) | LIMIT (dBuV/m) | MARGIN (dB) | ANTENNA HEIGHT (m) | TABLE ANGLE (Degree) | RAW VALUE (dBuV) | CORRECTION FACTOR (dB/m) |
|-----|----------------|-------------------------------|-------------------|----------------|--------------------------|----------------------------|------------------------|--------------------------------|
| 1 | *2452.00 | 106.7 PK | | | 1.51 V | 48 | 112.10 | -5.40 |
| 2 | *2452.00 | 94.8 AV | | | 1.51 V | 48 | 100.20 | -5.40 |
| 3 | 2483.50 | 67.3 PK | 74.0 | -6.7 | 1.51 V | 48 | 72.60 | -5.30 |
| 4 | 2483.50 | 48.2 AV | 54.0 | -5.8 | 1.51 V | 48 | 53.50 | -5.30 |
| 5 | 4904.00 | 44.2 PK | 74.0 | -29.8 | 1.85 V | 94 | 43.00 | 1.20 |
| 6 | 4904.00 | 33.9 AV | 54.0 | -20.1 | 1.85 V | 94 | 32.70 | 1.20 |
| 7 | 7356.00 | 43.4 PK | 74.0 | -30.6 | 2.84 V | 55 | 35.70 | 7.70 |
| 8 | 7356.00 | 31.0 AV | 54.0 | -23.0 | 2.84 V | 55 | 23.30 | 7.70 |

REMARKS:

1. Emission Level(dBuV/m) = Raw Value(dBuV) + Correction Factor(dB/m)
2. Correction Factor(dB/m) = Antenna Factor(dB/m) + Cable Factor(dB) – Pre-Amplifier Factor(dB)
3. The other emission levels were very low against the limit.
4. Margin value = Emission Level – Limit value
5. " * ": Fundamental frequency.

Below 1GHz Data:
802.11g

| | | | |
|------------------------|--------------|------------------------------|-----------------|
| CHANNEL | TX Channel 6 | DETECTOR FUNCTION | Quasi-Peak (QP) |
| FREQUENCY RANGE | below 1GHz | | |

ANTENNA POLARITY & TEST DISTANCE: HORIZONTAL AT 3 M

| NO. | FREQ. (MHz) | EMISSION LEVEL (dBuV/m) | LIMIT (dBuV/m) | MARGIN (dB) | ANTENNA HEIGHT (m) | TABLE ANGLE (Degree) | RAW VALUE (dBuV) | CORRECTION FACTOR (dB/m) |
|-----|----------------|-------------------------------|-------------------|----------------|--------------------------|----------------------------|------------------------|--------------------------------|
| 1 | 108.82 | 35.7 QP | 43.5 | -7.8 | 2.50 H | 92 | 47.20 | -11.50 |
| 2 | 128.90 | 24.2 QP | 43.5 | -19.3 | 2.50 H | 77 | 34.20 | -10.00 |
| 3 | 256.18 | 21.3 QP | 46.0 | -24.7 | 2.50 H | 67 | 31.00 | -9.70 |
| 4 | 325.03 | 22.5 QP | 46.0 | -23.5 | 1.00 H | 213 | 29.70 | -7.20 |
| 5 | 403.67 | 22.0 QP | 46.0 | -24.0 | 1.00 H | 61 | 27.30 | -5.30 |
| 6 | 609.36 | 24.8 QP | 46.0 | -21.2 | 2.50 H | 360 | 25.00 | -0.20 |

ANTENNA POLARITY & TEST DISTANCE: VERTICAL AT 3 M

| NO. | FREQ. (MHz) | EMISSION LEVEL (dBuV/m) | LIMIT (dBuV/m) | MARGIN (dB) | ANTENNA HEIGHT (m) | TABLE ANGLE (Degree) | RAW VALUE (dBuV) | CORRECTION FACTOR (dB/m) |
|-----|----------------|-------------------------------|-------------------|----------------|--------------------------|----------------------------|------------------------|--------------------------------|
| 1 | 73.93 | 33.8 QP | 40.0 | -6.2 | 1.50 V | 9 | 45.50 | -11.70 |
| 2 | 111.57 | 34.0 QP | 43.5 | -9.5 | 1.00 V | 9 | 45.20 | -11.20 |
| 3 | 162.53 | 23.0 QP | 43.5 | -20.5 | 1.00 V | 250 | 31.70 | -8.70 |
| 4 | 270.24 | 25.6 QP | 46.0 | -20.4 | 1.50 V | 175 | 34.50 | -8.90 |
| 5 | 350.00 | 23.6 QP | 46.0 | -22.4 | 1.50 V | 117 | 30.50 | -6.90 |
| 6 | 610.40 | 24.6 QP | 46.0 | -21.4 | 2.50 V | 173 | 24.80 | -0.20 |

REMARKS:

1. Emission Level(dBuV/m) = Raw Value(dBuV) + Correction Factor(dB/m)
2. Correction Factor(dB/m) = Antenna Factor(dB/m) + Cable Factor(dB) – Pre-Amplifier Factor(dB)
3. The other emission levels were very low against the limit.
4. Margin value = Emission Level – Limit value

4.2 Conducted Emission Measurement

4.2.1 Limits of Conducted Emission Measurement

| Frequency (MHz) | Conducted Limit (dBuV) | |
|-----------------|------------------------|---------|
| | Quasi-peak | Average |
| 0.15 - 0.5 | 66 - 56 | 56 - 46 |
| 0.50 - 5.0 | 56 | 46 |
| 5.0 - 30.0 | 60 | 50 |

Note: 1. The lower limit shall apply at the transition frequencies.

2. The limit decreases in line with the logarithm of the frequency in the range of 0.15 to 0.50MHz.

4.2.2 Test Instruments

| DESCRIPTION & MANUFACTURER | MODEL NO. | SERIAL NO. | CALIBRATED DATE | CALIBRATED UNTIL |
|-------------------------------------------------------------|-------------------------|------------|-----------------|------------------|
| Test Receiver R&S | ESCS 30 | 847124/029 | Oct. 23, 2015 | Oct. 22, 2016 |
| Line-Impedance Stabilization Network (for EUT) R&S | ESH3-Z5 | 848773/004 | Oct. 28, 2015 | Oct. 27, 2016 |
| RF Cable | 5D-FB | COACAB-002 | Mar. 04, 2016 | Mar. 03, 2017 |
| 10 dB PAD Mini-Circuits | HAT-10+ | CONATT-004 | Jun. 20, 2016 | Jun. 19, 2017 |
| Software BVADT | BVADT_Cond_ V7.3.7.3 | NA | NA | NA |

Note:

1. The calibration interval of the above test instruments are 12 months and the calibrations are traceable to NML/ROC and NIST/USA.
2. The test was performed in Shielded Room No. 1.
- 3 Tested Date: June 22, 2016

4.2.3 Test Procedures

- The EUT was placed 0.4 meters from the conducting wall of the shielded room with EUT being connected to the power mains through a line impedance stabilization network (LISN). Other support units were connected to the power mains through another LISN. The two LISNs provide 50 ohm/ 50uH of coupling impedance for the measuring instrument.
- Both lines of the power mains connected to the EUT were checked for maximum conducted interference.
- The frequency range from 150kHz to 30MHz was searched. Emission levels under (Limit - 20dB) was not recorded.

NOTE: The resolution bandwidth and video bandwidth of test receiver is 9kHz for quasi-peak detection (QP) and average detection (AV) at frequency 0.15MHz-30MHz.

4.2.4 Deviation from Test Standard

No deviation.

4.2.5 Test Setup

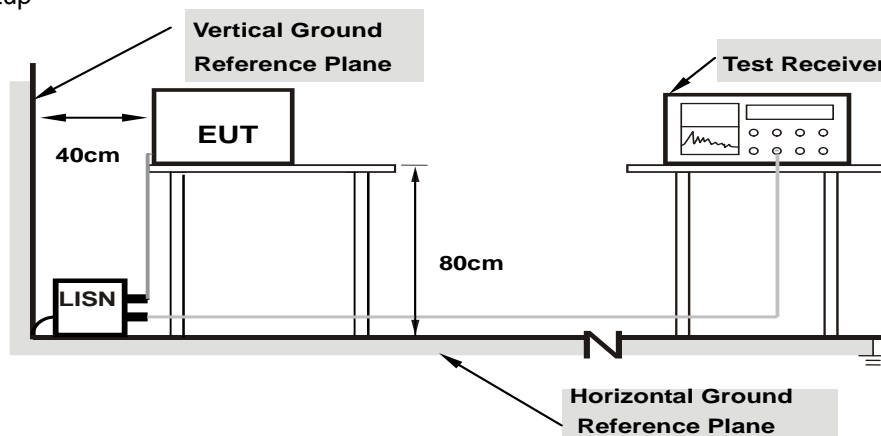

Note: 1.Support units were connected to second LISN.

For the actual test configuration, please refer to the attached file (Test Setup Photo).

4.2.6 EUT Operating Conditions

Same as 4.1.6.

4.2.7 Test Results

| Phase | Line (L) | Detector Function | Quasi-Peak (QP) / Average (AV) |
|-------|----------|-------------------|--------------------------------|
|-------|----------|-------------------|--------------------------------|

| No | Freq. [MHz] | Corr. | Reading Value | | Emission Level | | Limit | | Margin | |
|----|----------------|----------------|---------------|-------|----------------|-------|-----------|-------|--------|--------|
| | | Factor (dB) | [dB (uV)] | | [dB (uV)] | | [dB (uV)] | | (dB) | |
| | | | Q.P. | AV. | Q.P. | AV. | Q.P. | AV. | Q.P. | AV. |
| 1 | 0.16562 | 10.21 | 36.50 | 22.89 | 46.71 | 33.10 | 65.18 | 55.18 | -18.46 | -22.07 |
| 2 | 0.22031 | 10.22 | 29.11 | 16.39 | 39.33 | 26.61 | 62.81 | 52.81 | -23.48 | -26.20 |
| 3 | 0.37266 | 10.22 | 31.29 | 26.35 | 41.51 | 36.57 | 58.44 | 48.44 | -16.93 | -11.87 |
| 4 | 3.11719 | 10.30 | 17.99 | 12.19 | 28.29 | 22.49 | 56.00 | 46.00 | -27.71 | -23.51 |
| 5 | 6.55469 | 10.43 | 23.37 | 18.81 | 33.80 | 29.24 | 60.00 | 50.00 | -26.20 | -20.76 |
| 6 | 24.00000 | 11.43 | 23.17 | 22.61 | 34.60 | 34.04 | 60.00 | 50.00 | -25.40 | -15.96 |

REMARKS:

1. Q.P. and AV. are abbreviations of quasi-peak and average individually.
2. The emission levels of other frequencies were very low against the limit.
3. Margin value = Emission level - Limit value
4. Correction factor = Insertion loss + Cable loss
5. Emission Level = Correction Factor + Reading Value.

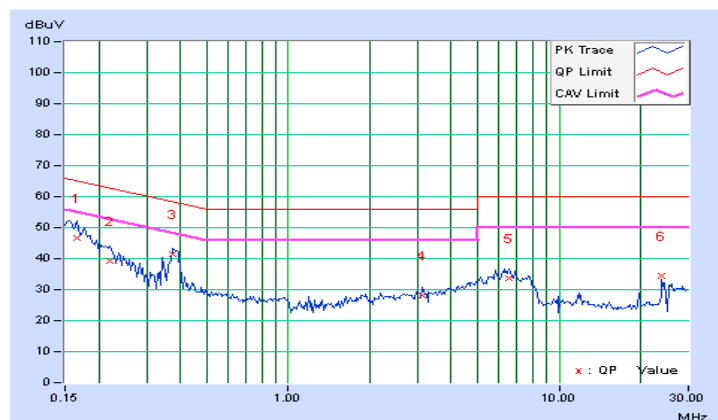

| | | | |
|-------|-------------|-------------------|--------------------------------|
| Phase | Neutral (N) | Detector Function | Quasi-Peak (QP) / Average (AV) |
|-------|-------------|-------------------|--------------------------------|

| No | Freq. [MHz] | Corr. | Reading Value | | Emission Level | | Limit | | Margin | |
|----------|----------------|--------------|---------------|--------------|----------------|--------------|--------------|--------------|---------------|---------------|
| | | Factor | [dB (uV)] | | [dB (uV)] | | [dB (uV)] | | (dB) | |
| | | (dB) | Q.P. | AV. | Q.P. | AV. | Q.P. | AV. | Q.P. | AV. |
| 1 | 0.15781 | 10.19 | 38.02 | 23.58 | 48.21 | 33.77 | 65.58 | 55.58 | -17.37 | -21.81 |
| 2 | 0.21250 | 10.21 | 29.47 | 16.37 | 39.68 | 26.58 | 63.11 | 53.11 | -23.43 | -26.53 |
| 3 | 0.37656 | 10.20 | 32.21 | 27.18 | 42.41 | 37.38 | 58.35 | 48.35 | -15.94 | -10.97 |
| 4 | 2.17969 | 10.29 | 18.01 | 13.50 | 28.30 | 23.79 | 56.00 | 46.00 | -27.70 | -22.21 |
| 5 | 5.94141 | 10.33 | 24.41 | 19.66 | 34.74 | 29.99 | 60.00 | 50.00 | -25.26 | -20.01 |
| 6 | 24.00000 | 11.13 | 23.45 | 22.49 | 34.58 | 33.62 | 60.00 | 50.00 | -25.42 | -16.38 |

REMARKS:

1. Q.P. and AV. are abbreviations of quasi-peak and average individually.
2. The emission levels of other frequencies were very low against the limit.
3. Margin value = Emission level - Limit value
4. Correction factor = Insertion loss + Cable loss
5. Emission Level = Correction Factor + Reading Value.

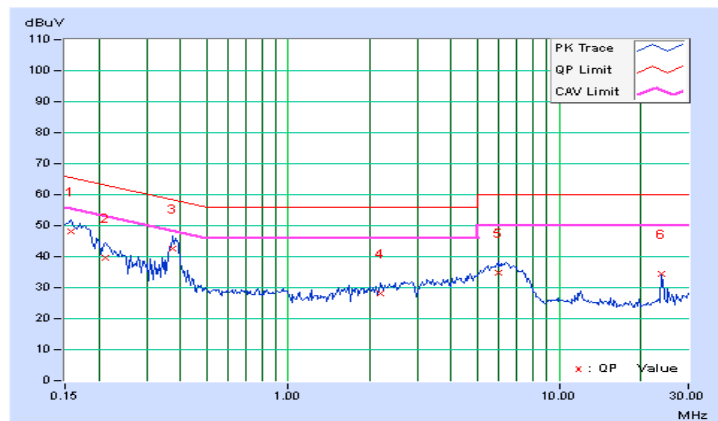

4.3 6dB Bandwidth Measurement

4.3.1 Limits of 6dB Bandwidth Measurement

The minimum of 6dB Bandwidth Measurement is 0.5 MHz.

4.3.2 Test Setup

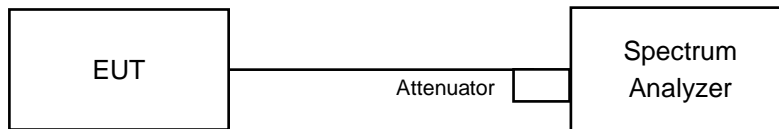

4.3.3 Test Instruments

Refer to section 4.1.2 to get information of above instrument.

4.3.4 Test Procedure

- a. Set resolution bandwidth (RBW) = 100kHz
- b. Set the video bandwidth (VBW) $\geq 3 \times$ RBW, Detector = Peak.
- c. Trace mode = max hold.
- d. Sweep = auto couple.
- e. Measure the maximum width of the emission that is constrained by the frequencies associated with the two amplitude points (upper and lower) that are attenuated by 6 dB relative to the maximum level measured in the fundamental emission

4.3.5 Deviation from Test Standard

No deviation.

4.3.6 EUT Operating Conditions

The software provided by client to enable the EUT under transmission condition continuously at lowest, middle and highest channel frequencies individually.

4.3.7 Test Result

802.11b

| Channel | Frequency (MHz) | 6dB Bandwidth (MHz) | | Minimum Limit (MHz) | Pass / Fail |
|---------|-----------------|---------------------|---------|---------------------|-------------|
| | | Chain 0 | Chain 1 | | |
| 1 | 2412 | 10.13 | 10.12 | 0.5 | Pass |
| 6 | 2437 | 10.10 | 10.12 | 0.5 | Pass |
| 11 | 2462 | 10.11 | 10.13 | 0.5 | Pass |

802.11g

| Channel | Frequency (MHz) | 6dB Bandwidth (MHz) | | Minimum Limit (MHz) | Pass / Fail |
|---------|-----------------|---------------------|---------|---------------------|-------------|
| | | Chain 0 | Chain 1 | | |
| 1 | 2412 | 16.45 | 16.43 | 0.5 | Pass |
| 6 | 2437 | 16.40 | 16.42 | 0.5 | Pass |
| 11 | 2462 | 16.44 | 16.43 | 0.5 | Pass |

802.11n (HT20)

| Channel | Frequency (MHz) | 6dB Bandwidth (MHz) | | Minimum Limit (MHz) | Pass / Fail |
|---------|-----------------|---------------------|---------|---------------------|-------------|
| | | Chain 0 | Chain 1 | | |
| 1 | 2412 | 17.61 | 17.61 | 0.5 | Pass |
| 6 | 2437 | 17.63 | 17.63 | 0.5 | Pass |
| 11 | 2462 | 17.60 | 17.63 | 0.5 | Pass |

802.11n (HT40)

| Channel | Frequency (MHz) | 6dB Bandwidth (MHz) | | Minimum Limit (MHz) | Pass / Fail |
|---------|-----------------|---------------------|---------|---------------------|-------------|
| | | Chain 0 | Chain 1 | | |
| 3 | 2422 | 36.41 | 36.41 | 0.5 | Pass |
| 6 | 2437 | 36.21 | 36.40 | 0.5 | Pass |
| 9 | 2452 | 36.22 | 36.39 | 0.5 | Pass |

Spectrum Plot of Worst Value

802.11b / Chain 0 : CH6

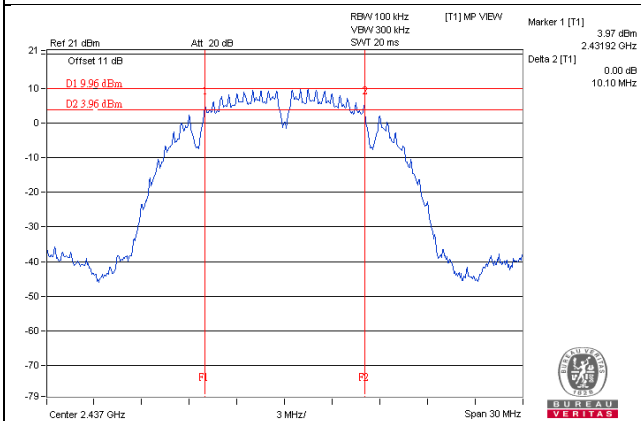

802.11g / Chain 0 : CH6

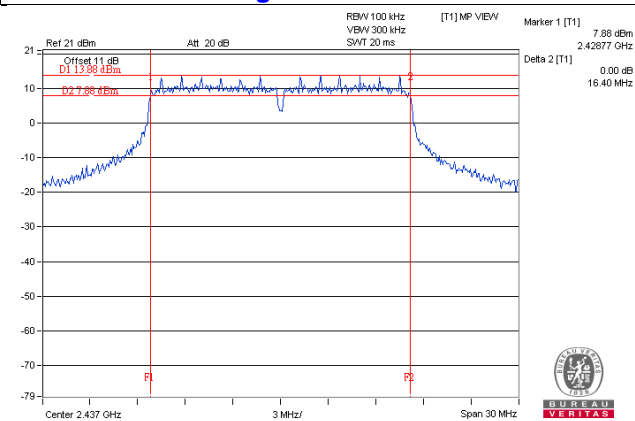

802.11n (HT20) / Chain 0 : CH11

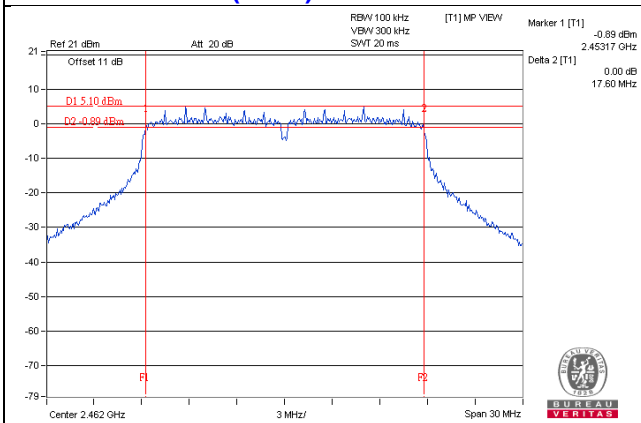

802.11n (HT40) / Chain 0 : CH6

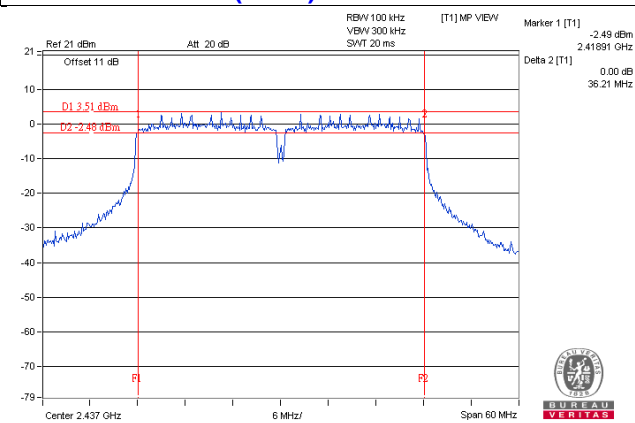

4.4 Conducted Output Power Measurement

4.4.1 Limits of Conducted Output Power Measurement

For systems using digital modulation in the 2400–2483.5 MHz bands: 1 Watt (30dBm)

Per KDB 662911 D01 Multiple Transmitter Output Method of conducted output power measurement on IEEE 802.11 devices,

Array Gain = 0 dB (i.e., no array gain) for $N_{ANT} \leq 4$;

Array Gain = 0 dB (i.e., no array gain) for channel widths ≥ 40 MHz for any N_{ANT} ;

Array Gain = $5 \log(N_{ANT}/N_{SS})$ dB or 3 dB, whichever is less for 20-MHz channel widths with $N_{ANT} \geq 5$.

For power measurements on all other devices: Array Gain = $10 \log(N_{ANT}/N_{SS})$ dB.

4.4.2 Test Setup

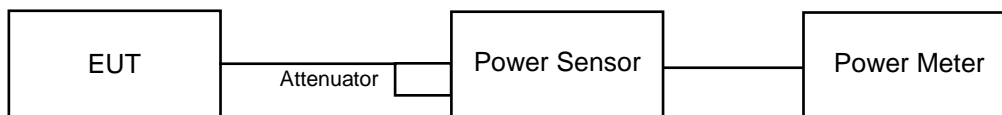

4.4.3 Test Instruments

Refer to section 4.1.2 to get information of above instrument.

4.4.4 Test Procedures

An average power sensor was used on the output port of the EUT. A power meter was used to read the response of the average power sensor. Record the power level.

4.4.5 Deviation from Test Standard

No deviation.

4.4.6 EUT Operating Conditions

Same as Item 4.3.6.

4.4.7 Test Results

802.11b

| Chan. | Freq. (MHz) | Avg. Power (dBm) | | Total Power (mW) | Total Power (dBm) | Limit (dBm) | Pass / Fail |
|-------|-------------|------------------|---------|------------------|-------------------|-------------|-------------|
| | | Chain 0 | Chain 1 | | | | |
| 1 | 2412 | 21.62 | 21.92 | 300.808 | 24.78 | 30 | Pass |
| 6 | 2437 | 19.47 | 19.88 | 185.787 | 22.69 | 30 | Pass |
| 11 | 2462 | 22.73 | 22.87 | 381.141 | 25.81 | 30 | Pass |

802.11g

| Chan. | Freq. (MHz) | Avg. Power (dBm) | | Total Power (mW) | Total Power (dBm) | Limit (dBm) | Pass / Fail |
|-------|-------------|------------------|---------|------------------|-------------------|-------------|-------------|
| | | Chain 0 | Chain 1 | | | | |
| 1 | 2412 | 17.63 | 18.25 | 124.777 | 20.96 | 30 | Pass |
| 6 | 2437 | 25.61 | 25.84 | 747.622 | 28.74 | 30 | Pass |
| 11 | 2462 | 19.04 | 19.43 | 167.868 | 22.25 | 30 | Pass |

802.11n (HT20)

| Chan. | Freq. (MHz) | Avg. Power (dBm) | | Total Power (mW) | Total Power (dBm) | Limit (dBm) | Pass / Fail |
|-------|-------------|------------------|---------|------------------|-------------------|-------------|-------------|
| | | Chain 0 | Chain 1 | | | | |
| 1 | 2412 | 17.90 | 18.29 | 129.113 | 21.11 | 30 | Pass |
| 6 | 2437 | 25.61 | 25.84 | 747.622 | 28.74 | 30 | Pass |
| 11 | 2462 | 16.65 | 17.20 | 98.719 | 19.94 | 30 | Pass |

802.11n (HT40)

| Chan. | Freq. (MHz) | Avg. Power (dBm) | | Total Power (mW) | Total Power (dBm) | Limit (dBm) | Pass / Fail |
|-------|-------------|------------------|---------|------------------|-------------------|-------------|-------------|
| | | Chain 0 | Chain 1 | | | | |
| 3 | 2422 | 14.51 | 15.48 | 63.567 | 18.03 | 30 | Pass |
| 6 | 2437 | 17.75 | 18.06 | 123.539 | 20.92 | 30 | Pass |
| 9 | 2452 | 14.25 | 14.93 | 57.724 | 17.61 | 30 | Pass |

4.5 Power Spectral Density Measurement

4.5.1 Limits of Power Spectral Density Measurement

The Maximum of Power Spectral Density Measurement is 8dBm.

4.5.2 Test Setup

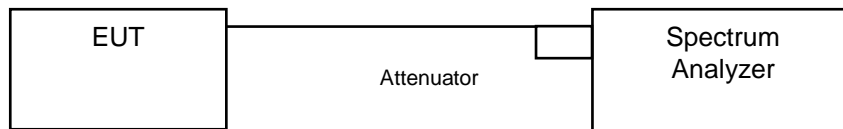

4.5.3 Test Instruments

Refer to section 4.1.2 to get information of above instrument.

4.5.4 Test Procedure

- a) Set instrument center frequency to DTS channel center frequency.
- b) Set span to at least 1.5 times the OBW.
- c) Set RBW to: $3 \text{ kHz} \leq \text{RBW} \leq 100 \text{ kHz}$.
- d) Set VBW $\geq 3 \times \text{RBW}$.
- e) Detector = power averaging (RMS) or sample detector (when RMS not available).
- f) Ensure that the number of measurement points in the sweep $\geq 2 \times \text{span}/\text{RBW}$.
- g) Sweep time = auto couple.
- h) Employ trace averaging (RMS) mode over a minimum of 100 traces.
- i) Use the peak marker function to determine the maximum amplitude level.

4.5.5 Deviation from Test Standard

No deviation.

4.5.6 EUT Operating Condition

Same as Item 4.3.6

4.5.7 Test Results

802.11b

| TX chain | Channel | Freq. (MHz) | PSD (dBm/10kHz) | 10 log (N=2) dB | Total PSD (dBm/10kHz) | Limit (dBm/3kHz) | Pass /Fail |
|----------|---------|-------------|-----------------|-----------------|-----------------------|------------------|------------|
| 0 | 1 | 2412 | -7.31 | 3.01 | -4.30 | 4.99 | Pass |
| | 6 | 2437 | -9.77 | 3.01 | -6.76 | 4.99 | Pass |
| | 11 | 2462 | -7.13 | 3.01 | -4.12 | 4.99 | Pass |
| 1 | 1 | 2412 | -6.39 | 3.01 | -3.38 | 4.99 | Pass |
| | 6 | 2437 | -7.76 | 3.01 | -4.75 | 4.99 | Pass |
| | 11 | 2462 | -5.75 | 3.01 | -2.74 | 4.99 | Pass |

NOTE: Directional gain = $6\text{dBi} + 10\log(2) = 9.01\text{dBi} > 6\text{dBi}$, so the power density limit shall be reduced to $8-(9.01-6) = 4.99\text{dBm}$.

802.11g

| TX chain | Channel | Freq. (MHz) | PSD (dBm/10kHz) | 10 log (N=2) dB | Total PSD (dBm/10kHz) | Limit (dBm/3kHz) | Pass /Fail |
|----------|---------|-------------|-----------------|-----------------|-----------------------|------------------|------------|
| 0 | 1 | 2412 | -12.28 | 3.01 | -9.27 | 4.99 | Pass |
| | 6 | 2437 | -5.12 | 3.01 | -2.11 | 4.99 | Pass |
| | 11 | 2462 | -12.04 | 3.01 | -9.03 | 4.99 | Pass |
| 1 | 1 | 2412 | -12.21 | 3.01 | -9.20 | 4.99 | Pass |
| | 6 | 2437 | -4.50 | 3.01 | -1.49 | 4.99 | Pass |
| | 11 | 2462 | -11.03 | 3.01 | -8.02 | 4.99 | Pass |

NOTE: Directional gain = $6\text{dBi} + 10\log(2) = 9.01\text{dBi} > 6\text{dBi}$, so the power density limit shall be reduced to $8-(9.01-6) = 4.99\text{dBm}$.

802.11n (HT20)

| TX chain | Channel | Freq. (MHz) | PSD (dBm/10kHz) | 10 log (N=2) dB | Total PSD (dBm/10kHz) | Limit (dBm/3kHz) | Pass /Fail |
|----------|---------|-------------|-----------------|-----------------|-----------------------|------------------|------------|
| 0 | 1 | 2412 | -13.36 | 3.01 | -10.35 | 4.99 | Pass |
| | 6 | 2437 | -5.42 | 3.01 | -2.41 | 4.99 | Pass |
| | 11 | 2462 | -14.04 | 3.01 | -11.03 | 4.99 | Pass |
| 1 | 1 | 2412 | -12.31 | 3.01 | -9.30 | 4.99 | Pass |
| | 6 | 2437 | -4.98 | 3.01 | -1.97 | 4.99 | Pass |
| | 11 | 2462 | -13.14 | 3.01 | -10.13 | 4.99 | Pass |

NOTE: Directional gain = $6\text{dBi} + 10\log(2) = 9.01\text{dBi} > 6\text{dBi}$, so the power density limit shall be reduced to $8-(9.01-6) = 4.99\text{dBm}$.

802.11n (HT40)

| TX chain | Channel | Freq. (MHz) | PSD (dBm/10kHz) | 10 log (N=2) dB | Total PSD (dBm/10kHz) | Limit (dBm/3kHz) | Pass /Fail |
|----------|---------|-------------|-----------------|-----------------|-----------------------|------------------|------------|
| 0 | 3 | 2422 | -19.00 | 3.01 | -15.99 | 4.99 | Pass |
| | 6 | 2437 | -15.12 | 3.01 | -12.11 | 4.99 | Pass |
| | 9 | 2452 | -12.27 | 3.01 | -9.26 | 4.99 | Pass |
| 1 | 3 | 2422 | -9.34 | 3.01 | -6.33 | 4.99 | Pass |
| | 6 | 2437 | -13.21 | 3.01 | -10.20 | 4.99 | Pass |
| | 9 | 2452 | -18.28 | 3.01 | -15.27 | 4.99 | Pass |

NOTE: Directional gain = $6\text{dBi} + 10\log(2) = 9.01\text{dBi} > 6\text{dBi}$, so the power density limit shall be reduced to $8 - (9.01 - 6) = 4.99\text{dBm}$.

Spectrum Plot of Worst Value

802.11b / Chain 1 : CH11

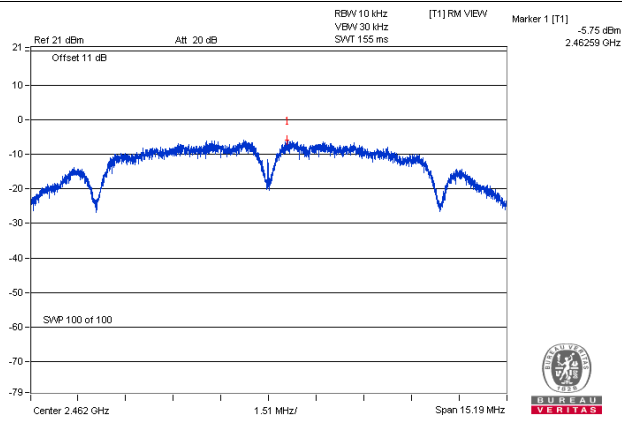

802.11g / Chain 1 : CH6

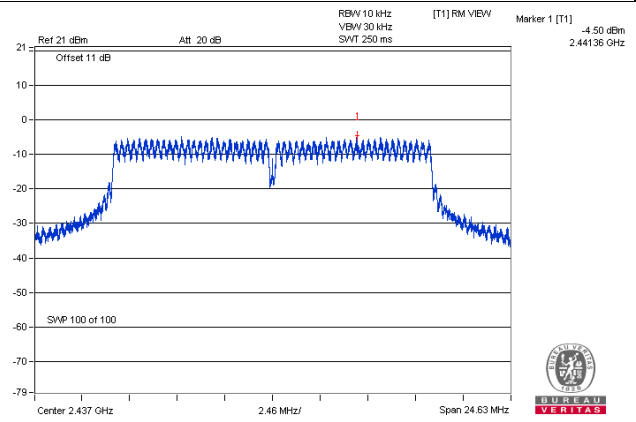

802.11n (HT20) / Chain 1 : CH6

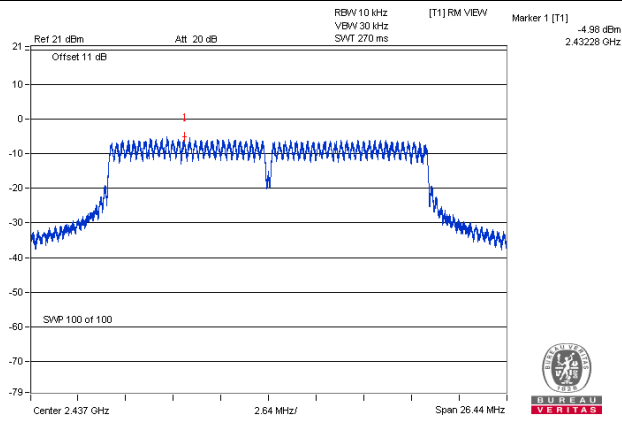

802.11n (HT40) / Chain 1 : CH3

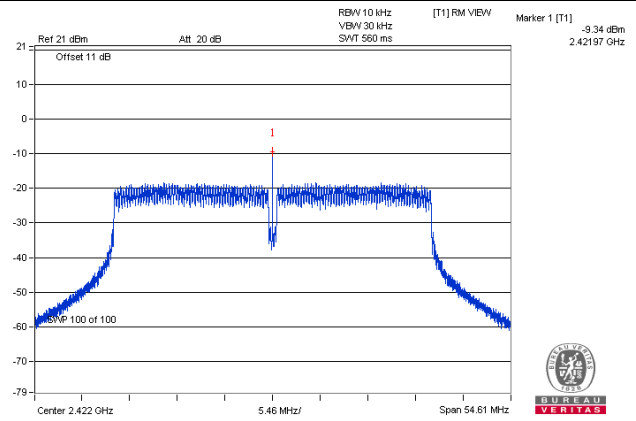

4.6 Conducted Out of Band Emission Measurement

4.6.1 Limits of Conducted Out of Band Emission Measurement

Below 30dB of the highest emission level of operating band (in 100kHz Resolution Bandwidth).

4.6.2 Test Setup

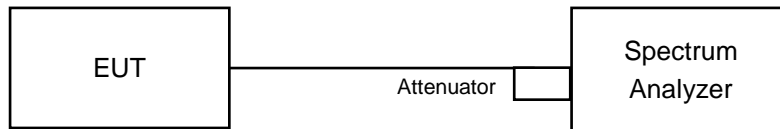

4.6.3 Test Instruments

Refer to section 4.1.2 to get information of above instrument.

4.6.4 Test Procedure

MEASUREMENT PROCEDURE REF

1. Set the RBW = 100 kHz.
2. Set the VBW \geq 300 kHz.
3. Detector = peak.
4. Sweep time = auto couple.
5. Trace mode = max hold.
6. Allow trace to fully stabilize.
7. Use the peak marker function to determine the maximum power level in any 100 kHz band segment within the fundamental EBW.

MEASUREMENT PROCEDURE OOBE

1. Set RBW = 100 kHz.
2. Set VBW \geq 300 kHz.
3. Detector = peak.
4. Sweep = auto couple.
5. Trace Mode = max hold.
6. Allow trace to fully stabilize.
7. Use the peak marker function to determine the maximum amplitude level.

4.6.5 Deviation from Test Standard

No deviation.

4.6.6 EUT Operating Condition

Same as Item 4.3.6

4.6.7 Test Results

The spectrum plots are attached on the following pages. D1 line indicates the highest level, and D2 line indicates the 30dB offset below D1. It shows compliance with the requirement.

802.11b

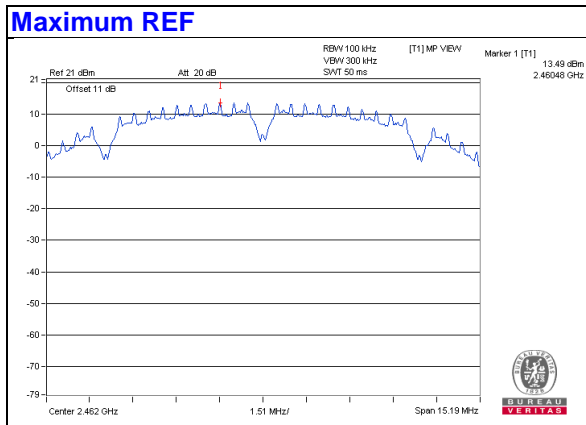

Chain 0

CH 1

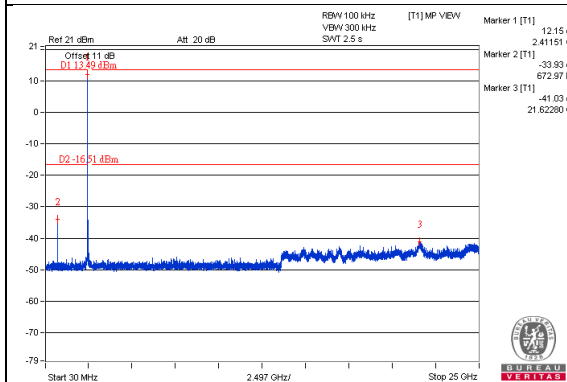

CH 6

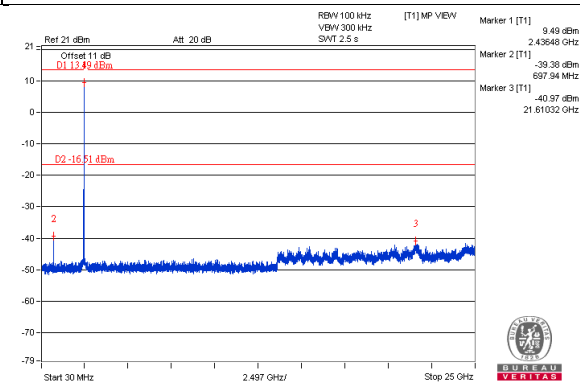

CH 11

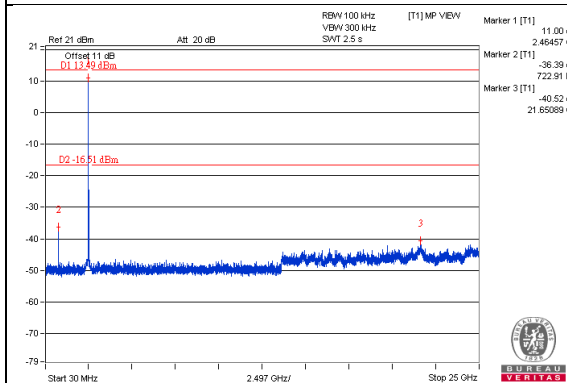

CH 1 Band edge

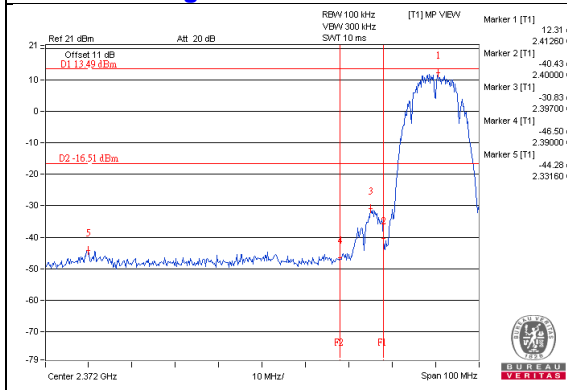

CH 11 Band edge

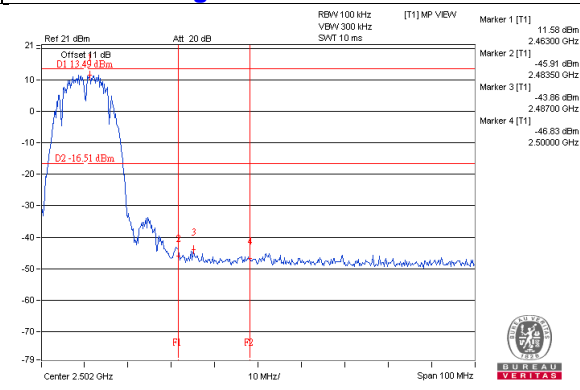

Chain 1

CH 1

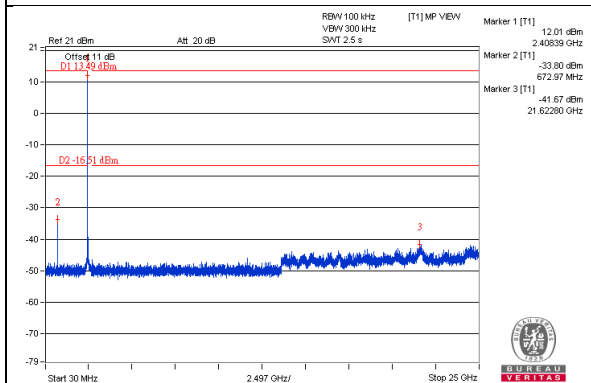

CH 6

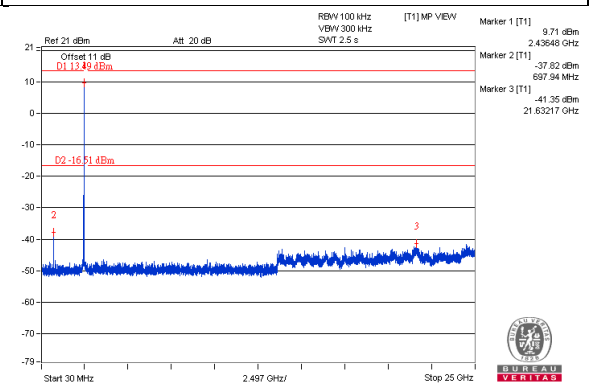

CH 11

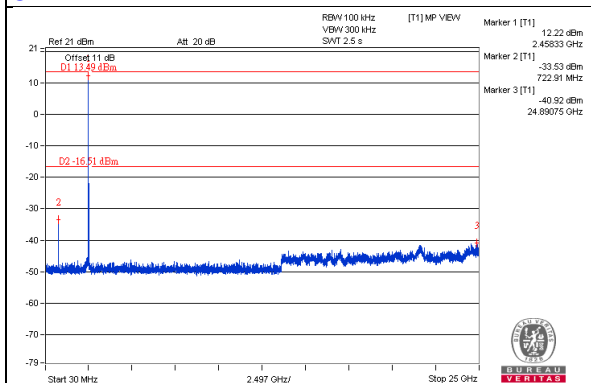

CH 1 Band edge

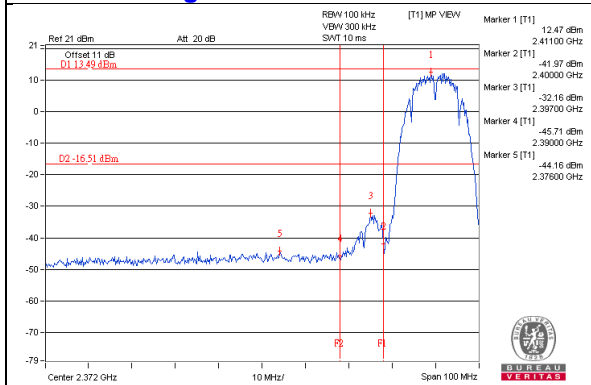

CH 11 Band edge

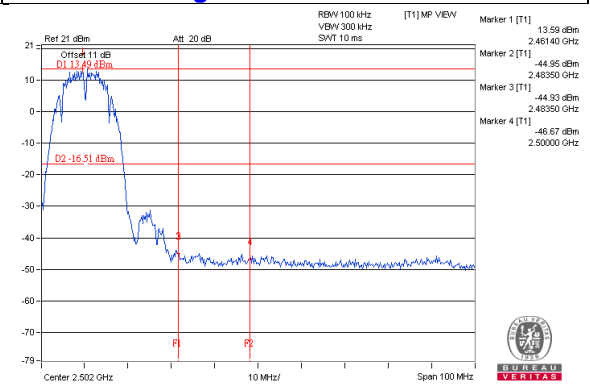

802.11g

Maximum REF

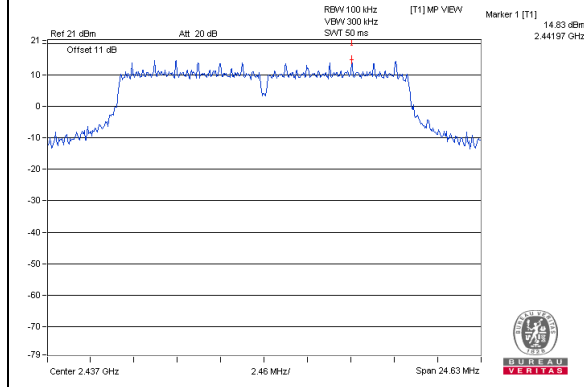

Chain 0

CH 1

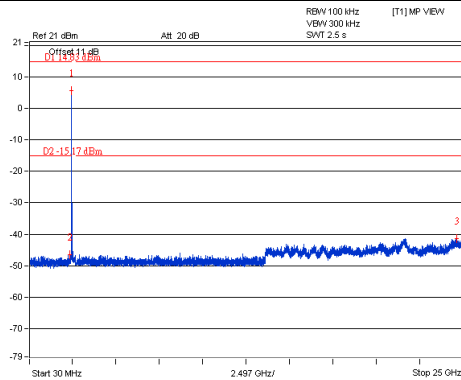

CH 6

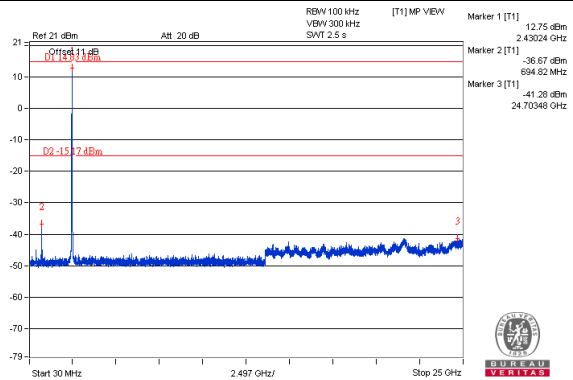

CH 11

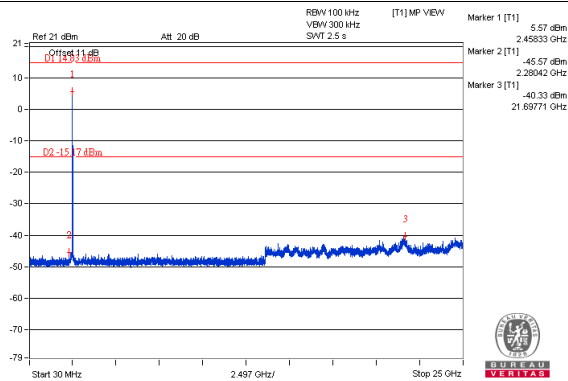

CH 1 Band edge

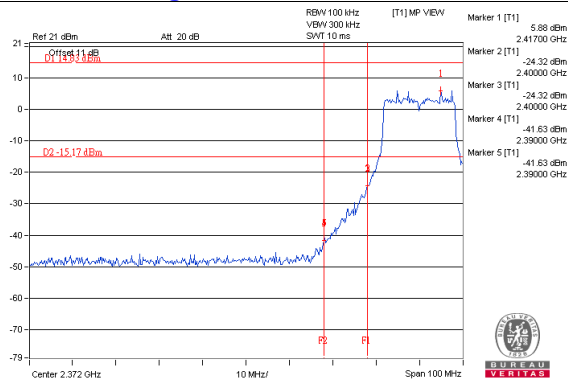

CH 11 Band edge

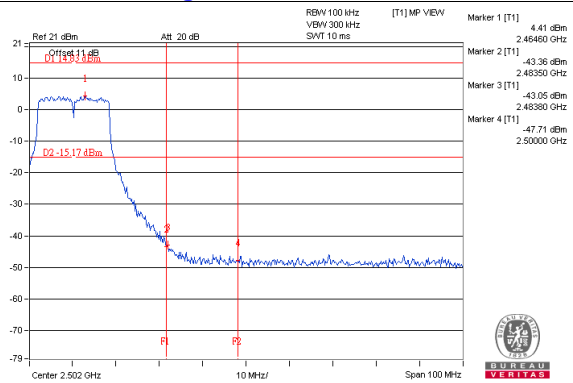

Chain 1

CH 1

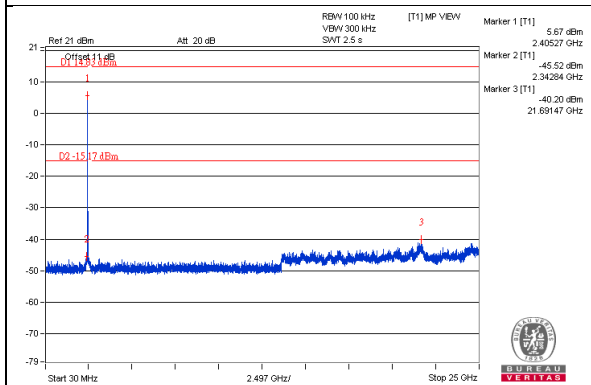

CH 6

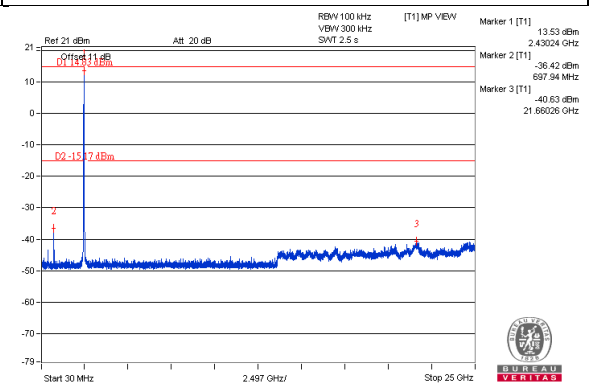

CH 11

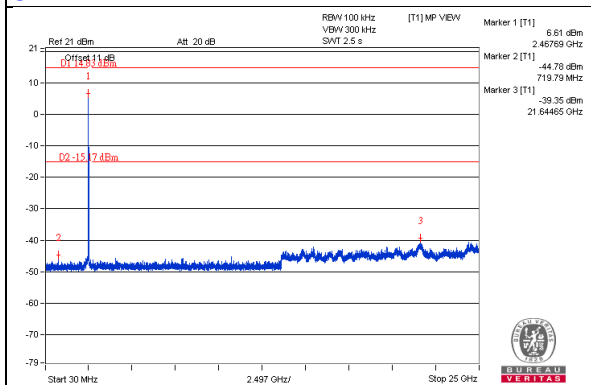

CH 11 Band edge

CH 1 Band edge

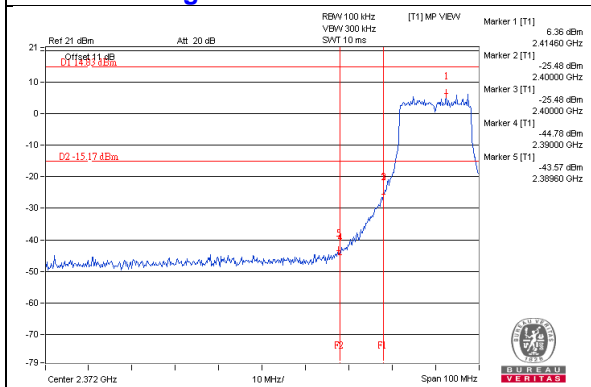

CH 11 Band edge

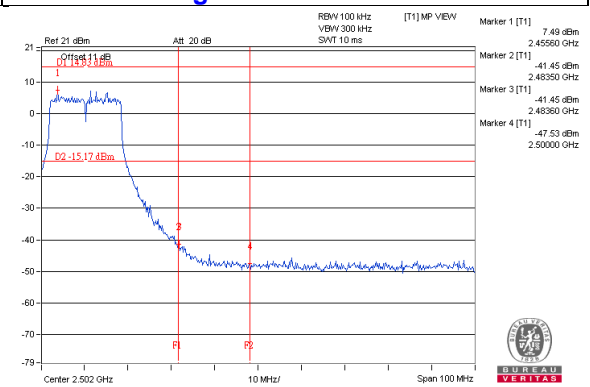

802.11n (HT20)

Maximum REF

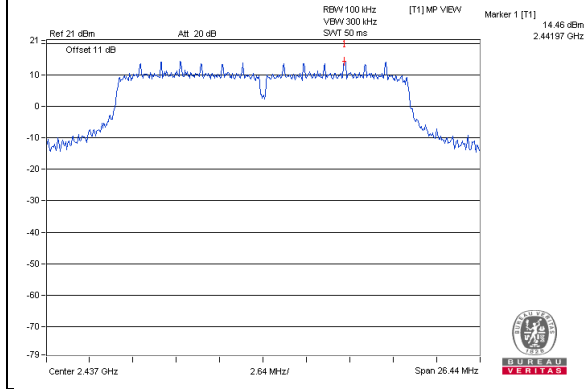

Chain 0

CH 1

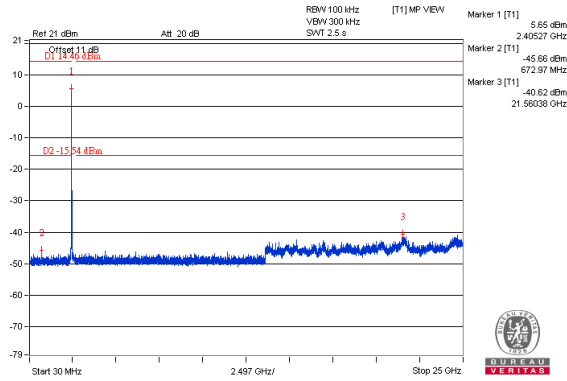

CH 6

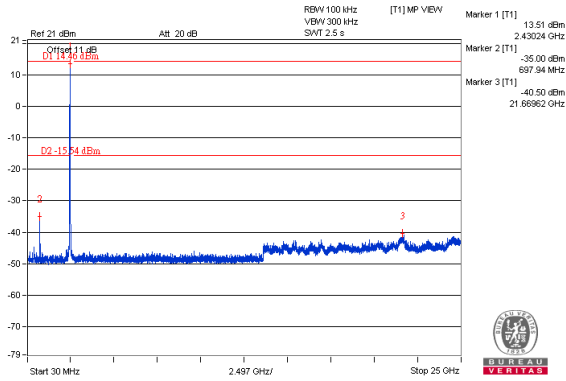

CH 11

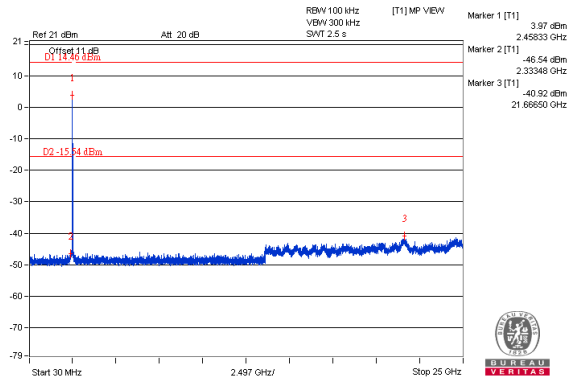

CH 1 Band edge

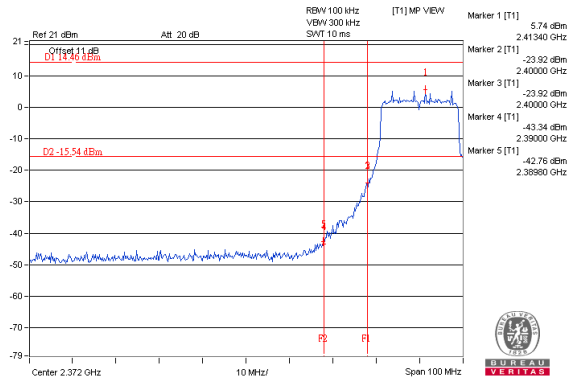

CH 11 Band edge

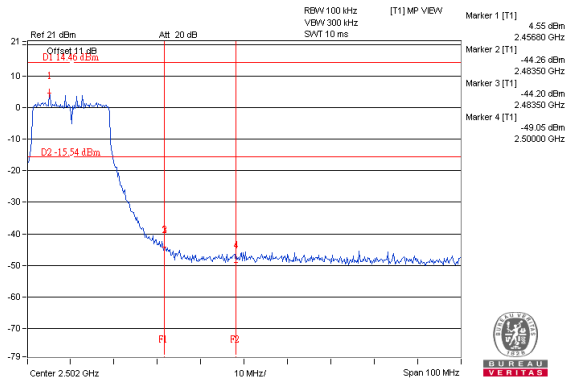

Chain 1

CH 1

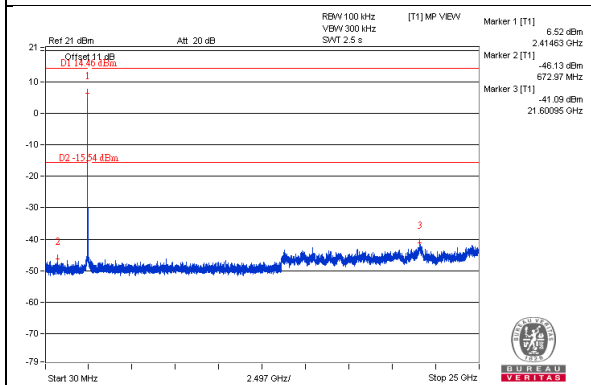

CH 6

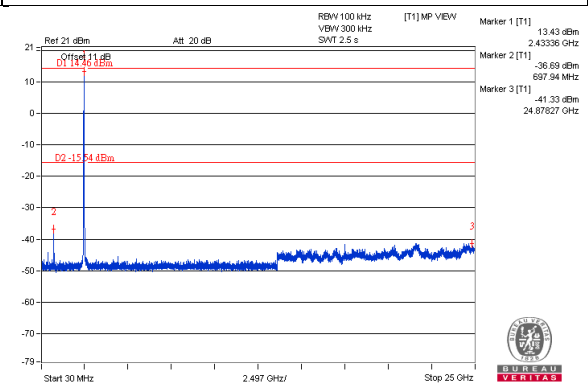

CH 11

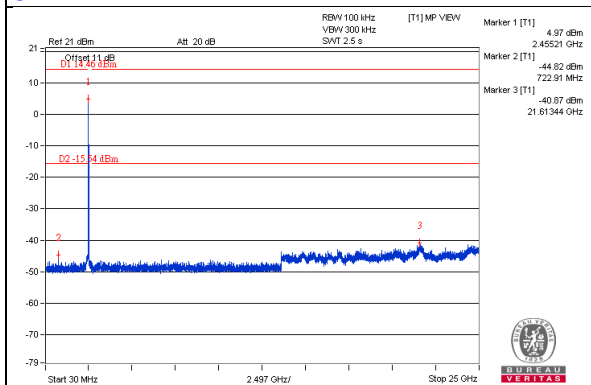

CH 1 Band edge

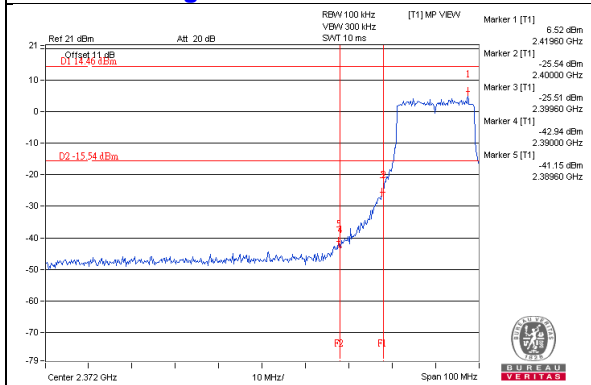

CH 11 Band edge

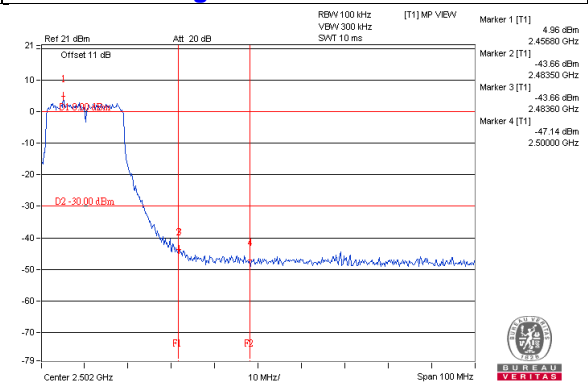

802.11n (HT40)

Maximum REF

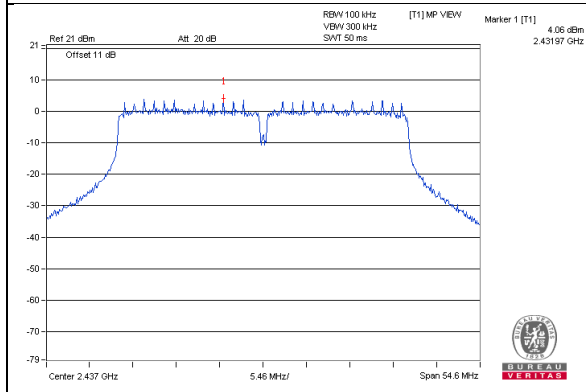

Chain 0

CH 3

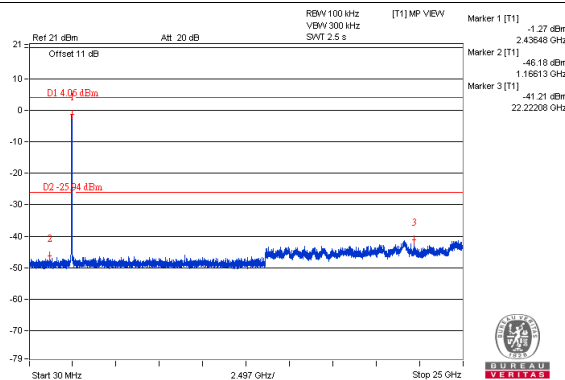

CH 6

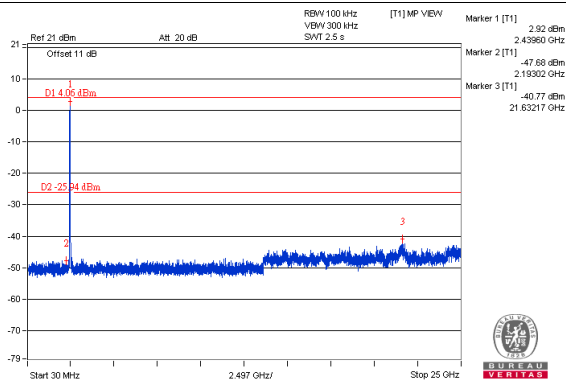

CH 9

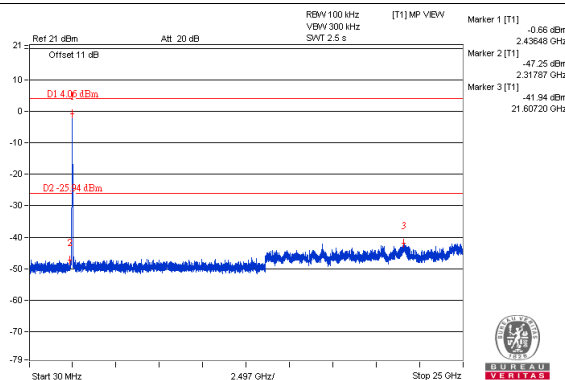

CH 3 Band edge

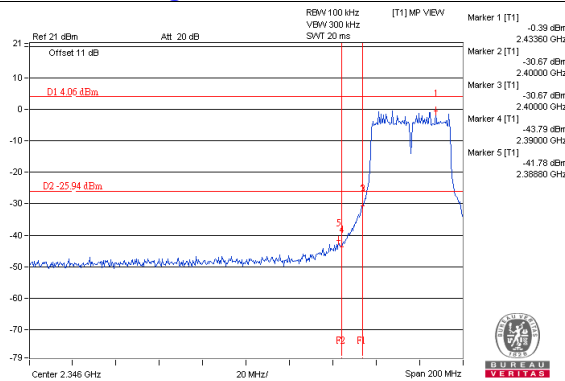

CH 9 Band edge

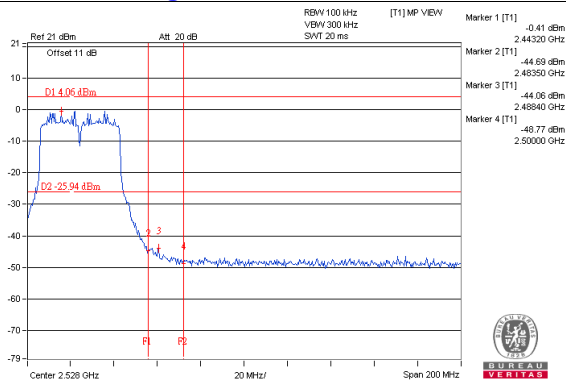

Chain 1

CH 3

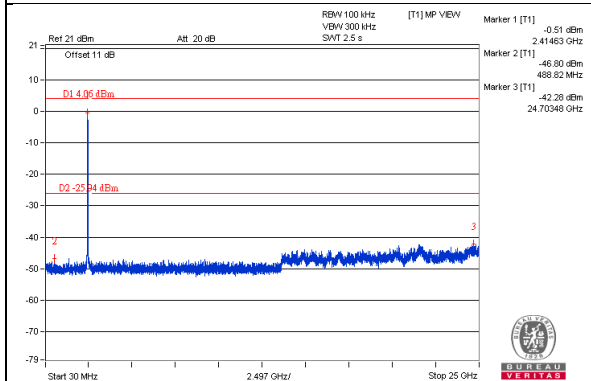

CH 6

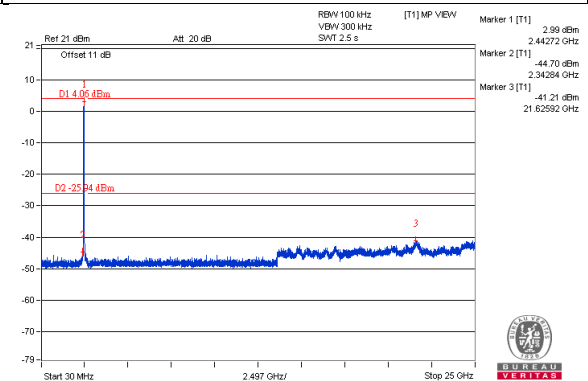

CH 9

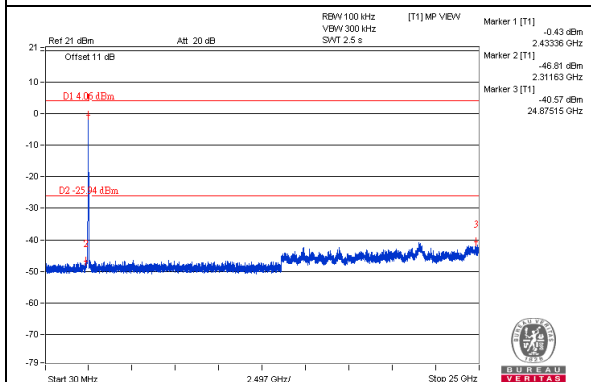

CH 3 Band edge

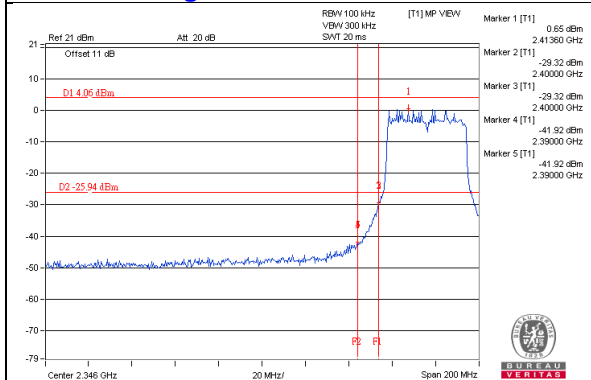

CH 9 Band edge

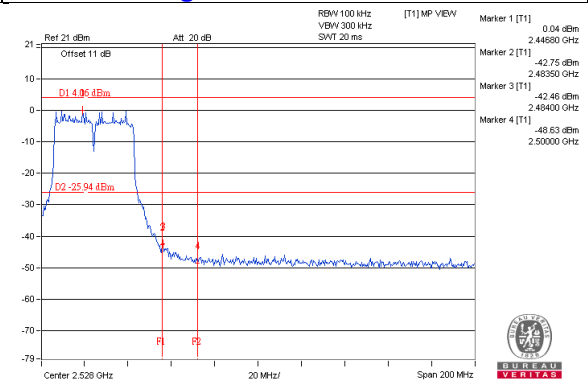

5 Pictures of Test Arrangements

Please refer to the attached file (Test Setup Photo).

Appendix – Information on the Testing Laboratories

We, Bureau Veritas Consumer Products Services (H.K.) Ltd., Taoyuan Branch, were founded in 1988 to provide our best service in EMC, Radio, Telecom and Safety consultation. Our laboratories are accredited and approved according to ISO/IEC 17025.

If you have any comments, please feel free to contact us at the following:

Linko EMC/RF Lab

Tel: 886-2-26052180

Fax: 886-2-26051924

Hsin Chu EMC/RF/Telecom Lab

Tel: 886-3-6668565

Fax: 886-3-6668323

Hwa Ya EMC/RF/Safety Lab

Tel: 886-3-3183232

Fax: 886-3-3270892

Email: service.adt@tw.bureauveritas.com

Web Site: www.bureauveritas-adt.com

The address and road map of all our labs can be found in our web site also.

--- END ---