

FCC Radio Test Report

FCC ID: W59XAP810

This report concerns (check one): Original Grant Class I Change Class II Change

Project No. : 1707C305
Equipment : AC1200 Dual-Band Wireless Access Point
Test Model : XAP-810
Series Model : XWS-1810
Applicant : Luxul Wireless
Address : 12884 S Frontrunner Blvd Suite 201 Draper UT
84020 USA

Date of Receipt : Jul. 26, 2017
Date of Test : Jul. 26, 2017 ~ Aug. 16, 2017
Issued Date : Aug. 17, 2017
Tested by : BTL Inc.

Testing Engineer : Shawn Xiao
(Shawn Xiao)

Technical Manager : David Mao
(David Mao)

Authorized Signatory : Steven Lu
(Steven Lu)

B T L I N C .

No.3, Jinshagang 1st Road, Shixia, Dalang Town, Dongguan,
Guangdong, China.

TEL: +86-769-8318-3000 FAX: +86-769-8319-6000

NVLAP[®]
Lab Code: 200788-0

Declaration

BTL represents to the client that testing is done in accordance with standard procedures as applicable and that test instruments used has been calibrated with standards traceable to international standard(s) and/or national standard(s).

BTL's reports apply only to the specific samples tested under conditions. It is manufacture's responsibility to ensure that additional production units of this model are manufactured with the identical electrical and mechanical components. **BTL** shall have no liability for any declarations, inferences or generalizations drawn by the client or others from **BTL** issued reports.

BTL's report must not be used by the client to claim product certification, approval, or endorsement by NVLAP, NIST, or any agency of the Federal Government.

This report is the confidential property of the client. As a mutual protection to the clients, the public and **BTL-self**, extracts from the test report shall not be reproduced except in full with **BTL's** authorized written approval.

BTL's laboratory quality assurance procedures are in compliance with the **ISO Guide 17025** requirements, and accredited by the conformity assessment authorities listed in this test report.

Limitation

For the use of the authority's logo is limited unless the Test Standard(s)/Scope(s)/Item(s) mentioned in this test report is (are) included in the conformity assessment authorities acceptance respective.

Table of Contents	Page
1 . CERTIFICATION	6
2 . SUMMARY OF TEST RESULTS	7
2.1 TEST FACILITY	8
2.2 MEASUREMENT UNCERTAINTY	8
3 . GENERAL INFORMATION	9
3.1 GENERAL DESCRIPTION OF EUT	9
3.2 DESCRIPTION OF TEST MODES	11
3.3 TABLE OF PARAMETERS OF TEST SOFTWARE SETTING	13
3.4 BLOCK DIAGRAM SHOWING THE CONFIGURATION OF SYSTEM TESTED	15
3.5 DESCRIPTION OF SUPPORT UNITS	15
4 . EMC EMISSION TEST	16
4.1 CONDUCTED EMISSION MEASUREMENT	16
4.1.1 POWER LINE CONDUCTED EMISSION	16
4.1.2 TEST PROCEDURE	16
4.1.3 DEVIATION FROM TEST STANDARD	16
4.1.4 TEST SETUP	17
4.1.5 EUT OPERATING CONDITIONS	17
4.1.6 EUT TEST CONDITIONS	17
4.1.7 TEST RESULTS	17
4.2 RADIATED EMISSION MEASUREMENT	18
4.2.1 RADIATED EMISSION LIMITS	18
4.2.2 TEST PROCEDURE	19
4.2.3 DEVIATION FROM TEST STANDARD	19
4.2.4 TEST SETUP	19
4.2.5 EUT OPERATING CONDITIONS	20
4.2.6 EUT TEST CONDITIONS	20
4.2.7 TEST RESULTS (9K TO 30MHz)	21
4.2.8 TEST RESULTS (30 TO 1000 MHz)	21
4.2.9 TEST RESULTS (ABOVE 1000 MHz)	21
5 . 26dB SPECTRUM BANDWIDTH	22
5.1 APPLIED PROCEDURES / LIMIT	22
5.1.1 TEST PROCEDURE	22
5.1.2 DEVIATION FROM STANDARD	22
5.1.3 TEST SETUP	22
5.1.4 EUT OPERATION CONDITIONS	22
5.1.5 EUT TEST CONDITIONS	23
5.1.6 TEST RESULTS	23
6 . MAXIMUM CONDUCTED OUTPUT POWER	24

Table of Contents	Page
6.1 APPLIED PROCEDURES / LIMIT	24
6.1.1 TEST PROCEDURE	24
6.1.2 DEVIATION FROM STANDARD	25
6.1.3 TEST SETUP	25
6.1.4 EUT OPERATION CONDITIONS	25
6.1.5 EUT TEST CONDITIONS	25
6.1.6 TEST RESULTS	25
7 . POWER SPECTRAL DENSITY TEST	26
7.1 APPLIED PROCEDURES / LIMIT	26
8.1.1 TEST PROCEDURE	26
7.1.1 DEVIATION FROM STANDARD	27
7.1.2 TEST SETUP	27
7.1.3 EUT OPERATION CONDITIONS	27
7.1.4 EUT TEST CONDITIONS	27
7.1.5 TEST RESULTS	27
8 . FREQUENCY STABILITY MEASUREMENT	28
8.1 APPLIED PROCEDURES / LIMIT	28
8.1.1 TEST PROCEDURE	28
8.1.2 DEVIATION FROM STANDARD	28
8.1.3 TEST SETUP	29
8.1.4 EUT OPERATION CONDITIONS	29
8.1.5 EUT TEST CONDITIONS	29
8.1.6 TEST RESULTS	29
9 . MEASUREMENT INSTRUMENTS LIST	30
10 . EUT TEST PHOTOS	32
ATTACHMENT A - CONDUCTED EMISSION	36
ATTACHMENT B - RADIATED EMISSION (9KHZ TO 30MHZ)	39
ATTACHMENT C - RADIATED EMISSION (30MHZ TO 1000MHZ)	44
ATTACHMENT D - RADIATED EMISSION (ABOVE 1000MHZ)	57
ATTACHMENT E - BANDWIDTH	176
ATTACHMENT F - MAXIMUM OUTPUT POWER	217
ATTACHMENT H - POWER SPECTRAL DENSITY	240
ATTACHMENT H - FREQUENCY STABILITY	337

REPORT ISSUED HISTORY

Issued No.	Description	Issued Date
BTL-FCCP-2-1707C305	Original Issue.	Aug. 17, 2017

1. CERTIFICATION

Equipment : AC1200 Dual-Band Wireless Access Point
Brand Name : LUXUL
Test Model : XAP-810
Series Model : XWS-1810
Applicant : Luxul Wireless
Manufacturer : Luxul Wireless
Address : 12884 S Frontrunner Blvd Suite 201 Draper UT 84020 USA
Date of Test : Jul. 26, 2017 ~ Aug. 16, 2017
Test Sample : Engineering Sample
Standard(s) : FCC Part15, Subpart E(15.407) / ANSI C63.10-2013

The above equipment has been tested and found compliance with the requirement of the relative standards by BTL Inc.

The test data, data evaluation, and equipment configuration contained in our test report (Ref No. BTL-FCCP-2-1707C305) were obtained utilizing the test procedures, test instruments, test sites that has been accredited by the Authority of NVLAP according to the ISO-17025 quality assessment standard and technical standard(s).

2. SUMMARY OF TEST RESULTS

Test procedures according to the technical standard(s):

FCC Part15, Subpart E(15.407)			
Standard(s) Section	Test Item	Judgment	Remark
15.207	AC Power Line Conducted Emissions	PASS	
15.407(a)	26dB Spectrum Bandwidth	PASS	
15.407(a)	Maximum Conducted Output Power	PASS	
15.407(a)	Power Spectral Density	PASS	
15.407(a)	Radiated Emissions	PASS	
15.407(b)	Band Edge Emissions	PASS	
15.407(g)	Frequency Stability	PASS	
15.203	Antenna Requirements	PASS	

NOTE:

(1) "N/A" denotes test is not applicable in this test report.

2.1 TEST FACILITY

The test facilities used to collect the test data in this report is at the location of No.3,Jinshagang 1st Road, Shixia, Dalang Town, Dongguan, Guangdong, China.

BTL's test firm number for FCC: 319330

2.2 MEASUREMENT UNCERTAINTY

Where relevant, the following measurement uncertainty levels have been estimated for tests performed on the EUT as specified in CISPR 16-4-2. The BTL measurement uncertainty is less than the CISPR 16-4-2 U_{CISPR} requirement.

The reported uncertainty of measurement $y \pm U$, where expanded uncertainty U is based on a standard uncertainty multiplied by a coverage factor of $k=2$, providing a level of confidence of approximately 95 %.

A. Conducted Measurement:

Test Site	Method	Measurement Frequency Range	U, (dB)
DG-C02	CISPR	150 KHz ~ 30MHz	1.94

B. Radiated Measurement:

Test Site	Method	Measurement Frequency Range	Ant. H / V	U, (dB)
DG-CB03	CISPR	9kHz~30MHz	V	3.79
		9kHz~30MHz	H	3.57
		30MHz ~ 200MHz	V	3.82
		30MHz ~ 200MHz	H	3.60
		200MHz ~ 1,000MHz	V	3.86
		200MHz ~ 1,000MHz	H	3.94
		1GHz~18GHz	V	3.12
		1GHz~18GHz	H	3.68
		18GHz~40GHz	V	4.15
		18GHz~40GHz	H	4.14

Note: Unless specifically mentioned, the uncertainty of measurement has not been taken into account to declare the compliance or non-compliance to the specification.

3. GENERAL INFORMATION

3.1 GENERAL DESCRIPTION OF EUT

Equipment	AC1200 Dual-Band Wireless Access Point	
Brand Name	LUXUL	
Test Model	XAP-810	
Series Model	XWS-1810	
Model Difference	With two XAP-810 in gift box.	
Power Source	DC voltage supplied from AC/DC adapter. Brand / Model: LUXUL / XPE-2500	
Power Rating	Input: 100-240V~0.8A 50/60Hz Output: 51V --- 30W	
Product Description	Operation Frequency	UNII-1: 5150-5250MHz UNII-3: 5725-5850MHz
	Modulation Technology	OFDM
	Bit Rate of Transmitter	Up to 866Mbps
Output Power	Output Power (Max.)for UNII-1 (Non-Beamforming)	802.11a: 21.70dBm 802.11n (20M): 25.54dBm 802.11n (40M): 23.74dBm 802.11ac (20M): 25.00dBm 802.11ac (40M): 22.61dBm 802.11ac (80M): 17.76dBm
	Output Power (Max.)for UNII-1 (Beamforming)	802.11n (20M): 25.54dBm 802.11n (40M): 23.92dBm 802.11ac (20M): 25.00dBm 802.11ac (40M): 23.15dBm 802.11ac (80M): 17.76dBm
	Output Power (Max.)for UNII-3 (Non-Beamforming)	802.11a: 20.80dBm 802.11n (20M): 24.33dBm 802.11n (40M): 25.73dBm 802.11ac (20M): 24.03dBm 802.11ac (40M): 25.87dBm 802.11ac (80M): 25.96dBm
	Output Power (Max.)for UNII-3 (Beamforming)	802.11n (20M): 24.33dBm 802.11n (40M): 25.91dBm 802.11ac (20M): 24.03dBm 802.11ac (40M): 26.41dBm 802.11ac (80M): 25.96dBm

Note:

1. For a more detailed features description, please refer to the manufacturer's specifications or the user's manual.

2. Channel List:

UNII-1		UNII-1		UNII-1	
Channel	Frequency (MHz)	Channel	Frequency (MHz)	Channel	Frequency (MHz)
36	5180	38	5190	42	5210
40	5200	46	5230		
44	5220				
48	5240				

UNII-3		UNII-3		UNII-3	
Channel	Frequency (MHz)	Channel	Frequency (MHz)	Channel	Frequency (MHz)
149	5745	151	5755	155	5775
153	5765	159	5795		
157	5785				
161	5805				
165	5825				

3. Table for Filed Antenna:

Ant.	Brand	Model Name	Antenna Type	Connector	Gain (dBi)
1	N/A	N/A	Internal	N/A	3
2	N/A	N/A	Internal	N/A	3

Note:

- (1) The EUT incorporates a MIMO function. Physically, the EUT provides two completed transmitters and receivers (2T2R).
- (2) The EUT with beamforming function, then, Direction gain = $G_{ANT} + 10\log(N_{ANT}/N_{SS})$, where N_{SS} = the number of independent spatial streams of data.
For 2TX with beamforming: Directional gain = $3 + 10\log(2/2) = 3 + 0 = 3$ dBi.

4. The worst case for 1TX/ 2TX as follow:

Operating Mode	TX Mode	
	1TX	2TX
802.11a	V (ANT 1)	-
802.11n(20MHz)	-	V (ANT 1 + ANT 2)
802.11n(40MHz)	-	V (ANT 1 + ANT 2)
802.11ac(20MHz)	-	V (ANT 1 + ANT 2)
802.11ac(40MHz)	-	V (ANT 1 + ANT 2)
802.11ac(80MHz)	-	V (ANT 1 + ANT 2)

3.2 DESCRIPTION OF TEST MODES

To investigate the maximum EMI emission characteristics generates from EUT, the test system was pre-scanning tested base on the consideration of following EUT operation mode or test configuration mode which possible have effect on EMI emission level. Each of these EUT operation mode(s) or test configuration mode(s) mentioned above was evaluated respectively.

Pretest Mode	Description
Mode 1	TX A Mode / CH36, CH40, CH48 (UNII-1)
Mode 2	TX N20 Mode / CH36, CH40, CH48 (UNII-1)
Mode 3	TX N40 Mode / CH38, CH46 (UNII-1)
Mode 4	TX AC20 Mode / CH36, CH40, CH48 (UNII-1)
Mode 5	TX AC40 Mode / CH38, CH46 (UNII-1)
Mode 6	TX AC80 Mode / CH42 (UNII-1)
Mode 7	TX A Mode / CH149,CH157,CH165 (UNII-3)
Mode 8	TX N20 Mode / CH149,CH157,CH165 (UNII-3)
Mode 9	TX N40 Mode / CH151,CH159 (UNII-3)
Mode 10	TX AC20 Mode / CH149,CH157,CH165 (UNII-3)
Mode 11	TX AC40 Mode / CH151,CH159 (UNII-3)
Mode 12	TX AC80 Mode / CH155 (UNII-3)
Mode 13	TX Mode

The EUT system operated these modes were found to be the worst case during the pre-scanning test as following:

For Conducted Test	
Final Test Mode	Description
Mode 13	TX Mode

For Radiated Test	
Final Test Mode	Description
Mode 1	TX A Mode / CH36, CH40, CH48 (UNII-1)
Mode 2	TX N20 Mode / CH36, CH40, CH48 (UNII-1)
Mode 3	TX N40 Mode / CH38, CH46 (UNII-1)
Mode 4	TX AC20 Mode / CH36, CH40, CH48 (UNII-1)
Mode 5	TX AC40 Mode / CH38, CH46 (UNII-1)
Mode 6	TX AC80 Mode / CH42 (UNII-1)
Mode 7	TX A Mode / CH149,CH157,CH165 (UNII-3)
Mode 8	TX N20 Mode / CH149,CH157,CH165 (UNII-3)
Mode 9	TX N40 Mode / CH151,CH159 (UNII-3)
Mode 10	TX AC20 Mode / CH149,CH157,CH165 (UNII-3)
Mode 11	TX AC40 Mode / CH151,CH159 (UNII-3)
Mode 12	TX AC80 Mode / CH155 (UNII-3)

Note:

(1) For radiated below 1GHz test, the 802.11a mode is found to be the worst case and recorded.

3.3 TABLE OF PARAMETERS OF TEST SOFTWARE SETTING

During testing channel & power controlling software provided by the customer was used to control the operating channel as well as the output power level. The RF output power selection is for the setting of RF output power expected by the customer and is going to be fixed on the firmware of the final end product

UNII-1 - Non-Beamforming			
Test Software Version	MTOOL		
Frequency (MHz)	5180	5200	5240
A Mode	70	72	85
N20 Mode	67	72	87
Frequency (MHz)	5190	5230	
N40 Mode	56	78	

UNII-3 - Non-Beamforming			
Test Software Version	MTOOL		
Frequency (MHz)	5745	5785	5825
A Mode	72	72	80
N20 Mode	72	72	82
Frequency (MHz)	5755	5795	
N40 Mode	82	88	

UNII-1 - Non-Beamforming			
Test Software Version	MTOOL		
Frequency (MHz)	5180	5200	5240
AC20 Mode	66	72	85
Frequency (MHz)	5190	5230	
AC40 Mode	51	73	
Frequency (MHz)	5210		
AC80 Mode	53		

UNII-3 - Non-Beamforming			
Test Software Version	MTOOL		
Frequency (MHz)	5745	5785	5825
AC20 Mode	73	70	80
Frequency (MHz)	5755	5795	
AC40 Mode	82	88	
Frequency (MHz)	5775		
AC80 Mode	88		

UNII-1 - Beamforming			
Test Software Version	MTOOL		
Frequency (MHz)	5180	5200	5240
N20 Mode	67	72	87
Frequency (MHz)	5190	5230	
N40 Mode	56	78	

UNII-3 - Beamforming			
Test Software Version	MTOOL		
Frequency (MHz)	5745	5785	5825
N20 Mode	72	72	82
Frequency (MHz)	5755	5795	
N40 Mode	82	88	

UNII-1 - Beamforming			
Test Software Version	MTOOL		
Frequency (MHz)	5180	5200	5240
AC20 Mode	66	72	85
Frequency (MHz)	5190	5230	
AC40 Mode	51	73	
Frequency (MHz)	5210		
AC80 Mode	53		

UNII-3 - Beamforming			
Test Software Version	MTOOL		
Frequency (MHz)	5745	5785	5825
AC20 Mode	73	70	80
Frequency (MHz)	5755	5795	
AC40 Mode	82	88	
Frequency (MHz)	5775		
AC80 Mode	88		

3.4 BLOCK DIAGRAM SHOWING THE CONFIGURATION OF SYSTEM TESTED

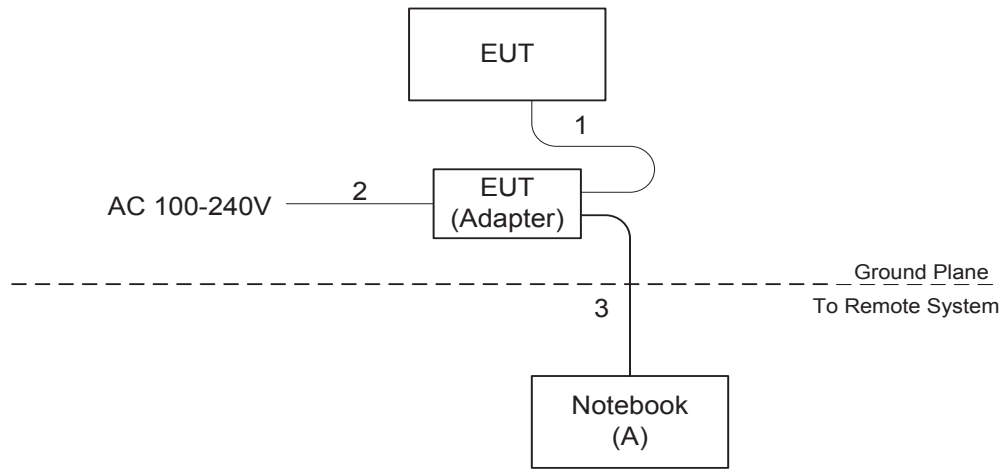

3.5 DESCRIPTION OF SUPPORT UNITS

The EUT has been tested as an independent unit together with other necessary accessories or support units. The following support units or accessories were used to form a representative test configuration during the tests.

Item	Equipment	Mfr/Brand	Model/Type No.	FCC ID	Series No.
A	Notebook	HP	HP NB 331	DOC	NA

Item	Shielded Type	Ferrite Core	Length	Note
1	NO	NO	1.5m	RJ45
2	NO	NO	1.8m	AC Cable
3	NO	NO	10m	RJ45

4. EMC EMISSION TEST

4.1 CONDUCTED EMISSION MEASUREMENT

4.1.1 POWER LINE CONDUCTED EMISSION (Frequency Range 150kHz-30MHz)

FREQUENCY (MHz)	Class A (dBuV)		Class B (dBuV)	
	Quasi-peak	Average	Quasi-peak	Average
0.15 -0.5	79.00	66.00	66 - 56 *	56 - 46 *
0.50 -5.0	73.00	60.00	56.00	46.00
5.0 -30.0	73.00	60.00	60.00	50.00

Note:

- (1) The tighter limit applies at the band edges.
- (2) The limit of " * " marked band means the limitation decreases linearly with the logarithm of the frequency in the range.

4.1.2 TEST PROCEDURE

- a. The EUT was placed 0.8 meters from the horizontal ground plane with EUT being connected to the power mains through a line impedance stabilization network (LISN). All other support equipment powered from additional LISN(s). The LISN provide 50 Ohm/ 50uH of coupling impedance for the measuring instrument.
- b. Interconnecting cables that hang closer than 40 cm to the ground plane shall be folded back and forth in the center forming a bundle 30 to 40 cm long.
- c. I/O cables that are not connected to a peripheral shall be bundled in the center. The end of the cable may be terminated, if required, using the correct terminating impedance. The overall length shall not exceed 1 m.
- d. LISN at least 80 cm from nearest part of EUT chassis.
- e. For the actual test configuration, please refer to the related Item –EUT Test Photos.

4.1.3 DEVIATION FROM TEST STANDARD

No deviation

4.1.4 TEST SETUP

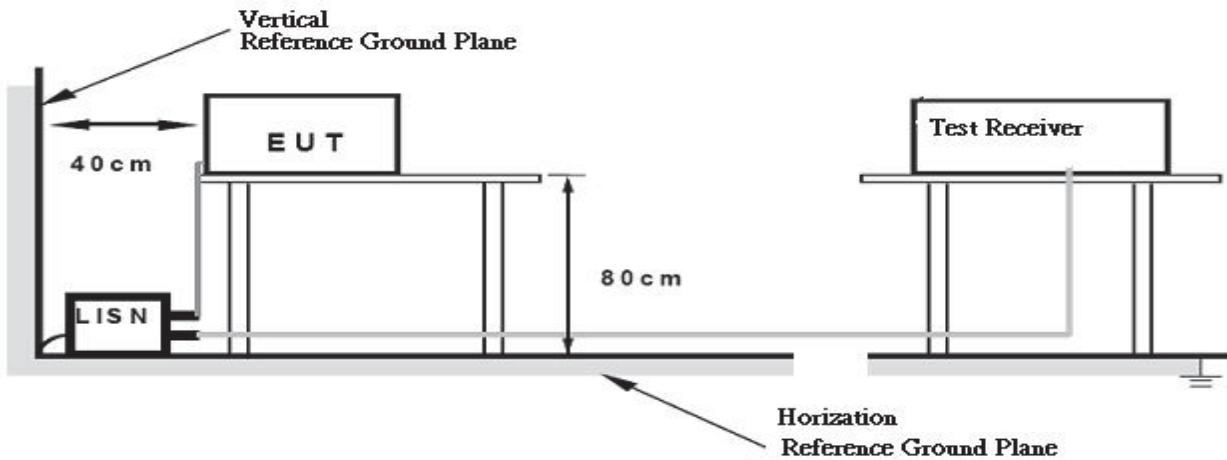

4.1.5 EUT OPERATING CONDITIONS

The EUT was configured for testing in a typical fashion (as a customer would normally use it). The EUT has been programmed to continuously transmit during test. This operating condition was tested and used to collect the included data.

The EUT was programmed to be in continuously transmitting/TX Mode mode.

4.1.6 EUT TEST CONDITIONS

Temperature: 25°C Relative Humidity: 53% Test Voltage: AC 120V/60Hz

4.1.7 TEST RESULTS

Please refer to the Attachment A.

Remark:

- (1) All readings are QP Mode value unless otherwise stated AVG in column of『Note』. If the QP Mode Measured value compliance with the QP Limits and lower than AVG Limits, the EUT shall be deemed to meet both QP & AVG Limits and then only QP Mode was measured, but AVG Mode didn't perform. In this case, a " * " marked in AVG Mode column of Interference Voltage Measured.
- (2) Measuring frequency range from 150kHz to 30MHz.

4.2 RADIATED EMISSION MEASUREMENT

4.2.1 RADIATED EMISSION LIMITS

In case the emission fall within the restricted band specified on 15.205(a), then the 15.209(a) limit in the table below has to be followed.

Frequencies (MHz)	Field Strength (micorvolts/meter)	Measurement Distance (meters)
0.009~0.490	2400/F(kHz)	300
0.490~1.705	24000/F(kHz)	30
1.705~30.0	30	30
30~88	100	3
88~216	150	3
216~960	200	3
Above 960	500	3

Frequencies (MHz)	EIRP Limit (dBm)	Equivalent Field Strength at 3m (dBμV/m)
5150-5250	-27	68.3
5250-5350	-27	68.3
5470-5725	-27	68.3
5725-5850	-27(Note 2)	68.3
	10(Note 2)	105.3
	15.6(Note 2)	110.9
	27(Note 2)	122.3

Note:

1. The following formula is used to convert the equipment isotropic radiated power (eirp) to

field strength: $E = \frac{1000000\sqrt{30P}}{3} \mu\text{V/m}$, where P is the eirp (Watts)

2. According to FCC 16-24, All emissions shall be limited to a level of -27 dBm/MHz at 75 MHz or more above or below the band edge increasing linearly to 10 dBm/MHz at 25 MHz above or below the band edge, and from 25MHz above or below the band edge increasing linearly to a level of 15.6 dBm/MHz at 5 MHz above or below the band edge, and from 5 MHz above or below the band edge increasing linearly to a level of 27dBm/MHz at the band edge.

4.2.2 TEST PROCEDURE

- a. The measuring distance of 3 m shall be used for measurements. The EUT was placed on the top of a rotating table 0.8 meter above the ground at a 3 meter semi-anechoic chamber. The table was rotated 360 degrees to determine the position of the highest radiation.(below 1GHz)
- b. The measuring distance of 3 m shall be used for measurements. The EUT was placed on the top of a rotating table 1.5 meter above the ground at a 3 meter semi-anechoic chamber. The table was rotated 360 degrees to determine the position of the highest radiation.(above 1GHz)
- c. The height of the equipment or of the substitution antenna shall be 0.8m or 1.5m; the height of the test antenna shall vary between 1 m to 4 m. Both horizontal and vertical polarizations of the antenna are set to make the measurement.
- d. For each suspected emission, the EUT was arranged to its worst case and then the antenna was tuned to heights find the maximum reading (used Bore sight function).
- e. The receiver system was set to peak and average detect function and specified bandwidth with maximum hold mode when the test frequency is above 1GHz.
- f. The initial step in collecting radiated emission data is a receiver peak detector mode pre-scanning the measurement frequency range. Significant peaks are then marked and then Quasi Peak detector mode re-measured.
- g. All readings are Peak unless otherwise stated QP in column of Note. Peak denotes that the Peak reading compliance with the QP Limits and then QP Mode measurement didn't perform. (below 1GHz)
- h. All readings are Peak Mode value unless otherwise stated AVG in column of Note. If the Peak Mode Measured value compliance with the Peak Limits and lower than AVG Limits, the EUT shall be deemed to meet both Peak & AVG Limits and then only Peak Mode was measured, but AVG Mode didn't perform. (above 1GHz)
- i. For the actual test configuration, please refer to the related Item –EUT Test Photos.

4.2.3 DEVIATION FROM TEST STANDARD

No deviation

4.2.4 TEST SETUP

(A) Radiated Emission Test Set-Up Frequency Below 1GHz

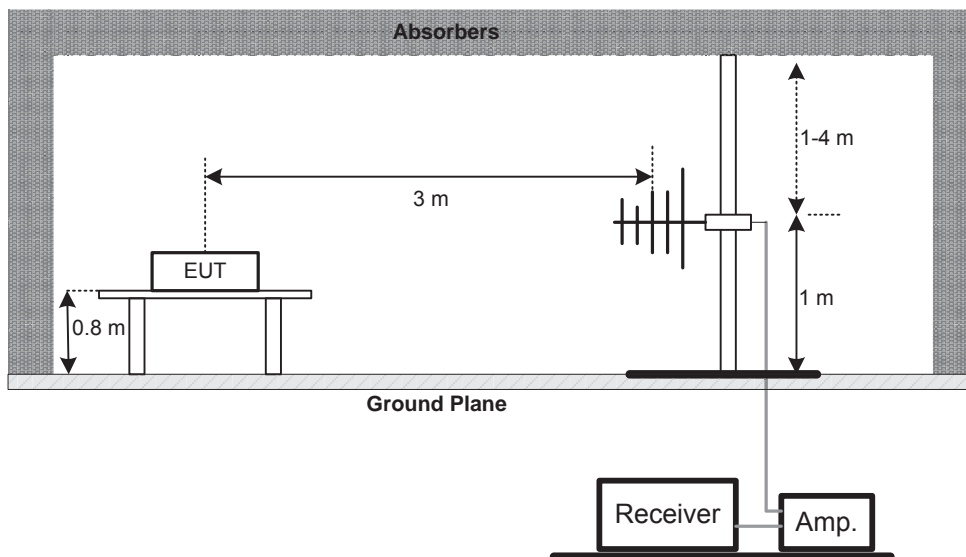

(B) Radiated Emission Test Set-Up Frequency Above 1 GHz

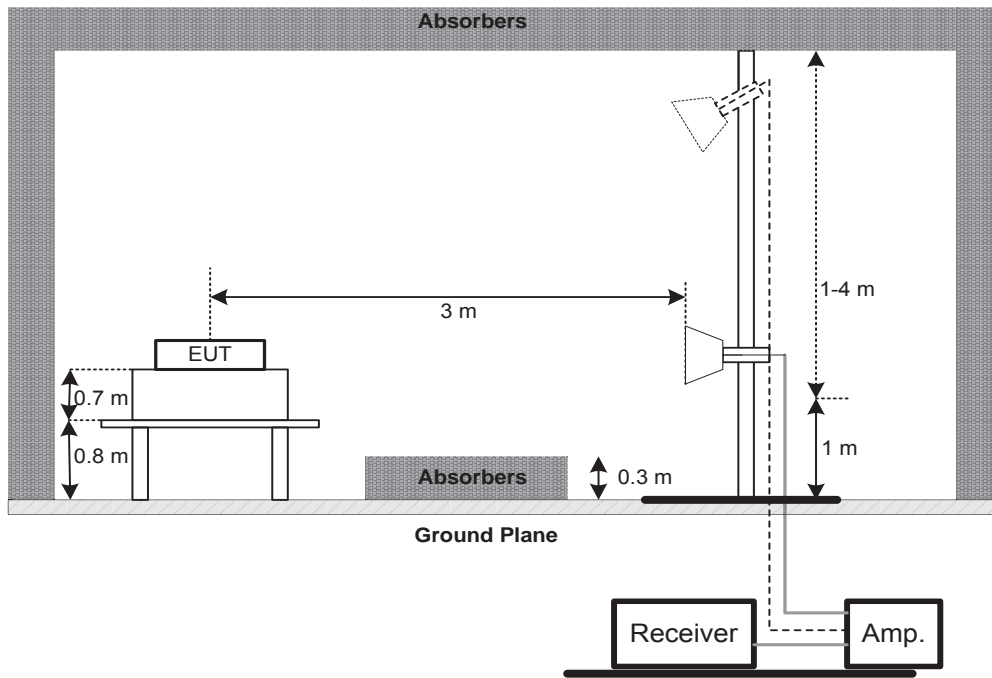

(C) Radiated emissions below 30MHz

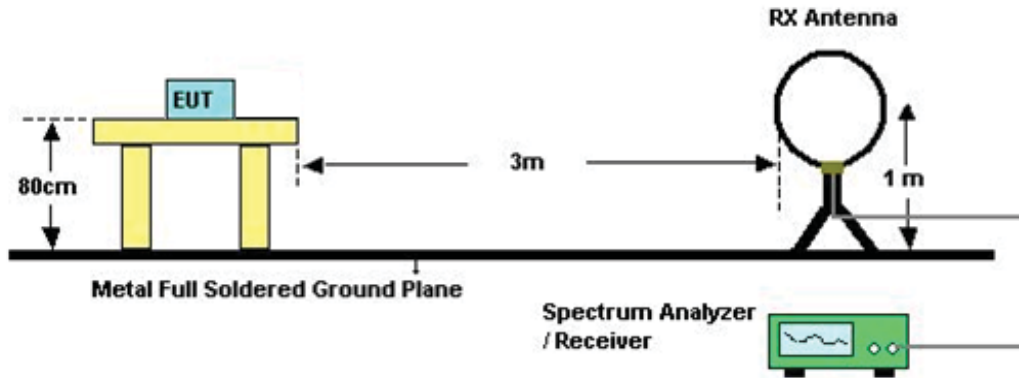

4.2.5 EUT OPERATING CONDITIONS

The EUT tested system was configured as the statements of 4.1.5 unless otherwise a special operating condition is specified in the follows during the testing.

4.2.6 EUT TEST CONDITIONS

Temperature: 25°C Relative Humidity: 60% Test Voltage: AC 120V/60Hz

4.2.7 TEST RESULTS (9K TO 30MHz)

Please refer to the Attachment B

Remark:

- (1) The amplitude of spurious emissions which are attenuated by more than 20 dB below the permissible value has no need to be reported.
- (2) Distance extrapolation factor = $40 \log (\text{specific distance} / \text{test distance})$ (dB);
- (3) Limit line = specific limits (dBuV) + distance extrapolation factor.

4.2.8 TEST RESULTS (30 TO 1000 MHz)

Please refer to the Attachment C.

4.2.9 TEST RESULTS (ABOVE 1000 MHz)

Please refer to the Attachment D.

Remark:

- (1) No limit: This is fundamental signal, the judgment is not applicable.
For fundamental signal judgment was referred to Peak output test.

5. 26dB SPECTRUM BANDWIDTH

5.1 APPLIED PROCEDURES / LIMIT

FCC Part15, Subpart E			
Test Item	Limit	Frequency Range (MHz)	Result
Bandwidth	26 dB Bandwidth	5150-5250	PASS
	Minimum 500kHz 6dB Bandwidth	5725-5850	PASS

5.1.1 TEST PROCEDURE

a. The EUT was directly connected to the spectrum analyzer and antenna output port as show in the block diagram below,

b.

Spectrum Parameters	Setting
Attenuation	Auto
Span Frequency	> 26dB Bandwidth
RBW	300 kHz(Bandwidth 20MHz) 1MHz(Bandwidth 40MHz and 80MHz)
VBW	1MHz(Bandwidth 20MHz) 3MHz(Bandwidth 40MHz and 80MHz)
Detector	Peak
Trace	Max Hold
Sweep Time	Auto

c. Measured the spectrum width with power higher than 26dB below carrier

5.1.2 DEVIATION FROM STANDARD

No deviation.

5.1.3 TEST SETUP



5.1.4 EUT OPERATION CONDITIONS

The EUT tested system was configured as the statements of 4.1.5 unless otherwise a special operating condition is specified in the follows during the testing.

5.1.5 EUT TEST CONDITIONS

Temperature: 25°C Relative Humidity: 60% Test Voltage: AC 120V/60Hz

5.1.6 TEST RESULTS

Please refer to the Attachment E.

6. MAXIMUM CONDUCTED OUTPUT POWER

6.1 APPLIED PROCEDURES / LIMIT

FCC Part15, Subpart E			
Test Item	Limit	Frequency Range (MHz)	Result
Conducted Output Power	Fixed:1 Watt (30dBm) Mobile and portable: 250mW (24dBm)	5150-5250	PASS
	1 Watt (30dBm)	5725-5850	PASS
Note: The maximum e.i.r.p at any elevation angle above 30 degrees as measured from the horizon must not exceed 125mW(21dBm)			

6.1.1 TEST PROCEDURE

- a. The EUT was directly connected to the power meter and antenna output port as show in the block diagram below,
- b.

Spectrum Parameter	Setting
Attenuation	Auto
Span Frequency	Encompass the entire emissions bandwidth (EBW) of the signal
RBW	= 1MHz.
VBW	\geq 3MHz.
Detector	RMS
Trace	Max Hold
Sweep Time	auto

- c. Test was performed in accordance with method of KDB 789033 D02.

6.1.2 DEVIATION FROM STANDARD

No deviation.

6.1.3 TEST SETUP



6.1.4 EUT OPERATION CONDITIONS

The EUT tested system was configured as the statements of 4.1.5 unless otherwise a special operating condition is specified in the follows during the testing.

6.1.5 EUT TEST CONDITIONS

Temperature: 25°C Relative Humidity: 60% Test Voltage: AC 120V/60Hz

6.1.6 TEST RESULTS

Please refer to the Attachment F.

7. POWER SPECTRAL DENSITY TEST

7.1 APPLIED PROCEDURES / LIMIT

FCC Part15, Subpart E			
Test Item	Limit	Frequency Range (MHz)	Result
Power Spectral Density	Other then Mobile and portable:17dBm/MHz Mobile and portable:11dBm/MHz	5150-5250	PASS
	30dBm/500kHz	5725-5850	PASS

8.1.1 TEST PROCEDURE

a. The EUT was directly connected to the spectrum analyzer and antenna output port as show in the block diagram below,

b.

Spectrum Parameter	Setting
Attenuation	Auto
Span Frequency	Encompass the entire emissions bandwidth (EBW) of the signal
RBW	= 1MHz.
VBW	≥ 3MHz.
Detector	RMS
Trace average	100 trace
Sweep Time	Auto

Note:

- For UNII-3, according to KDB publication 789033 D02 General UNII Test Procedures New Rules v01r02, section II.F.5., it is acceptable to set RBW at 1MHz and VBW at 3MHz if the spectrum analyzer does not have 500kHz RBW.
- The value measured with RBW=1MHz is to be added with $10\log(500\text{kHz}/1\text{MHz})$ which is -3dB. For example, if the measured value is +10dBm using RBW=1MHz (that is +10dBm/MHz), then the converted value will be +7dBm/500kHz.

7.1.1 DEVIATION FROM STANDARD

No deviation.

7.1.2 TEST SETUP

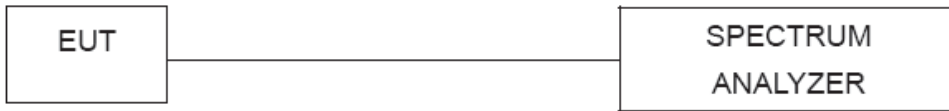

7.1.3 EUT OPERATION CONDITIONS

The EUT tested system was configured as the statements of 4.1.5 unless otherwise a special operating condition is specified in the follows during the testing.

7.1.4 EUT TEST CONDITIONS

Temperature: 25°C Relative Humidity: 60% Test Voltage: AC 120V/60Hz

7.1.5 TEST RESULTS

Please refer to the Attachment H.

8. FREQUENCY STABILITY MEASUREMENT

8.1 APPLIED PROCEDURES / LIMIT

FCC Part15, Subpart E			
Test Item	Limit	Frequency Range (MHz)	Result
Frequency Stability	Specified in the user's manual	5150-5250	PASS
		5725-5850	PASS

8.1.1 TEST PROCEDURE

a. The EUT was directly connected to the spectrum analyzer and antenna output port as show in the block diagram below,

b.

Spectrum Parameter	Setting
Attenuation	Auto
Span Frequency	Entire absence of modulation emissions bandwidth
RBW	10 kHz
VBW	10 kHz
Sweep Time	Auto

c. The test extreme voltage is to change the primary supply voltage from 85 to 115 percent of the nominal value.

d. User manual temperature is 0°C~40°C.

8.1.2 DEVIATION FROM STANDARD

No deviation.

8.1.3 TEST SETUP

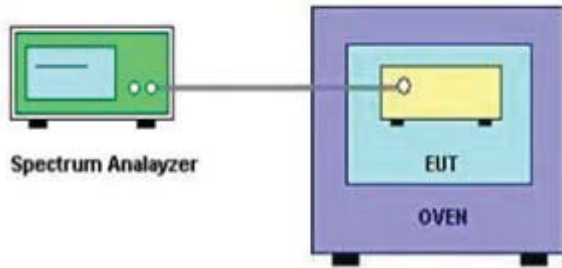

8.1.4 EUT OPERATION CONDITIONS

The EUT tested system was configured as the statements of 4.1.5 unless otherwise a special operating condition is specified in the follows during the testing.

8.1.5 EUT TEST CONDITIONS

Temperature: 25°C Relative Humidity: 55% Test Voltage: AC 120V/60Hz

8.1.6 TEST RESULTS

Please refer to the Attachment I.

9. MEASUREMENT INSTRUMENTS LIST

Conducted Emission Measurement					
Item	Kind of Equipment	Manufacturer	Type No.	Serial No.	Calibrated until
1	EMI Test Receiver	R&S	ESCI	100382	Mar. 26, 2018
2	LISN	EMCO	3816/2	52765	Mar. 26, 2018
3	50Ω Terminator	SHX	TF2-3G-A	8122901	Mar. 26, 2018
4	TWO-LINE V-NETWORK	R&S	ENV216	101447	Mar. 26, 2018
5	Measurement Software	Farad	EZ-EMC Ver.NB-03A1-01	N/A	N/A
6	Cable	N/A	RG223	12m	Oct. 20, 2017

Radiated Emission Measurement - Below 1GHz					
Item	Kind of Equipment	Manufacturer	Type No.	Serial No.	Calibrated until
1	Antenna	Schwarbeck	VULB9160	9160-3232	Mar. 26, 2018
2	Amplifier	HP	8447D	2944A09673	Oct. 20, 2017
3	Receiver	Agilent	N9038A	MY52130039	Sep. 04, 2017
4	Cable	emci	LMR-400(30MHz-1 GHz)(8m+5m)	N/A	Jun. 26, 2018
5	Controller	CT	SC100	N/A	N/A
6	Controller	MF	MF-7802	MF780208416	N/A
7	Measurement Software	Farad	EZ-EMC Ver.NB-03A1-01	N/A	N/A
8	Active Loop Antenna	R&S	HFH2-Z2	830749/020	Sep. 06, 2017

Radiated Emission Measurement - Above 1GHz

Item	Kind of Equipment	Manufacturer	Type No.	Serial No.	Calibrated until
1	Double Ridged Guide Antenna	ETS	3115	75789	Mar. 26, 2018
2	Broad-Band Horn Antenna	Schwarzbeck	BBHA 9170	9170319	Jun. 08, 2018
3	Amplifier	Agilent	8449B	3008A02274	May. 16, 2018
4	Microwave Preamplifier With Adaptor	EMC INSTRUMENT	EMC2654045	980039 & HA01	Mar. 26, 2018
5	Receiver	Agilent	N9038A	MY52130039	Sep. 04, 2017
6	Antenna	EM	EM-6876-1	230	Jul. 07, 2018
7	Controller	CT	SC100	N/A	N/A
8	Controller	MF	MF-7802	MF780208416	N/A
9	Cable	emci	EMC104-SM-SM-1 2000(12m)	N/A	Jun. 26, 2018
10	Measurement Software	Farad	EZ-EMC Ver.NB-03A1-01	N/A	N/A

Spectrum Bandwidth Measurement

Item	Kind of Equipment	Manufacturer	Type No.	Serial No.	Calibrated until
1	Spectrum Analyzer	R&S	FSP40	100185	Sep. 04, 2017

Maximum Conducted Output Power Measurement

Item	Kind of Equipment	Manufacturer	Type No.	Serial No.	Calibrated until
1	Power Meter	ANRITSU	ML2495A	1128009	Mar. 26, 2018
2	Pulse Power Sensor	ANRITSU	MA 2411B	1027500	Mar. 26, 2018

Power Spectral Density Measurement

Item	Kind of Equipment	Manufacturer	Type No.	Serial No.	Calibrated until
1	Spectrum Analyzer	R&S	FSP40	100185	Sep. 04, 2017

Frequency Stability Measurement

Item	Kind of Equipment	Manufacturer	Type No.	Serial No.	Calibrated until
1	Spectrum Analyzer	R&S	FSP40	100185	Sep. 04, 2017
2	Precision Oven Tester	Bell	BTH-50C	20170306001	Mar. 26, 2018

Remark: "N/A" denotes no model name, serial no. or calibration specified.
All calibration period of equipment list is one year.

10. EUT TEST PHOTOS

Conducted Measurement Photos



Radiated Measurement Photos

9kHz to 30MHz

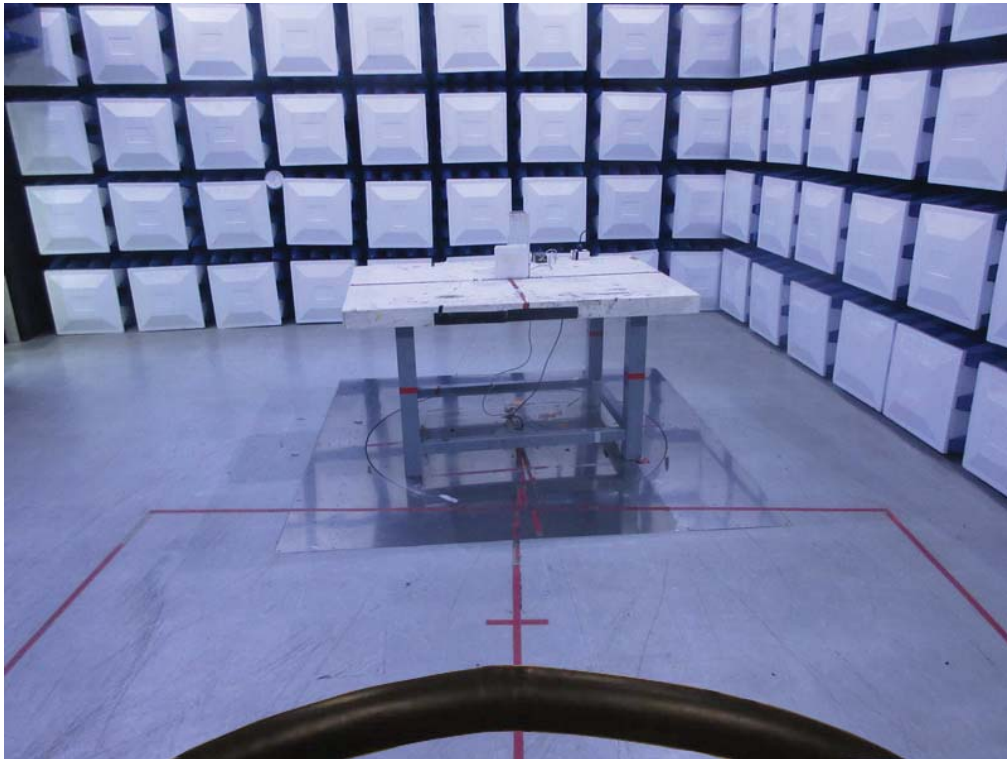

Radiated Measurement Photos

30MHz to 1000MHz

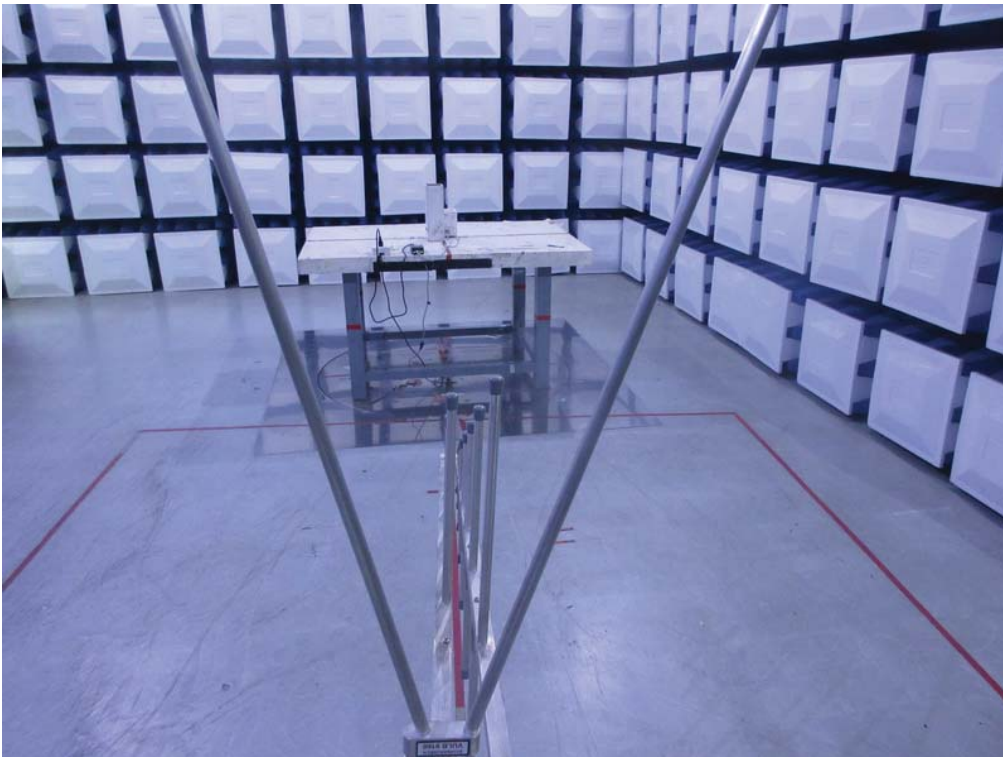

Radiated Measurement Photos

Above 1000MHz



ATTACHMENT A - CONDUCTED EMISSION

Test Mode: TX MODE

Line

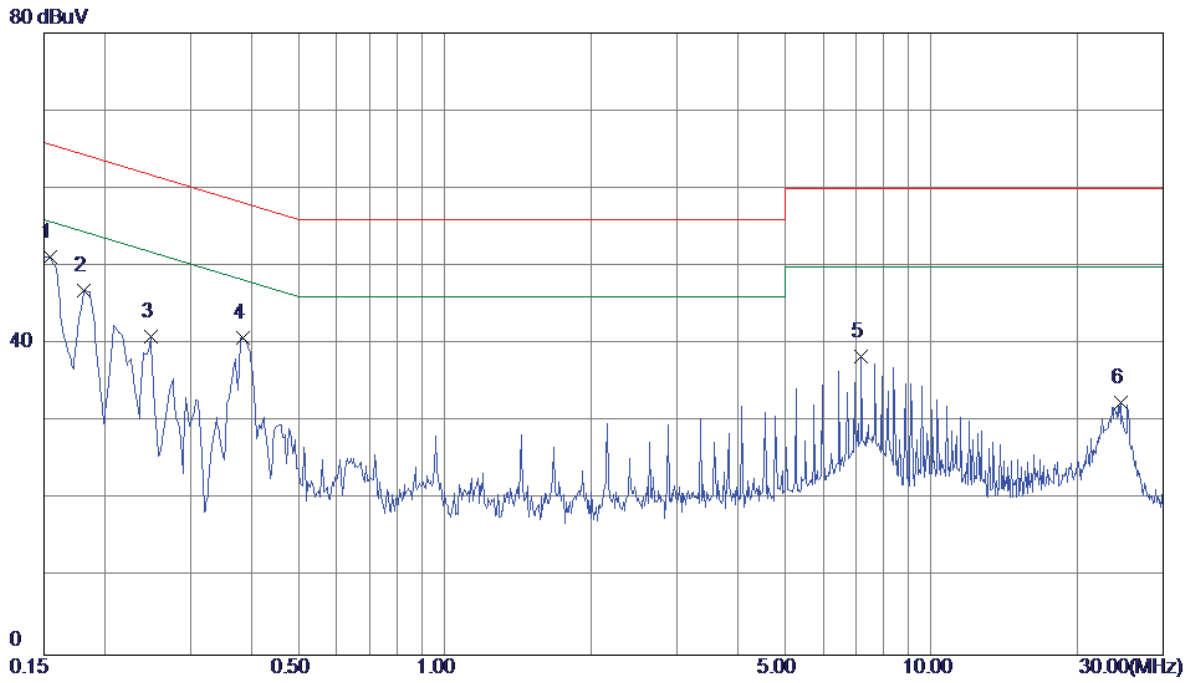

No.	Freq. MHz	Reading Level dBuV	Correct Factor dB	Measurement dBuV	Limit dBuV	Margin dB	Detector	Comment
1 *	0.1545	41.46	9.79	51.25	65.75	-14.50	Peak	
2	0.1815	37.13	9.77	46.90	64.42	-17.52	Peak	
3	0.2490	31.19	9.76	40.95	61.79	-20.84	Peak	
4	0.3840	30.98	9.79	40.77	58.19	-17.42	Peak	
5	7.1880	28.14	10.20	38.34	60.00	-21.66	Peak	
6	24.5264	21.67	10.78	32.45	60.00	-27.55	Peak	

Note: The test result has included the cable loss.

Test Mode: TX MODE

Neutral

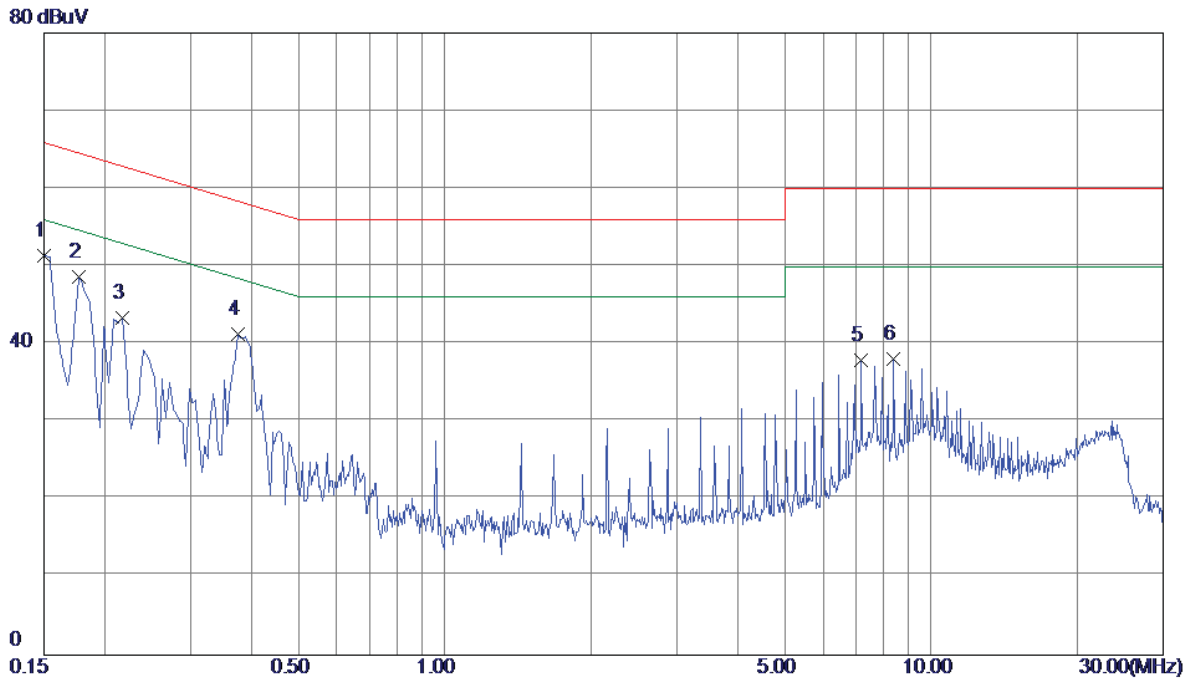

No.	Freq. MHz	Reading Level dBuV	Correct Factor dB	Measure ment dBuV	Limit dBuV	Margin dB	Detector	Comment
1 *	0.1500	41.70	9.68	51.38	66.00	-14.62	Peak	
2	0.1770	39.03	9.68	48.71	64.63	-15.92	Peak	
3	0.2175	33.71	9.68	43.39	62.91	-19.52	Peak	
4	0.3750	31.57	9.69	41.26	58.39	-17.13	Peak	
5	7.1880	27.87	10.12	37.99	60.00	-22.01	Peak	
6	8.3850	27.97	10.18	38.15	60.00	-21.85	Peak	

Note: The test result has included the cable loss.

ATTACHMENT B - RADIATED EMISSION (9KHZ TO 30MHZ)

Test Mode: TX MODE

Ant 0°

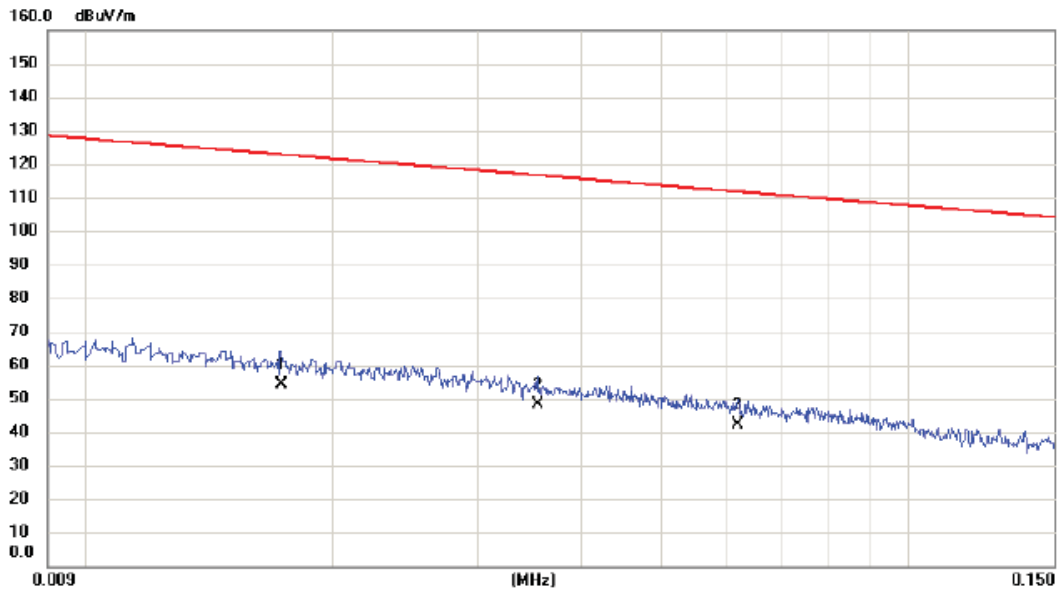

No.	Mk.	Freq. MHz	Reading Level dBuV	Correct Factor dB	Measure- ment dBuV/m	Limit dBuV/m	Margin dB	Detector	Comment
1		0.0173	34.15	19.97	54.12	122.84	-68.72	AVG	
2	*	0.0354	28.94	19.16	48.10	116.62	-68.52	AVG	
3		0.0620	23.67	18.49	42.16	111.76	-69.60	AVG	

Test Mode: TX MODE

Ant 0°

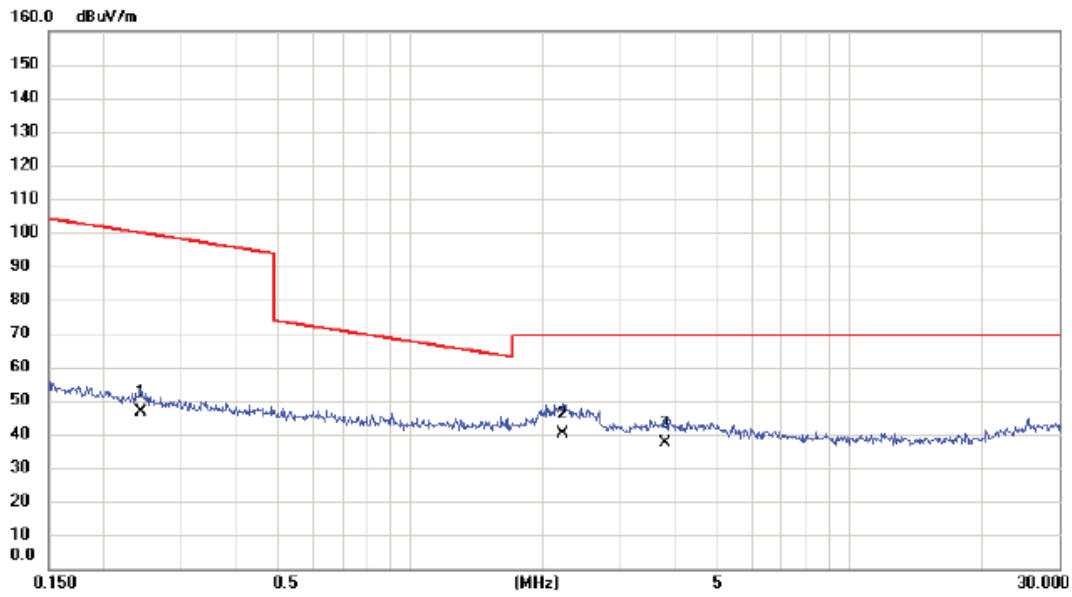

No.	Mk.	Freq. MHz	Reading Level dBuV	Correct Factor dB	Measure- ment dBuV/m	Limit dBuV/m	Margin dB	Detector	Comment
1		0.2442	29.86	16.68	46.54	99.85	-53.31	AVG	
2	*	2.2250	24.76	15.44	40.20	69.54	-29.34	QP	
3		3.7994	22.44	15.01	37.45	69.54	-32.09	QP	

Test Mode: TX MODE

Ant 90°

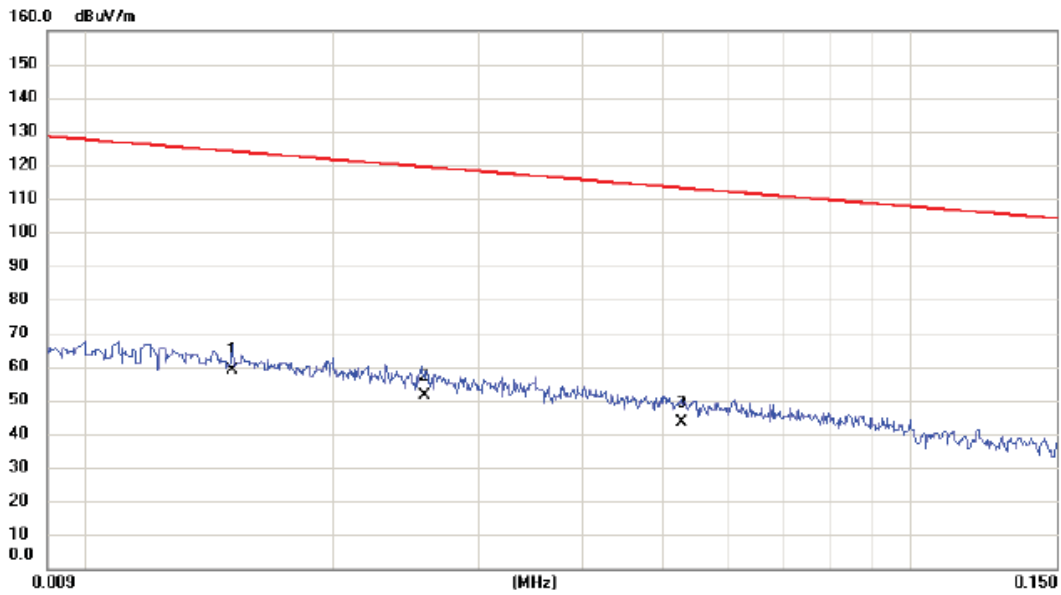

No.	Mk.	Freq. MHz	Reading Level dBuV	Correct Factor dB	Measure- ment dBuV/m	Limit dBuV/m	Margin dB	Detector	Comment
1	*	0.0151	38.64	20.26	58.90	124.03	-65.13	AVG	
2		0.0258	31.94	19.45	51.39	119.37	-67.98	AVG	
3		0.0528	24.63	18.66	43.29	113.15	-69.86	AVG	

Test Mode: TX MODE

Ant 90°

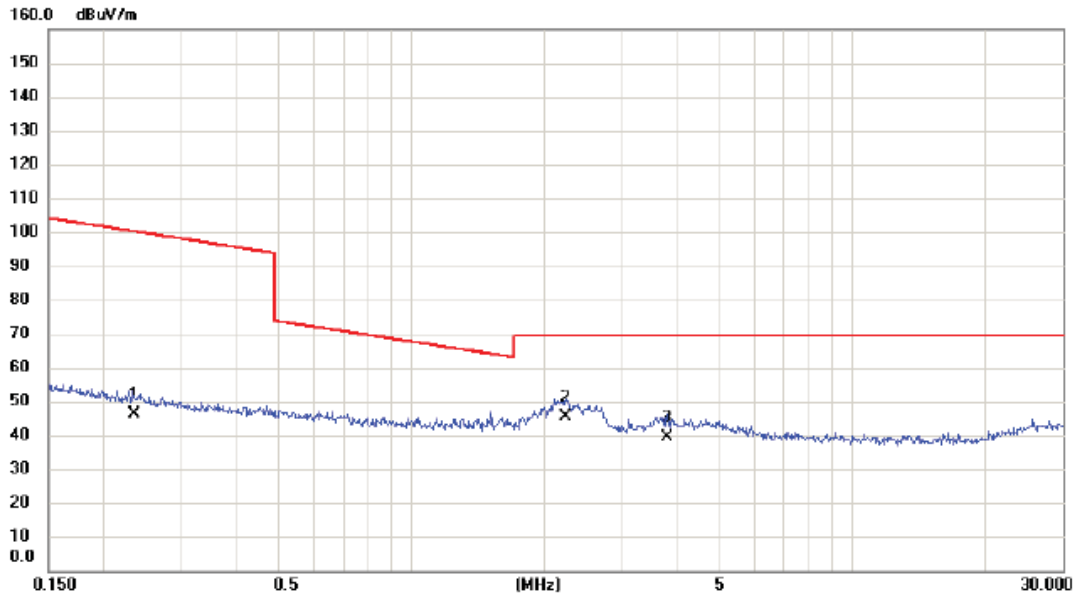

No.	Mk.	Freq. MHz	Reading Level dBuV	Correct Factor dB	Measure- ment dBuV/m	Limit dBuV/m	Margin dB	Detector	Comment
1		0.2341	29.46	16.70	46.16	100.22	-54.06	AVG	
2	*	2.2367	29.86	15.44	45.30	69.54	-24.24	QP	
3		3.7994	24.57	15.01	39.58	69.54	-29.96	QP	

ATTACHMENT C - RADIATED EMISSION (30MHZ TO 1000MHZ)

Test Mode: UNII-1/TX A Mode 5180MHz

Vertical

80 dBuV/m

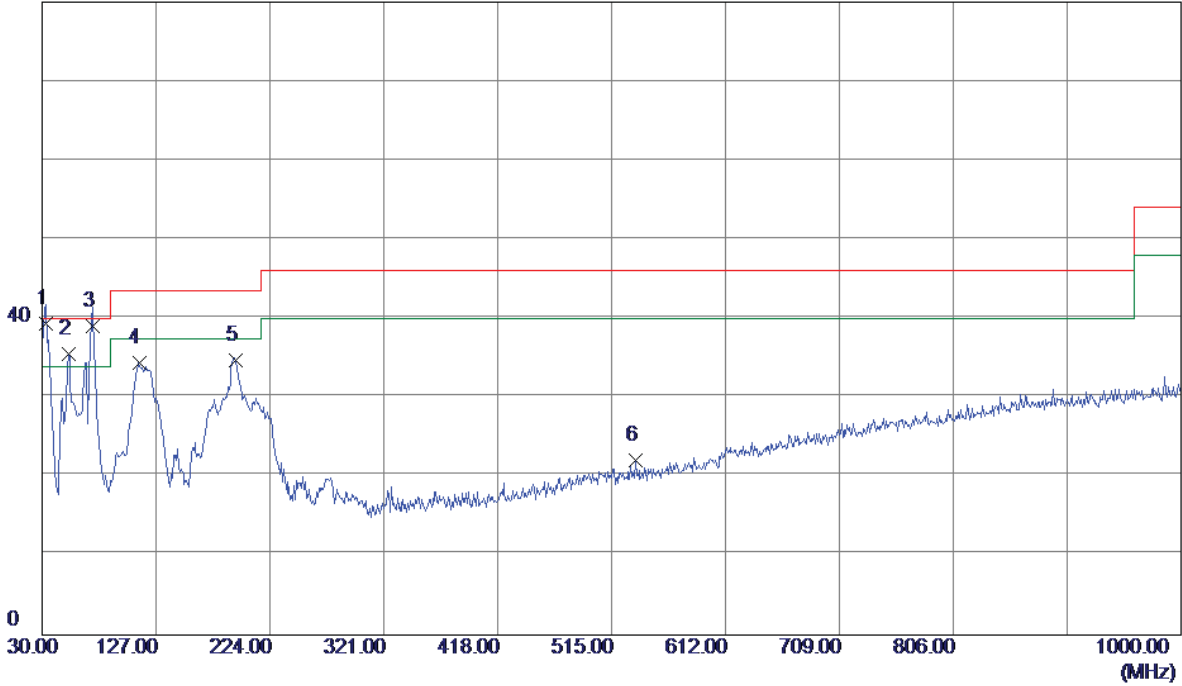

No.	Freq. MHz	Reading Level dBuV/m	Correct Factor dB	Measure ment dBuV/m	Limit dBuV/m	Margin dB	Detector	Comment
1 *	32.9100	54.22	-14.89	39.33	40.00	-0.67	QP	
2	52.3100	49.28	-13.79	35.49	40.00	-4.51	Peak	
3	72.6800	55.90	-16.82	39.08	40.00	-0.92	QP	
4	112.4500	50.41	-16.00	34.41	43.50	-9.09	Peak	
5	194.9000	47.99	-13.29	34.70	43.50	-8.80	Peak	
6	535.3700	30.06	-8.01	22.05	46.00	-23.95	Peak	

Test Mode: UNII-1/TX A Mode 5180MHz

Horizontal

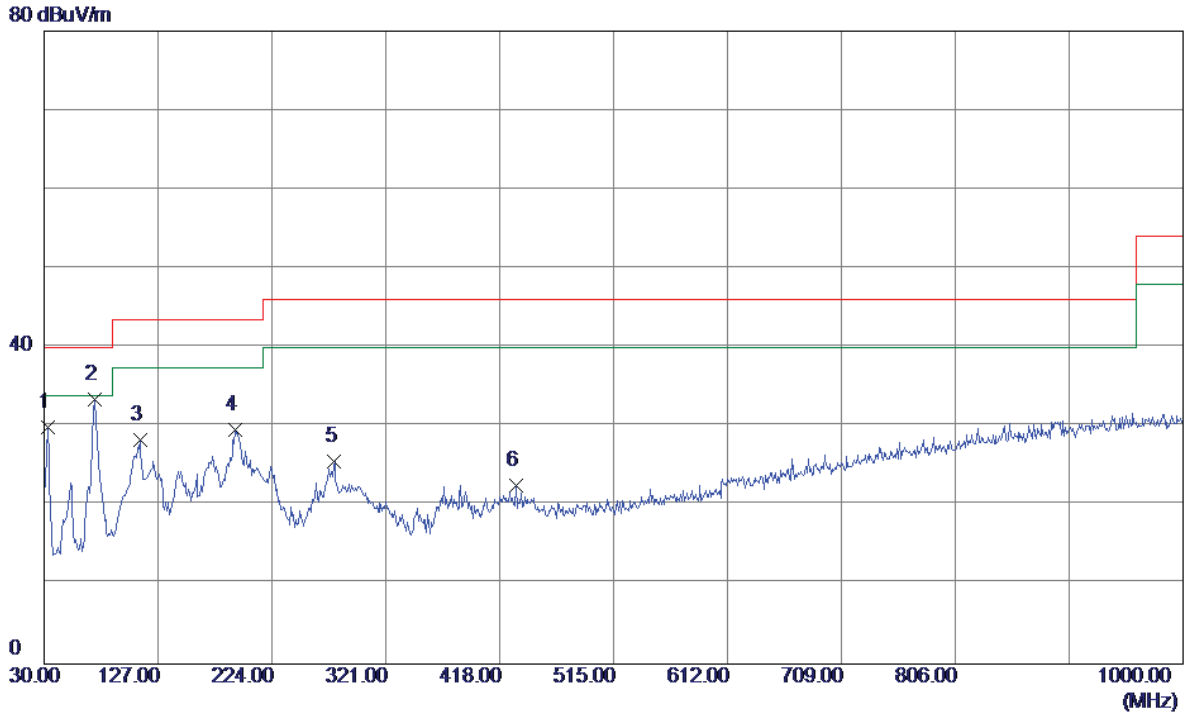

No.	Freq. MHz	Reading Level dBuV/m	Correct Factor dB	Measure ment dBuV/m	Limit dBuV/m	Margin dB	Detector	Comment
1	32.9100	44.83	-14.89	29.94	40.00	-10.06	Peak	
2 *	72.6800	50.31	-16.82	33.49	40.00	-6.51	Peak	
3	111.4800	44.32	-16.07	28.25	43.50	-15.25	Peak	
4	192.9600	42.64	-13.11	29.53	43.50	-13.97	Peak	
5	277.3500	40.67	-15.06	25.61	46.00	-20.39	Peak	
6	431.5800	33.00	-10.46	22.54	46.00	-23.46	Peak	

Test Mode: UNII-1/TX A Mode 5200MHz

Vertical

80 dBuV/m

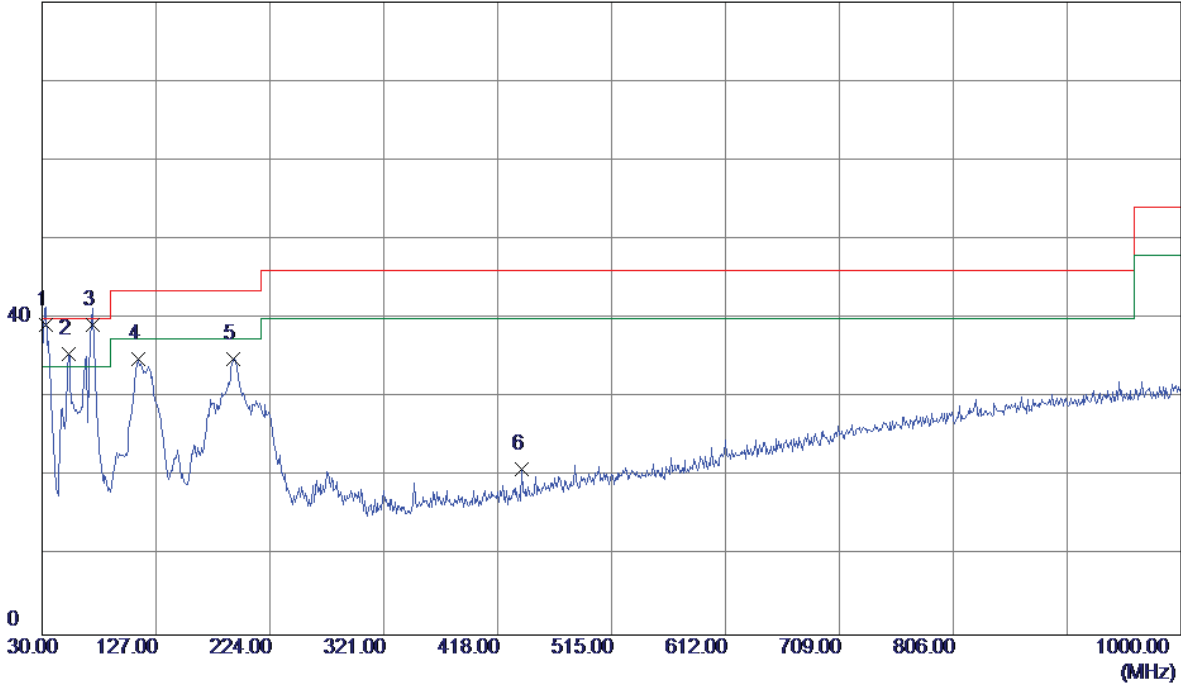

No.	Freq. MHz	Reading Level dBuV/m	Correct Factor dB	Measure ment dBuV/m	Limit dBuV/m	Margin dB	Detector	Comment
1 *	32.9100	54.16	-14.89	39.27	40.00	-0.73	QP	
2	52.3100	49.28	-13.79	35.49	40.00	-4.51	Peak	
3	72.6800	56.04	-16.82	39.22	40.00	-0.78	QP	
4	111.4800	50.88	-16.07	34.81	43.50	-8.69	Peak	
5	192.9600	47.98	-13.11	34.87	43.50	-8.63	Peak	
6	438.3700	31.20	-10.27	20.93	46.00	-25.07	Peak	

Test Mode: UNII-1/TX A Mode 5200MHz

Horizontal

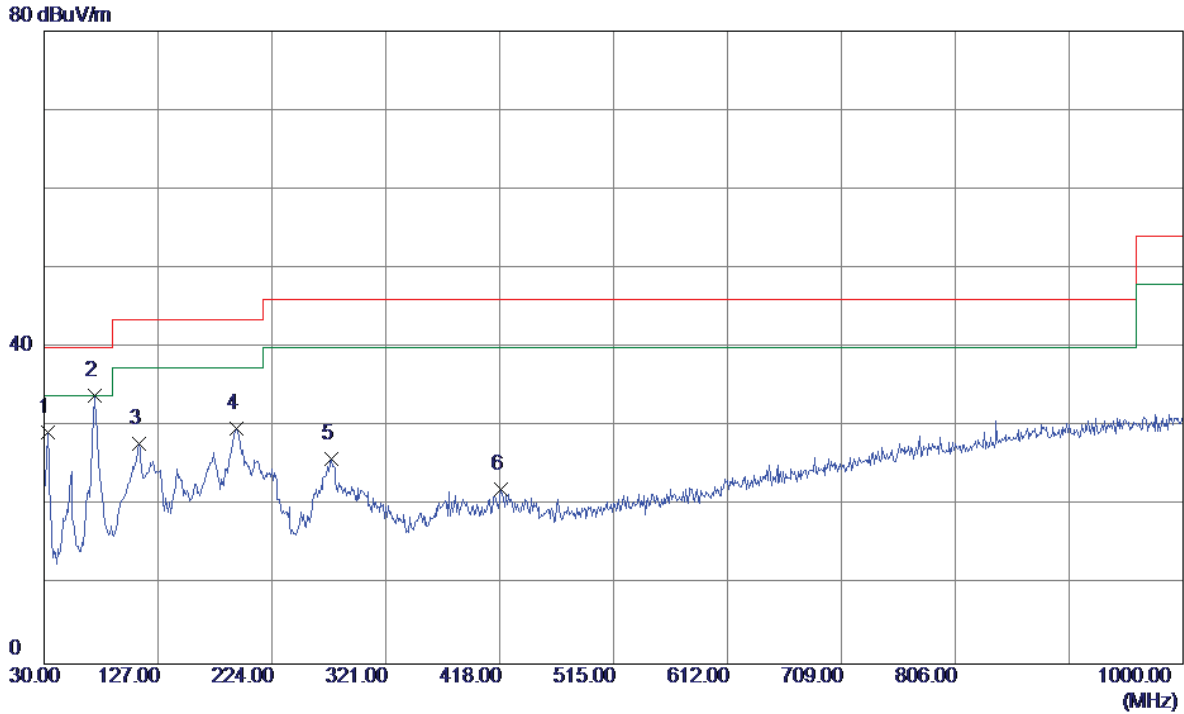

No.	Freq. MHz	Reading Level dBuV/m	Correct Factor dB	Measure ment dBuV/m	Limit dBuV/m	Margin dB	Detector	Comment
1	32.9100	44.17	-14.89	29.28	40.00	-10.72	Peak	
2 *	72.6800	50.72	-16.82	33.90	40.00	-6.10	Peak	
3	110.5100	44.00	-16.15	27.85	43.50	-15.65	Peak	
4	193.9299	42.95	-13.20	29.75	43.50	-13.75	Peak	
5	274.4400	41.22	-15.37	25.85	46.00	-20.15	Peak	
6	418.9700	32.84	-10.82	22.02	46.00	-23.98	Peak	

Test Mode: UNII-1/TX A Mode 5240MHz

Vertical

80 dBuV/m

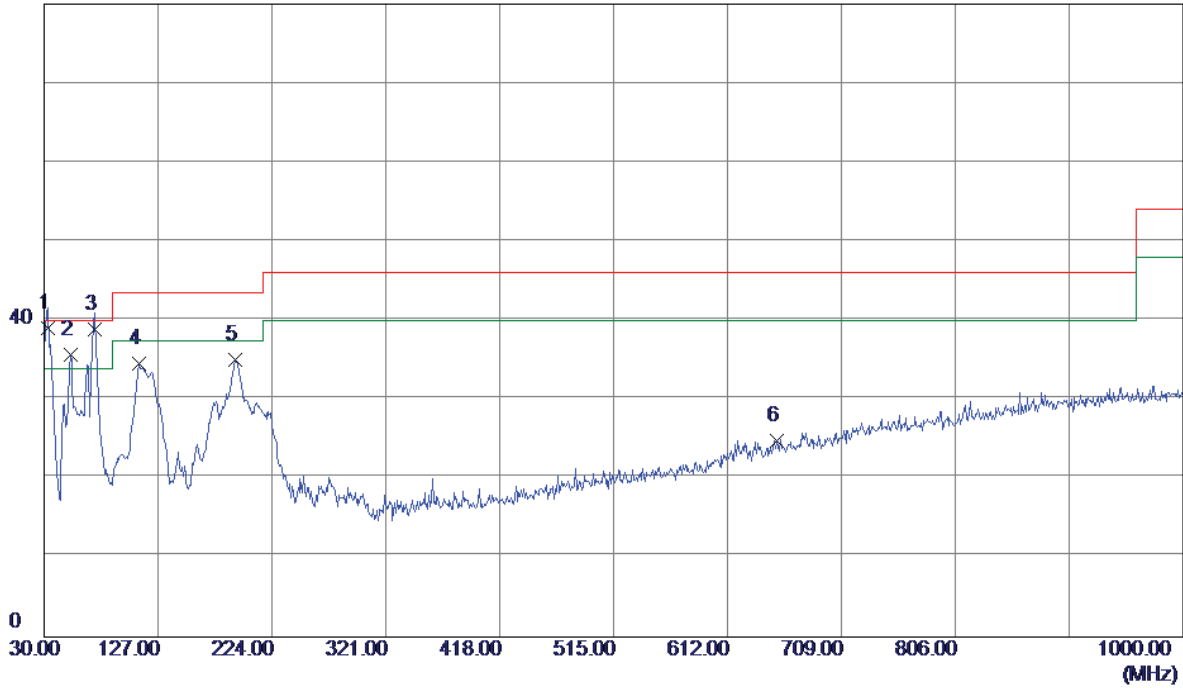

No.	Freq. MHz	Reading Level dBuV/m	Correct Factor dB	Measure ment dBuV/m	Limit dBuV/m	Margin dB	Detector	Comment
1 *	32.9100	53.91	-14.89	39.02	40.00	-0.98	QP	
2	52.3100	49.51	-13.79	35.72	40.00	-4.28	Peak	
3	72.6800	55.73	-16.82	38.91	40.00	-1.09	QP	
4	110.5100	50.68	-16.15	34.53	43.50	-8.97	Peak	
5	192.9600	48.11	-13.11	35.00	43.50	-8.50	Peak	
6	653.7100	30.20	-5.36	24.84	46.00	-21.16	Peak	

Test Mode: UNII-1/TX A Mode 5240MHz

Horizontal

80 dBuV/m

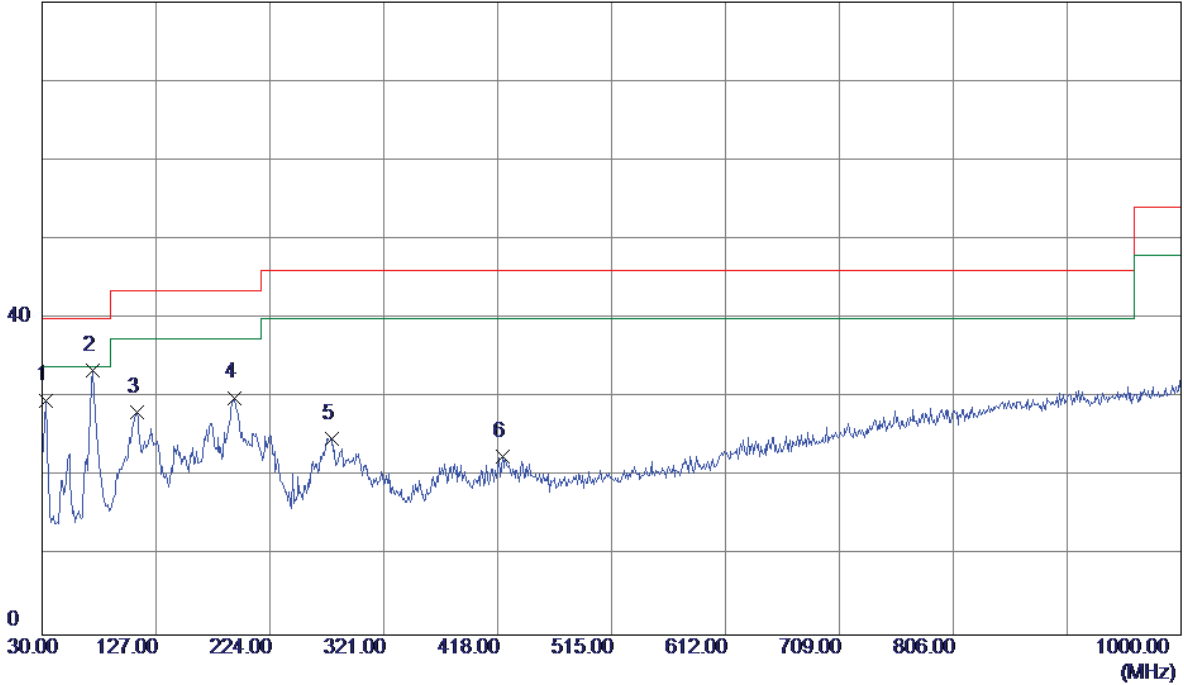

No.	Freq. MHz	Reading Level dBuV/m	Correct Factor dB	Measure ment dBuV/m	Limit dBuV/m	Margin dB	Detector	Comment
1	32.9100	44.57	-14.89	29.68	40.00	-10.32	Peak	
2 *	72.6800	50.33	-16.82	33.51	40.00	-6.49	Peak	
3	110.5100	44.30	-16.15	28.15	43.50	-15.35	Peak	
4	193.9299	43.20	-13.20	30.00	43.50	-13.50	Peak	
5	276.3800	40.03	-15.16	24.87	46.00	-21.13	Peak	
6	421.8800	33.32	-10.74	22.58	46.00	-23.42	Peak	

Test Mode: UNII-3/TX A Mode 5745MHz

Vertical

80 dBuV/m

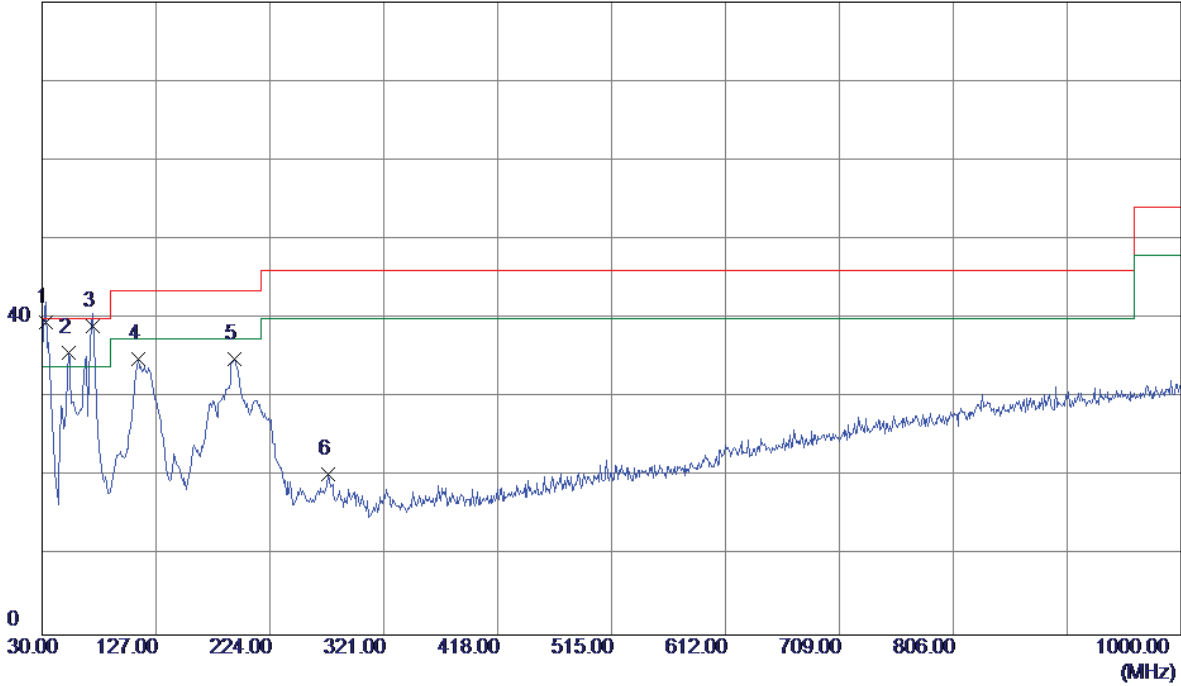

No.	Freq. MHz	Reading Level dBuV/m	Correct Factor dB	Measure ment dBuV/m	Limit dBuV/m	Margin dB	Detector	Comment
1 *	32.9100	54.47	-14.89	39.58	40.00	-0.42	QP	
2	52.3100	49.53	-13.79	35.74	40.00	-4.26	Peak	
3	72.6800	55.85	-16.82	39.03	40.00	-0.97	QP	
4	111.4800	50.89	-16.07	34.82	43.50	-8.68	Peak	
5	193.9299	48.10	-13.20	34.90	43.50	-8.60	Peak	
6	273.4700	35.80	-15.47	20.33	46.00	-25.67	Peak	

Test Mode: UNII-3/TX A Mode 5745MHz

Horizontal

80 dBuV/m

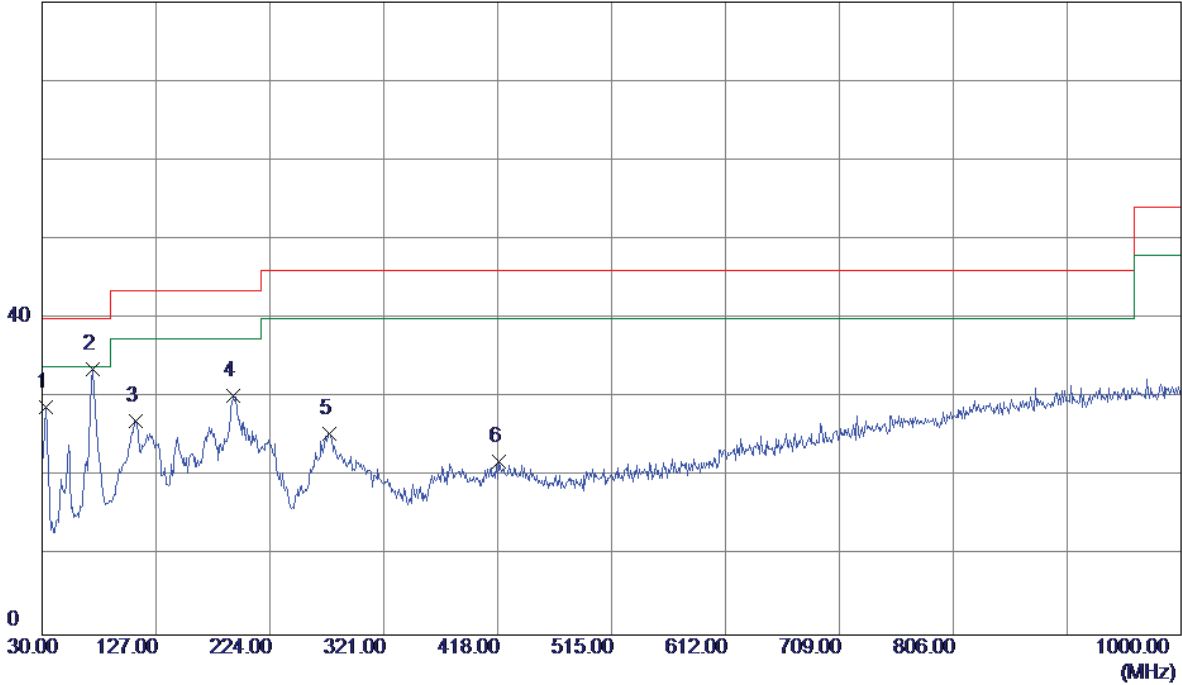

No.	Freq. MHz	Reading Level dBuV/m	Correct Factor dB	Measure ment dBuV/m	Limit dBuV/m	Margin dB	Detector	Comment
1	32.9100	43.75	-14.89	28.86	40.00	-11.14	Peak	
2 *	72.6800	50.38	-16.82	33.56	40.00	-6.44	Peak	
3	109.5400	43.29	-16.25	27.04	43.50	-16.46	Peak	
4	192.9600	43.31	-13.11	30.20	43.50	-13.30	Peak	
5	274.4400	40.87	-15.37	25.50	46.00	-20.50	Peak	
6	418.9700	32.71	-10.82	21.89	46.00	-24.11	Peak	

Test Mode: UNII-3/TX A Mode 5785MHz

Vertical

80 dBuV/m

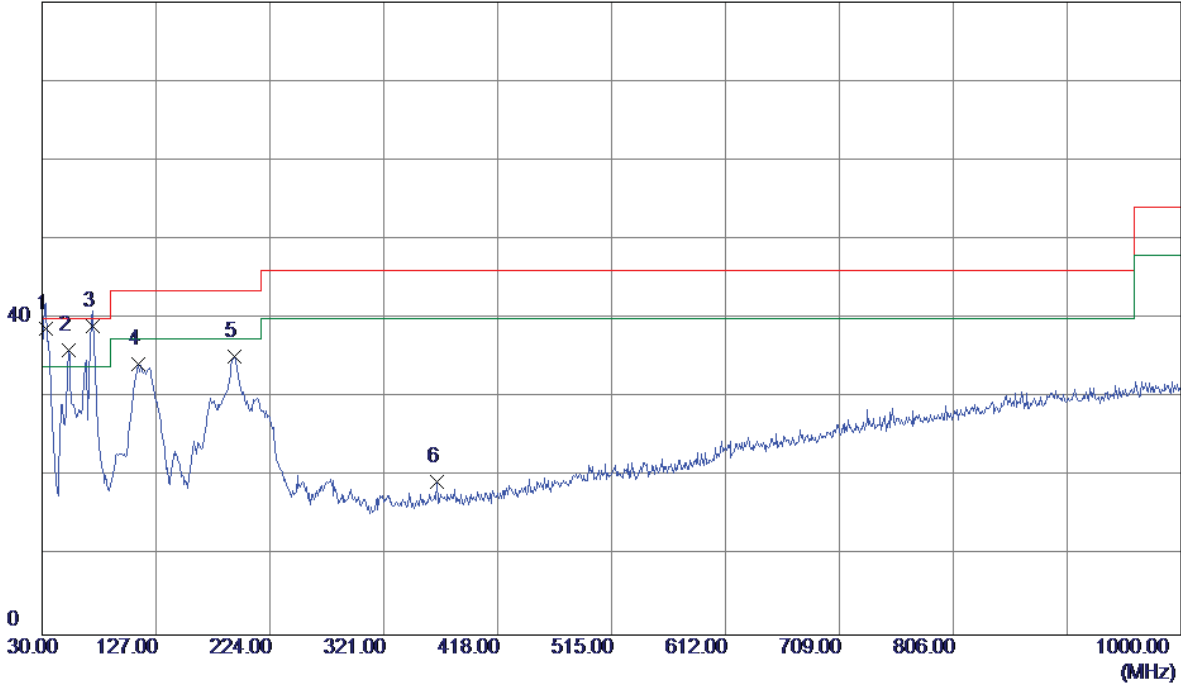

No.	Freq. MHz	Reading Level dBuV/m	Correct Factor dB	Measure ment dBuV/m	Limit dBuV/m	Margin dB	Detector	Comment
1	32.9100	53.56	-14.89	38.67	40.00	-1.33	QP	
2	52.3100	49.79	-13.79	36.00	40.00	-4.00	Peak	
3 *	72.6800	55.89	-16.82	39.07	40.00	-0.93	QP	
4	111.4800	50.36	-16.07	34.29	43.50	-9.21	Peak	
5	193.9299	48.36	-13.20	35.16	43.50	-8.34	Peak	
6	366.5900	31.08	-11.76	19.32	46.00	-26.68	Peak	

Test Mode: UNII-3/TX A Mode 5785MHz

Horizontal

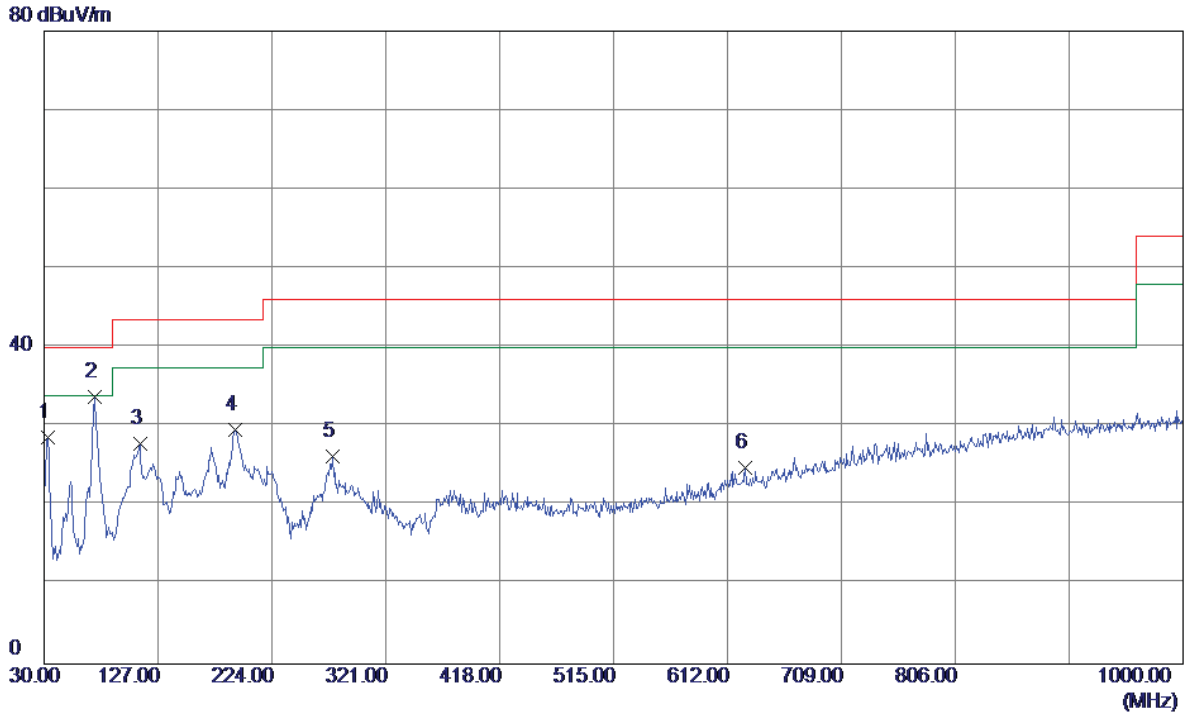

No.	Freq. MHz	Reading Level dBuV/m	Correct Factor dB	Measure ment dBuV/m	Limit dBuV/m	Margin dB	Detector	Comment
1	32.9100	43.53	-14.89	28.64	40.00	-11.36	Peak	
2 *	72.6800	50.64	-16.82	33.82	40.00	-6.18	Peak	
3	111.4800	43.92	-16.07	27.85	43.50	-15.65	Peak	
4	192.9600	42.78	-13.11	29.67	43.50	-13.83	Peak	
5	275.4100	41.51	-15.26	26.25	46.00	-19.75	Peak	
6	627.5200	30.69	-5.90	24.79	46.00	-21.21	Peak	

Test Mode: UNII-3/TX A Mode 5825MHz

Vertical

80 dBuV/m

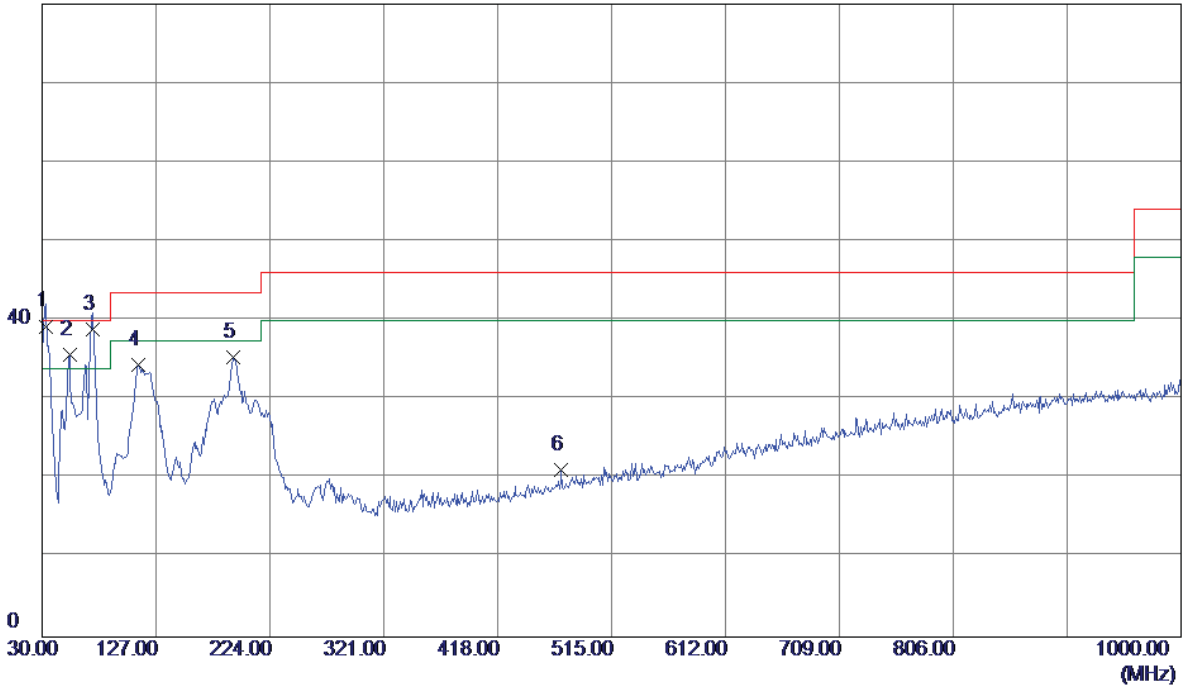

No.	Freq. MHz	Reading Level dBuV/m	Correct Factor dB	Measure ment dBuV/m	Limit dBuV/m	Margin dB	Detector	Comment
1 *	32.9100	54.17	-14.89	39.28	40.00	-0.72	QP	
2	53.2800	49.59	-13.88	35.71	40.00	-4.29	Peak	
3	72.6800	55.72	-16.82	38.90	40.00	-1.10	QP	
4	111.4800	50.49	-16.07	34.42	43.50	-9.08	Peak	
5	192.9600	48.54	-13.11	35.43	43.50	-8.07	Peak	
6	472.3200	30.53	-9.40	21.13	46.00	-24.87	Peak	

Test Mode: UNII-3/TX A Mode 5825MHz

Horizontal

80 dBuV/m

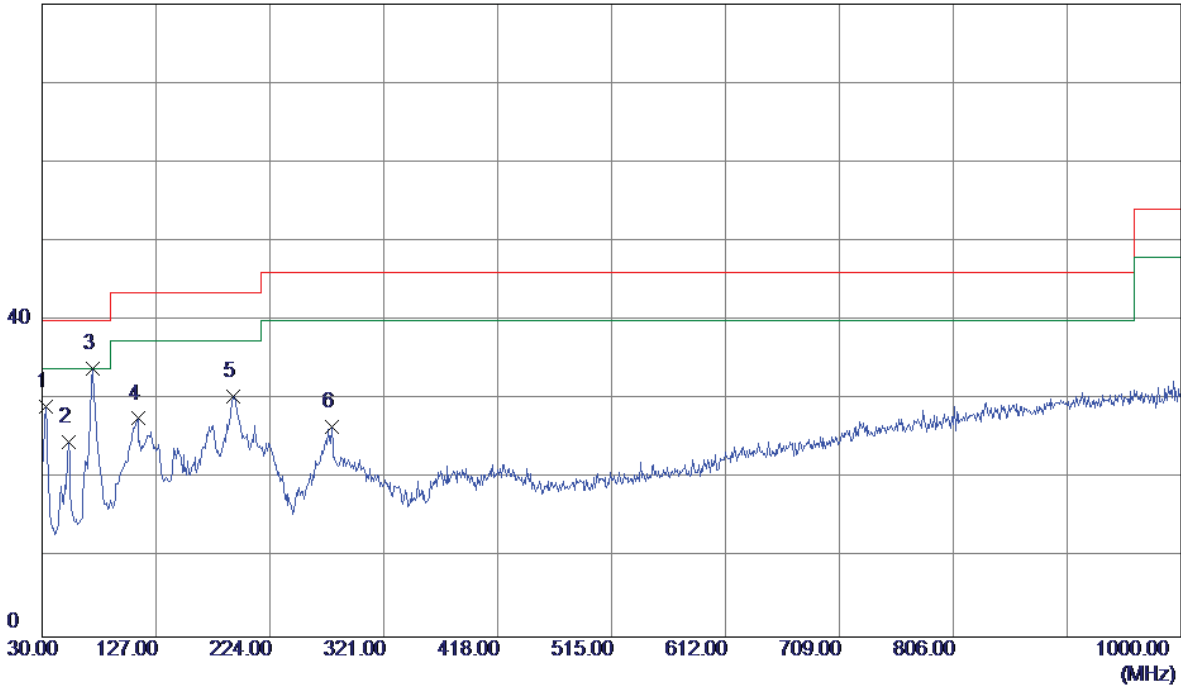

No.	Freq. MHz	Reading Level dBuV/m	Correct Factor dB	Measure ment dBuV/m	Limit dBuV/m	Margin dB	Detector	Comment
1	32.9100	44.03	-14.89	29.14	40.00	-10.86	Peak	
2	52.3100	38.37	-13.79	24.58	40.00	-15.42	Peak	
3 *	72.6800	50.72	-16.82	33.90	40.00	-6.10	Peak	
4	111.4800	43.67	-16.07	27.60	43.50	-15.90	Peak	
5	192.9600	43.47	-13.11	30.36	43.50	-13.14	Peak	
6	276.3800	41.68	-15.16	26.52	46.00	-19.48	Peak	

ATTACHMENT D - RADIATED EMISSION (ABOVE 1000MHZ)

Orthogonal Axis:	X
Test Mode:	UNII-1/ TX A Mode 5180MHz

Vertical

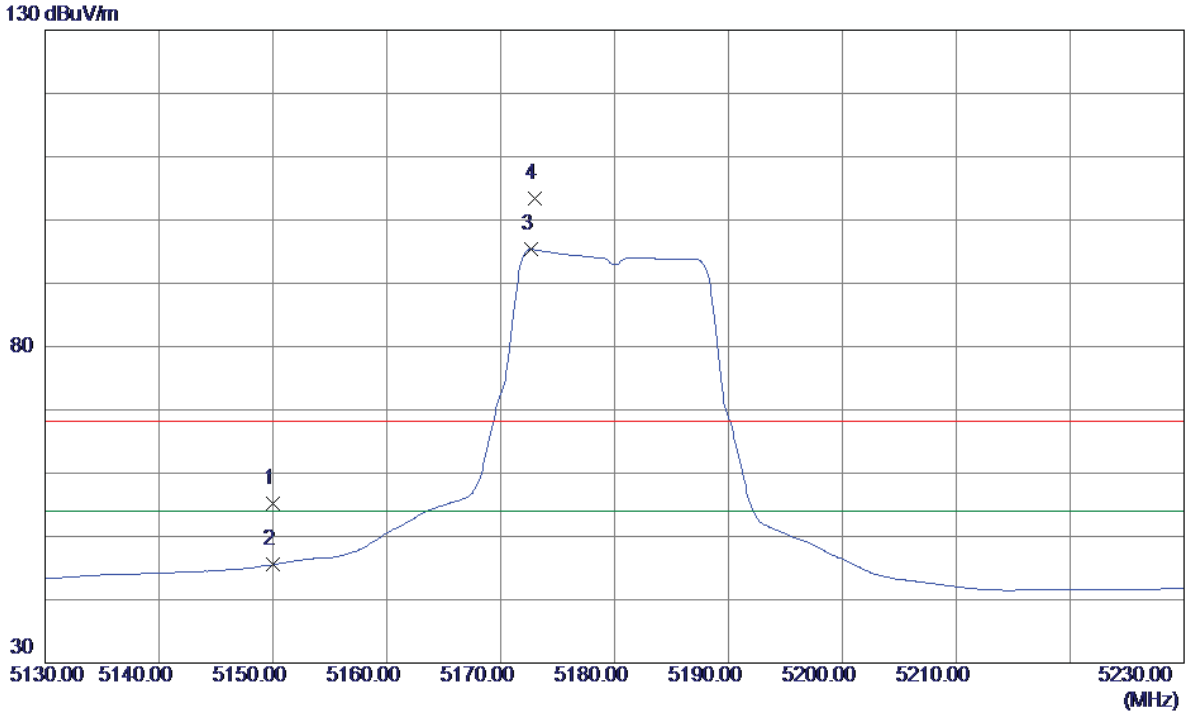

No.	Freq. MHz	Reading Level dBuV/m	Correct Factor dB	Measure ment dBuV/m	Limit dBuV/m	Margin dB	Detector	Comment
1	5150.0000	14.16	41.10	55.26	68.30	-13.04	Peak	
2	5150.0000	4.41	41.10	45.51	54.00	-8.49	AVG	
3 *	5172.7000	54.14	41.22	95.36	54.00	41.36	AVG	No Limit
4	5173.0000	62.12	41.22	103.34	68.30	35.04	Peak	No Limit

Orthogonal Axis:	X
Test Mode:	UNII-1/ TX A Mode 5180MHz

Vertical

80 dBuV/m

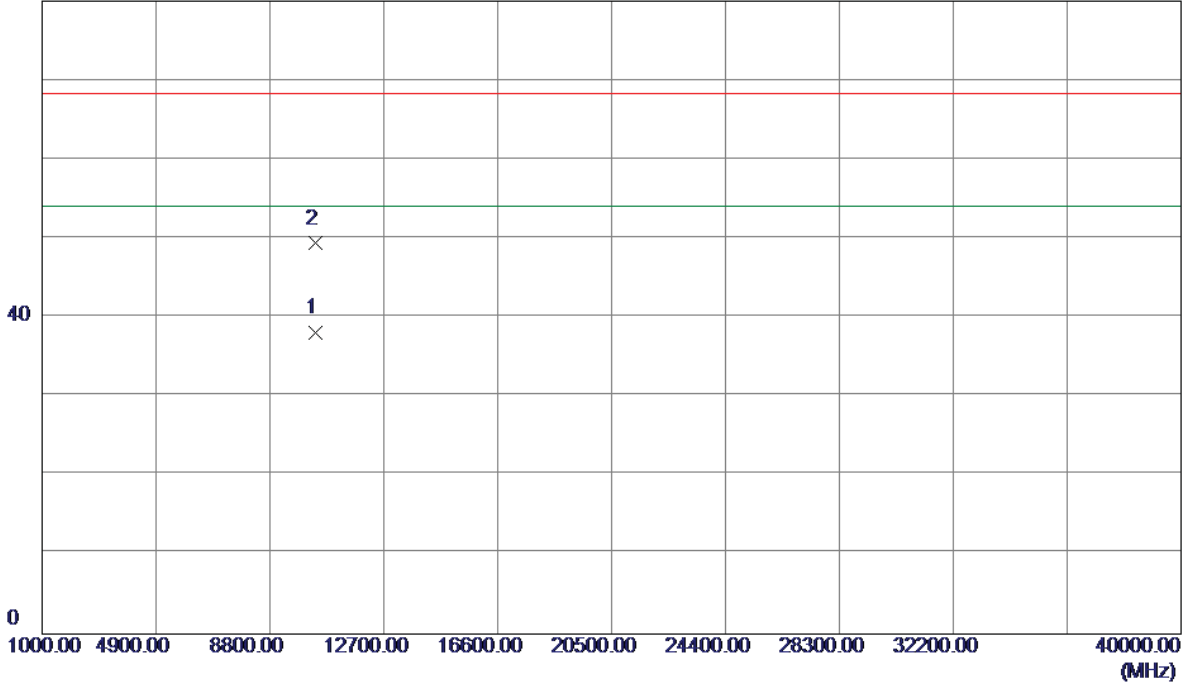

No.	Freq. MHz	Reading Level dBuV/m	Correct Factor dB	Measure ment dBuV/m	Limit dBuV/m	Margin dB	Detector	Comment
1 *	10359.3580	20.92	17.10	38.02	54.00	-15.98	AVG	
2	10359.6560	32.26	17.10	49.36	68.30	-18.94	Peak	

Orthogonal Axis:	X
Test Mode:	UNII-1/ TX A Mode 5180MHz

Horizontal

130 dBuV/m

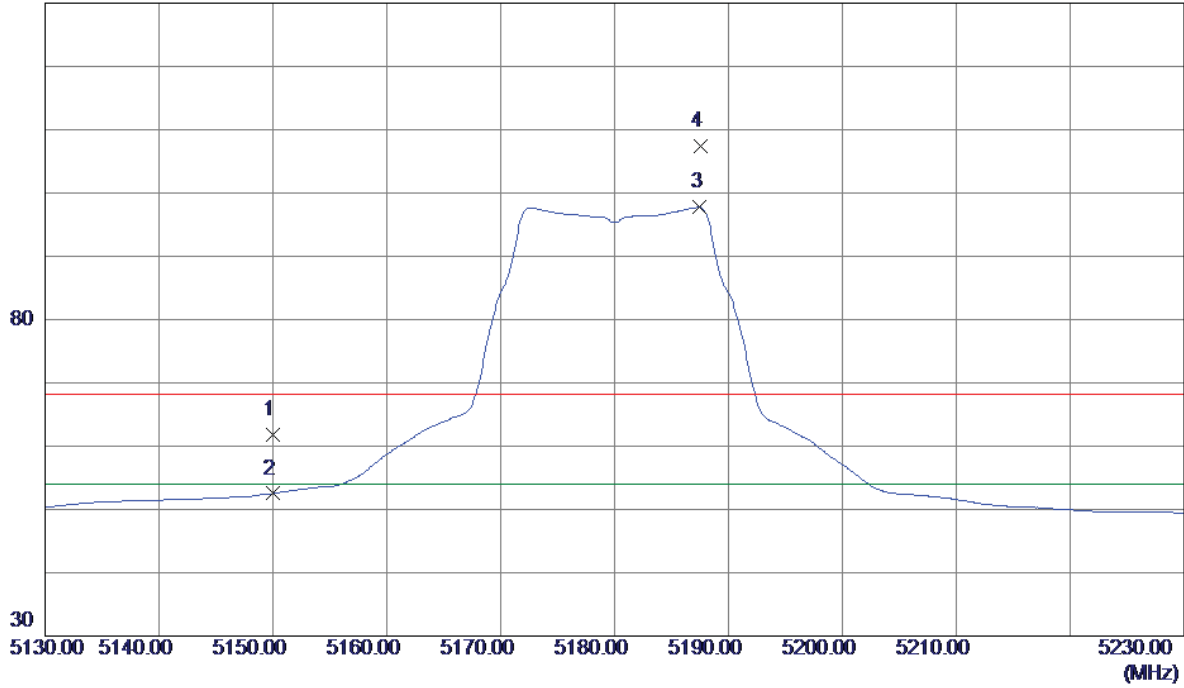

No.	Freq. MHz	Reading Level dBuV/m	Correct Factor dB	Measure ment dBuV/m	Limit dBuV/m	Margin dB	Detector	Comment
1	5150.0000	20.76	41.10	61.86	68.30	-6.44	Peak	
2	5150.0000	11.40	41.10	52.50	54.00	-1.50	AVG	
3 *	5187.5000	56.44	41.29	97.73	54.00	43.73	AVG	No Limit
4	5187.6000	66.16	41.29	107.45	68.30	39.15	Peak	No Limit

Orthogonal Axis:	X
Test Mode:	UNII-1/ TX A Mode 5180MHz

Horizontal

80 dBuV/m

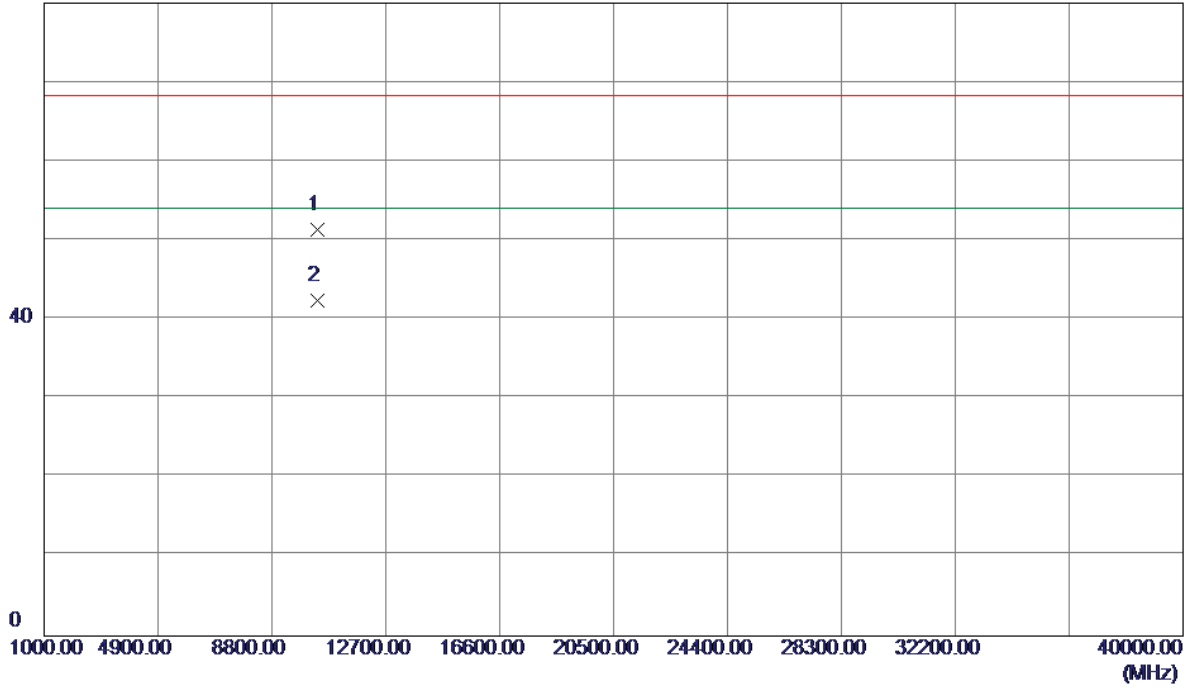

No.	Freq. MHz	Reading Level dBuV/m	Correct Factor dB	Measure ment dBuV/m	Limit dBuV/m	Margin dB	Detector	Comment
1	10359.7920	34.23	17.10	51.33	68.30	-16.97	Peak	
2 *	10359.8960	25.28	17.10	42.38	54.00	-11.62	AVG	

Orthogonal Axis:	X
Test Mode:	UNII-1/ TX A Mode 5200MHz

Vertical

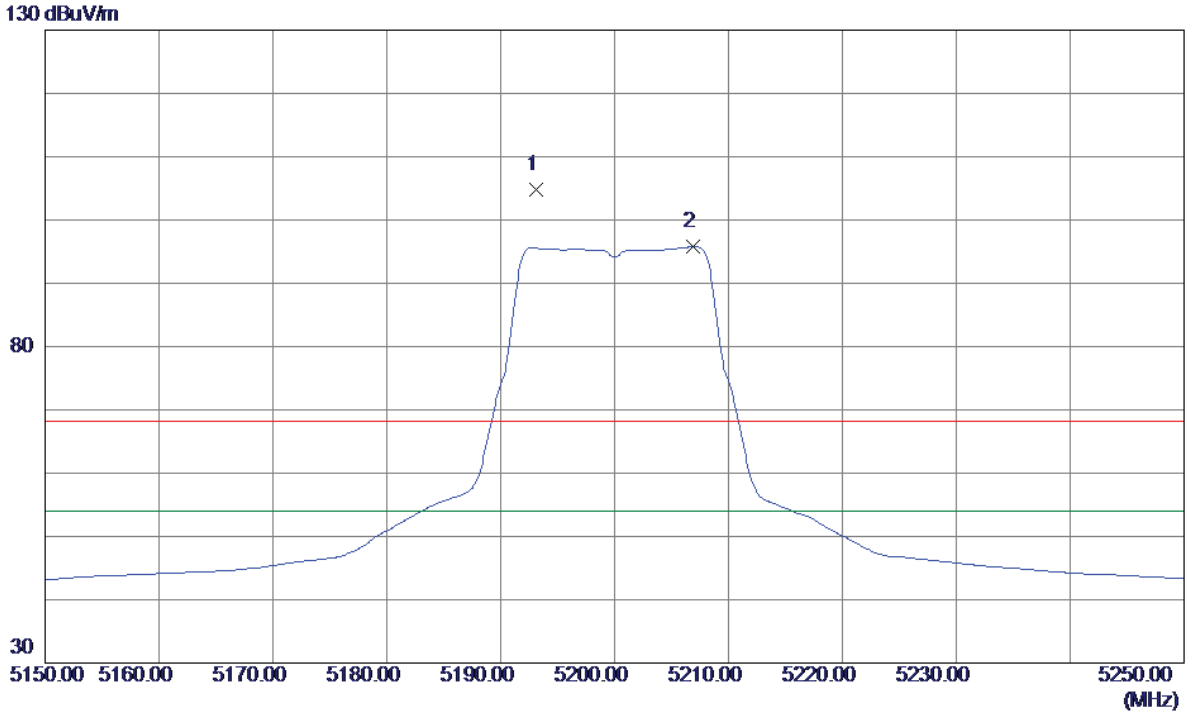

No.	Freq. MHz	Reading Level dBuV/m	Correct Factor dB	Measure ment dBuV/m	Limit dBuV/m	Margin dB	Detector	Comment
1	5193.1000	63.40	41.32	104.72	68.30	36.42	Peak	No Limit
2 *	5206.9000	54.36	41.39	95.75	54.00	41.75	AVG	No Limit

Orthogonal Axis:	X
Test Mode:	UNII-1/ TX A Mode 5200MHz

Vertical

80 dBuV/m

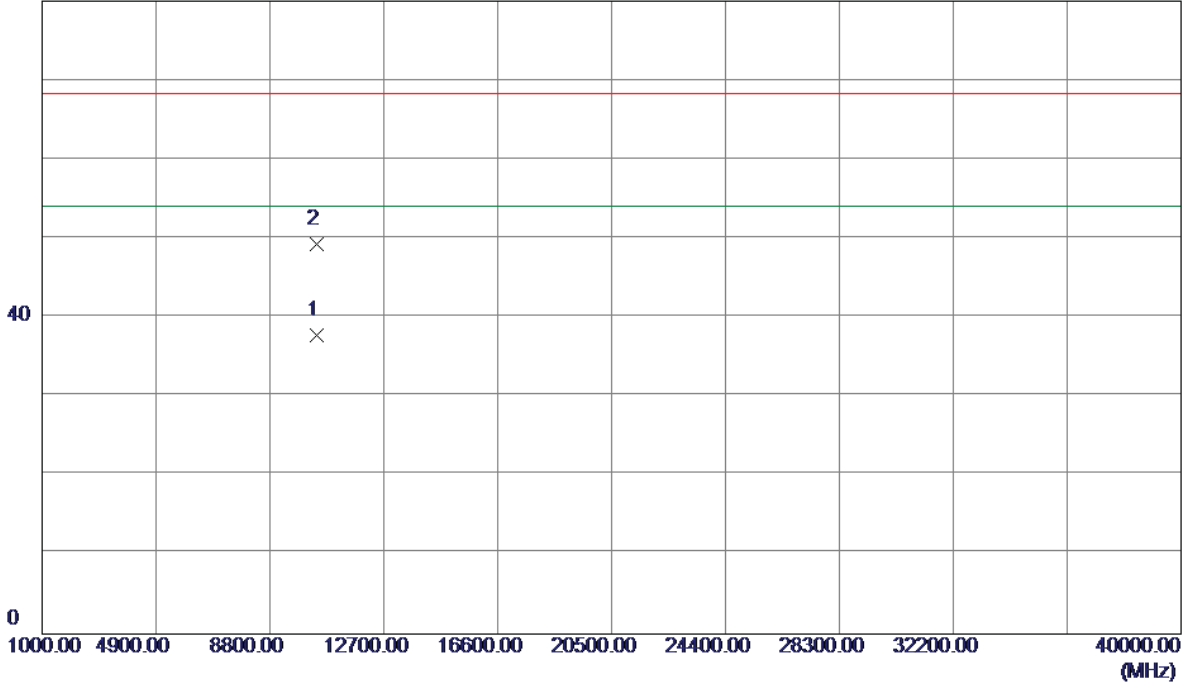

No.	Freq. MHz	Reading Level dBuV/m	Correct Factor dB	Measure ment dBuV/m	Limit dBuV/m	Margin dB	Detector	Comment
1 *	10399.5800	20.59	17.22	37.81	54.00	-16.19	AVG	
2	10399.5980	32.00	17.22	49.22	68.30	-19.08	Peak	

Orthogonal Axis:	X
Test Mode:	UNII-1/ TX A Mode 5200MHz

Horizontal

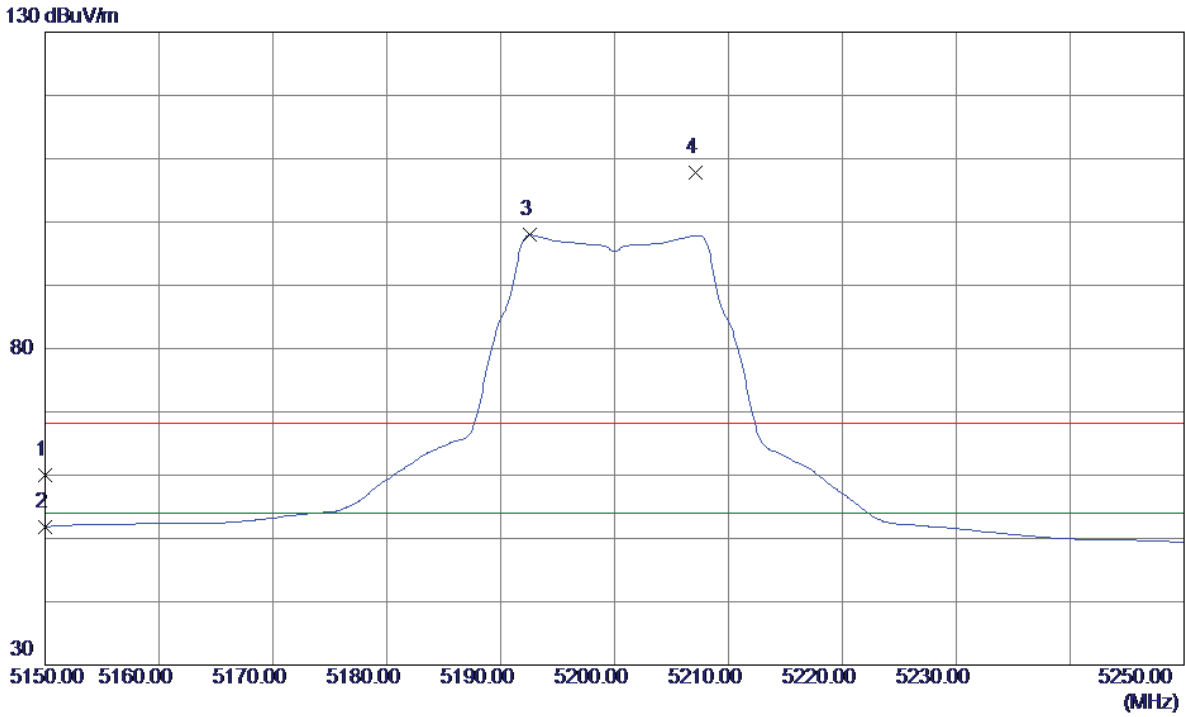

No.	Freq. MHz	Reading Level dBuV/m	Correct Factor dB	Measure ment dBuV/m	Limit dBuV/m	Margin dB	Detector	Comment
1	5150.0000	18.98	41.10	60.08	68.30	-8.22	Peak	
2	5150.0000	10.74	41.10	51.84	54.00	-2.16	AVG	
3 *	5192.6000	56.63	41.32	97.95	54.00	43.95	AVG	No Limit
4	5207.1000	66.46	41.39	107.85	68.30	39.55	Peak	No Limit

Orthogonal Axis:	X
Test Mode:	UNII-1/ TX A Mode 5200MHz

Horizontal

80 dBuV/m

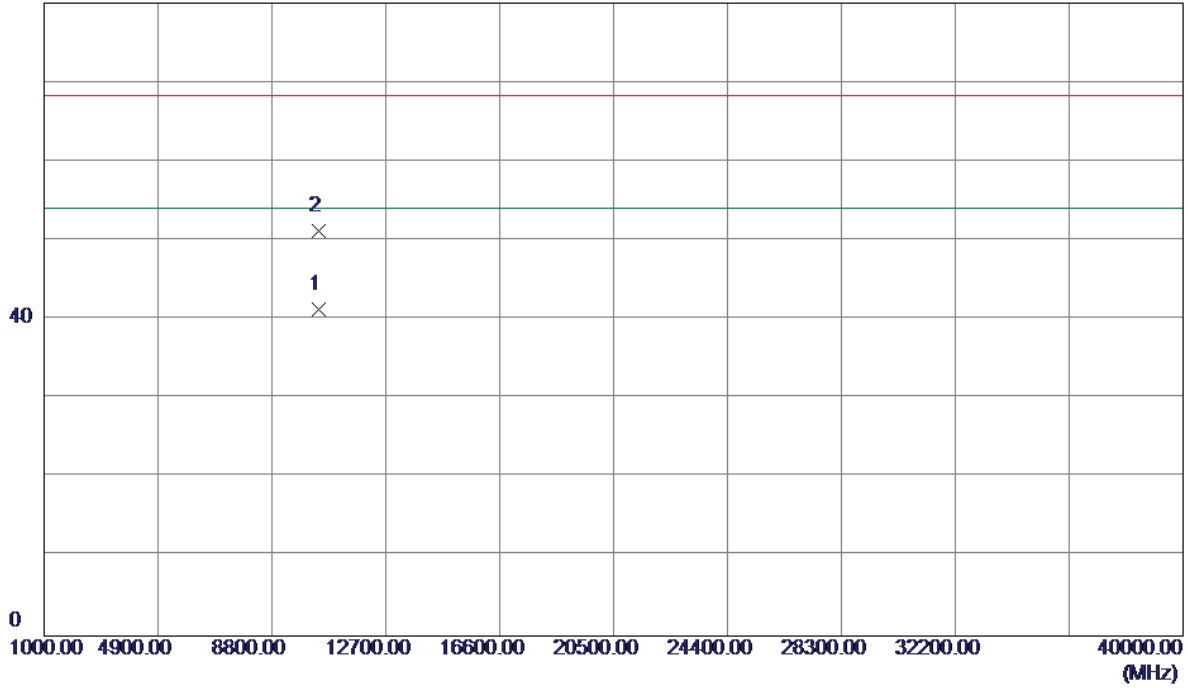

No.	Freq. MHz	Reading Level dBuV/m	Correct Factor dB	Measure ment dBuV/m	Limit dBuV/m	Margin dB	Detector	Comment
1 *	10399.8800	24.06	17.22	41.28	54.00	-12.72	AVG	
2	10400.2460	33.97	17.22	51.19	68.30	-17.11	Peak	

Orthogonal Axis:	X
Test Mode:	UNII-1/ TX A Mode 5240MHz

Vertical

130 dBuV/m

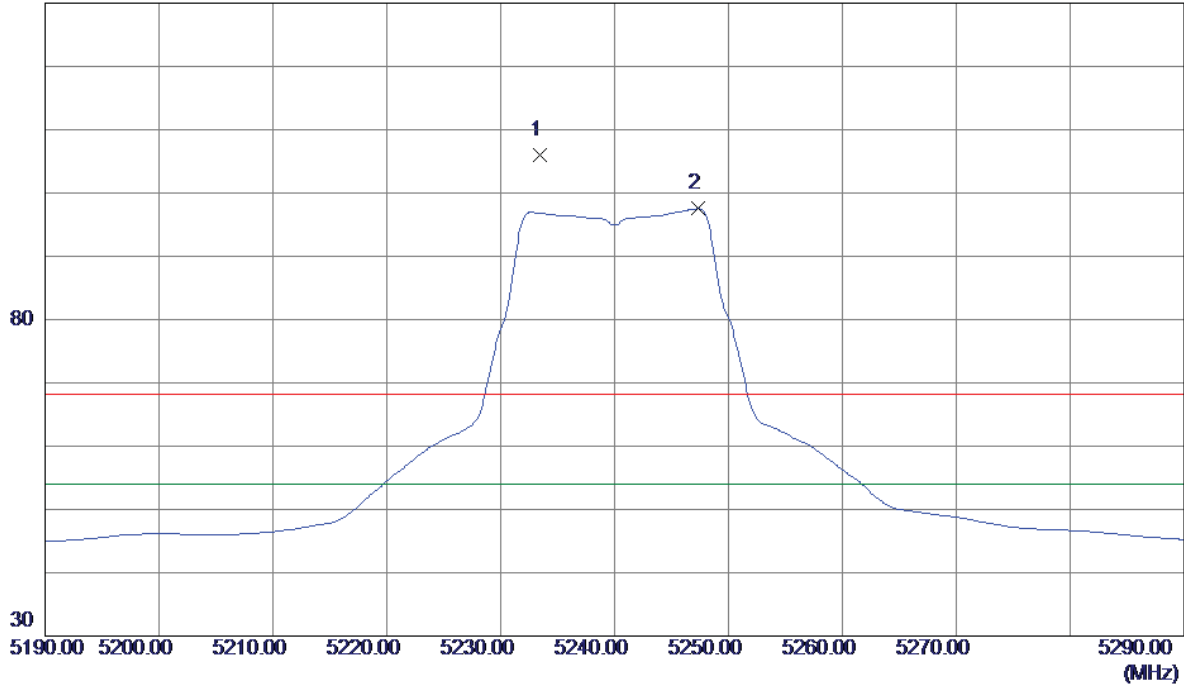

No.	Freq. MHz	Reading Level dBuV/m	Correct Factor dB	Measure ment dBuV/m	Limit dBuV/m	Margin dB	Detector	Comment
1	5233.4000	64.41	41.53	105.94	68.30	37.64	Peak	No Limit
2 *	5247.3000	55.92	41.60	97.52	54.00	43.52	AVG	No Limit

Orthogonal Axis:	X
Test Mode:	UNII-1/ TX A Mode 5240MHz

Vertical

80 dBuV/m

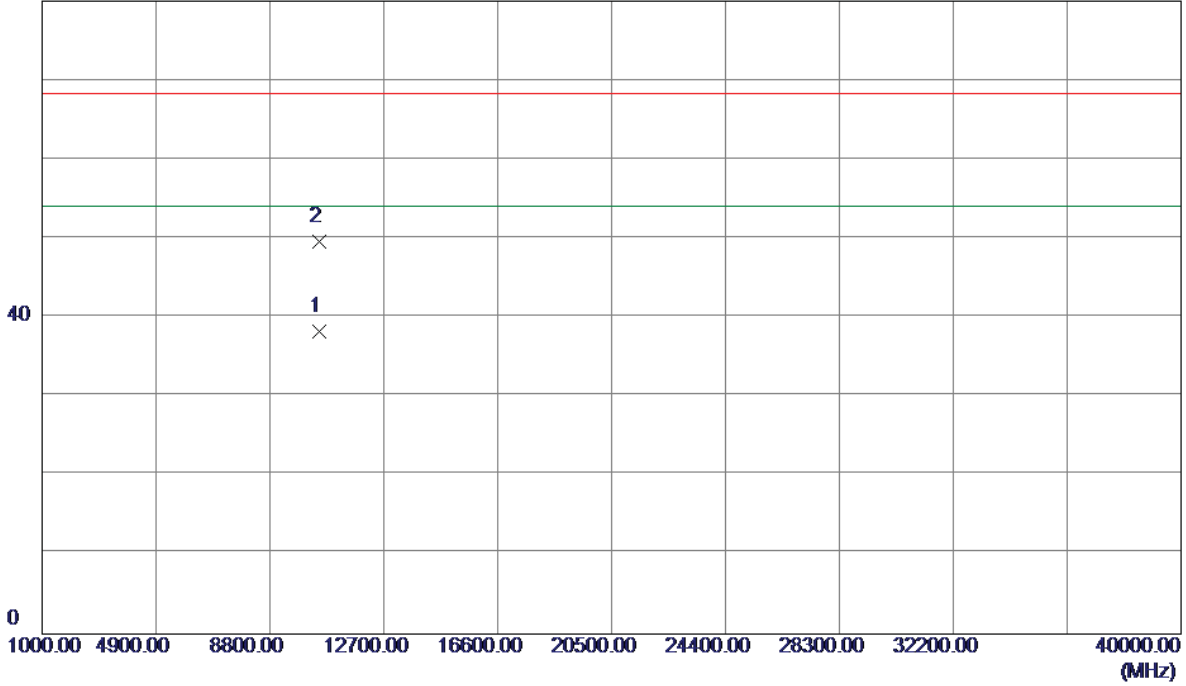

No.	Freq. MHz	Reading Level dBuV/m	Correct Factor dB	Measure ment dBuV/m	Limit dBuV/m	Margin dB	Detector	Comment
1 *	10479.6600	20.84	17.44	38.28	54.00	-15.72	AVG	
2	10479.9440	32.20	17.44	49.64	68.30	-18.66	Peak	

Orthogonal Axis:	X
Test Mode:	UNII-1/ TX A Mode 5240MHz

Horizontal

130 dBuV/m

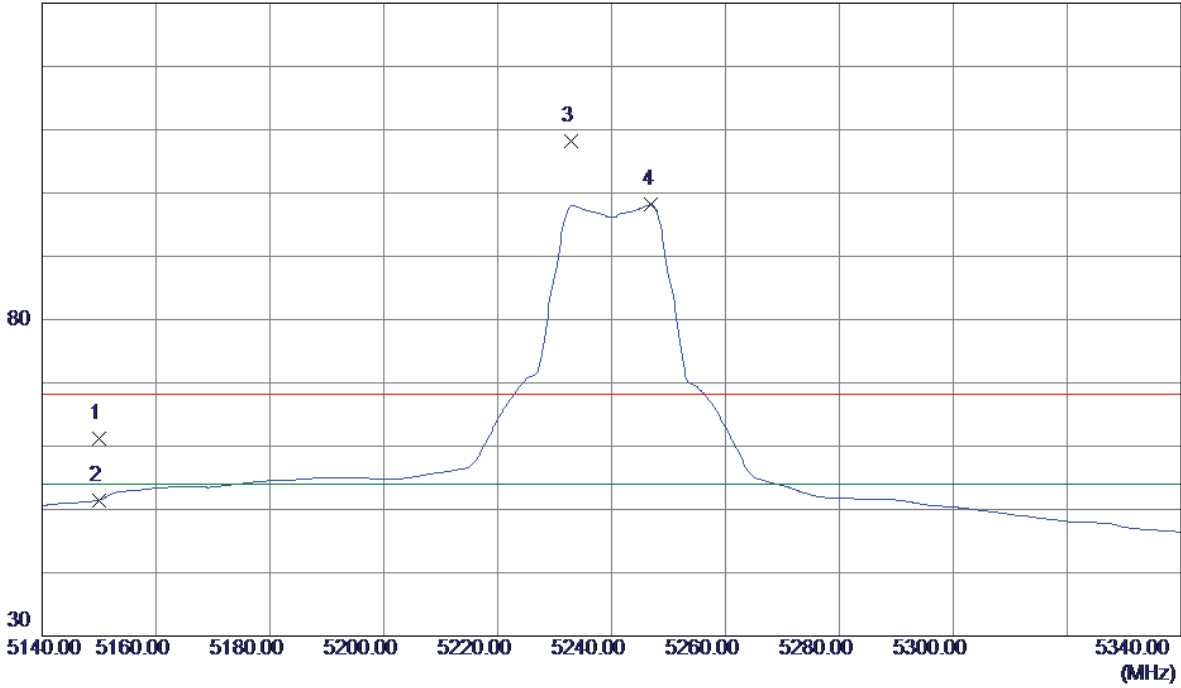

No.	Freq. MHz	Reading Level dBuV/m	Correct Factor dB	Measure ment dBuV/m	Limit dBuV/m	Margin dB	Detector	Comment
1	5150.0000	20.02	41.10	61.12	68.30	-7.18	Peak	
2	5150.0000	10.38	41.10	51.48	54.00	-2.52	AVG	
3	5232.8000	66.75	41.52	108.27	68.30	39.97	Peak	No Limit
4 *	5247.0000	56.61	41.59	98.20	54.00	44.20	AVG	No Limit

Orthogonal Axis:	X
Test Mode:	UNII-1/ TX A Mode 5240MHz

Horizontal

80 dBuV/m

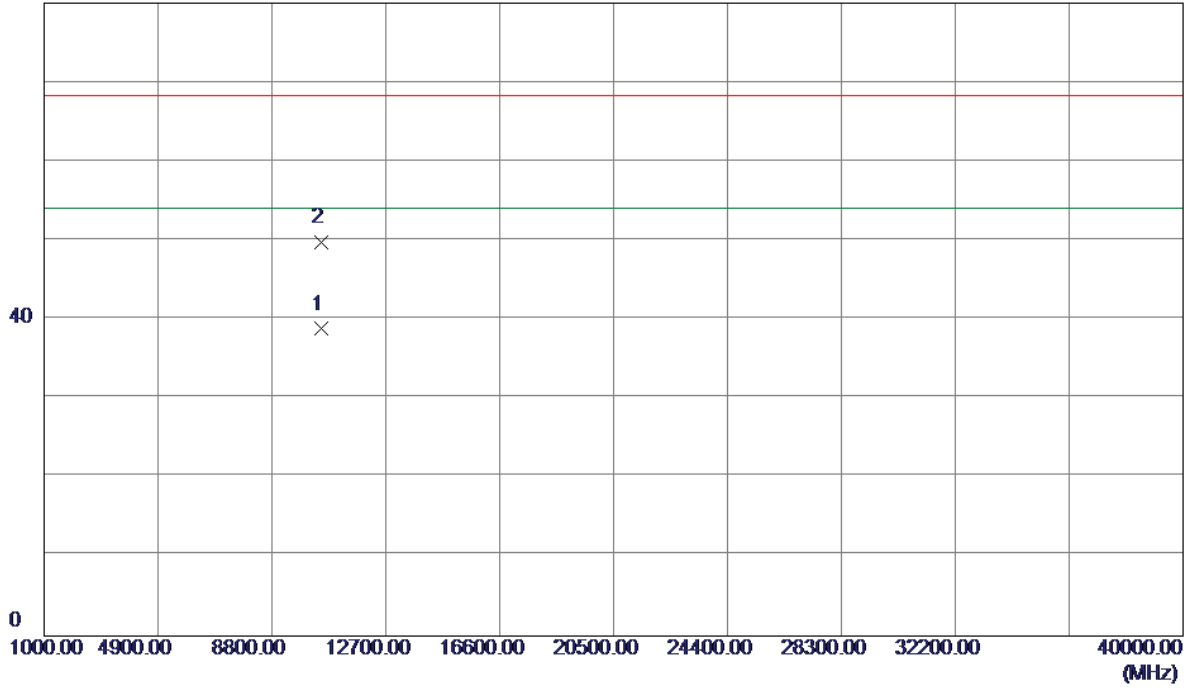

No.	Freq. MHz	Reading Level dBuV/m	Correct Factor dB	Measure ment dBuV/m	Limit dBuV/m	Margin dB	Detector	Comment
1 *	10479.8880	21.36	17.44	38.80	54.00	-15.20	AVG	
2	10480.3840	32.36	17.44	49.80	68.30	-18.50	Peak	

Orthogonal Axis:	X
Test Mode:	UNII-1/ TX N20 Mode 5180MHz

Vertical

130 dBuV/m

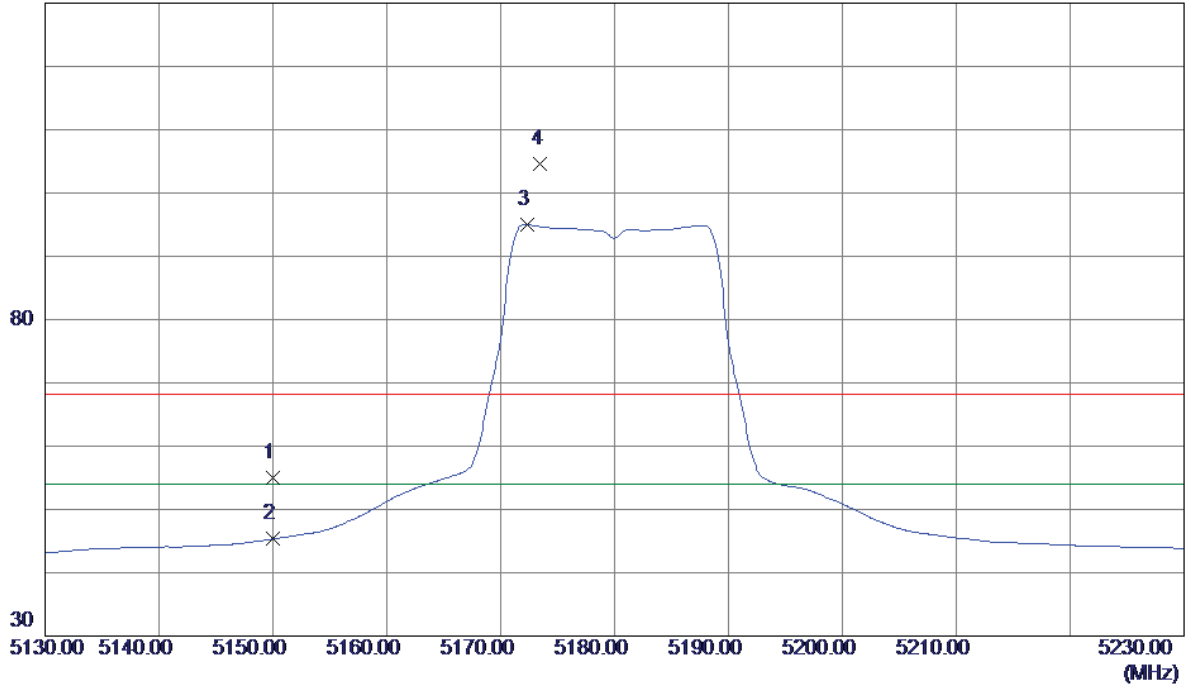

No.	Freq. MHz	Reading Level dBuV/m	Correct Factor dB	Measure ment dBuV/m	Limit dBuV/m	Margin dB	Detector	Comment
1	5150.0000	13.97	41.10	55.07	68.30	-13.23	Peak	
2	5150.0000	4.24	41.10	45.34	54.00	-8.66	AVG	
3 *	5172.3000	53.80	41.22	95.02	54.00	41.02	AVG	No Limit
4	5173.5000	63.47	41.22	104.69	68.30	36.39	Peak	No Limit

Orthogonal Axis:	X
Test Mode:	UNII-1/ TX N20 Mode 5180MHz

Vertical

80 dBuV/m

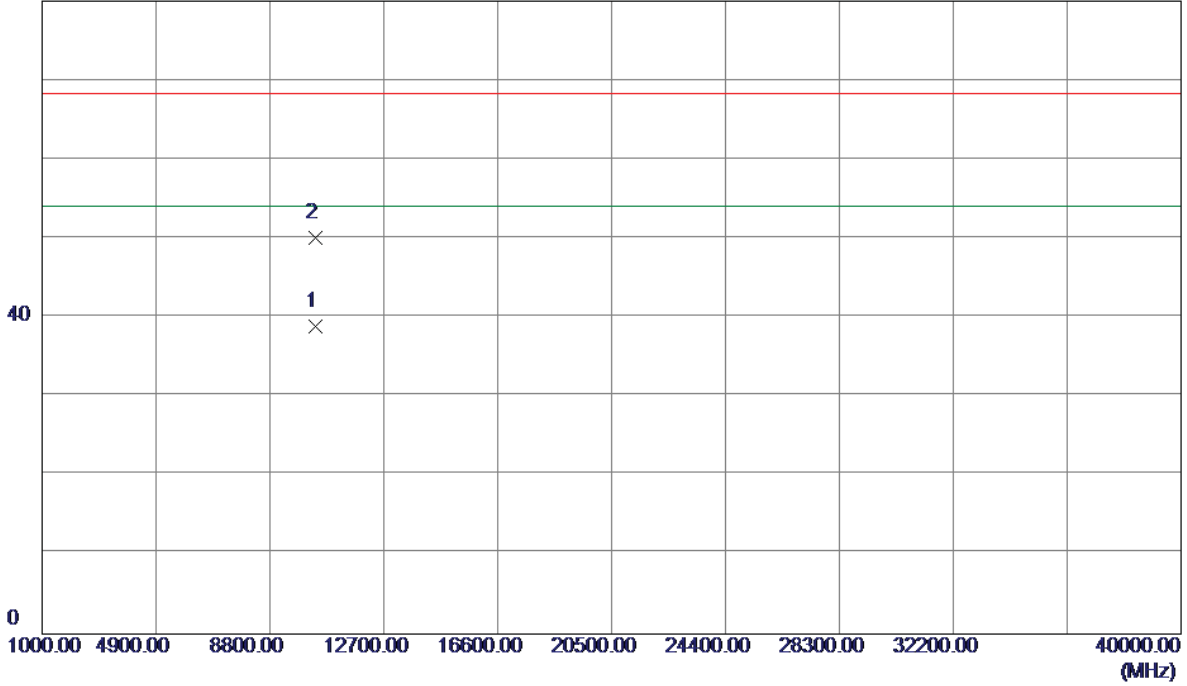

No.	Freq. MHz	Reading Level dBuV/m	Correct Factor dB	Measure ment dBuV/m	Limit dBuV/m	Margin dB	Detector	Comment
1 *	10359.7120	21.73	17.10	38.83	54.00	-15.17	AVG	
2	10360.7699	33.01	17.11	50.12	68.30	-18.18	Peak	

Orthogonal Axis:	X
Test Mode:	UNII-1/ TX N20 Mode 5180MHz

Horizontal

130 dBuV/m

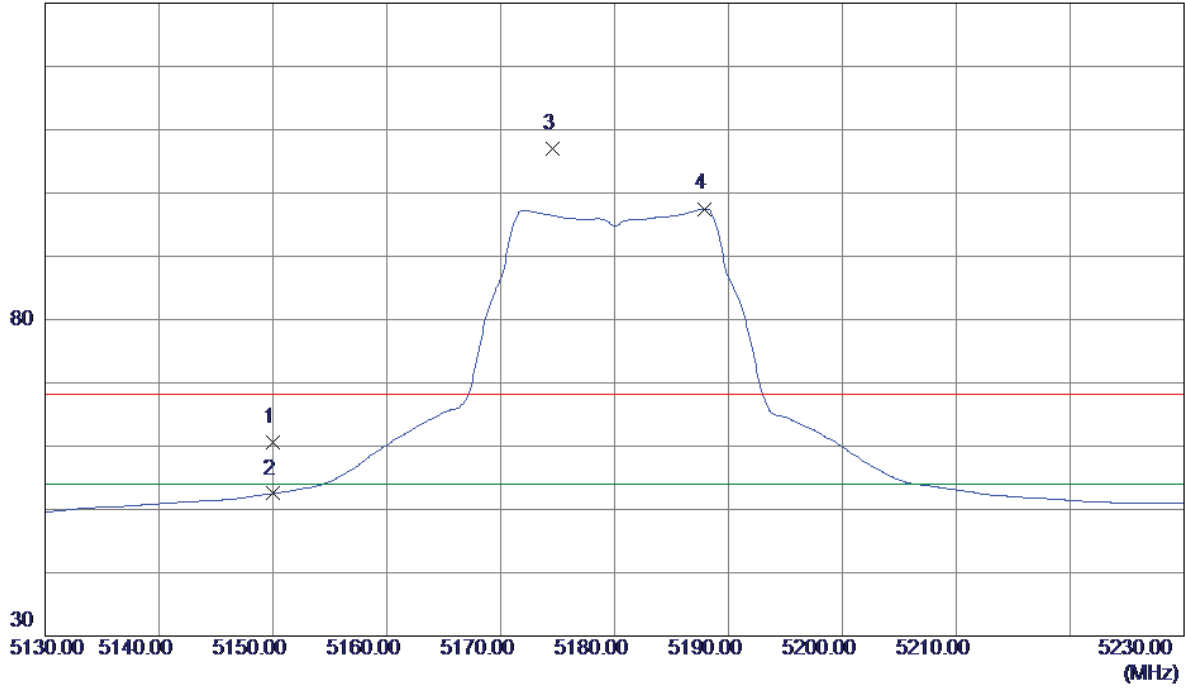

No.	Freq. MHz	Reading Level dBuV/m	Correct Factor dB	Measure ment dBuV/m	Limit dBuV/m	Margin dB	Detector	Comment
1	5150.0000	19.42	41.10	60.52	68.30	-7.78	Peak	
2	5150.0000	11.40	41.10	52.50	54.00	-1.50	AVG	
3	5174.6000	65.72	41.23	106.95	68.30	38.65	Peak	No Limit
4 *	5187.9000	56.21	41.29	97.50	54.00	43.50	AVG	No Limit

Orthogonal Axis:	X
Test Mode:	UNII-1/ TX N20 Mode 5180MHz

Horizontal

80 dBuV/m

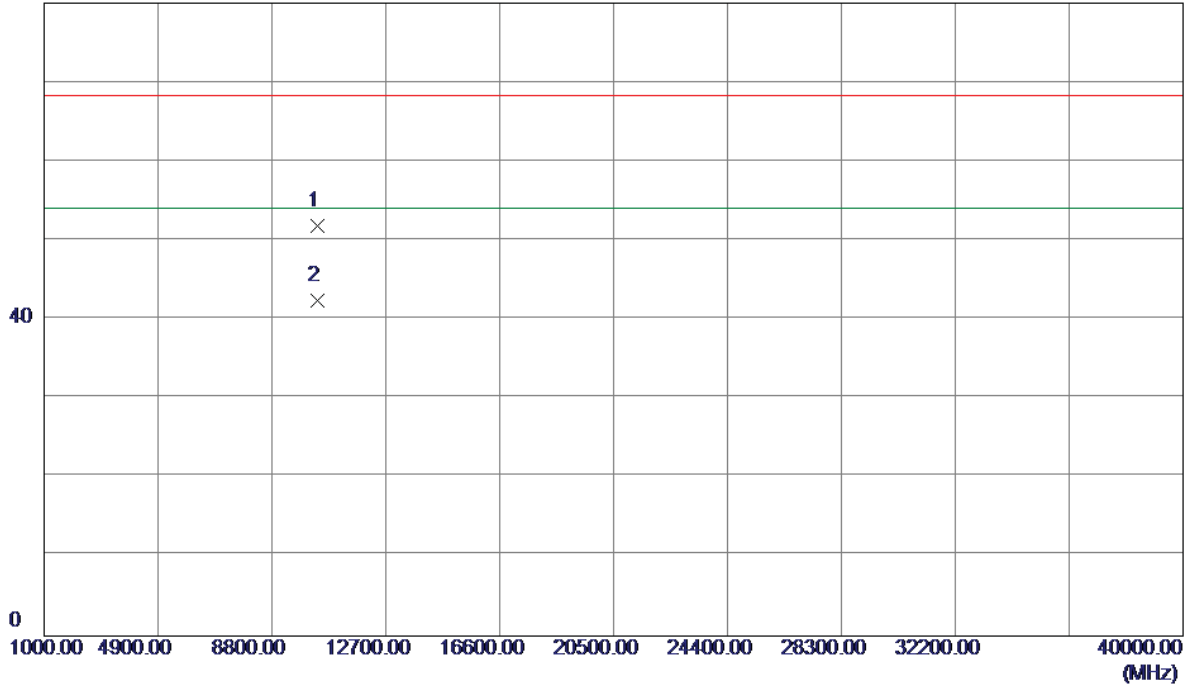

No.	Freq. MHz	Reading Level dBuV/m	Correct Factor dB	Measure ment dBuV/m	Limit dBuV/m	Margin dB	Detector	Comment
1	10359.6900	34.71	17.10	51.81	68.30	-16.49	Peak	
2 *	10359.8300	25.33	17.10	42.43	54.00	-11.57	AVG	

Orthogonal Axis:	X
Test Mode:	UNII-1/ TX N20 Mode 5200MHz

Vertical

130 dBuV/m

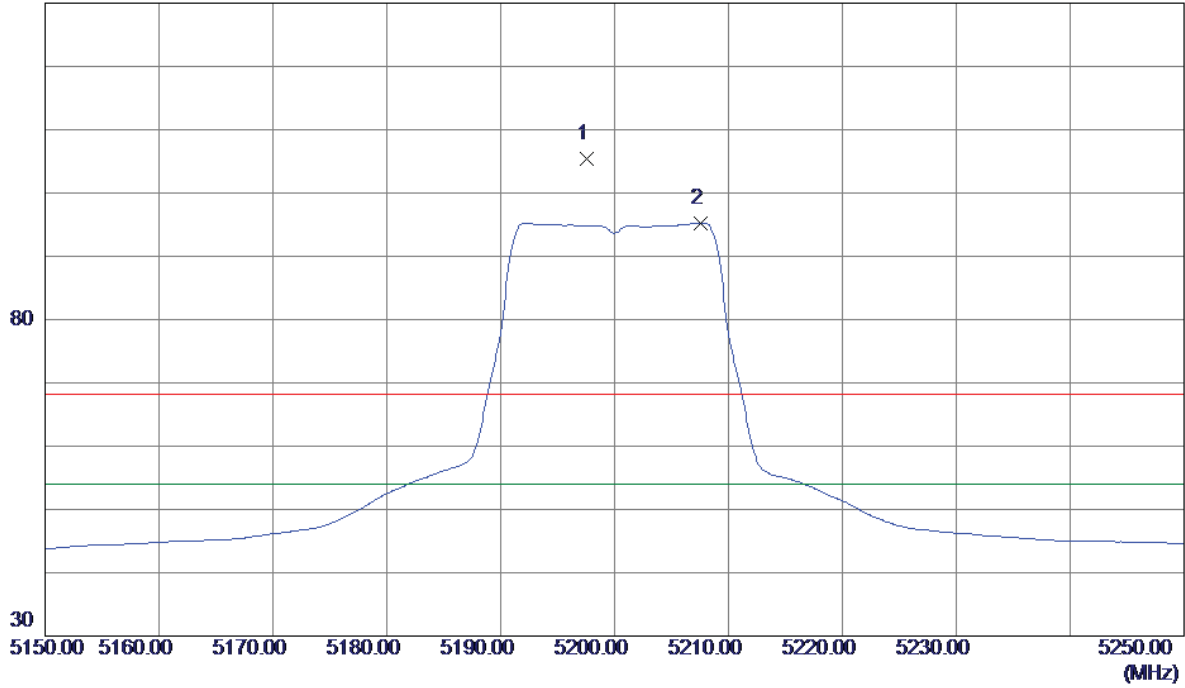

No.	Freq. MHz	Reading Level dBuV/m	Correct Factor dB	Measure ment dBuV/m	Limit dBuV/m	Margin dB	Detector	Comment
1	5197.6000	64.09	41.34	105.43	68.30	37.13	Peak	No Limit
2 *	5207.6000	53.89	41.39	95.28	54.00	41.28	AVG	No Limit

Orthogonal Axis:	X
Test Mode:	UNII-1/ TX N20 Mode 5200MHz

Vertical

80 dBuV/m

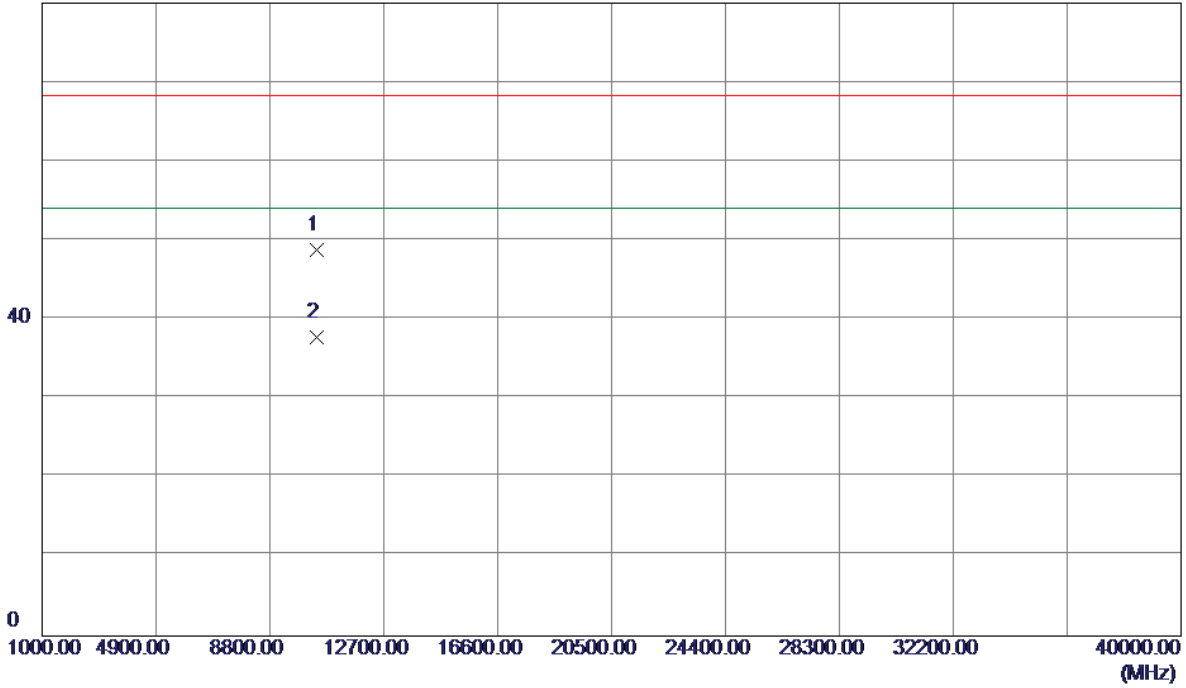

No.	Freq. MHz	Reading Level dBuV/m	Correct Factor dB	Measure ment dBuV/m	Limit dBuV/m	Margin dB	Detector	Comment
1	10400.5180	31.51	17.22	48.73	68.30	-19.57	Peak	
2 *	10400.7380	20.54	17.22	37.76	54.00	-16.24	AVG	

Orthogonal Axis:	X
Test Mode:	UNII-1/ TX N20 Mode 5200MHz

Horizontal

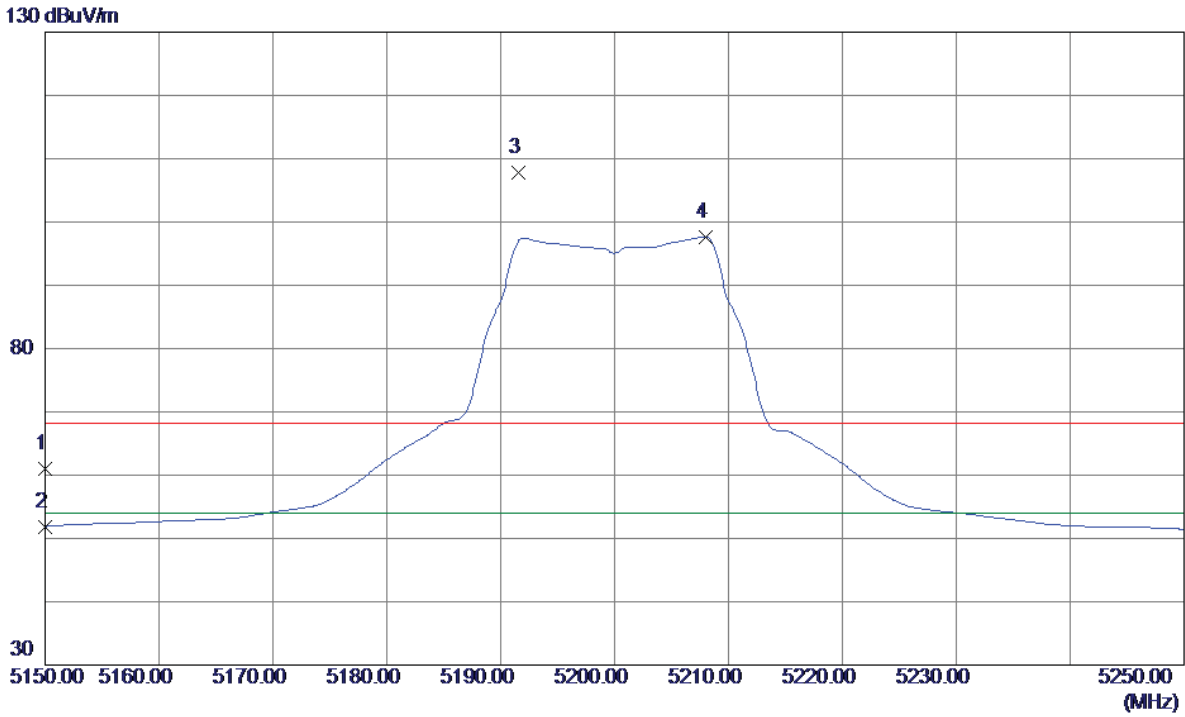

No.	Freq. MHz	Reading Level dBuV/m	Correct Factor dB	Measure ment dBuV/m	Limit dBuV/m	Margin dB	Detector	Comment
1	5150.0000	19.98	41.10	61.08	68.30	-7.22	Peak	
2	5150.0000	10.78	41.10	51.88	54.00	-2.12	AVG	
3	5191.6000	66.49	41.31	107.80	68.30	39.50	Peak	No Limit
4 *	5208.0000	56.23	41.40	97.63	54.00	43.63	AVG	No Limit

Orthogonal Axis:	X
Test Mode:	UNII-1/ TX N20 Mode 5200MHz

Horizontal

80 dBuV/m

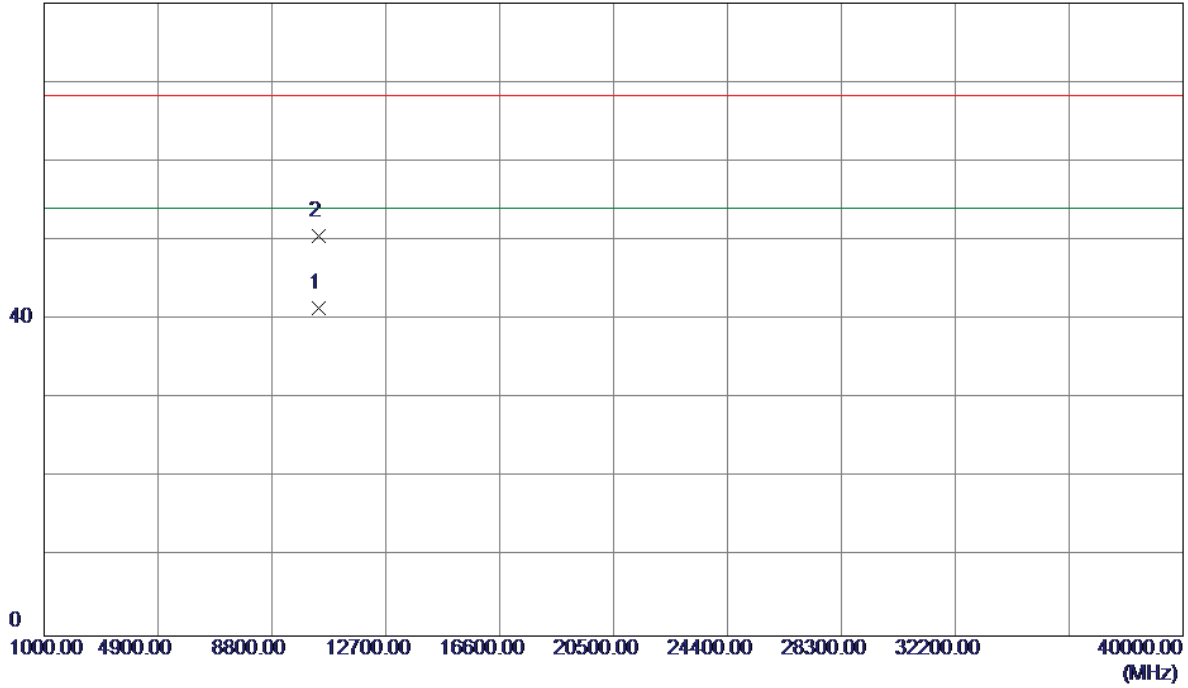

No.	Freq. MHz	Reading Level dBuV/m	Correct Factor dB	Measure ment dBuV/m	Limit dBuV/m	Margin dB	Detector	Comment
1 *	10399.8640	24.17	17.22	41.39	54.00	-12.61	AVG	
2	10399.9840	33.31	17.22	50.53	68.30	-17.77	Peak	

Orthogonal Axis:	X
Test Mode:	UNII-1/ TX N20 Mode 5240MHz

Vertical

130 dBuV/m

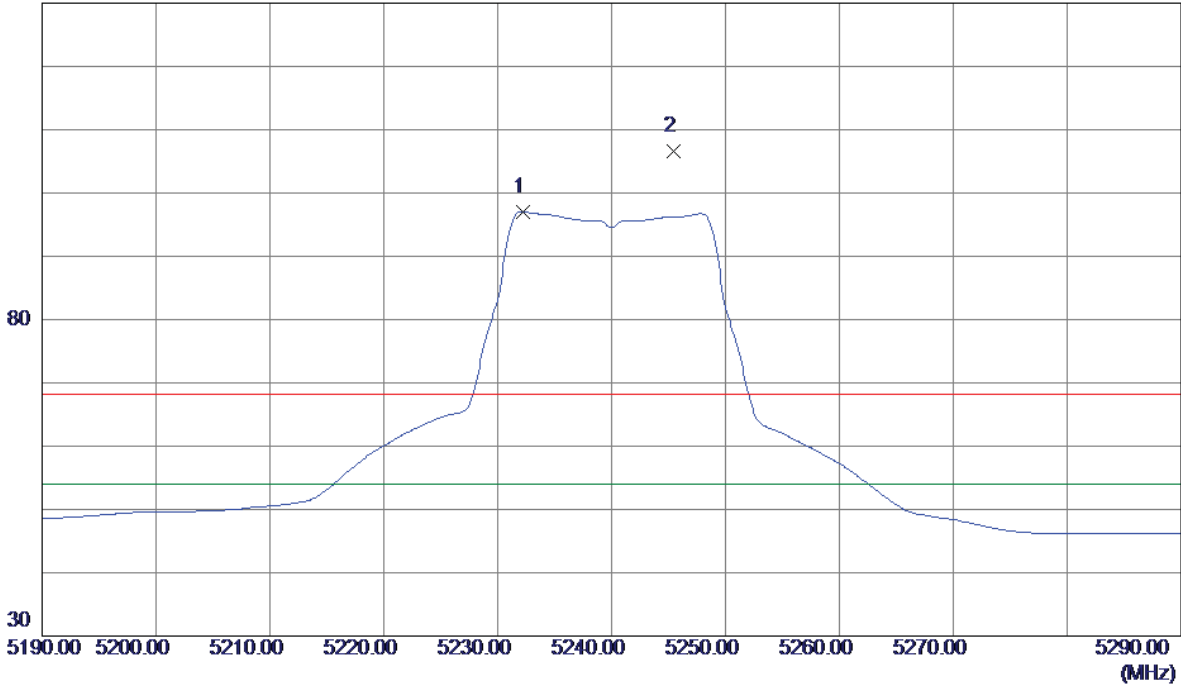

No.	Freq. MHz	Reading Level dBuV/m	Correct Factor dB	Measure ment dBuV/m	Limit dBuV/m	Margin dB	Detector	Comment
1 *	5232.2000	55.51	41.52	97.03	54.00	43.03	AVG	No Limit
2	5245.4000	65.07	41.59	106.66	68.30	38.36	Peak	No Limit

Orthogonal Axis:	X
Test Mode:	UNII-1/ TX N20 Mode 5240MHz

Vertical

80 dBuV/m

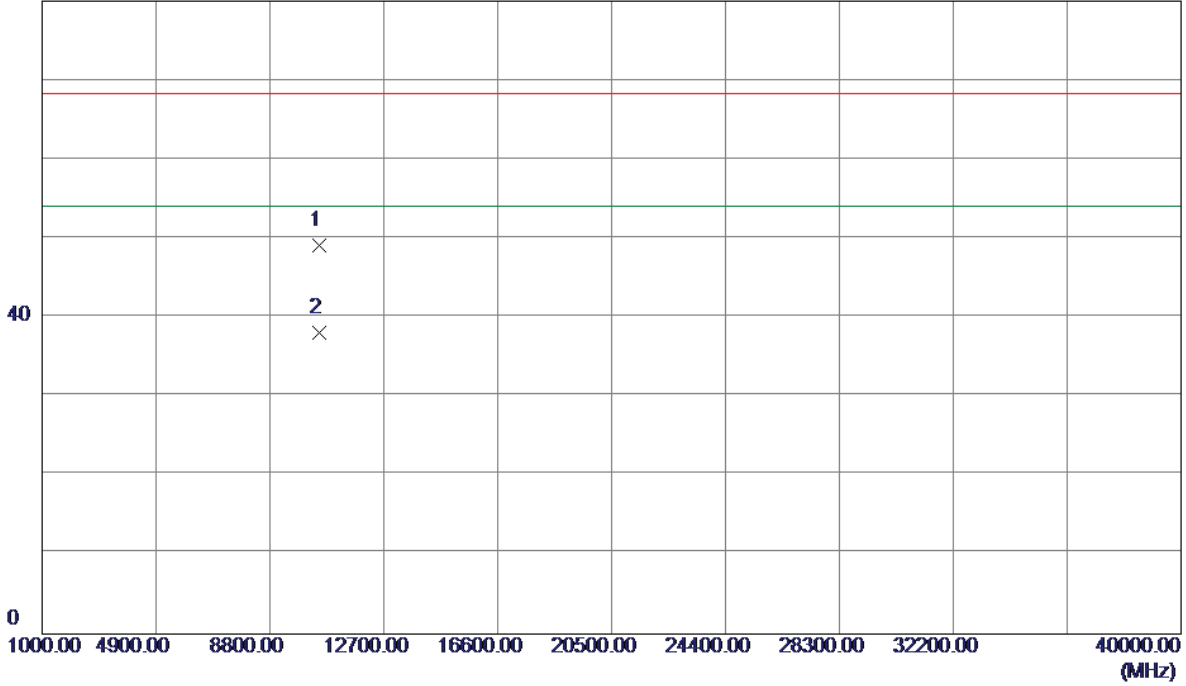

No.	Freq. MHz	Reading Level dBuV/m	Correct Factor dB	Measure ment dBuV/m	Limit dBuV/m	Margin dB	Detector	Comment
1	10479.3259	31.64	17.44	49.08	68.30	-19.22	Peak	
2 *	10479.8300	20.66	17.44	38.10	54.00	-15.90	AVG	

Orthogonal Axis:	X
Test Mode:	UNII-1/ TX N20 Mode 5240MHz

Horizontal

130 dBuV/m

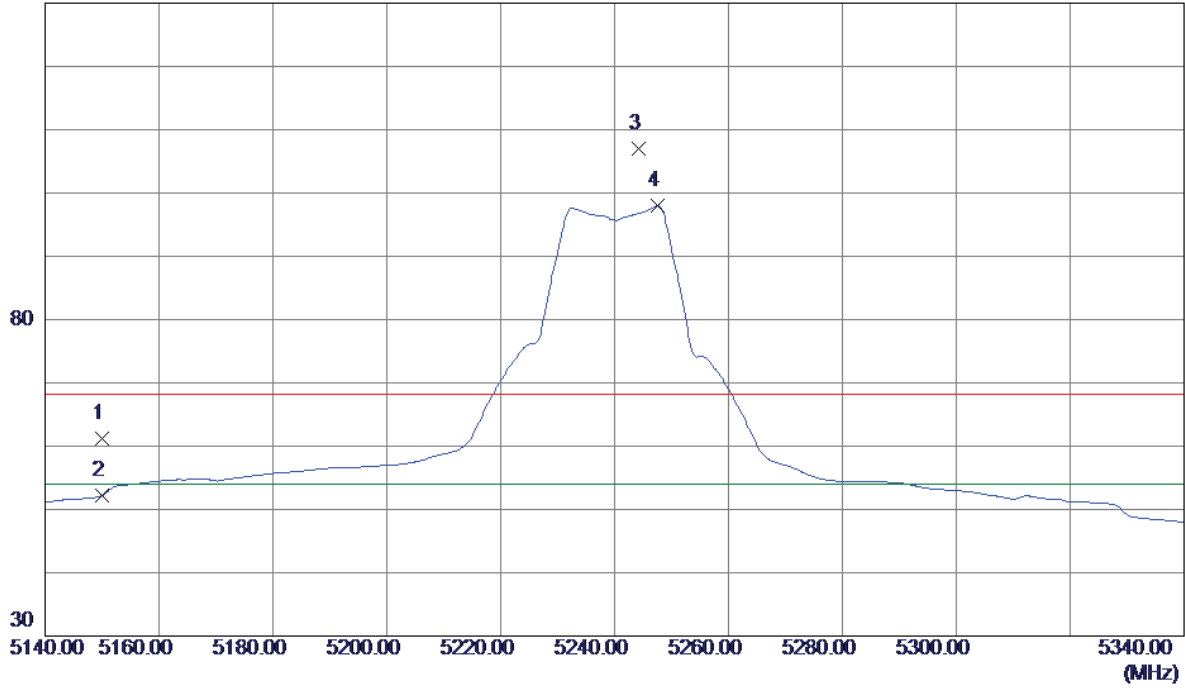

No.	Freq. MHz	Reading Level dBuV/m	Correct Factor dB	Measure ment dBuV/m	Limit dBuV/m	Margin dB	Detector	Comment
1	5150.0000	20.05	41.10	61.15	68.30	-7.15	Peak	
2	5150.0000	11.10	41.10	52.20	54.00	-1.80	AVG	
3	5244.2000	65.36	41.58	106.94	68.30	38.64	Peak	No Limit
4 *	5247.6000	56.34	41.60	97.94	54.00	43.94	AVG	No Limit

Orthogonal Axis:	X
Test Mode:	UNII-1/ TX N20 Mode 5240MHz

Horizontal

80 dBuV/m

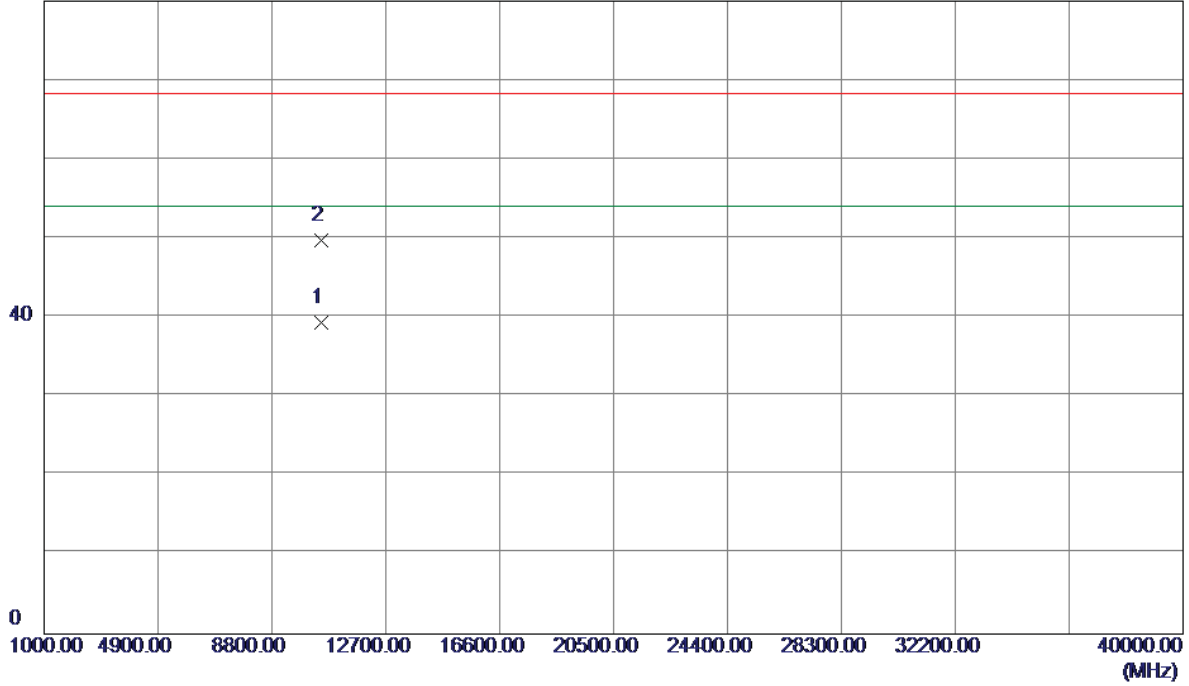

No.	Freq. MHz	Reading Level dBuV/m	Correct Factor dB	Measure ment dBuV/m	Limit dBuV/m	Margin dB	Detector	Comment
1 *	10479.6980	21.92	17.44	39.36	54.00	-14.64	AVG	
2	10480.0279	32.29	17.44	49.73	68.30	-18.57	Peak	

Orthogonal Axis:	X
Test Mode:	UNII-1/ TX N40 Mode 5190MHz

Vertical

130 dBuV/m

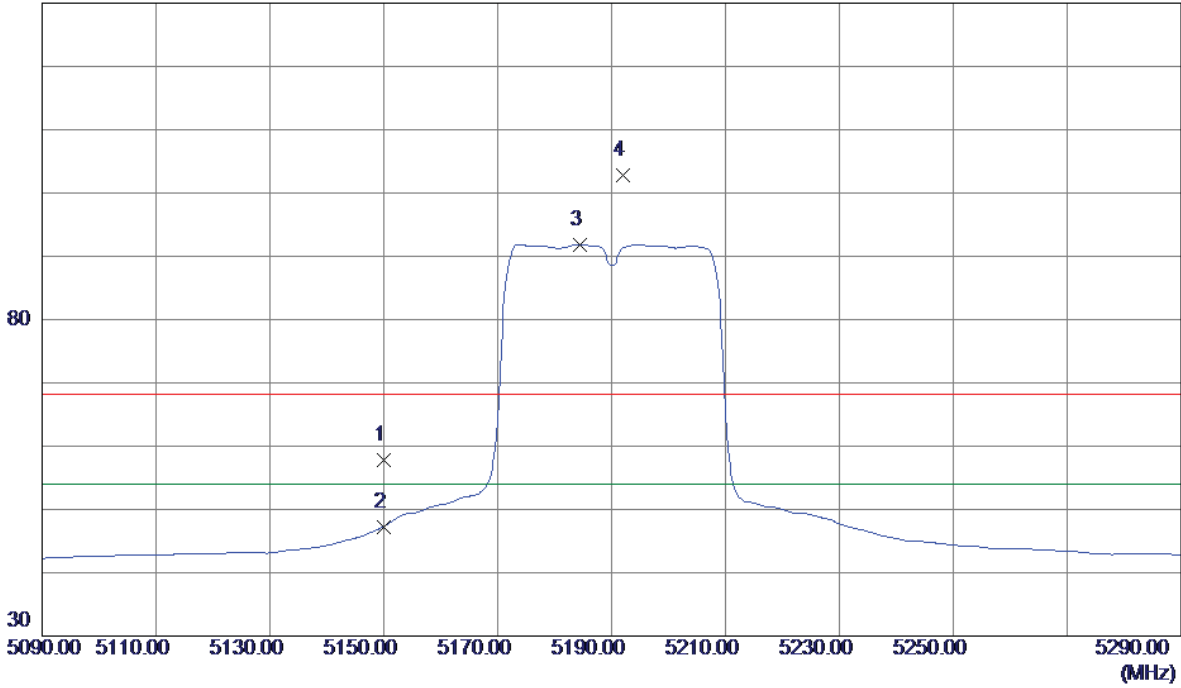

No.	Freq. MHz	Reading Level dBuV/m	Correct Factor dB	Measure ment dBuV/m	Limit dBuV/m	Margin dB	Detector	Comment
1	5150.0000	16.70	41.10	57.80	68.30	-10.50	Peak	
2	5150.0000	6.19	41.10	47.29	54.00	-6.71	AVG	
3 *	5184.4000	50.58	41.28	91.86	54.00	37.86	AVG	No Limit
4	5192.0000	61.57	41.32	102.89	68.30	34.59	Peak	No Limit

Orthogonal Axis:	X
Test Mode:	UNII-1/ TX N40 Mode 5190MHz

Vertical

80 dBuV/m

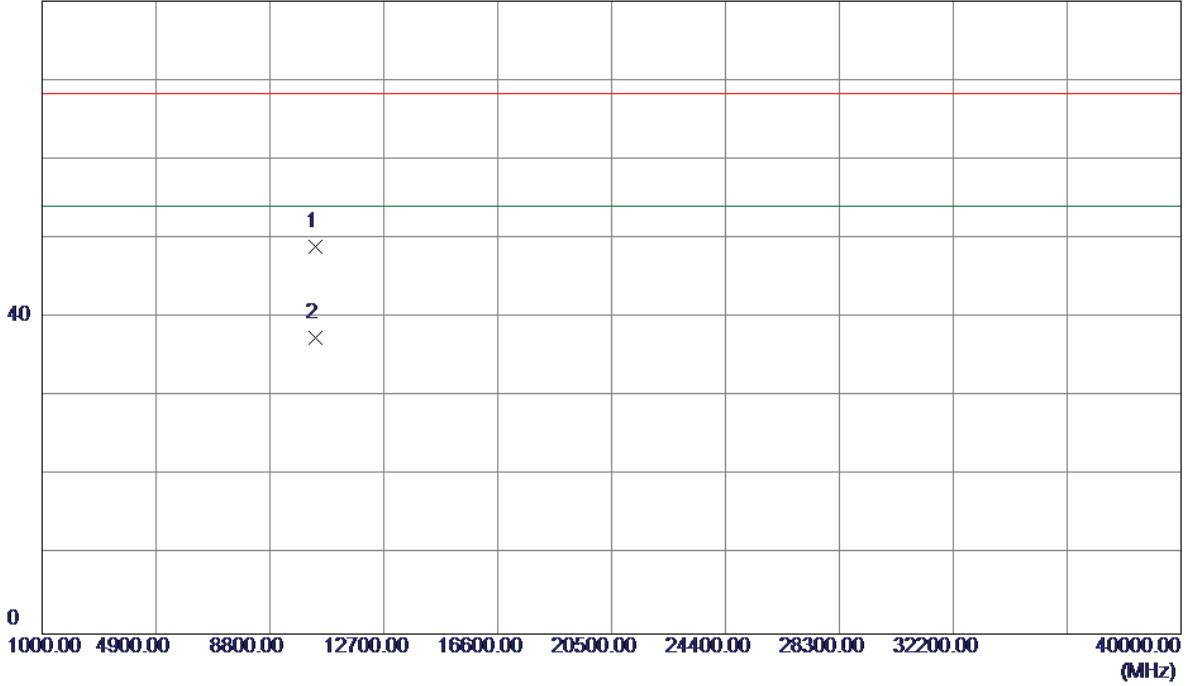

No.	Freq. MHz	Reading Level dBuV/m	Correct Factor dB	Measure ment dBuV/m	Limit dBuV/m	Margin dB	Detector	Comment
1	10379.5640	31.86	17.16	49.02	68.30	-19.28	Peak	
2 *	10380.0380	20.28	17.16	37.44	54.00	-16.56	AVG	

Orthogonal Axis:	X
Test Mode:	UNII-1/ TX N40 Mode 5190MHz

Horizontal

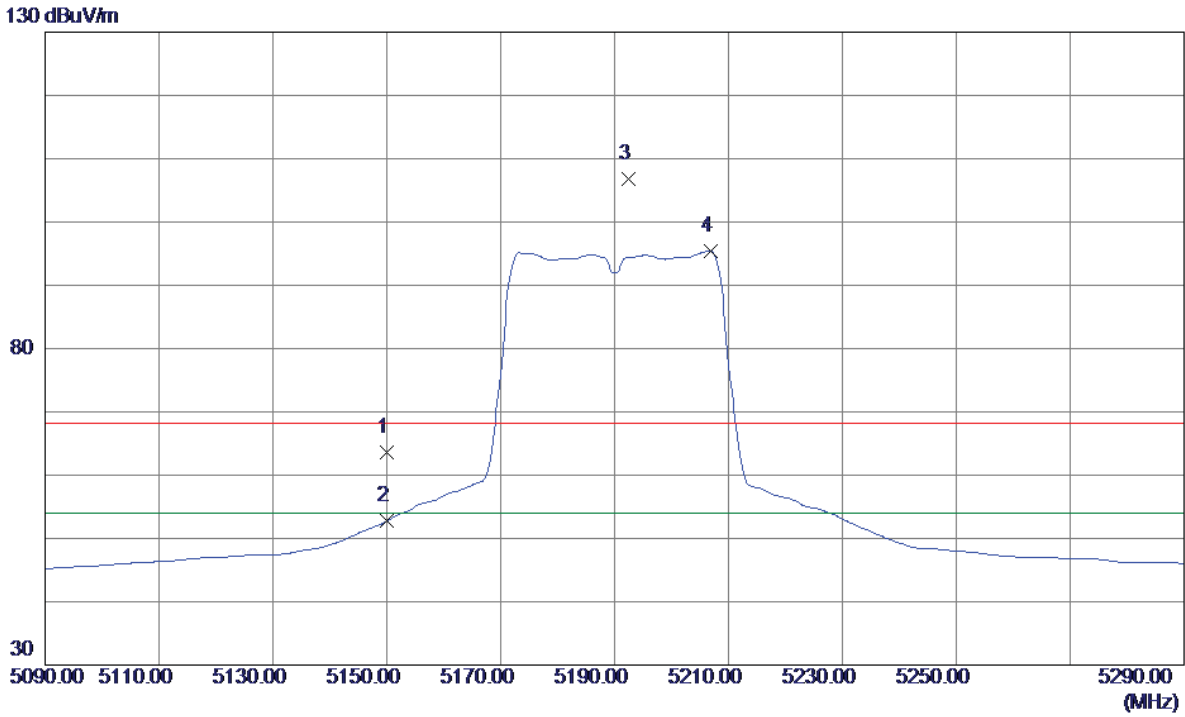

No.	Freq. MHz	Reading Level dBuV/m	Correct Factor dB	Measure ment dBuV/m	Limit dBuV/m	Margin dB	Detector	Comment
1	5150.0000	22.54	41.10	63.64	68.30	-4.66	Peak	
2	5150.0000	11.62	41.10	52.72	54.00	-1.28	AVG	
3	5192.4000	65.39	41.32	106.71	68.30	38.41	Peak	No Limit
4 *	5206.8000	54.02	41.39	95.41	54.00	41.41	AVG	No Limit

Orthogonal Axis:	X
Test Mode:	UNII-1/ TX N40 Mode 5190MHz

Horizontal

80 dBuV/m

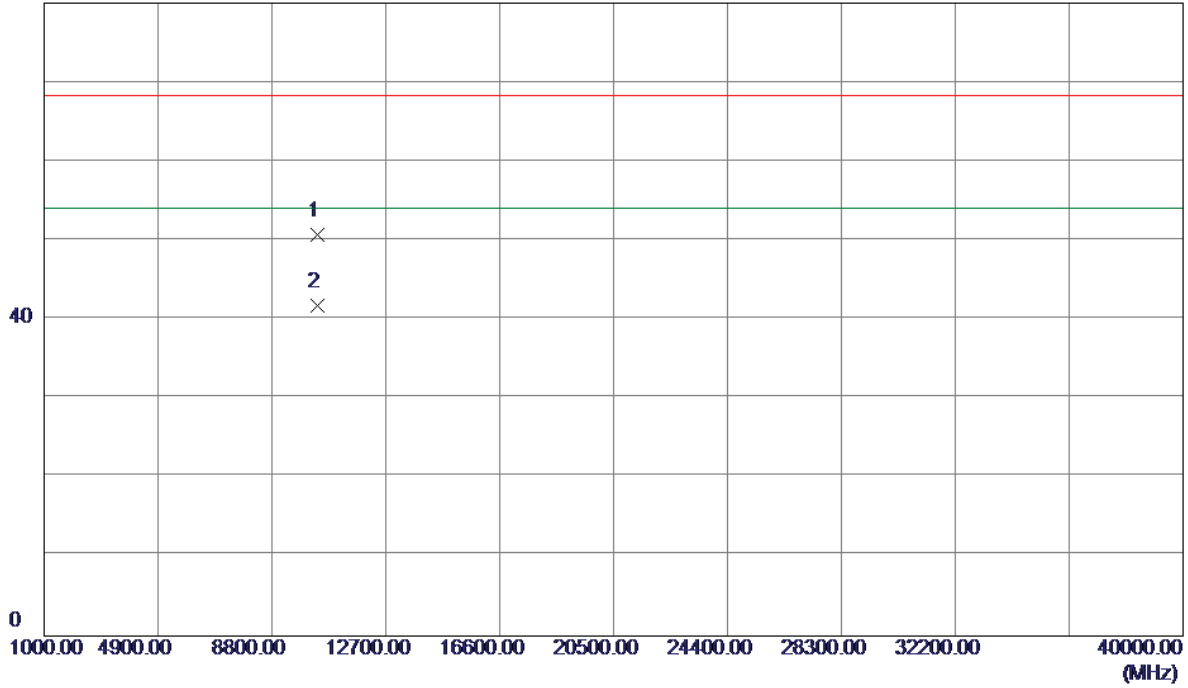

No.	Freq. MHz	Reading Level dBuV/m	Correct Factor dB	Measure ment dBuV/m	Limit dBuV/m	Margin dB	Detector	Comment
1	10379.5780	33.48	17.16	50.64	68.30	-17.66	Peak	
2 *	10379.8120	24.52	17.16	41.68	54.00	-12.32	AVG	

Orthogonal Axis:	X
Test Mode:	UNII-1/ TX N40 Mode 5230MHz

Vertical

130 dBuV/m

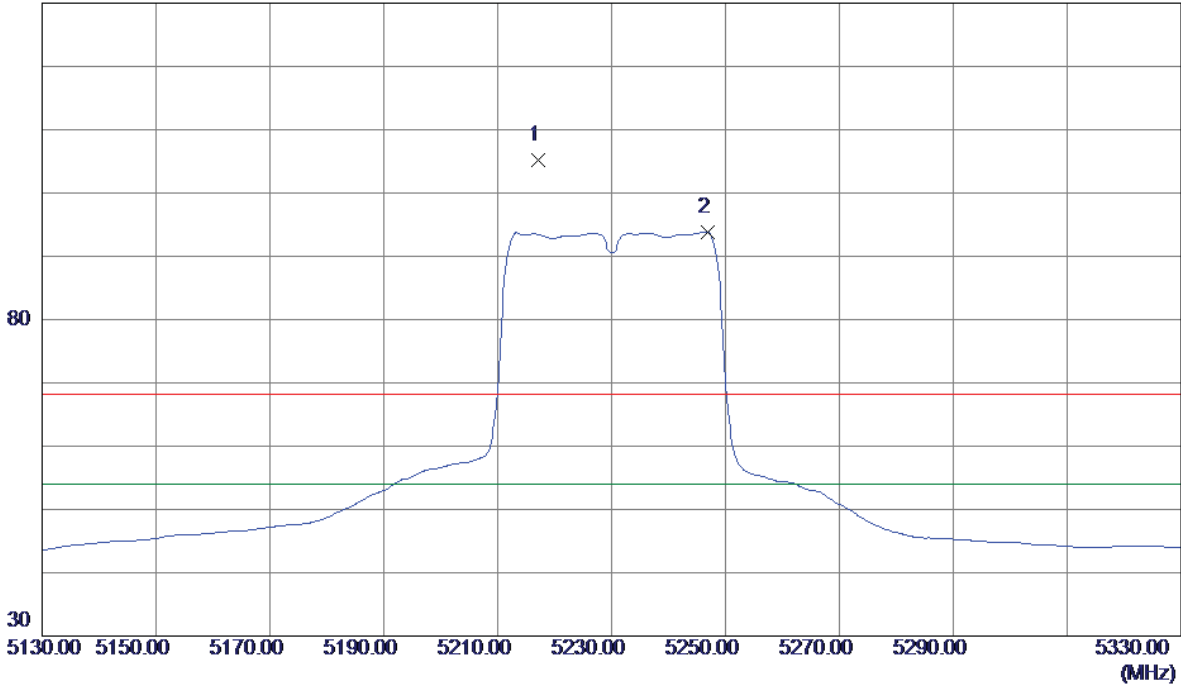

No.	Freq. MHz	Reading Level dBuV/m	Correct Factor dB	Measure ment dBuV/m	Limit dBuV/m	Margin dB	Detector	Comment
1	5217.2000	63.67	41.44	105.11	68.30	36.81	Peak	No Limit
2 *	5246.8000	52.30	41.59	93.89	54.00	39.89	AVG	No Limit

Orthogonal Axis:	X
Test Mode:	UNII-1/ TX N40 Mode 5230MHz

Vertical

80 dBuV/m

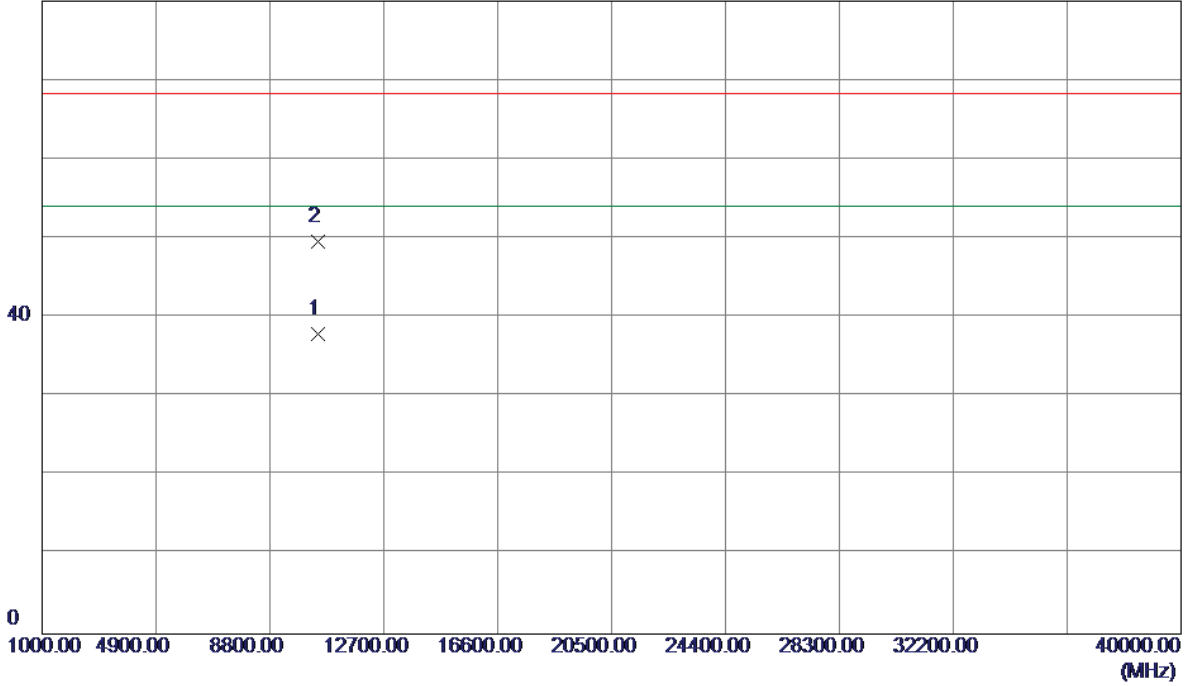

No.	Freq. MHz	Reading Level dBuV/m	Correct Factor dB	Measure ment dBuV/m	Limit dBuV/m	Margin dB	Detector	Comment
1 *	10459.1880	20.48	17.38	37.86	54.00	-16.14	AVG	
2	10459.7140	32.24	17.39	49.63	68.30	-18.67	Peak	

Orthogonal Axis:	X
Test Mode:	UNII-1/ TX N40 Mode 5230MHz

Horizontal

130 dBuV/m

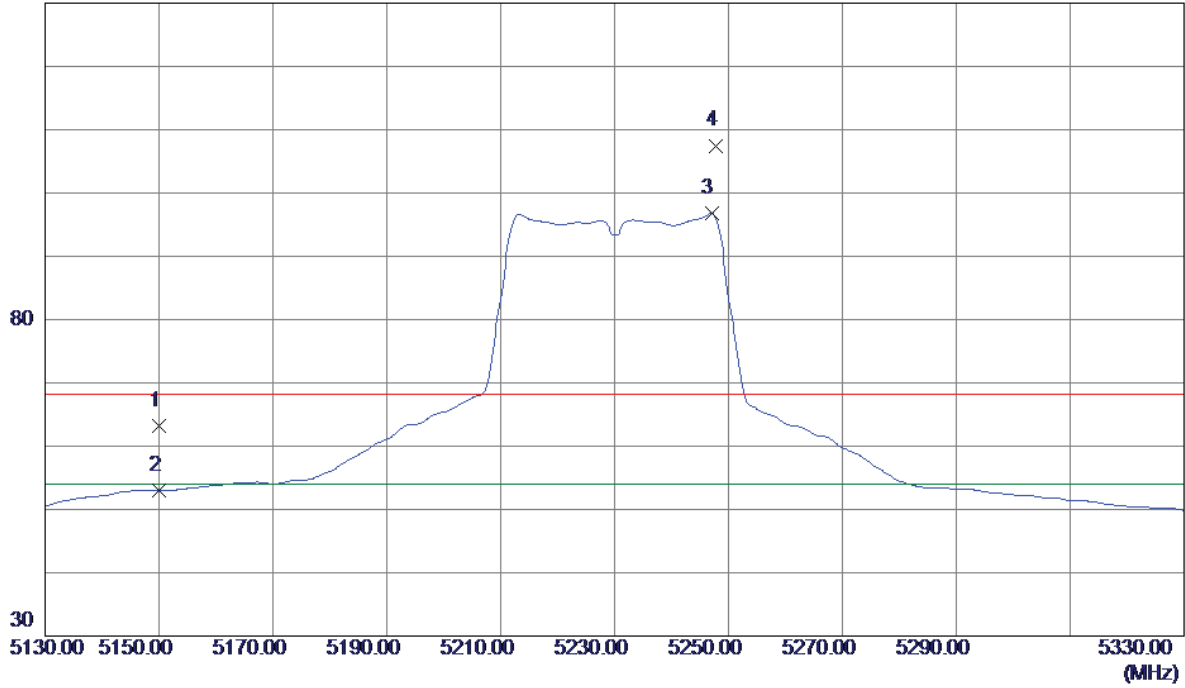

No.	Freq. MHz	Reading Level dBuV/m	Correct Factor dB	Measure ment dBuV/m	Limit dBuV/m	Margin dB	Detector	Comment
1	5150.0000	22.08	41.10	63.18	68.30	-5.12	Peak	
2	5150.0000	11.82	41.10	52.92	54.00	-1.08	AVG	
3 *	5247.0000	55.25	41.59	96.84	54.00	42.84	AVG	No Limit
4	5247.8000	65.90	41.60	107.50	68.30	39.20	Peak	No Limit

Orthogonal Axis:	X
Test Mode:	UNII-1/ TX N40 Mode 5230MHz

Horizontal

80 dBuV/m

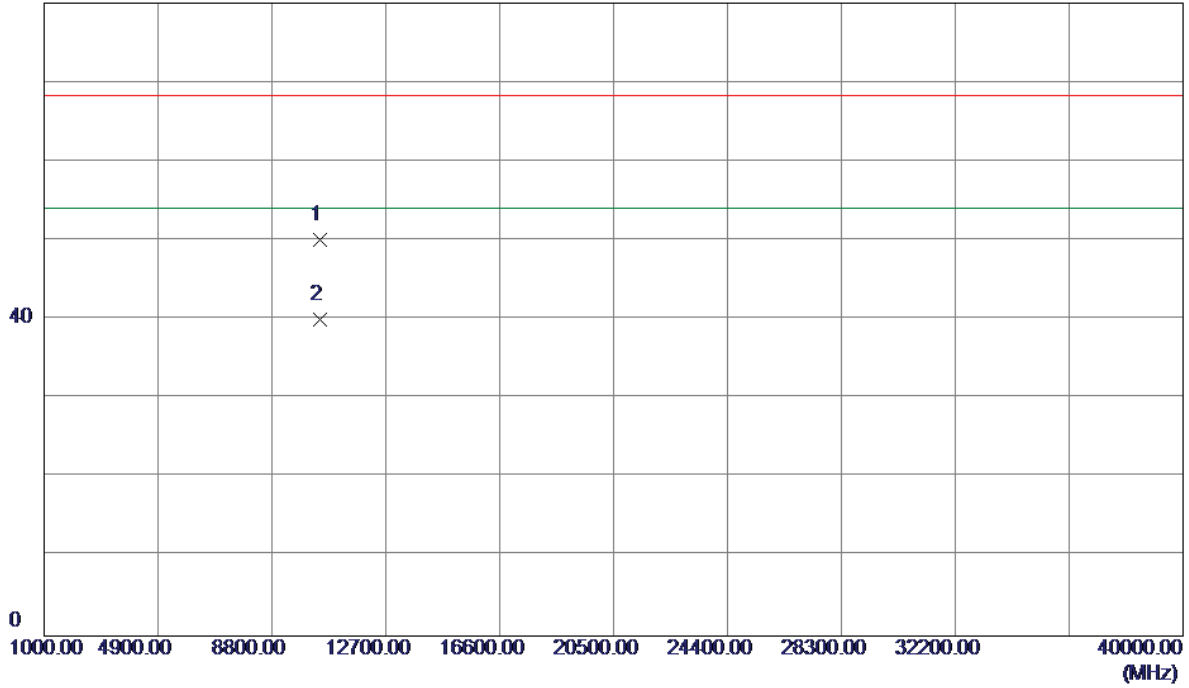

No.	Freq. MHz	Reading Level dBuV/m	Correct Factor dB	Measure ment dBuV/m	Limit dBuV/m	Margin dB	Detector	Comment
1	10459.5220	32.72	17.39	50.11	68.30	-18.19	Peak	
2 *	10459.8520	22.59	17.39	39.98	54.00	-14.02	AVG	

Orthogonal Axis:	X
Test Mode:	UNII-3/TX A Mode 5745MHz

Vertical

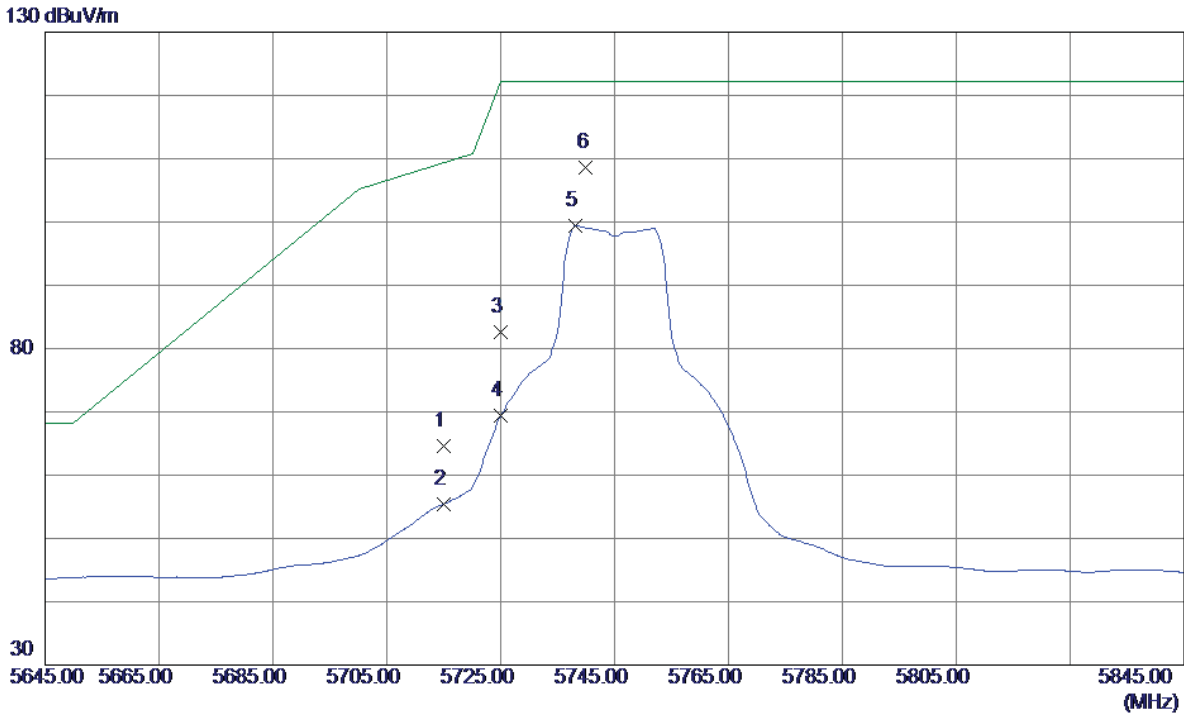

No.	Freq. MHz	Reading Level dBuV/m	Correct Factor dB	Measure ment dBuV/m	Limit dBuV/m	Margin dB	Detector	Comment
1	5715.0000	21.13	43.53	64.66	109.40	-44.74	Peak	
2	5715.0000	11.92	43.53	55.45	109.40	-53.95	AVG	
3	5725.0000	39.11	43.56	82.67	122.20	-39.53	Peak	
4	5725.0000	25.86	43.56	69.42	122.20	-52.78	AVG	
5	5738.2000	55.86	43.60	99.46	122.20	-22.74	AVG	
6 *	5740.0000	64.92	43.60	108.52	122.20	-13.68	Peak	

Orthogonal Axis:	X
Test Mode:	UNII-3/TX A Mode 5745MHz

Vertical

80 dBuV/m

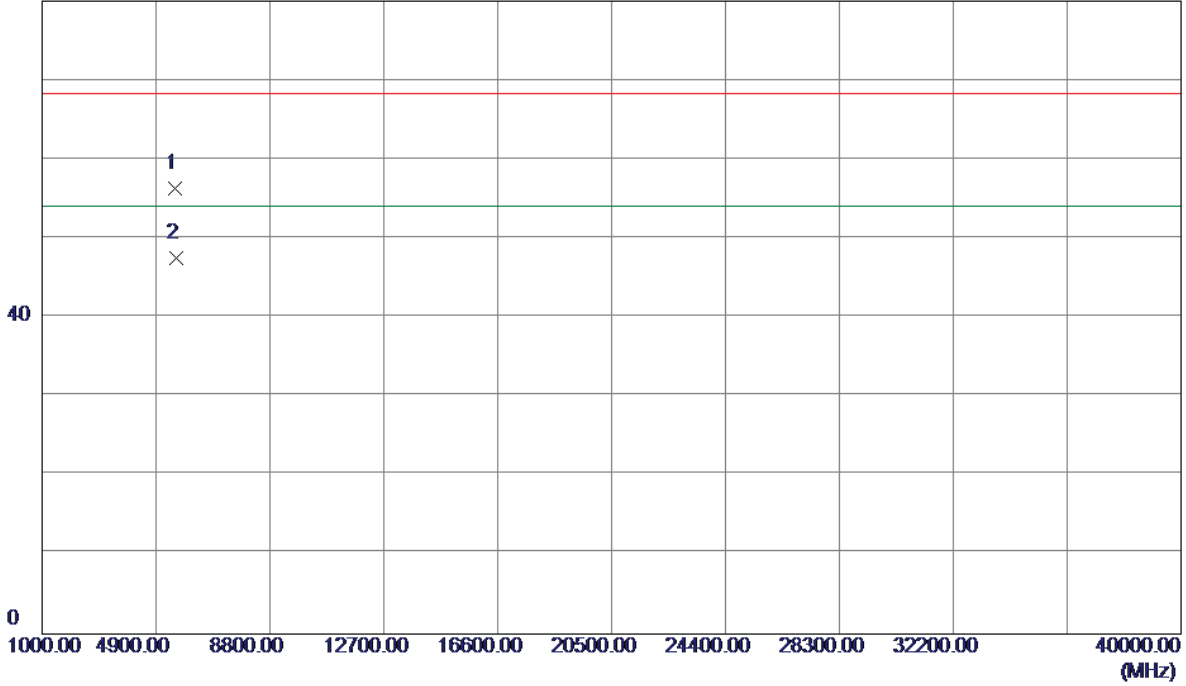

No.	Freq. MHz	Reading Level dBuV/m	Correct Factor dB	Measure ment dBuV/m	Limit dBuV/m	Margin dB	Detector	Comment
1	5570.0000	46.83	9.54	56.37	68.30	-11.93	Peak	
2 *	5572.0000	37.94	9.55	47.49	54.00	-6.51	AVG	

Orthogonal Axis:	X
Test Mode:	UNII-3/TX A Mode 5745MHz

Horizontal

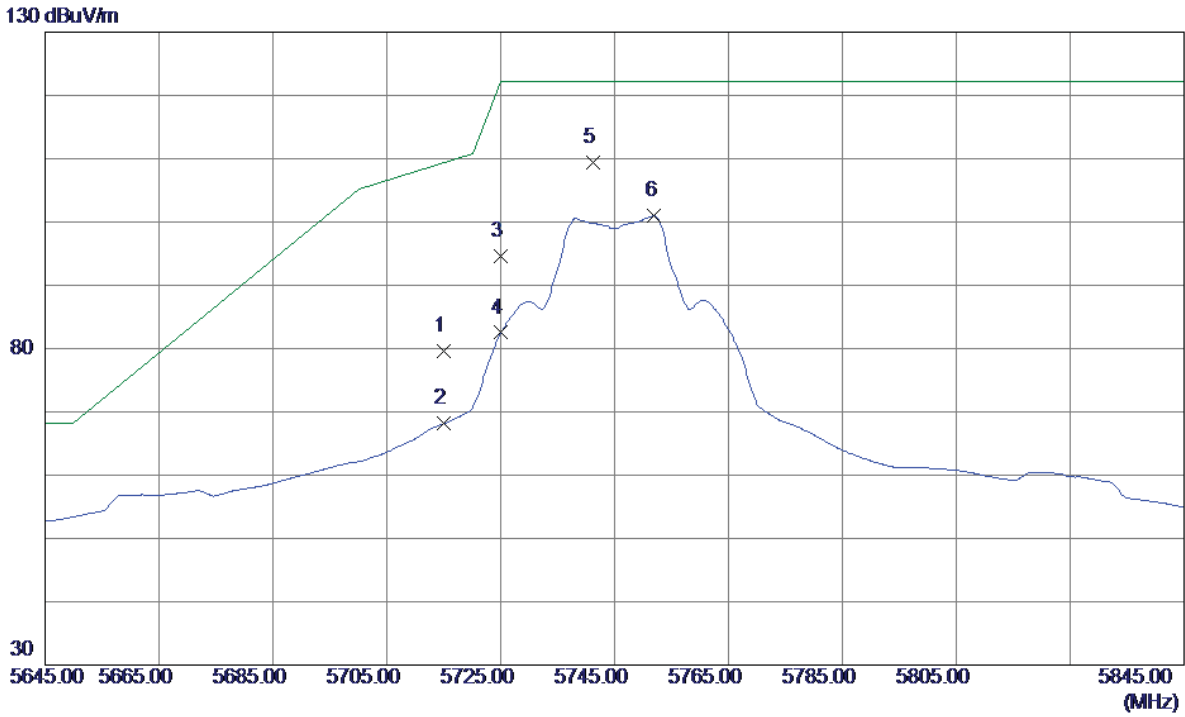

No.	Freq. MHz	Reading Level dBuV/m	Correct Factor dB	Measure ment dBuV/m	Limit dBuV/m	Margin dB	Detector	Comment
1	5715.0000	36.13	43.53	79.66	109.40	-29.74	Peak	
2	5715.0000	24.60	43.53	68.13	109.40	-41.27	AVG	
3	5725.0000	51.12	43.56	94.68	122.20	-27.52	Peak	
4	5725.0000	38.94	43.56	82.50	122.20	-39.70	AVG	
5 *	5741.2000	65.85	43.61	109.46	122.20	-12.74	Peak	
6	5752.0000	57.35	43.64	100.99	122.20	-21.21	AVG	

Orthogonal Axis:	X
Test Mode:	UNII-3/TX A Mode 5745MHz

Horizontal

80 dBuV/m

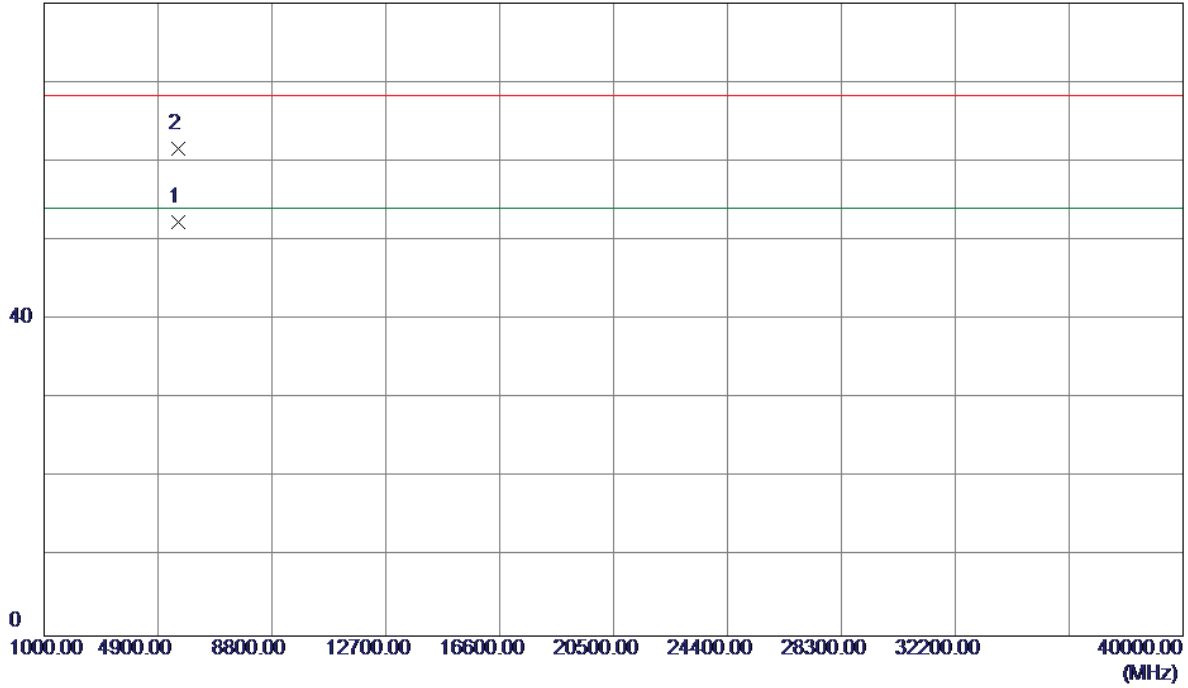

No.	Freq. MHz	Reading Level dBuV/m	Correct Factor dB	Measure ment dBuV/m	Limit dBuV/m	Margin dB	Detector	Comment
1 *	5577.8000	42.74	9.56	52.30	54.00	-1.70	AVG	
2	5578.8000	52.08	9.57	61.65	68.30	-6.65	Peak	

Orthogonal Axis:	X
Test Mode:	UNII-3/TX A Mode 5785MHz

Vertical

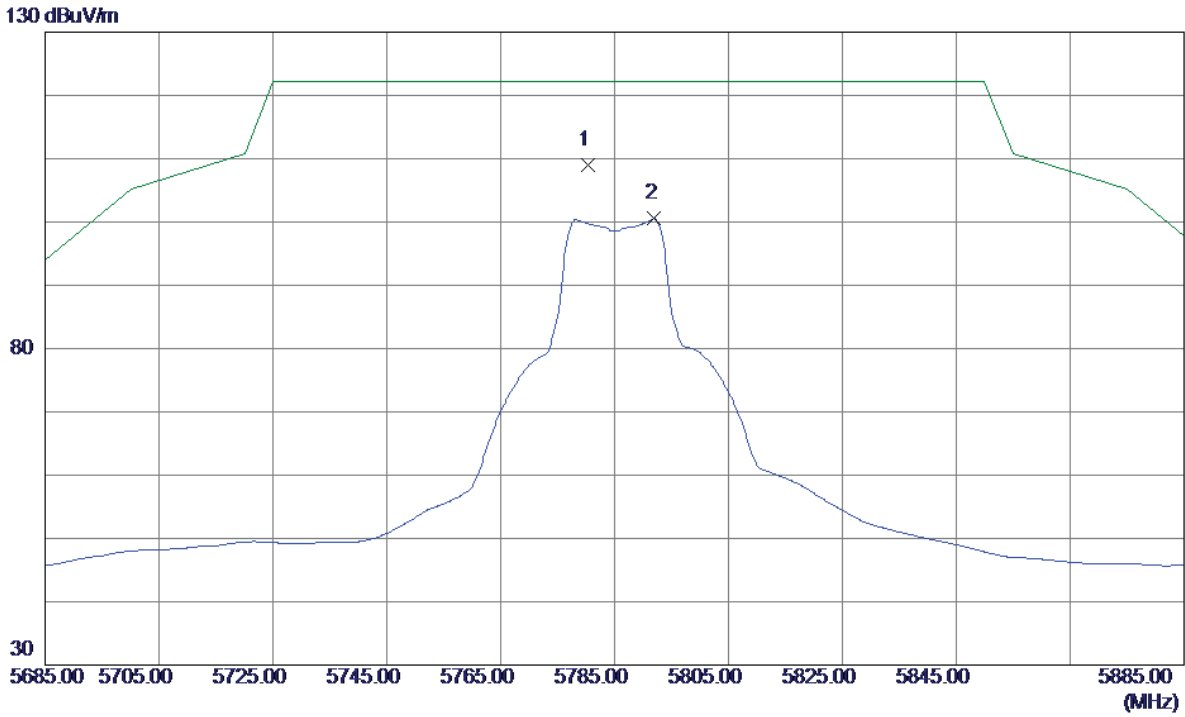

No.	Freq. MHz	Reading Level dBuV/m	Correct Factor dB	Measure ment dBuV/m	Limit dBuV/m	Margin dB	Detector	Comment
1 *	5780.4000	65.34	43.73	109.07	122.20	-13.13	Peak	
2	5792.0000	56.75	43.76	100.51	122.20	-21.69	AVG	

Orthogonal Axis:	X
Test Mode:	UNII-3/TX A Mode 5785MHz

Vertical

80 dBuV/m

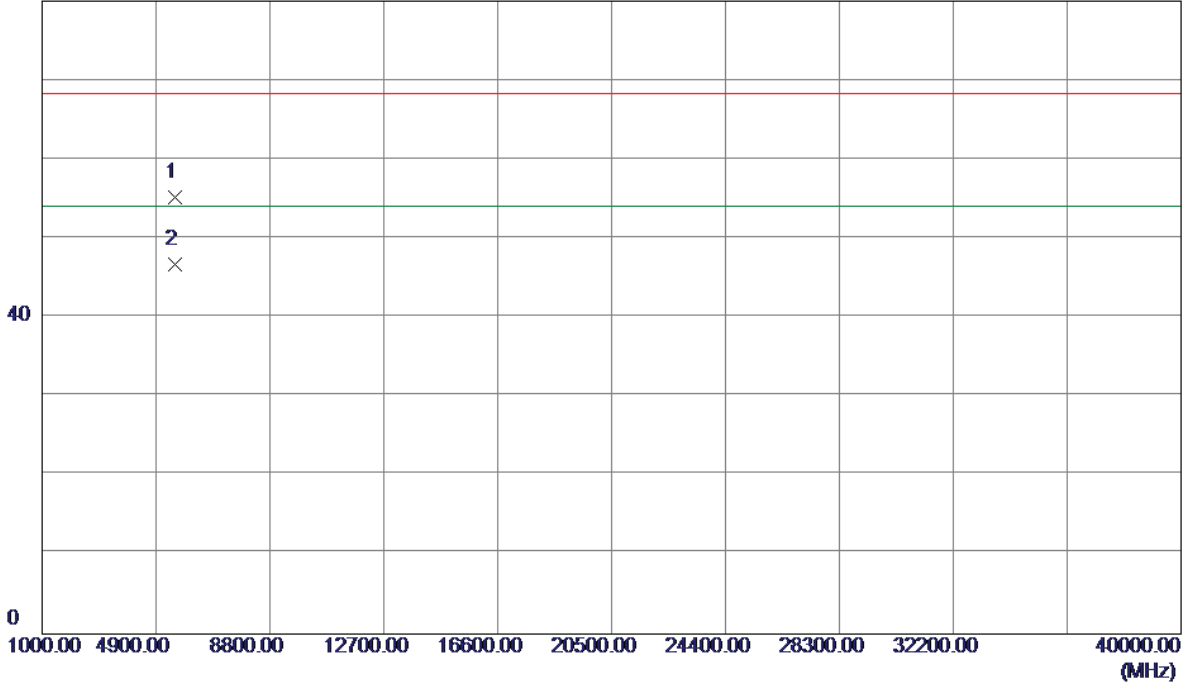

No.	Freq. MHz	Reading Level dBuV/m	Correct Factor dB	Measure ment dBuV/m	Limit dBuV/m	Margin dB	Detector	Comment
1	5550.5000	45.71	9.48	55.19	68.30	-13.11	Peak	
2 *	5551.5000	37.17	9.48	46.65	54.00	-7.35	AVG	

Orthogonal Axis:	X
Test Mode:	UNII-3/TX A Mode 5785MHz

Horizontal

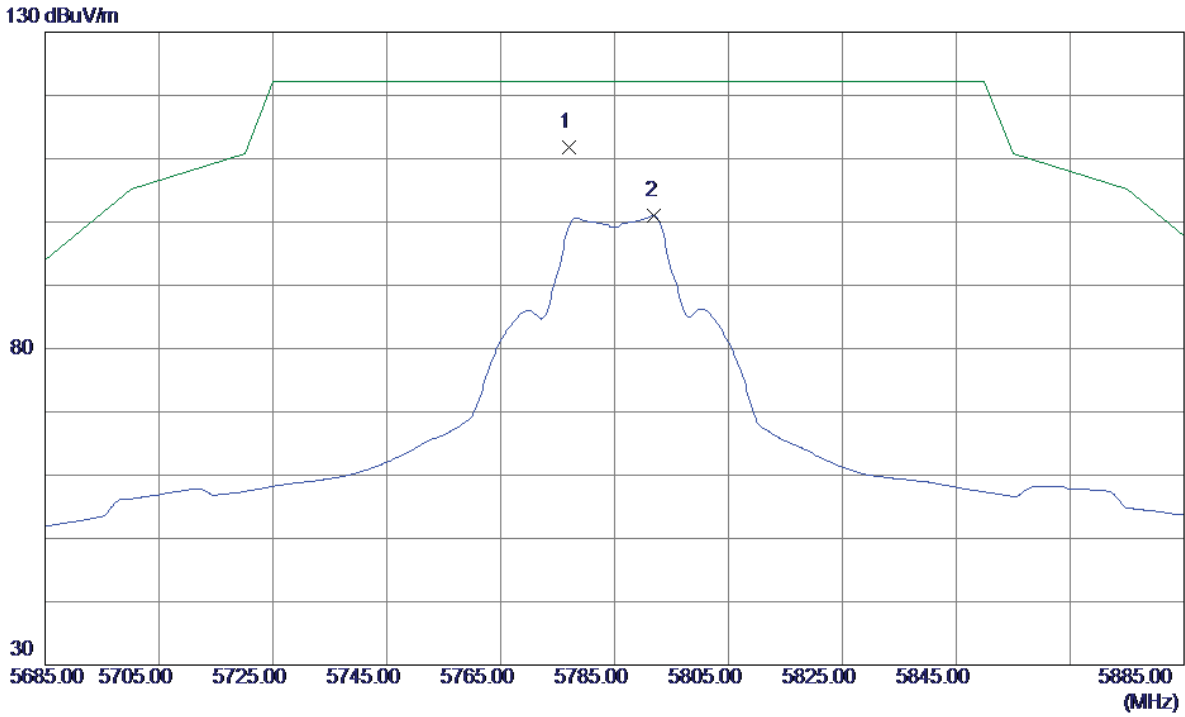

No.	Freq. MHz	Reading Level dBuV/m	Correct Factor dB	Measure ment dBuV/m	Limit dBuV/m	Margin dB	Detector	Comment
1 *	5777.0000	68.05	43.72	111.77	122.20	-10.43	Peak	
2	5792.0000	57.24	43.76	101.00	122.20	-21.20	AVG	

Orthogonal Axis:	X
Test Mode:	UNII-3/TX A Mode 5785MHz

Horizontal

80 dBuV/m

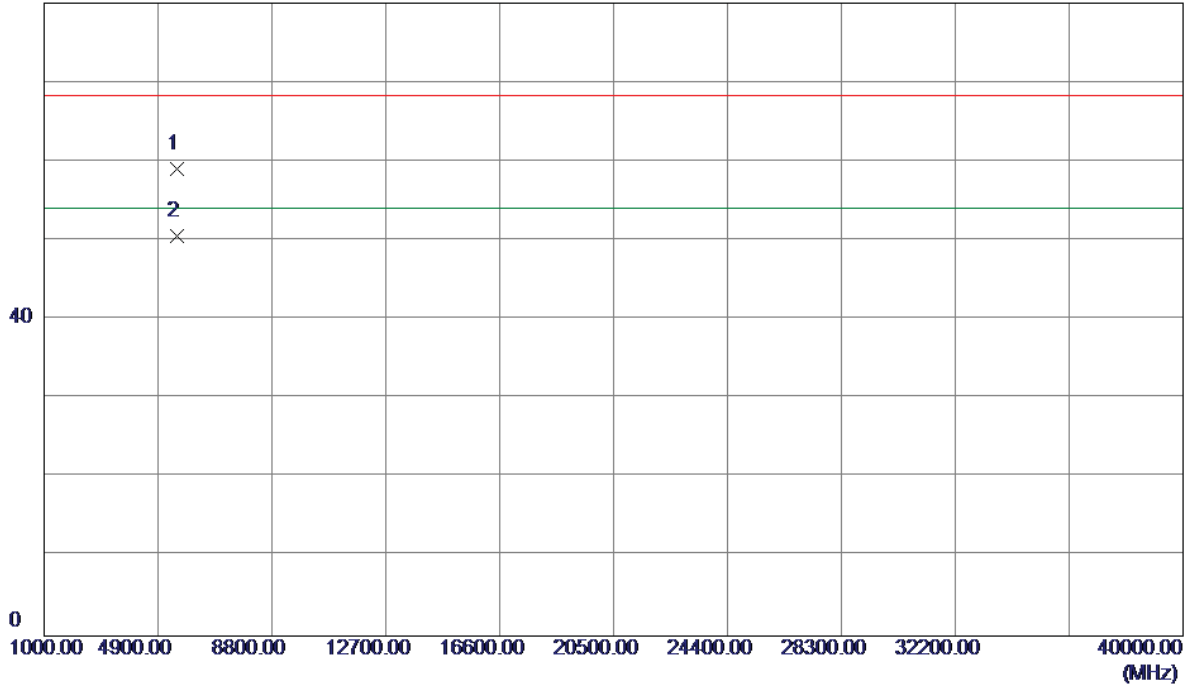

No.	Freq. MHz	Reading Level dBuV/m	Correct Factor dB	Measure ment dBuV/m	Limit dBuV/m	Margin dB	Detector	Comment
1	5550.4500	49.55	9.48	59.03	68.30	-9.27	Peak	
2 *	5551.7500	41.07	9.48	50.55	54.00	-3.45	AVG	

Orthogonal Axis:	X
Test Mode:	UNII-3/TX A Mode 5825MHz

Vertical

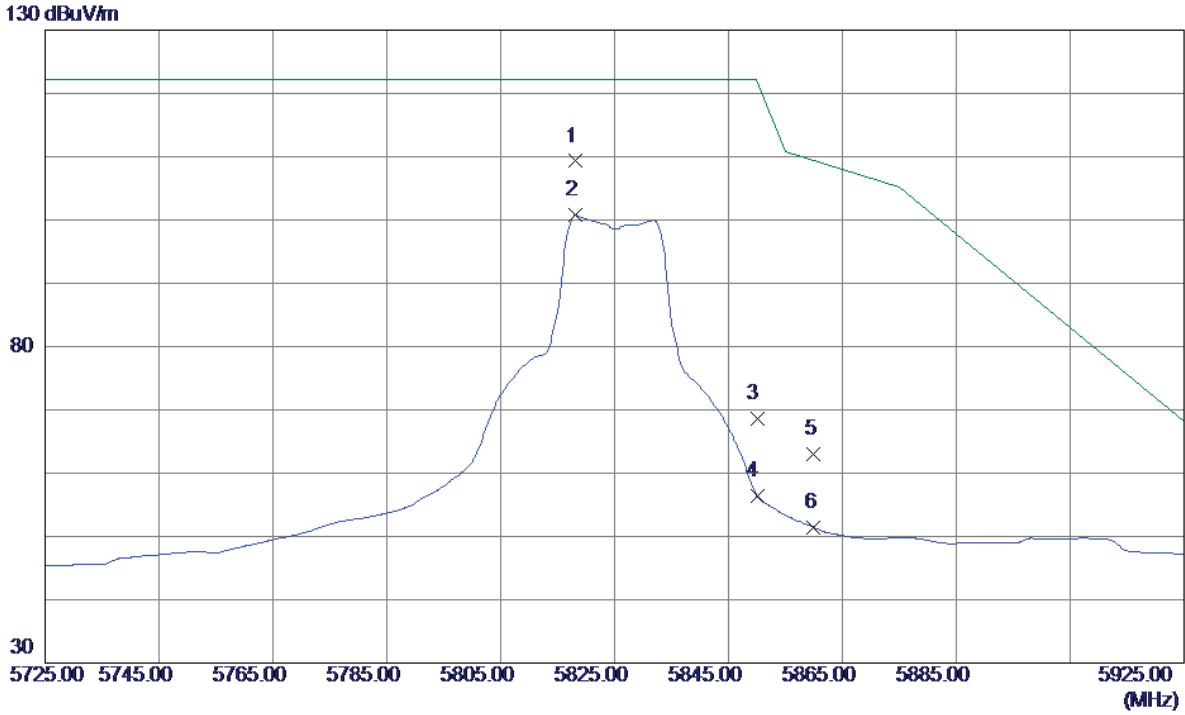

No.	Freq. MHz	Reading Level dBuV/m	Correct Factor dB	Measure ment dBuV/m	Limit dBuV/m	Margin dB	Detector	Comment
1 *	5818.2000	65.46	43.84	109.30	122.20	-12.90	Peak	
2	5818.2000	56.92	43.84	100.76	122.20	-21.44	AVG	
3	5850.0000	24.66	43.94	68.60	122.20	-53.60	Peak	
4	5850.0000	12.53	43.94	56.47	122.20	-65.73	AVG	
5	5860.0000	19.02	43.97	62.99	109.40	-46.41	Peak	
6	5860.0000	7.50	43.97	51.47	109.40	-57.93	AVG	

Orthogonal Axis:	X
Test Mode:	UNII-3/TX A Mode 5825MHz

Vertical

80 dBuV/m

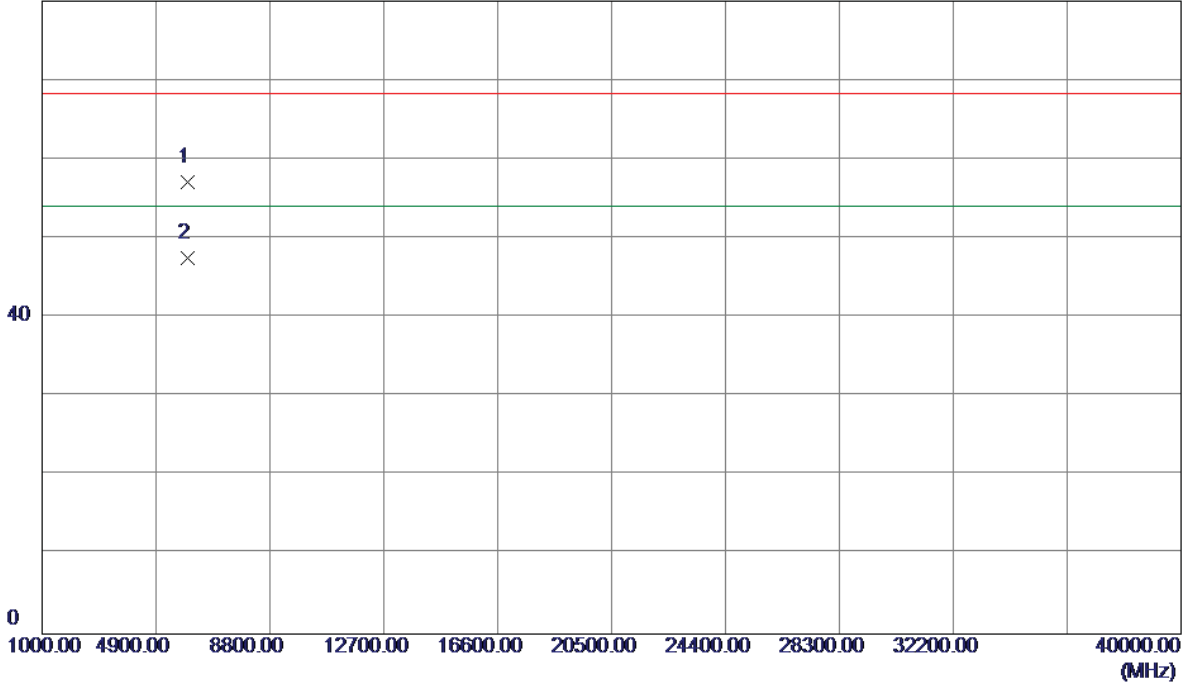

No.	Freq. MHz	Reading Level dBuV/m	Correct Factor dB	Measure ment dBuV/m	Limit dBuV/m	Margin dB	Detector	Comment
1	5991.5000	46.22	10.83	57.05	68.30	-11.25	Peak	
2 *	5991.5000	36.65	10.83	47.48	54.00	-6.52	AVG	

Orthogonal Axis:	X
Test Mode:	UNII-3/TX A Mode 5825MHz

Horizontal

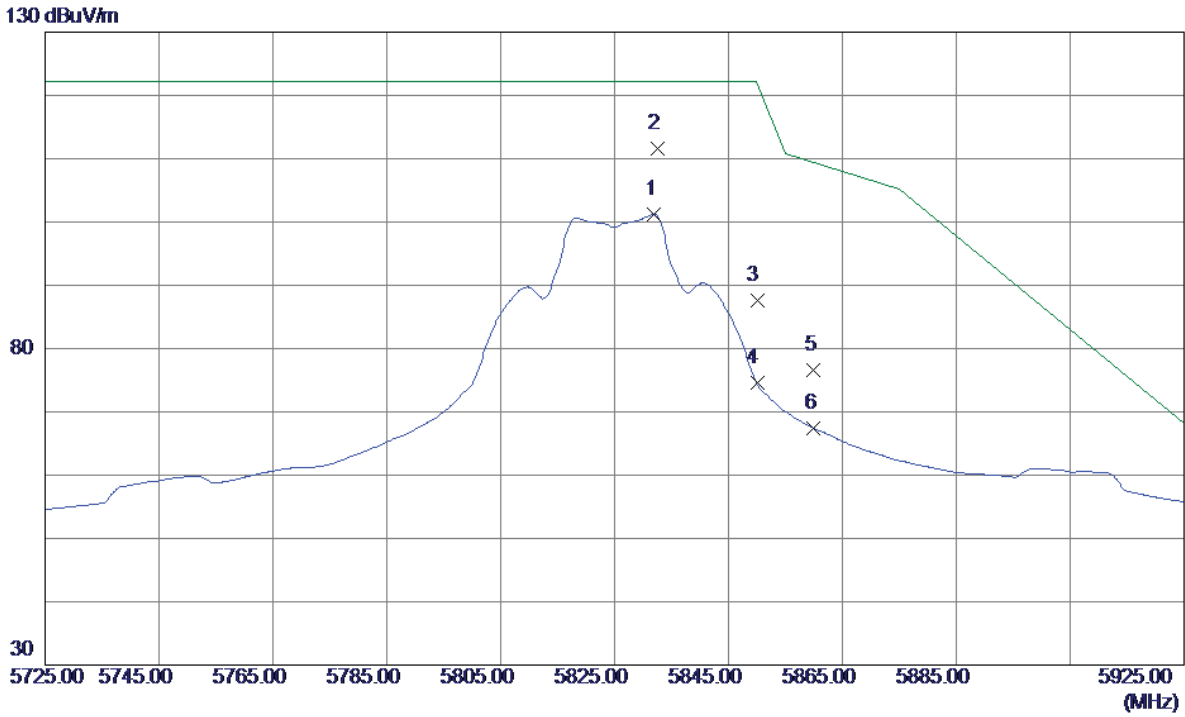

No.	Freq. MHz	Reading Level dBuV/m	Correct Factor dB	Measure ment dBuV/m	Limit dBuV/m	Margin dB	Detector	Comment
1	5832.0000	57.41	43.88	101.29	122.20	-20.91	AVG	
2 *	5832.6000	67.63	43.88	111.51	122.20	-10.69	Peak	
3	5850.0000	43.58	43.94	87.52	122.20	-34.68	Peak	
4	5850.0000	30.59	43.94	74.53	122.20	-47.67	AVG	
5	5860.0000	32.57	43.97	76.54	109.40	-32.86	Peak	
6	5860.0000	23.43	43.97	67.40	109.40	-42.00	AVG	

Orthogonal Axis:	X
Test Mode:	UNII-3/TX A Mode 5825MHz

Horizontal

80 dBuV/m

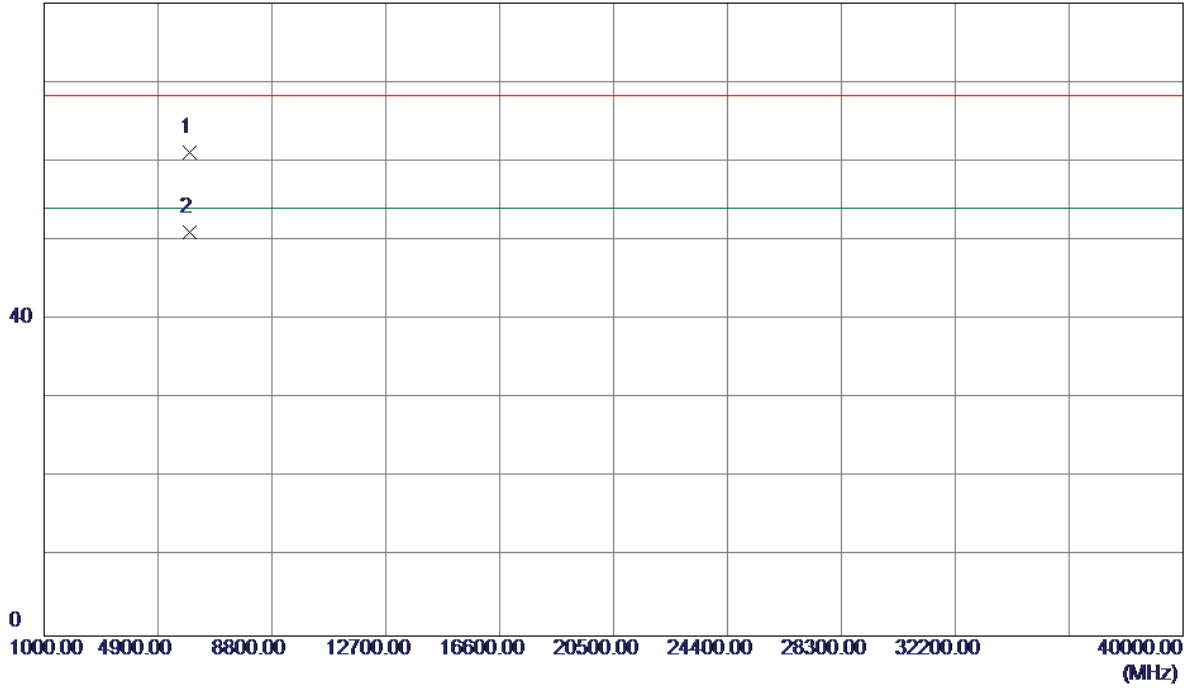

No.	Freq. MHz	Reading Level dBuV/m	Correct Factor dB	Measure ment dBuV/m	Limit dBuV/m	Margin dB	Detector	Comment
1	5991.2000	50.26	10.83	61.09	68.30	-7.21	Peak	
2 *	5991.6000	40.23	10.83	51.06	54.00	-2.94	AVG	

Orthogonal Axis:	X
Test Mode:	UNII-3/TX N20 Mode 5745MHz

Vertical

130 dBuV/m

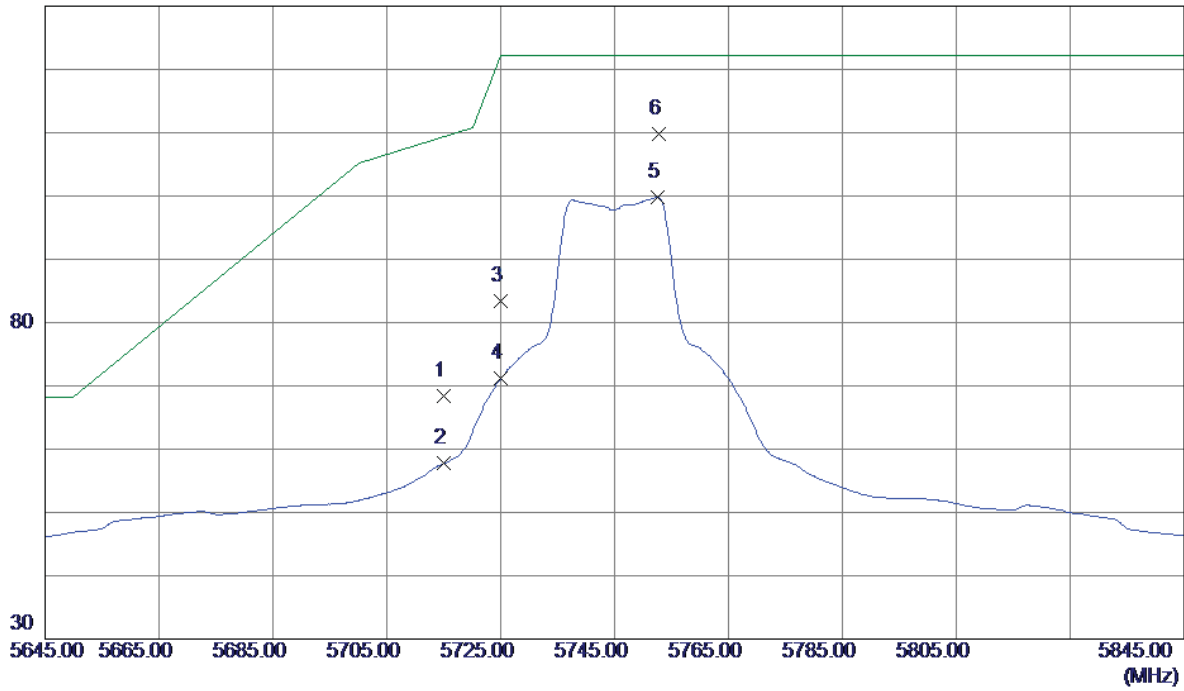

No.	Freq. MHz	Reading Level dBuV/m	Correct Factor dB	Measure ment dBuV/m	Limit dBuV/m	Margin dB	Detector	Comment
1	5715.0000	24.93	43.53	68.46	109.40	-40.94	Peak	
2	5715.0000	14.21	43.53	57.74	109.40	-51.66	AVG	
3	5725.0000	39.85	43.56	83.41	122.20	-38.79	Peak	
4	5725.0000	27.60	43.56	71.16	122.20	-51.04	AVG	
5	5752.6000	56.17	43.64	99.81	122.20	-22.39	AVG	
6 *	5752.8000	66.22	43.64	109.86	122.20	-12.34	Peak	

Orthogonal Axis:	X
Test Mode:	UNII-3/TX N20 Mode 5745MHz

Vertical

80 dBuV/m

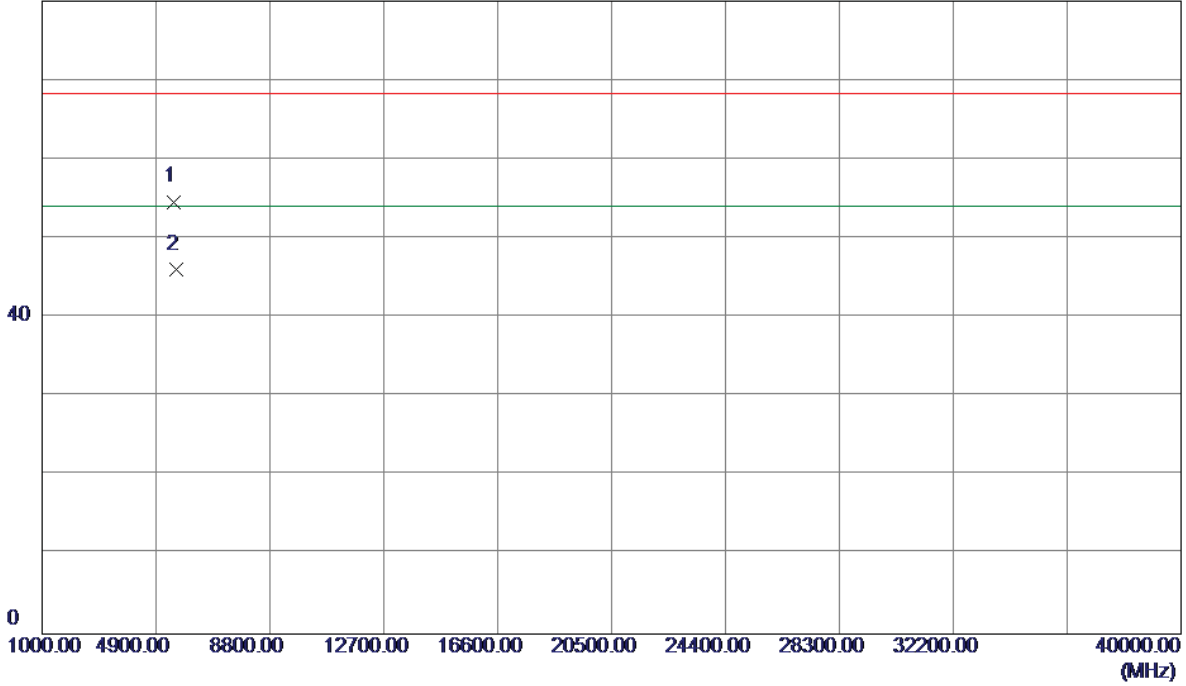

No.	Freq. MHz	Reading Level dBuV/m	Correct Factor dB	Measure ment dBuV/m	Limit dBuV/m	Margin dB	Detector	Comment
1	5513.6000	45.27	9.37	54.64	68.30	-13.66	Peak	
2 *	5577.0000	36.55	9.56	46.11	54.00	-7.89	AVG	

Orthogonal Axis:	X
Test Mode:	UNII-3/TX N20 Mode 5745MHz

Horizontal

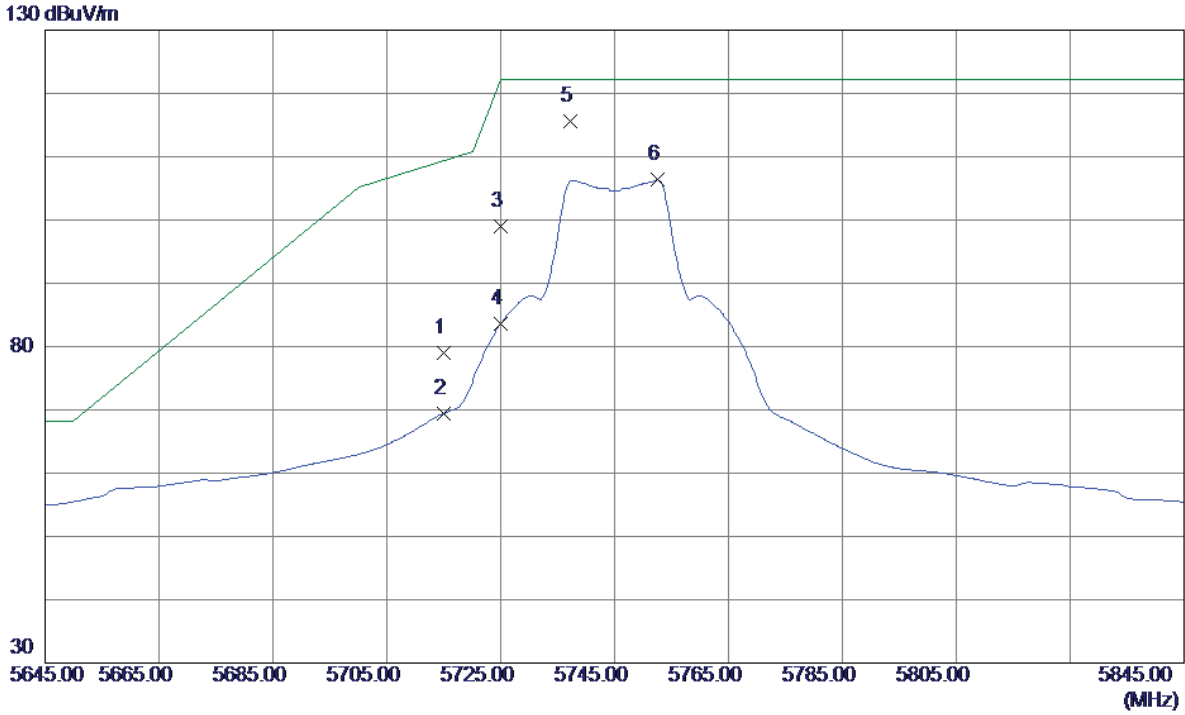

No.	Freq. MHz	Reading Level dBuV/m	Correct Factor dB	Measure ment dBuV/m	Limit dBuV/m	Margin dB	Detector	Comment
1	5715.0000	35.55	43.53	79.08	109.40	-30.32	Peak	
2	5715.0000	25.89	43.53	69.42	109.40	-39.98	AVG	
3	5725.0000	55.43	43.56	98.99	122.20	-23.21	Peak	
4	5725.0000	40.11	43.56	83.67	122.20	-38.53	AVG	
5 *	5737.2000	72.05	43.60	115.65	122.20	-6.55	Peak	
6	5752.6000	62.68	43.64	106.32	122.20	-15.88	AVG	

Orthogonal Axis:	X
Test Mode:	UNII-3/TX N20 Mode 5745MHz

Horizontal

80 dBuV/m

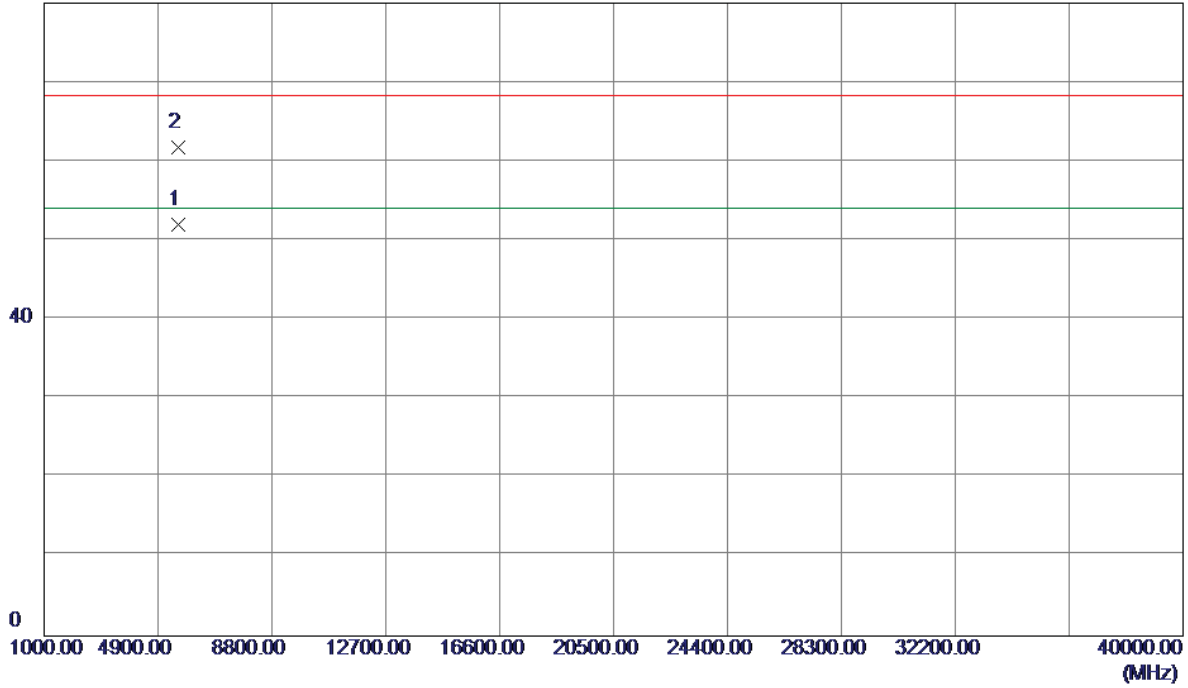

No.	Freq. MHz	Reading Level dBuV/m	Correct Factor dB	Measure ment dBuV/m	Limit dBuV/m	Margin dB	Detector	Comment
1 *	5578.0000	42.38	9.56	51.94	54.00	-2.06	AVG	
2	5584.4000	52.16	9.58	61.74	68.30	-6.56	Peak	

Orthogonal Axis:	X
Test Mode:	UNII-3/TX N20 Mode 5785MHz

Vertical

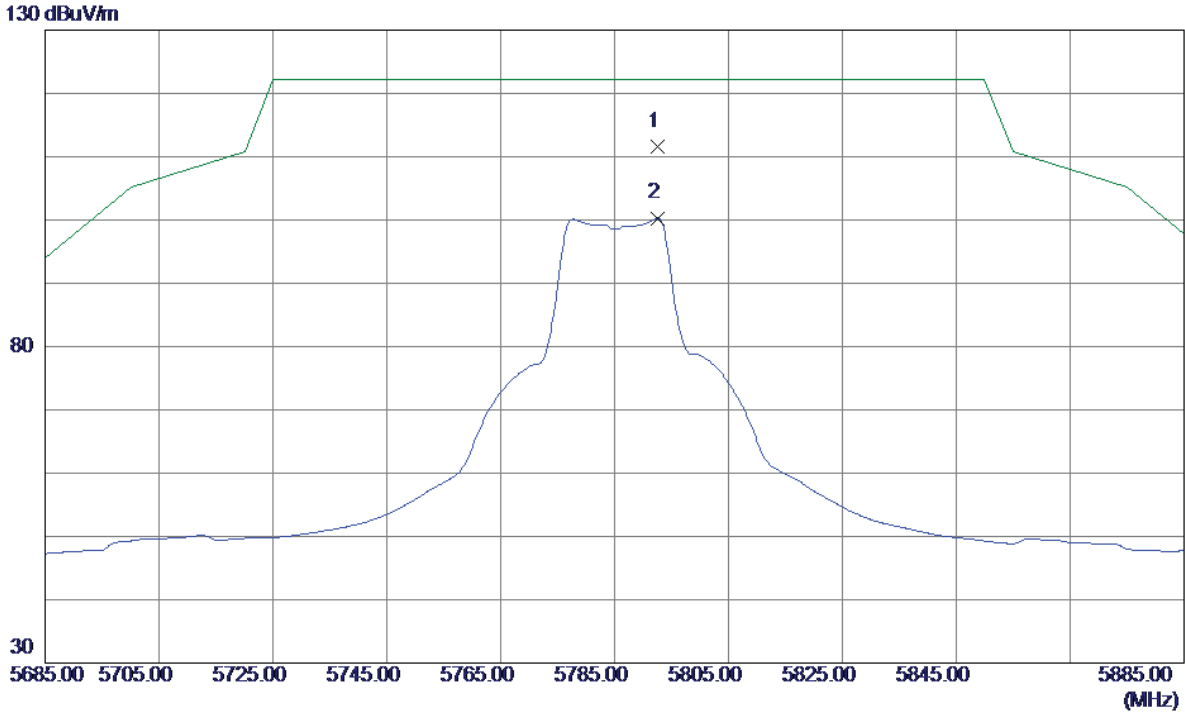

No.	Freq. MHz	Reading Level dBuV/m	Correct Factor dB	Measure ment dBuV/m	Limit dBuV/m	Margin dB	Detector	Comment
1 *	5792.6000	67.92	43.76	111.68	122.20	-10.52	Peak	
2	5792.6000	56.54	43.76	100.30	122.20	-21.90	AVG	

Orthogonal Axis:	X
Test Mode:	UNII-3/TX N20 Mode 5785MHz

Vertical

80 dBuV/m

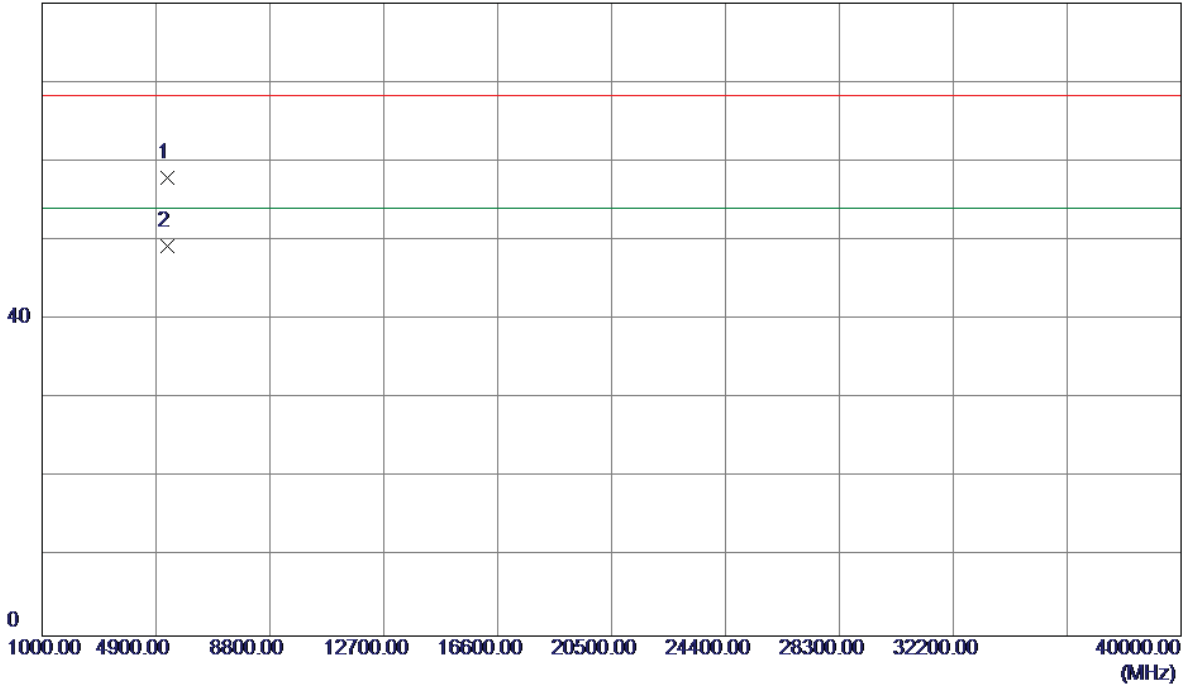

No.	Freq. MHz	Reading Level dBuV/m	Correct Factor dB	Measure ment dBuV/m	Limit dBuV/m	Margin dB	Detector	Comment
1	5300.4000	49.56	8.30	57.86	68.30	-10.44	Peak	
2 *	5301.7000	40.99	8.31	49.30	54.00	-4.70	AVG	

Orthogonal Axis:	X
Test Mode:	UNII-3/TX N20 Mode 5785MHz

Horizontal

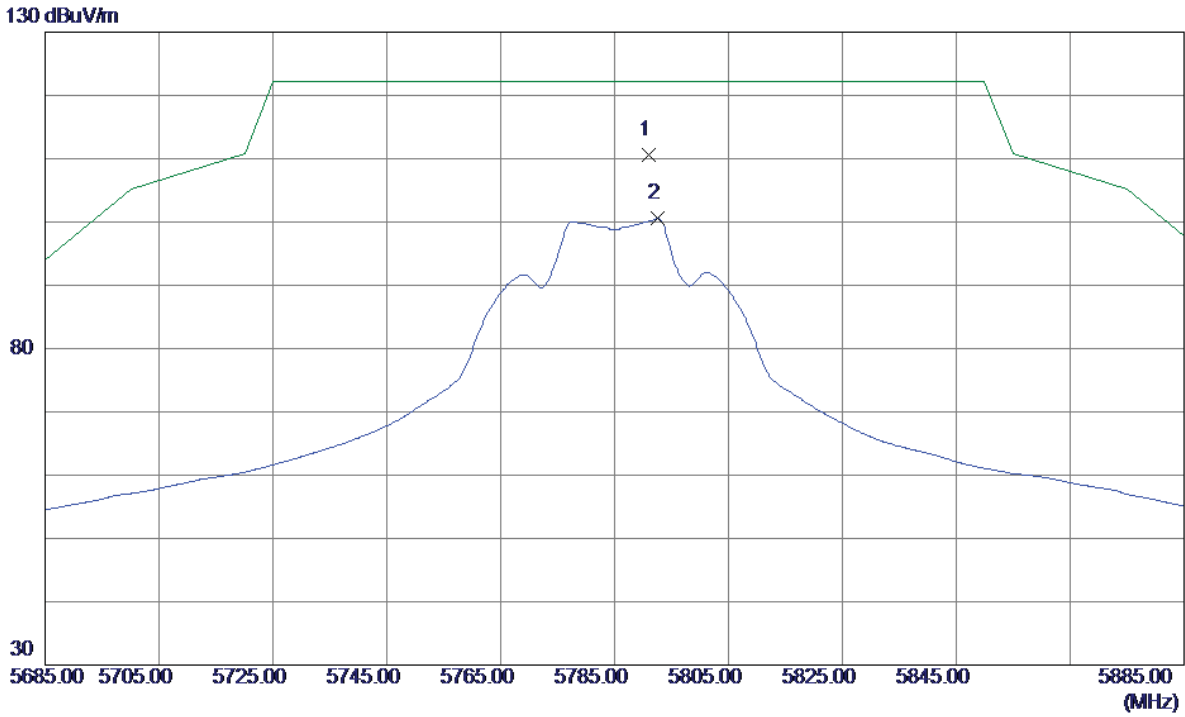

No.	Freq. MHz	Reading Level dBuV/m	Correct Factor dB	Measure ment dBuV/m	Limit dBuV/m	Margin dB	Detector	Comment
1 *	5791.0000	66.77	43.76	110.53	122.20	-11.67	Peak	
2	5792.6000	56.79	43.76	100.55	122.20	-21.65	AVG	

Orthogonal Axis:	X
Test Mode:	UNII-3/TX N20 Mode 5785MHz

Horizontal

80 dBuV/m

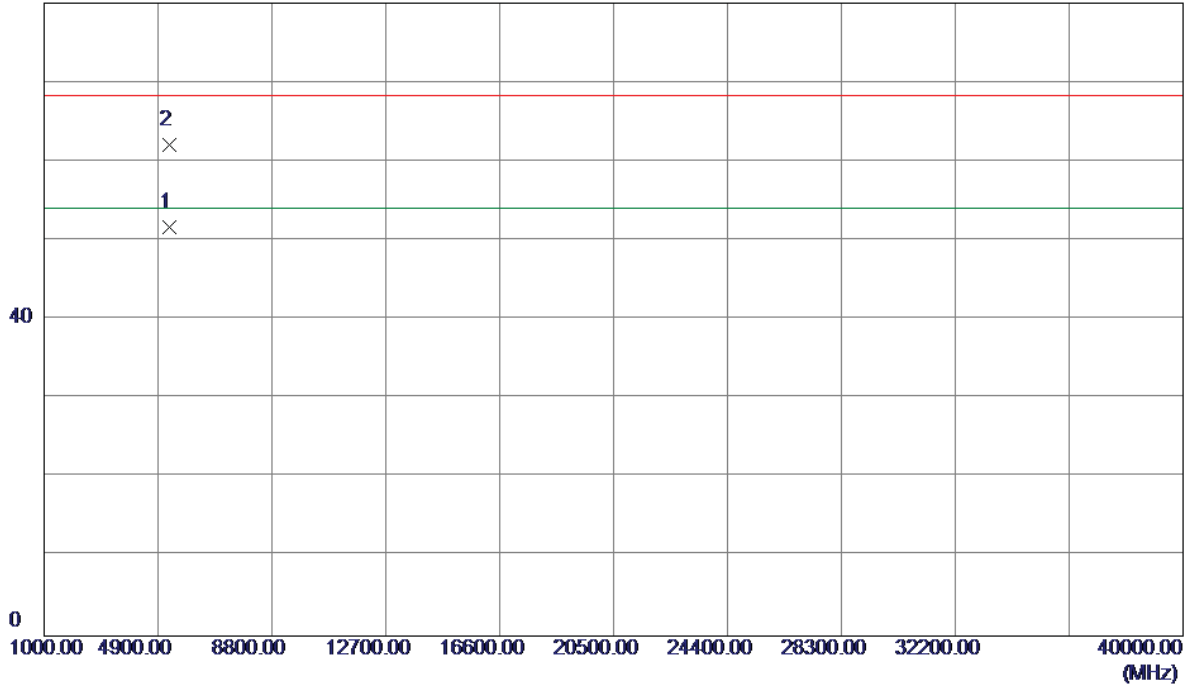

No.	Freq. MHz	Reading Level dBuV/m	Correct Factor dB	Measure ment dBuV/m	Limit dBuV/m	Margin dB	Detector	Comment
1 *	5297.8000	43.47	8.29	51.76	54.00	-2.24	AVG	
2	5298.2000	53.73	8.29	62.02	68.30	-6.28	Peak	

Orthogonal Axis:	X
Test Mode:	UNII-3/TX N20 Mode 5825MHz

Vertical

130 dBuV/m

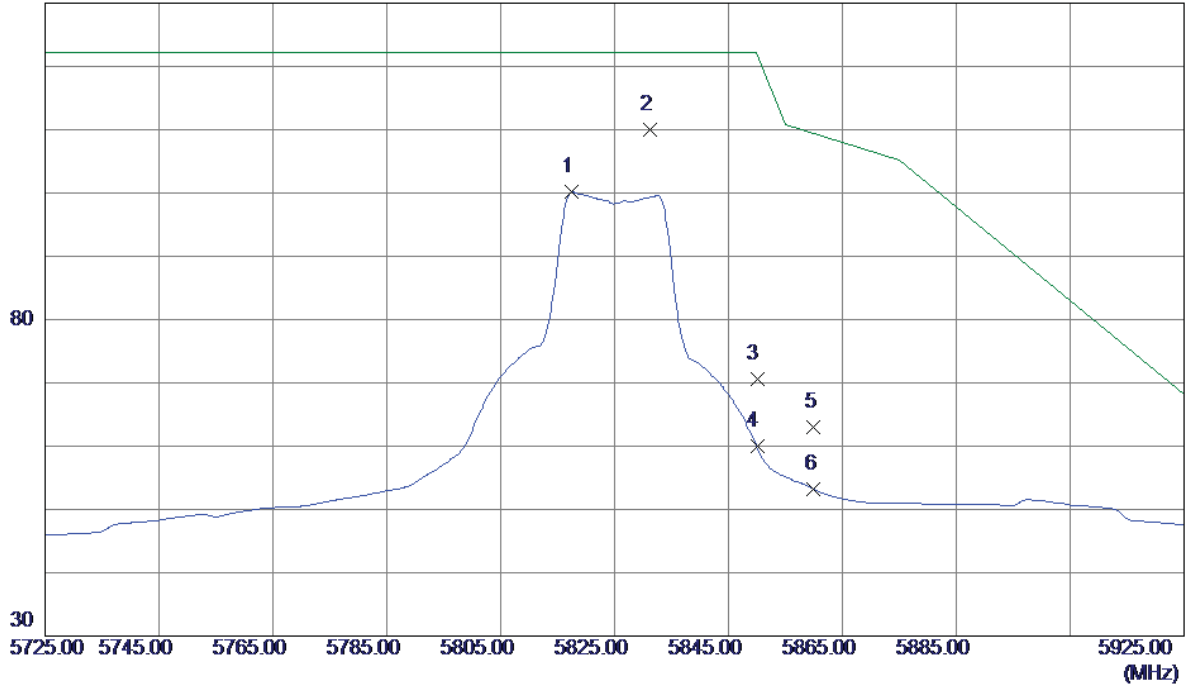

No.	Freq. MHz	Reading Level dBuV/m	Correct Factor dB	Measure ment dBuV/m	Limit dBuV/m	Margin dB	Detector	Comment
1	5817.4000	56.31	43.84	100.15	122.20	-22.05	AVG	
2 *	5831.2000	66.14	43.88	110.02	122.20	-12.18	Peak	
3	5850.0000	26.64	43.94	70.58	122.20	-51.62	Peak	
4	5850.0000	16.01	43.94	59.95	122.20	-62.25	AVG	
5	5860.0000	19.05	43.97	63.02	109.40	-46.38	Peak	
6	5860.0000	9.21	43.97	53.18	109.40	-56.22	AVG	

Orthogonal Axis:	X
Test Mode:	UNII-3/TX N20 Mode 5825MHz

Vertical

80 dBuV/m

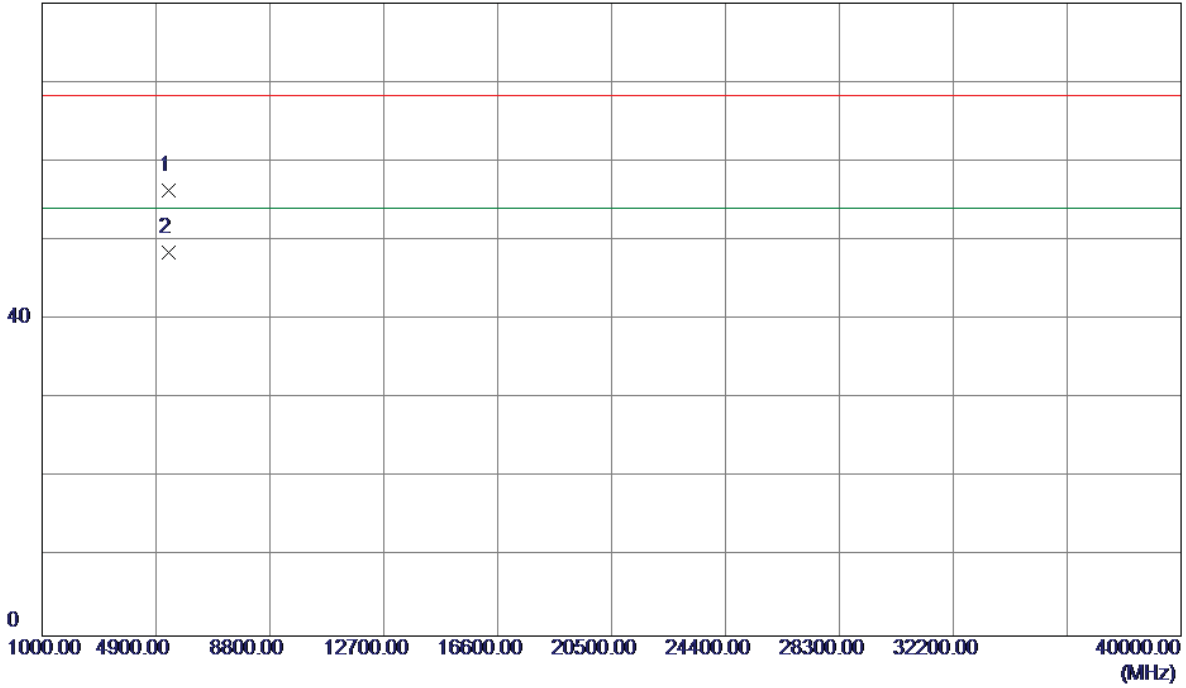

No.	Freq. MHz	Reading Level dBuV/m	Correct Factor dB	Measure ment dBuV/m	Limit dBuV/m	Margin dB	Detector	Comment
1	5331.5000	47.93	8.46	56.39	68.30	-11.91	Peak	
2 *	5339.5500	40.04	8.50	48.54	54.00	-5.46	AVG	

Orthogonal Axis:	X
Test Mode:	UNII-3/TX N20 Mode 5825MHz

Horizontal

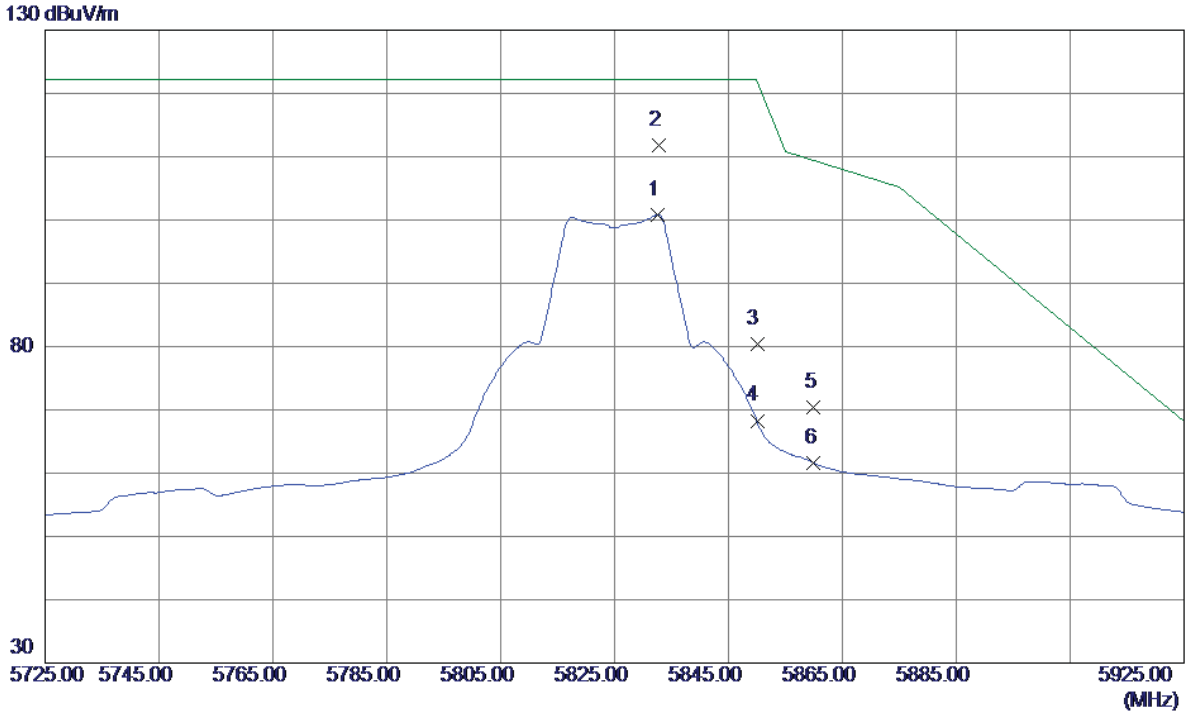

No.	Freq. MHz	Reading Level dBuV/m	Correct Factor dB	Measure ment dBuV/m	Limit dBuV/m	Margin dB	Detector	Comment
1	5832.6000	56.99	43.88	100.87	122.20	-21.33	AVG	
2 *	5832.8000	67.88	43.88	111.76	122.20	-10.44	Peak	
3	5850.0000	36.44	43.94	80.38	122.20	-41.82	Peak	
4	5850.0000	24.36	43.94	68.30	122.20	-53.90	AVG	
5	5860.0000	26.34	43.97	70.31	109.40	-39.09	Peak	
6	5860.0000	17.60	43.97	61.57	109.40	-47.83	AVG	

Orthogonal Axis:	X
Test Mode:	UNII-3/TX N20 Mode 5825MHz

Horizontal

80 dBuV/m

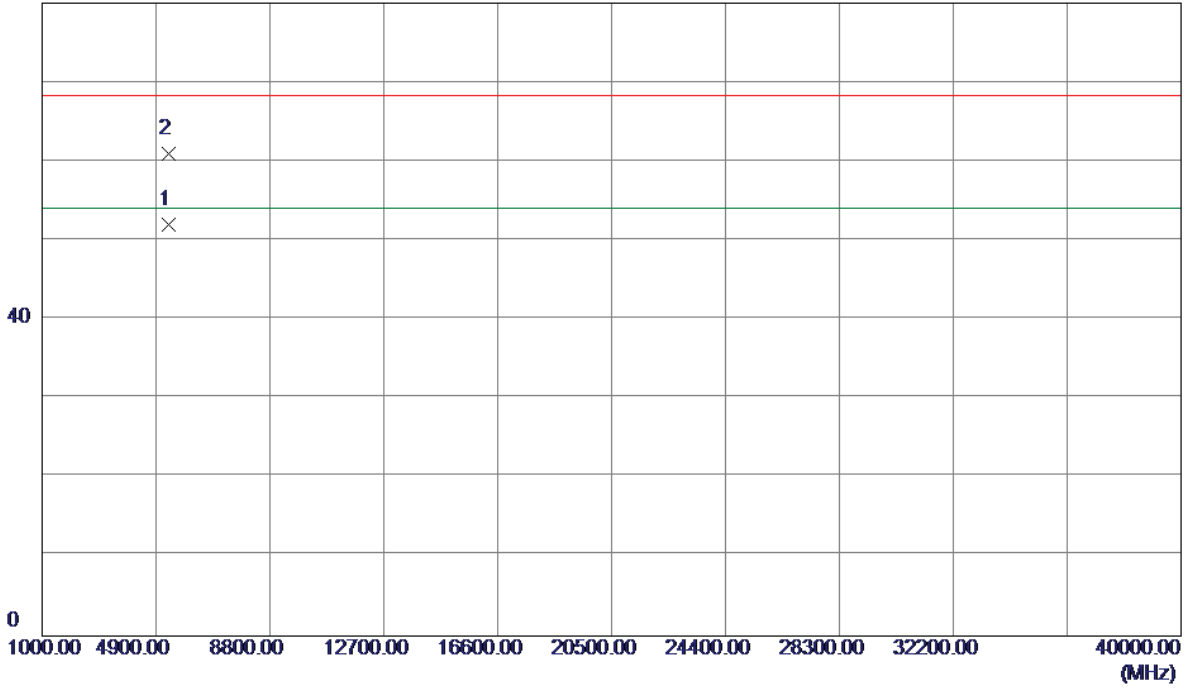

No.	Freq. MHz	Reading Level dBuV/m	Correct Factor dB	Measure ment dBuV/m	Limit dBuV/m	Margin dB	Detector	Comment
1 *	5332.8000	43.60	8.47	52.07	54.00	-1.93	AVG	
2	5335.8000	52.55	8.48	61.03	68.30	-7.27	Peak	

Orthogonal Axis:	X
Test Mode:	UNII-3/TX N40 Mode 5755MHz

Vertical

130 dBuV/m

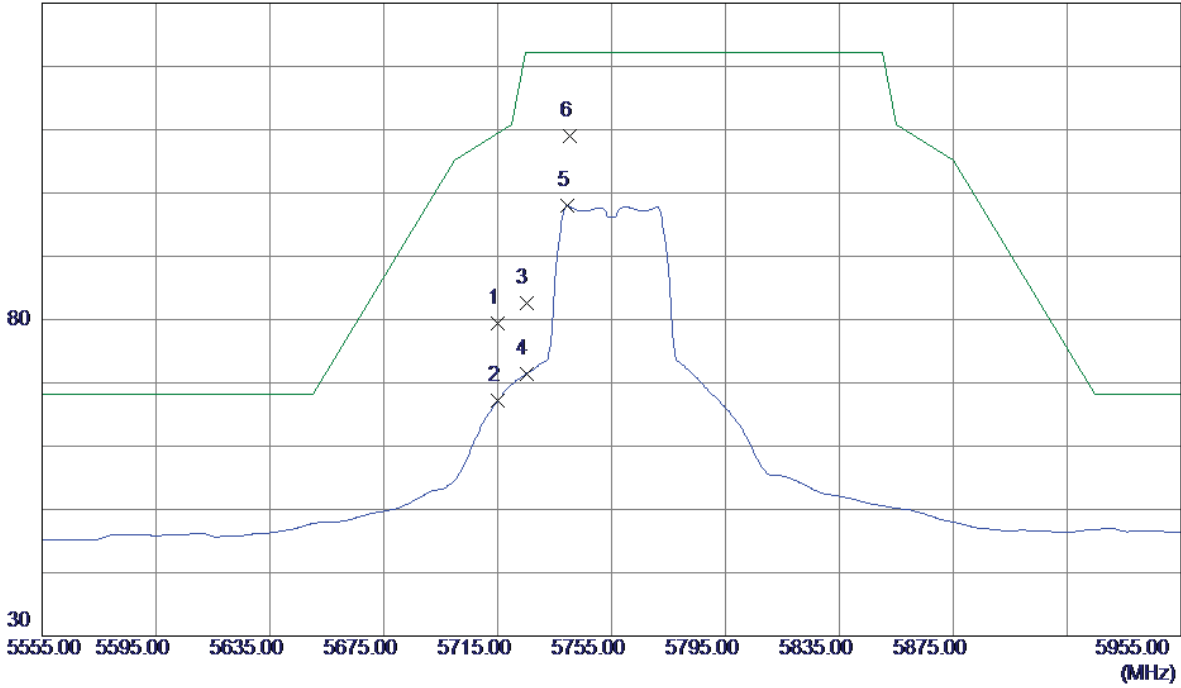

No.	Freq. MHz	Reading Level dBuV/m	Correct Factor dB	Measure ment dBuV/m	Limit dBuV/m	Margin dB	Detector	Comment
1	5715.0000	35.81	43.53	79.34	109.40	-30.06	Peak	
2	5715.0000	23.64	43.53	67.17	109.40	-42.23	AVG	
3	5725.0000	39.09	43.56	82.65	122.20	-39.55	Peak	
4	5725.0000	27.82	43.56	71.38	122.20	-50.82	AVG	
5	5739.4000	54.34	43.60	97.94	122.20	-24.26	AVG	
6 *	5740.2000	65.44	43.61	109.05	122.20	-13.15	Peak	

Orthogonal Axis:	X
Test Mode:	UNII-3/TX N40 Mode 5755MHz

Vertical

80 dBuV/m

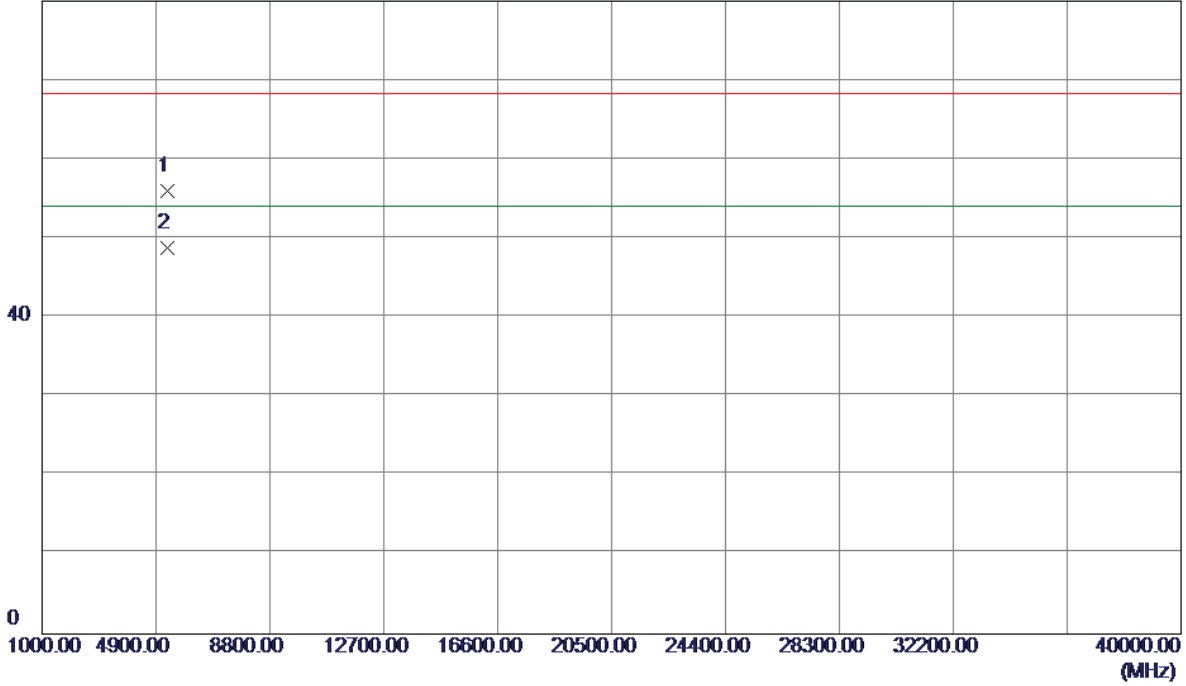

No.	Freq. MHz	Reading Level dBuV/m	Correct Factor dB	Measure ment dBuV/m	Limit dBuV/m	Margin dB	Detector	Comment
1	5275.2850	47.90	8.17	56.07	68.30	-12.23	Peak	
2 *	5275.3050	40.67	8.17	48.84	54.00	-5.16	AVG	

Orthogonal Axis:	X
Test Mode:	UNII-3/TX N40 Mode 5755MHz

Horizontal

130 dBuV/m

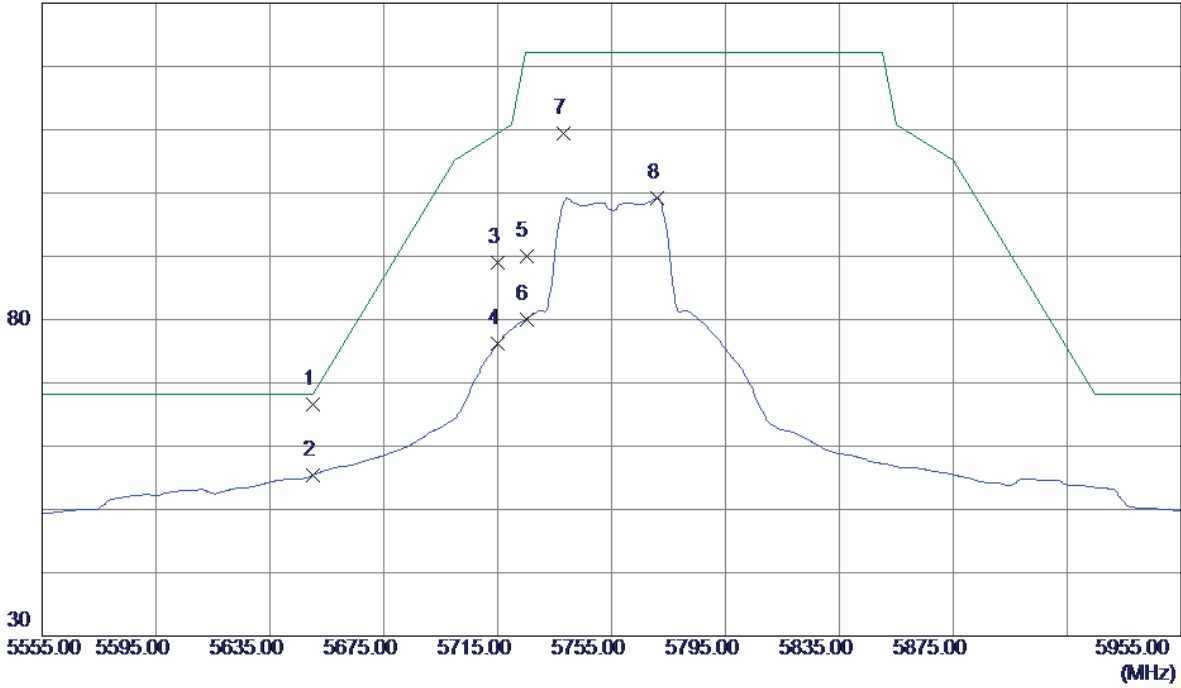

No.	Freq. MHz	Reading Level dBuV/m	Correct Factor dB	Measure ment dBuV/m	Limit dBuV/m	Margin dB	Detector	Comment
1 *	5650.2000	23.29	43.33	66.62	68.35	-1.73	Peak	
2	5650.2000	12.11	43.33	55.44	68.35	-12.91	AVG	
3	5715.0000	45.46	43.53	88.99	109.40	-20.41	Peak	
4	5715.0000	32.62	43.53	76.15	109.40	-33.25	AVG	
5	5725.0000	46.49	43.56	90.05	122.20	-32.15	Peak	
6	5725.0000	36.51	43.56	80.07	122.20	-42.13	AVG	
7	5738.2000	65.79	43.60	109.39	122.20	-12.81	Peak	
8	5771.0000	55.55	43.70	99.25	122.20	-22.95	Peak	

Orthogonal Axis:	X
Test Mode:	UNII-3/TX N40 Mode 5755MHz

Horizontal

80 dBuV/m

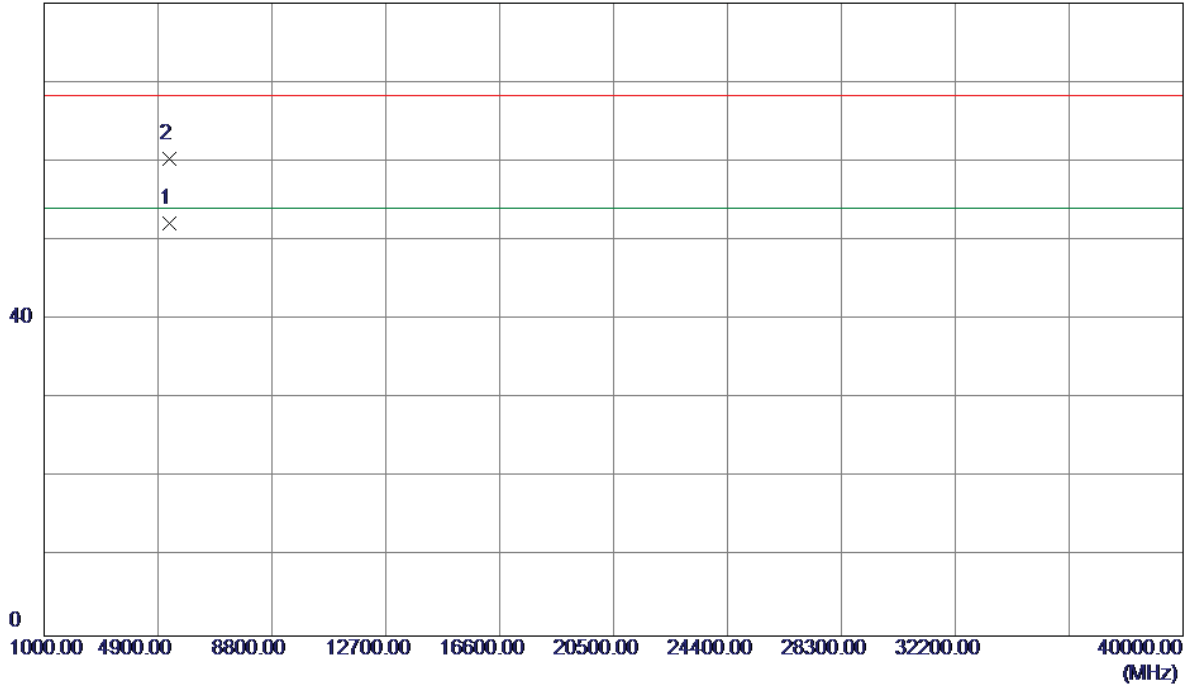

No.	Freq. MHz	Reading Level dBuV/m	Correct Factor dB	Measure ment dBuV/m	Limit dBuV/m	Margin dB	Detector	Comment
1 *	5275.3500	44.01	8.17	52.18	54.00	-1.82	AVG	
2	5275.5000	52.17	8.17	60.34	68.30	-7.96	Peak	

Orthogonal Axis:	X
Test Mode:	UNII-3/TX N40 Mode 5795MHz

Vertical

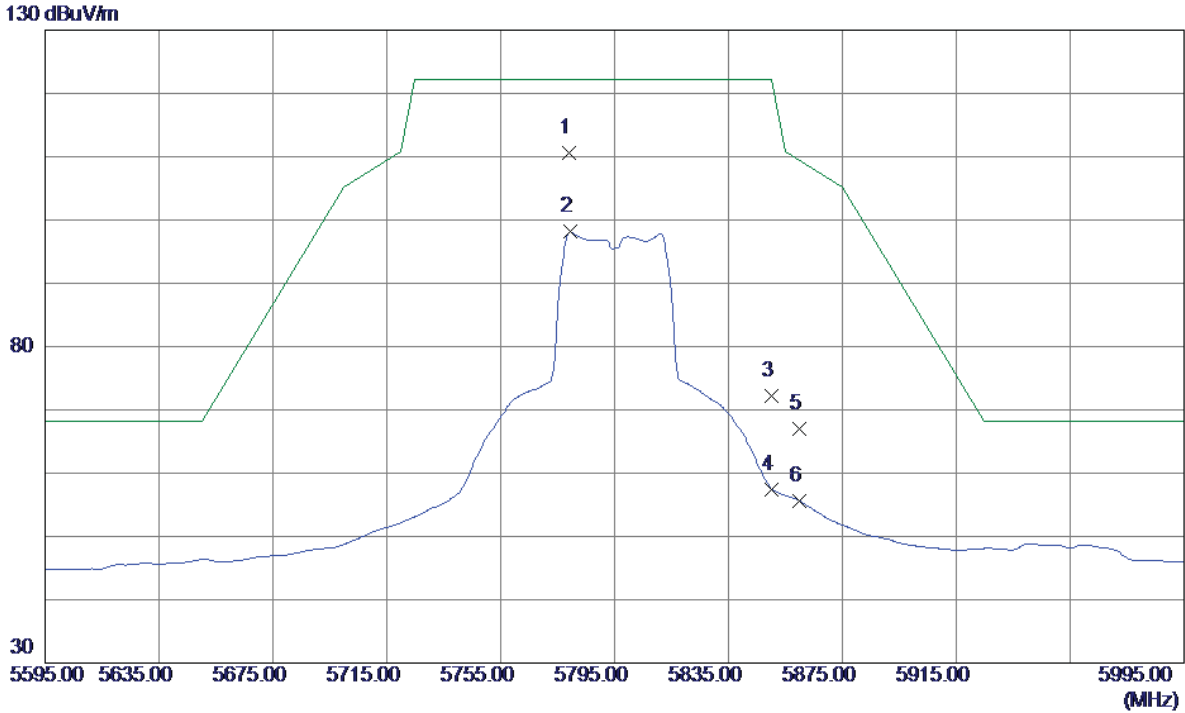

No.	Freq. MHz	Reading Level dBuV/m	Correct Factor dB	Measure ment dBuV/m	Limit dBuV/m	Margin dB	Detector	Comment
1 *	5779.0000	66.92	43.72	110.64	122.20	-11.56	Peak	
2	5779.4000	54.40	43.72	98.12	122.20	-24.08	AVG	
3	5850.0000	28.31	43.94	72.25	122.20	-49.95	Peak	
4	5850.0000	13.55	43.94	57.49	122.20	-64.71	AVG	
5	5860.0000	23.12	43.97	67.09	109.40	-42.31	Peak	
6	5860.0000	11.63	43.97	55.60	109.40	-53.80	AVG	

Orthogonal Axis:	X
Test Mode:	UNII-3/TX N40 Mode 5795MHz

Vertical

80 dBuV/m

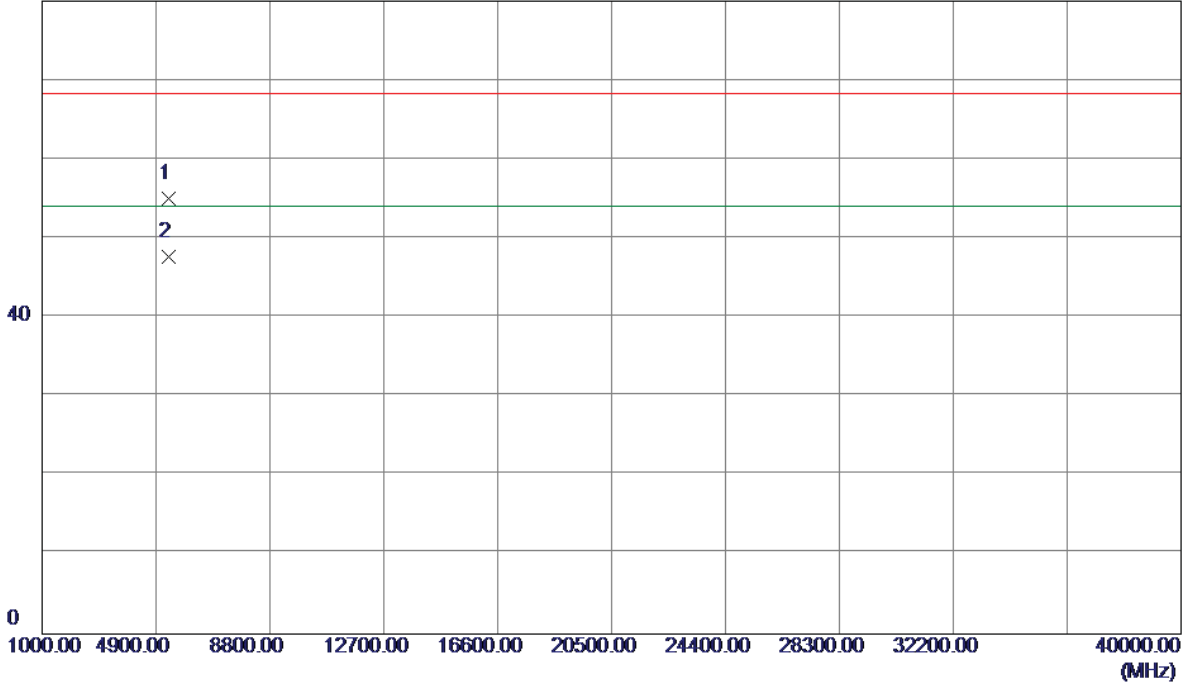

No.	Freq. MHz	Reading Level dBuV/m	Correct Factor dB	Measure ment dBuV/m	Limit dBuV/m	Margin dB	Detector	Comment
1	5311.8860	46.75	8.36	55.11	68.30	-13.19	Peak	
2 *	5311.9810	39.37	8.36	47.73	54.00	-6.27	AVG	

Orthogonal Axis:	X
Test Mode:	UNII-3/TX N40 Mode 5795MHz

Horizontal

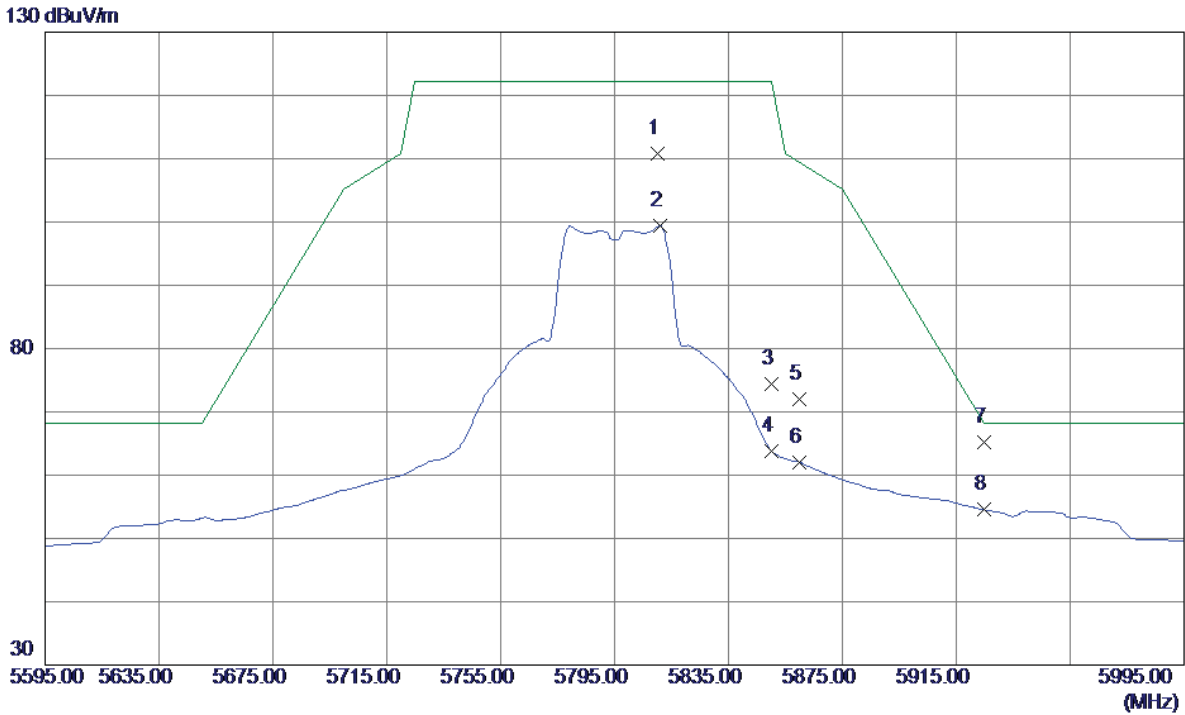

No.	Freq. MHz	Reading Level dBuV/m	Correct Factor dB	Measure ment dBuV/m	Limit dBuV/m	Margin dB	Detector	Comment
1	5810.2000	67.00	43.82	110.82	122.20	-11.38	Peak	
2	5811.0000	55.58	43.82	99.40	122.20	-22.80	AVG	
3	5850.0000	30.49	43.94	74.43	122.20	-47.77	Peak	
4	5850.0000	19.84	43.94	63.78	122.20	-58.42	AVG	
5	5860.0000	28.08	43.97	72.05	109.40	-37.35	Peak	
6	5860.0000	18.02	43.97	61.99	109.40	-47.41	AVG	
7 *	5924.6000	21.07	44.16	65.23	68.50	-3.27	Peak	
8	5924.6000	10.39	44.16	54.55	68.50	-13.95	AVG	

Orthogonal Axis:	X
Test Mode:	UNII-3/TX N40 Mode 5795MHz

Horizontal

80 dBuV/m

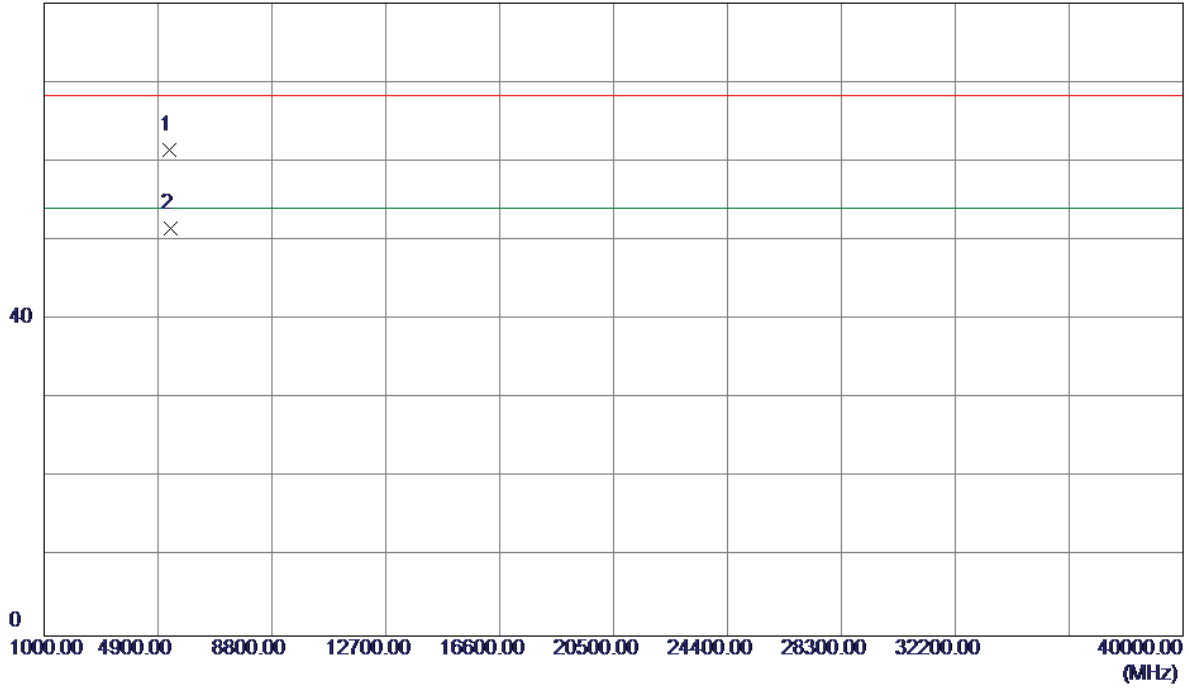

No.	Freq. MHz	Reading Level dBuV/m	Correct Factor dB	Measure ment dBuV/m	Limit dBuV/m	Margin dB	Detector	Comment
1	5310.3010	53.02	8.35	61.37	68.30	-6.93	Peak	
2 *	5312.0160	43.16	8.36	51.52	54.00	-2.48	AVG	

Orthogonal Axis:	X
Test Mode:	UNII-1/ TX AC20 Mode 5180MHz

Vertical

130 dBuV/m

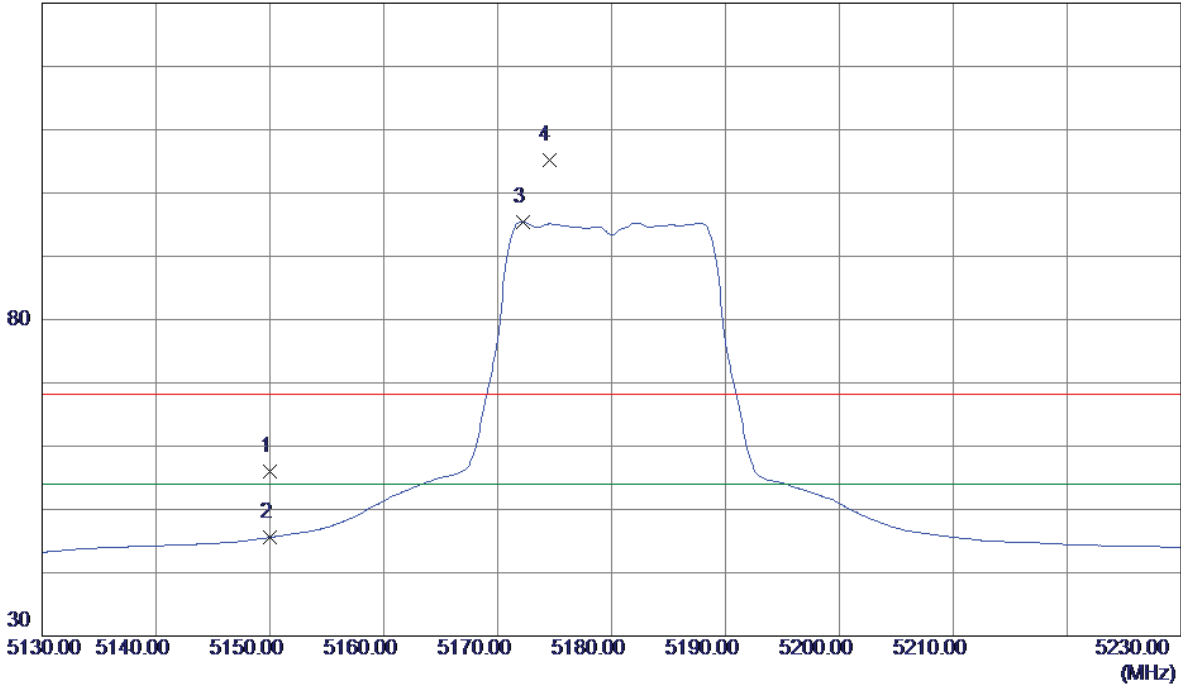

No.	Freq. MHz	Reading Level dBuV/m	Correct Factor dB	Measure ment dBuV/m	Limit dBuV/m	Margin dB	Detector	Comment
1	5150.0000	14.83	41.10	55.93	68.30	-12.37	Peak	
2	5150.0000	4.48	41.10	45.58	54.00	-8.42	AVG	
3 *	5172.2000	54.19	41.21	95.40	54.00	41.40	AVG	No Limit
4	5174.5000	63.95	41.23	105.18	68.30	36.88	Peak	No Limit

Orthogonal Axis:	X
Test Mode:	UNII-1/ TX AC20 Mode 5180MHz

Vertical

80 dBuV/m

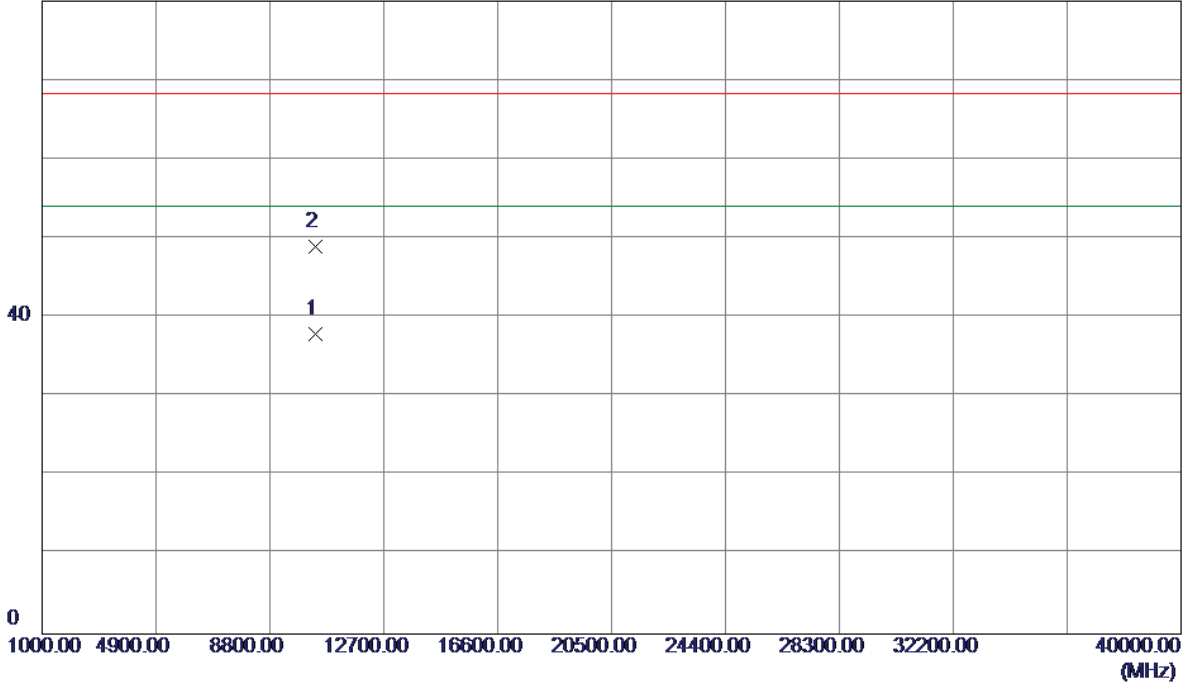

No.	Freq. MHz	Reading Level dBuV/m	Correct Factor dB	Measure ment dBuV/m	Limit dBuV/m	Margin dB	Detector	Comment
1 *	10359.7120	20.80	17.10	37.90	54.00	-16.10	AVG	
2	10360.7699	31.81	17.11	48.92	68.30	-19.38	Peak	

Orthogonal Axis:	X
Test Mode:	UNII-1/ TX AC20 Mode 5180MHz

Horizontal

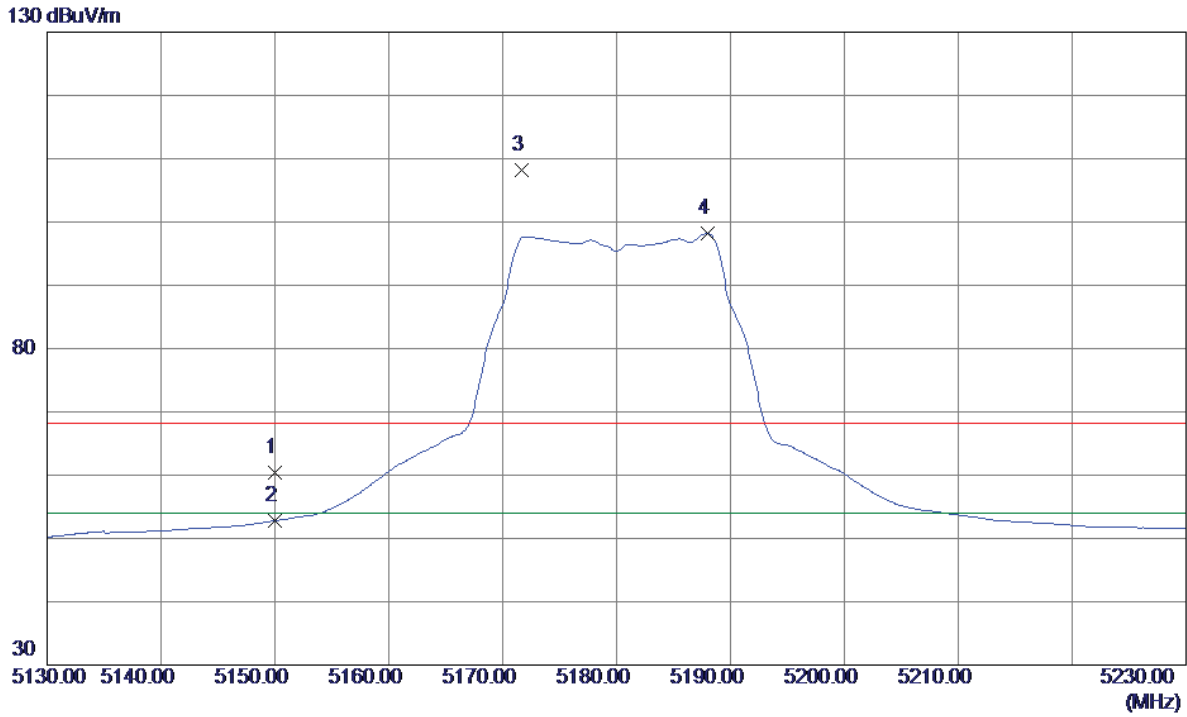

No.	Freq. MHz	Reading Level dBuV/m	Correct Factor dB	Measure ment dBuV/m	Limit dBuV/m	Margin dB	Detector	Comment
1	5150.0000	19.34	41.10	60.44	68.30	-7.86	Peak	
2	5150.0000	11.70	41.10	52.80	54.00	-1.20	AVG	
3	5171.7000	66.99	41.21	108.20	68.30	39.90	Peak	No Limit
4 *	5188.0000	56.86	41.29	98.15	54.00	44.15	AVG	No Limit

Orthogonal Axis:	X
Test Mode:	UNII-1/ TX AC20 Mode 5180MHz

Horizontal

80 dBuV/m

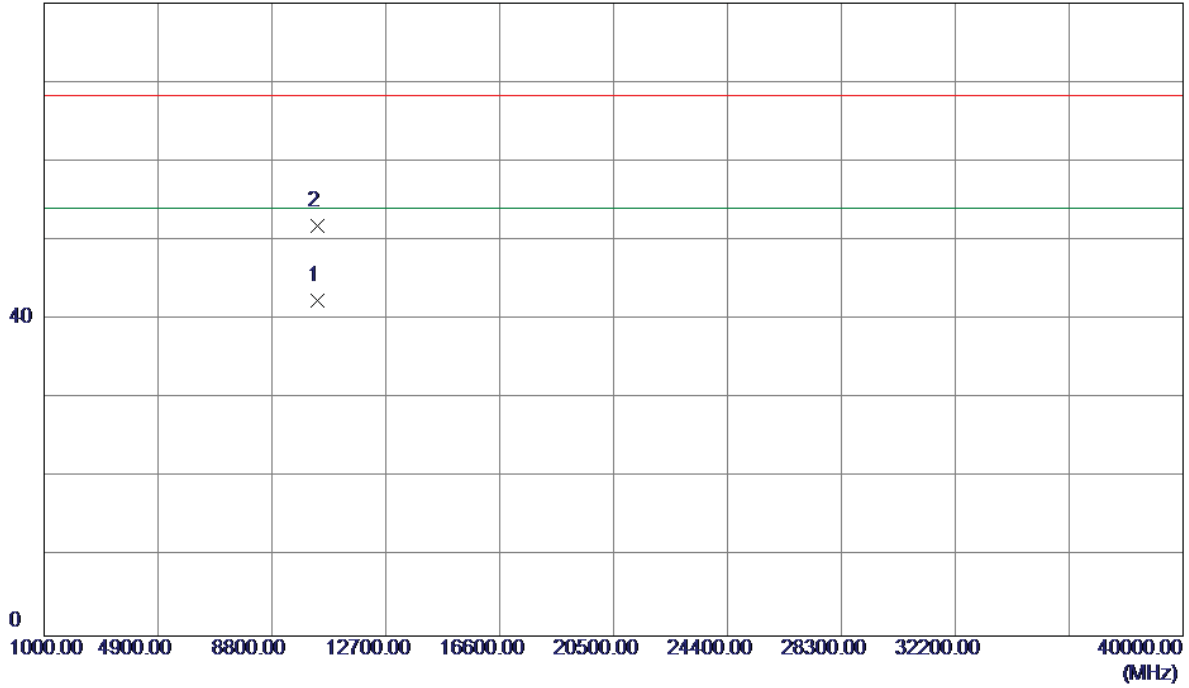

No.	Freq. MHz	Reading Level dBuV/m	Correct Factor dB	Measure ment dBuV/m	Limit dBuV/m	Margin dB	Detector	Comment
1 *	10359.8300	25.33	17.10	42.43	54.00	-11.57	AVG	
2	10359.6900	34.71	17.10	51.81	68.30	-16.49	Peak	

Orthogonal Axis:	X
Test Mode:	UNII-1/ TX AC20 Mode 5200MHz

Vertical

130 dBuV/m

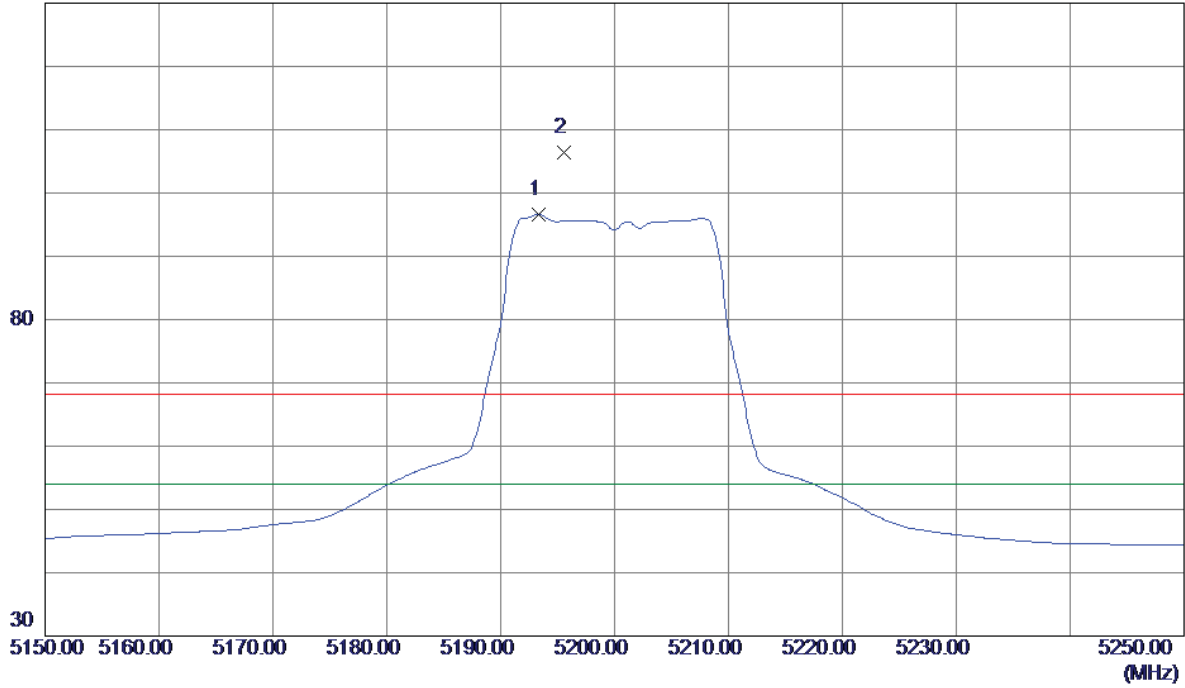

No.	Freq. MHz	Reading Level dBuV/m	Correct Factor dB	Measure ment dBuV/m	Limit dBuV/m	Margin dB	Detector	Comment
1 *	5193.3000	55.28	41.32	96.60	54.00	42.60	AVG	No Limit
2	5195.6000	65.00	41.33	106.33	68.30	38.03	Peak	No Limit

Orthogonal Axis:	X
Test Mode:	UNII-1/ TX AC20 Mode 5200MHz

Vertical

80 dBuV/m

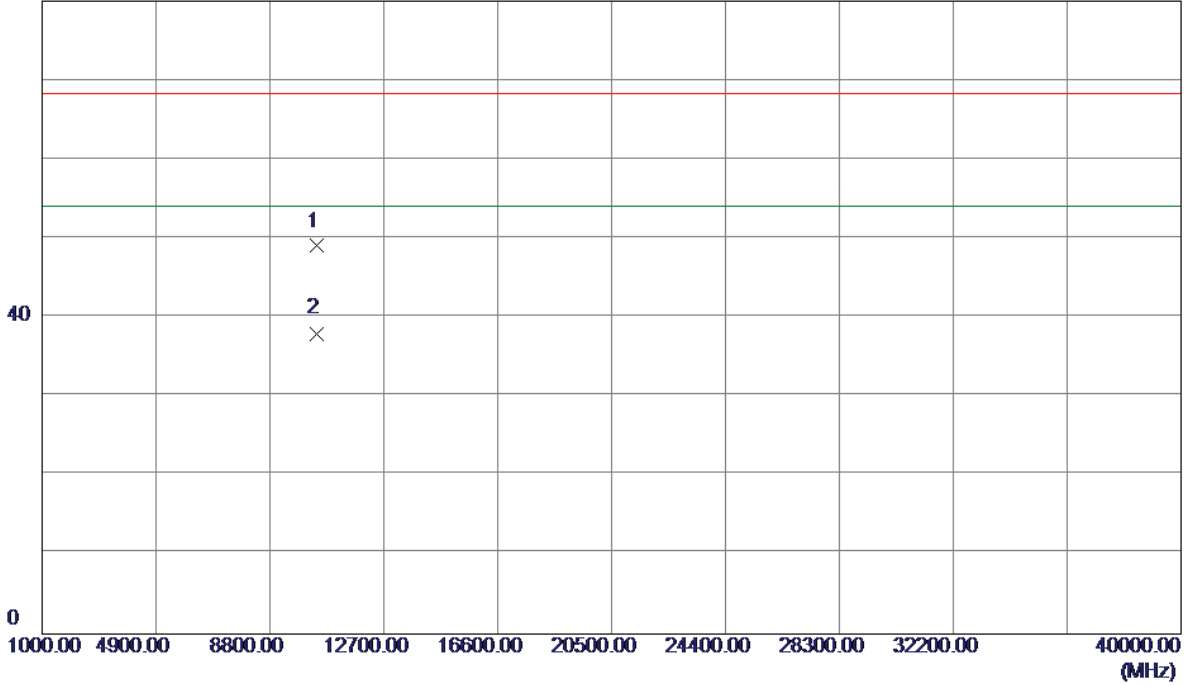

No.	Freq. MHz	Reading Level dBuV/m	Correct Factor dB	Measure ment dBuV/m	Limit dBuV/m	Margin dB	Detector	Comment
1	10399.8480	31.82	17.22	49.04	68.30	-19.26	Peak	
2 *	10400.6640	20.78	17.22	38.00	54.00	-16.00	AVG	

Orthogonal Axis:	X
Test Mode:	UNII-1/ TX AC20 Mode 5200MHz

Horizontal

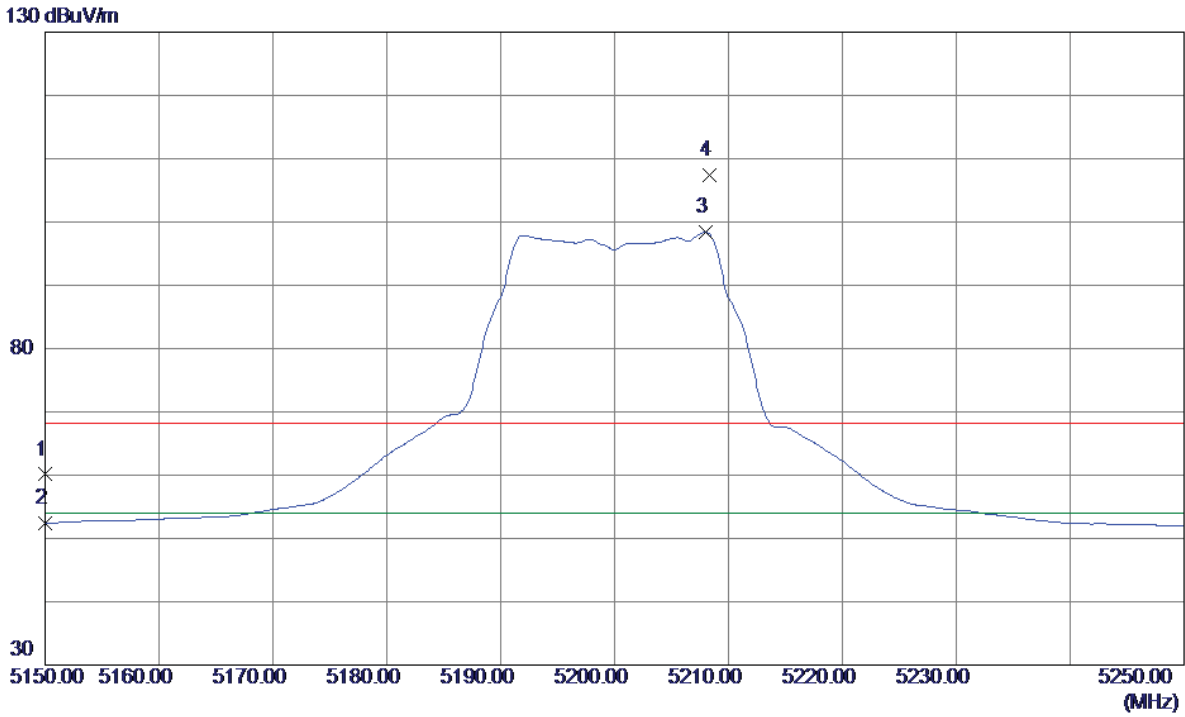

No.	Freq. MHz	Reading Level dBuV/m	Correct Factor dB	Measure ment dBuV/m	Limit dBuV/m	Margin dB	Detector	Comment
1	5150.0000	19.00	41.10	60.10	68.30	-8.20	Peak	
2	5150.0000	11.26	41.10	52.36	54.00	-1.64	AVG	
3 *	5208.0000	56.94	41.40	98.34	54.00	44.34	AVG	No Limit
4	5208.3000	66.02	41.40	107.42	68.30	39.12	Peak	No Limit

Orthogonal Axis:	X
Test Mode:	UNII-1/ TX AC20 Mode 5200MHz

Horizontal

80 dBuV/m

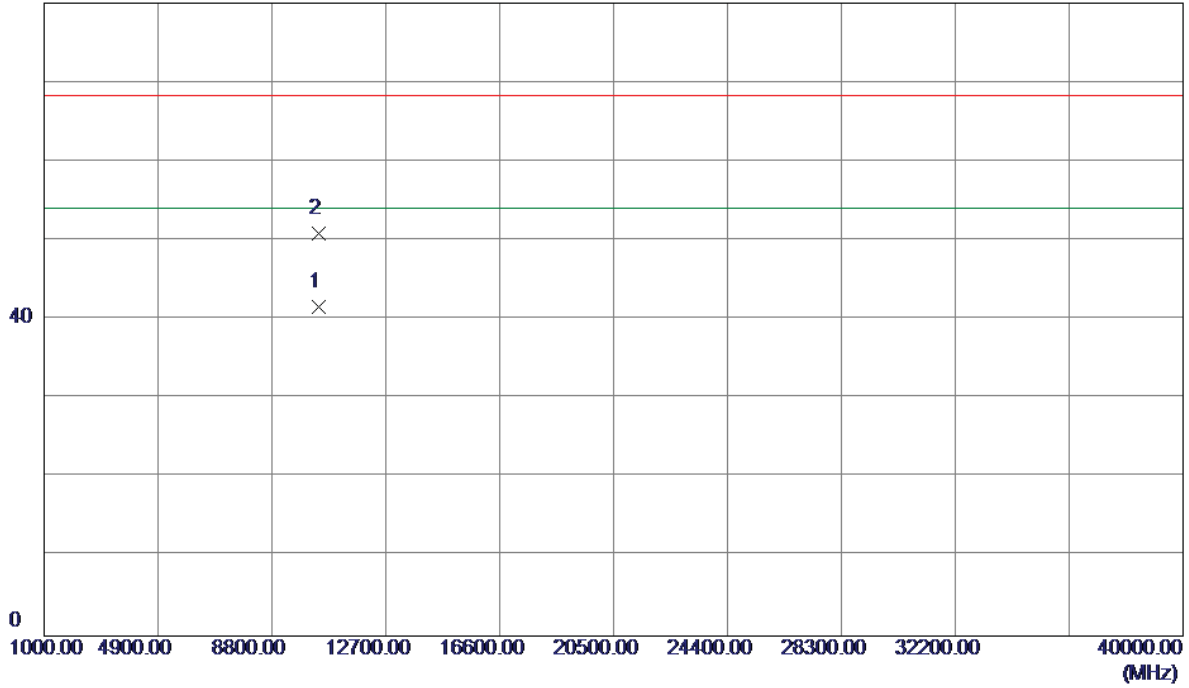

No.	Freq. MHz	Reading Level dBuV/m	Correct Factor dB	Measure ment dBuV/m	Limit dBuV/m	Margin dB	Detector	Comment
1 *	10399.8760	24.33	17.22	41.55	54.00	-12.45	AVG	
2	10399.9260	33.59	17.22	50.81	68.30	-17.49	Peak	

Orthogonal Axis:	X
Test Mode:	UNII-1/ TX AC20 Mode 5240MHz

Vertical

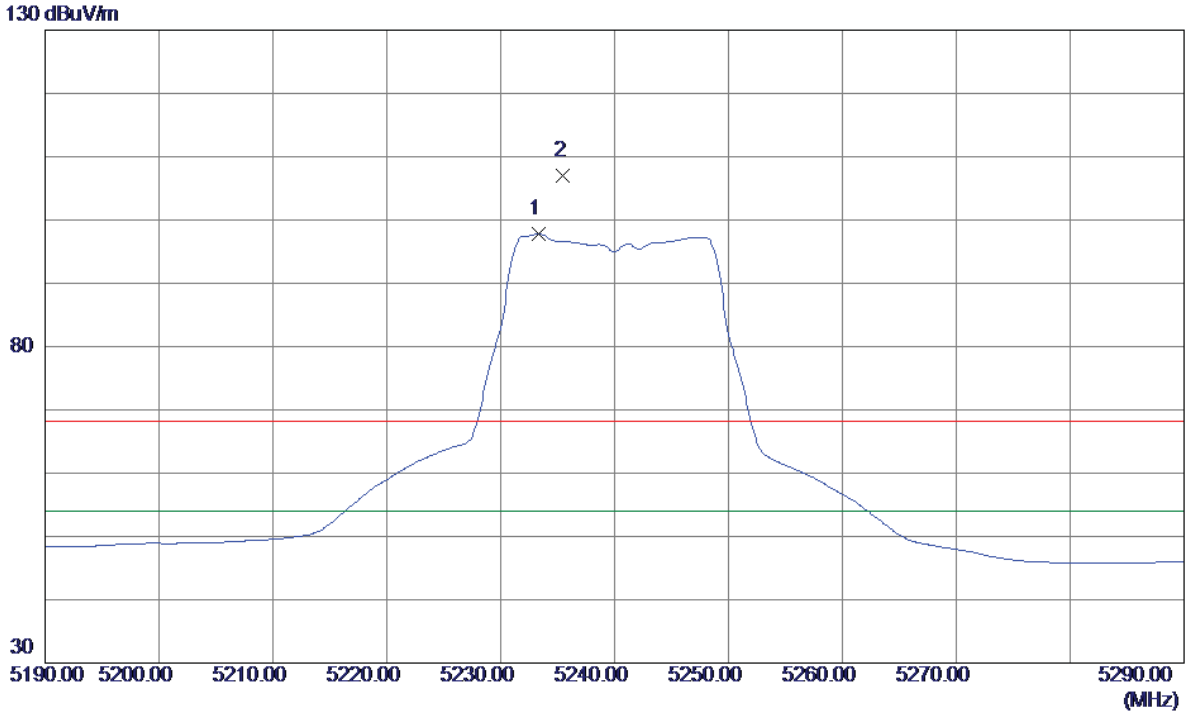

No.	Freq. MHz	Reading Level dBuV/m	Correct Factor dB	Measure ment dBuV/m	Limit dBuV/m	Margin dB	Detector	Comment
1 *	5233.3000	56.30	41.53	97.83	54.00	43.83	AVG	No Limit
2	5235.5000	65.36	41.54	106.90	68.30	38.60	Peak	No Limit

Orthogonal Axis:	X
Test Mode:	UNII-1/ TX AC20 Mode 5240MHz

Vertical

80 dBuV/m

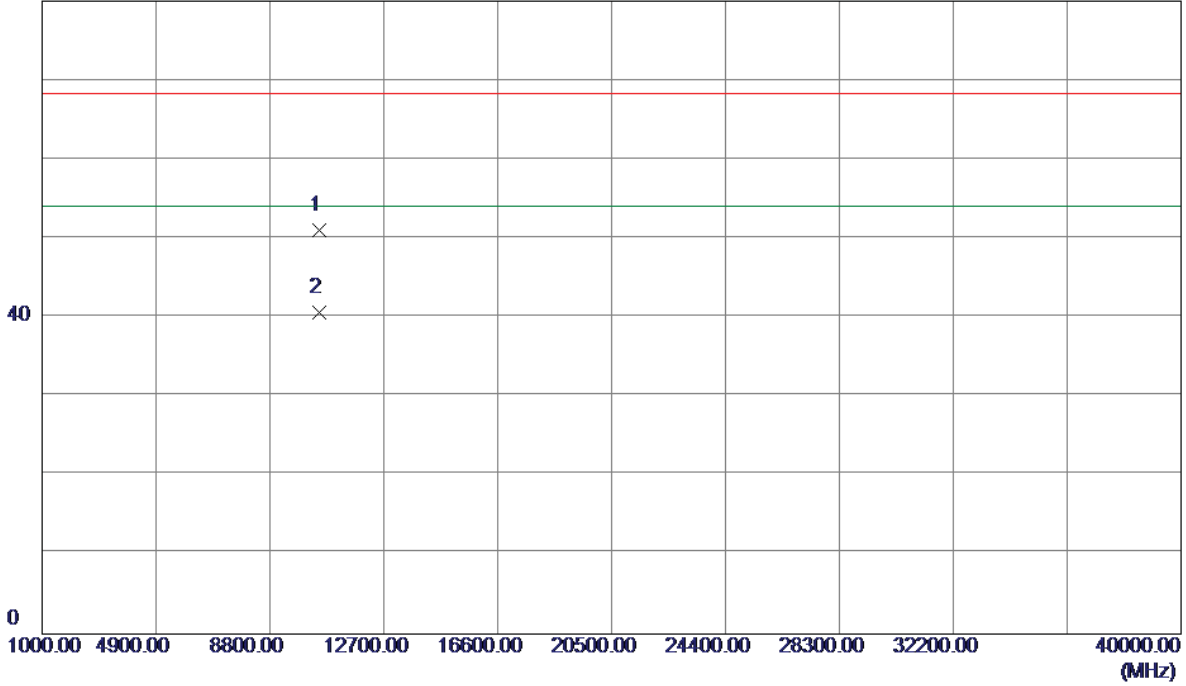

No.	Freq. MHz	Reading Level dBuV/m	Correct Factor dB	Measure ment dBuV/m	Limit dBuV/m	Margin dB	Detector	Comment
1	10479.7100	33.59	17.44	51.03	68.30	-17.27	Peak	
2 *	10479.8740	23.18	17.44	40.62	54.00	-13.38	AVG	

Orthogonal Axis:	X
Test Mode:	UNII-1/ TX AC20 Mode 5240MHz

Horizontal

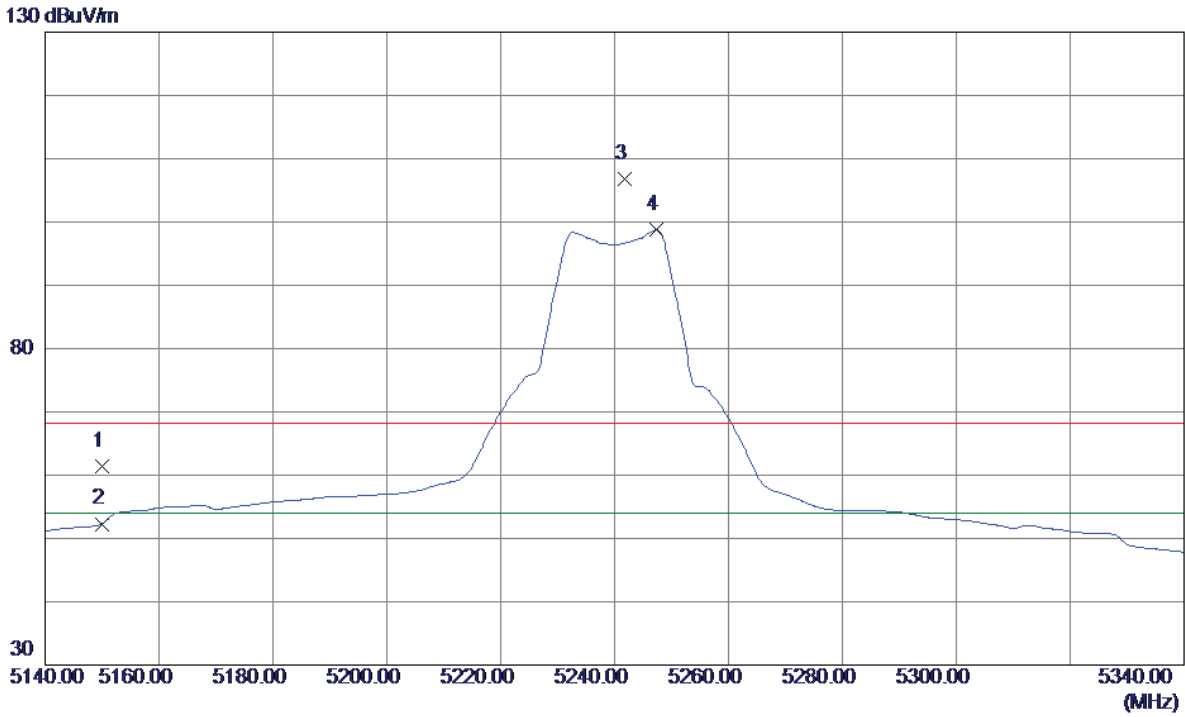

No.	Freq. MHz	Reading Level dBuV/m	Correct Factor dB	Measure ment dBuV/m	Limit dBuV/m	Margin dB	Detector	Comment
1	5150.0000	20.38	41.10	61.48	68.30	-6.82	Peak	
2	5150.0000	11.20	41.10	52.30	54.00	-1.70	AVG	
3	5241.8000	65.23	41.57	106.80	68.30	38.50	Peak	No Limit
4 *	5247.4000	57.14	41.60	98.74	54.00	44.74	AVG	No Limit

Orthogonal Axis:	X
Test Mode:	UNII-1/ TX AC20 Mode 5240MHz

Horizontal

80 dBuV/m

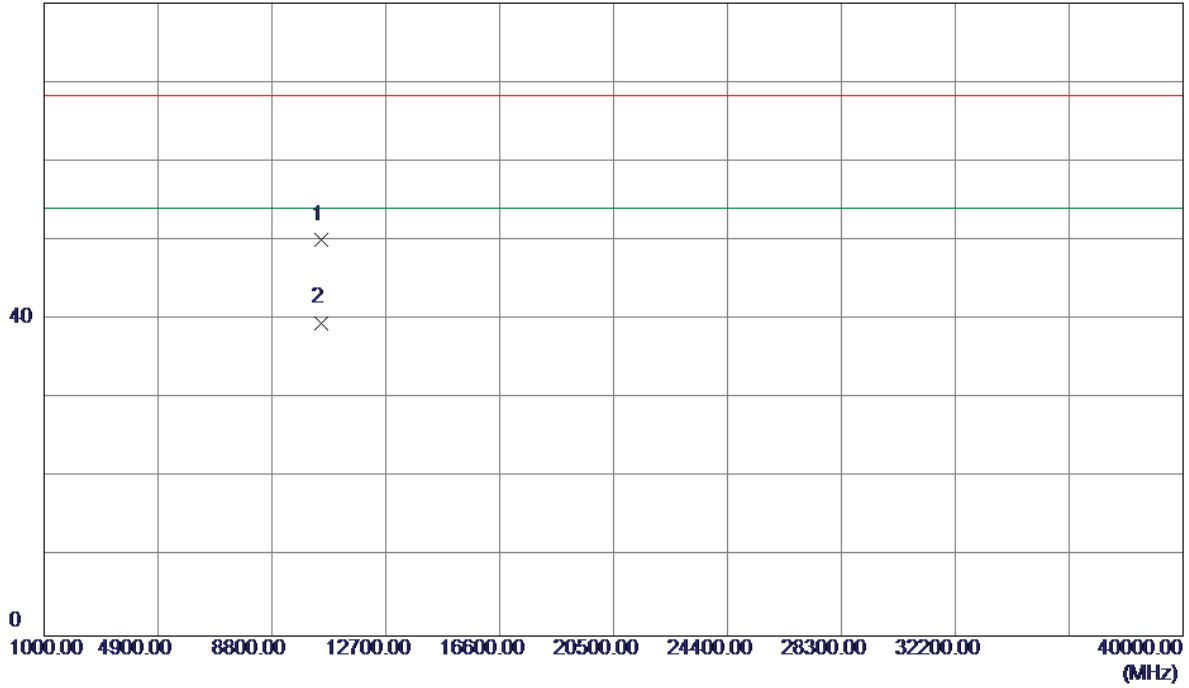

No.	Freq. MHz	Reading Level dBuV/m	Correct Factor dB	Measure ment dBuV/m	Limit dBuV/m	Margin dB	Detector	Comment
1	10479.7100	32.67	17.44	50.11	68.30	-18.19	Peak	
2 *	10479.8740	22.16	17.44	39.60	54.00	-14.40	AVG	

Orthogonal Axis:	X
Test Mode:	UNII-1/ TX AC40 Mode 5190MHz

Vertical

130 dBuV/m

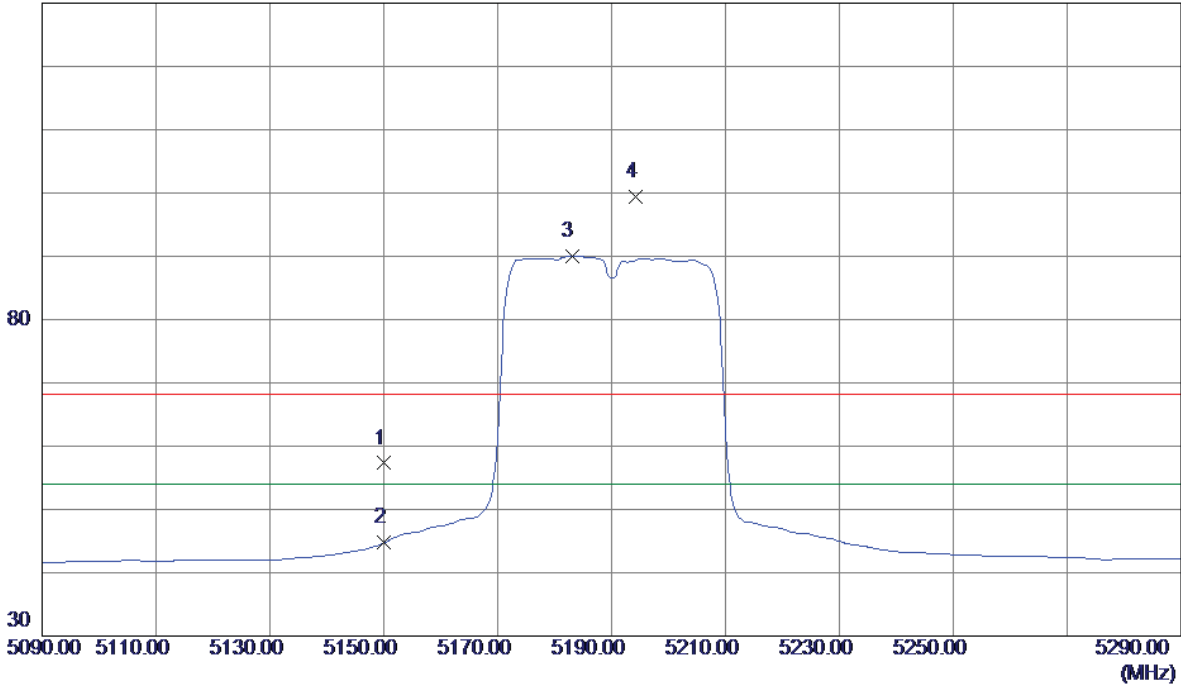

No.	Freq. MHz	Reading Level dBuV/m	Correct Factor dB	Measure ment dBuV/m	Limit dBuV/m	Margin dB	Detector	Comment
1	5150.0000	16.20	41.10	57.30	68.30	-11.00	Peak	
2	5150.0000	3.63	41.10	44.73	54.00	-9.27	AVG	
3 *	5183.0000	48.78	41.27	90.05	54.00	36.05	AVG	No Limit
4	5194.2000	58.10	41.33	99.43	68.30	31.13	Peak	No Limit

Orthogonal Axis:	X
Test Mode:	UNII-1/ TX AC40 Mode 5190MHz

Vertical

80 dBuV/m

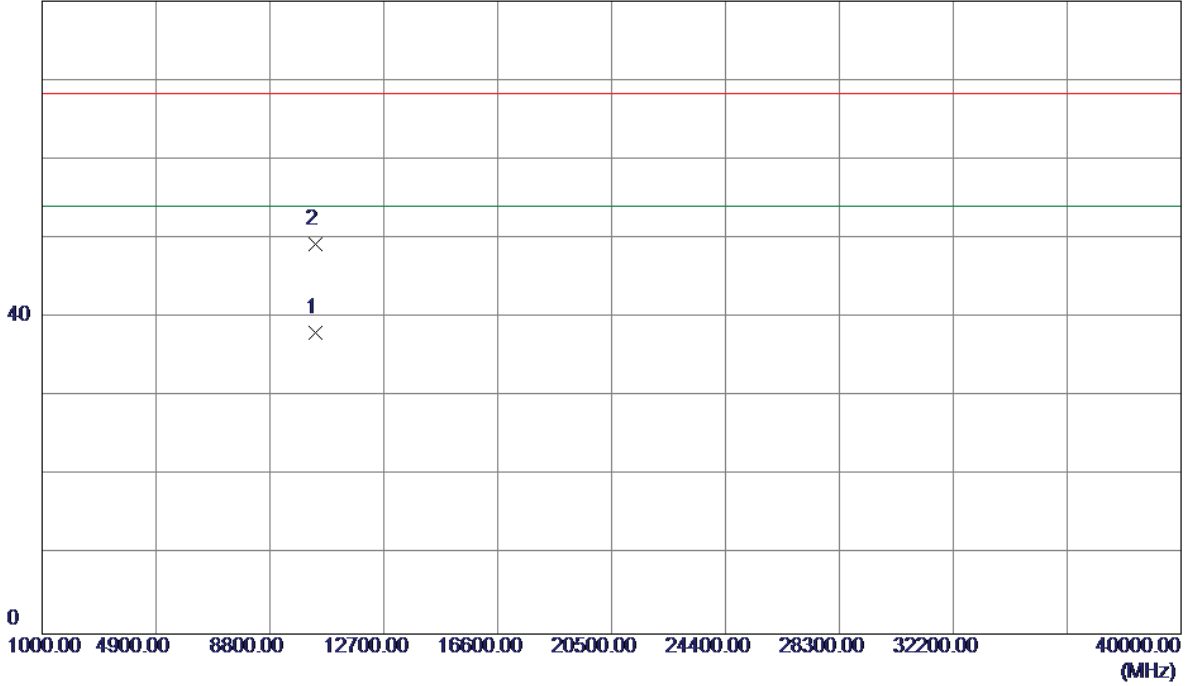

No.	Freq. MHz	Reading Level dBuV/m	Correct Factor dB	Measure ment dBuV/m	Limit dBuV/m	Margin dB	Detector	Comment
1 *	10380.0300	20.95	17.16	38.11	54.00	-15.89	AVG	
2	10380.4140	32.13	17.16	49.29	68.30	-19.01	Peak	

Orthogonal Axis:	X
Test Mode:	UNII-1/ TX AC40 Mode 5190MHz

Horizontal

130 dBuV/m

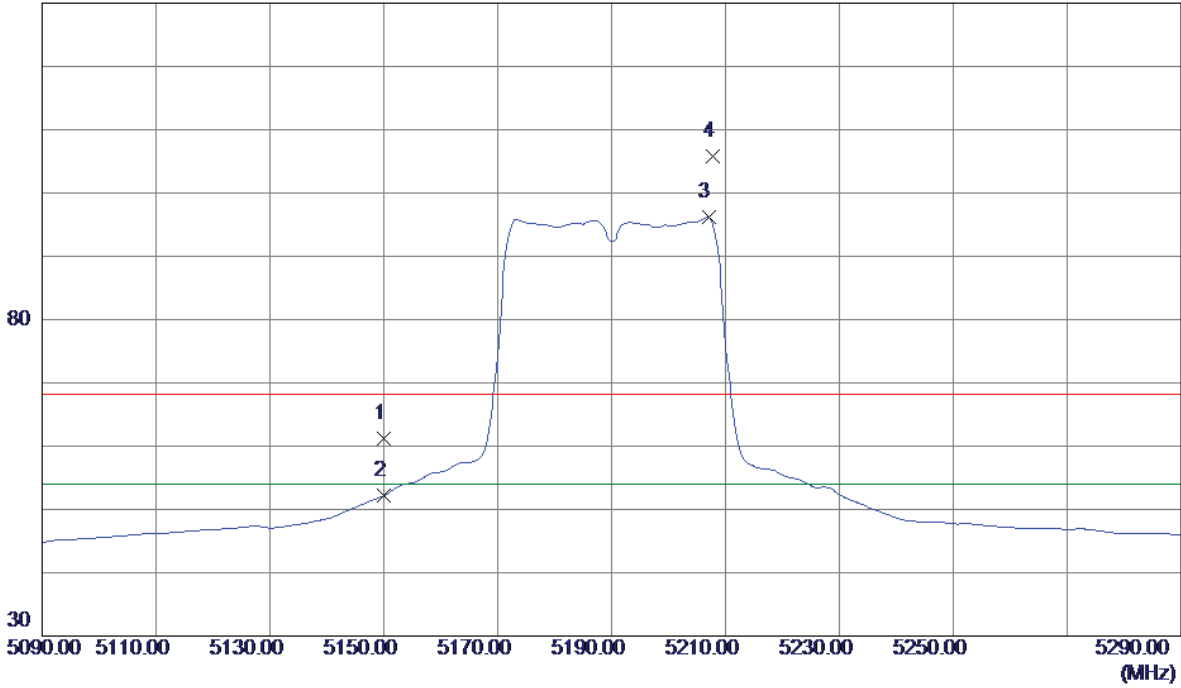

No.	Freq. MHz	Reading Level dBuV/m	Correct Factor dB	Measure ment dBuV/m	Limit dBuV/m	Margin dB	Detector	Comment
1	5150.0000	20.07	41.10	61.17	68.30	-7.13	Peak	
2	5150.0000	11.07	41.10	52.17	54.00	-1.83	AVG	
3 *	5207.0000	54.81	41.39	96.20	54.00	42.20	AVG	No Limit
4	5207.8000	64.46	41.40	105.86	68.30	37.56	Peak	No Limit

Orthogonal Axis:	X
Test Mode:	UNII-1/ TX AC40 Mode 5190MHz

Horizontal

80 dBuV/m

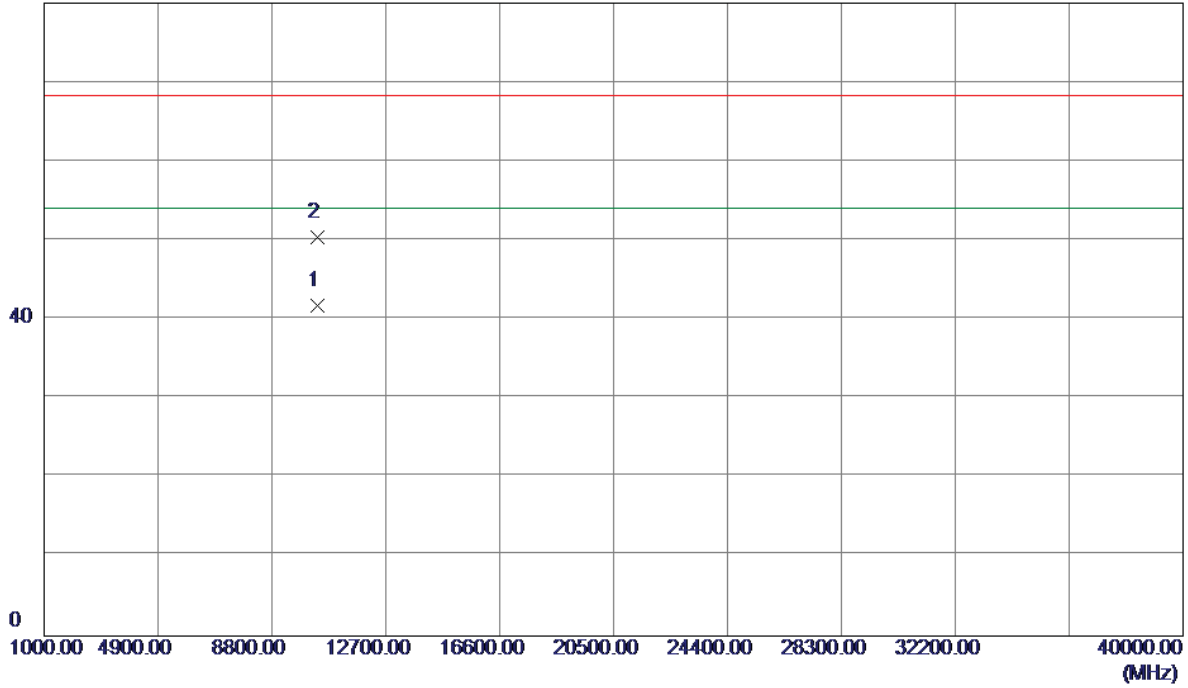

No.	Freq. MHz	Reading Level dBuV/m	Correct Factor dB	Measure ment dBuV/m	Limit dBuV/m	Margin dB	Detector	Comment
1 *	10379.8019	24.63	17.16	41.79	54.00	-12.21	AVG	
2	10379.8500	33.32	17.16	50.48	68.30	-17.82	Peak	

Orthogonal Axis:	X
Test Mode:	UNII-1/ TX AC40 Mode 5230MHz

Vertical

130 dBuV/m

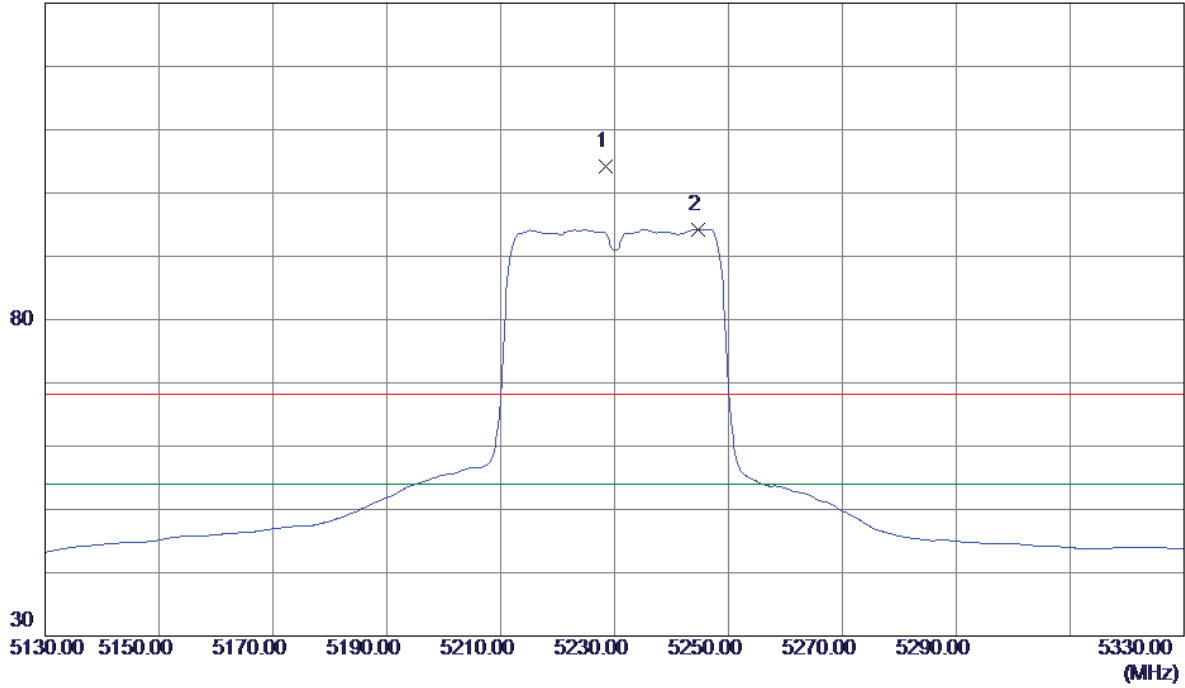

No.	Freq. MHz	Reading Level dBuV/m	Correct Factor dB	Measure ment dBuV/m	Limit dBuV/m	Margin dB	Detector	Comment
1	5228.4000	62.62	41.50	104.12	68.30	35.82	Peak	No Limit
2 *	5244.6000	52.70	41.58	94.28	54.00	40.28	AVG	No Limit

Orthogonal Axis:	X
Test Mode:	UNII-1/ TX AC40 Mode 5230MHz

Vertical

80 dBuV/m

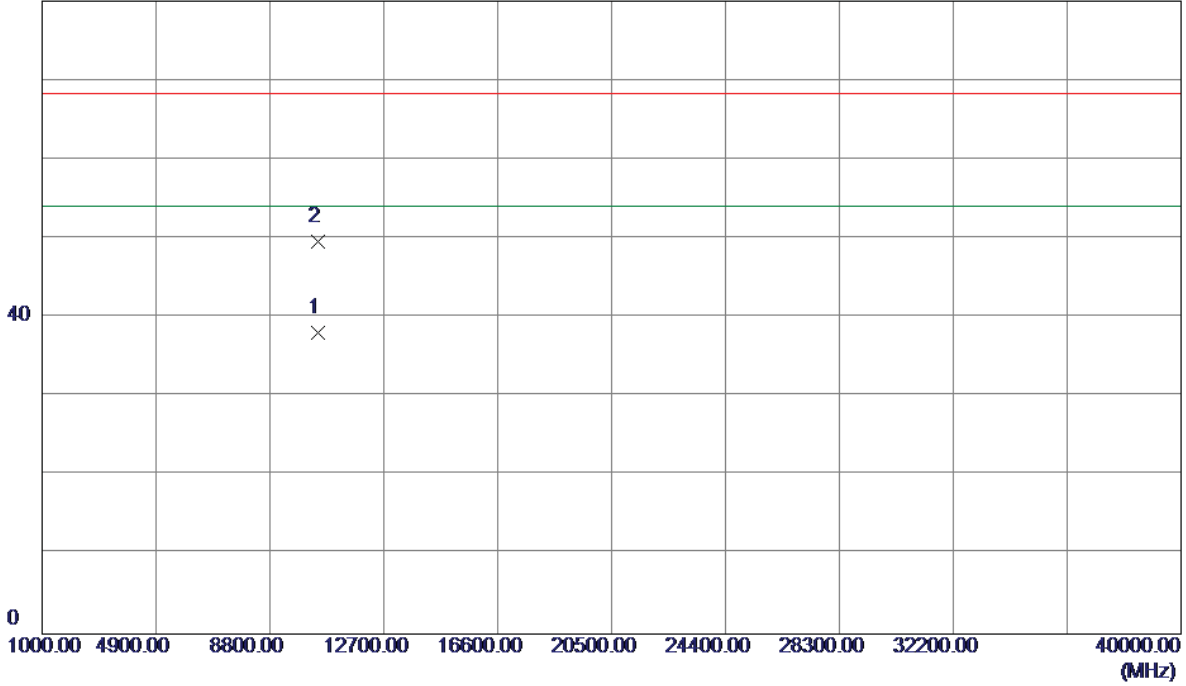

No.	Freq. MHz	Reading Level dBuV/m	Correct Factor dB	Measure ment dBuV/m	Limit dBuV/m	Margin dB	Detector	Comment
1 *	10459.9460	20.66	17.39	38.05	54.00	-15.95	AVG	
2	10460.6100	32.25	17.39	49.64	68.30	-18.66	Peak	

Orthogonal Axis:	X
Test Mode:	UNII-1/ TX AC40 Mode 5230MHz

Horizontal

130 dBuV/m

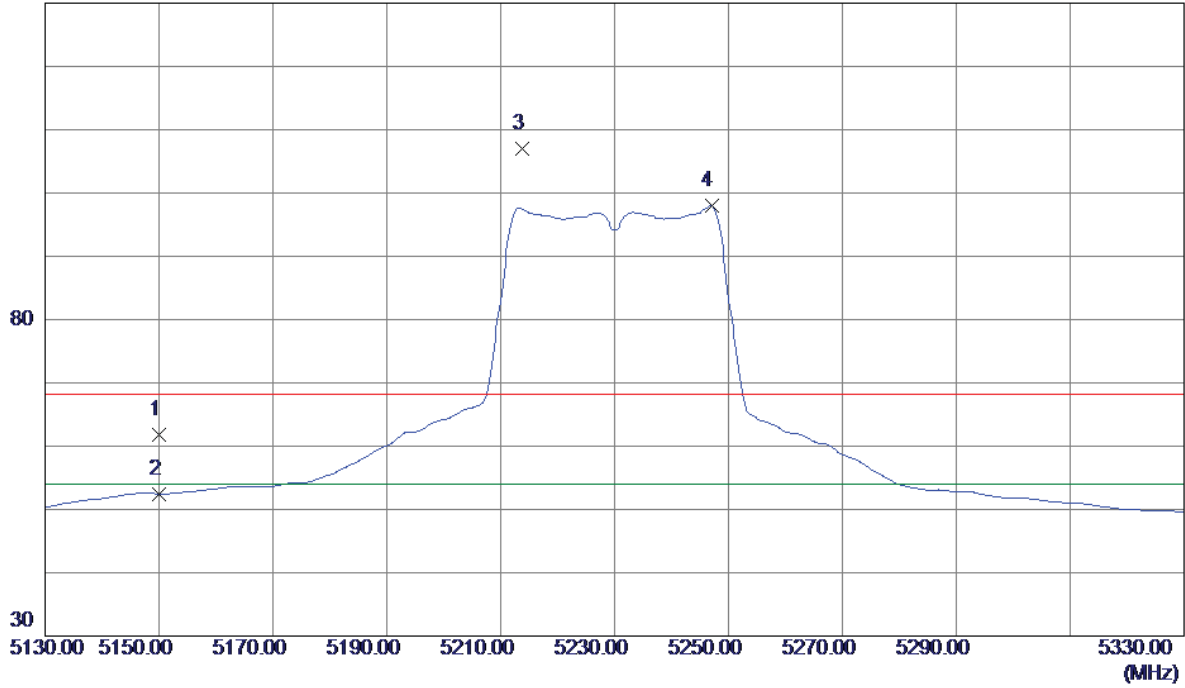

No.	Freq. MHz	Reading Level dBuV/m	Correct Factor dB	Measure ment dBuV/m	Limit dBuV/m	Margin dB	Detector	Comment
1	5150.0000	20.74	41.10	61.84	68.30	-6.46	Peak	
2	5150.0000	11.37	41.10	52.47	54.00	-1.53	AVG	
3	5213.8000	65.57	41.43	107.00	68.30	38.70	Peak	No Limit
4 *	5247.0000	56.43	41.59	98.02	54.00	44.02	AVG	No Limit

Orthogonal Axis:	X
Test Mode:	UNII-1/ TX AC40 Mode 5230MHz

Horizontal

80 dBuV/m

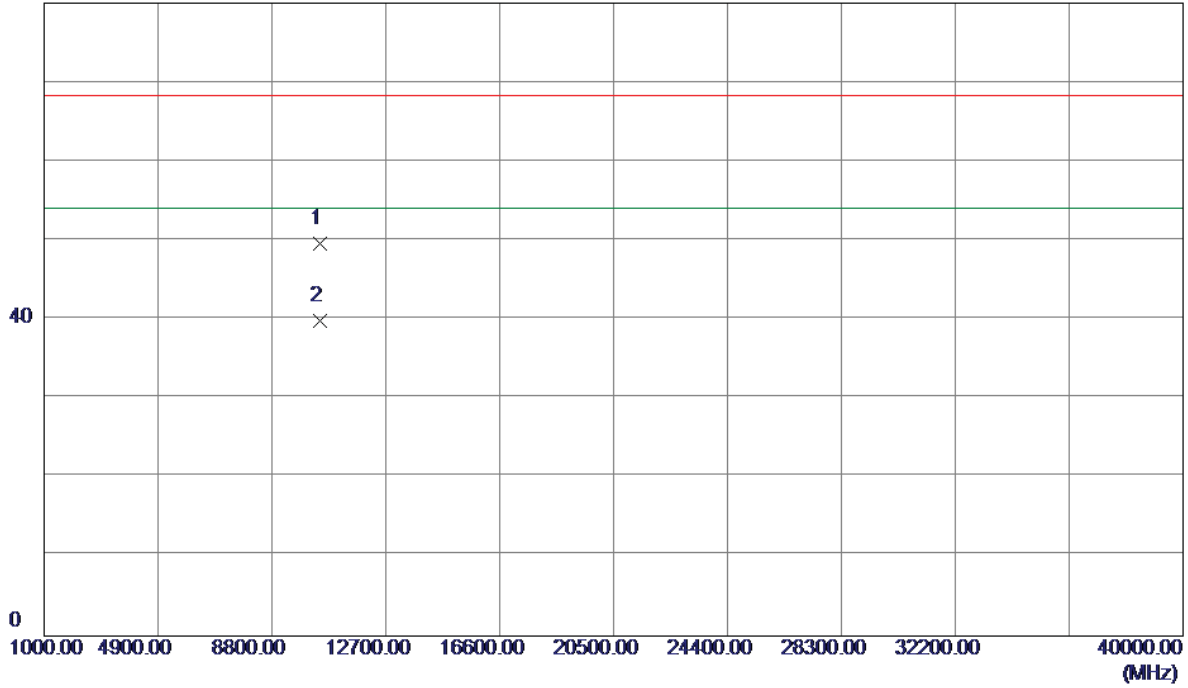

No.	Freq. MHz	Reading Level dBuV/m	Correct Factor dB	Measure ment dBuV/m	Limit dBuV/m	Margin dB	Detector	Comment
1	10459.4460	32.24	17.39	49.63	68.30	-18.67	Peak	
2 *	10459.9540	22.52	17.39	39.91	54.00	-14.09	AVG	

Orthogonal Axis:	X
Test Mode:	UNII-1/ TX AC80 Mode 5210MHz

Vertical

130 dBuV/m

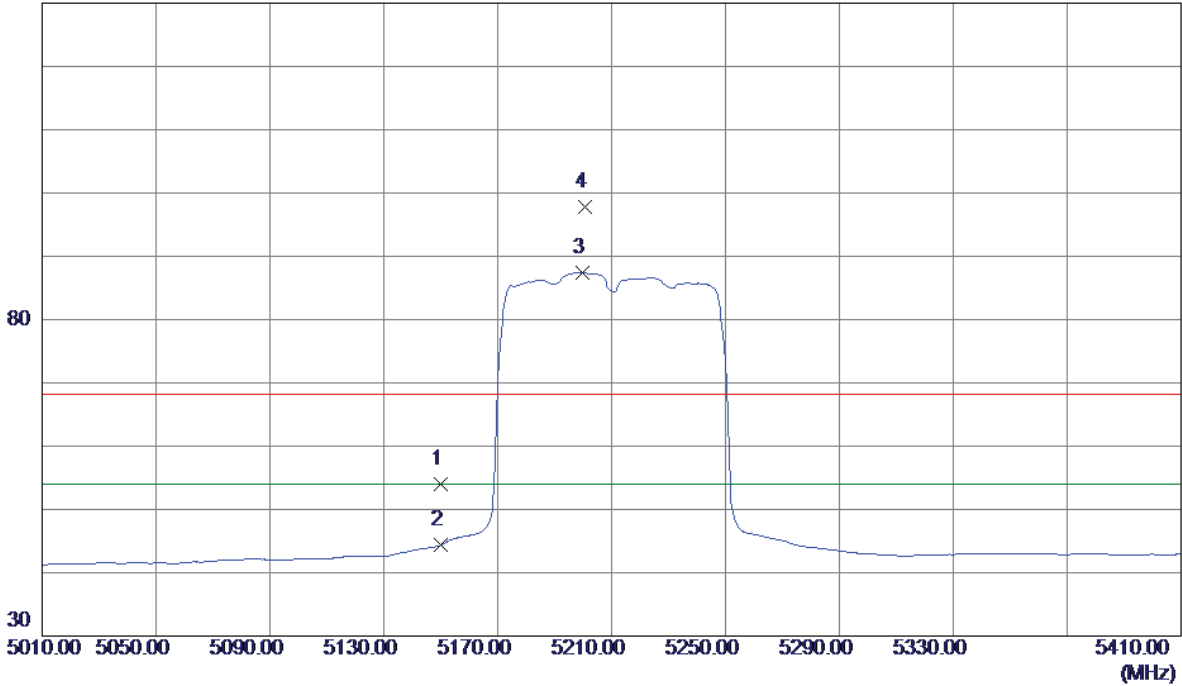

No.	Freq. MHz	Reading Level dBuV/m	Correct Factor dB	Measure ment dBuV/m	Limit dBuV/m	Margin dB	Detector	Comment
1	5150.0000	12.81	41.10	53.91	68.30	-14.39	Peak	
2	5150.0000	3.27	41.10	44.37	54.00	-9.63	AVG	
3 *	5199.6000	46.03	41.35	87.38	54.00	33.38	AVG	No Limit
4	5200.8000	56.45	41.36	97.81	68.30	29.51	Peak	No Limit

Orthogonal Axis:	X
Test Mode:	UNII-1/ TX AC80 Mode 5210MHz

Vertical

80 dBuV/m

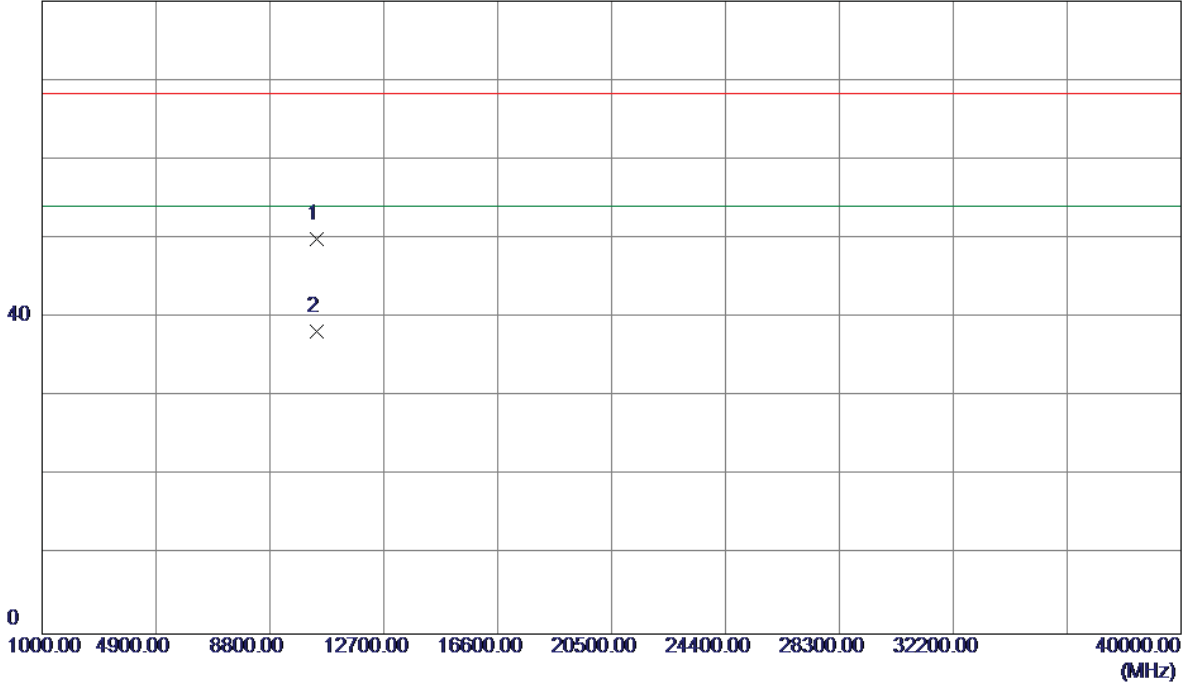

No.	Freq. MHz	Reading Level dBuV/m	Correct Factor dB	Measure ment dBuV/m	Limit dBuV/m	Margin dB	Detector	Comment
1	10419.4660	32.72	17.27	49.99	68.30	-18.31	Peak	
2 *	10419.8580	20.91	17.27	38.18	54.00	-15.82	AVG	

Orthogonal Axis:	X
Test Mode:	UNII-1/ TX AC80 Mode 5210MHz

Horizontal

130 dBuV/m

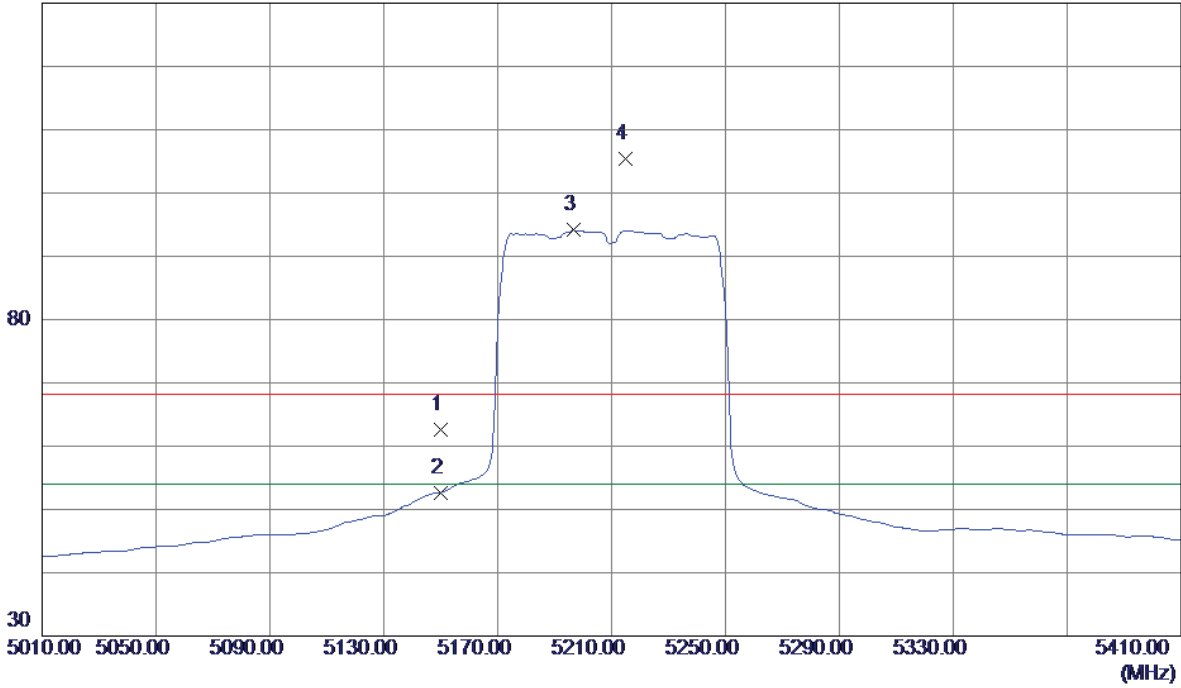

No.	Freq. MHz	Reading Level dBuV/m	Correct Factor dB	Measure ment dBuV/m	Limit dBuV/m	Margin dB	Detector	Comment
1	5150.0000	21.46	41.10	62.56	68.30	-5.74	Peak	
2	5150.0000	11.59	41.10	52.69	54.00	-1.31	AVG	
3 *	5196.8000	52.78	41.34	94.12	54.00	40.12	AVG	No Limit
4	5214.8000	63.88	41.43	105.31	68.30	37.01	Peak	No Limit

Orthogonal Axis:	X
Test Mode:	UNII-1/ TX AC80 Mode 5210MHz

Horizontal

80 dBuV/m

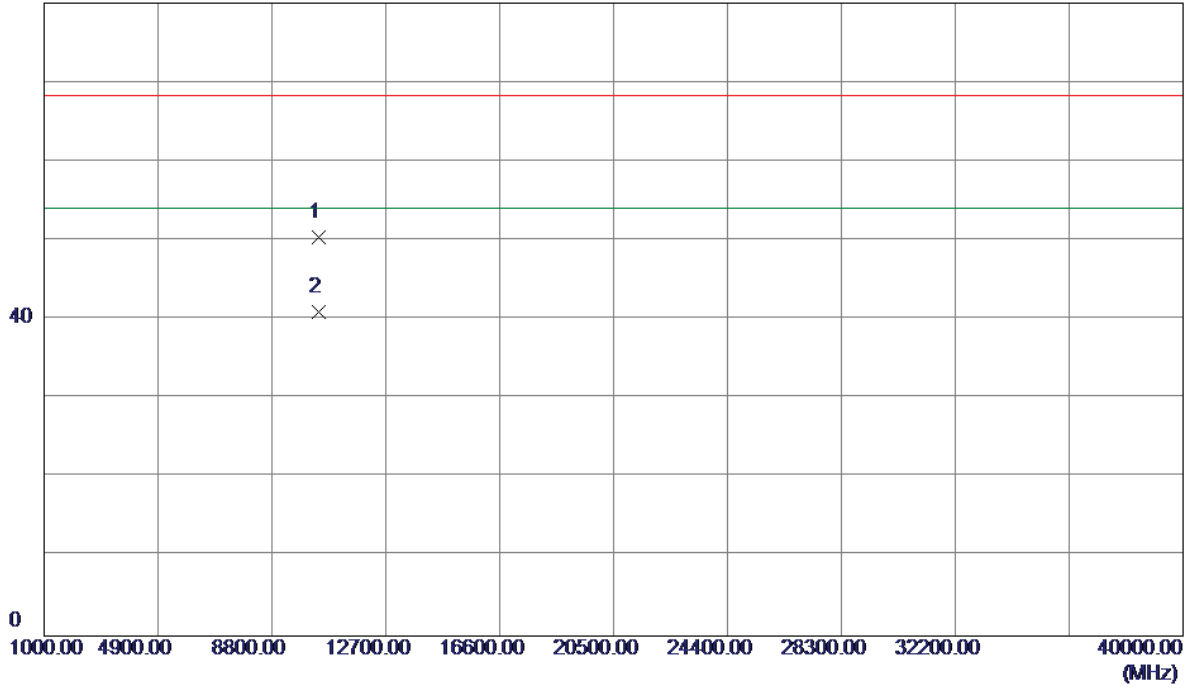

No.	Freq. MHz	Reading Level dBuV/m	Correct Factor dB	Measure ment dBuV/m	Limit dBuV/m	Margin dB	Detector	Comment
1	10419.6720	33.10	17.27	50.37	68.30	-17.93	Peak	
2 *	10419.8820	23.66	17.27	40.93	54.00	-13.07	AVG	

Orthogonal Axis:	X
Test Mode:	UNII-3/TX AC20 Mode 5745MHz

Vertical

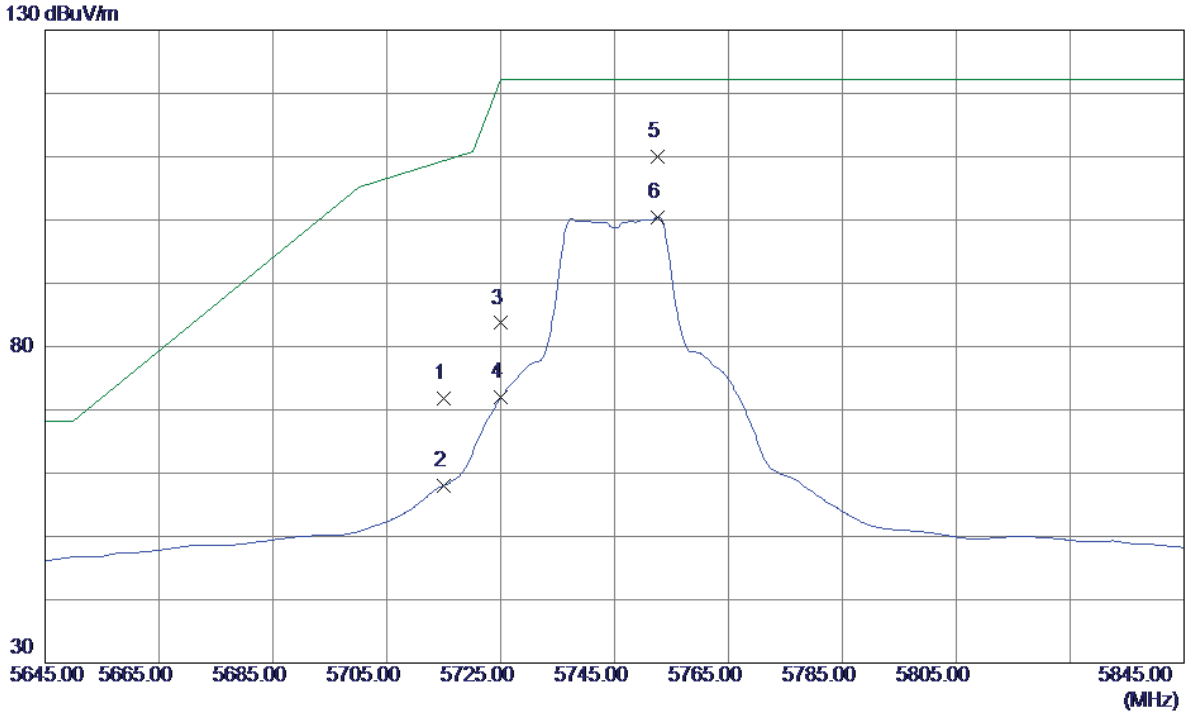

No.	Freq. MHz	Reading Level dBuV/m	Correct Factor dB	Measure ment dBuV/m	Limit dBuV/m	Margin dB	Detector	Comment
1	5715.0000	28.21	43.53	71.74	109.40	-37.66	Peak	
2	5715.0000	14.51	43.53	58.04	109.40	-51.36	AVG	
3	5725.0000	40.14	43.56	83.70	122.20	-38.50	Peak	
4	5725.0000	28.37	43.56	71.93	122.20	-50.27	AVG	
5 *	5752.6000	66.43	43.64	110.07	122.20	-12.13	Peak	
6	5752.6000	56.80	43.64	100.44	122.20	-21.76	AVG	

Orthogonal Axis:	X
Test Mode:	UNII-3/TX AC20 Mode 5745MHz

Vertical

80 dBuV/m

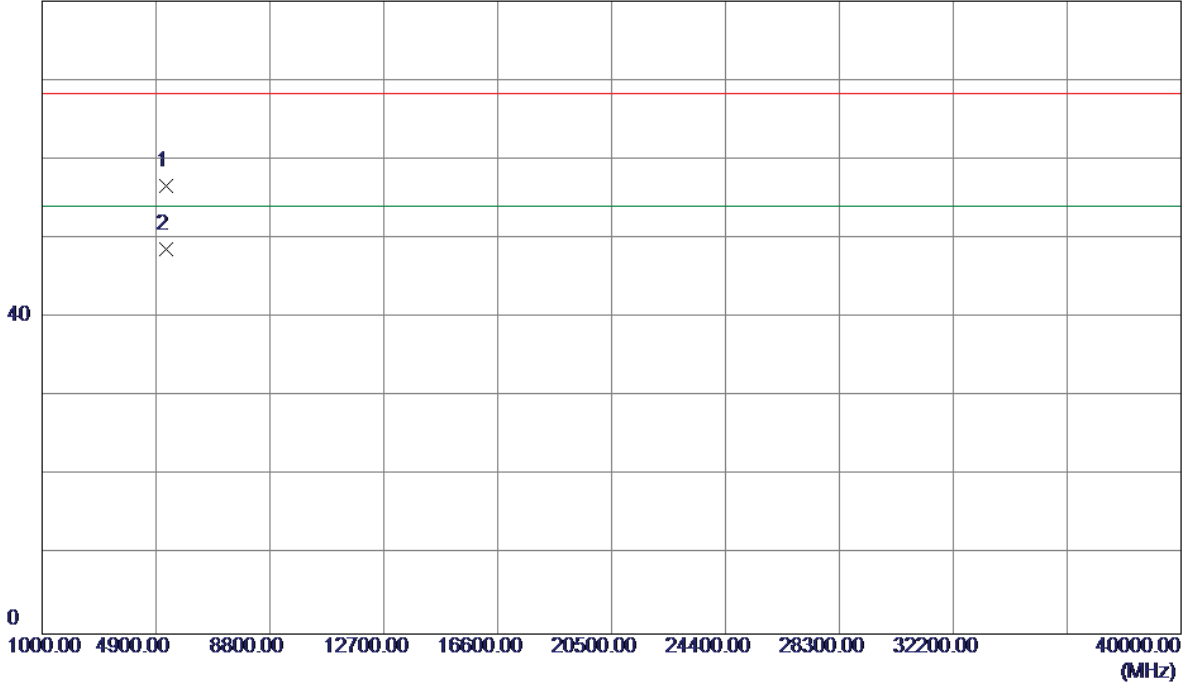

No.	Freq. MHz	Reading Level dBuV/m	Correct Factor dB	Measure ment dBuV/m	Limit dBuV/m	Margin dB	Detector	Comment
1	5261.8500	48.61	8.10	56.71	68.30	-11.59	Peak	
2 *	5266.0500	40.45	8.12	48.57	54.00	-5.43	AVG	

Orthogonal Axis:	X
Test Mode:	UNII-3/TX AC20 Mode 5745MHz

Horizontal

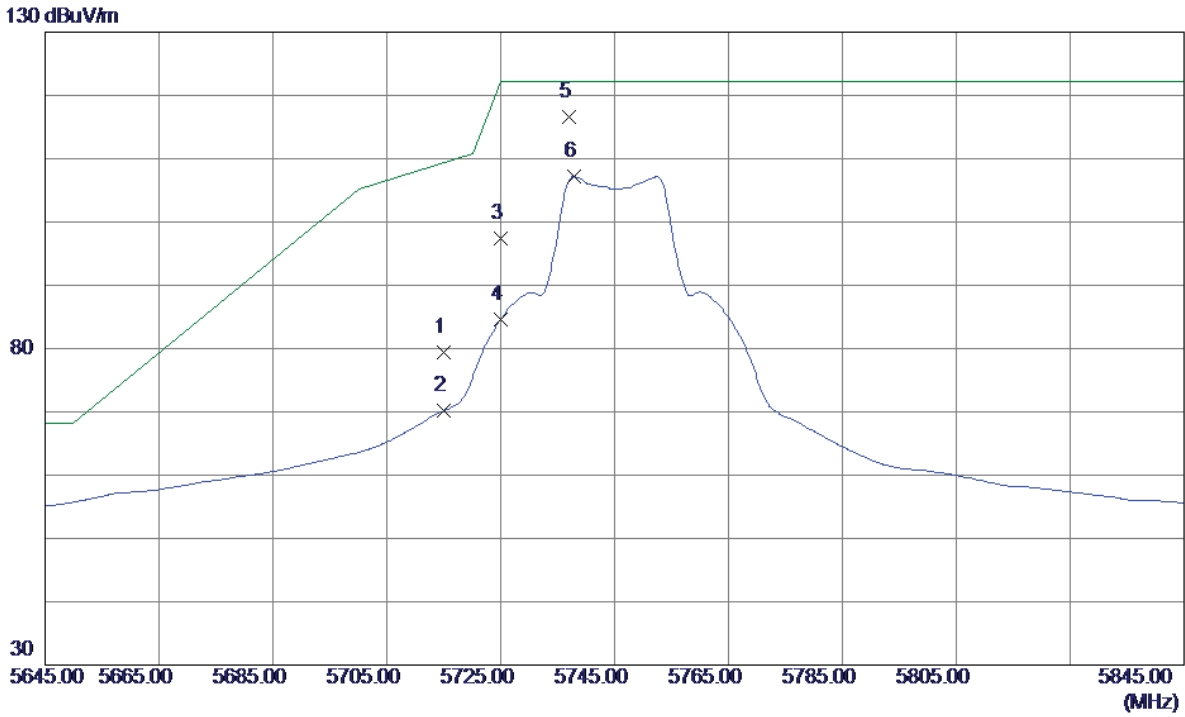

No.	Freq. MHz	Reading Level dBuV/m	Correct Factor dB	Measure ment dBuV/m	Limit dBuV/m	Margin dB	Detector	Comment
1	5715.0000	35.85	43.53	79.38	109.40	-30.02	Peak	
2	5715.0000	26.63	43.53	70.16	109.40	-39.24	AVG	
3	5725.0000	53.89	43.56	97.45	122.20	-24.75	Peak	
4	5725.0000	41.10	43.56	84.66	122.20	-37.54	AVG	
5 *	5737.0000	72.99	43.60	116.59	122.20	-5.61	Peak	
6	5737.8000	63.58	43.60	107.18	122.20	-15.02	AVG	

Orthogonal Axis:	X
Test Mode:	UNII-3/TX AC20 Mode 5745MHz

Horizontal

80 dBuV/m

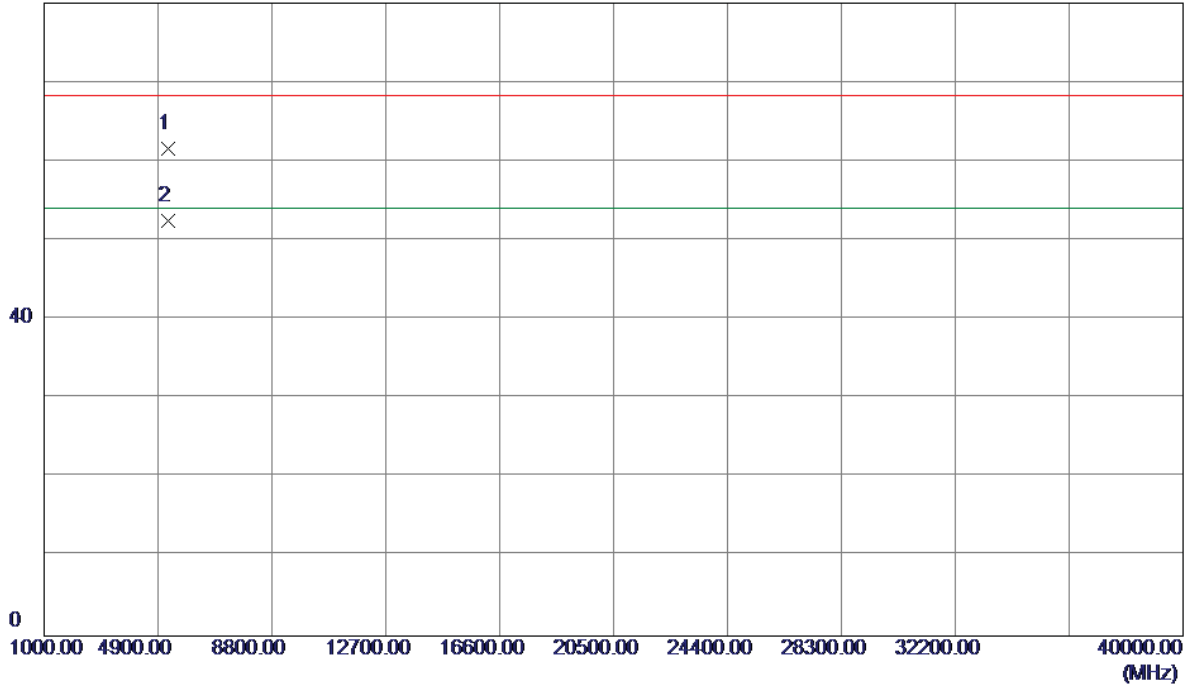

No.	Freq. MHz	Reading Level dBuV/m	Correct Factor dB	Measure ment dBuV/m	Limit dBuV/m	Margin dB	Detector	Comment
1	5261.0500	53.43	8.10	61.53	68.30	-6.77	Peak	
2 *	5266.2000	44.40	8.13	52.53	54.00	-1.47	AVG	

Orthogonal Axis:	X
Test Mode:	UNII-3/TX AC20 Mode 5785MHz

Vertical

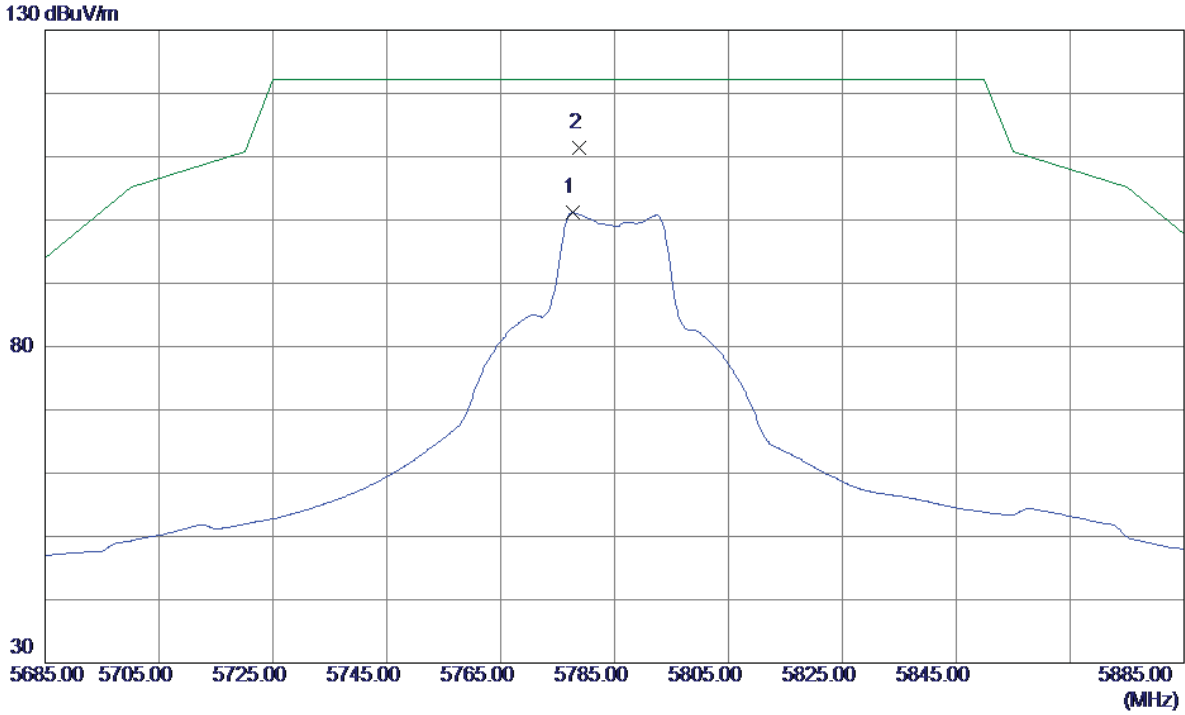

No.	Freq. MHz	Reading Level dBuV/m	Correct Factor dB	Measure ment dBuV/m	Limit dBuV/m	Margin dB	Detector	Comment
1	5777.6000	57.50	43.72	101.22	122.20	-20.98	AVG	
2 *	5778.8000	67.63	43.72	111.35	122.20	-10.85	Peak	

Orthogonal Axis:	X
Test Mode:	UNII-3/TX AC20 Mode 5785MHz

Vertical

80 dBuV/m

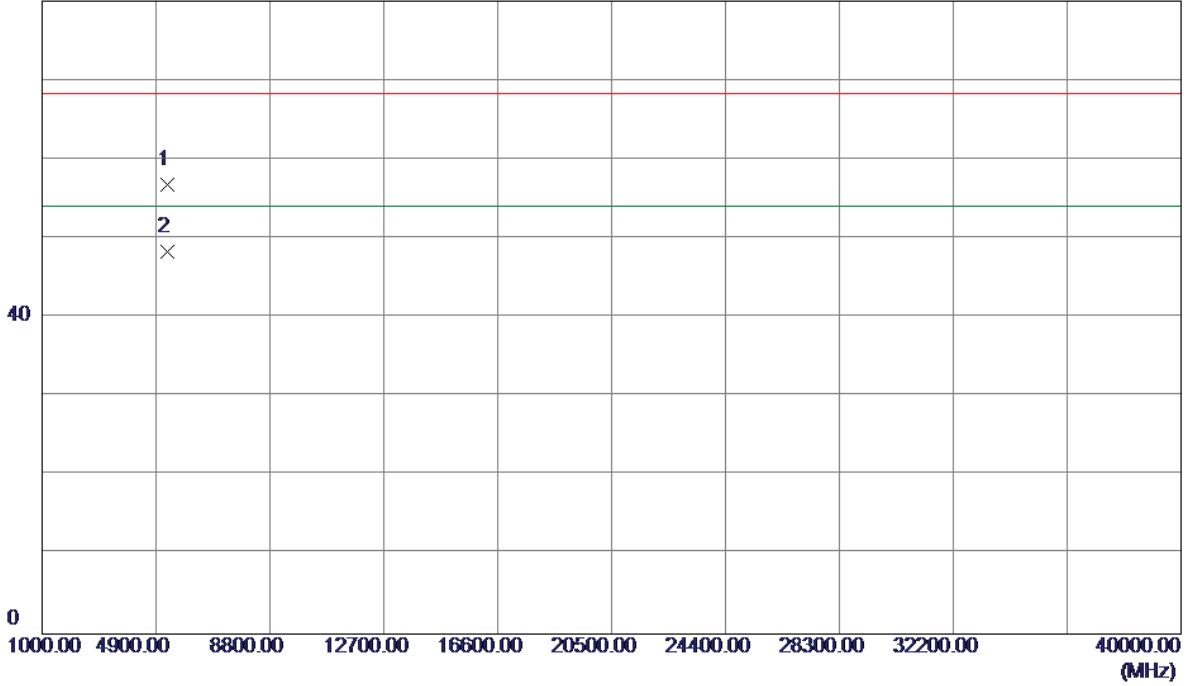

No.	Freq. MHz	Reading Level dBuV/m	Correct Factor dB	Measure ment dBuV/m	Limit dBuV/m	Margin dB	Detector	Comment
1	5297.3000	48.50	8.29	56.79	68.30	-11.51	Peak	
2 *	5299.7000	39.95	8.30	48.25	54.00	-5.75	AVG	

Orthogonal Axis:	X
Test Mode:	UNII-3/TX AC20 Mode 5785MHz

Horizontal

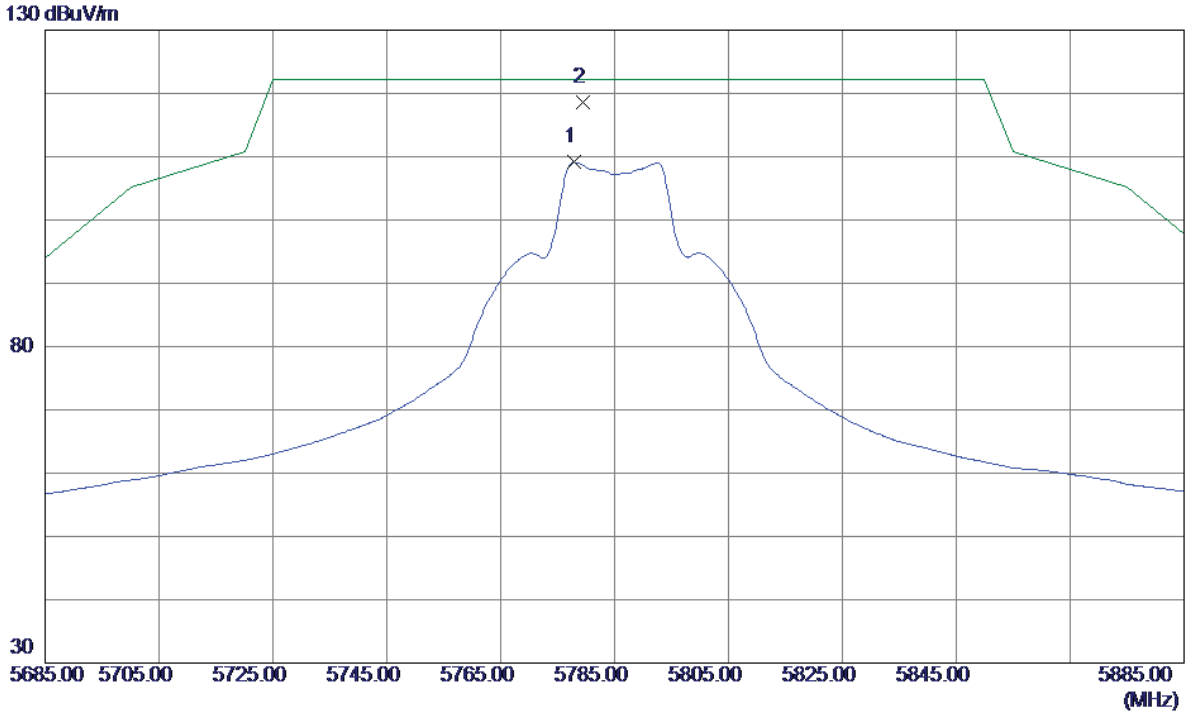

No.	Freq. MHz	Reading Level dBuV/m	Correct Factor dB	Measure ment dBuV/m	Limit dBuV/m	Margin dB	Detector	Comment
1	5777.8000	65.42	43.72	109.14	122.20	-13.06	AVG	
2 *	5779.4000	74.83	43.72	118.55	122.20	-3.65	Peak	

Orthogonal Axis:	X
Test Mode:	UNII-3/TX AC20 Mode 5785MHz

Horizontal

80 dBuV/m

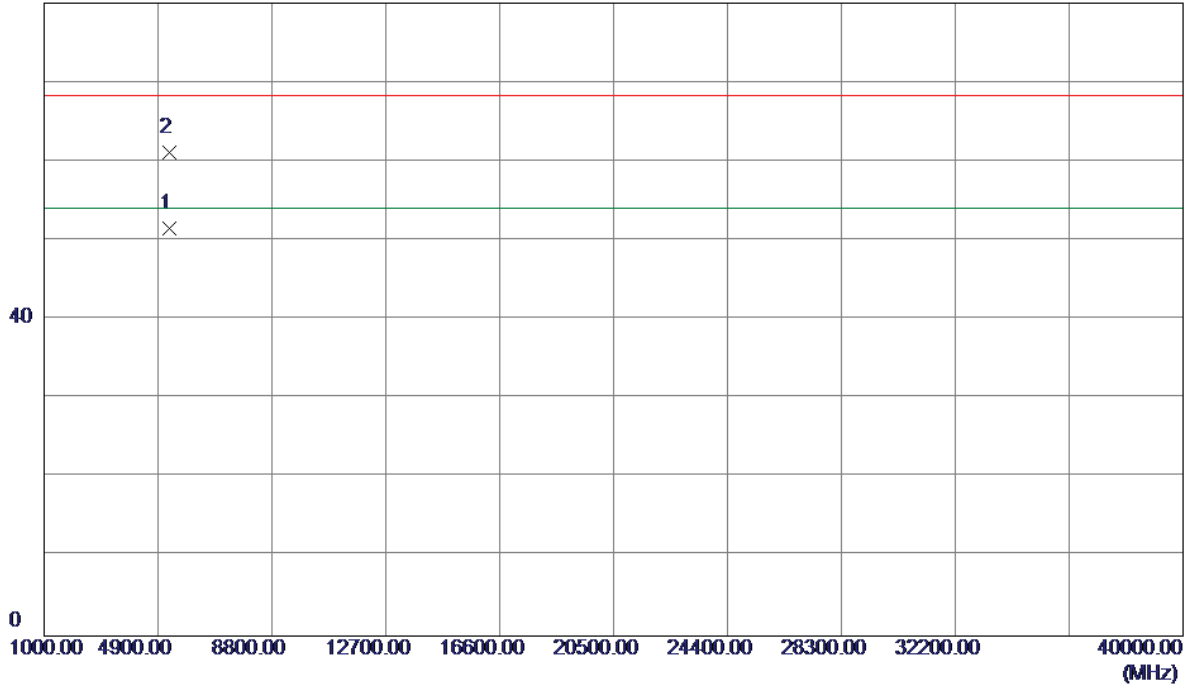

No.	Freq. MHz	Reading Level dBuV/m	Correct Factor dB	Measure ment dBuV/m	Limit dBuV/m	Margin dB	Detector	Comment
1 *	5298.8000	43.23	8.29	51.52	54.00	-2.48	AVG	
2	5300.7000	52.79	8.30	61.09	68.30	-7.21	Peak	

Orthogonal Axis:	X
Test Mode:	UNII-3/TX AC20 Mode 5825MHz

Vertical

130 dBuV/m

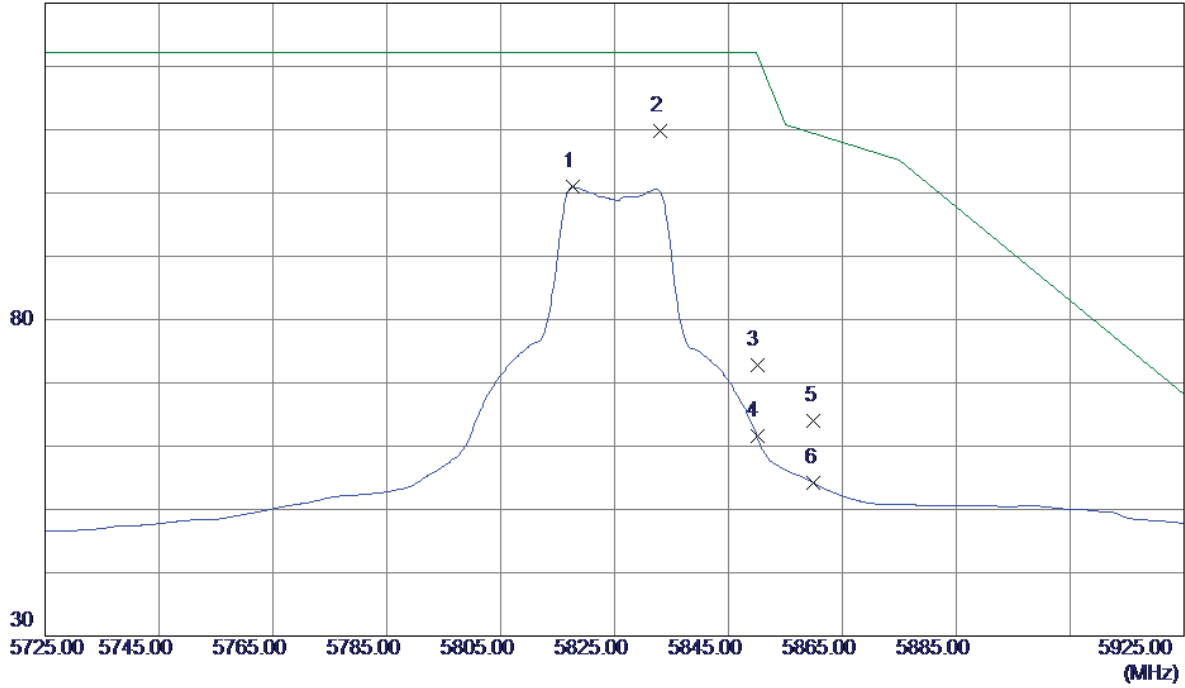

No.	Freq. MHz	Reading Level dBuV/m	Correct Factor dB	Measure ment dBuV/m	Limit dBuV/m	Margin dB	Detector	Comment
1	5817.6000	57.15	43.84	100.99	122.20	-21.21	AVG	
2 *	5833.0000	65.93	43.89	109.82	122.20	-12.38	Peak	
3	5850.0000	28.84	43.94	72.78	122.20	-49.42	Peak	
4	5850.0000	17.67	43.94	61.61	122.20	-60.59	AVG	
5	5860.0000	20.09	43.97	64.06	109.40	-45.34	Peak	
6	5860.0000	10.18	43.97	54.15	109.40	-55.25	AVG	

Orthogonal Axis:	X
Test Mode:	UNII-3/TX AC20 Mode 5825MHz

Vertical

80 dBuV/m

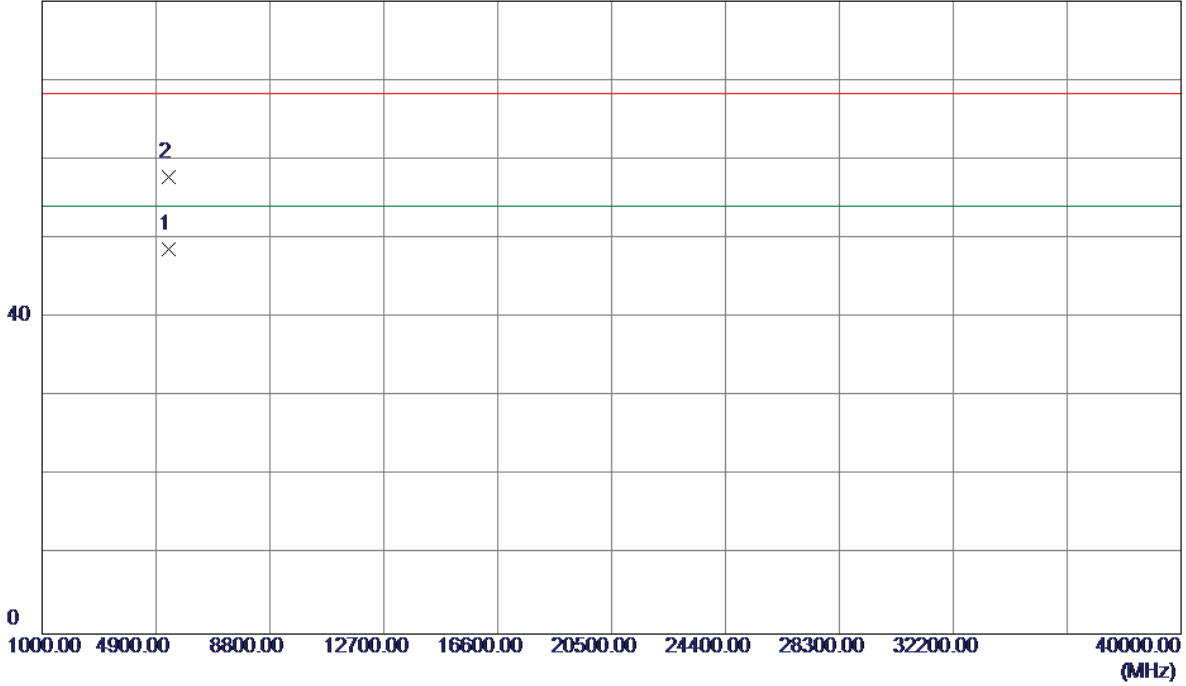

No.	Freq. MHz	Reading Level dBuV/m	Correct Factor dB	Measure ment dBuV/m	Limit dBuV/m	Margin dB	Detector	Comment
1 *	5333.0259	40.20	8.47	48.67	54.00	-5.33	AVG	
2	5343.9760	49.27	8.52	57.79	68.30	-10.51	Peak	

Orthogonal Axis:	X
Test Mode:	UNII-3/TX AC20 Mode 5825MHz

Horizontal

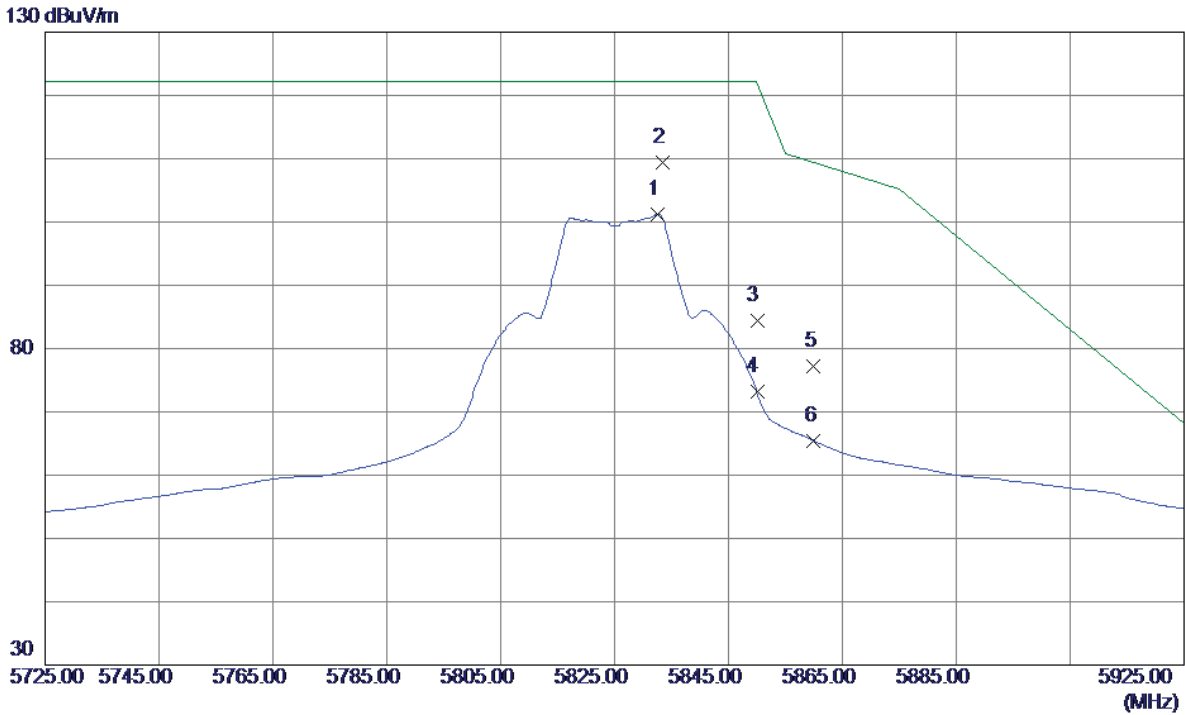

No.	Freq. MHz	Reading Level dBuV/m	Correct Factor dB	Measure ment dBuV/m	Limit dBuV/m	Margin dB	Detector	Comment
1	5832.6000	57.37	43.88	101.25	122.20	-20.95	AVG	
2 *	5833.4000	65.51	43.89	109.40	122.20	-12.80	Peak	
3	5850.0000	40.55	43.94	84.49	122.20	-37.71	Peak	
4	5850.0000	29.31	43.94	73.25	122.20	-48.95	AVG	
5	5860.0000	33.25	43.97	77.22	109.40	-32.18	Peak	
6	5860.0000	21.47	43.97	65.44	109.40	-43.96	AVG	

Orthogonal Axis:	X
Test Mode:	UNII-3/TX AC20 Mode 5825MHz

Horizontal

80 dBuV/m

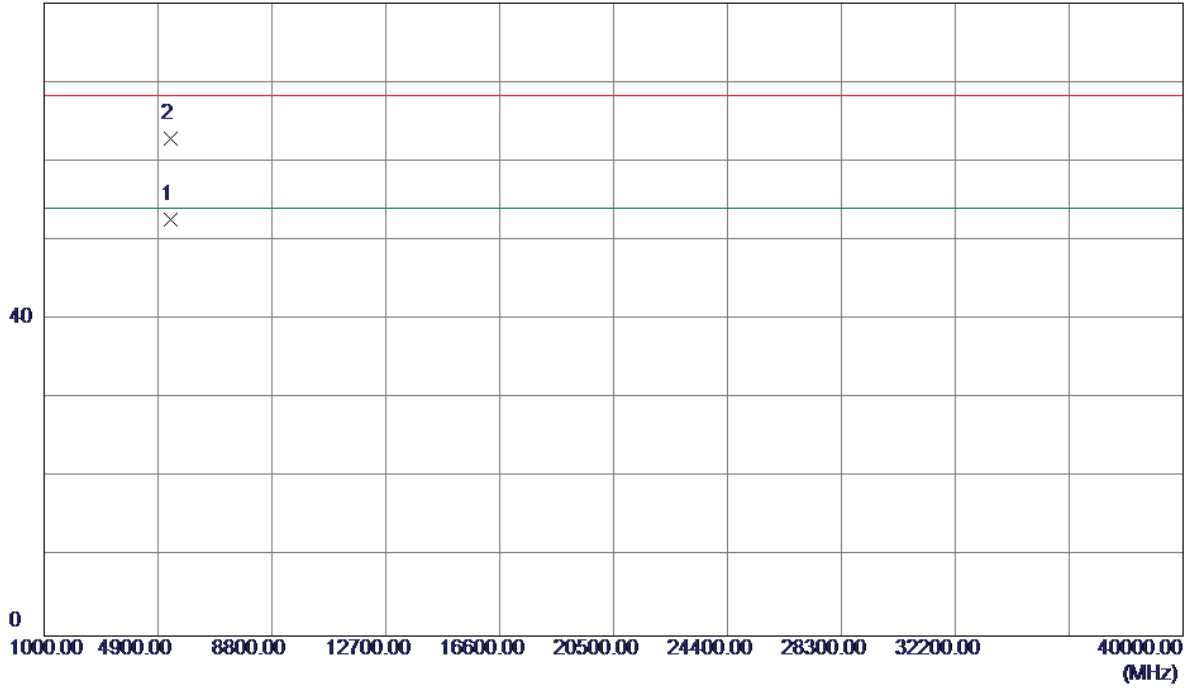

No.	Freq. MHz	Reading Level dBuV/m	Correct Factor dB	Measure ment dBuV/m	Limit dBuV/m	Margin dB	Detector	Comment
1 *	5331.5000	44.16	8.46	52.62	54.00	-1.38	AVG	
2	5338.1000	54.35	8.49	62.84	68.30	-5.46	Peak	

Orthogonal Axis:	X
Test Mode:	UNII-3/TX AC40 Mode 5755MHz

Vertical

130 dBuV/m

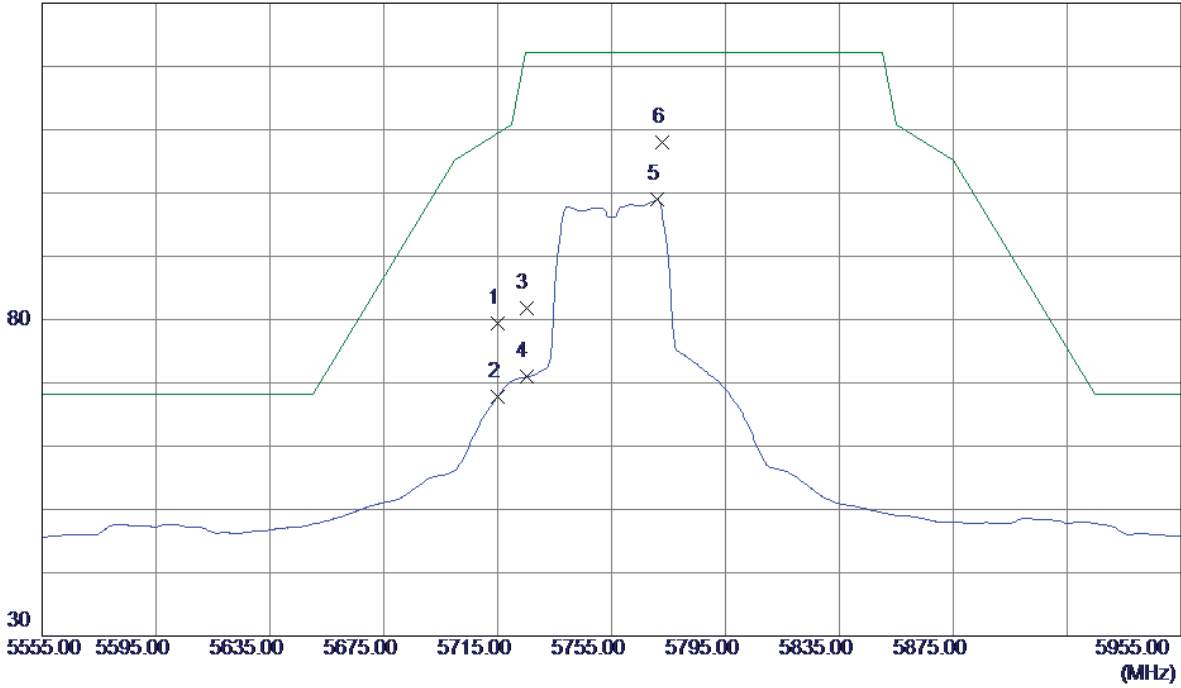

No.	Freq. MHz	Reading Level dBuV/m	Correct Factor dB	Measure ment dBuV/m	Limit dBuV/m	Margin dB	Detector	Comment
1	5715.0000	35.87	43.53	79.40	109.40	-30.00	Peak	
2	5715.0000	24.33	43.53	67.86	109.40	-41.54	AVG	
3	5725.0000	38.20	43.56	81.76	122.20	-40.44	Peak	
4	5725.0000	27.36	43.56	70.92	122.20	-51.28	AVG	
5	5771.0000	55.23	43.70	98.93	122.20	-23.27	AVG	
6 *	5772.6000	64.32	43.70	108.02	122.20	-14.18	Peak	

Orthogonal Axis:	X
Test Mode:	UNII-3/TX AC40 Mode 5755MHz

Vertical

80 dBuV/m

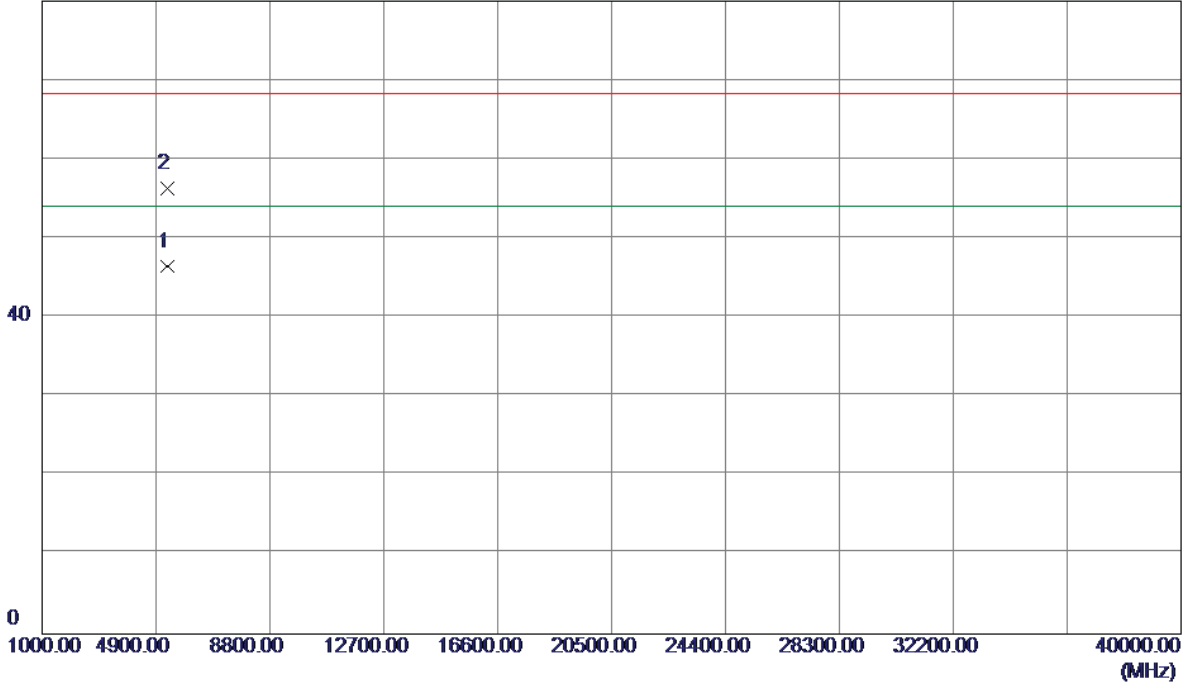

No.	Freq. MHz	Reading Level dBuV/m	Correct Factor dB	Measure ment dBuV/m	Limit dBuV/m	Margin dB	Detector	Comment
1 *	5275.3500	38.31	8.17	46.48	54.00	-7.52	AVG	
2	5275.5099	48.15	8.17	56.32	68.30	-11.98	Peak	

Orthogonal Axis:	X
Test Mode:	UNII-3/TX AC40 Mode 5755MHz

Horizontal

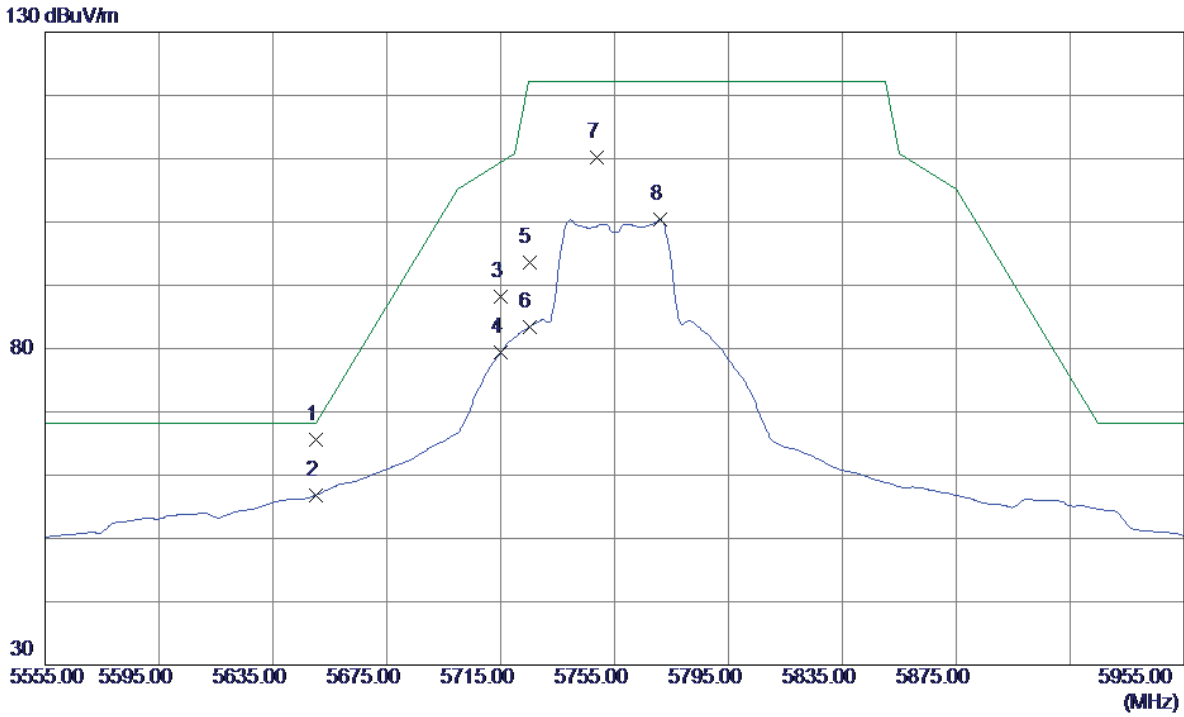

No.	Freq. MHz	Reading Level dBuV/m	Correct Factor dB	Measure ment dBuV/m	Limit dBuV/m	Margin dB	Detector	Comment
1 *	5650.0000	22.30	43.33	65.63	68.20	-2.57	Peak	
2	5650.0000	13.53	43.33	56.86	68.20	-11.34	AVG	
3	5715.0000	44.71	43.53	88.24	109.40	-21.16	Peak	
4	5715.0000	35.87	43.53	79.40	109.40	-30.00	AVG	
5	5725.0000	50.07	43.56	93.63	122.20	-28.57	Peak	
6	5725.0000	39.77	43.56	83.33	122.20	-38.87	AVG	
7	5748.6000	66.65	43.63	110.28	122.20	-11.92	Peak	
8	5771.0000	56.67	43.70	100.37	122.20	-21.83	AVG	

Orthogonal Axis:	X
Test Mode:	UNII-3/TX AC40 Mode 5755MHz

Horizontal

80 dBuV/m

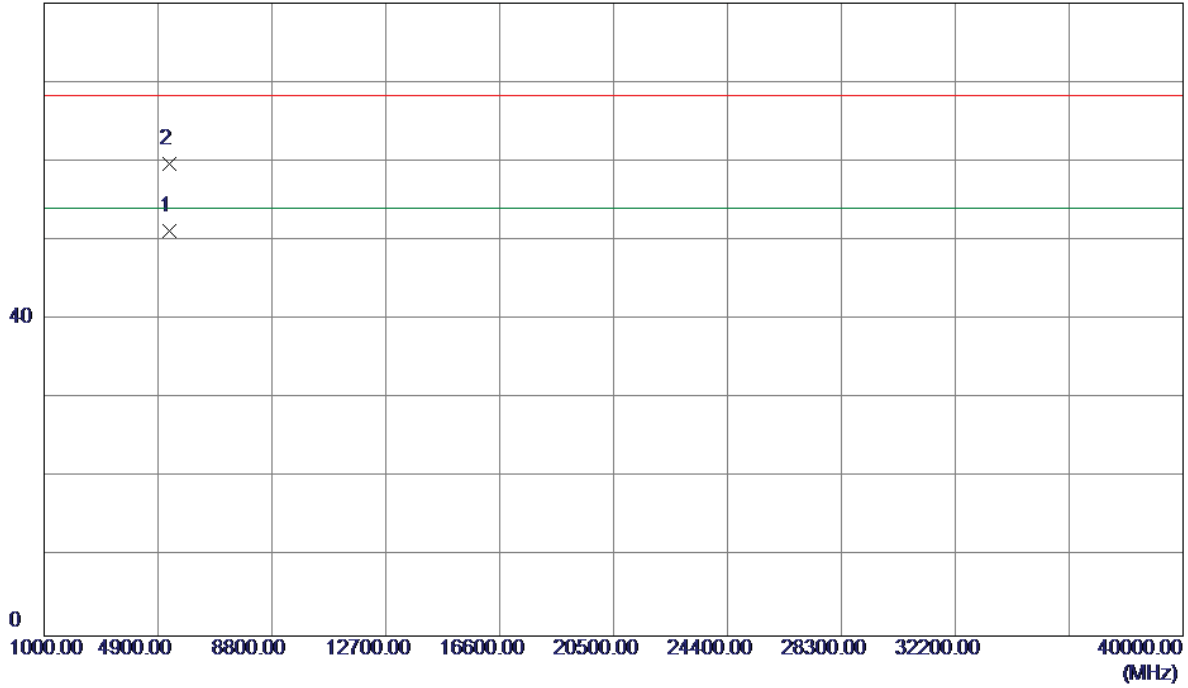

No.	Freq. MHz	Reading Level dBuV/m	Correct Factor dB	Measure ment dBuV/m	Limit dBuV/m	Margin dB	Detector	Comment
1 *	5275.3150	43.04	8.17	51.21	54.00	-2.79	AVG	
2	5275.5050	51.44	8.17	59.61	68.30	-8.69	Peak	

Orthogonal Axis:	X
Test Mode:	UNII-3/TX AC40 Mode 5795MHz

Vertical

130 dBuV/m

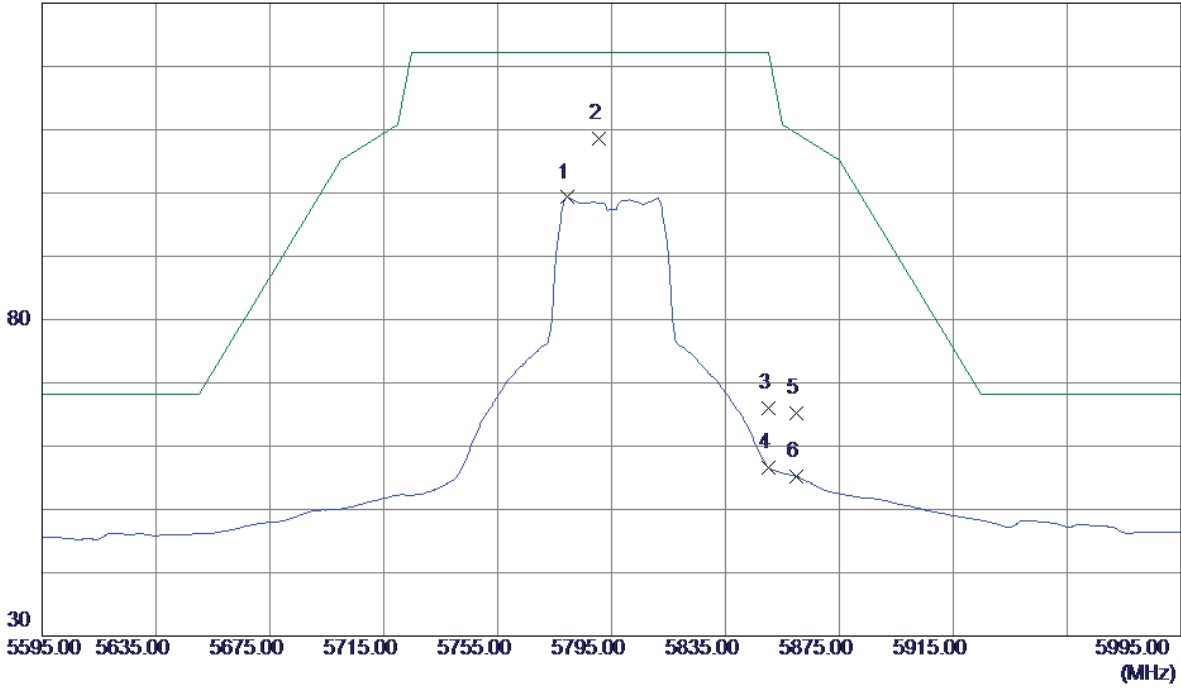

No.	Freq. MHz	Reading Level dBuV/m	Correct Factor dB	Measure ment dBuV/m	Limit dBuV/m	Margin dB	Detector	Comment
1	5779.4000	55.58	43.72	99.30	122.20	-22.90	AVG	
2 *	5790.6000	64.84	43.76	108.60	122.20	-13.60	Peak	
3	5850.0000	22.11	43.94	66.05	122.20	-56.15	Peak	
4	5850.0000	12.63	43.94	56.57	122.20	-65.63	AVG	
5	5860.0000	21.21	43.97	65.18	109.40	-44.22	Peak	
6	5860.0000	11.23	43.97	55.20	109.40	-54.20	AVG	

Orthogonal Axis:	X
Test Mode:	UNII-3/TX AC40 Mode 5795MHz

Vertical

80 dBuV/m

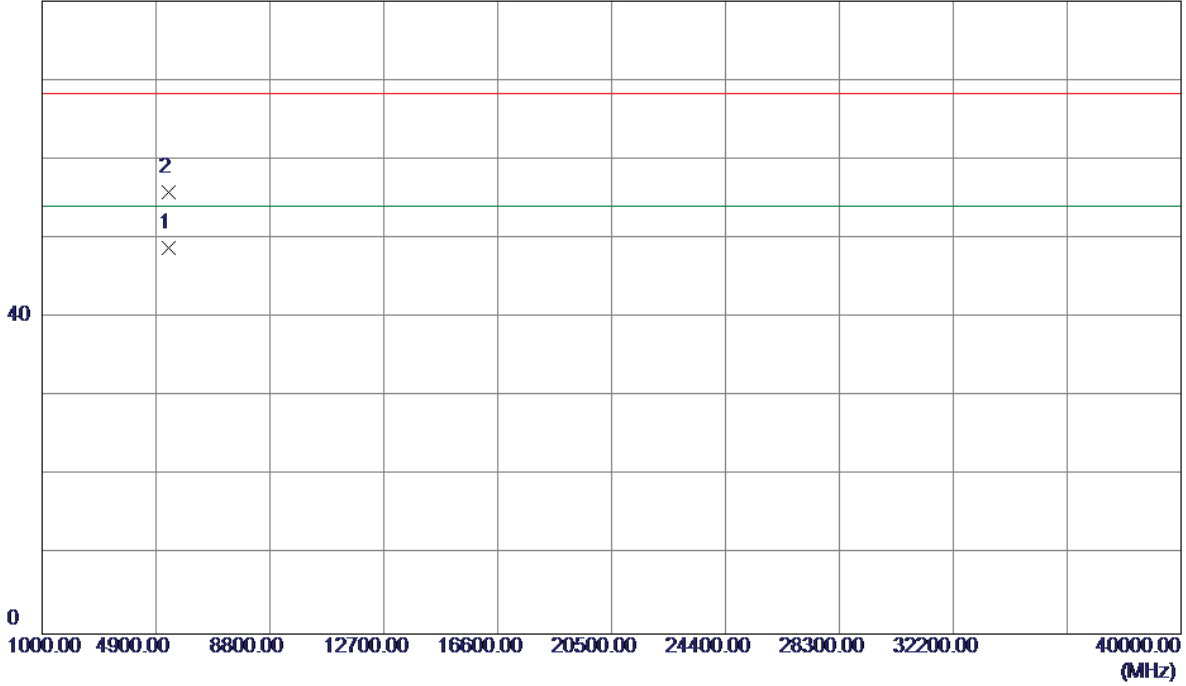

No.	Freq. MHz	Reading Level dBuV/m	Correct Factor dB	Measure ment dBuV/m	Limit dBuV/m	Margin dB	Detector	Comment
1 *	5312.1060	40.43	8.36	48.79	54.00	-5.21	AVG	
2	5312.2610	47.54	8.36	55.90	68.30	-12.40	Peak	

Orthogonal Axis:	X
Test Mode:	UNII-3/TX AC40 Mode 5795MHz

Horizontal

130 dBuV/m

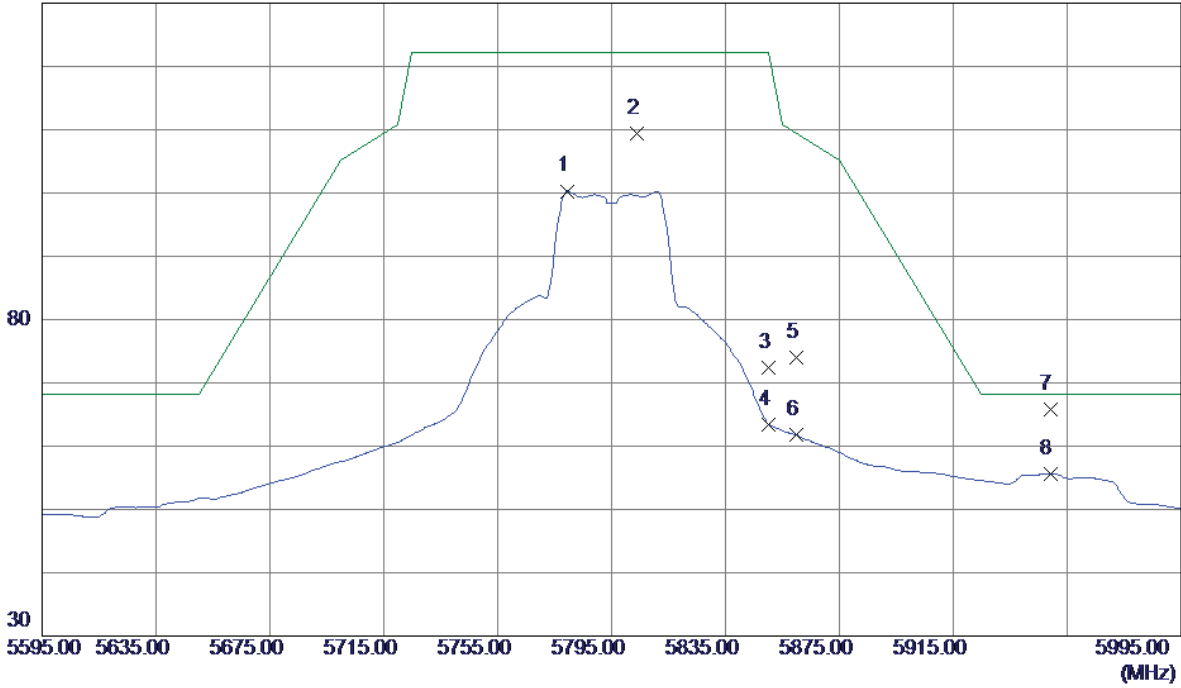

No.	Freq. MHz	Reading Level dBuV/m	Correct Factor dB	Measure ment dBuV/m	Limit dBuV/m	Margin dB	Detector	Comment
1	5779.4000	56.58	43.72	100.30	122.20	-21.90	AVG	
2	5803.8000	65.61	43.80	109.41	122.20	-12.79	Peak	
3	5850.0000	28.55	43.94	72.49	122.20	-49.71	Peak	
4	5850.0000	19.51	43.94	63.45	122.20	-58.75	AVG	
5	5860.0000	30.03	43.97	74.00	109.40	-35.40	Peak	
6	5860.0000	17.74	43.97	61.71	109.40	-47.69	AVG	
7 *	5949.0000	21.54	44.24	65.78	68.20	-2.42	Peak	
8	5949.0000	11.39	44.24	55.63	68.20	-12.57	AVG	

Orthogonal Axis:	X
Test Mode:	UNII-3/TX AC40 Mode 5795MHz

Horizontal

80 dBuV/m

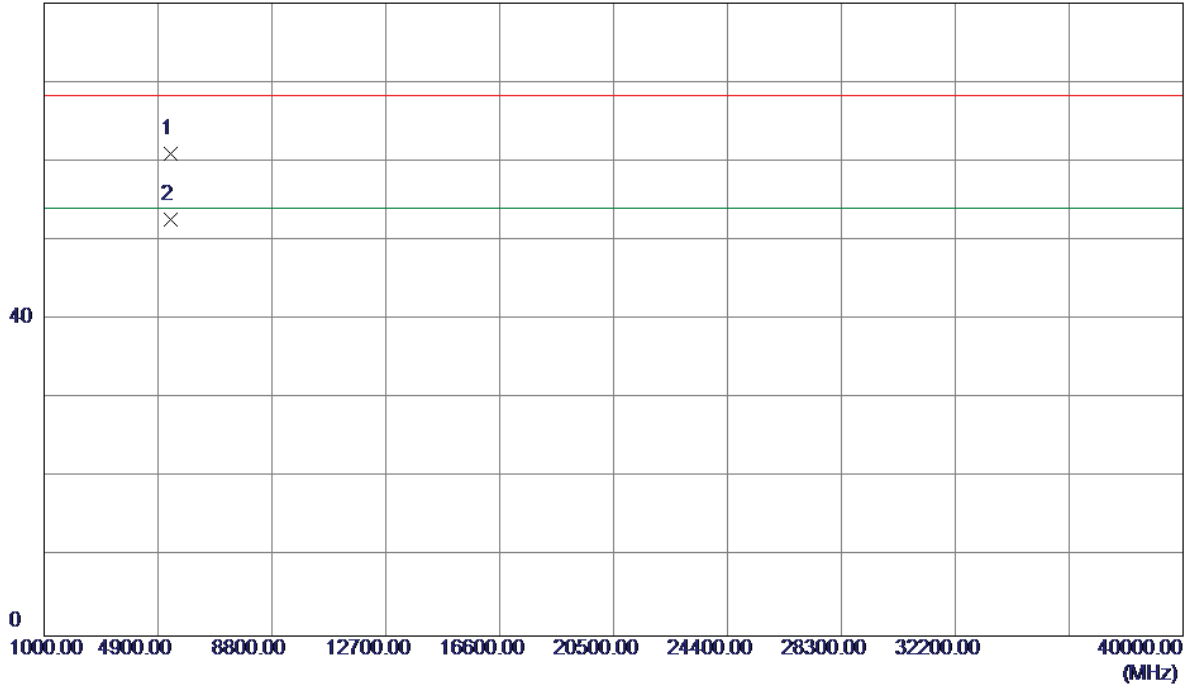

No.	Freq. MHz	Reading Level dBuV/m	Correct Factor dB	Measure ment dBuV/m	Limit dBuV/m	Margin dB	Detector	Comment
1	5311.9460	52.53	8.36	60.89	68.30	-7.41	Peak	
2 *	5312.0259	44.24	8.36	52.60	54.00	-1.40	AVG	

Orthogonal Axis:	X
Test Mode:	UNII-3/TX AC80 Mode 5775MHz

Vertical

130 dBuV/m

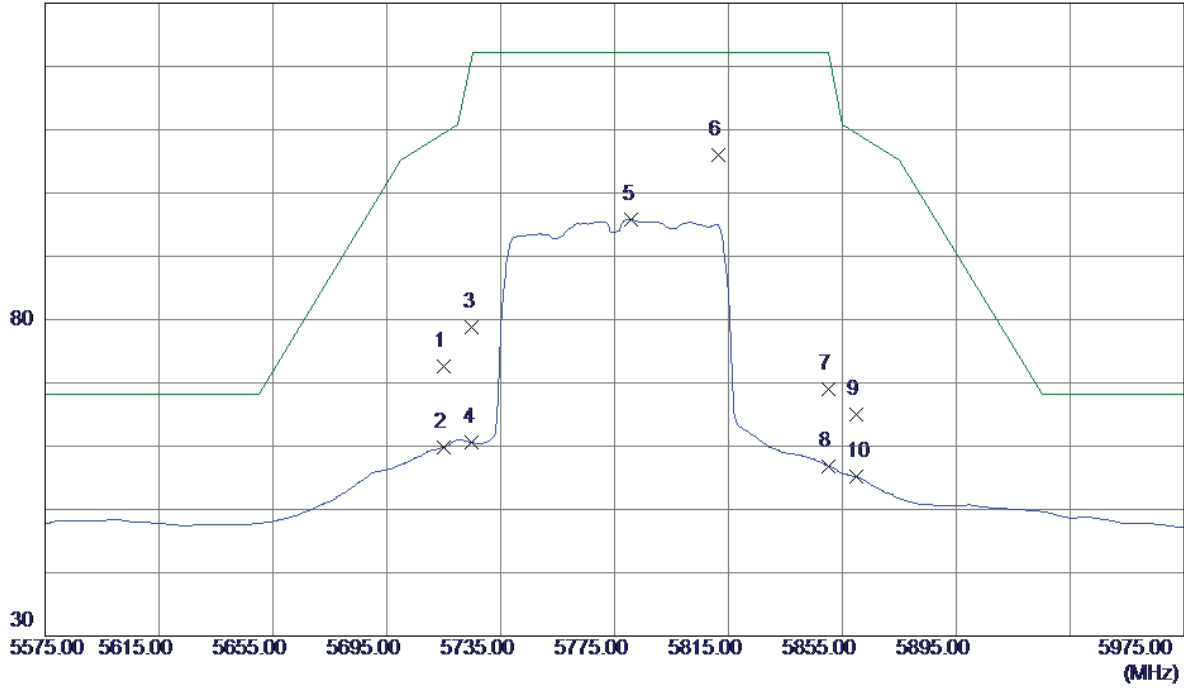

No.	Freq. MHz	Reading Level dBuV/m	Correct Factor dB	Measure ment dBuV/m	Limit dBuV/m	Margin dB	Detector	Comment
1	5715.0000	28.98	43.53	72.51	109.40	-36.89	Peak	
2	5715.0000	16.29	43.53	59.82	109.40	-49.58	AVG	
3	5725.0000	35.29	43.56	78.85	122.20	-43.35	Peak	
4	5725.0000	17.08	43.56	60.64	122.20	-61.56	AVG	
5	5781.0000	52.02	43.73	95.75	122.20	-26.45	AVG	
6 *	5811.4000	62.24	43.82	106.06	122.20	-16.14	Peak	
7	5850.0000	25.07	43.94	69.01	122.20	-53.19	Peak	
8	5850.0000	12.91	43.94	56.85	122.20	-65.35	AVG	
9	5860.0000	20.98	43.97	64.95	109.40	-44.45	Peak	
10	5860.0000	11.17	43.97	55.14	109.40	-54.26	AVG	

Orthogonal Axis:	X
Test Mode:	UNII-3/TX AC80 Mode 5775MHz

Vertical

80 dBuV/m

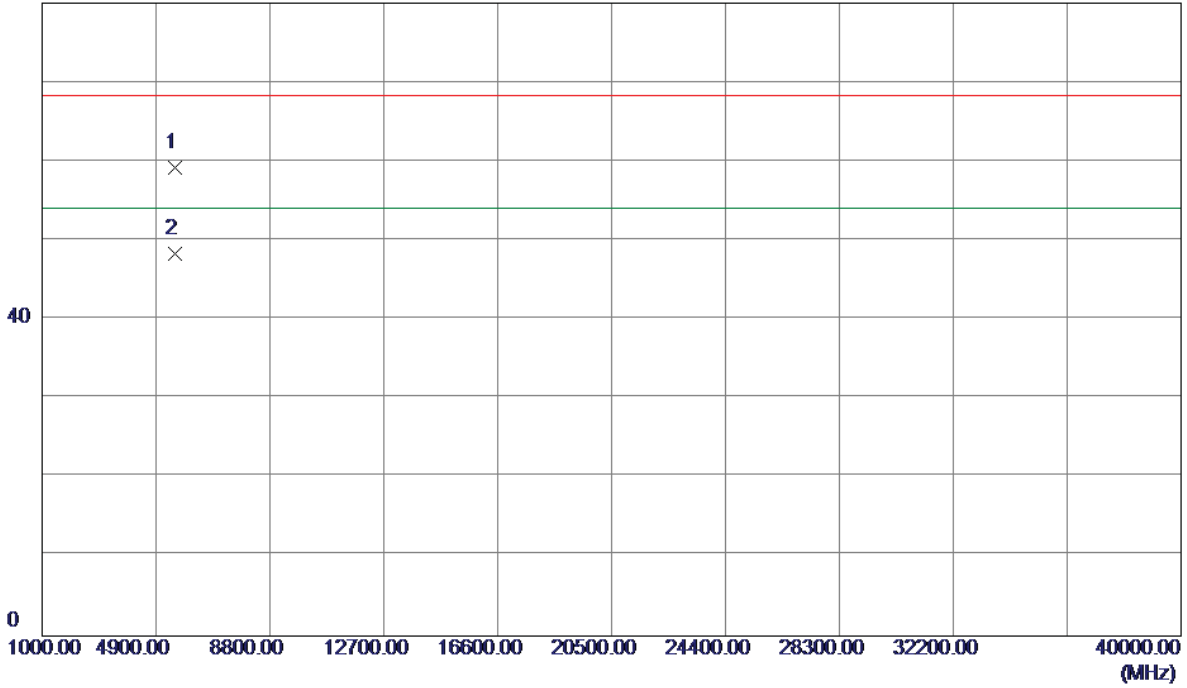

No.	Freq. MHz	Reading Level dBuV/m	Correct Factor dB	Measure ment dBuV/m	Limit dBuV/m	Margin dB	Detector	Comment
1	5563.3260	49.74	9.52	59.26	68.30	-9.04	Peak	
2 *	5571.6260	38.79	9.54	48.33	54.00	-5.67	AVG	

Orthogonal Axis:	X
Test Mode:	UNII-3/TX AC80 Mode 5775MHz

Horizontal

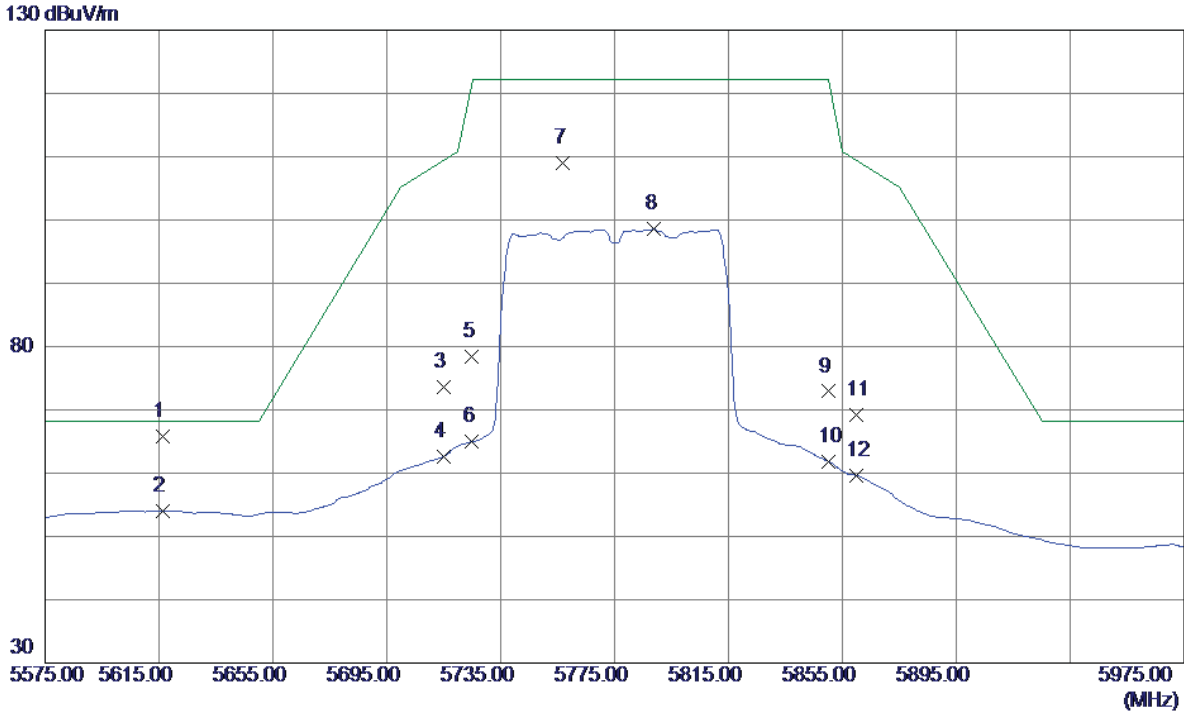

No.	Freq. MHz	Reading Level dBuV/m	Correct Factor dB	Measure ment dBuV/m	Limit dBuV/m	Margin dB	Detector	Comment
1 *	5616.2000	22.51	43.23	65.74	68.20	-2.46	Peak	
2	5616.2000	10.82	43.23	54.05	68.20	-14.15	AVG	
3	5715.0000	30.05	43.53	73.58	109.40	-35.82	Peak	
4	5715.0000	19.12	43.53	62.65	109.40	-46.75	AVG	
5	5725.0000	34.87	43.56	78.43	122.20	-43.77	Peak	
6	5725.0000	21.44	43.56	65.00	122.20	-57.20	AVG	
7	5757.0000	65.37	43.66	109.03	122.20	-13.17	Peak	
8	5789.0000	54.82	43.75	98.57	122.20	-23.63	AVG	
9	5850.0000	28.96	43.94	72.90	122.20	-49.30	Peak	
10	5850.0000	17.88	43.94	61.82	122.20	-60.38	AVG	
11	5860.0000	25.25	43.97	69.22	109.40	-40.18	Peak	
12	5860.0000	15.66	43.97	59.63	109.40	-49.77	AVG	

Orthogonal Axis:	X
Test Mode:	UNII-3/TX AC80 Mode 5775MHz

Horizontal

80 dBuV/m

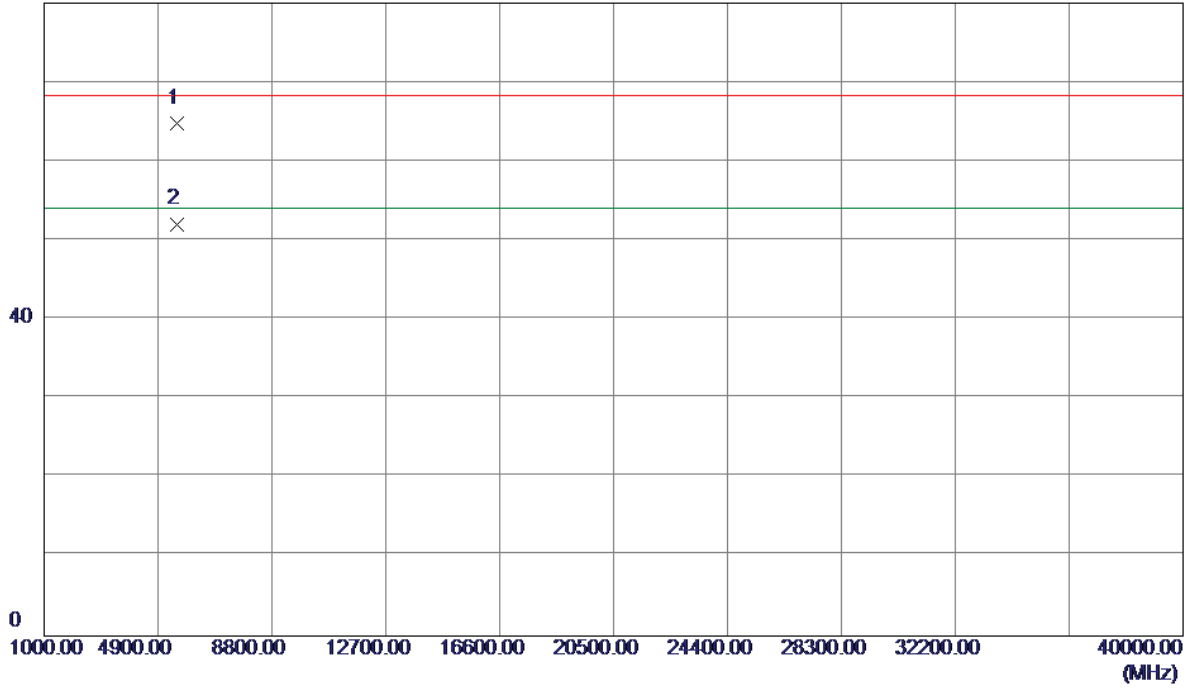

No.	Freq. MHz	Reading Level dBuV/m	Correct Factor dB	Measure ment dBuV/m	Limit dBuV/m	Margin dB	Detector	Comment
1	5569.0259	55.30	9.54	64.84	68.30	-3.46	Peak	
2 *	5569.2260	42.54	9.54	52.08	54.00	-1.92	AVG	

TX A Mode_DUTY CYCLE

Duty cycle: TX DUTYMHZ

Duty cycle = T_{ON} / T_{Total}

T_{ON} : 2.07 msec

T_{Total} : 2.18 msec

Duty cycle: 94.95%

Duty Factor = $10 \log(1/\text{Duty cycle})$

Duty Factor = 0.22

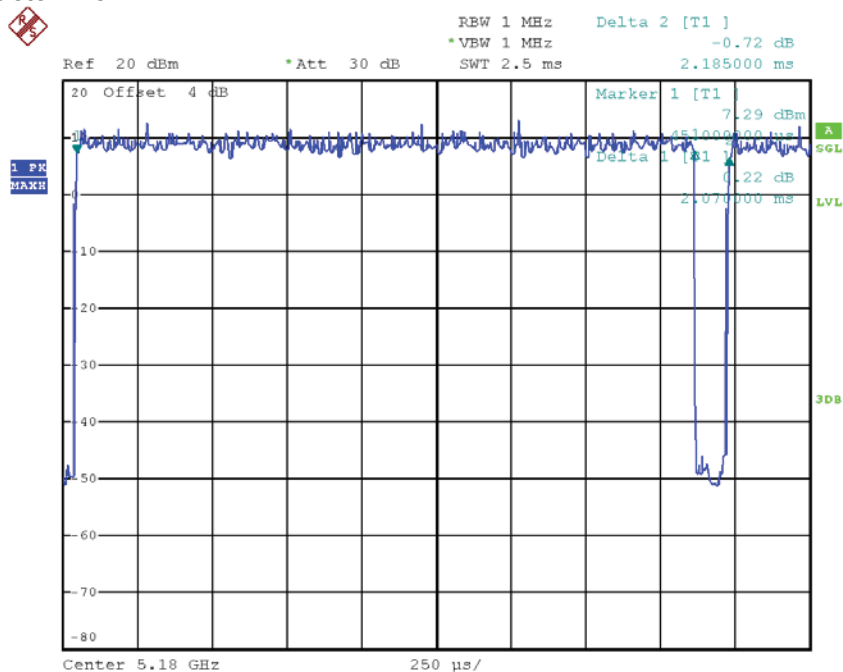

Date: 12.AUG.2017 13:29:36

Note: The EUT was programmed to be in countinously transmitting mode and the transmit duty cycle is not less than 98 %, so, the output power and power density should be cacluated as

Output Power = Measured power + Ducus factor

Power Spectral Density = Measured density + Duty factor

TX N20 Mode_DUTY CYCLE

Duty cycle: TX DUTYMHZ

Duty cycle = T_{ON} / T_{Total}

T_{ON} : 0.98 msec

T_{Total} : 1.09 msec

Duty cycle: 89.91%

Duty Factor = $10 \log(1/Duty\ cycle)$

Duty Factor = 0.46

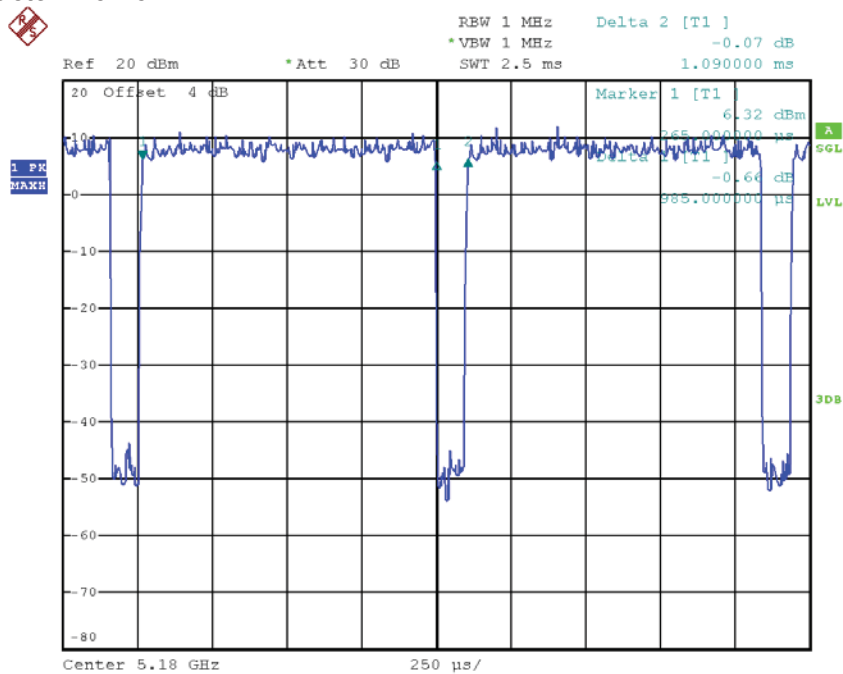

Date: 12.AUG.2017 13:36:28

Note: The EUT was programmed to be in continuously transmitting mode and the transmit duty cycle is not less than 98 %, so, the output power and power density should be calculated as

Output Power = Measured power + Duty factor

Power Spectral Density = Measured density + Duty factor

TX N40 Mode_DUTY CYCLE

Duty cycle: TX DUTYMHZ

Duty cycle = T_{ON} / T_{Total}

T_{ON} : 0.48 msec

T_{Total} : 0.60 msec

Duty cycle: 80.00%

Duty Factor = $10 \log(1/\text{Duty cycle})$

Duty Factor = 0.97

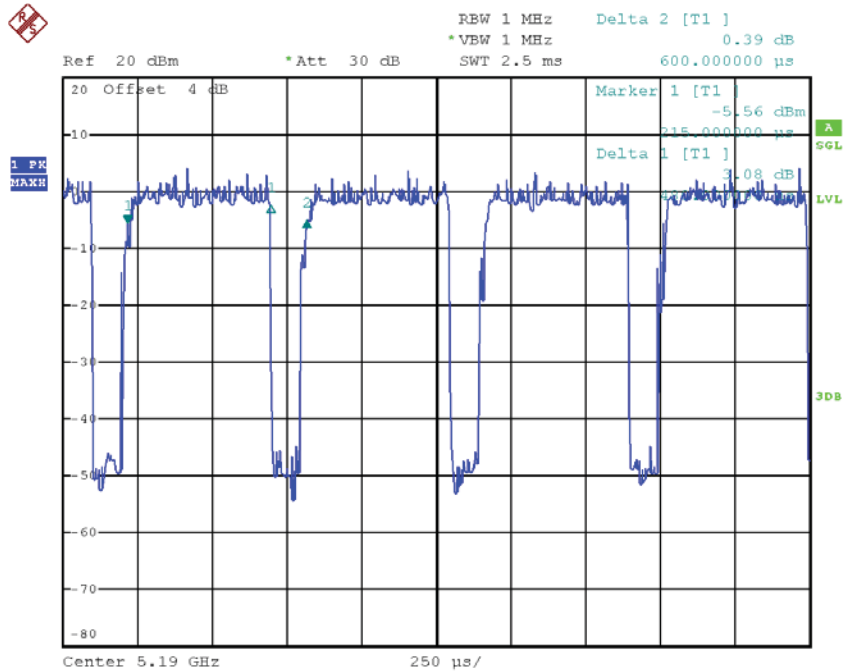

Date: 12.AUG.2017 14:35:34

Note: The EUT was programmed to be in countinously transmitting mode and the transmit duty cycle is not less than 98 %, so, the output power and power density should be cacluated as

Output Power = Measured power + Ducus factor

Power Spectral Density = Measured density + Duty factor

TX AC20 Mode_DUTY CYCLE

Duty cycle: TX DUTYMHZ

Duty cycle = T_{ON} / T_{Total}

T_{ON} : 0.98 msec

T_{Total} : 1.03 msec

Duty cycle: 95.15%

Duty Factor = $10 \log(1/Duty \text{ cycle})$

Duty Factor = 0.22

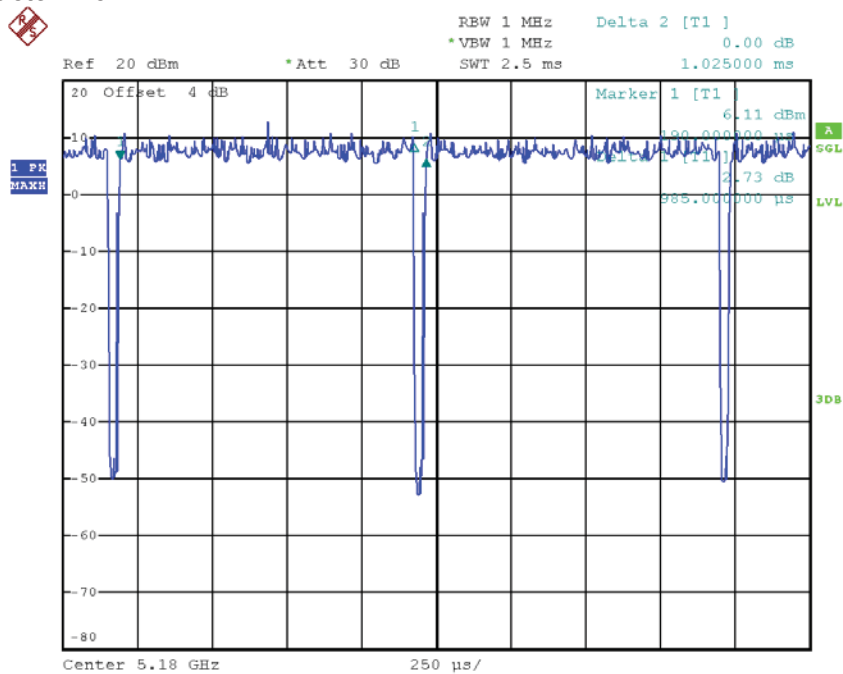

Date: 12.AUG.2017 13:53:27

Note: The EUT was programmed to be in continuously transmitting mode and the transmit duty cycle is not less than 98 %, so, the output power and power density should be calculated as

Output Power = Measured power + Duty factor

Power Spectral Density = Measured density + Duty factor

TX AC40 Mode_DUTY CYCLE

Duty cycle: TX DUTYMHz

Duty cycle = T_{ON} / T_{Total}

T_{ON} : 0.47 msec

T_{Total} : 0.53 msec

Duty cycle: 88.68%

Duty Factor = $10 \log(1/Duty\ cycle)$

Duty Factor = 0.52

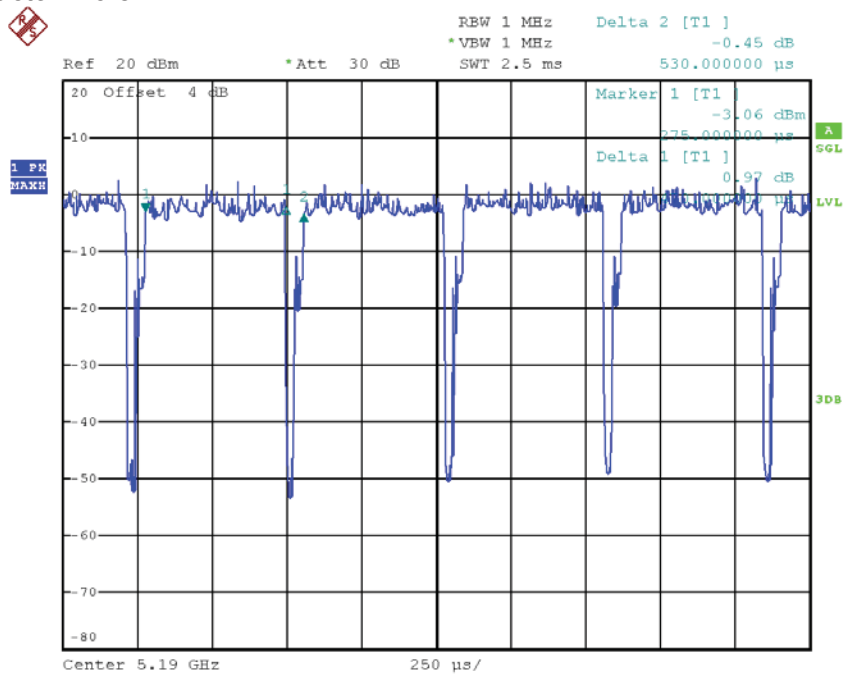

Date: 12.AUG.2017 14:51:59

Note: The EUT was programmed to be in countinously transmitting mode and the transmit duty cycle is not less than 98 %, so, the output power and power density should be cacluated as

Output Power = Measured power + Ducus factor

Power Spectral Density = Measured density + Duty factor

TX AC80 Mode_DUTY CYCLE

Duty cycle: TX DUTYMHZ

Duty cycle = T_{ON} / T_{Total}

T_{ON} : 0.22 msec

T_{Total} : 0.28 msec

Duty cycle: 78.57%

Duty Factor = $10 \log(1/Duty\ cycle)$

Duty Factor = 1.05

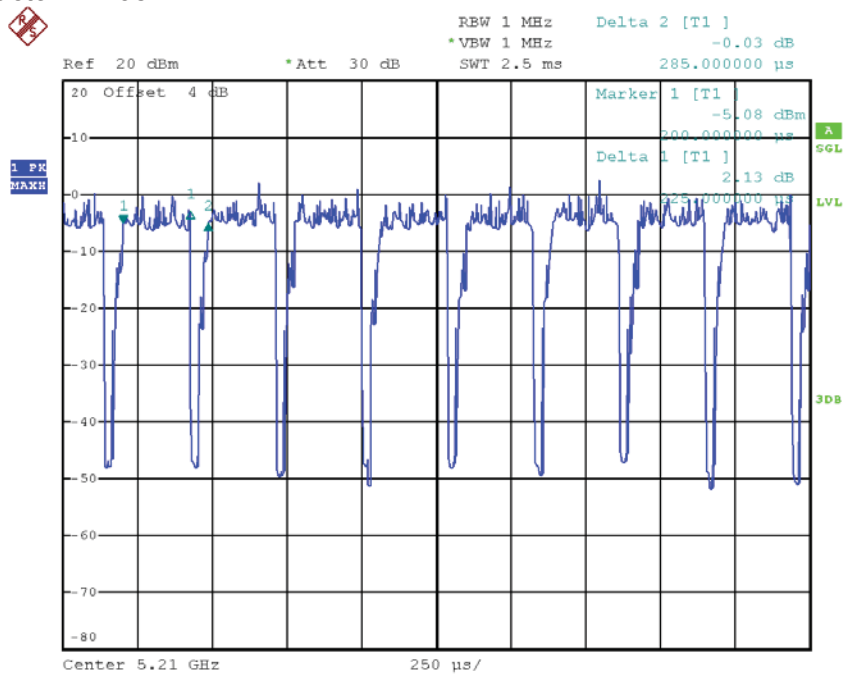

Date: 12.AUG.2017 15:04:40

Note: The EUT was programmed to be in countinously transmitting mode and the transmit duty cycle is not less than 98 %, so, the output power and power density should be cacluated as

Output Power = Measured power + Ducus factor

Power Spectral Density = Measured density + Duty factor

ATTACHMENT E - BANDWIDTH

Non-Beamforming

Test Mode: UNII-1/TX A Mode_CH36/CH40/CH48

Channel	Frequency (MHz)	26dB Bandwidth (MHz)	99% Occupied Bandwidth (MHz)
CH36	5180	21.69	17.30
CH40	5200	21.70	17.30
CH48	5240	21.79	17.40

TX CH36

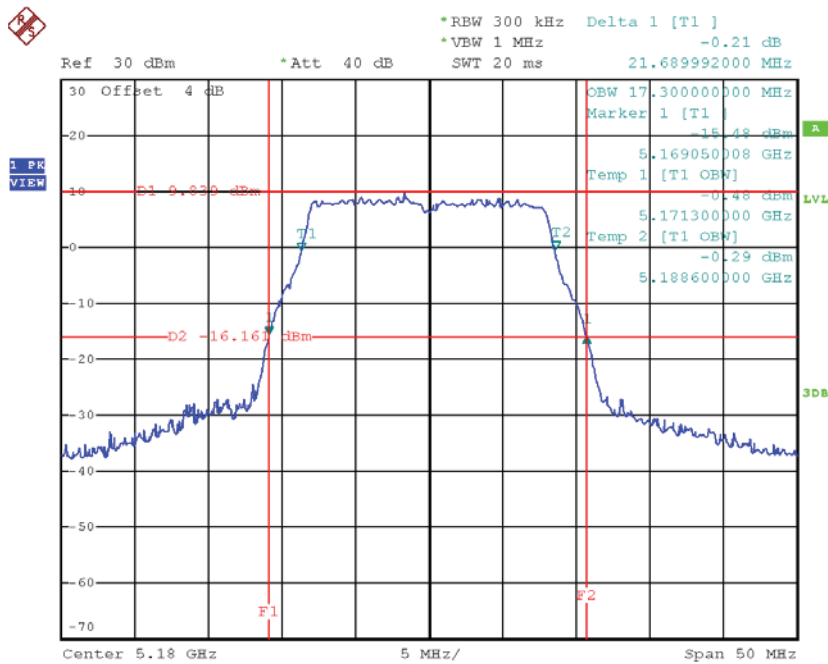

Date: 12.AUG.2017 13:29:24

TX CH40

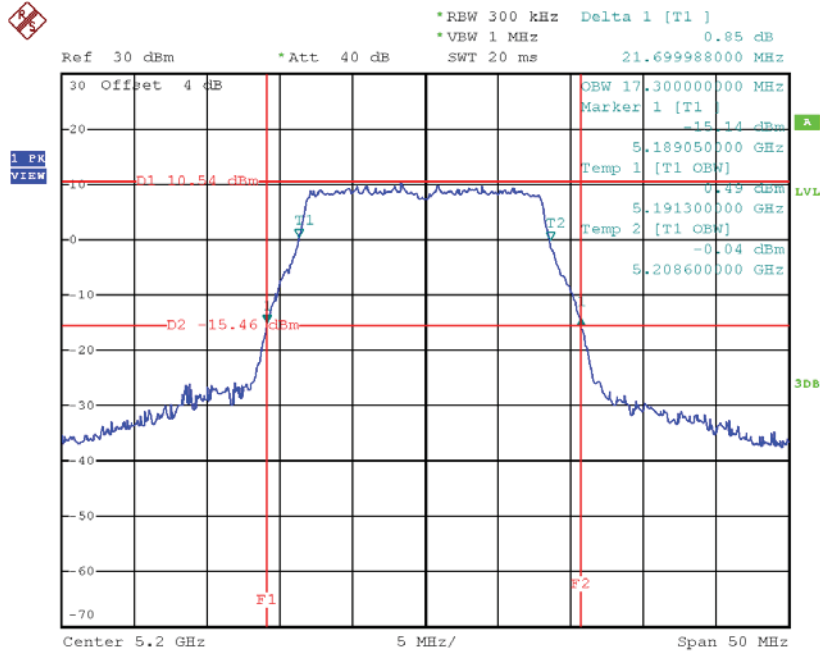

Date: 12.AUG.2017 13:30:30

TX CH48

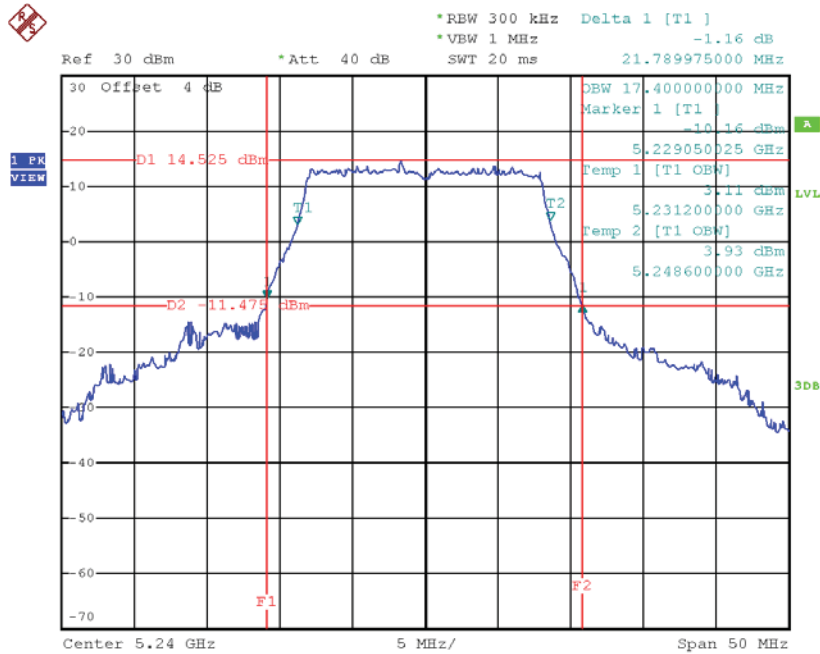

Date: 12.AUG.2017 13:31:21

Test Mode: UNII-1/TX N20 Mode_CH36/CH40/CH48

Channel	Frequency (MHz)	26dB Bandwidth (MHz)	99% Occupied Bandwidth (MHz)
CH36	5180	21.95	18.30
CH40	5200	22.00	18.30
CH48	5240	22.00	18.40

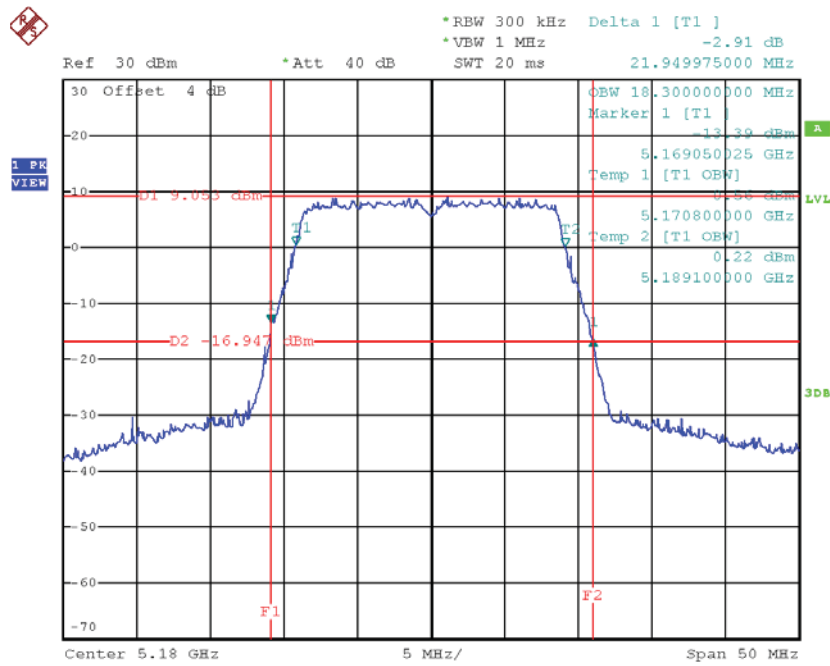
TX CH36

Date: 12.AUG.2017 13:36:16

TX CH40

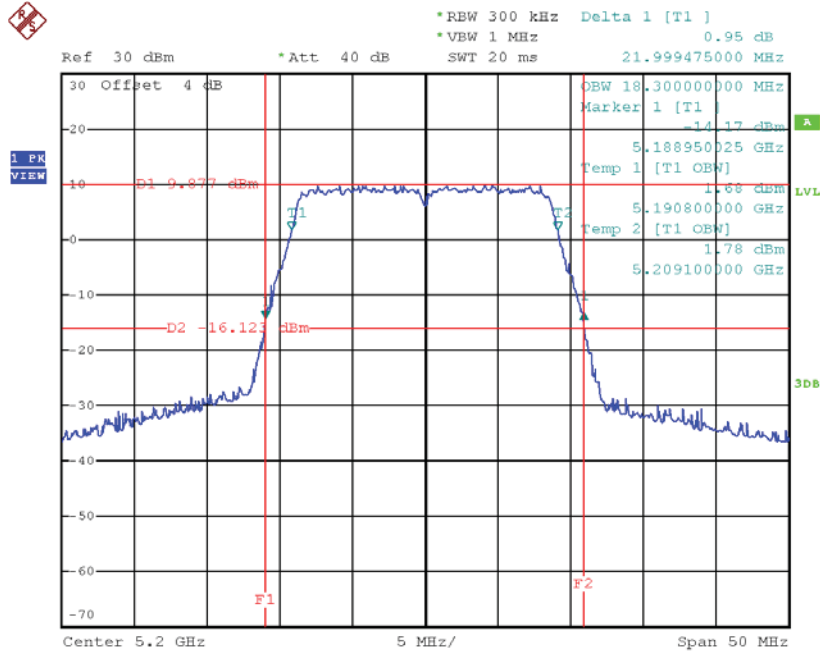

Date: 12.AUG.2017 13:37:46

TX CH48

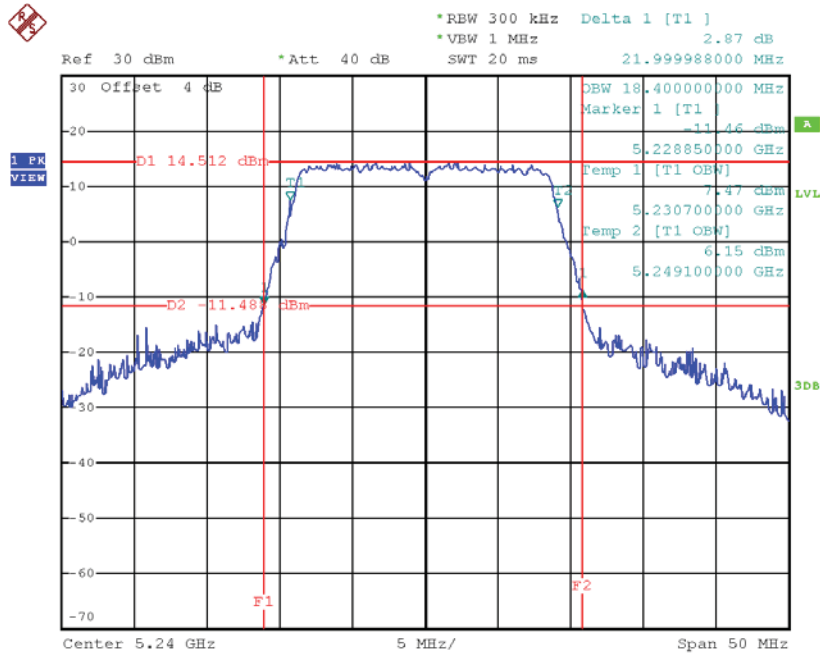

Date: 12.AUG.2017 13:38:51

Test Mode: UNII-1/TX N40 Mode_CH38/CH46

Channel	Frequency (MHz)	26dB Bandwidth (MHz)	99% Occupied Bandwidth (MHz)
CH38	5190	41.70	37.00
CH46	5230	41.50	37.00

TX CH38

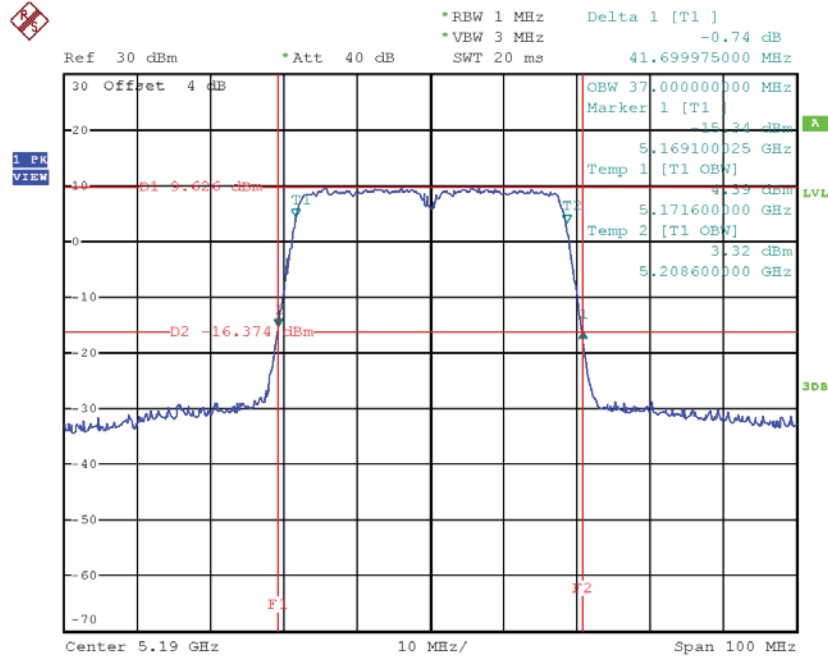

Date: 12.AUG.2017 14:35:17

TX CH46

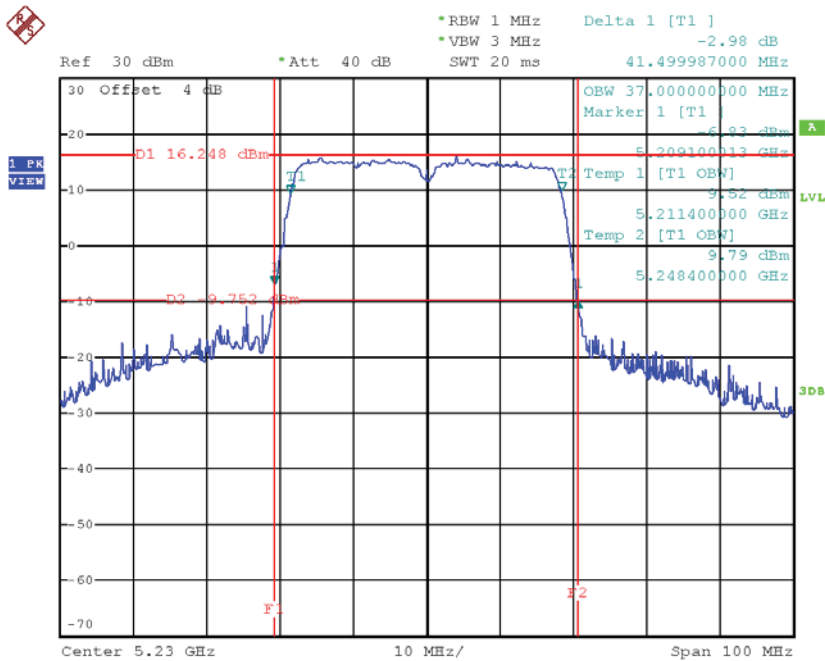

Date: 12.AUG.2017 14:36:55

Test Mode: UNII-3/ TX A Mode_CH149/CH157/CH165

Channel	Frequency (MHz)	6dB Bandwidth (MHz)	99% Occupied Bandwidth (MHz)	Limit (kHz)
CH149	5745	16.35	16.70	>=500
CH157	5785	16.39	17.00	>=500
CH165	5825	16.35	17.70	>=500

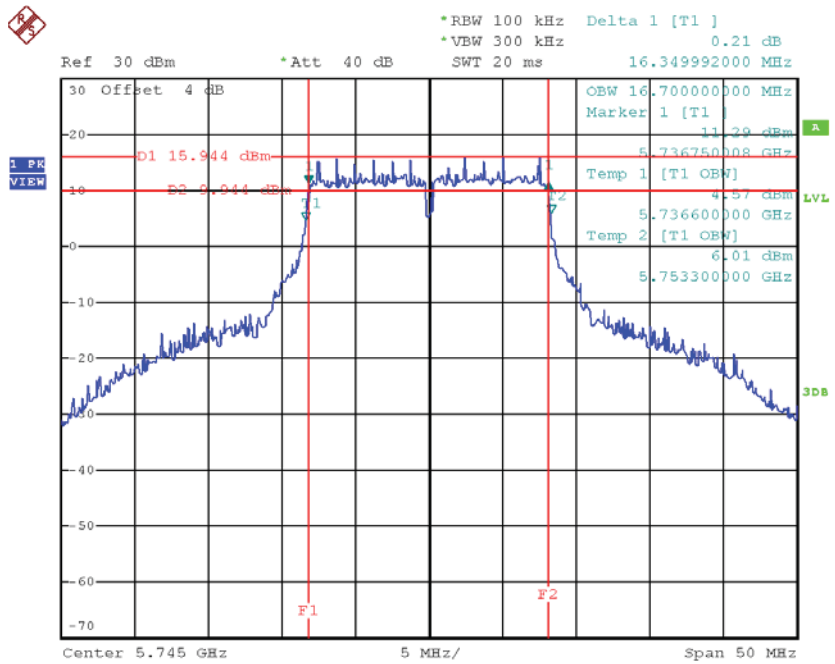
TX CH 149

Date: 12.AUG.2017 13:32:20

TX CH 157

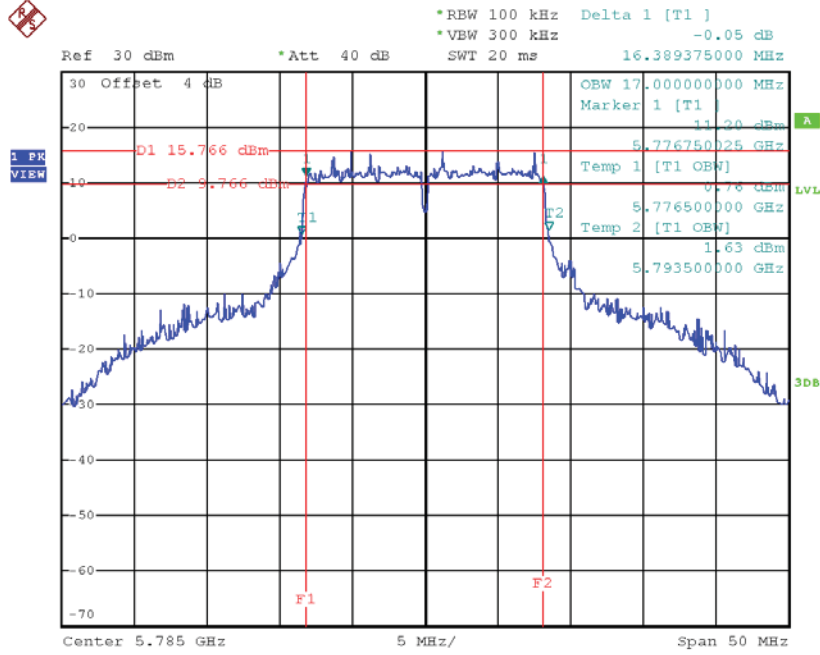

Date: 12.AUG.2017 13:33:10

TX CH 165

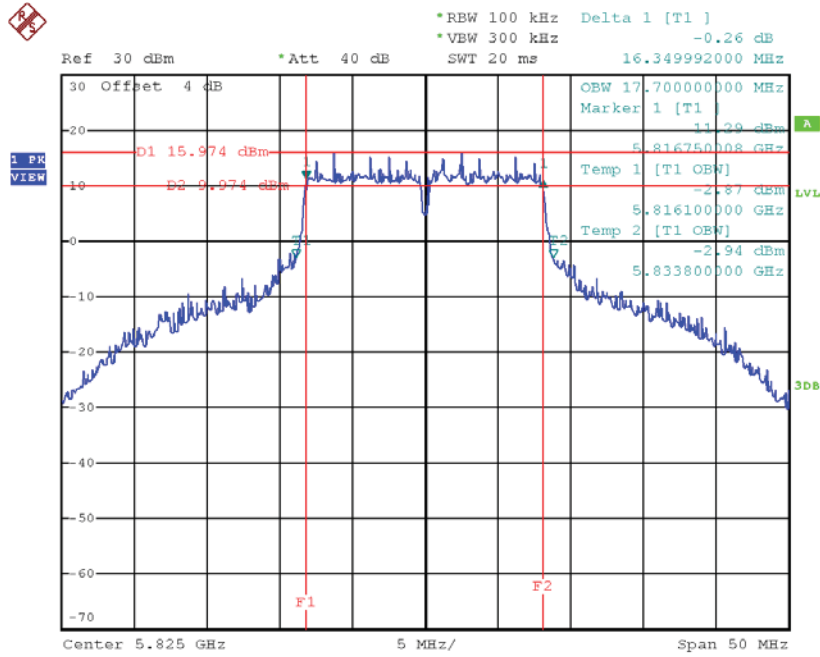

Date: 12.AUG.2017 13:33:59

Test Mode: UNII-3/ TX N20 Mode_CH149/CH157/CH165

Channel	Frequency (MHz)	6dB Bandwidth (MHz)	99% Occupied Bandwidth (MHz)	Limit (kHz)
CH149	5745	17.65	17.90	>=500
CH157	5785	17.65	18.40	>=500
CH165	5825	17.75	17.90	>=500

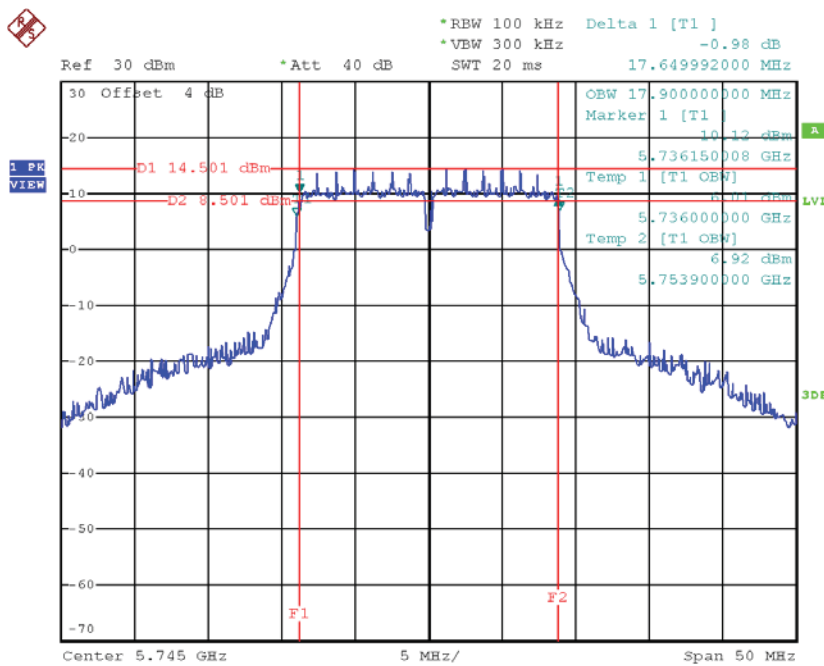
TX CH 149

Date: 12.AUG.2017 13:40:10

TX CH 157

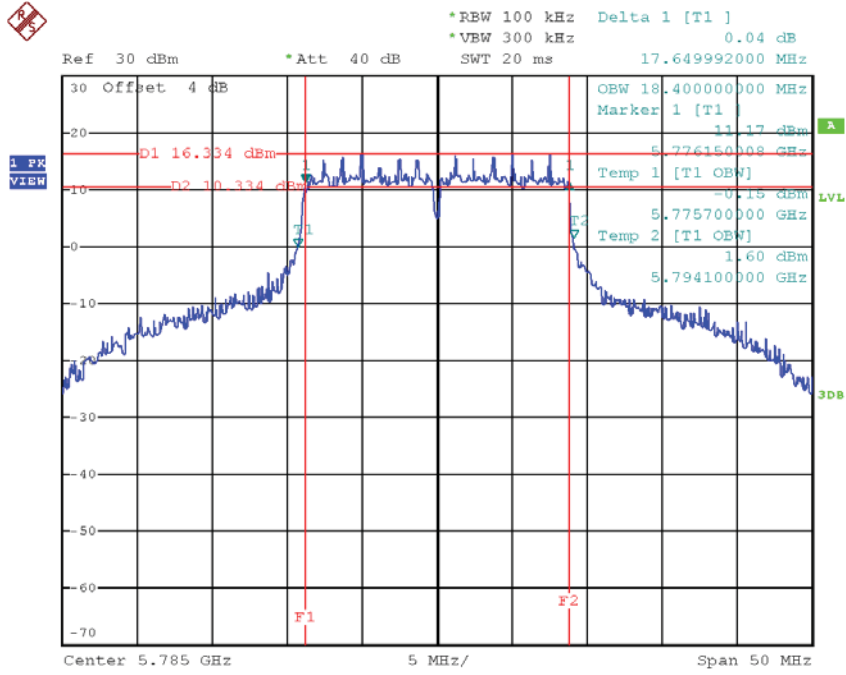

Date: 12.AUG.2017 13:41:04

TX CH 165

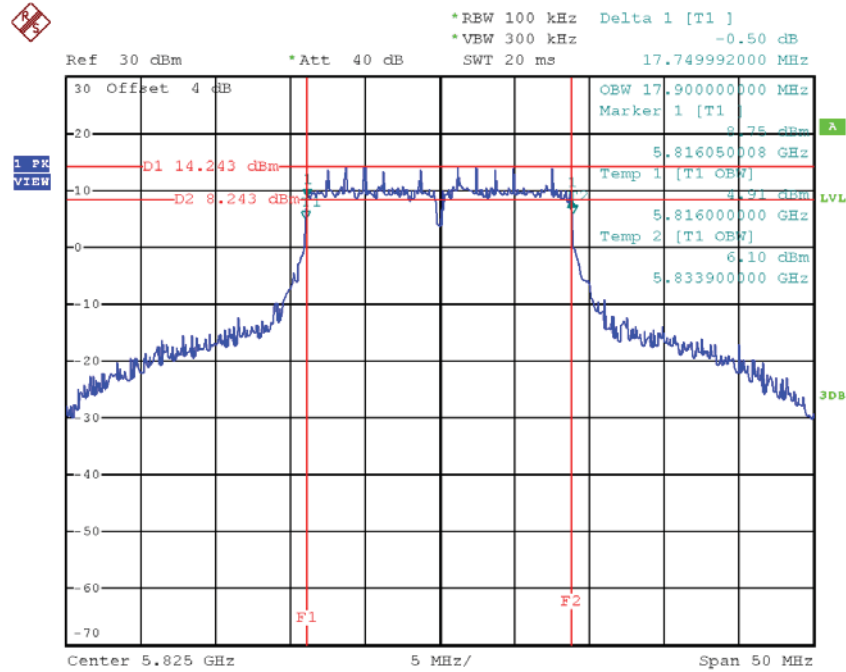

Date: 12.AUG.2017 13:41:58

Test Mode: UNII-3/ TX N40 Mode_CH151/CH159

Channel	Frequency (MHz)	6dB Bandwidth (MHz)	99% Occupied Bandwidth (MHz)	Limit (kHz)
CH151	5755	36.50	36.40	>=500
CH159	5795	36.50	36.40	>=500

TX CH 151

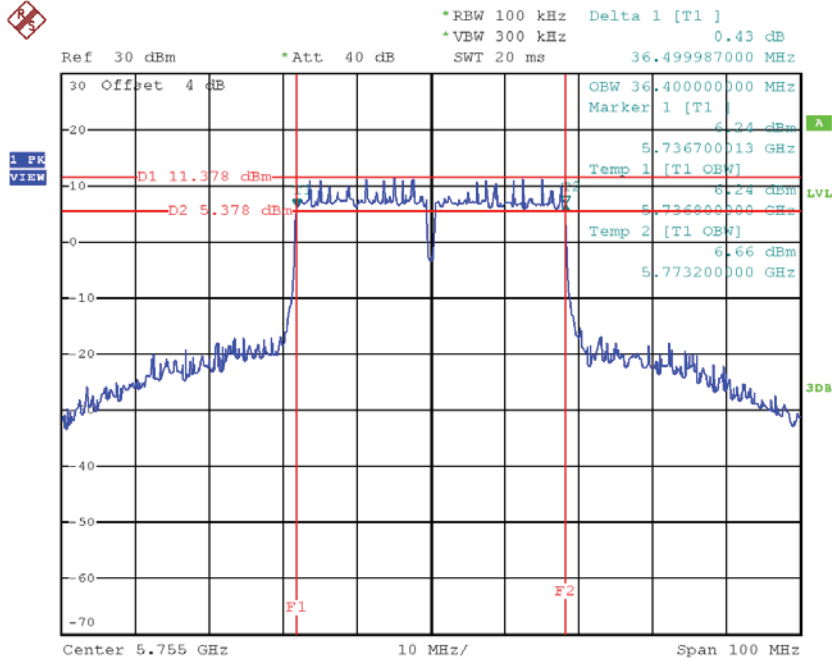

Date: 12.AUG.2017 14:38:19

TX CH 159

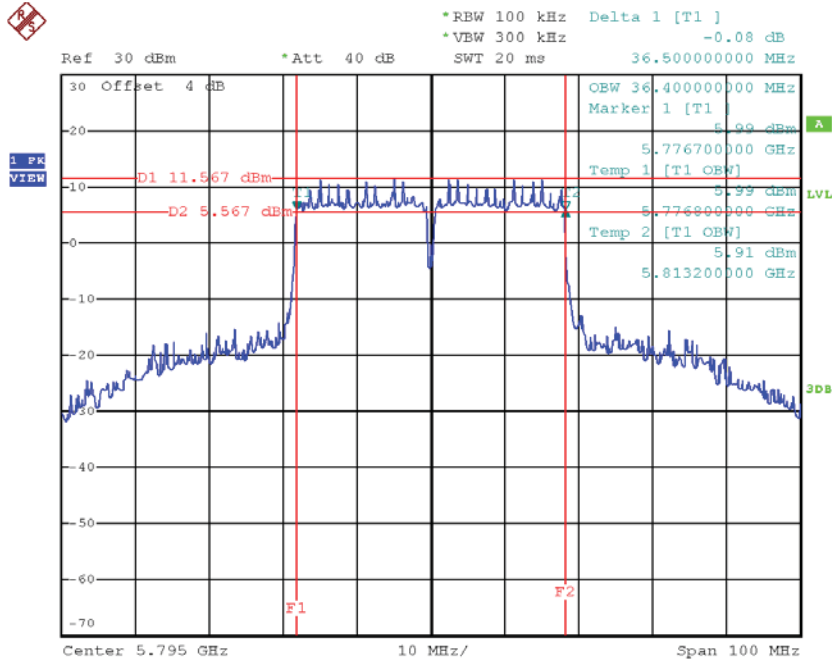

Date: 12.AUG.2017 14:39:19

Test Mode: UNII-1/TX AC20 Mode_CH36/CH40/CH48

Channel	Frequency (MHz)	26dB Bandwidth (MHz)	99% Occupied Bandwidth (MHz)
CH36	5180	22.05	18.30
CH40	5200	22.15	18.40
CH48	5240	22.25	18.40

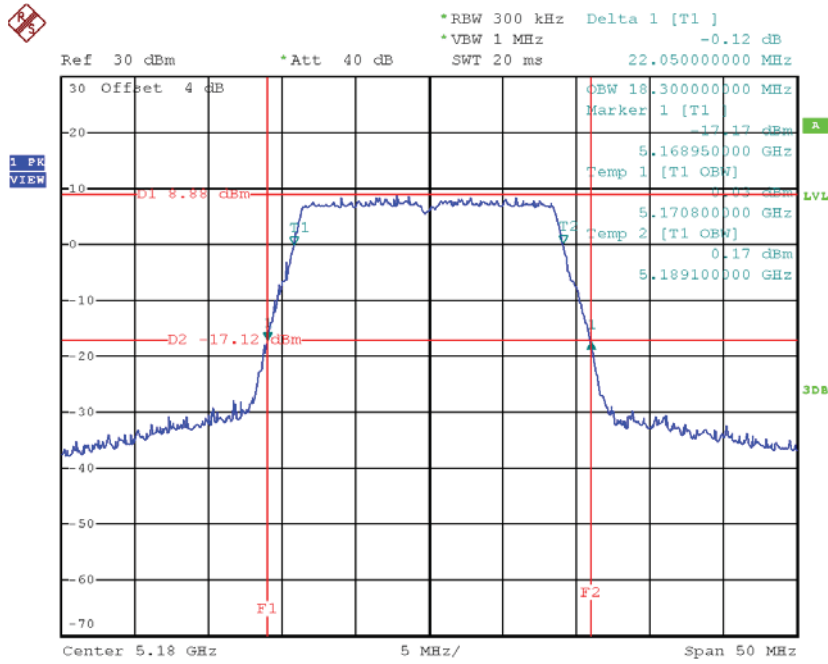
TX CH36

Date: 12.AUG.2017 13:53:14

TX CH40

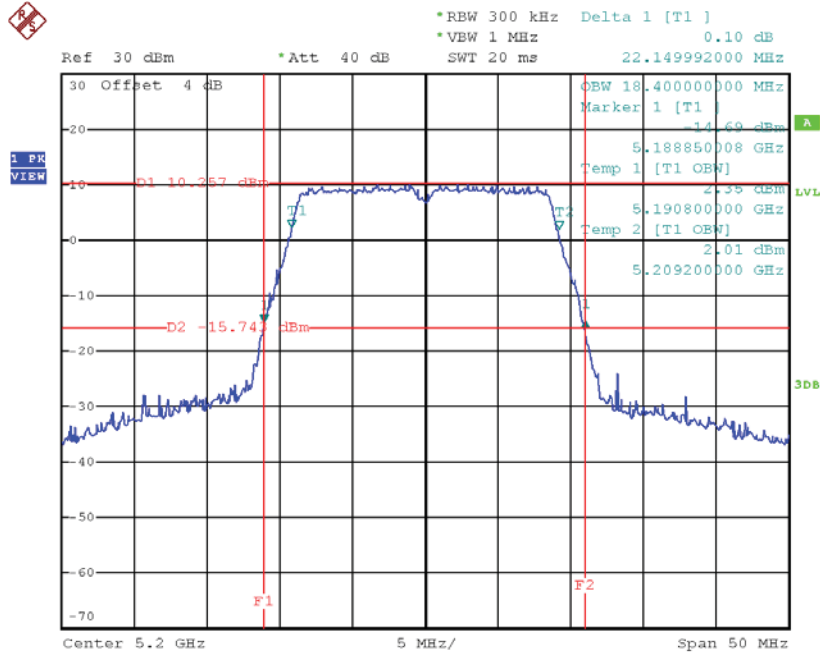

Date: 12.AUG.2017 13:56:01

TX CH48

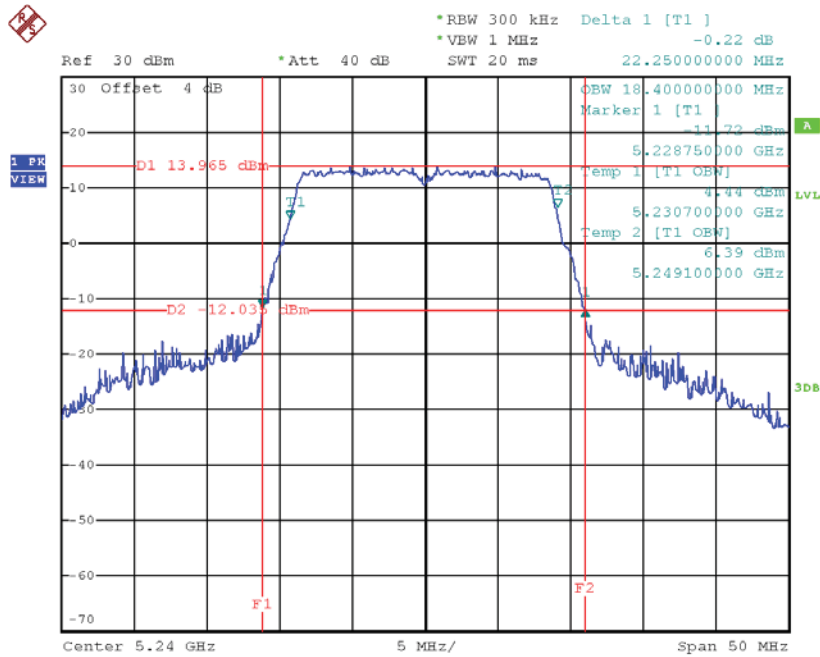

Date: 12.AUG.2017 13:56:53

Test Mode: UNII-1/TX AC40 Mode_CH38/CH46

Channel	Frequency (MHz)	26dB Bandwidth (MHz)	99% Occupied Bandwidth (MHz)
CH38	5190	41.90	37.20
CH46	5230	41.61	37.00

TX CH38

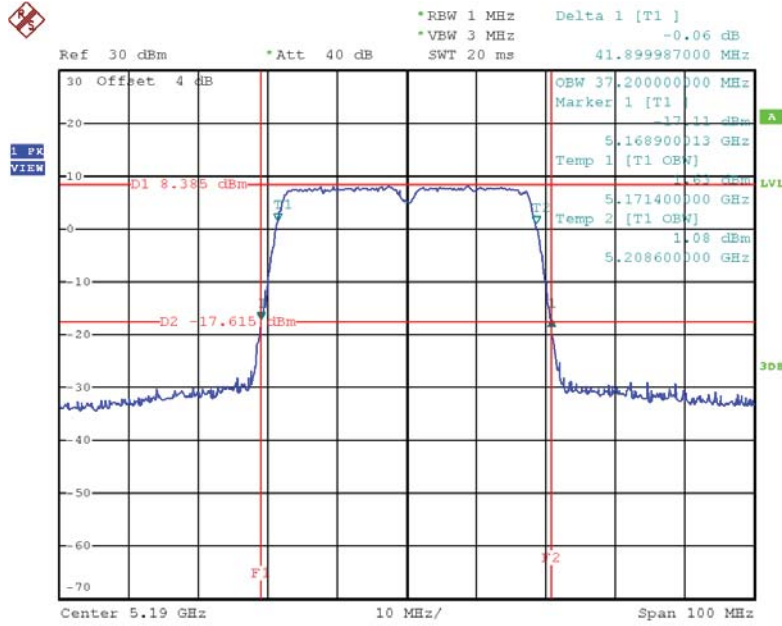

Date: 12.AUG.2017 14:51:43

TX CH46

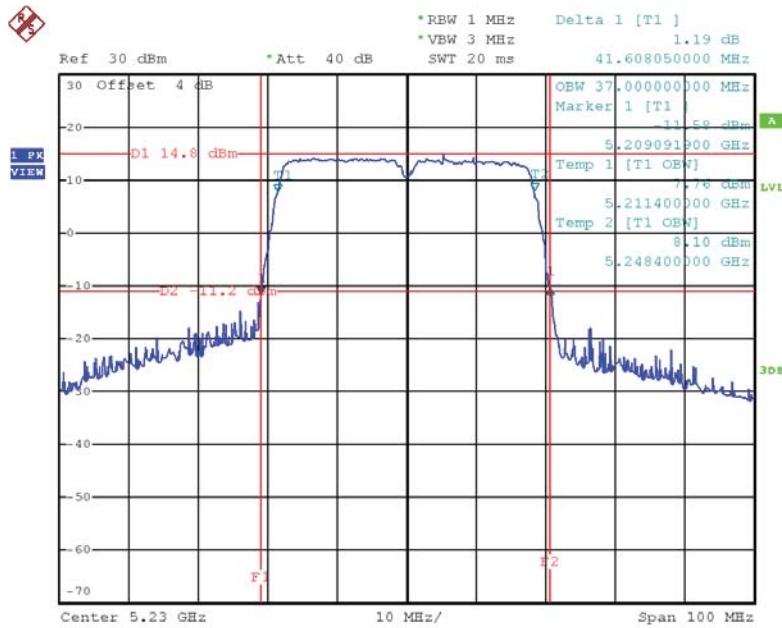

Date: 12.AUG.2017 14:53:14

Test Mode: UNII-1/TX AC80 Mode_CH42

Channel	Frequency (MHz)	26dB Bandwidth (MHz)	99% Occupied Bandwidth (MHz)
CH42	5210	82.60	76.00

TX CH42

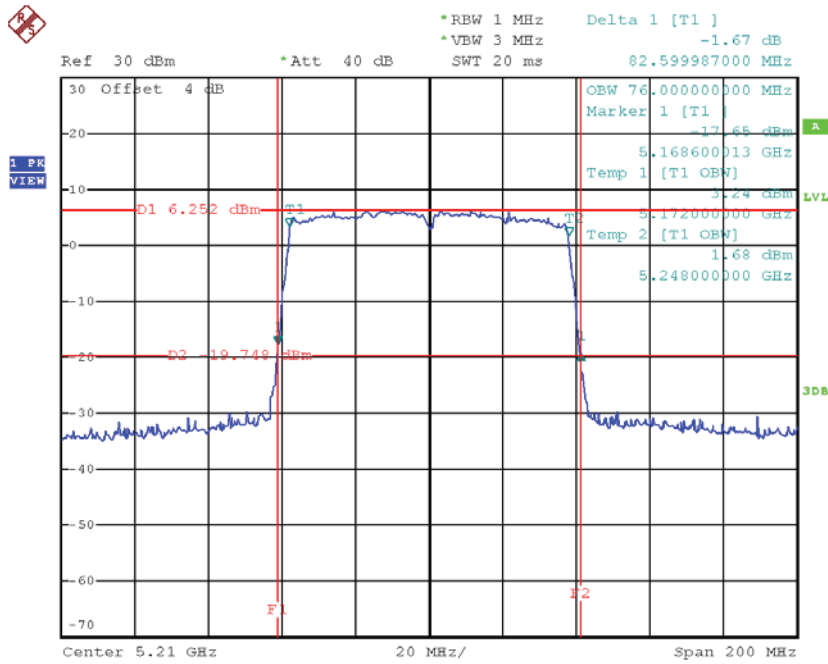

Date: 12.AUG.2017 15:04:24

Test Mode: UNII-3/ TX AC20 Mode_CH149/CH157/CH165

Channel	Frequency (MHz)	6dB Bandwidth (MHz)	99% Occupied Bandwidth (MHz)	Limit (kHz)
CH149	5745	17.65	17.80	>=500
CH157	5785	17.71	18.40	>=500
CH165	5825	17.75	17.90	>=500

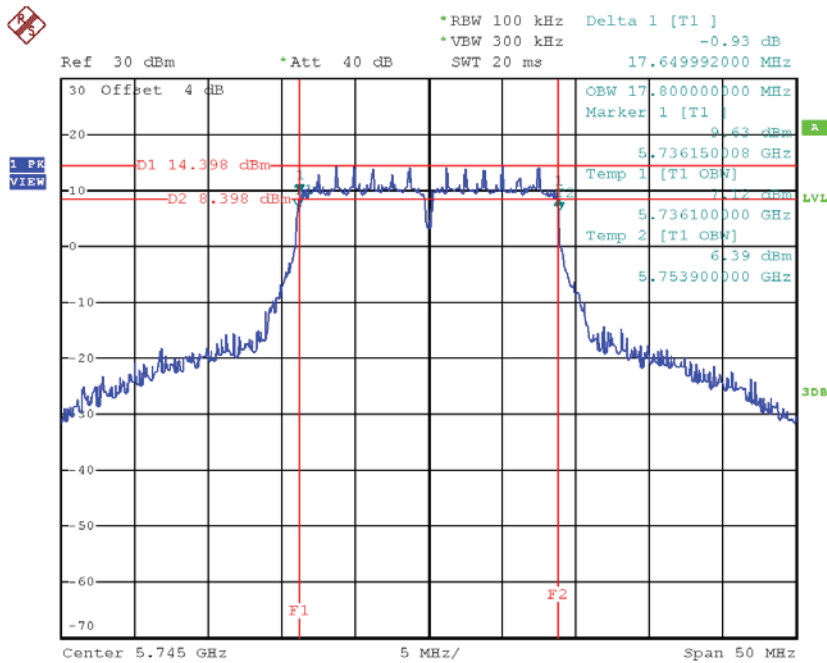
TX CH 149

Date: 12.AUG.2017 13:59:40

TX CH 157

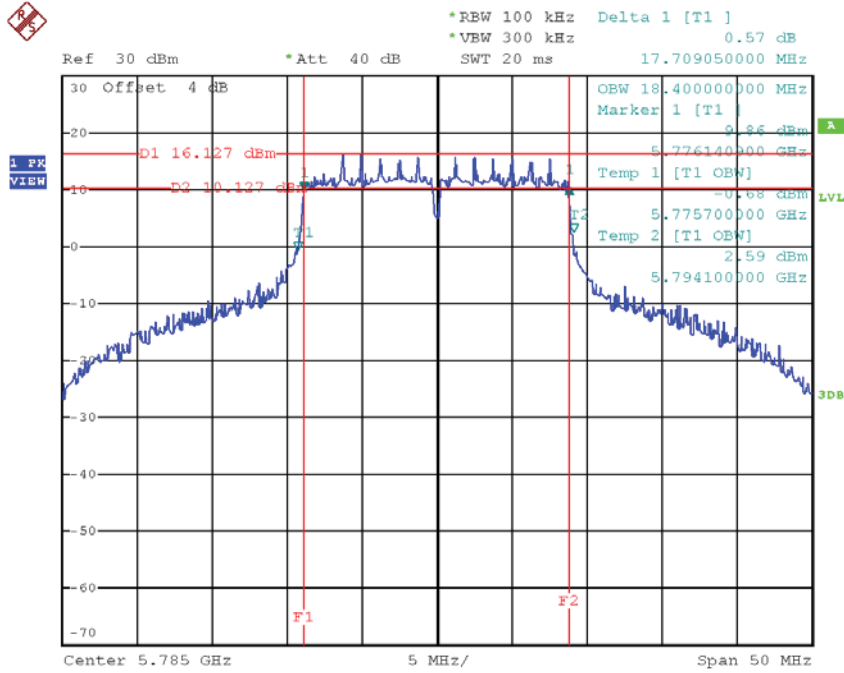

Date: 12.AUG.2017 14:00:31

TX CH 165

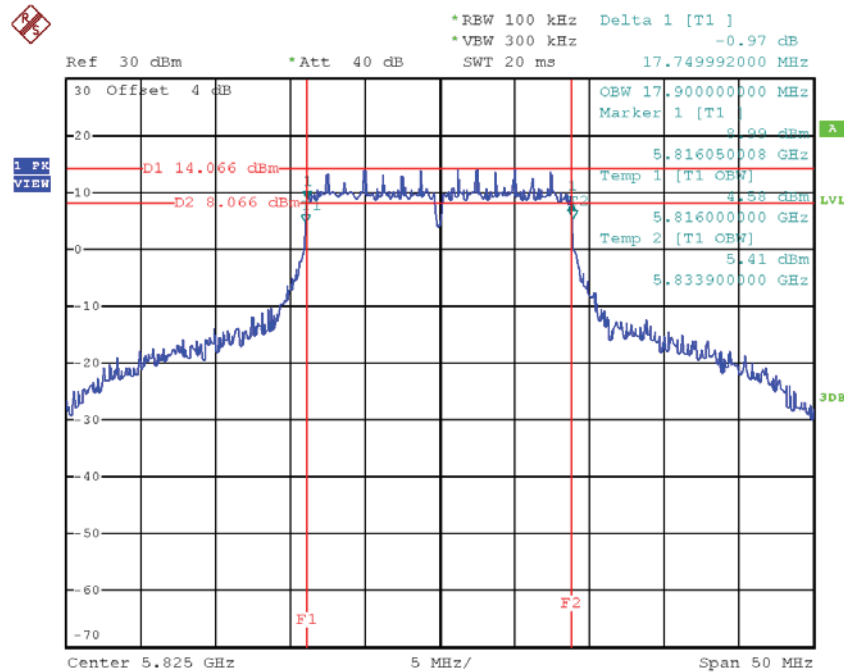

Date: 12.AUG.2017 14:02:26

Test Mode: UNII-3/ TX AC40 Mode_CH151/CH159

Channel	Frequency (MHz)	6dB Bandwidth (MHz)	99% Occupied Bandwidth (MHz)	Limit (kHz)
CH151	5755	36.50	36.40	>=500
CH159	5795	36.50	36.40	>=500

TX CH 151

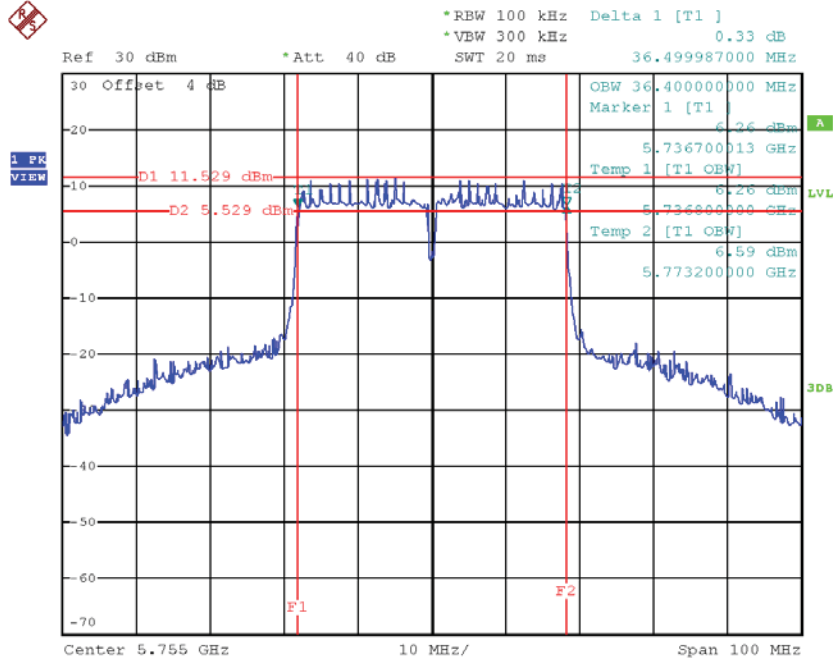

Date: 12.AUG.2017 14:55:12

TX CH 159

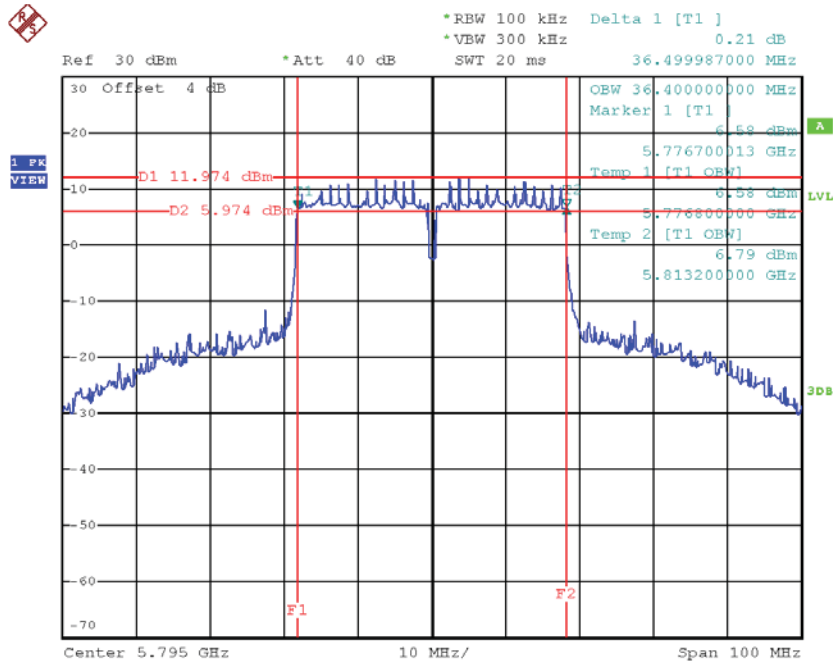

Date: 12.AUG.2017 14:56:16

Test Mode: UNII-3/ TX AC80 Mode_CH155

Channel	Frequency (MHz)	6dB Bandwidth (MHz)	99% Occupied Bandwidth (MHz)	Limit (kHz)
CH155	5775	76.00	76.00	>=500

TX CH 155

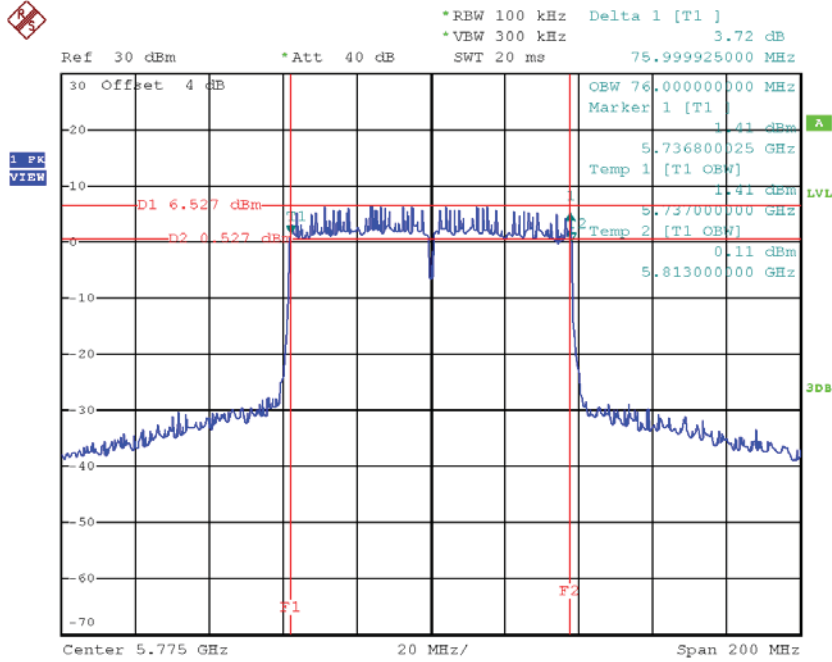

Date: 12.AUG.2017 15:06:03

Beamforming

Test Mode: UNII-1/TX N20 Mode_CH36/CH40/CH48

Channel	Frequency (MHz)	26dB Bandwidth (MHz)	99% Occupied Bandwidth (MHz)
CH36	5180	22.09	18.30
CH40	5200	22.16	18.30
CH48	5240	22.25	18.40

TX CH36

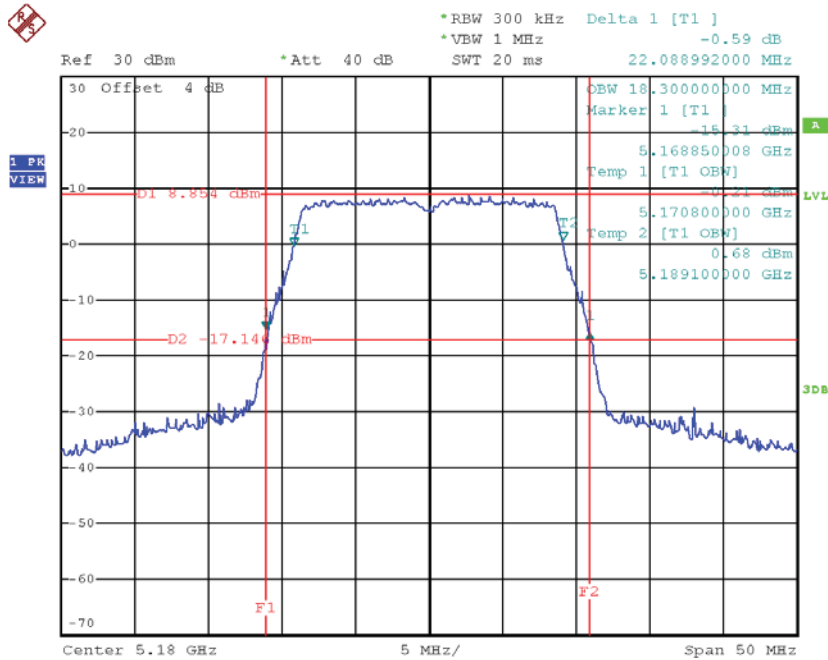

Date: 12.AUG.2017 15:48:41

TX CH40

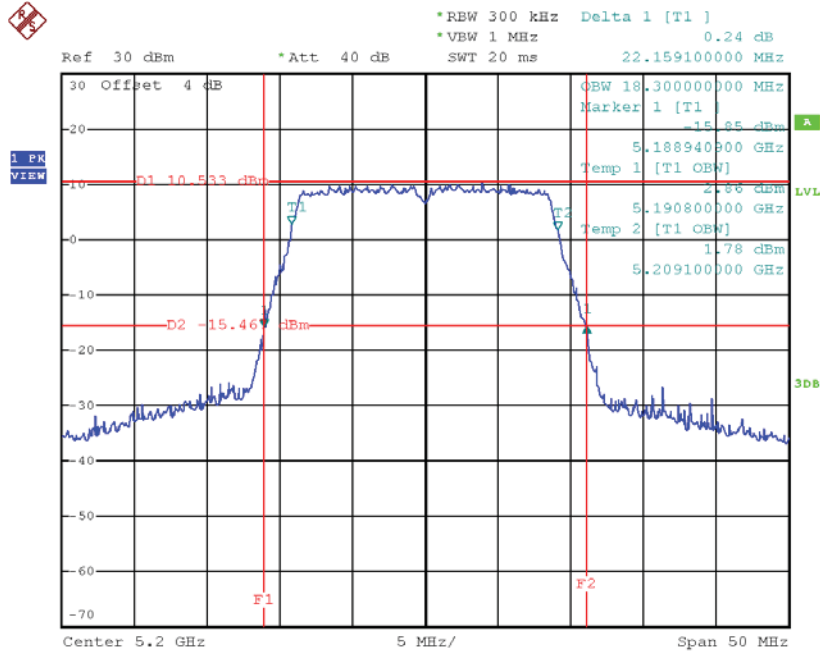

Date: 12.AUG.2017 15:49:41

TX CH48

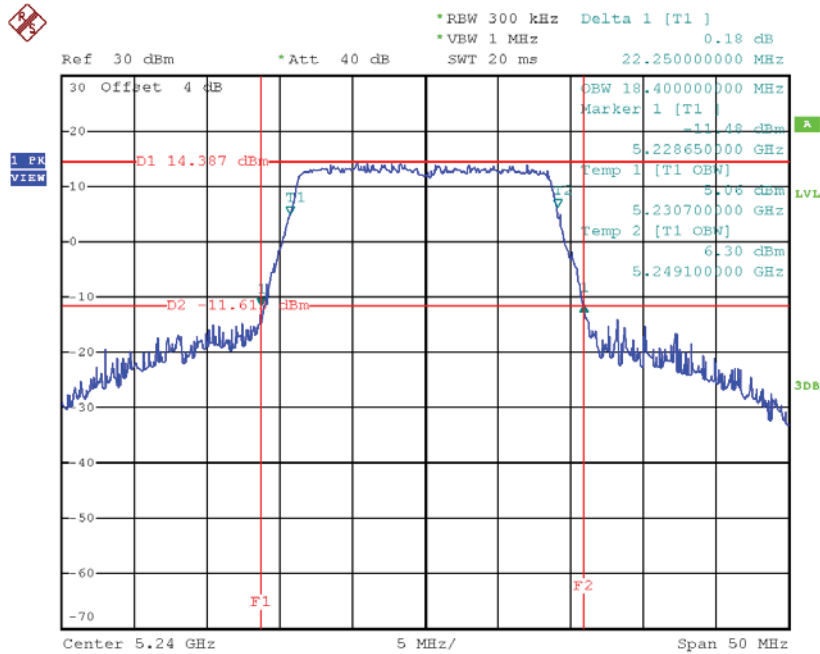

Date: 12.AUG.2017 15:50:26

Test Mode: UNII-1/TX N40 Mode_CH38/CH46

Channel	Frequency (MHz)	26dB Bandwidth (MHz)	99% Occupied Bandwidth (MHz)
CH38	5190	41.60	37.00
CH46	5230	41.80	37.00

TX CH38

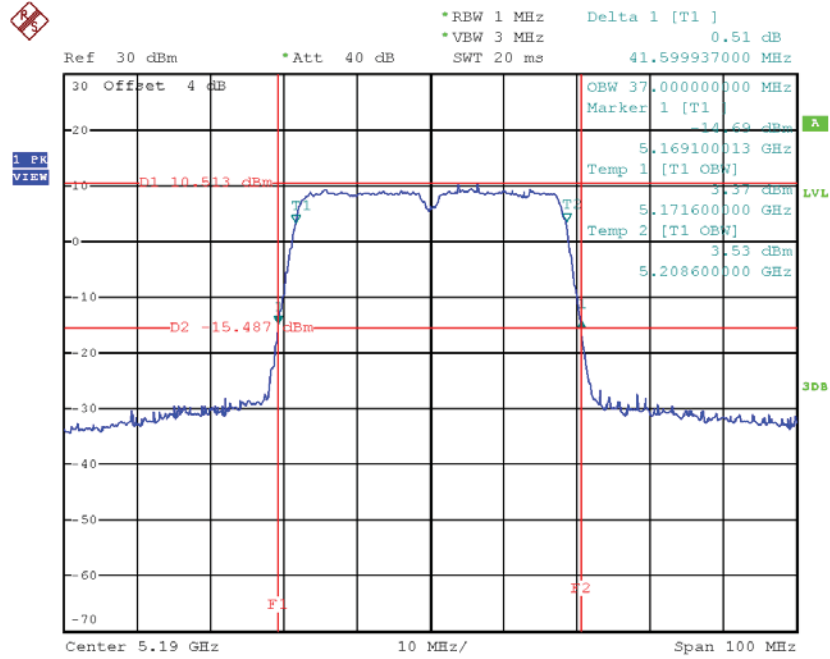

Date: 12.AUG.2017 16:58:02

TX CH46

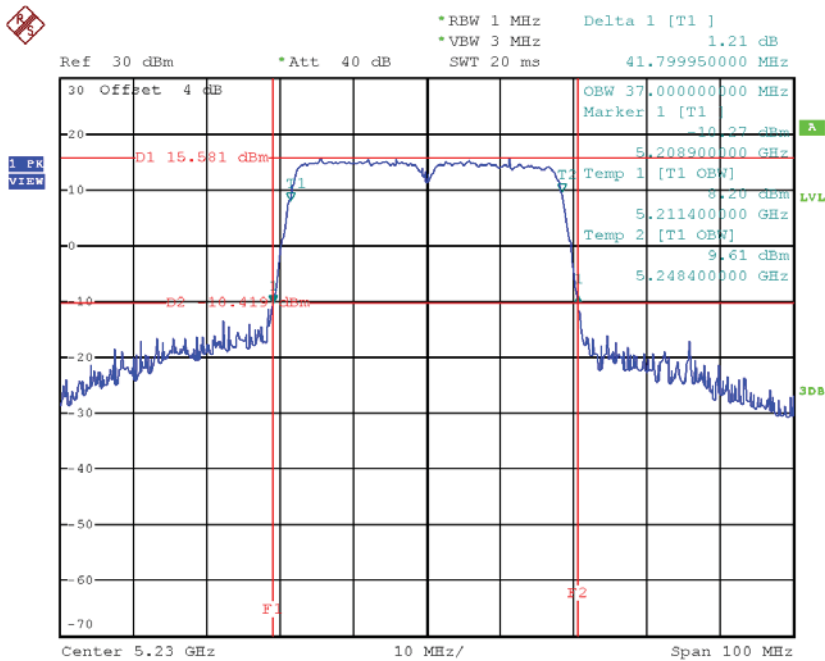

Date: 12.AUG.2017 16:59:21

Test Mode: UNII-3/ TX N20 Mode_CH149/CH157/CH165

Channel	Frequency (MHz)	6dB Bandwidth (MHz)	99% Occupied Bandwidth (MHz)	Limit (kHz)
CH149	5745	17.65	17.80	>=500
CH157	5785	17.65	18.50	>=500
CH165	5825	17.75	17.90	>=500

TX CH 149

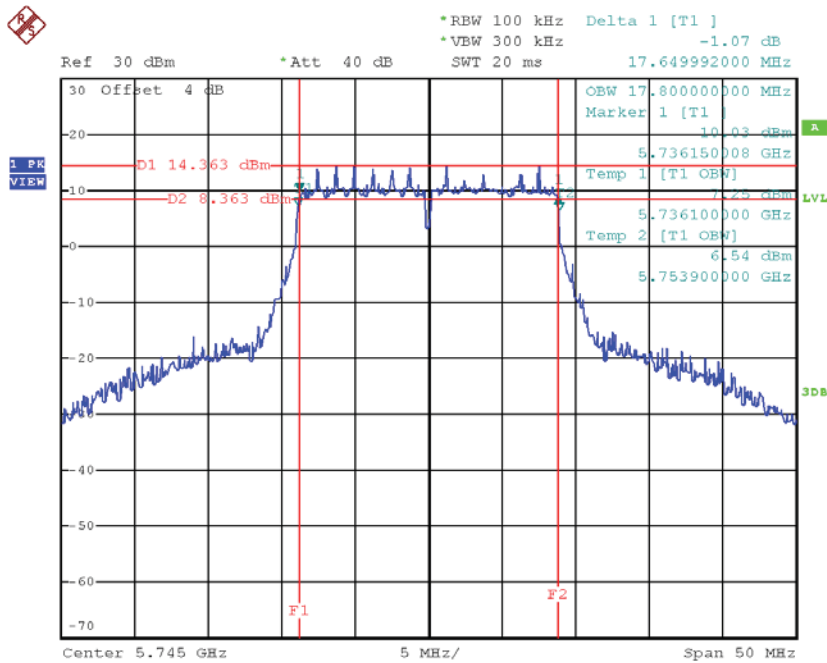

Date: 12.AUG.2017 15:51:45

TX CH 157

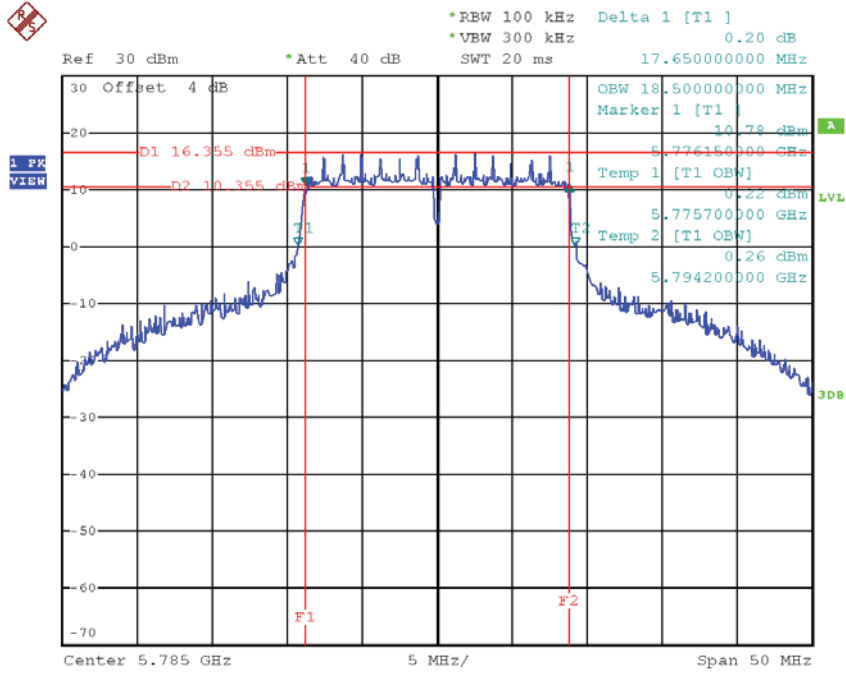

Date: 12.AUG.2017 15:52:34

TX CH 165

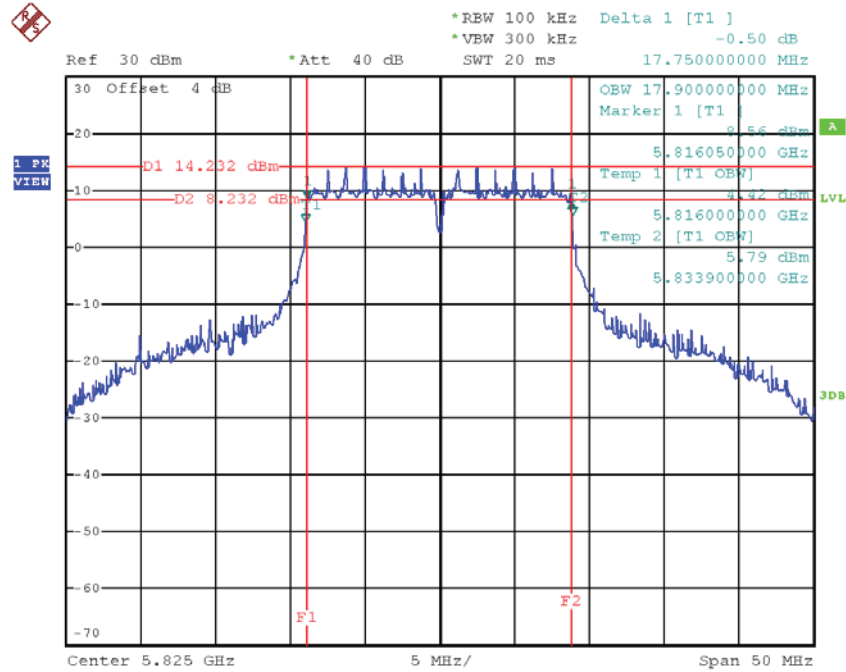

Date: 12.AUG.2017 15:53:23

Test Mode: UNII-3/ TX N40 Mode_CH151/CH159

Channel	Frequency (MHz)	6dB Bandwidth (MHz)	99% Occupied Bandwidth (MHz)	Limit (kHz)
CH151	5755	36.50	36.40	>=500
CH159	5795	36.50	36.40	>=500

TX CH 151

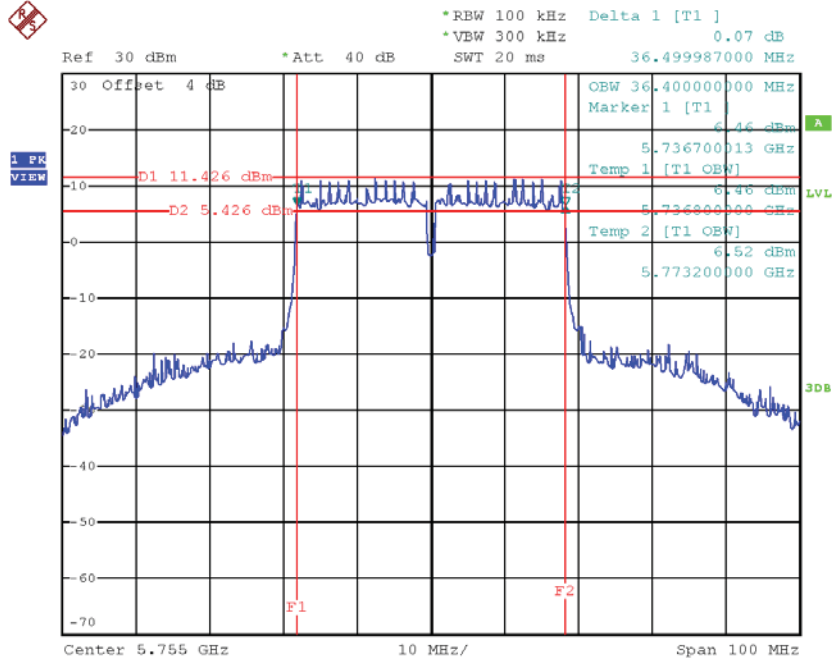

Date: 12.AUG.2017 17:00:33

TX CH 159

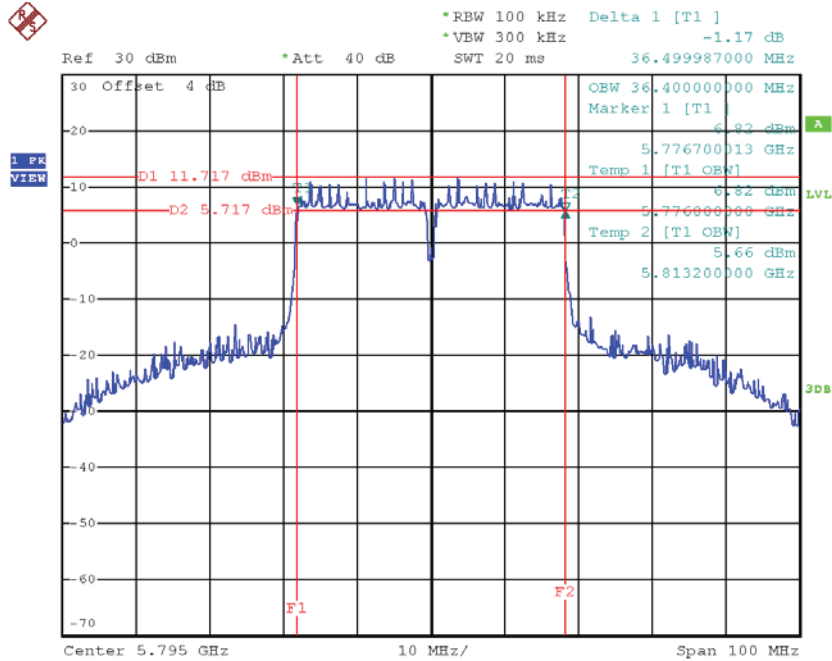

Date: 12.AUG.2017 17:01:28

Test Mode: UNII-1/TX AC20 Mode_CH36/CH40/CH48

Channel	Frequency (MHz)	26dB Bandwidth (MHz)	99% Occupied Bandwidth (MHz)
CH36	5180	22.05	18.40
CH40	5200	22.09	18.30
CH48	5240	22.15	18.40

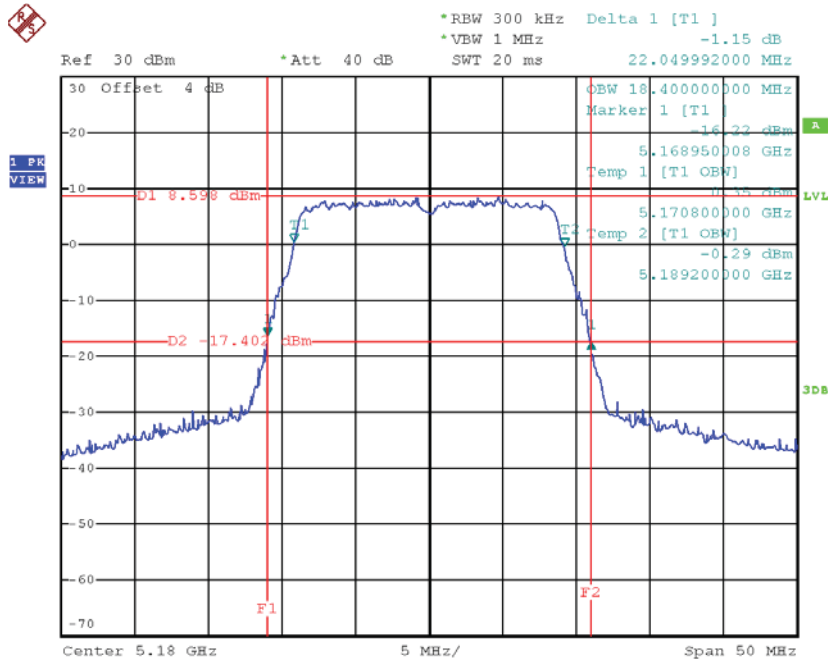
TX CH36

Date: 12.AUG.2017 16:39:43