

Supplemental “Transmit Simultaneously” Test Report

Report No.: RF150828E07-2

FCC ID: W59XAP1510

Test Model: XAP-1510

Series Model: XWS-2510

Received Date: Aug. 28, 2015

Test Date: Sep. 01 to 12, 2015

Issued Date: Sep. 23, 2015

Applicant: Luxul Wireless

Address: 14203 Minuteman Dr Suite 201 Draper UT 84020 USA

Issued By: Bureau Veritas Consumer Products Services (H.K.) Ltd., Taoyuan Branch
Hsin Chu Laboratory

Lab Address: No. 81-1, Lu Liao Keng, 9th Ling, Wu Lung Tsuen, Chiung Lin Hsiang, Hsin
Chu Hsien 307, Taiwan R.O.C.

Test Location (1): No. 81-1, Lu Liao Keng, 9th Ling, Wu Lung Tsuen, Chiung Lin Hsiang, Hsin
Chu Hsien 307, Taiwan R.O.C.

Test Location (2): No. 49, Ln. 206, Wende Rd., Shangshan Tsuen, Chiung Lin Hsiang, Hsin
Chu Hsien 307, Taiwan R.O.C.

Test Location (3): E-2, No.1, Li Hsin 1st Road, Hsinchu Science Park, Hsinchu City 300,
Taiwan R.O.C.



This report is for your exclusive use. Any copying or replication of this report to or for any other person or entity, or use of our name or trademark, is permitted only with our prior written permission. This report sets forth our findings solely with respect to the test samples identified herein. The results set forth in this report are not indicative or representative of the quality or characteristics of the lot from which a test sample was taken or any similar or identical product unless specifically and expressly noted. Our report includes all of the tests requested by you and the results thereof based upon the information that you provided to us. You have 60 days from date of issuance of this report to notify us of any material error or omission caused by our negligence, provided, however, that such notice shall be in writing and shall specifically address the issue you wish to raise. A failure to raise such issue within the prescribed time shall constitute your unqualified acceptance of the completeness of this report, the tests conducted and the correctness of the report contents. Unless specific mention, the uncertainty of measurement has been explicitly taken into account to declare the compliance or non-compliance to the specification. The report must not be used by the client to claim product certification, approval, or endorsement by TAF or any government agencies

Table of Contents

Release Control Record	3
1 Certificate of Conformity	4
2 Summary of Test Results	5
2.1 Measurement Uncertainty.....	5
2.2 Modification Record.....	5
3 General Information	6
3.1 General Description of EUT.....	6
3.2 Test Mode Applicability and Tested Channel Detail.....	9
3.3 Duty Cycle of Test Signal.....	10
3.4 Description of Support Units.....	11
3.4.1 Configuration of System under Test.....	11
3.5 General Description of Applied Standards.....	12
4 Test Types and Results	13
4.1 Radiated Emission and Bandedge Measurement.....	13
4.1.1 Limits of Radiated Emission and Bandedge Measurement.....	13
4.1.2 Test Instruments.....	14
4.1.3 Test Procedures.....	16
4.1.4 Deviation from Test Standard.....	16
4.1.5 Test Setup.....	17
4.1.6 EUT Operating Conditions.....	17
4.1.7 Test Results.....	18
4.2 Conducted Emission Measurement.....	20
4.2.1 Limits of Conducted Emission Measurement.....	20
4.2.2 Test Instruments.....	20
4.2.3 Test Procedures.....	21
4.2.4 Deviation from Test Standard.....	21
4.2.5 Test Setup.....	21
4.2.6 EUT Operating Conditions.....	21
4.2.7 Test Results.....	22
4.3 Conducted Out of Band Emission Measurement.....	24
4.3.1 Limits of Conducted Out of Band Emission Measurement.....	24
4.3.2 Test Setup.....	24
4.3.3 Test Instruments.....	24
4.3.4 Test Procedure.....	24
4.3.5 Deviation from Test Standard.....	24
4.3.6 EUT Operating Condition.....	24
4.3.7 Test Results.....	24
5 Pictures of Test Arrangements	26
Appendix – Information on the Testing Laboratories	27



Release Control Record

Issue No.	Description	Date Issued
RF150828E07-2	Original release.	Sep. 23, 2015

2 Summary of Test Results

47 CFR FCC Part 15, Subpart C (SECTION 15.247)			
FCC Clause	Test Item	Result	Remarks
15.207	AC Power Conducted Emission	PASS	Meet the requirement of limit. Minimum passing margin is -3.46dB at 0.29844MHz.
15.205 / 15.209 / 15.247(d)	Radiated Emissions and Band Edge Measurement	PASS	Meet the requirement of limit. Minimum passing margin is -0.6dB at 17385.00MHz.

2.1 Measurement Uncertainty

Where relevant, the following measurement uncertainty levels have been estimated for tests performed on the EUT as specified in CISPR 16-4-2:

Measurement	Frequency	Expanded Uncertainty (k=2) (±)
Conducted Emissions at mains ports	150kHz ~ 30MHz	2.86 dB
Radiated Emissions up to 1 GHz	30MHz ~ 1GHz	5.43 dB
Radiated Emissions above 1 GHz	1GHz ~ 6GHz	3.65 dB
	6GHz ~ 18GHz	3.88 dB
	18GHz ~ 40GHz	4.11 dB

2.2 Modification Record

There were no modifications required for compliance.

3 General Information

3.1 General Description of EUT

Product	High Power AC1900 Dual-Band Wireless AP
Brand	LUXUL
Test Model	XAP-1510
Series Model	XWS-2510
Status of EUT	ENGINEERING SAMPLE
Power Supply Rating	48Vdc from POE
Modulation Type	CCK, DQPSK, DBPSK for DSSS 64QAM, 16QAM, QPSK, BPSK for OFDM 256QAM for OFDM in 11ac mode and VHT (20/40) mode in 2.4GHz
Modulation Technology	DSSS, OFDM
Transfer Rate	802.11b: up to 11Mbps 802.11a: up to 54Mbps 802.11n: up to 450Mbps 802.11ac: up to 1300Mbps
Operating Frequency	For 15.247: 2.412 ~ 2.462GHz For 15.407: 5.18 ~ 5.24GHz, 5.745 ~ 5.825GHz
Number of Channel	For 2.4GHz: 11 for 802.11b, 802.11g, 802.11n (HT20), VHT20 7 for 802.11n (HT40), VHT40 For 5GHz: 9 for 802.11a, 802.11n (HT20), 802.11ac (VHT20) 4 for 802.11n (HT40), 802.11ac (VHT40) 2 for 802.11ac (VHT80)
Output Power	For 2.4GHz: CDD Mode: 802.11b: 605.624mW 802.11g: 790.746mW VHT20: 751.503mW VHT40: 229.57mW Beamforming Mode: VHT20: 547.733mW VHT40: 191.375mW For 5GHz: CDD Mode: 802.11a: 447.865mW 802.11ac (VHT20): 392.124W 802.11ac (VHT40): 611.716mW 802.11ac (VHT80): 195.614mW Beamforming Mode: 802.11ac (VHT20): 378.038mW 802.11ac (VHT40): 388.373mW 802.11ac (VHT80): 130.735mW
Antenna Type	Refer to Note
Antenna Connector	Refer to Note
Accessory Device	POE x 1
Data Cable Supplied	RJ45 cable (Unshielded, 0.9m) x 1

Note:

1. The EUT has two model names, which are identical to each other in all aspects except for the following table:

Brand	Model No.	Difference
LUXUL	XAP-1510	With one XAP-1510 in gift box.
	XWS-2510	With two XAP-1510 in gift box.

From the above models, model: XAP-1510 was selected as representative model for the test and its data was recorded in this report.

2. 2.4GHz and 5GHz technology can transmit at same time.
 3. The antennas provided to the EUT, please refer to the following table:

Transmitter Circuit	Brand	Model	Antenna Gain (dBi)	Frequency range (GHz to GHz)	Antenna Type	Connector Type
Chain (0)	NA	29020222	2.7	2.4-2.4835	PIFA	i-pex(MHF)
			5.2	5.15-5.85		
Chain (1)	NA	29020223	2.7	2.4-2.4835	PIFA	i-pex(MHF)
			5.2	5.15-5.85		
Chain (2)	NA	29020224	2.7	2.4-2.4835	PIFA	i-pex(MHF)
			5.2	5.15-5.85		

4. The EUT must be supplied with an POE as following table:

Brand Name	Model No.	Spec.
Great power	GRT-480125A	Input: 100-240V, 50/60Hz Output: 48V, 1250mA

5. The EUT incorporates a MIMO function.

2.4GHz Band			
MODULATION MODE	DATA RATE (MCS)	TX & RX CONFIGURATION	
802.11b	1 ~ 11Mbps	3TX	3RX
802.11g	6 ~ 54Mbps	3TX	3RX
802.11n (HT20)	MCS 0~7	3TX	3RX
	MCS 8~15	3TX	3RX
	MCS 16~23	3TX	3RX
802.11n (HT40)	MCS 0~7	3TX	3RX
	MCS 8~15	3TX	3RX
	MCS 16~23	3TX	3RX
VHT20	MCS 0~8, Nss=1	3TX	3RX
	MCS 0~8, Nss=2	3TX	3RX
	MCS 0~9, Nss=3	3TX	3RX
VHT40	MCS 0~9, Nss=1	3TX	3RX
	MCS 0~9, Nss=2	3TX	3RX
	MCS 0~9, Nss=3	3TX	3RX
5GHz Band			
MODULATION MODE	DATA RATE (MCS)	TX & RX CONFIGURATION	
802.11a	6 ~ 54Mbps	3TX	3RX
802.11n (HT20)	MCS 0~7	3TX	3RX
	MCS 8~15	3TX	3RX
	MCS 16~23	3TX	3RX
802.11n (HT40)	MCS 0~7	3TX	3RX
	MCS 8~15	3TX	3RX
	MCS 16~23	3TX	3RX
802.11ac (VHT20)	MCS 0~8, Nss=1	3TX	3RX
	MCS 0~8, Nss=2	3TX	3RX
	MCS 0~9, Nss=3	3TX	3RX
802.11ac (VHT40)	MCS 0~9, Nss=1	3TX	3RX
	MCS 0~9, Nss=2	3TX	3RX
	MCS 0~9, Nss=3	3TX	3RX
802.11ac (VHT80)	MCS 0~9, Nss=1	3TX	3RX
	MCS 0~9, Nss=2	3TX	3RX
	MCS 0~9, Nss=3	3TX	3RX

Note:

1. All of modulation mode support beamforming function except (802.11b/g/a) modulation mode.

6. The above EUT information is declared by manufacturer and for more detailed features description, please refer to the manufacturer's specifications or user's manual.

3.2 Test Mode Applicability and Tested Channel Detail

EUT CONFIGURE MODE	APPLICABLE TO				DESCRIPTION
	RE \geq 1G	RE $<$ 1G	PLC	OB	
-	√	√	√	√	-

Where **RE \geq 1G**: Radiated Emission above 1GHz

RE $<$ 1G: Radiated Emission below 1GHz

PLC: Power Line Conducted Emission

OB: Conducted Out-Band Emission Measurement

NOTE:

1. The EUT had been pre-tested on the positioned of each 2 axis. The worst case was found when positioned on **Y-plane**.

Radiated Emission Test (Above 1GHz):

Following channel(s) was (were) selected for the final test as listed below.

MODE	AVAILABLE CHANNEL	TESTED CHANNEL	MODULATION TECHNOLOGY	MODULATION TYPE	DATA RATE (Mbps)
2.4GHz (802.11g + 5GHz (802.11ac (VHT40)))	1 to 11	6	OFDM	BPSK	6
	151 to 159	159	OFDM	BPSK	13.5

Radiated Emission Test (Below 1GHz):

Following channel(s) was (were) selected for the final test as listed below.

MODE	AVAILABLE CHANNEL	TESTED CHANNEL	MODULATION TECHNOLOGY	MODULATION TYPE	DATA RATE (Mbps)
2.4GHz (802.11g + 5GHz (802.11ac (VHT40)))	1 to 11	6	OFDM	BPSK	6
	151 to 159	159	OFDM	BPSK	13.5

Power Line Conducted Emission Test:

Following channel(s) was (were) selected for the final test as listed below.

MODE	AVAILABLE CHANNEL	TESTED CHANNEL	MODULATION TECHNOLOGY	MODULATION TYPE	DATA RATE (Mbps)
2.4GHz (802.11g + 5GHz (802.11ac (VHT40)))	1 to 11	6	OFDM	BPSK	6
	151 to 159	159	OFDM	BPSK	13.5

Conducted Out-Band Emission Measurement:

Following channel(s) was (were) selected for the final test as listed below.

MODE	AVAILABLE CHANNEL	TESTED CHANNEL	MODULATION TECHNOLOGY	MODULATION TYPE	DATA RATE (Mbps)
2.4GHz (802.11g + 5GHz (802.11ac (VHT40)))	1 to 11	6	OFDM	BPSK	6
	151 to 159	159	OFDM	BPSK	13.5

Test Condition:

APPLICABLE TO	ENVIRONMENTAL CONDITIONS	INPUT POWER	TESTED BY
RE\geq1G	24deg. C, 67%RH	120Vac, 60Hz	Andy Ho
RE$<$1G	23deg. C, 69%RH	120Vac, 60Hz	Robert Cheng
PLC	26deg. C, 62%RH	120Vac, 60Hz	Timmy Hu
OB	25deg. C, 60%RH	120Vac, 60Hz	Andy Ho

3.3 Duty Cycle of Test Signal

Duty cycle of test signal is $\geq 98\%$, duty factor is not required.

2.4GHz_802.11g: Duty cycle = $2.064\text{ ms} / 2.087\text{ ms} = 0.989$

5GHz Band_802.11ac (VHT40): Duty cycle = $0.943\text{ ms} / 0.962\text{ ms} = 0.98$

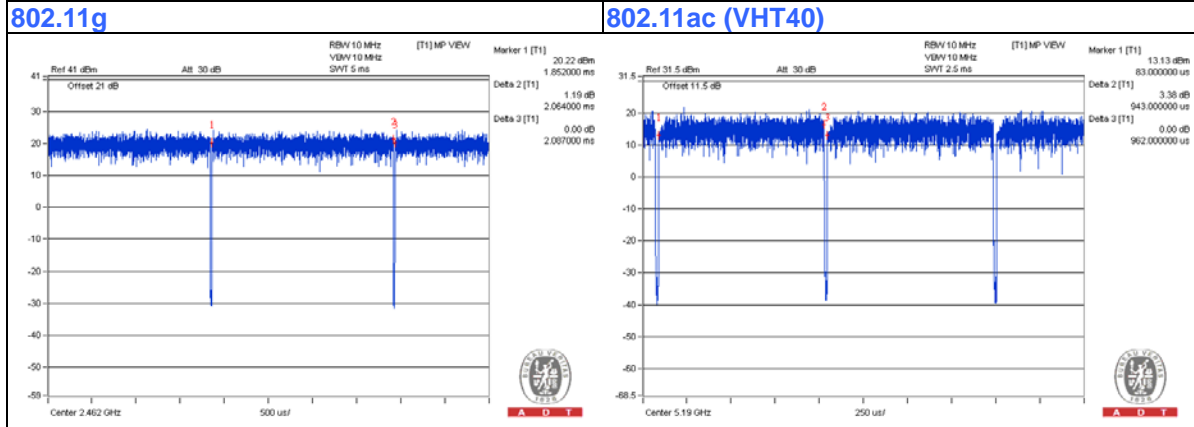

3.4 Description of Support Units

The EUT has been tested as an independent unit together with other necessary accessories or support units. The following support units or accessories were used to form a representative test configuration during the tests.

ID	Product	Brand	Model No.	Serial No.	FCC ID	Remarks
A.	Notebook Computer	DELL	E5430	HYV4VY1	FCC DoC	Provided by Lab
B.	HUB	ZyXEL	ES-116P	S060H02000215	FCC DoC	Provided by Lab

Note:

1. All power cords of the above support units are non-shielded (1.8m).

ID	Descriptions	Qty.	Length (m)	Shielding (Yes/No)	Cores (Qty.)	Remarks
1.	RJ45	1	0.9	No	0	Supplied by Client
2.	RJ45	1	10	No	0	Provided by Lab
3.	RJ45	1	10	No	0	Provided by Lab
4.	AC	1	1.8	No	0	Supplied by Client

3.4.1 Configuration of System under Test

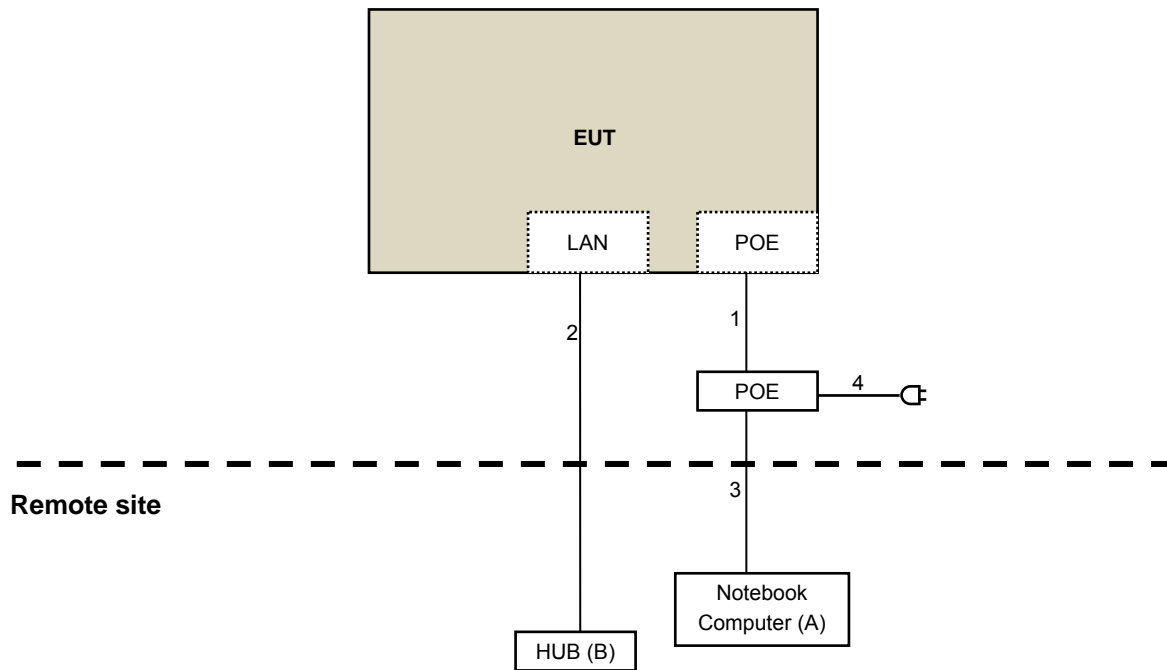

3.5 General Description of Applied Standards

The EUT is a RF Product. According to the specifications of the manufacturer, it must comply with the requirements of the following standards:

FCC Part 15, Subpart C (15.247)

ANSI C63.10-2013

All test items have been performed and recorded as per the above standards.

NOTE: The EUT has been verified to comply with the requirements of FCC Part 15, Subpart B, Class B (DoC). The test report has been issued separately.

4 Test Types and Results

4.1 Radiated Emission and Bandedge Measurement

4.1.1 Limits of Radiated Emission and Bandedge Measurement

Radiated emissions which fall in the restricted bands must comply with the radiated emission limits specified as below table. Other emissions shall be at least 30dB below the highest level of the desired power:

Frequencies (MHz)	Field Strength (microvolts/meter)	Measurement Distance (meters)
0.009 ~ 0.490	2400/F(kHz)	300
0.490 ~ 1.705	24000/F(kHz)	30
1.705 ~ 30.0	30	30
30 ~ 88	100	3
88 ~ 216	150	3
216 ~ 960	200	3
Above 960	500	3

NOTE:

1. The lower limit shall apply at the transition frequencies.
2. Emission level (dBuV/m) = 20 log Emission level (uV/m).
3. For frequencies above 1000MHz, the field strength limits are based on average detector, however, the peak field strength of any emission shall not exceed the maximum permitted average limits, specified above by more than 20dB under any condition of modulation.

4.1.2 Test Instruments

For below 1GHz:

DESCRIPTION & MANUFACTURER	MODEL NO.	SERIAL NO.	CALIBRATED DATE	CALIBRATED UNTIL
Test Receiver Agilent	N9038A	MY51210202	Dec. 12, 2014	Dec. 11, 2015
Pre-Amplifier Mini-Circuits	ZFL-1000VH2 B	AMP-ZFL-04	Nov. 12, 2014	Nov. 11, 2015
Trilog Broadband Antenna SCHWARZBECK	VULB 9168	9168-361	Feb. 09, 2015	Feb. 08, 2016
RF Cable	8D-FB	CHHCAB-001-1 CHHCAB-001-2	Oct. 05, 2014	Oct. 04, 2015
	RF-141	CHHCAB-004	Oct. 05, 2014	Oct. 04, 2015
Software	ADT_Radiated _V8.7.07	NA	NA	NA
Antenna Tower & Turn Table CT	NA	NA	NA	NA

Note:

1. The calibration interval of the above test instruments is 12 months and the calibrations are traceable to NML/ROC and NIST/USA.
2. The test was performed in 966 Chamber No. H.
3. The FCC Site Registration No. is 797305.
4. The CANADA Site Registration No. is IC 7450H-3.
5. Tested Date: Sep. 10, 2015

For other test items:

DESCRIPTION & MANUFACTURER	MODEL NO.	SERIAL NO.	CALIBRATED DATE	CALIBRATED UNTIL
Test Receiver Agilent	N9038A	MY51210105	July 24, 2015	July 23, 2016
Horn_Antenna AISI	AIH.8018	000032009111 0	Feb. 09, 2015	Feb. 08, 2016
Pre-Amplifier Agilent	8449B	3008A02578	June 23, 2015	June 22, 2016
RF Cable	NA	131205 131216 131217 SNMY23684/ 4	Jan. 16, 2015	Jan. 15, 2016
Spectrum Analyzer R&S	FSV40	100964	June 26, 2015	June 25, 2016
Pre-Amplifier SPACEK LABS	SLKKa-48-6	9K16	Dec. 12, 2014	Dec. 11, 2015
Horn_Antenna SCHWARZBECK	BBHA 9170	9170-424	Feb. 05, 2015	Feb. 04, 2016
RF Cable	NA	329751/4 RF104-204	Dec. 11, 2014	Dec. 10, 2015
Software	ADT_Radiated _V8.7.07	NA	NA	NA
Antenna Tower & Turn Table CT	NA	NA	NA	NA
Power Meter Anritsu	ML2495A	1014008	Apr. 28, 2015	Apr. 27, 2016
Power Sensor Anritsu	MA2411B	0917122	Apr. 28, 2015	Apr. 27, 2016
Spectrum Analyzer R&S	FSP 40	100060	May 08, 2015	May 07, 2016

Note:

1. The calibration interval of the above test instruments is 12 months and the calibrations are traceable to NML/ROC and NIST/USA.
2. The test was performed in 966 Chamber No. G.
3. The FCC Site Registration No. is 966073.
4. The VCCI Site Registration No. is G-137.
5. The CANADA Site Registration No. is IC 7450H-2.
6. Tested Date: Sep. 01 to 12, 2015

4.1.3 Test Procedures

- a. The EUT was placed on the top of a rotating table 0.8 meters (for below 1GHz) / 1.5 meters (for above 1GHz) above the ground at 3 meter chamber room for test. The table was rotated 360 degrees to determine the position of the highest radiation.
- b. The EUT was set 3 meters away from the interference-receiving antenna, which was mounted on the top of a variable-height antenna tower.
- c. The height of antenna is varied from one meter to four meters above the ground to determine the maximum value of the field strength. Both horizontal and vertical polarizations of the antenna are set to make the measurement.
- d. For each suspected emission, the EUT was arranged to its worst case and then the antenna was tuned to heights from 1 meter to 4 meters and the rotatable table was turned from 0 degrees to 360 degrees to find the maximum reading.
- e. The test-receiver system was set to quasi-peak detect function and specified bandwidth with maximum hold mode when the test frequency is below 1 GHz.
- f. The test-receiver system was set to peak and average detect function and specified bandwidth with maximum hold mode when the test frequency is above 1 GHz. If the peak reading value also meets average limit, measurement with the average detector is unnecessary.

Note:

1. The resolution bandwidth and video bandwidth of test receiver/spectrum analyzer is 120kHz for Quasi-peak detection (QP) at frequency below 1GHz.
2. The resolution bandwidth of test receiver/spectrum analyzer is 1 MHz and the video bandwidth is 3 MHz for Peak detection (PK) at frequency above 1GHz.
3. The resolution bandwidth of test receiver/spectrum analyzer is 1MHz and the video bandwidth is 3MHz for RMS Average (Duty cycle < 98%) for Average detection (AV) at frequency above 1GHz, then the measurement results was added to a correction factor ($10 \log(1/\text{duty cycle})$).
4. The resolution bandwidth of test receiver/spectrum analyzer is 1MHz and the video bandwidth is 10Hz (Duty cycle $\geq 98\%$) for Average detection (AV) at frequency above 1GHz.
5. All modes of operation were investigated and the worst-case emissions are reported.

4.1.4 Deviation from Test Standard

No deviation.

4.1.5 Test Setup

<Frequency Range below 1GHz>

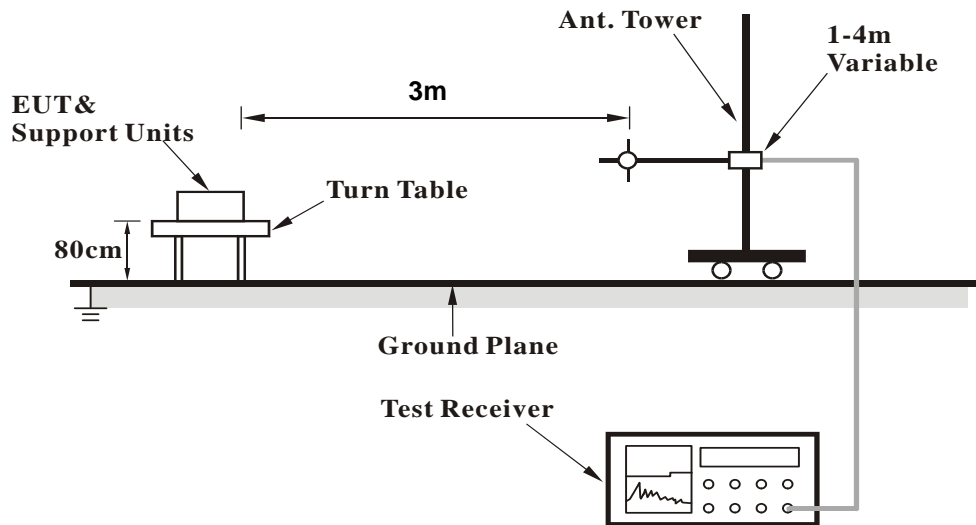

<Frequency Range above 1GHz>

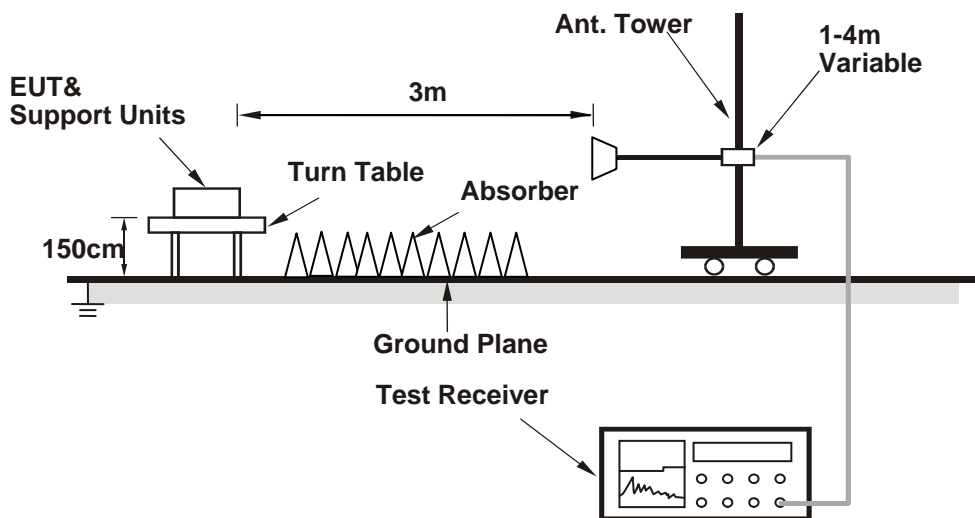

For the actual test configuration, please refer to the attached file (Test Setup Photo).

4.1.6 EUT Operating Conditions

1. Connect the EUT with the support unit A (Notebook Computer) which is placed on remote site.
2. Controlling software (MTool_2.0.1.1.exe) has been activated to set the EUT on specific status.

4.1.7 Test Results

Above 1GHz Data:

FREQUENCY RANGE	1GHz ~ 40GHz	DETECTOR FUNCTION	Peak (PK) Average (AV)
------------------------	--------------	--------------------------	---------------------------

ANTENNA POLARITY & TEST DISTANCE: HORIZONTAL AT 3 M								
NO.	FREQ. (MHz)	EMISSION LEVEL (dBuV/m)	LIMIT (dBuV/m)	MARGIN (dB)	ANTENNA HEIGHT (m)	TABLE ANGLE (Degree)	RAW VALUE (dBuV)	CORRECTION FACTOR (dB/m)
1	4874.00	42.8 PK	74.0	-31.2	1.92 H	326	35.55	7.25
2	4874.00	31.7 AV	54.0	-22.3	1.92 H	326	24.45	7.25
3	7311.00	62.7 PK	74.0	-11.3	1.61 H	80	48.25	14.45
4	7311.00	48.2 AV	54.0	-5.8	1.61 H	80	33.75	14.45
5	11590.00	62.4 PK	74.0	-11.6	1.88 H	360	47.09	15.31
6	11590.00	52.3 AV	54.0	-1.7	1.88 H	360	36.99	15.31
7	#17385.00	67.6 PK	68.2	-0.6	1.43 H	314	43.84	23.76
ANTENNA POLARITY & TEST DISTANCE: VERTICAL AT 3 M								
NO.	FREQ. (MHz)	EMISSION LEVEL (dBuV/m)	LIMIT (dBuV/m)	MARGIN (dB)	ANTENNA HEIGHT (m)	TABLE ANGLE (Degree)	RAW VALUE (dBuV)	CORRECTION FACTOR (dB/m)
1	4874.00	47.9 PK	74.0	-26.1	1.77 V	356	40.65	7.25
2	4874.00	35.6 AV	54.0	-18.4	1.77 V	356	28.35	7.25
3	7311.00	58.4 PK	74.0	-15.6	2.26 V	341	43.95	14.45
4	7311.00	46.7 AV	54.0	-7.3	2.26 V	341	32.25	14.45
5	11590.00	62.0 PK	74.0	-12.0	1.13 V	360	46.69	15.31
6	11590.00	50.9 AV	54.0	-3.1	1.13 V	360	35.59	15.31
7	#17385.00	64.7 PK	68.2	-3.5	1.84 V	125	40.94	23.76

REMARKS:

1. Emission Level(dBuV/m) = Raw Value(dBuV) + Correction Factor(dB/m)
2. Correction Factor(dB/m) = Antenna Factor(dB/m) + Cable Factor(dB) – Pre-Amplifier Factor(dB)
3. The other emission levels were very low against the limit.
4. Margin value = Emission Level – Limit value
5. "#": The radiated frequency is out of the restricted band.

Below 1GHz Data:

FREQUENCY RANGE	Below 1GHz	DETECTOR FUNCTION	Quasi-Peak (QP)
------------------------	------------	--------------------------	-----------------

ANTENNA POLARITY & TEST DISTANCE: HORIZONTAL AT 3 M								
NO.	FREQ. (MHz)	EMISSION LEVEL (dBuV/m)	LIMIT (dBuV/m)	MARGIN (dB)	ANTENNA HEIGHT (m)	TABLE ANGLE (Degree)	RAW VALUE (dBuV)	CORRECTION FACTOR (dB/m)
1	40.32	31.7 QP	40.0	-8.4	1.54 H	360	45.41	-13.76
2	90.42	35.4 QP	43.5	-8.1	1.67 H	145	54.36	-18.94
3	158.61	37.8 QP	43.5	-5.7	1.34 H	144	50.75	-12.93
4	168.62	40.3 QP	43.5	-3.2	1.20 H	124	53.65	-13.31
5	195.71	32.8 QP	43.5	-10.7	1.42 H	241	48.76	-15.94
6	326.81	35.6 QP	46.0	-10.4	1.42 H	211	46.45	-10.89

ANTENNA POLARITY & TEST DISTANCE: VERTICAL AT 3 M								
NO.	FREQ. (MHz)	EMISSION LEVEL (dBuV/m)	LIMIT (dBuV/m)	MARGIN (dB)	ANTENNA HEIGHT (m)	TABLE ANGLE (Degree)	RAW VALUE (dBuV)	CORRECTION FACTOR (dB/m)
1	37.59	35.8 QP	40.0	-4.2	1.34 V	210	49.77	-13.98
2	38.22	33.9 QP	40.0	-6.1	1.47 V	164	47.79	-13.88
3	76.45	36.4 QP	40.0	-3.6	1.42 V	100	53.24	-16.80
4	97.75	36.7 QP	43.5	-6.8	1.66 V	241	54.74	-18.03
5	169.45	36.8 QP	43.5	-6.8	1.64 V	244	50.15	-13.40
6	341.45	35.2 QP	46.0	-10.8	1.44 V	200	45.98	-10.77

REMARKS:

1. Emission Level(dBuV/m) = Raw Value(dBuV) + Correction Factor(dB/m)
2. Correction Factor(dB/m) = Antenna Factor(dB/m) + Cable Factor(dB) – Pre-Amplifier Factor(dB)
3. The other emission levels were very low against the limit.
4. Margin value = Emission Level – Limit value

4.2 Conducted Emission Measurement

4.2.1 Limits of Conducted Emission Measurement

Frequency (MHz)	Conducted Limit (dBuV)	
	Quasi-peak	Average
0.15 - 0.5	66 - 56	56 - 46
0.50 - 5.0	56	46
5.0 - 30.0	60	50

Note: 1. The lower limit shall apply at the transition frequencies.

2. The limit decreases in line with the logarithm of the frequency in the range of 0.15 to 0.50MHz.

4.2.2 Test Instruments

DESCRIPTION & MANUFACTURER	MODEL NO.	SERIAL NO.	CALIBRATED DATE	CALIBRATED UNTIL
Test Receiver R&S	ESCS 30	100375	May 06, 2015	May 05, 2016
Line-Impedance Stabilization Network (for EUT) R&S	ENV216	100072	June 11, 2015	June 10, 2016
Line-Impedance Stabilization Network (for Peripheral) R&S	ENV216	100071	Nov. 10, 2014	Nov. 09, 2015
RF Cable	5D-FB	COCCAB-001	Mar. 09, 2015	Mar. 08, 2016
50 ohms Terminator	N/A	EMC-03	Sep. 22, 2014	Sep. 21, 2015
50 ohms Terminator	N/A	EMC-02	Sep. 30, 2014	Sep. 29, 2015
Software BVADT	BVADT_Cond_ V7.3.7.3	NA	NA	NA

Note:

1. The calibration interval of the above test instruments are 12 months and the calibrations are traceable to NML/ROC and NIST/USA.
2. The test was performed in Shielded Room No. C.
- 3 The VCCI Con C Registration No. is C-3611.
- 4 Tested Date: Sep. 10, 2015

4.2.3 Test Procedures

- a. The EUT was placed 0.4 meters from the conducting wall of the shielded room with EUT being connected to the power mains through a line impedance stabilization network (LISN). Other support units were connected to the power mains through another LISN. The two LISNs provide 50 ohm/ 50uH of coupling impedance for the measuring instrument.
- b. Both lines of the power mains connected to the EUT were checked for maximum conducted interference.
- c. The frequency range from 150kHz to 30MHz was searched. Emission levels under (Limit - 20dB) was not recorded.

NOTE: The resolution bandwidth and video bandwidth of test receiver is 9kHz for quasi-peak detection (QP) and average detection (AV) at frequency 0.15MHz-30MHz.

4.2.4 Deviation from Test Standard

No deviation.

4.2.5 Test Setup

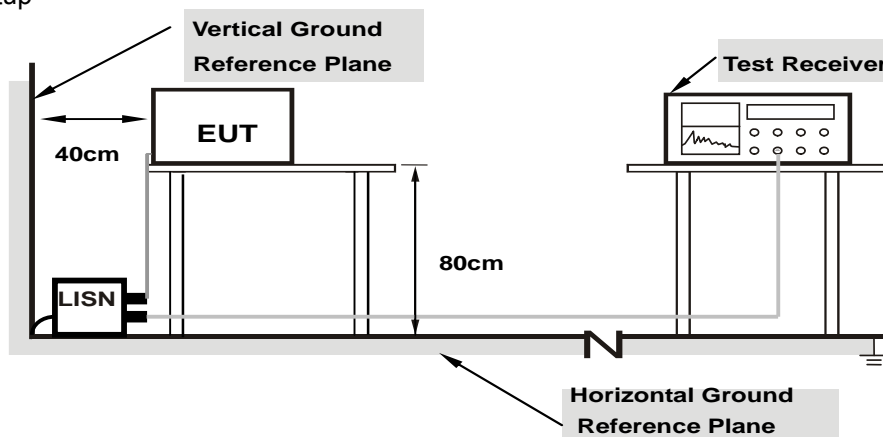

Note: 1.Support units were connected to second LISN.

For the actual test configuration, please refer to the attached file (Test Setup Photo).

4.2.6 EUT Operating Conditions

Same as 4.1.6.

4.2.7 Test Results

Phase	Line (L)	Detector Function	Quasi-Peak (QP) / Average (AV)
-------	----------	-------------------	--------------------------------

No	Freq. [MHz]	Corr. Factor	Reading Value [dB (uV)]		Emission Level [dB (uV)]		Limit [dB (uV)]		Margin (dB)	
		(dB)	Q.P.	AV.	Q.P.	AV.	Q.P.	AV.	Q.P.	AV.
	1	0.29844	0.09	55.80	46.56	55.89	46.65	60.29	50.29	-4.39
2	0.32188	0.10	54.25	38.52	54.35	38.62	59.66	49.66	-5.31	-11.04
3	0.36875	0.10	46.19	35.03	46.29	35.13	58.53	48.53	-12.24	-13.40
4	0.39609	0.10	40.94	30.08	41.04	30.18	57.93	47.93	-16.90	-17.76
5	0.49766	0.10	45.20	31.14	45.30	31.24	56.04	46.04	-10.73	-14.79
6	0.59531	0.11	42.79	31.64	42.90	31.75	56.00	46.00	-13.10	-14.25
7	0.79453	0.12	46.07	34.77	46.19	34.89	56.00	46.00	-9.81	-11.11
8	0.98203	0.13	43.31	32.87	43.44	33.00	56.00	46.00	-12.56	-13.00
9	1.12054	0.13	43.10	32.07	43.23	32.20	56.00	46.00	-12.77	-13.80
10	1.35938	0.14	42.47	32.43	42.61	32.57	56.00	46.00	-13.39	-13.43
11	1.57813	0.15	39.60	29.54	39.75	29.69	56.00	46.00	-16.25	-16.31

REMARKS:

1. Q.P. and AV. are abbreviations of quasi-peak and average individually.
2. The emission levels of other frequencies were very low against the limit.
3. Margin value = Emission level - Limit value
4. Correction factor = Insertion loss + Cable loss
5. Emission Level = Correction Factor + Reading Value

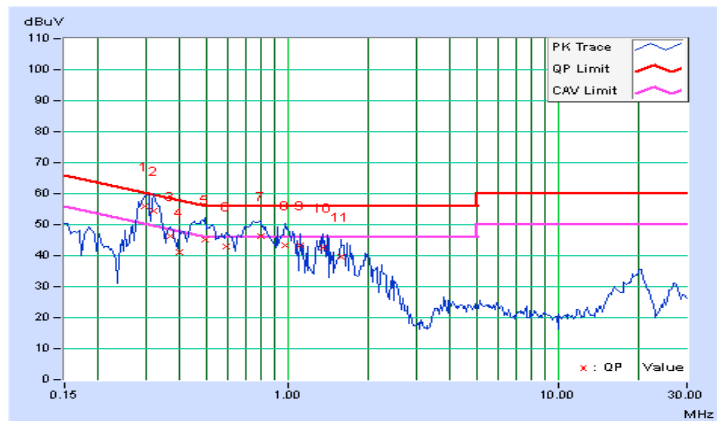

Phase	Neutral (N)	Detector Function	Quasi-Peak (QP) / Average (AV)
-------	-------------	-------------------	--------------------------------

No	Freq. [MHz]	Corr.	Reading Value		Emission Level		Limit		Margin	
		Factor	[dB (uV)]		[dB (uV)]		[dB (uV)]		(dB)	
	(dB)	Q.P.	AV.	Q.P.	AV.	Q.P.	AV.	Q.P.	AV.	
1	0.29844	0.09	55.86	46.74	55.95	46.83	60.29	50.29	-4.34	-3.46
2	0.32188	0.09	54.21	41.06	54.30	41.15	59.66	49.66	-5.36	-8.51
3	0.37266	0.10	45.89	37.93	45.99	38.03	58.44	48.44	-12.45	-10.41
4	0.44688	0.10	46.93	38.37	47.03	38.47	56.93	46.93	-9.90	-8.46
5	0.49375	0.10	46.32	33.44	46.42	33.54	56.10	46.10	-9.68	-12.56
6	0.59922	0.11	42.47	31.15	42.58	31.26	56.00	46.00	-13.42	-14.74
7	0.73203	0.12	46.01	35.09	46.13	35.21	56.00	46.00	-9.87	-10.79
8	0.79453	0.12	45.81	34.77	45.93	34.89	56.00	46.00	-10.07	-11.11
9	0.99766	0.13	44.12	33.58	44.25	33.71	56.00	46.00	-11.75	-12.29
10	1.08594	0.13	44.86	34.28	44.99	34.41	56.00	46.00	-11.01	-11.59

REMARKS:

1. Q.P. and AV. are abbreviations of quasi-peak and average individually.
2. The emission levels of other frequencies were very low against the limit.
3. Margin value = Emission level - Limit value
4. Correction factor = Insertion loss + Cable loss
5. Emission Level = Correction Factor + Reading Value

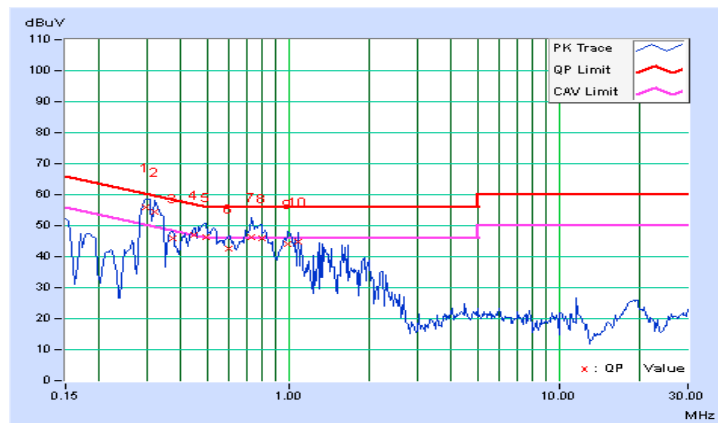

4.3 Conducted Out of Band Emission Measurement

4.3.1 Limits of Conducted Out of Band Emission Measurement

Below 30dB of the highest emission level of operating band (in 100kHz Resolution Bandwidth).

4.3.2 Test Setup

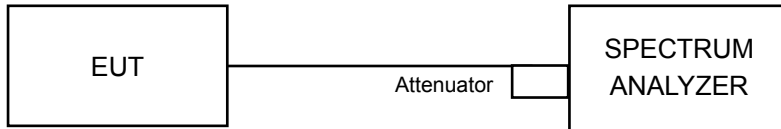

4.3.3 Test Instruments

Refer to section 4.1.2 to get information of above instrument.

4.3.4 Test Procedure

MEASUREMENT PROCEDURE REF

1. Set the RBW = 100 kHz.
2. Set the VBW ≥ 300 kHz.
3. Detector = peak.
4. Sweep time = auto couple.
5. Trace mode = max hold.
6. Allow trace to fully stabilize.
7. Use the peak marker function to determine the maximum power level in any 100 kHz band segment within the fundamental EBW.

MEASUREMENT PROCEDURE OOB

1. Set RBW = 100 kHz.
2. Set VBW ≥ 300 kHz.
3. Detector = peak.
4. Sweep = auto couple.
5. Trace Mode = max hold.
6. Allow trace to fully stabilize.
7. Use the peak marker function to determine the maximum amplitude level.

4.3.5 Deviation from Test Standard

No deviation.

4.3.6 EUT Operating Condition

Same as Item 4.3.6

4.3.7 Test Results

The spectrum plots are attached on the following pages. D1 line indicates the highest level, and D2 line indicates the 30dB offset below D1. It shows compliance with the requirement.

2.4GHz 802.11g CH 6 + 5GHz 802.11ac (VHT40) CH 159

Chain 0

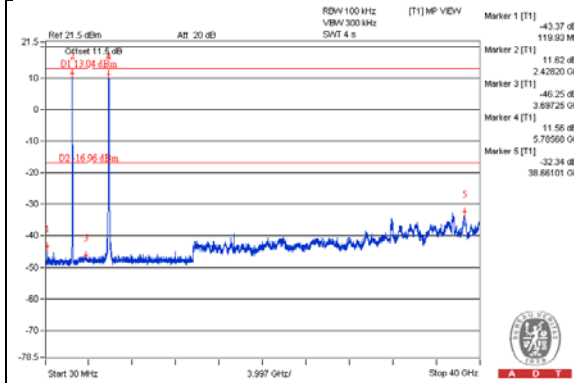

Chain 1

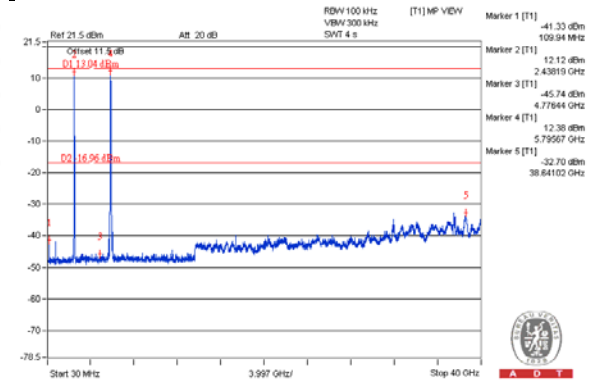

Chain 2

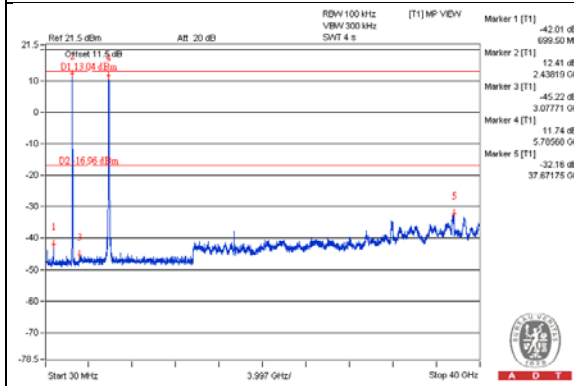

5 Pictures of Test Arrangements

Please refer to the attached file (Test Setup Photo).



Appendix – Information on the Testing Laboratories

We, Bureau Veritas Consumer Products Services (H.K.) Ltd., Taoyuan Branch, were founded in 1988 to provide our best service in EMC, Radio, Telecom and Safety consultation. Our laboratories are accredited and approved according to ISO/IEC 17025.

If you have any comments, please feel free to contact us at the following:

Linko EMC/RF Lab

Tel: 886-2-26052180

Fax: 886-2-26051924

Hsin Chu EMC/RF/Telecom Lab

Tel: 886-3-5935343

Fax: 886-3-5935342

Hwa Ya EMC/RF/Safety Lab

Tel: 886-3-3183232

Fax: 886-3-3270892

Email: service.adt@tw.bureauveritas.com

Web Site: www.bureauveritas-adt.com

The address and road map of all our labs can be found in our web site also.

--- END ---