

FCC Test Report

Report No.: RF150828E07

FCC ID: W59XAP1510

Test Model: XAP-1510

Series Model: XWS-2510

Received Date: Aug. 28, 2015

Test Date: Sep. 09 to 11, 2015

Issued Date: Sep. 23, 2015

Applicant: Luxul Wireless

Address: 14203 Minuteman Dr Suite 201 Draper UT 84020 USA

Issued By: Bureau Veritas Consumer Products Services (H.K.) Ltd., Taoyuan Branch
Hsin Chu Laboratory

Lab Address: No. 81-1, Lu Liao Keng, 9th Ling, Wu Lung Tsuen, Chiung Lin Hsiang, Hsin
Chu Hsien 307, Taiwan R.O.C.

Test Location (1): No. 81-1, Lu Liao Keng, 9th Ling, Wu Lung Tsuen, Chiung Lin Hsiang, Hsin
Chu Hsien 307, Taiwan R.O.C.

Test Location (2): No. 49, Ln. 206, Wende Rd., Shangshan Tsuen, Chiung Lin Hsiang, Hsin
Chu Hsien 307, Taiwan R.O.C.

Test Location (3): E-2, No.1, Li Hsin 1st Road, Hsinchu Science Park, Hsinchu City 300,
Taiwan R.O.C.



This report is for your exclusive use. Any copying or replication of this report to or for any other person or entity, or use of our name or trademark, is permitted only with our prior written permission. This report sets forth our findings solely with respect to the test samples identified herein. The results set forth in this report are not indicative or representative of the quality or characteristics of the lot from which a test sample was taken or any similar or identical product unless specifically and expressly noted. Our report includes all of the tests requested by you and the results thereof based upon the information that you provided to us. You have 60 days from date of issuance of this report to notify us of any material error or omission caused by our negligence, provided, however, that such notice shall be in writing and shall specifically address the issue you wish to raise. A failure to raise such issue within the prescribed time shall constitute your unqualified acceptance of the completeness of this report, the tests conducted and the correctness of the report contents. Unless specific mention, the uncertainty of measurement has been explicitly taken into account to declare the compliance or non-compliance to the specification. The report must not be used by the client to claim product certification, approval, or endorsement by TAF or any government agencies.

Table of Contents

Release Control Record	4
1 Certificate of Conformity	5
2 Summary of Test Results	6
2.1 Measurement Uncertainty.....	6
2.2 Modification Record.....	6
3 General Information	7
3.1 General Description of EUT.....	7
3.2 Description of Test Modes.....	10
3.2.1 Test Mode Applicability and Tested Channel Detail.....	11
3.3 Duty Cycle of Test Signal.....	13
3.4 Description of Support Units.....	14
3.4.1 Configuration of System under Test.....	14
3.5 General Description of Applied Standards.....	15
4 Test Types and Results	16
4.1 Radiated Emission and Bandedge Measurement.....	16
4.1.1 Limits of Radiated Emission and Bandedge Measurement.....	16
4.1.2 Test Instruments.....	17
4.1.3 Test Procedures.....	19
4.1.4 Deviation from Test Standard.....	19
4.1.5 Test Setup.....	20
4.1.6 EUT Operating Conditions.....	20
4.1.7 Test Results.....	21
4.2 Conducted Emission Measurement.....	40
4.2.1 Limits of Conducted Emission Measurement.....	40
4.2.2 Test Instruments.....	40
4.2.3 Test Procedures.....	41
4.2.4 Deviation from Test Standard.....	41
4.2.5 Test Setup.....	41
4.2.6 EUT Operating Conditions.....	41
4.2.7 Test Results.....	42
4.3 6dB Bandwidth Measurement.....	44
4.3.1 Limits of 6dB Bandwidth Measurement.....	44
4.3.2 Test Setup.....	44
4.3.3 Test Instruments.....	44
4.3.4 Test Procedure.....	44
4.3.5 Deviation from Test Standard.....	44
4.3.6 EUT Operating Conditions.....	44
4.3.7 Test Result.....	45
4.4 Conducted Output Power Measurement.....	47
4.4.1 Limits of Conducted Output Power Measurement.....	47
4.4.2 Test Setup.....	47
4.4.3 Test Instruments.....	47
4.4.4 Test Procedures.....	47
4.4.5 Deviation from Test Standard.....	47
4.4.6 EUT Operating Conditions.....	47
4.4.7 Test Results.....	48
4.5 Power Spectral Density Measurement.....	50
4.5.1 Limits of Power Spectral Density Measurement.....	50
4.5.2 Test Setup.....	50
4.5.3 Test Instruments.....	50
4.5.4 Test Procedure.....	50
4.5.5 Deviation from Test Standard.....	50
4.5.6 EUT Operating Condition.....	50

4.5.7 Test Results	51
4.6 Conducted Out of Band Emission Measurement.....	54
4.6.1 Limits of Conducted Out of Band Emission Measurement	54
4.6.2 Test Setup.....	54
4.6.3 Test Instruments	54
4.6.4 Test Procedure	54
4.6.5 Deviation from Test Standard	54
4.6.6 EUT Operating Condition	54
4.6.7 Test Results	54
5 Pictures of Test Arrangements.....	67
Appendix – Information on the Testing Laboratories	68



A D T

Release Control Record

Issue No.	Description	Date Issued
RF150828E07	Original release.	Sep. 23, 2015

2 Summary of Test Results

47 CFR FCC Part 15, Subpart C (SECTION 15.247)			
FCC Clause	Test Item	Result	Remarks
15.207	AC Power Conducted Emission	PASS	Meet the requirement of limit. Minimum passing margin is -3.42dB at 0.30234MHz.
15.205 / 15.209 / 15.247(d)	Radiated Emissions and Band Edge Measurement	PASS	Meet the requirement of limit. Minimum passing margin is -0.1dB at 7311.00MHz, 7386.00MHz & 2390.00MHz.
15.247(d)	Antenna Port Emission	PASS	Meet the requirement of limit.
15.247(a)(2)	6dB bandwidth	PASS	Meet the requirement of limit.
15.247(b)	Conducted power	PASS	Meet the requirement of limit.
15.247(e)	Power Spectral Density	PASS	Meet the requirement of limit.
15.203	Antenna Requirement	PASS	Antenna connector is i-pex(MHF) not a standard connector.

NOTE: 1. The EUT was operating in 2.4 ~ 2.4835GHz, 5.15~5.25GHz and 5.725~5.85GHz frequencies band. This report was recorded the RF parameters including 2.4 ~ 2.4835GHz. For the 5.15~5.25GHz and 5.725~5.85GHz RF parameters was recorded in another test report.

2.1 Measurement Uncertainty

Where relevant, the following measurement uncertainty levels have been estimated for tests performed on the EUT as specified in CISPR 16-4-2:

Measurement	Frequency	Expanded Uncertainty (k=2) (±)
Conducted Emissions at mains ports	150kHz ~ 30MHz	2.86 dB
Radiated Emissions up to 1 GHz	30MHz ~ 1GHz	5.43 dB
Radiated Emissions above 1 GHz	1GHz ~ 6GHz	3.65 dB
	6GHz ~ 18GHz	3.88 dB
	18GHz ~ 40GHz	4.11 dB

2.2 Modification Record

There were no modifications required for compliance.

3 General Information

3.1 General Description of EUT

Product	High Power AC1900 Dual-Band Wireless AP
Brand	LUXUL
Test Model	XAP-1510
Series Model	XWS-2510
Status of EUT	ENGINEERING SAMPLE
Power Supply Rating	48Vdc from POE
Modulation Type	CCK, DQPSK, DBPSK for DSSS 64QAM, 16QAM, QPSK, BPSK for OFDM 256QAM for OFDM in 11ac mode and VHT (20/40) mode in 2.4GHz
Modulation Technology	DSSS, OFDM
Transfer Rate	802.11b: up to 11Mbps 802.11a: up to 54Mbps 802.11n: up to 450Mbps 802.11ac: up to 1300Mbps
Operating Frequency	For 15.247: 2.412 ~ 2.462GHz For 15.407: 5.18 ~ 5.24GHz, 5.745 ~ 5.825GHz
Number of Channel	For 2.4GHz: 11 for 802.11b, 802.11g, 802.11n (HT20), VHT20 7 for 802.11n (HT40), VHT40 For 5GHz: 9 for 802.11a, 802.11n (HT20), 802.11ac (VHT20) 4 for 802.11n (HT40), 802.11ac (VHT40) 2 for 802.11ac (VHT80)
Output Power	For 2.4GHz: CDD Mode: 802.11b: 605.624mW 802.11g: 790.746mW VHT20: 751.503mW VHT40: 229.57mW Beamforming Mode: VHT20: 547.733mW VHT40: 191.375mW For 5GHz: CDD Mode: 802.11a: 447.865mW 802.11ac (VHT20): 392.124W 802.11ac (VHT40): 611.716mW 802.11ac (VHT80): 195.614mW Beamforming Mode: 802.11ac (VHT20): 378.038mW 802.11ac (VHT40): 388.373mW 802.11ac (VHT80): 130.735mW
Antenna Type	Refer to Note
Antenna Connector	Refer to Note
Accessory Device	POE x 1
Data Cable Supplied	RJ45 cable (Unshielded, 0.9m) x 1

Note:

1. The EUT has two model names, which are identical to each other in all aspects except for the following table:

Brand	Model No.	Difference
LUXUL	XAP-1510	With one XAP-1510 in gift box.
	XWS-2510	With two XAP-1510 in gift box.

From the above models, model: XAP-1510 was selected as representative model for the test and its data was recorded in this report.

2. 2.4GHz and 5GHz technology can transmit at same time.

3. The antennas provided to the EUT, please refer to the following table:

Transmitter Circuit	Brand	Model	Antenna Gain (dBi)	Frequency range (GHz to GHz)	Antenna Type	Connector Type
Chain (0)	NA	29020222	2.7	2.4-2.4835	PIFA	i-pex(MHF)
			5.2	5.15-5.85		
Chain (1)	NA	29020223	2.7	2.4-2.4835	PIFA	i-pex(MHF)
			5.2	5.15-5.85		
Chain (2)	NA	29020224	2.7	2.4-2.4835	PIFA	i-pex(MHF)
			5.2	5.15-5.85		

4. The EUT must be supplied with an POE as following table:

Brand Name	Model No.	Spec.
Great power	GRT-480125A	Input: 100-240V, 50/60Hz Output: 48V, 1250mA

5. The EUT incorporates a MIMO function.

2.4GHz Band			
MODULATION MODE	DATA RATE (MCS)	TX & RX CONFIGURATION	
802.11b	1 ~ 11Mbps	3TX	3RX
802.11g	6 ~ 54Mbps	3TX	3RX
802.11n (HT20)	MCS 0~7	3TX	3RX
	MCS 8~15	3TX	3RX
	MCS 16~23	3TX	3RX
802.11n (HT40)	MCS 0~7	3TX	3RX
	MCS 8~15	3TX	3RX
	MCS 16~23	3TX	3RX
VHT20	MCS 0~8, Nss=1	3TX	3RX
	MCS 0~8, Nss=2	3TX	3RX
	MCS 0~9, Nss=3	3TX	3RX
VHT40	MCS 0~9, Nss=1	3TX	3RX
	MCS 0~9, Nss=2	3TX	3RX
	MCS 0~9, Nss=3	3TX	3RX
5GHz Band			
MODULATION MODE	DATA RATE (MCS)	TX & RX CONFIGURATION	
802.11a	6 ~ 54Mbps	3TX	3RX
802.11n (HT20)	MCS 0~7	3TX	3RX
	MCS 8~15	3TX	3RX
	MCS 16~23	3TX	3RX
802.11n (HT40)	MCS 0~7	3TX	3RX
	MCS 8~15	3TX	3RX
	MCS 16~23	3TX	3RX
802.11ac (VHT20)	MCS 0~8, Nss=1	3TX	3RX
	MCS 0~8, Nss=2	3TX	3RX
	MCS 0~9, Nss=3	3TX	3RX
802.11ac (VHT40)	MCS 0~9, Nss=1	3TX	3RX
	MCS 0~9, Nss=2	3TX	3RX
	MCS 0~9, Nss=3	3TX	3RX
802.11ac (VHT80)	MCS 0~9, Nss=1	3TX	3RX
	MCS 0~9, Nss=2	3TX	3RX
	MCS 0~9, Nss=3	3TX	3RX

Note:

1. The modulation and bandwidth are similar for 802.11n mode for 20MHz (40MHz) and 802.11ac mode for 20MHz (40MHz), therefore investigated worst case to representative mode in test report. (Final test mode refer section 3.2.1)

2. All of modulation mode support beamforming function except (802.11b/g/a) modulation mode.

6. The above EUT information is declared by manufacturer and for more detailed features description, please refer to the manufacturer's specifications or user's manual.

3.2 Description of Test Modes

11 channels are provided for 802.11b, 802.11g, 802.11n (HT20) and VHT20:

Channel	Frequency	Channel	Frequency
1	2412MHz	7	2442MHz
2	2417MHz	8	2447MHz
3	2422MHz	9	2452MHz
4	2427MHz	10	2457MHz
5	2432MHz	11	2462MHz
6	2437MHz		

7 channels are provided for 802.11n (HT40) and VHT40:

Channel	Frequency	Channel	Frequency
3	2422MHz	7	2442MHz
4	2427MHz	8	2447MHz
5	2432MHz	9	2452MHz
6	2437MHz		

3.2.1 Test Mode Applicability and Tested Channel Detail

EUT CONFIGURE MODE	APPLICABLE TO				DESCRIPTION
	RE \geq 1G	RE<1G	PLC	APCM	
-	√	√	√	√	-

Where RE \geq 1G: Radiated Emission above 1GHz & Bandedge Measurement
 RE<1G: Radiated Emission below 1GHz
 PLC: Power Line Conducted Emission
 APCM: Antenna Port Conducted Measurement

NOTE: The EUT had been pre-tested on the positioned of each 2 axis. The worst case was found when positioned on Y-plane.

Radiated Emission Test (Above 1GHz):

- Pre-Scan has been conducted to determine the worst-case mode from all possible combinations between available modulations, data rates and antenna ports (if EUT with antenna diversity architecture).
- Following channel(s) was (were) selected for the final test as listed below.

CDD Mode					
MODE	AVAILABLE CHANNEL	TESTED CHANNEL	MODULATION TECHNOLOGY	MODULATION TYPE	DATA RATE (Mbps)
802.11b	1 to 11	1, 6, 11	DSSS	DBPSK	1
802.11g	1 to 11	1, 6, 11	OFDM	BPSK	6
VHT20	1 to 11	1, 6, 11	OFDM	BPSK	6.5
VHT40	3 to 9	3, 6, 9	OFDM	BPSK	13.5
Beamforming Mode					
MODE	AVAILABLE CHANNEL	TESTED CHANNEL	MODULATION TECHNOLOGY	MODULATION TYPE	DATA RATE (Mbps)
VHT20	1 to 11	1, 6, 11	OFDM	BPSK	6.5
VHT40	3 to 9	3, 6, 9	OFDM	BPSK	13.5

Radiated Emission Test (Below 1GHz):

- Pre-Scan has been conducted to determine the worst-case mode from all possible combinations between available modulations, data rates and antenna ports (if EUT with antenna diversity architecture).
- Following channel(s) was (were) selected for the final test as listed below.

CDD Mode					
MODE	AVAILABLE CHANNEL	TESTED CHANNEL	MODULATION TECHNOLOGY	MODULATION TYPE	DATA RATE (Mbps)
802.11g	1 to 11	6	OFDM	BPSK	6

Power Line Conducted Emission Test:

- Pre-Scan has been conducted to determine the worst-case mode from all possible combinations between available modulations, data rates and antenna ports (if EUT with antenna diversity architecture).
- Following channel(s) was (were) selected for the final test as listed below.

CDD Mode					
MODE	AVAILABLE CHANNEL	TESTED CHANNEL	MODULATION TECHNOLOGY	MODULATION TYPE	DATA RATE (Mbps)
802.11g	1 to 11	6	OFDM	BPSK	6

Antenna Port Conducted Measurement:

- This item includes all test value of each mode, but only includes spectrum plot of worst value of each mode.
- Pre-Scan has been conducted to determine the worst-case mode from all possible combinations between available modulations, data rates and antenna ports (if EUT with antenna diversity architecture).
- Following channel(s) was (were) selected for the final test as listed below.

CDD Mode					
For Conducted Output Power / Power Spectral Density / 6dB Bandwidth Measurement					
MODE	AVAILABLE CHANNEL	TESTED CHANNEL	MODULATION TECHNOLOGY	MODULATION TYPE	DATA RATE (Mbps)
802.11b	1 to 11	1, 6, 11	DSSS	DBPSK	1
802.11g	1 to 11	1, 6, 11	OFDM	BPSK	6
VHT20	1 to 11	1, 6, 11	OFDM	BPSK	6.5
VHT40	3 to 9	3, 6, 9	OFDM	BPSK	13.5
Beamforming Mode					
For Conducted Output Power Measurement					
MODE	AVAILABLE CHANNEL	TESTED CHANNEL	MODULATION TECHNOLOGY	MODULATION TYPE	DATA RATE (Mbps)
VHT20	1 to 11	1, 6, 11	OFDM	BPSK	6.5
VHT40	3 to 9	3, 6, 9	OFDM	BPSK	13.5

Test Condition:

APPLICABLE TO	ENVIRONMENTAL CONDITIONS	INPUT POWER	TESTED BY
RE\geq1G	26deg. C, 67%RH	120Vac, 60Hz	Andy Ho
RE$<$1G	23deg. C, 69%RH	120Vac, 60Hz	Robert Cheng
PLC	26deg. C, 62%RH	120Vac, 60Hz	Timmy Hu
APCM	25deg. C, 60%RH	120Vac, 60Hz	Anderson Chen

3.3 Duty Cycle of Test Signal

Duty cycle of test signal is $\geq 98\%$, duty factor is not required.

802.11b: Duty cycle = 12.41 ms/12.43 ms = 0.998

802.11g: Duty cycle = 2.064 ms/2.087 ms = 0.989

VHT20: Duty cycle = 1.92 ms/1.942 ms = 0.989

VHT40: Duty cycle = 0.948 ms/0.966 ms = 0.981

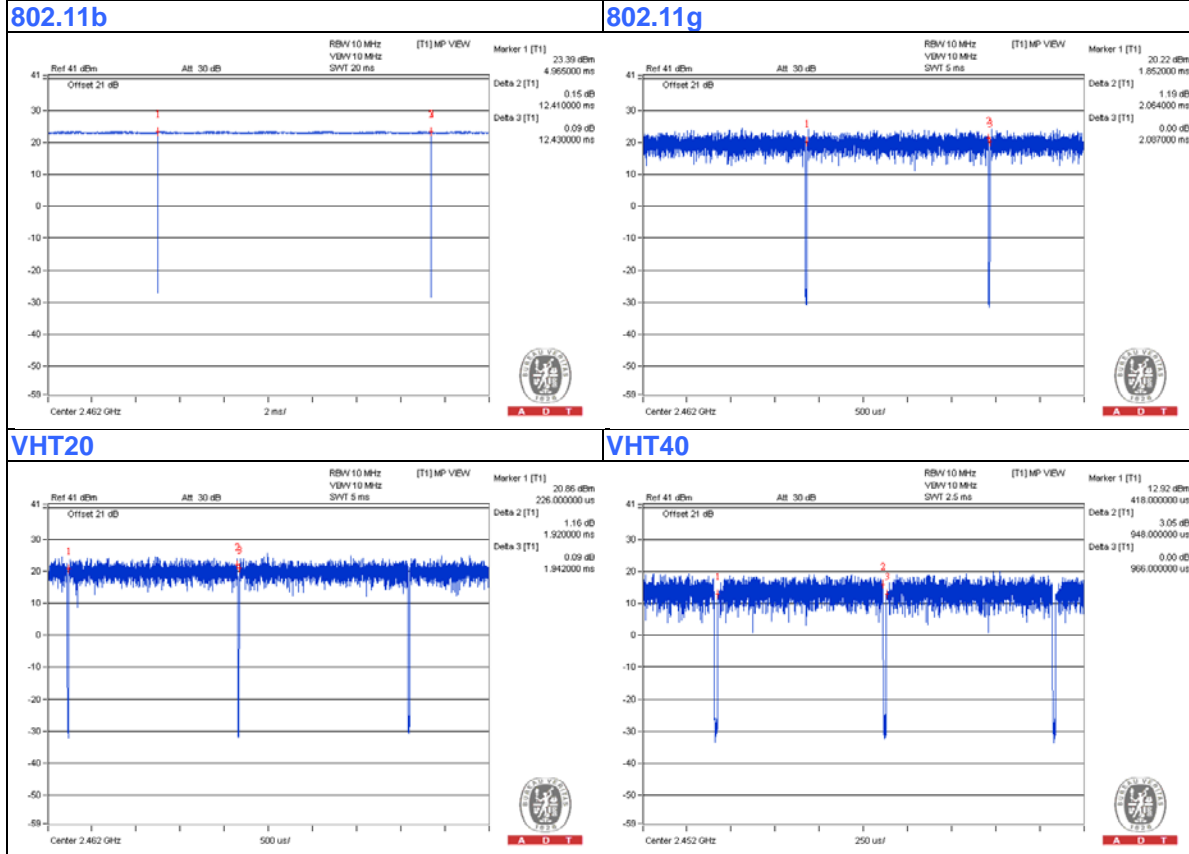

3.4 Description of Support Units

The EUT has been tested as an independent unit together with other necessary accessories or support units. The following support units or accessories were used to form a representative test configuration during the tests.

ID	Product	Brand	Model No.	Serial No.	FCC ID	Remarks
A.	Notebook Computer	DELL	E5430	HYV4VY1	FCC DoC	Provided by Lab
B.	HUB	ZyXEL	ES-116P	S060H02000215	FCC DoC	Provided by Lab

Note:

1. All power cords of the above support units are non-shielded (1.8m).

ID	Descriptions	Qty.	Length (m)	Shielding (Yes/No)	Cores (Qty.)	Remarks
1.	RJ45	1	0.9	No	0	Supplied by Client
2.	RJ45	1	10	No	0	Provided by Lab
3.	RJ45	1	10	No	0	Provided by Lab
4.	AC	1	1.8	No	0	Supplied by Client

3.4.1 Configuration of System under Test

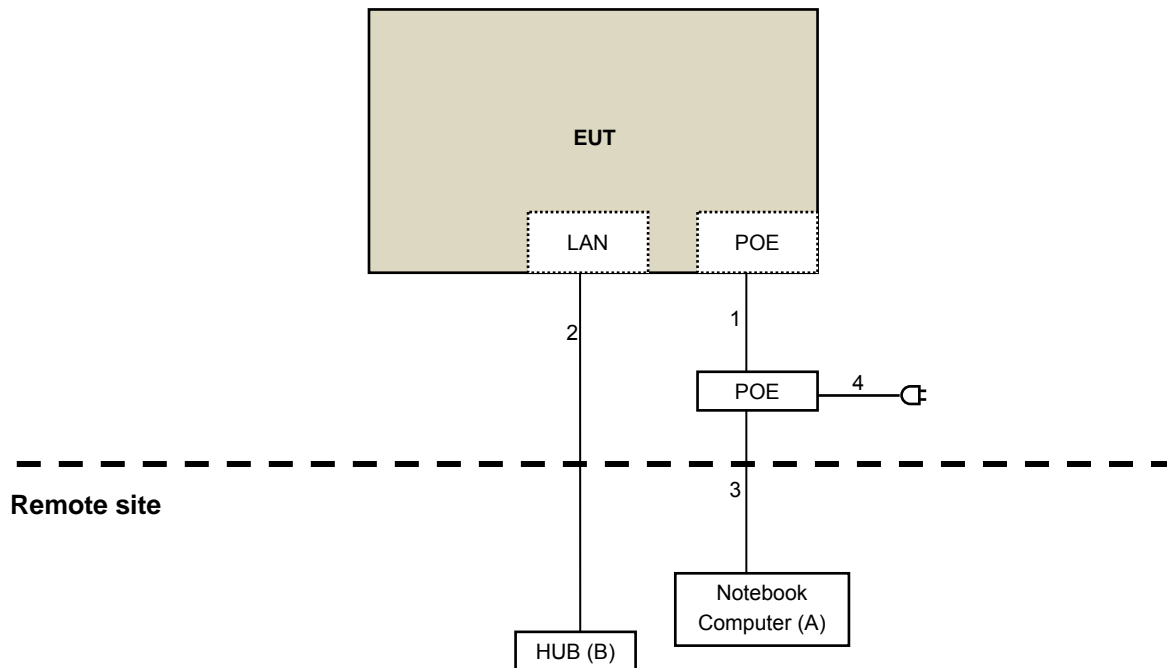

3.5 General Description of Applied Standards

The EUT is a RF Product. According to the specifications of the manufacturer, it must comply with the requirements of the following standards:

FCC Part 15, Subpart C (15.247)

558074 D01 DTS Meas Guidance v03r03

662911 D01 Multiple Transmitter Output v02r01

ANSI C63.10-2013

All test items have been performed and recorded as per the above standards.

NOTE: The EUT has been verified to comply with the requirements of FCC Part 15, Subpart B, Class B (DoC). The test report has been issued separately.

4 Test Types and Results

4.1 Radiated Emission and Bandedge Measurement

4.1.1 Limits of Radiated Emission and Bandedge Measurement

Radiated emissions which fall in the restricted bands must comply with the radiated emission limits specified as below table. Other emissions shall be at least 30dB below the highest level of the desired power:

Frequencies (MHz)	Field Strength (microvolts/meter)	Measurement Distance (meters)
0.009 ~ 0.490	2400/F(kHz)	300
0.490 ~ 1.705	24000/F(kHz)	30
1.705 ~ 30.0	30	30
30 ~ 88	100	3
88 ~ 216	150	3
216 ~ 960	200	3
Above 960	500	3

NOTE:

1. The lower limit shall apply at the transition frequencies.
2. Emission level (dBuV/m) = 20 log Emission level (uV/m).
3. For frequencies above 1000MHz, the field strength limits are based on average detector, however, the peak field strength of any emission shall not exceed the maximum permitted average limits, specified above by more than 20dB under any condition of modulation.

4.1.2 Test Instruments

For below 1GHz:

DESCRIPTION & MANUFACTURER	MODEL NO.	SERIAL NO.	CALIBRATED DATE	CALIBRATED UNTIL
Test Receiver Agilent	N9038A	MY51210202	Dec. 12, 2014	Dec. 11, 2015
Pre-Amplifier Mini-Circuits	ZFL-1000VH2 B	AMP-ZFL-04	Nov. 12, 2014	Nov. 11, 2015
Trilog Broadband Antenna SCHWARZBECK	VULB 9168	9168-361	Feb. 09, 2015	Feb. 08, 2016
RF Cable	8D-FB	CHHCAB-001-1	Oct. 05, 2014	Oct. 04, 2015
		CHHCAB-001-2		
	RF-141	CHHCAB-004	Oct. 05, 2014	Oct. 04, 2015
Software	ADT_Radiated_V8.7.07	NA	NA	NA
Antenna Tower & Turn Table CT	NA	NA	NA	NA

Note:

1. The calibration interval of the above test instruments is 12 months and the calibrations are traceable to NML/ROC and NIST/USA.
2. The test was performed in 966 Chamber No. H.
3. The FCC Site Registration No. is 797305.
4. The CANADA Site Registration No. is IC 7450H-3.
5. Tested Date: Sep. 10, 2015

For other test items:

DESCRIPTION & MANUFACTURER	MODEL NO.	SERIAL NO.	CALIBRATED DATE	CALIBRATED UNTIL
Test Receiver Agilent	N9038A	MY51210105	July 24, 2015	July 23, 2016
Horn_Antenna AISI	AIH.8018	000032009111 0	Feb. 09, 2015	Feb. 08, 2016
Pre-Amplifier Agilent	8449B	3008A02578	June 23, 2015	June 22, 2016
RF Cable	NA	131205 131216 131217 SNMY23684/ 4	Jan. 16, 2015	Jan. 15, 2016
Spectrum Analyzer R&S	FSV40	100964	June 26, 2015	June 25, 2016
Pre-Amplifier SPACEK LABS	SLKKa-48-6	9K16	Dec. 12, 2014	Dec. 11, 2015
Horn_Antenna SCHWARZBECK	BBHA 9170	9170-424	Feb. 05, 2015	Feb. 04, 2016
RF Cable	NA	329751/4 RF104-204	Dec. 11, 2014	Dec. 10, 2015
Software	ADT_Radiated _V8.7.07	NA	NA	NA
Antenna Tower & Turn Table CT	NA	NA	NA	NA
Power Meter Anritsu	ML2495A	1014008	Apr. 28, 2015	Apr. 27, 2016
Power Sensor Anritsu	MA2411B	0917122	Apr. 28, 2015	Apr. 27, 2016
Spectrum Analyzer R&S	FSP 40	100060	May 08, 2015	May 07, 2016

Note:

1. The calibration interval of the above test instruments is 12 months and the calibrations are traceable to NML/ROC and NIST/USA.
2. The test was performed in 966 Chamber No. G.
3. The FCC Site Registration No. is 966073.
4. The VCCI Site Registration No. is G-137.
5. The CANADA Site Registration No. is IC 7450H-2.
6. Tested Date: Sep. 09 to 11, 2015

4.1.3 Test Procedures

- a. The EUT was placed on the top of a rotating table 0.8 meters (for below 1GHz) / 1.5 meters (for above 1GHz) above the ground at 3 meter chamber room for test. The table was rotated 360 degrees to determine the position of the highest radiation.
- b. The EUT was set 3 meters away from the interference-receiving antenna, which was mounted on the top of a variable-height antenna tower.
- c. The height of antenna is varied from one meter to four meters above the ground to determine the maximum value of the field strength. Both horizontal and vertical polarizations of the antenna are set to make the measurement.
- d. For each suspected emission, the EUT was arranged to its worst case and then the antenna was tuned to heights from 1 meter to 4 meters and the rotatable table was turned from 0 degrees to 360 degrees to find the maximum reading.
- e. The test-receiver system was set to quasi-peak detect function and specified bandwidth with maximum hold mode when the test frequency is below 1 GHz.
- f. The test-receiver system was set to peak and average detect function and specified bandwidth with maximum hold mode when the test frequency is above 1 GHz. If the peak reading value also meets average limit, measurement with the average detector is unnecessary.

Note:

1. The resolution bandwidth and video bandwidth of test receiver/spectrum analyzer is 120kHz for Quasi-peak detection (QP) at frequency below 1GHz.
2. The resolution bandwidth of test receiver/spectrum analyzer is 1 MHz and the video bandwidth is 3 MHz for Peak detection (PK) at frequency above 1GHz.
3. The resolution bandwidth of test receiver/spectrum analyzer is 1MHz and the video bandwidth is 3MHz for RMS Average (Duty cycle < 98%) for Average detection (AV) at frequency above 1GHz, then the measurement results was added to a correction factor ($10 \log(1/\text{duty cycle})$).
4. The resolution bandwidth of test receiver/spectrum analyzer is 1MHz and the video bandwidth is 10Hz (Duty cycle \geq 98%) for Average detection (AV) at frequency above 1GHz.
5. All modes of operation were investigated and the worst-case emissions are reported.

4.1.4 Deviation from Test Standard

No deviation.

4.1.5 Test Setup

<Frequency Range below 1GHz>

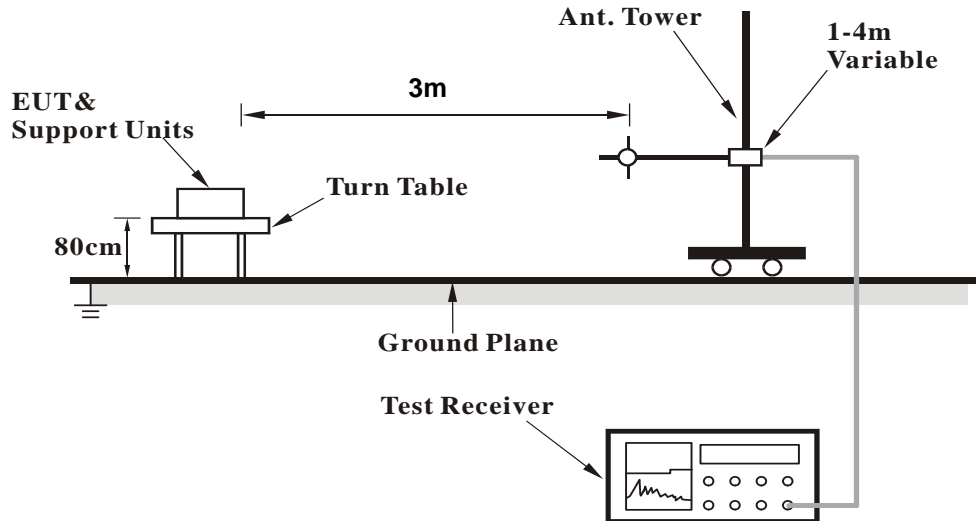

<Frequency Range above 1GHz>

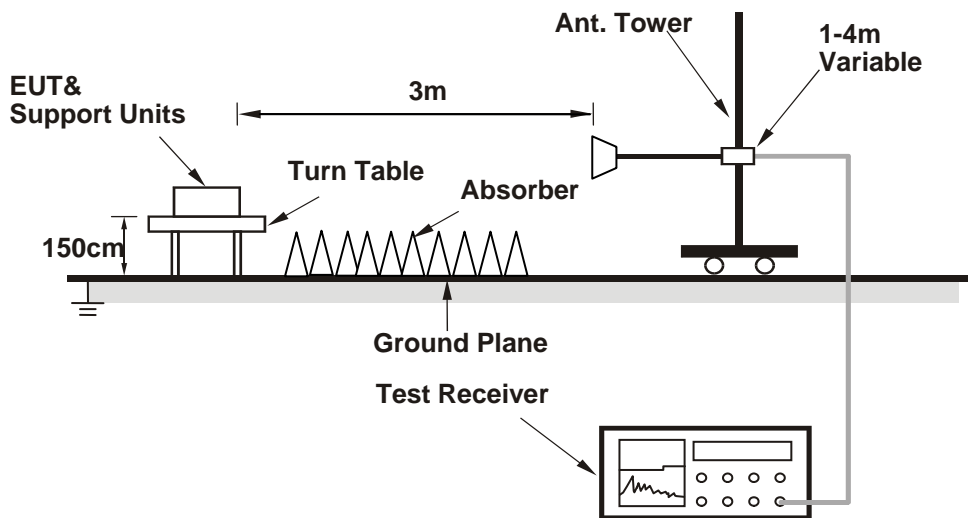

For the actual test configuration, please refer to the attached file (Test Setup Photo).

4.1.6 EUT Operating Conditions

1. Connect the EUT with the support unit A (Notebook Computer) which is placed on remote site.
2. Controlling software (MTool_2.0.1.1.exe) has been activated to set the EUT on specific status.

4.1.7 Test Results

Above 1GHz Data:

CDD Mode

802.11b

CHANNEL	TX Channel 1	DETECTOR FUNCTION	Peak (PK)
FREQUENCY RANGE	1GHz ~ 25GHz		Average (AV)

ANTENNA POLARITY & TEST DISTANCE: HORIZONTAL AT 3 M

NO.	FREQ. (MHz)	EMISSION LEVEL (dBuV/m)	LIMIT (dBuV/m)	MARGIN (dB)	ANTENNA HEIGHT (m)	TABLE ANGLE (Degree)	RAW VALUE (dBuV)	CORRECTION FACTOR (dB/m)
1	2390.00	55.4 PK	74.0	-18.6	1.74 H	70	56.83	-1.43
2	2390.00	50.1 AV	54.0	-3.9	1.74 H	70	51.53	-1.43
3	*2412.00	112.7 PK			1.74 H	70	114.08	-1.38
4	*2412.00	109.1 AV			1.74 H	70	110.48	-1.38
5	4824.00	43.9 PK	74.0	-30.1	1.75 H	35	36.81	7.09
6	4824.00	38.3 AV	54.0	-15.7	1.75 H	35	31.21	7.09

ANTENNA POLARITY & TEST DISTANCE: VERTICAL AT 3 M

NO.	FREQ. (MHz)	EMISSION LEVEL (dBuV/m)	LIMIT (dBuV/m)	MARGIN (dB)	ANTENNA HEIGHT (m)	TABLE ANGLE (Degree)	RAW VALUE (dBuV)	CORRECTION FACTOR (dB/m)
1	2390.00	57.9 PK	74.0	-16.1	1.50 V	56	59.33	-1.43
2	2390.00	52.2 AV	54.0	-1.8	1.50 V	56	53.63	-1.43
3	*2412.00	114.2 PK			1.50 V	56	115.58	-1.38
4	*2412.00	111.3 AV			1.50 V	56	112.68	-1.38
5	4824.00	51.3 PK	74.0	-22.7	1.56 V	341	44.21	7.09
6	4824.00	47.6 AV	54.0	-6.4	1.56 V	341	40.51	7.09

REMARKS:

1. Emission Level(dBuV/m) = Raw Value(dBuV) + Correction Factor(dB/m)
2. Correction Factor(dB/m) = Antenna Factor(dB/m) + Cable Factor(dB) – Pre-Amplifier Factor(dB)
3. The other emission levels were very low against the limit.
4. Margin value = Emission Level – Limit value
5. " * ": Fundamental frequency.

CHANNEL	TX Channel 6	DETECTOR FUNCTION	Peak (PK)
FREQUENCY RANGE	1GHz ~ 25GHz		Average (AV)

ANTENNA POLARITY & TEST DISTANCE: HORIZONTAL AT 3 M

NO.	FREQ. (MHz)	EMISSION LEVEL (dBuV/m)	LIMIT (dBuV/m)	MARGIN (dB)	ANTENNA HEIGHT (m)	TABLE ANGLE (Degree)	RAW VALUE (dBuV)	CORRECTION FACTOR (dB/m)
1	2390.00	46.2 PK	74.0	-27.8	1.45 H	76	47.63	-1.43
2	2390.00	33.8 AV	54.0	-20.2	1.45 H	76	35.23	-1.43
3	*2437.00	109.2 PK			1.45 H	76	110.52	-1.32
4	*2437.00	106.7 AV			1.45 H	76	108.02	-1.32
5	4874.00	44.0 PK	74.0	-30.0	1.73 H	44	36.75	7.25
6	4874.00	38.4 AV	54.0	-15.6	1.73 H	44	31.15	7.25
7	7311.00	58.2 PK	74.0	-15.8	1.91 H	87	43.75	14.45
8	7311.00	53.9 AV	54.0	-0.1	1.91 H	87	39.45	14.45

ANTENNA POLARITY & TEST DISTANCE: VERTICAL AT 3 M

NO.	FREQ. (MHz)	EMISSION LEVEL (dBuV/m)	LIMIT (dBuV/m)	MARGIN (dB)	ANTENNA HEIGHT (m)	TABLE ANGLE (Degree)	RAW VALUE (dBuV)	CORRECTION FACTOR (dB/m)
1	2390.00	47.8 PK	74.0	-26.2	1.78 V	360	49.23	-1.43
2	2390.00	34.9 AV	54.0	-19.1	1.78 V	360	36.33	-1.43
3	*2437.00	112.6 PK			1.78 V	360	113.92	-1.32
4	*2437.00	109.2 AV			1.78 V	360	110.52	-1.32
5	4874.00	45.4 PK	74.0	-28.6	1.44 V	314	38.15	7.25
6	4874.00	40.7 AV	54.0	-13.3	1.44 V	314	33.45	7.25
7	7311.00	54.4 PK	74.0	-19.6	2.29 V	20	39.95	14.45
8	7311.00	49.4 AV	54.0	-4.6	2.29 V	20	34.95	14.45

REMARKS:

1. Emission Level(dBuV/m) = Raw Value(dBuV) + Correction Factor(dB/m)
2. Correction Factor(dB/m) = Antenna Factor(dB/m) + Cable Factor(dB) – Pre-Amplifier Factor(dB)
3. The other emission levels were very low against the limit.
4. Margin value = Emission Level – Limit value
5. " * ": Fundamental frequency.

CHANNEL	TX Channel 11	DETECTOR FUNCTION	Peak (PK)
FREQUENCY RANGE	1GHz ~ 25GHz		Average (AV)

ANTENNA POLARITY & TEST DISTANCE: HORIZONTAL AT 3 M

NO.	FREQ. (MHz)	EMISSION LEVEL (dBuV/m)	LIMIT (dBuV/m)	MARGIN (dB)	ANTENNA HEIGHT (m)	TABLE ANGLE (Degree)	RAW VALUE (dBuV)	CORRECTION FACTOR (dB/m)
1	*2462.00	108.4 PK			2.15 H	71	109.66	-1.26
2	*2462.00	105.4 AV			2.15 H	71	106.66	-1.26
3	2483.50	50.9 PK	74.0	-23.1	2.15 H	71	52.11	-1.21
4	2483.50	42.0 AV	54.0	-12.0	2.15 H	71	43.21	-1.21
5	4924.00	43.6 PK	74.0	-30.4	1.62 H	112	36.15	7.45
6	4924.00	38.9 AV	54.0	-15.1	1.62 H	112	31.45	7.45
7	7386.00	58.0 PK	74.0	-16.0	1.02 H	68	43.48	14.52
8	7386.00	53.9 AV	54.0	-0.1	1.02 H	68	39.38	14.52

ANTENNA POLARITY & TEST DISTANCE: VERTICAL AT 3 M

NO.	FREQ. (MHz)	EMISSION LEVEL (dBuV/m)	LIMIT (dBuV/m)	MARGIN (dB)	ANTENNA HEIGHT (m)	TABLE ANGLE (Degree)	RAW VALUE (dBuV)	CORRECTION FACTOR (dB/m)
1	*2462.00	112.4 PK			2.10 V	16	113.66	-1.26
2	*2462.00	109.3 AV			2.10 V	16	110.56	-1.26
3	2483.50	54.2 PK	74.0	-19.8	2.10 V	16	55.41	-1.21
4	2483.50	46.1 AV	54.0	-7.9	2.10 V	16	47.31	-1.21
5	4924.00	49.8 PK	74.0	-24.2	1.50 V	340	42.35	7.45
6	4924.00	45.4 AV	54.0	-8.6	1.50 V	340	37.95	7.45
7	7386.00	56.9 PK	74.0	-17.1	2.22 V	217	42.38	14.52
8	7386.00	51.8 AV	54.0	-2.2	2.22 V	217	37.28	14.52

REMARKS:

1. Emission Level(dBuV/m) = Raw Value(dBuV) + Correction Factor(dB/m)
2. Correction Factor(dB/m) = Antenna Factor(dB/m) + Cable Factor(dB) – Pre-Amplifier Factor(dB)
3. The other emission levels were very low against the limit.
4. Margin value = Emission Level – Limit value
5. " * ": Fundamental frequency.

802.11g

CHANNEL	TX Channel 1	DETECTOR FUNCTION	Peak (PK)
FREQUENCY RANGE	1GHz ~ 25GHz		Average (AV)

ANTENNA POLARITY & TEST DISTANCE: HORIZONTAL AT 3 M								
NO.	FREQ. (MHz)	EMISSION LEVEL (dBuV/m)	LIMIT (dBuV/m)	MARGIN (dB)	ANTENNA HEIGHT (m)	TABLE ANGLE (Degree)	RAW VALUE (dBuV)	CORRECTION FACTOR (dB/m)
1	2390.00	63.7 PK	74.0	-10.3	1.33 H	300	65.13	-1.43
2	2390.00	51.3 AV	54.0	-2.7	1.33 H	300	52.73	-1.43
3	*2412.00	109.8 PK			1.33 H	300	111.18	-1.38
4	*2412.00	100.1 AV			1.33 H	300	101.48	-1.38
5	4824.00	41.9 PK	74.0	-32.1	1.22 H	147	34.81	7.09
6	4824.00	29.8 AV	54.0	-24.2	1.22 H	147	22.71	7.09
ANTENNA POLARITY & TEST DISTANCE: VERTICAL AT 3 M								
NO.	FREQ. (MHz)	EMISSION LEVEL (dBuV/m)	LIMIT (dBuV/m)	MARGIN (dB)	ANTENNA HEIGHT (m)	TABLE ANGLE (Degree)	RAW VALUE (dBuV)	CORRECTION FACTOR (dB/m)
1	2390.00	73.4 PK	74.0	-0.6	1.49 V	347	74.83	-1.43
2	2390.00	53.2 AV	54.0	-0.8	1.49 V	347	54.63	-1.43
3	*2412.00	111.6 PK			1.66 V	320	112.98	-1.38
4	*2412.00	103.0 AV			1.66 V	320	104.38	-1.38
5	4824.00	43.2 PK	74.0	-30.8	1.22 V	224	36.11	7.09
6	4824.00	31.5 AV	54.0	-22.5	1.22 V	224	24.41	7.09

REMARKS:

1. Emission Level(dBuV/m) = Raw Value(dBuV) + Correction Factor(dB/m)
2. Correction Factor(dB/m) = Antenna Factor(dB/m) + Cable Factor(dB) – Pre-Amplifier Factor(dB)
3. The other emission levels were very low against the limit.
4. Margin value = Emission Level – Limit value
5. " * ": Fundamental frequency.

CHANNEL	TX Channel 6	DETECTOR FUNCTION	Peak (PK)
FREQUENCY RANGE	1GHz ~ 25GHz		Average (AV)

ANTENNA POLARITY & TEST DISTANCE: HORIZONTAL AT 3 M

NO.	FREQ. (MHz)	EMISSION LEVEL (dBuV/m)	LIMIT (dBuV/m)	MARGIN (dB)	ANTENNA HEIGHT (m)	TABLE ANGLE (Degree)	RAW VALUE (dBuV)	CORRECTION FACTOR (dB/m)
1	2390.00	61.2 PK	74.0	-12.8	1.46 H	301	62.63	-1.43
2	2390.00	47.8 AV	54.0	-6.2	1.46 H	301	49.23	-1.43
3	*2437.00	116.2 PK			1.46 H	301	117.52	-1.32
4	*2437.00	105.7 AV			1.46 H	301	107.02	-1.32
5	2483.50	62.1 PK	74.0	-11.9	1.46 H	301	63.31	-1.21
6	2483.50	48.7 AV	54.0	-5.3	1.46 H	301	49.91	-1.21
7	4874.00	43.5 PK	74.0	-30.5	1.91 H	320	36.25	7.25
8	4874.00	32.2 AV	54.0	-21.8	1.91 H	320	24.95	7.25
9	7311.00	62.7 PK	74.0	-11.3	1.62 H	89	48.25	14.45
10	7311.00	48.0 AV	54.0	-6.0	1.62 H	89	33.55	14.45

ANTENNA POLARITY & TEST DISTANCE: VERTICAL AT 3 M

NO.	FREQ. (MHz)	EMISSION LEVEL (dBuV/m)	LIMIT (dBuV/m)	MARGIN (dB)	ANTENNA HEIGHT (m)	TABLE ANGLE (Degree)	RAW VALUE (dBuV)	CORRECTION FACTOR (dB/m)
1	2390.00	72.0 PK	74.0	-2.0	1.42 V	351	73.43	-1.43
2	2390.00	53.2 AV	54.0	-0.8	1.42 V	351	54.63	-1.43
3	*2437.00	118.6 PK			1.42 V	351	119.92	-1.32
4	*2437.00	108.4 AV			1.42 V	351	109.72	-1.32
5	2483.50	69.7 PK	74.0	-4.3	1.82 V	331	70.91	-1.21
6	2483.50	52.0 AV	54.0	-2.0	1.82 V	331	53.21	-1.21
7	4874.00	47.3 PK	74.0	-26.7	1.75 V	342	40.05	7.25
8	4874.00	35.2 AV	54.0	-18.8	1.75 V	342	27.95	7.25
9	7311.00	57.9 PK	74.0	-16.1	2.21 V	344	43.45	14.45
10	7311.00	46.4 AV	54.0	-7.6	2.21 V	344	31.95	14.45

REMARKS:

1. Emission Level(dBuV/m) = Raw Value(dBuV) + Correction Factor(dB/m)
2. Correction Factor(dB/m) = Antenna Factor(dB/m) + Cable Factor(dB) – Pre-Amplifier Factor(dB)
3. The other emission levels were very low against the limit.
4. Margin value = Emission Level – Limit value
5. " * ": Fundamental frequency.

CHANNEL	TX Channel 11	DETECTOR FUNCTION	Peak (PK)
FREQUENCY RANGE	1GHz ~ 25GHz		Average (AV)

ANTENNA POLARITY & TEST DISTANCE: HORIZONTAL AT 3 M

NO.	FREQ. (MHz)	EMISSION LEVEL (dBuV/m)	LIMIT (dBuV/m)	MARGIN (dB)	ANTENNA HEIGHT (m)	TABLE ANGLE (Degree)	RAW VALUE (dBuV)	CORRECTION FACTOR (dB/m)
1	*2462.00	108.2 PK			1.53 H	311	109.46	-1.26
2	*2462.00	98.6 AV			1.53 H	311	99.86	-1.26
3	2483.50	69.2 PK	74.0	-4.8	1.53 H	311	70.41	-1.21
4	2483.50	50.3 AV	54.0	-3.7	1.53 H	311	51.51	-1.21
5	4924.00	42.8 PK	74.0	-31.2	1.53 H	190	35.35	7.45
6	4924.00	31.1 AV	54.0	-22.9	1.53 H	190	23.65	7.45
7	7386.00	56.3 PK	74.0	-17.7	1.19 H	44	41.78	14.52
8	7386.00	46.1 AV	54.0	-7.9	1.19 H	44	31.58	14.52

ANTENNA POLARITY & TEST DISTANCE: VERTICAL AT 3 M

NO.	FREQ. (MHz)	EMISSION LEVEL (dBuV/m)	LIMIT (dBuV/m)	MARGIN (dB)	ANTENNA HEIGHT (m)	TABLE ANGLE (Degree)	RAW VALUE (dBuV)	CORRECTION FACTOR (dB/m)
1	*2462.00	111.6 PK			1.93 V	327	112.86	-1.26
2	*2462.00	101.8 AV			1.93 V	327	103.06	-1.26
3	2483.50	71.3 PK	74.0	-2.7	1.79 V	327	72.51	-1.21
4	2483.50	53.5 AV	54.0	-0.5	1.79 V	327	54.71	-1.21
5	4924.00	41.2 PK	74.0	-32.8	1.98 V	324	33.75	7.45
6	4924.00	30.8 AV	54.0	-23.2	1.98 V	324	23.35	7.45
7	7386.00	54.3 PK	74.0	-19.7	1.68 V	72	39.78	14.52
8	7386.00	41.0 AV	54.0	-13.0	1.68 V	72	26.48	14.52

REMARKS:

1. Emission Level(dBuV/m) = Raw Value(dBuV) + Correction Factor(dB/m)
2. Correction Factor(dB/m) = Antenna Factor(dB/m) + Cable Factor(dB) – Pre-Amplifier Factor(dB)
3. The other emission levels were very low against the limit.
4. Margin value = Emission Level – Limit value
5. " * ": Fundamental frequency.

VHT20

CHANNEL	TX Channel 1	DETECTOR FUNCTION	Peak (PK)
FREQUENCY RANGE	1GHz ~ 25GHz		Average (AV)

ANTENNA POLARITY & TEST DISTANCE: HORIZONTAL AT 3 M

NO.	FREQ. (MHz)	EMISSION LEVEL (dBuV/m)	LIMIT (dBuV/m)	MARGIN (dB)	ANTENNA HEIGHT (m)	TABLE ANGLE (Degree)	RAW VALUE (dBuV)	CORRECTION FACTOR (dB/m)
1	2390.00	63.0 PK	74.0	-11.0	1.38 H	289	64.43	-1.43
2	2390.00	50.9 AV	54.0	-3.1	1.38 H	289	52.33	-1.43
3	*2412.00	109.2 PK			1.34 H	286	110.58	-1.38
4	*2412.00	99.3 AV			1.34 H	286	100.68	-1.38
5	4824.00	42.3 PK	74.0	-31.7	1.23 H	134	35.21	7.09
6	4824.00	30.0 AV	54.0	-24.0	1.23 H	134	22.91	7.09

ANTENNA POLARITY & TEST DISTANCE: VERTICAL AT 3 M

NO.	FREQ. (MHz)	EMISSION LEVEL (dBuV/m)	LIMIT (dBuV/m)	MARGIN (dB)	ANTENNA HEIGHT (m)	TABLE ANGLE (Degree)	RAW VALUE (dBuV)	CORRECTION FACTOR (dB/m)
1	2390.00	73.3 PK	74.0	-0.7	1.63 V	339	74.73	-1.43
2	2390.00	52.7 AV	54.0	-1.3	1.63 V	339	54.13	-1.43
3	*2412.00	111.9 PK			1.63 V	339	113.28	-1.38
4	*2412.00	102.2 AV			1.63 V	339	103.58	-1.38
5	4824.00	45.3 PK	74.0	-28.7	1.97 V	325	38.21	7.09
6	4824.00	29.1 AV	54.0	-24.9	1.97 V	325	22.01	7.09

REMARKS:

1. Emission Level(dBuV/m) = Raw Value(dBuV) + Correction Factor(dB/m)
2. Correction Factor(dB/m) = Antenna Factor(dB/m) + Cable Factor(dB) – Pre-Amplifier Factor(dB)
3. The other emission levels were very low against the limit.
4. Margin value = Emission Level – Limit value
5. " * ": Fundamental frequency.

CHANNEL	TX Channel 6	DETECTOR FUNCTION	Peak (PK)
FREQUENCY RANGE	1GHz ~ 25GHz		Average (AV)

ANTENNA POLARITY & TEST DISTANCE: HORIZONTAL AT 3 M

NO.	FREQ. (MHz)	EMISSION LEVEL (dBuV/m)	LIMIT (dBuV/m)	MARGIN (dB)	ANTENNA HEIGHT (m)	TABLE ANGLE (Degree)	RAW VALUE (dBuV)	CORRECTION FACTOR (dB/m)
1	2390.00	61.5 PK	74.0	-12.5	1.49 H	301	62.93	-1.43
2	2390.00	48.1 AV	54.0	-5.9	1.49 H	301	49.53	-1.43
3	*2437.00	114.3 PK			1.50 H	292	115.62	-1.32
4	*2437.00	103.8 AV			1.50 H	292	105.12	-1.32
5	2483.50	62.7 PK	74.0	-11.3	1.44 H	287	63.91	-1.21
6	2483.50	49.2 AV	54.0	-4.8	1.44 H	287	50.41	-1.21
7	4874.00	43.7 PK	74.0	-30.3	1.90 H	309	36.45	7.25
8	4874.00	32.2 AV	54.0	-21.8	1.90 H	309	24.95	7.25
9	7311.00	62.9 PK	74.0	-11.1	1.65 H	78	48.45	14.45
10	7311.00	48.0 AV	54.0	-6.0	1.65 H	78	33.55	14.45

ANTENNA POLARITY & TEST DISTANCE: VERTICAL AT 3 M

NO.	FREQ. (MHz)	EMISSION LEVEL (dBuV/m)	LIMIT (dBuV/m)	MARGIN (dB)	ANTENNA HEIGHT (m)	TABLE ANGLE (Degree)	RAW VALUE (dBuV)	CORRECTION FACTOR (dB/m)
1	2390.00	71.3 PK	74.0	-2.7	1.42 V	328	72.73	-1.43
2	2390.00	53.9 AV	54.0	-0.1	1.42 V	328	55.33	-1.43
3	*2437.00	117.0 PK			1.42 V	328	118.32	-1.32
4	*2437.00	106.5 AV			1.42 V	328	107.82	-1.32
5	2483.50	66.9 PK	74.0	-7.1	1.42 V	328	68.11	-1.21
6	2483.50	50.2 AV	54.0	-3.8	1.42 V	328	51.41	-1.21
7	4874.00	41.2 PK	74.0	-32.8	1.98 V	332	33.95	7.25
8	4874.00	30.5 AV	54.0	-23.5	1.98 V	332	23.25	7.25
9	7311.00	54.2 PK	74.0	-19.8	1.64 V	86	39.75	14.45
10	7311.00	40.6 AV	54.0	-13.4	1.64 V	86	26.15	14.45

REMARKS:

1. Emission Level(dBuV/m) = Raw Value(dBuV) + Correction Factor(dB/m)
2. Correction Factor(dB/m) = Antenna Factor(dB/m) + Cable Factor(dB) – Pre-Amplifier Factor(dB)
3. The other emission levels were very low against the limit.
4. Margin value = Emission Level – Limit value
5. " * ": Fundamental frequency.

CHANNEL	TX Channel 11	DETECTOR FUNCTION	Peak (PK)
FREQUENCY RANGE	1GHz ~ 25GHz		Average (AV)

ANTENNA POLARITY & TEST DISTANCE: HORIZONTAL AT 3 M

NO.	FREQ. (MHz)	EMISSION LEVEL (dBuV/m)	LIMIT (dBuV/m)	MARGIN (dB)	ANTENNA HEIGHT (m)	TABLE ANGLE (Degree)	RAW VALUE (dBuV)	CORRECTION FACTOR (dB/m)
1	*2462.00	108.0 PK			1.49 H	318	109.26	-1.26
2	*2462.00	98.3 AV			1.49 H	318	99.56	-1.26
3	2483.50	68.7 PK	74.0	-5.3	1.48 H	313	69.91	-1.21
4	2483.50	50.0 AV	54.0	-4.0	1.48 H	313	51.21	-1.21
5	4924.00	42.4 PK	74.0	-31.6	1.53 H	201	34.95	7.45
6	4924.00	30.8 AV	54.0	-23.2	1.53 H	201	23.35	7.45
7	7386.00	57.1 PK	74.0	-16.9	1.13 H	42	42.58	14.52
8	7386.00	46.6 AV	54.0	-7.4	1.13 H	42	32.08	14.52

ANTENNA POLARITY & TEST DISTANCE: VERTICAL AT 3 M

NO.	FREQ. (MHz)	EMISSION LEVEL (dBuV/m)	LIMIT (dBuV/m)	MARGIN (dB)	ANTENNA HEIGHT (m)	TABLE ANGLE (Degree)	RAW VALUE (dBuV)	CORRECTION FACTOR (dB/m)
1	*2462.00	111.3 PK			1.72 V	340	112.56	-1.26
2	*2462.00	101.5 AV			1.72 V	340	102.76	-1.26
3	2483.50	73.6 PK	74.0	-0.4	1.72 V	340	74.81	-1.21
4	2483.50	53.7 AV	54.0	-0.3	1.72 V	340	54.91	-1.21
5	4924.00	41.4 PK	74.0	-32.6	1.96 V	344	33.95	7.45
6	4924.00	30.9 AV	54.0	-23.1	1.96 V	344	23.45	7.45
7	7386.00	54.5 PK	74.0	-19.5	1.70 V	90	39.98	14.52
8	7386.00	40.6 AV	54.0	-13.4	1.70 V	90	26.08	14.52

REMARKS:

1. Emission Level(dBuV/m) = Raw Value(dBuV) + Correction Factor(dB/m)
2. Correction Factor(dB/m) = Antenna Factor(dB/m) + Cable Factor(dB) – Pre-Amplifier Factor(dB)
3. The other emission levels were very low against the limit.
4. Margin value = Emission Level – Limit value
5. " * ": Fundamental frequency.

VHT40

CHANNEL	TX Channel 3	DETECTOR FUNCTION	Peak (PK)
FREQUENCY RANGE	1GHz ~ 25GHz		Average (AV)

ANTENNA POLARITY & TEST DISTANCE: HORIZONTAL AT 3 M								
NO.	FREQ. (MHz)	EMISSION LEVEL (dBuV/m)	LIMIT (dBuV/m)	MARGIN (dB)	ANTENNA HEIGHT (m)	TABLE ANGLE (Degree)	RAW VALUE (dBuV)	CORRECTION FACTOR (dB/m)
1	2390.00	66.0 PK	74.0	-8.0	1.53 H	300	67.43	-1.43
2	2390.00	50.8 AV	54.0	-3.2	1.53 H	300	52.23	-1.43
3	*2422.00	104.4 PK			1.53 H	300	105.76	-1.36
4	*2422.00	94.5 AV			1.53 H	300	95.86	-1.36
5	4844.00	44.3 PK	74.0	-29.7	2.18 H	48	37.15	7.15
6	4844.00	32.5 AV	54.0	-21.5	2.18 H	48	25.35	7.15
7	7266.00	60.7 PK	74.0	-13.3	1.61 H	75	46.13	14.57
8	7266.00	45.6 AV	54.0	-8.4	1.61 H	75	31.03	14.57

ANTENNA POLARITY & TEST DISTANCE: VERTICAL AT 3 M								
NO.	FREQ. (MHz)	EMISSION LEVEL (dBuV/m)	LIMIT (dBuV/m)	MARGIN (dB)	ANTENNA HEIGHT (m)	TABLE ANGLE (Degree)	RAW VALUE (dBuV)	CORRECTION FACTOR (dB/m)
1	2390.00	72.7 PK	74.0	-1.3	1.73 V	331	74.13	-1.43
2	2390.00	53.8 AV	54.0	-0.2	1.73 V	331	55.23	-1.43
3	*2422.00	108.4 PK			1.73 V	331	109.76	-1.36
4	*2422.00	98.3 AV			1.73 V	331	99.66	-1.36
5	4844.00	41.0 PK	74.0	-33.0	2.03 V	324	33.85	7.15
6	4844.00	30.4 AV	54.0	-23.6	2.03 V	324	23.25	7.15
7	7266.00	54.8 PK	74.0	-19.2	1.62 V	95	40.23	14.57
8	7266.00	40.9 AV	54.0	-13.1	1.62 V	95	26.33	14.57

REMARKS:

1. Emission Level(dBuV/m) = Raw Value(dBuV) + Correction Factor(dB/m)
2. Correction Factor(dB/m) = Antenna Factor(dB/m) + Cable Factor(dB) – Pre-Amplifier Factor(dB)
3. The other emission levels were very low against the limit.
4. Margin value = Emission Level – Limit value
5. " * ": Fundamental frequency.

CHANNEL	TX Channel 6	DETECTOR FUNCTION	Peak (PK)
FREQUENCY RANGE	1GHz ~ 25GHz		Average (AV)

ANTENNA POLARITY & TEST DISTANCE: HORIZONTAL AT 3 M

NO.	FREQ. (MHz)	EMISSION LEVEL (dBuV/m)	LIMIT (dBuV/m)	MARGIN (dB)	ANTENNA HEIGHT (m)	TABLE ANGLE (Degree)	RAW VALUE (dBuV)	CORRECTION FACTOR (dB/m)
1	2390.00	62.6 PK	74.0	-11.4	1.29 H	302	64.03	-1.43
2	2390.00	48.4 AV	54.0	-5.6	1.29 H	302	49.83	-1.43
3	*2437.00	105.6 PK			1.29 H	302	106.92	-1.32
4	*2437.00	95.5 AV			1.29 H	302	96.82	-1.32
5	2483.50	63.3 PK	74.0	-10.7	1.29 H	302	64.51	-1.21
6	2483.50	48.9 AV	54.0	-5.1	1.29 H	302	50.11	-1.21
7	4874.00	44.0 PK	74.0	-30.0	2.12 H	59	36.75	7.25
8	4874.00	32.5 AV	54.0	-21.5	2.12 H	59	25.25	7.25
9	7311.00	59.6 PK	74.0	-14.4	1.69 H	69	45.15	14.45
10	7311.00	44.7 AV	54.0	-9.3	1.69 H	69	30.25	14.45

ANTENNA POLARITY & TEST DISTANCE: VERTICAL AT 3 M

NO.	FREQ. (MHz)	EMISSION LEVEL (dBuV/m)	LIMIT (dBuV/m)	MARGIN (dB)	ANTENNA HEIGHT (m)	TABLE ANGLE (Degree)	RAW VALUE (dBuV)	CORRECTION FACTOR (dB/m)
1	2390.00	69.9 PK	74.0	-4.1	1.82 V	318	71.33	-1.43
2	2390.00	53.1 AV	54.0	-0.9	1.82 V	318	54.53	-1.43
3	*2437.00	109.4 PK			1.61 V	353	110.72	-1.32
4	*2437.00	99.0 AV			1.61 V	353	100.32	-1.32
5	2483.50	69.2 PK	74.0	-4.8	1.82 V	310	70.41	-1.21
6	2483.50	49.8 AV	54.0	-4.2	1.82 V	310	51.01	-1.21
7	4874.00	40.8 PK	74.0	-33.2	1.96 V	343	33.55	7.25
8	4874.00	30.1 AV	54.0	-23.9	1.96 V	343	22.85	7.25
9	7311.00	54.4 PK	74.0	-19.6	1.66 V	71	39.95	14.45
10	7311.00	40.5 AV	54.0	-13.5	1.66 V	71	26.05	14.45

REMARKS:

1. Emission Level(dBuV/m) = Raw Value(dBuV) + Correction Factor(dB/m)
2. Correction Factor(dB/m) = Antenna Factor(dB/m) + Cable Factor(dB) – Pre-Amplifier Factor(dB)
3. The other emission levels were very low against the limit.
4. Margin value = Emission Level – Limit value
5. " * ": Fundamental frequency.

CHANNEL	TX Channel 9	DETECTOR FUNCTION	Peak (PK)
FREQUENCY RANGE	1GHz ~ 25GHz		Average (AV)

ANTENNA POLARITY & TEST DISTANCE: HORIZONTAL AT 3 M

NO.	FREQ. (MHz)	EMISSION LEVEL (dBuV/m)	LIMIT (dBuV/m)	MARGIN (dB)	ANTENNA HEIGHT (m)	TABLE ANGLE (Degree)	RAW VALUE (dBuV)	CORRECTION FACTOR (dB/m)
1	*2452.00	104.2 PK			1.37 H	289	105.48	-1.28
2	*2452.00	83.6 AV			1.37 H	289	84.88	-1.28
3	2483.50	65.3 PK	74.0	-8.7	1.37 H	289	66.51	-1.21
4	2483.50	49.4 AV	54.0	-4.6	1.37 H	289	50.61	-1.21
5	4904.00	43.8 PK	74.0	-30.2	2.20 H	62	36.44	7.36
6	4904.00	32.2 AV	54.0	-21.8	2.20 H	62	24.84	7.36
7	7356.00	59.8 PK	74.0	-14.2	1.62 H	91	45.30	14.50
8	7356.00	45.1 AV	54.0	-8.9	1.62 H	91	30.60	14.50

ANTENNA POLARITY & TEST DISTANCE: VERTICAL AT 3 M

NO.	FREQ. (MHz)	EMISSION LEVEL (dBuV/m)	LIMIT (dBuV/m)	MARGIN (dB)	ANTENNA HEIGHT (m)	TABLE ANGLE (Degree)	RAW VALUE (dBuV)	CORRECTION FACTOR (dB/m)
1	*2452.00	108.2 PK			1.79 V	336	109.48	-1.28
2	*2452.00	97.8 AV			1.79 V	336	99.08	-1.28
3	2483.50	71.2 PK	74.0	-2.8	1.79 V	336	72.41	-1.21
4	2483.50	53.6 AV	54.0	-0.4	1.79 V	336	54.81	-1.21
5	4904.00	41.0 PK	74.0	-33.0	1.93 V	345	33.64	7.36
6	4904.00	30.1 AV	54.0	-23.9	1.93 V	345	22.74	7.36
7	7356.00	54.5 PK	74.0	-19.5	1.67 V	102	40.00	14.50
8	7356.00	41.0 AV	54.0	-13.0	1.67 V	102	26.50	14.50

REMARKS:

1. Emission Level(dBuV/m) = Raw Value(dBuV) + Correction Factor(dB/m)
2. Correction Factor(dB/m) = Antenna Factor(dB/m) + Cable Factor(dB) – Pre-Amplifier Factor(dB)
3. The other emission levels were very low against the limit.
4. Margin value = Emission Level – Limit value
5. " * ": Fundamental frequency.

Below 1GHz Data:

CDD Mode

802.11g

CHANNEL	TX Channel 6	DETECTOR FUNCTION	Quasi-Peak (QP)
FREQUENCY RANGE	Below 1GHz		

ANTENNA POLARITY & TEST DISTANCE: HORIZONTAL AT 3 M

NO.	FREQ. (MHz)	EMISSION LEVEL (dBuV/m)	LIMIT (dBuV/m)	MARGIN (dB)	ANTENNA HEIGHT (m)	TABLE ANGLE (Degree)	RAW VALUE (dBuV)	CORRECTION FACTOR (dB/m)
1	41.01	29.7 QP	40.0	-10.3	1.00 H	39	43.35	-13.69
2	90.09	35.8 QP	43.5	-7.7	2.00 H	25	54.68	-18.92
3	158.14	37.5 QP	43.5	-6.0	1.50 H	84	50.44	-12.91
4	168.22	40.1 QP	43.5	-3.4	1.50 H	65	53.34	-13.28
5	195.77	32.4 QP	43.5	-11.1	1.50 H	80	48.34	-15.95
6	326.48	35.4 QP	46.0	-10.6	1.00 H	292	46.29	-10.91

ANTENNA POLARITY & TEST DISTANCE: VERTICAL AT 3 M

NO.	FREQ. (MHz)	EMISSION LEVEL (dBuV/m)	LIMIT (dBuV/m)	MARGIN (dB)	ANTENNA HEIGHT (m)	TABLE ANGLE (Degree)	RAW VALUE (dBuV)	CORRECTION FACTOR (dB/m)
1	37.53	35.6 QP	40.0	-4.5	1.00 V	360	49.54	-13.99
2	38.23	33.7 QP	40.0	-6.3	1.01 V	336	47.54	-13.88
3	76.03	36.4 QP	40.0	-3.6	1.00 V	240	53.05	-16.62
4	97.42	37.0 QP	43.5	-6.5	1.00 V	235	55.06	-18.09
5	169.16	36.4 QP	43.5	-7.1	1.00 V	16	49.77	-13.36
6	341.03	35.0 QP	46.0	-11.0	1.00 V	360	45.81	-10.78

REMARKS:

1. Emission Level(dBuV/m) = Raw Value(dBuV) + Correction Factor(dB/m)
2. Correction Factor(dB/m) = Antenna Factor(dB/m) + Cable Factor(dB) – Pre-Amplifier Factor(dB)
3. The other emission levels were very low against the limit.
4. Margin value = Emission Level – Limit value

Above 1GHz Data:

Beamforming Mode

VHT20

CHANNEL	TX Channel 1	DETECTOR FUNCTION	Peak (PK)
FREQUENCY RANGE	1GHz ~ 25GHz		Average (AV)

ANTENNA POLARITY & TEST DISTANCE: HORIZONTAL AT 3 M

NO.	FREQ. (MHz)	EMISSION LEVEL (dBuV/m)	LIMIT (dBuV/m)	MARGIN (dB)	ANTENNA HEIGHT (m)	TABLE ANGLE (Degree)	RAW VALUE (dBuV)	CORRECTION FACTOR (dB/m)
1	2390.00	63.4 PK	74.0	-10.6	1.42 H	280	64.83	-1.43
2	2390.00	51.2 AV	54.0	-2.8	1.42 H	280	52.63	-1.43
3	*2412.00	110.1 PK			1.34 H	281	111.48	-1.38
4	*2412.00	100.4 AV			1.34 H	281	101.78	-1.38
5	4824.00	42.4 PK	74.0	-31.6	1.18 H	140	35.31	7.09
6	4824.00	30.1 AV	54.0	-23.9	1.18 H	140	23.01	7.09

ANTENNA POLARITY & TEST DISTANCE: VERTICAL AT 3 M

NO.	FREQ. (MHz)	EMISSION LEVEL (dBuV/m)	LIMIT (dBuV/m)	MARGIN (dB)	ANTENNA HEIGHT (m)	TABLE ANGLE (Degree)	RAW VALUE (dBuV)	CORRECTION FACTOR (dB/m)
1	2390.00	73.7 PK	74.0	-0.3	1.66 V	327	75.13	-1.43
2	2390.00	53.8 AV	54.0	-0.2	1.66 V	327	55.23	-1.43
3	*2412.00	114.2 PK			1.66 V	327	115.58	-1.38
4	*2412.00	103.6 AV			1.66 V	327	104.98	-1.38
5	4824.00	45.0 PK	74.0	-29.0	2.03 V	335	37.91	7.09
6	4824.00	28.8 AV	54.0	-25.2	2.03 V	335	21.71	7.09

REMARKS:

1. Emission Level(dBuV/m) = Raw Value(dBuV) + Correction Factor(dB/m)
2. Correction Factor(dB/m) = Antenna Factor(dB/m) + Cable Factor(dB) – Pre-Amplifier Factor(dB)
3. The other emission levels were very low against the limit.
4. Margin value = Emission Level – Limit value
5. " * ": Fundamental frequency.

CHANNEL	TX Channel 6	DETECTOR FUNCTION	Peak (PK)
FREQUENCY RANGE	1GHz ~ 25GHz		Average (AV)

ANTENNA POLARITY & TEST DISTANCE: HORIZONTAL AT 3 M

NO.	FREQ. (MHz)	EMISSION LEVEL (dBuV/m)	LIMIT (dBuV/m)	MARGIN (dB)	ANTENNA HEIGHT (m)	TABLE ANGLE (Degree)	RAW VALUE (dBuV)	CORRECTION FACTOR (dB/m)
1	2390.00	61.8 PK	74.0	-12.2	1.52 H	307	63.23	-1.43
2	2390.00	48.4 AV	54.0	-5.6	1.52 H	307	49.83	-1.43
3	*2437.00	115.9 PK			1.47 H	300	117.22	-1.32
4	*2437.00	105.2 AV			1.47 H	300	106.52	-1.32
5	2483.50	62.9 PK	74.0	-11.1	1.41 H	289	64.11	-1.21
6	2483.50	49.4 AV	54.0	-4.6	1.41 H	289	50.61	-1.21
7	4874.00	43.7 PK	74.0	-30.3	1.94 H	293	36.45	7.25
8	4874.00	32.3 AV	54.0	-21.7	1.94 H	293	25.05	7.25
9	7311.00	63.2 PK	74.0	-10.8	1.65 H	79	48.75	14.45
10	7311.00	48.3 AV	54.0	-5.7	1.65 H	79	33.85	14.45

ANTENNA POLARITY & TEST DISTANCE: VERTICAL AT 3 M

NO.	FREQ. (MHz)	EMISSION LEVEL (dBuV/m)	LIMIT (dBuV/m)	MARGIN (dB)	ANTENNA HEIGHT (m)	TABLE ANGLE (Degree)	RAW VALUE (dBuV)	CORRECTION FACTOR (dB/m)
1	2390.00	67.4 PK	74.0	-6.6	1.58 V	325	68.83	-1.43
2	2390.00	53.2 AV	54.0	-0.8	1.58 V	325	54.63	-1.43
3	*2437.00	118.5 PK			1.58 V	325	119.82	-1.32
4	*2437.00	108.8 AV			1.58 V	325	110.12	-1.32
5	2483.50	66.8 PK	74.0	-7.2	1.58 V	325	68.01	-1.21
6	2483.50	50.8 AV	54.0	-3.2	1.58 V	325	52.01	-1.21
7	4874.00	41.0 PK	74.0	-33.0	1.93 V	340	33.75	7.25
8	4874.00	30.6 AV	54.0	-23.4	1.93 V	340	23.35	7.25
9	7311.00	54.2 PK	74.0	-19.8	1.61 V	71	39.75	14.45
10	7311.00	40.6 AV	54.0	-13.4	1.61 V	71	26.15	14.45

REMARKS:

1. Emission Level(dBuV/m) = Raw Value(dBuV) + Correction Factor(dB/m)
2. Correction Factor(dB/m) = Antenna Factor(dB/m) + Cable Factor(dB) – Pre-Amplifier Factor(dB)
3. The other emission levels were very low against the limit.
4. Margin value = Emission Level – Limit value
5. " * ": Fundamental frequency.

CHANNEL	TX Channel 11	DETECTOR FUNCTION	Peak (PK)
FREQUENCY RANGE	1GHz ~ 25GHz		Average (AV)

ANTENNA POLARITY & TEST DISTANCE: HORIZONTAL AT 3 M

NO.	FREQ. (MHz)	EMISSION LEVEL (dBuV/m)	LIMIT (dBuV/m)	MARGIN (dB)	ANTENNA HEIGHT (m)	TABLE ANGLE (Degree)	RAW VALUE (dBuV)	CORRECTION FACTOR (dB/m)
1	*2462.00	107.9 PK			1.50 H	305	109.16	-1.26
2	*2462.00	98.1 AV			1.50 H	305	99.36	-1.26
3	2483.50	69.1 PK	74.0	-4.9	1.53 H	307	70.31	-1.21
4	2483.50	50.3 AV	54.0	-3.7	1.53 H	307	51.51	-1.21
5	4924.00	43.0 PK	74.0	-31.0	1.57 H	215	35.55	7.45
6	4924.00	31.2 AV	54.0	-22.8	1.57 H	215	23.75	7.45
7	7386.00	57.8 PK	74.0	-16.2	1.15 H	47	43.28	14.52
8	7386.00	47.0 AV	54.0	-7.0	1.15 H	47	32.48	14.52

ANTENNA POLARITY & TEST DISTANCE: VERTICAL AT 3 M

NO.	FREQ. (MHz)	EMISSION LEVEL (dBuV/m)	LIMIT (dBuV/m)	MARGIN (dB)	ANTENNA HEIGHT (m)	TABLE ANGLE (Degree)	RAW VALUE (dBuV)	CORRECTION FACTOR (dB/m)
1	*2462.00	110.5 PK			1.84 V	341	111.76	-1.26
2	*2462.00	101.1 AV			1.84 V	341	102.36	-1.26
3	2483.50	68.6 PK	74.0	-5.4	1.84 V	341	69.81	-1.21
4	2483.50	53.5 AV	54.0	-0.5	1.84 V	341	54.71	-1.21
5	4924.00	41.8 PK	74.0	-32.2	1.92 V	344	34.35	7.45
6	4924.00	31.1 AV	54.0	-22.9	1.92 V	344	23.65	7.45
7	7386.00	54.8 PK	74.0	-19.2	1.73 V	76	40.28	14.52
8	7386.00	40.9 AV	54.0	-13.1	1.73 V	76	26.38	14.52

REMARKS:

1. Emission Level(dBuV/m) = Raw Value(dBuV) + Correction Factor(dB/m)
2. Correction Factor(dB/m) = Antenna Factor(dB/m) + Cable Factor(dB) – Pre-Amplifier Factor(dB)
3. The other emission levels were very low against the limit.
4. Margin value = Emission Level – Limit value
5. " * ": Fundamental frequency.

VHT40

CHANNEL	TX Channel 3	DETECTOR FUNCTION	Peak (PK)
FREQUENCY RANGE	1GHz ~ 25GHz		Average (AV)

ANTENNA POLARITY & TEST DISTANCE: HORIZONTAL AT 3 M								
NO.	FREQ. (MHz)	EMISSION LEVEL (dBuV/m)	LIMIT (dBuV/m)	MARGIN (dB)	ANTENNA HEIGHT (m)	TABLE ANGLE (Degree)	RAW VALUE (dBuV)	CORRECTION FACTOR (dB/m)
1	2390.00	66.6 PK	74.0	-7.4	1.49 H	294	68.03	-1.43
2	2390.00	51.2 AV	54.0	-2.8	1.49 H	294	52.63	-1.43
3	*2422.00	105.7 PK			1.51 H	304	107.06	-1.36
4	*2422.00	95.8 AV			1.51 H	304	97.16	-1.36
5	4844.00	44.4 PK	74.0	-29.6	2.15 H	63	37.25	7.15
6	4844.00	32.6 AV	54.0	-21.4	2.15 H	63	25.45	7.15
7	7266.00	60.7 PK	74.0	-13.3	1.57 H	86	46.13	14.57
8	7266.00	45.3 AV	54.0	-8.7	1.57 H	86	30.73	14.57

ANTENNA POLARITY & TEST DISTANCE: VERTICAL AT 3 M								
NO.	FREQ. (MHz)	EMISSION LEVEL (dBuV/m)	LIMIT (dBuV/m)	MARGIN (dB)	ANTENNA HEIGHT (m)	TABLE ANGLE (Degree)	RAW VALUE (dBuV)	CORRECTION FACTOR (dB/m)
1	2390.00	72.1 PK	74.0	-1.9	1.86 V	349	73.53	-1.43
2	2390.00	53.7 AV	54.0	-0.3	1.86 V	349	55.13	-1.43
3	*2422.00	109.6 PK			1.86 V	349	110.96	-1.36
4	*2422.00	99.4 AV			1.86 V	349	100.76	-1.36
5	4844.00	41.1 PK	74.0	-32.9	2.02 V	320	33.95	7.15
6	4844.00	30.7 AV	54.0	-23.3	2.02 V	320	23.55	7.15
7	7266.00	54.7 PK	74.0	-19.3	1.62 V	99	40.13	14.57
8	7266.00	40.6 AV	54.0	-13.4	1.62 V	99	26.03	14.57

REMARKS:

1. Emission Level(dBuV/m) = Raw Value(dBuV) + Correction Factor(dB/m)
2. Correction Factor(dB/m) = Antenna Factor(dB/m) + Cable Factor(dB) – Pre-Amplifier Factor(dB)
3. The other emission levels were very low against the limit.
4. Margin value = Emission Level – Limit value
5. " * ": Fundamental frequency.

CHANNEL	TX Channel 6	DETECTOR FUNCTION	Peak (PK)
FREQUENCY RANGE	1GHz ~ 25GHz		Average (AV)

ANTENNA POLARITY & TEST DISTANCE: HORIZONTAL AT 3 M

NO.	FREQ. (MHz)	EMISSION LEVEL (dBuV/m)	LIMIT (dBuV/m)	MARGIN (dB)	ANTENNA HEIGHT (m)	TABLE ANGLE (Degree)	RAW VALUE (dBuV)	CORRECTION FACTOR (dB/m)
1	2390.00	62.5 PK	74.0	-11.5	1.25 H	307	63.93	-1.43
2	2390.00	48.5 AV	54.0	-5.5	1.25 H	307	49.93	-1.43
3	*2437.00	106.9 PK			1.25 H	294	108.22	-1.32
4	*2437.00	96.6 AV			1.25 H	294	97.92	-1.32
5	2483.50	60.5 PK	74.0	-13.5	1.26 H	312	61.71	-1.21
6	2483.50	46.9 AV	54.0	-7.1	1.26 H	312	48.11	-1.21
7	4874.00	43.8 PK	74.0	-30.2	2.14 H	69	36.55	7.25
8	4874.00	32.2 AV	54.0	-21.8	2.14 H	69	24.95	7.25
9	7311.00	58.9 PK	74.0	-15.1	1.70 H	53	44.45	14.45
10	7311.00	44.2 AV	54.0	-9.8	1.70 H	53	29.75	14.45

ANTENNA POLARITY & TEST DISTANCE: VERTICAL AT 3 M

NO.	FREQ. (MHz)	EMISSION LEVEL (dBuV/m)	LIMIT (dBuV/m)	MARGIN (dB)	ANTENNA HEIGHT (m)	TABLE ANGLE (Degree)	RAW VALUE (dBuV)	CORRECTION FACTOR (dB/m)
1	2390.00	70.2 PK	74.0	-3.8	1.87 V	353	71.63	-1.43
2	2390.00	53.4 AV	54.0	-0.6	1.87 V	353	54.83	-1.43
3	*2437.00	110.3 PK			1.87 V	353	111.62	-1.32
4	*2437.00	100.2 AV			1.87 V	353	101.52	-1.32
5	2483.50	68.4 PK	74.0	-5.6	1.87 V	353	69.61	-1.21
6	2483.50	49.5 AV	54.0	-4.5	1.87 V	353	50.71	-1.21
7	4874.00	40.6 PK	74.0	-33.4	1.95 V	340	33.35	7.25
8	4874.00	29.7 AV	54.0	-24.3	1.95 V	340	22.45	7.25
9	7311.00	54.1 PK	74.0	-19.9	1.66 V	60	39.65	14.45
10	7311.00	40.2 AV	54.0	-13.8	1.66 V	60	25.75	14.45

REMARKS:

1. Emission Level(dBuV/m) = Raw Value(dBuV) + Correction Factor(dB/m)
2. Correction Factor(dB/m) = Antenna Factor(dB/m) + Cable Factor(dB) – Pre-Amplifier Factor(dB)
3. The other emission levels were very low against the limit.
4. Margin value = Emission Level – Limit value
5. " * ": Fundamental frequency.

CHANNEL	TX Channel 9	DETECTOR FUNCTION	Peak (PK)
FREQUENCY RANGE	1GHz ~ 25GHz		Average (AV)

ANTENNA POLARITY & TEST DISTANCE: HORIZONTAL AT 3 M

NO.	FREQ. (MHz)	EMISSION LEVEL (dBuV/m)	LIMIT (dBuV/m)	MARGIN (dB)	ANTENNA HEIGHT (m)	TABLE ANGLE (Degree)	RAW VALUE (dBuV)	CORRECTION FACTOR (dB/m)
1	*2452.00	104.4 PK			1.31 H	274	105.68	-1.28
2	*2452.00	83.5 AV			1.31 H	274	84.78	-1.28
3	2483.50	65.9 PK	74.0	-8.1	1.40 H	297	67.11	-1.21
4	2483.50	49.8 AV	54.0	-4.2	1.40 H	297	51.01	-1.21
5	4904.00	43.6 PK	74.0	-30.4	2.19 H	77	36.24	7.36
6	4904.00	32.2 AV	54.0	-21.8	2.19 H	77	24.84	7.36
7	7356.00	60.3 PK	74.0	-13.7	1.62 H	84	45.80	14.50
8	7356.00	45.6 AV	54.0	-8.4	1.62 H	84	31.10	14.50

ANTENNA POLARITY & TEST DISTANCE: VERTICAL AT 3 M

NO.	FREQ. (MHz)	EMISSION LEVEL (dBuV/m)	LIMIT (dBuV/m)	MARGIN (dB)	ANTENNA HEIGHT (m)	TABLE ANGLE (Degree)	RAW VALUE (dBuV)	CORRECTION FACTOR (dB/m)
1	*2452.00	109.5 PK			1.92 V	343	110.78	-1.28
2	*2452.00	98.4 AV			1.92 V	343	99.68	-1.28
3	2483.50	70.3 PK	74.0	-3.7	1.92 V	343	71.51	-1.21
4	2483.50	53.5 AV	54.0	-0.5	1.92 V	343	54.71	-1.21
5	4904.00	41.3 PK	74.0	-32.7	1.96 V	333	33.94	7.36
6	4904.00	30.2 AV	54.0	-23.8	1.96 V	333	22.84	7.36
7	7356.00	54.6 PK	74.0	-19.4	1.65 V	102	40.10	14.50
8	7356.00	41.1 AV	54.0	-12.9	1.65 V	102	26.60	14.50

REMARKS:

1. Emission Level(dBuV/m) = Raw Value(dBuV) + Correction Factor(dB/m)
2. Correction Factor(dB/m) = Antenna Factor(dB/m) + Cable Factor(dB) – Pre-Amplifier Factor(dB)
3. The other emission levels were very low against the limit.
4. Margin value = Emission Level – Limit value
5. " * ": Fundamental frequency.

4.2 Conducted Emission Measurement

4.2.1 Limits of Conducted Emission Measurement

Frequency (MHz)	Conducted Limit (dBuV)	
	Quasi-peak	Average
0.15 - 0.5	66 - 56	56 - 46
0.50 - 5.0	56	46
5.0 - 30.0	60	50

Note: 1. The lower limit shall apply at the transition frequencies.

2. The limit decreases in line with the logarithm of the frequency in the range of 0.15 to 0.50MHz.

4.2.2 Test Instruments

DESCRIPTION & MANUFACTURER	MODEL NO.	SERIAL NO.	CALIBRATED DATE	CALIBRATED UNTIL
Test Receiver R&S	ESCS 30	100375	May 06, 2015	May 05, 2016
Line-Impedance Stabilization Network (for EUT) R&S	ENV216	100072	June 11, 2015	June 10, 2016
Line-Impedance Stabilization Network (for Peripheral) R&S	ENV216	100071	Nov. 10, 2014	Nov. 09, 2015
RF Cable	5D-FB	COCCAB-001	Mar. 09, 2015	Mar. 08, 2016
50 ohms Terminator	N/A	EMC-03	Sep. 22, 2014	Sep. 21, 2015
50 ohms Terminator	N/A	EMC-02	Sep. 30, 2014	Sep. 29, 2015
Software BVADT	BVADT_Cond_ V7.3.7.3	NA	NA	NA

Note:

1. The calibration interval of the above test instruments are 12 months and the calibrations are traceable to NML/ROC and NIST/USA.
2. The test was performed in Shielded Room No. C.
3. The VCCI Con C Registration No. is C-3611.
4. Tested Date: Sep. 10, 2015

4.2.3 Test Procedures

- a. The EUT was placed 0.4 meters from the conducting wall of the shielded room with EUT being connected to the power mains through a line impedance stabilization network (LISN). Other support units were connected to the power mains through another LISN. The two LISNs provide 50 ohm/ 50uH of coupling impedance for the measuring instrument.
- b. Both lines of the power mains connected to the EUT were checked for maximum conducted interference.
- c. The frequency range from 150kHz to 30MHz was searched. Emission levels under (Limit - 20dB) was not recorded.

NOTE: The resolution bandwidth and video bandwidth of test receiver is 9kHz for quasi-peak detection (QP) and average detection (AV) at frequency 0.15MHz-30MHz.

4.2.4 Deviation from Test Standard

No deviation.

4.2.5 Test Setup

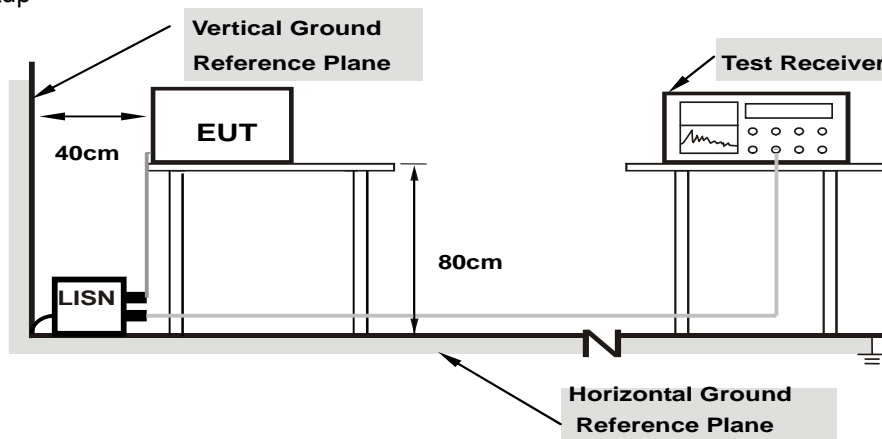

Note: 1.Support units were connected to second LISN.

For the actual test configuration, please refer to the attached file (Test Setup Photo).

4.2.6 EUT Operating Conditions

Same as 4.1.6.

4.2.7 Test Results

CDD Mode

Phase	Line (L)	Detector Function	Quasi-Peak (QP) / Average (AV)
-------	----------	-------------------	--------------------------------

No	Freq. [MHz]	Corr.	Reading Value		Emission Level		Limit		Margin	
		Factor	[dB (uV)]		[dB (uV)]		[dB (uV)]		(dB)	
		(dB)	Q.P.	AV.	Q.P.	AV.	Q.P.	AV.	Q.P.	AV.
1	0.30234	0.10	56.39	46.66	56.49	46.76	60.18	50.18	-3.69	-3.42
2	0.32188	0.10	54.60	41.63	54.70	41.73	59.66	49.66	-4.96	-7.93
3	0.36875	0.10	46.92	39.54	47.02	39.64	58.53	48.53	-11.51	-8.89
4	0.40781	0.10	45.18	37.31	45.28	37.41	57.69	47.69	-12.41	-10.28
5	0.44297	0.10	47.56	39.24	47.66	39.34	57.01	47.01	-9.34	-7.66
6	0.48984	0.10	48.29	37.25	48.39	37.35	56.17	46.17	-7.78	-8.82
7	0.57188	0.11	41.78	29.04	41.89	29.15	56.00	46.00	-14.11	-16.85
8	0.77891	0.12	47.20	36.95	47.32	37.07	56.00	46.00	-8.68	-8.93
9	0.95469	0.13	42.23	31.31	42.36	31.44	56.00	46.00	-13.64	-14.56
10	1.34375	0.14	43.24	33.28	43.38	33.42	56.00	46.00	-12.62	-12.58

REMARKS:

1. Q.P. and AV. are abbreviations of quasi-peak and average individually.
2. The emission levels of other frequencies were very low against the limit.
3. Margin value = Emission level - Limit value
4. Correction factor = Insertion loss + Cable loss
5. Emission Level = Correction Factor + Reading Value

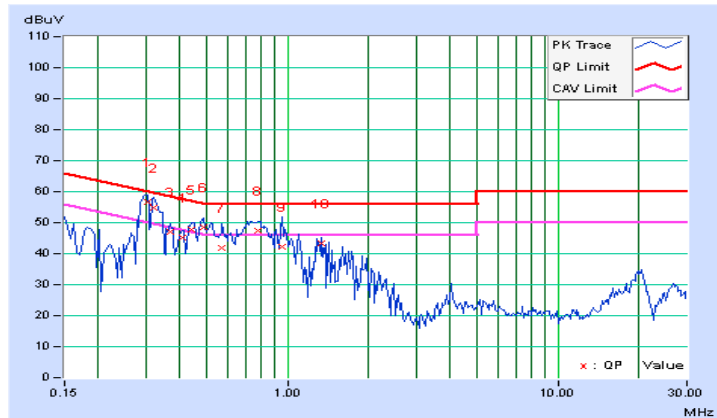

Phase	Neutral (N)	Detector Function	Quasi-Peak (QP) / Average (AV)
-------	-------------	-------------------	--------------------------------

No	Freq. [MHz]	Corr. Factor (dB)	Reading Value		Emission Level		Limit		Margin	
			[dB (uV)]		[dB (uV)]		[dB (uV)]		(dB)	
			Q.P.	AV.	Q.P.	AV.	Q.P.	AV.	Q.P.	AV.
1	0.30395	0.09	56.46	45.30	56.55	45.39	60.13	50.13	-3.58	-4.74
2	0.32188	0.09	54.57	40.59	54.66	40.68	59.66	49.66	-5.00	-8.98
3	0.36484	0.10	46.80	37.80	46.90	37.90	58.62	48.62	-11.72	-10.72
4	0.41172	0.10	44.65	36.35	44.75	36.45	57.61	47.61	-12.86	-11.16
5	0.47422	0.10	47.01	37.06	47.11	37.16	56.44	46.44	-9.33	-9.28
6	0.59141	0.11	42.52	31.32	42.63	31.43	56.00	46.00	-13.37	-14.57
7	0.75547	0.12	46.65	35.77	46.77	35.89	56.00	46.00	-9.23	-10.11
8	0.96250	0.13	42.12	31.82	42.25	31.95	56.00	46.00	-13.75	-14.05
9	1.10156	0.13	44.23	33.57	44.36	33.70	56.00	46.00	-11.64	-12.30
10	1.30859	0.14	42.82	32.78	42.96	32.92	56.00	46.00	-13.04	-13.08
11	1.39453	0.15	42.05	31.71	42.20	31.86	56.00	46.00	-13.80	-14.14

REMARKS:

1. Q.P. and AV. are abbreviations of quasi-peak and average individually.
2. The emission levels of other frequencies were very low against the limit.
3. Margin value = Emission level - Limit value
4. Correction factor = Insertion loss + Cable loss
5. Emission Level = Correction Factor + Reading Value

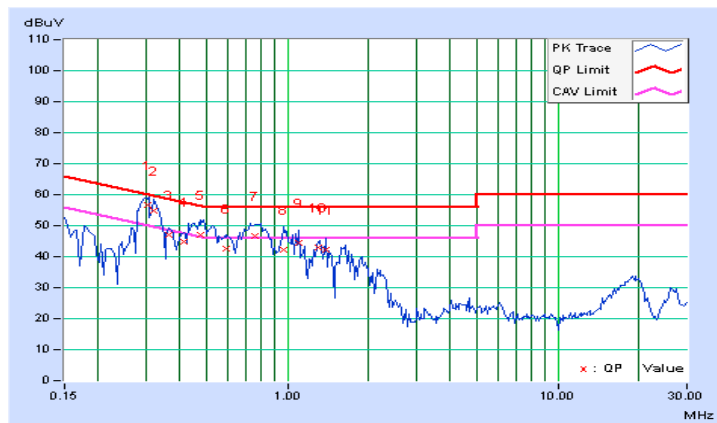

4.3 6dB Bandwidth Measurement

4.3.1 Limits of 6dB Bandwidth Measurement

The minimum of 6dB Bandwidth Measurement is 0.5 MHz.

4.3.2 Test Setup

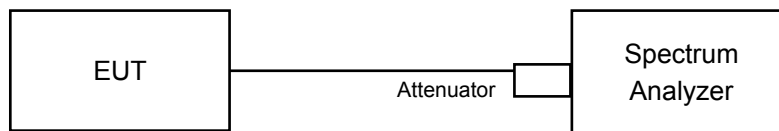

4.3.3 Test Instruments

Refer to section 4.1.2 to get information of above instrument.

4.3.4 Test Procedure

- a. Set resolution bandwidth (RBW) = 100kHz
- b. Set the video bandwidth (VBW) $\geq 3 \times$ RBW, Detector = Peak.
- c. Trace mode = max hold.
- d. Sweep = auto couple.
- e. Measure the maximum width of the emission that is constrained by the frequencies associated with the two amplitude points (upper and lower) that are attenuated by 6 dB relative to the maximum level measured in the fundamental emission

4.3.5 Deviation from Test Standard

No deviation.

4.3.6 EUT Operating Conditions

The software provided by client to enable the EUT under transmission condition continuously at lowest, middle and highest channel frequencies individually.

4.3.7 Test Result

CDD Mode

802.11b

Channel	Frequency (MHz)	6dB Bandwidth (MHz)			Minimum Limit (MHz)	Pass / Fail
		Chain 0	Chain 1	Chain 2		
1	2412	9.06	9.07	9.09	0.5	Pass
6	2437	8.61	8.60	8.59	0.5	Pass
11	2462	9.02	9.07	8.59	0.5	Pass

802.11g

Channel	Frequency (MHz)	6dB Bandwidth (MHz)			Minimum Limit (MHz)	Pass / Fail
		Chain 0	Chain 1	Chain 2		
1	2412	16.36	16.38	16.41	0.5	Pass
6	2437	16.36	15.79	15.81	0.5	Pass
11	2462	16.38	16.41	16.43	0.5	Pass

VHT20

Channel	Frequency (MHz)	6dB Bandwidth (MHz)			Minimum Limit (MHz)	Pass / Fail
		Chain 0	Chain 1	Chain 2		
1	2412	17.30	17.65	17.61	0.5	Pass
6	2437	17.37	17.62	17.36	0.5	Pass
11	2462	17.56	17.66	17.67	0.5	Pass

VHT40

Channel	Frequency (MHz)	6dB Bandwidth (MHz)			Minimum Limit (MHz)	Pass / Fail
		Chain 0	Chain 1	Chain 2		
3	2422	35.88	36.45	36.47	0.5	Pass
6	2437	36.08	36.03	35.89	0.5	Pass
9	2452	36.20	36.42	35.55	0.5	Pass

Spectrum Plot of Worst Value

802.11b – Chain 2: CH 11

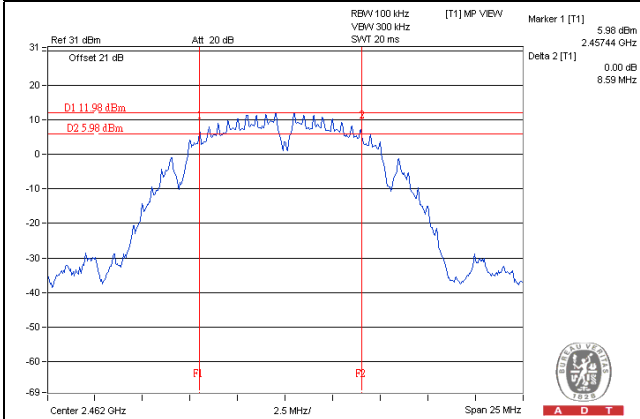

802.11g – Chain 1: CH 6

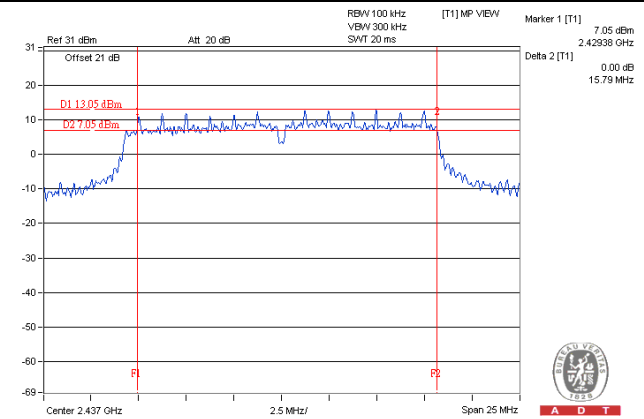

VHT20 – Chain 0: CH 1

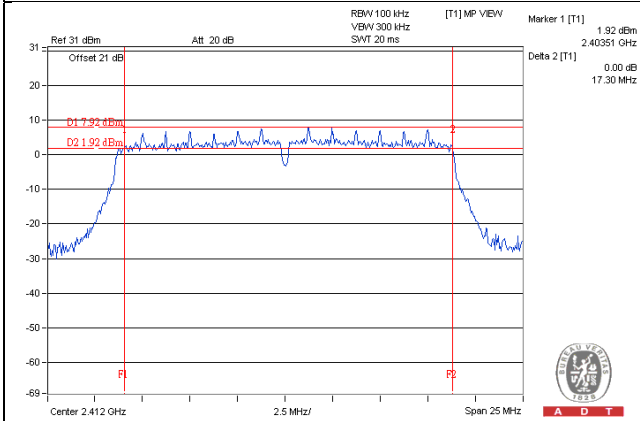

VHT40 – Chain 2: CH 9

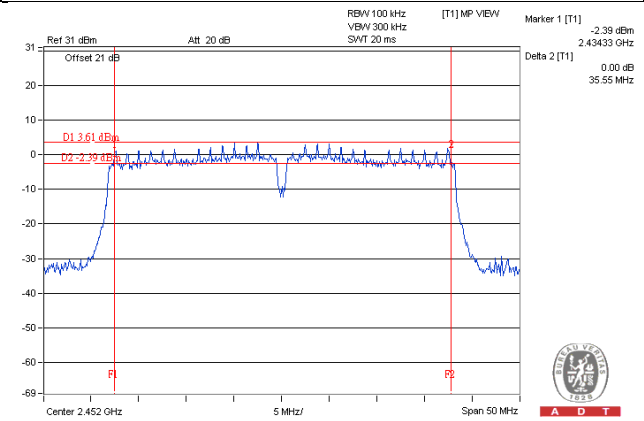

4.4 Conducted Output Power Measurement

4.4.1 Limits of Conducted Output Power Measurement

For systems using digital modulation in the 2400–2483.5 MHz bands: 1 Watt (30dBm)

Per KDB 662911 D01 Multiple Transmitter Output Method of conducted output power measurement on IEEE 802.11 devices,

Array Gain = 0 dB (i.e., no array gain) for $NANT \leq 4$;

Array Gain = 0 dB (i.e., no array gain) for channel widths ≥ 40 MHz for any NANT;

Array Gain = $5 \log(NANT/NSS)$ dB or 3 dB, whichever is less for 20-MHz channel widths with $NANT \geq 5$.

For power measurements on all other devices: Array Gain = $10 \log(NANT/NSS)$ dB.

4.4.2 Test Setup

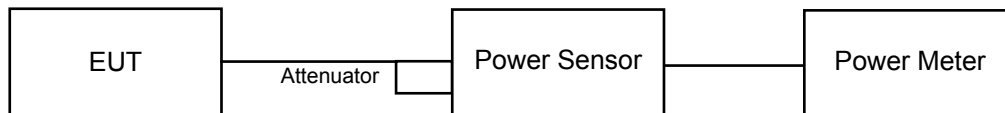

4.4.3 Test Instruments

Refer to section 4.1.2 to get information of above instrument.

4.4.4 Test Procedures

A average power sensor was used on the output port of the EUT. A power meter was used to read the response of the average power senso and set the detector to AVERAGE . Record the power level.

4.4.5 Deviation from Test Standard

No deviation.

4.4.6 EUT Operating Conditions

Same as Item 4.3.6.

4.4.7 Test Results

CDD Mode

802.11b

Channel	Frequency (MHz)	Average Power (dBm)			Total Power (mW)	Total Power (dBm)	Limit (dBm)	Pass / Fail
		Chain 0	Chain 1	Chain 2				
1	2412	22.90	22.64	23.56	605.624	27.82	30	Pass
6	2437	20.70	20.41	21.10	356.216	25.52	30	Pass
11	2462	20.26	20.20	20.69	328.103	25.16	30	Pass

802.11g

Channel	Frequency (MHz)	Average Power (dBm)			Total Power (mW)	Total Power (dBm)	Limit (dBm)	Pass / Fail
		Chain 0	Chain 1	Chain 2				
1	2412	18.98	18.80	18.68	228.716	23.59	30	Pass
6	2437	24.39	24.03	24.20	790.746	28.98	30	Pass
11	2462	18.30	18.27	18.18	200.517	23.02	30	Pass

VHT20

Channel	Frequency (MHz)	Average Power (dBm)			Total Power (mW)	Total Power (dBm)	Limit (dBm)	Pass / Fail
		Chain 0	Chain 1	Chain 2				
1	2412	18.81	18.70	18.63	223.11	23.49	30	Pass
6	2437	24.01	23.84	24.11	751.503	28.76	30	Pass
11	2462	18.87	18.72	18.97	230.449	23.63	30	Pass

VHT40

Channel	Frequency (MHz)	Average Power (dBm)			Total Power (mW)	Total Power (dBm)	Limit (dBm)	Pass / Fail
		Chain 0	Chain 1	Chain 2				
3	2422	18.03	17.78	17.62	181.322	22.58	30	Pass
6	2437	18.78	18.62	19.10	229.57	23.61	30	Pass
9	2452	17.40	17.28	17.14	160.171	22.05	30	Pass

Beamforming Mode

VHT20

Channel	Frequency (MHz)	Average Power (dBm)			Total Power (mW)	Total Power (dBm)	Limit (dBm)	Pass / Fail
		Chain 0	Chain 1	Chain 2				
1	2412	18.46	18.34	18.34	206.614	23.15	28.53	Pass
6	2437	22.64	22.48	22.72	547.733	27.39	28.53	Pass
11	2462	17.61	17.47	17.72	172.68	22.37	28.53	Pass

Note: Directional gain = 2.7dBi + 10log(3) = 7.47dBi > 6dBi , so the power limit shall be reduced to 30-(7.47-6) = 28.53dBm.

VHT40

Channel	Frequency (MHz)	Average Power (dBm)			Total Power (mW)	Total Power (dBm)	Limit (dBm)	Pass / Fail
		Chain 0	Chain 1	Chain 2				
3	2422	17.22	17.02	16.98	152.961	21.85	28.53	Pass
6	2437	17.96	17.86	18.31	191.375	22.82	28.53	Pass
9	2452	16.38	16.25	16.02	125.615	20.99	28.53	Pass

Note: Directional gain = 2.7dBi + 10log(3) = 7.47dBi > 6dBi , so the power limit shall be reduced to 30-(7.47-6) = 28.53dBm.

4.5 Power Spectral Density Measurement

4.5.1 Limits of Power Spectral Density Measurement

The Maximum of Power Spectral Density Measurement is 8dBm.

4.5.2 Test Setup

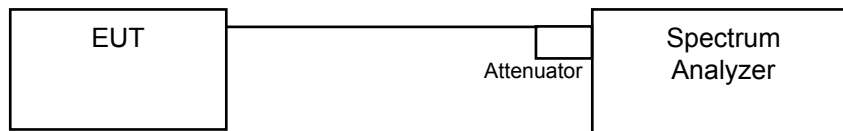

4.5.3 Test Instruments

Refer to section 4.1.2 to get information of above instrument.

4.5.4 Test Procedure

- a) Set instrument center frequency to DTS channel center frequency.
- b) Set span to at least 1.5 times the OBW.
- c) Set RBW to: $3 \text{ kHz} \leq \text{RBW} \leq 100 \text{ kHz}$.
- d) Set VBW $\geq 3 \times \text{RBW}$.
- e) Detector = power averaging (RMS) or sample detector (when RMS not available).
- f) Ensure that the number of measurement points in the sweep $\geq 2 \times \text{span}/\text{RBW}$.
- g) Sweep time = auto couple.
- h) Employ trace averaging (RMS) mode over a minimum of 100 traces.
- i) Use the peak marker function to determine the maximum amplitude level.

4.5.5 Deviation from Test Standard

No deviation.

4.5.6 EUT Operating Condition

Same as Item 4.3.6

4.5.7 Test Results

CDD Mode

802.11b

TX chain	Channel	Freq. (MHz)	PSD (dBm)	10 log (N=3) dB	Total PSD (dBm)	Limit (dBm)	Pass /Fail
0	1	2412	-5.39	4.77	-0.62	6.53	Pass
	6	2437	-6.92	4.77	-2.15	6.53	Pass
	11	2462	-7.38	4.77	-2.61	6.53	Pass
1	1	2412	-4.98	4.77	-0.21	6.53	Pass
	6	2437	-7.24	4.77	-2.47	6.53	Pass
	11	2462	-7.23	4.77	-2.46	6.53	Pass
2	1	2412	-4.98	4.77	-0.21	6.53	Pass
	6	2437	-7.38	4.77	-2.61	6.53	Pass
	11	2462	-7.50	4.77	-2.73	6.53	Pass

Note: 1. Directional gain = 2.7dBi + 10log(3) = 7.47dBi > 6dBi , so the power density limit shall be reduced to 8-(7.47-6) = 6.53dBm.

802.11g

TX chain	Channel	Freq. (MHz)	PSD (dBm)	10 log (N=3) dB	Total PSD (dBm)	Limit (dBm)	Pass /Fail
0	1	2412	-10.13	4.77	-5.36	6.53	Pass
	6	2437	-5.56	4.77	-0.79	6.53	Pass
	11	2462	-10.94	4.77	-6.17	6.53	Pass
1	1	2412	-10.22	4.77	-5.45	6.53	Pass
	6	2437	-6.05	4.77	-1.28	6.53	Pass
	11	2462	-11.28	4.77	-6.51	6.53	Pass
2	1	2412	-10.62	4.77	-5.85	6.53	Pass
	6	2437	-6.10	4.77	-1.33	6.53	Pass
	11	2462	-11.07	4.77	-6.30	6.53	Pass

Note: 1. Directional gain = 2.7dBi + 10log(3) = 7.47dBi > 6dBi , so the power density limit shall be reduced to 8-(7.47-6) = 6.53dBm.

VHT20

TX chain	Channel	Freq. (MHz)	PSD (dBm)	10 log (N=3) dB	Total PSD (dBm)	Limit (dBm)	Pass /Fail
0	1	2412	-11.34	4.77	-6.57	6.53	Pass
	6	2437	-6.77	4.77	-2.00	6.53	Pass
	11	2462	-11.06	4.77	-6.29	6.53	Pass
1	1	2412	-11.64	4.77	-6.87	6.53	Pass
	6	2437	-6.85	4.77	-2.08	6.53	Pass
	11	2462	-11.52	4.77	-6.75	6.53	Pass
2	1	2412	-11.82	4.77	-7.05	6.53	Pass
	6	2437	-7.12	4.77	-2.35	6.53	Pass
	11	2462	-11.93	4.77	-7.16	6.53	Pass

Note: 1. Directional gain = 2.7dBi + 10log(3) = 7.47dBi > 6dBi , so the power density limit shall be reduced to 8-(7.47-6) = 6.53dBm.

VHT40

TX chain	Channel	Freq. (MHz)	PSD (dBm)	10 log (N=3) dB	Total PSD (dBm)	Limit (dBm)	Pass /Fail
0	3	2422	-14.24	4.77	-9.47	6.53	Pass
	6	2437	-13.83	4.77	-9.06	6.53	Pass
	9	2452	-14.81	4.77	-10.04	6.53	Pass
1	3	2422	-12.83	4.77	-8.06	6.53	Pass
	6	2437	-13.78	4.77	-9.01	6.53	Pass
	9	2452	-14.78	4.77	-10.01	6.53	Pass
2	3	2422	-15.44	4.77	-10.67	6.53	Pass
	6	2437	-14.41	4.77	-9.64	6.53	Pass
	9	2452	-15.30	4.77	-10.53	6.53	Pass

Note: 1. Directional gain = 2.7dBi + 10log(3) = 7.47dBi > 6dBi , so the power density limit shall be reduced to 8-(7.47-6) = 6.53dBm.

Spectrum Plot of Worst Value

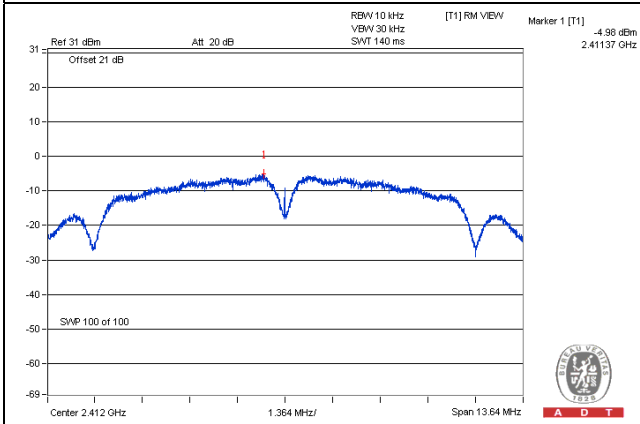
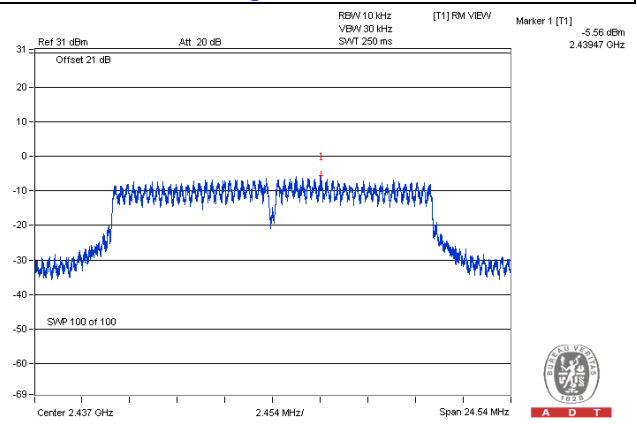
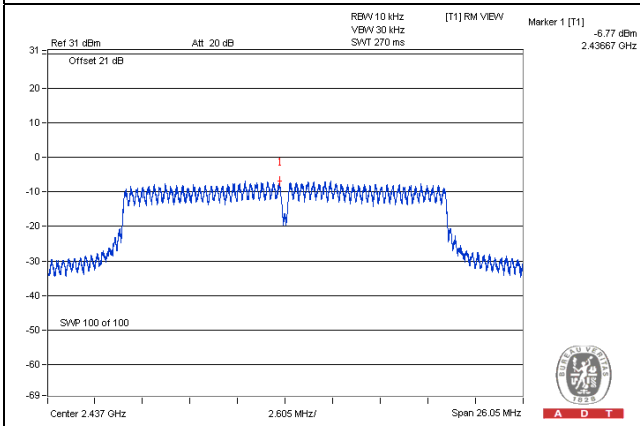
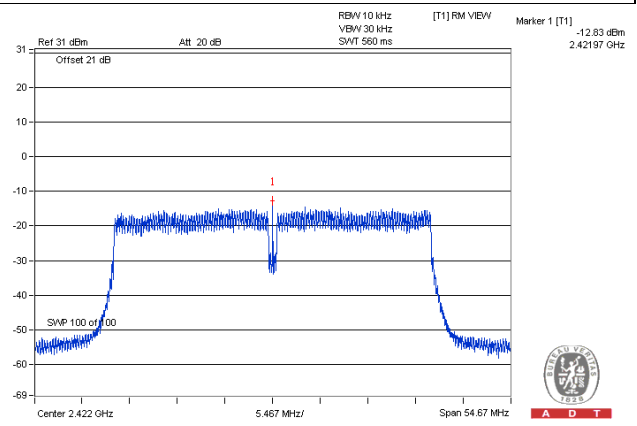
802.11b – Chain 2: CH 1**802.11g – Chain 0: CH 6****VHT20 – Chain 0: CH 6****VHT40 – Chain 1: CH 3**

4.6 Conducted Out of Band Emission Measurement

4.6.1 Limits of Conducted Out of Band Emission Measurement

Below 30dB of the highest emission level of operating band (in 100kHz Resolution Bandwidth).

4.6.2 Test Setup

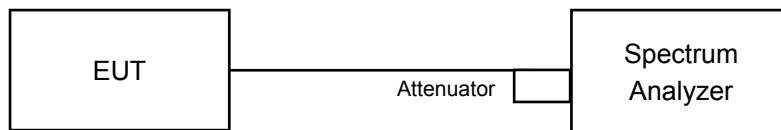

4.6.3 Test Instruments

Refer to section 4.1.2 to get information of above instrument.

4.6.4 Test Procedure

MEASUREMENT PROCEDURE REF

1. Set the RBW = 100 kHz.
2. Set the VBW \geq 300 kHz.
3. Detector = peak.
4. Sweep time = auto couple.
5. Trace mode = max hold.
6. Allow trace to fully stabilize.
7. Use the peak marker function to determine the maximum power level in any 100 kHz band segment within the fundamental EBW.

MEASUREMENT PROCEDURE OOB

1. Set RBW = 100 kHz.
2. Set VBW \geq 300 kHz.
3. Detector = peak.
4. Sweep = auto couple.
5. Trace Mode = max hold.
6. Allow trace to fully stabilize.
7. Use the peak marker function to determine the maximum amplitude level.

4.6.5 Deviation from Test Standard

No deviation.

4.6.6 EUT Operating Condition

Same as Item 4.3.6

4.6.7 Test Results

The spectrum plots are attached on the following pages. D1 line indicates the highest level, and D2 line indicates the 30dB offset below D1. It shows compliance with the requirement.

CDD Mode
802.11b

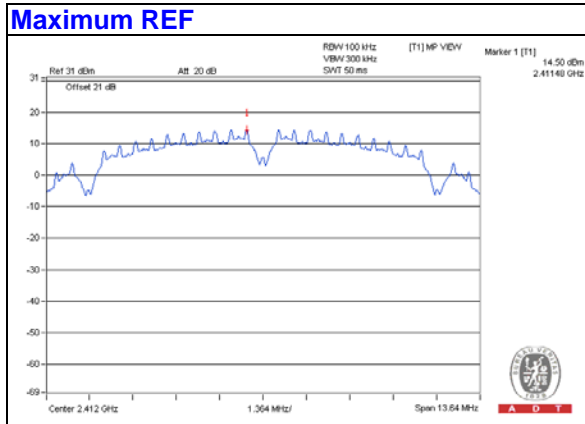

Chain 0
CH 1

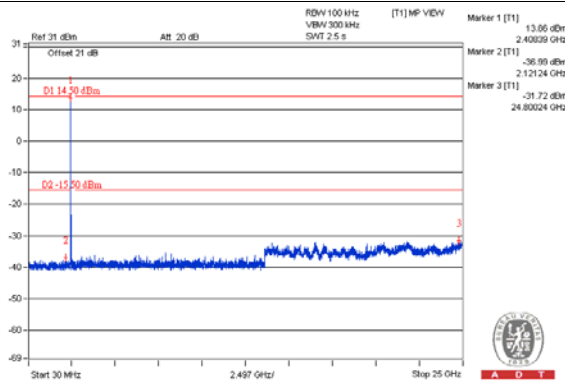

CH 6

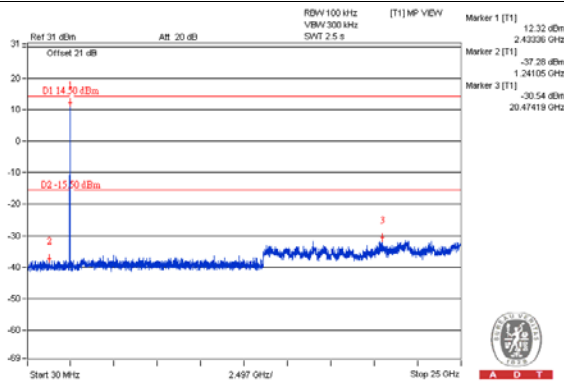

CH 11

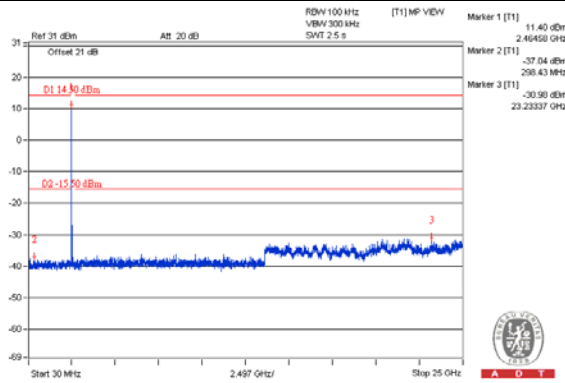

CH 1 Band edge

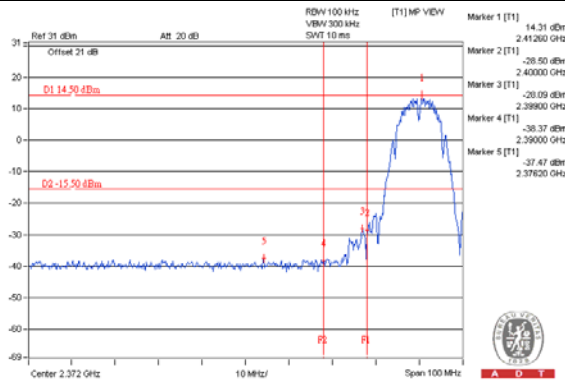

CH 11 Band edge

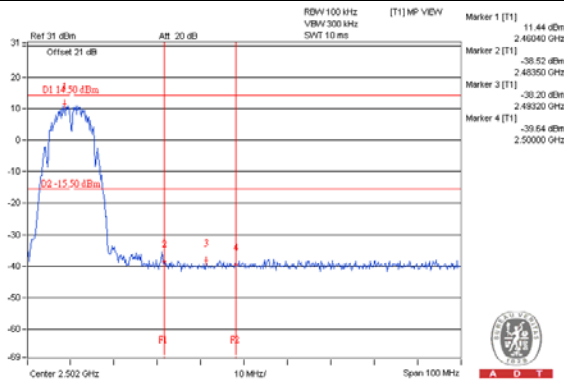

Chain 1

CH 1

CH 6

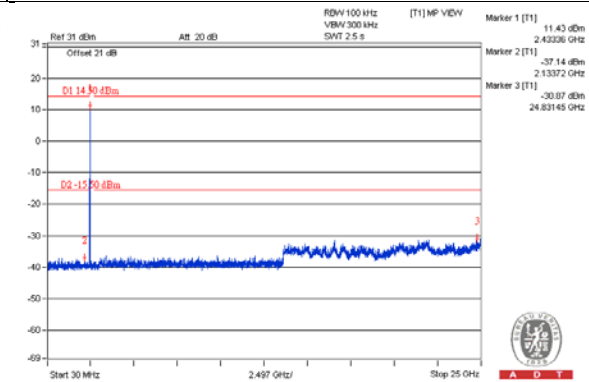
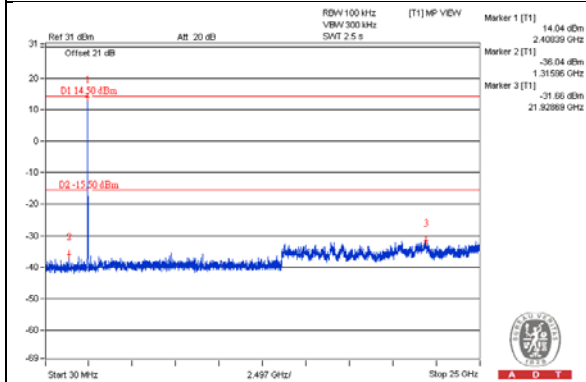

CH 11

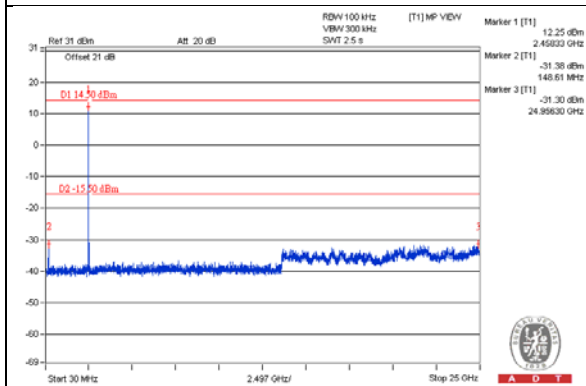

CH 1 Band edge

CH 11 Band edge

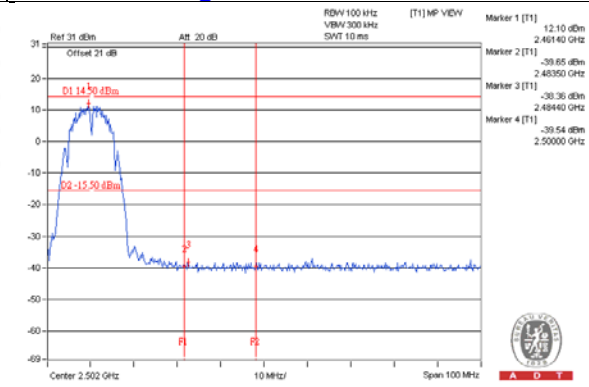
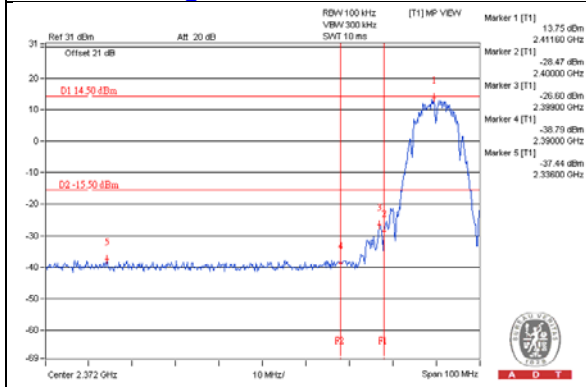

Chain 2

CH 1

CH 6

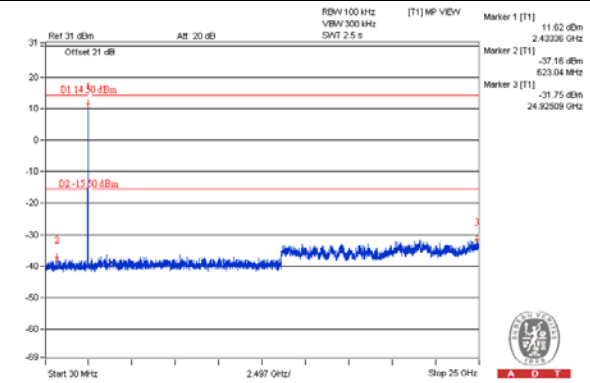
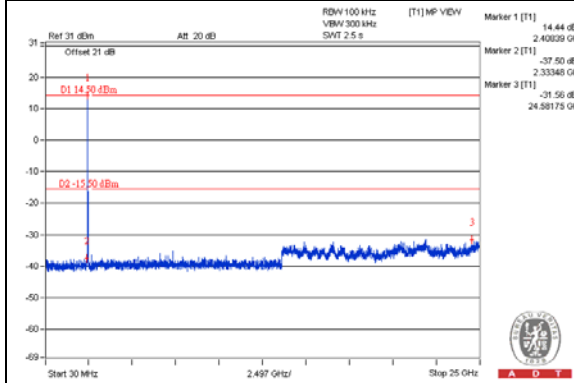

CH 11

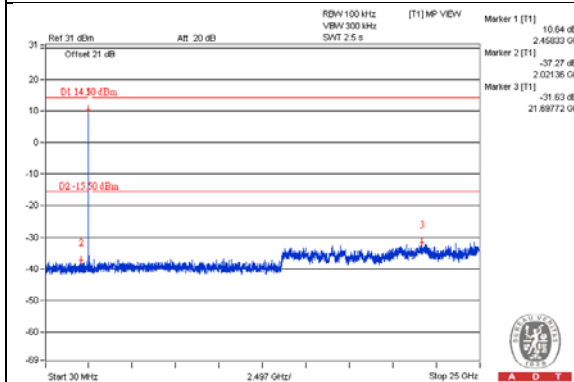

CH 1 Band edge

CH 11 Band edge

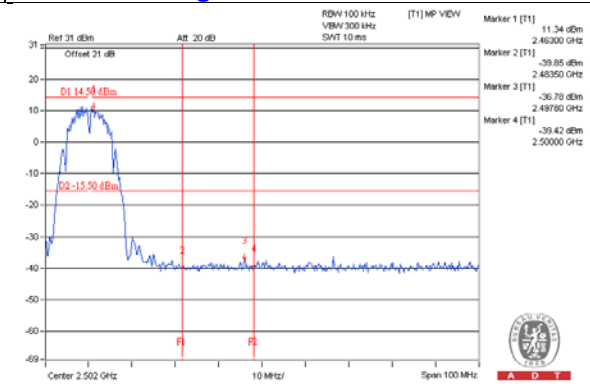
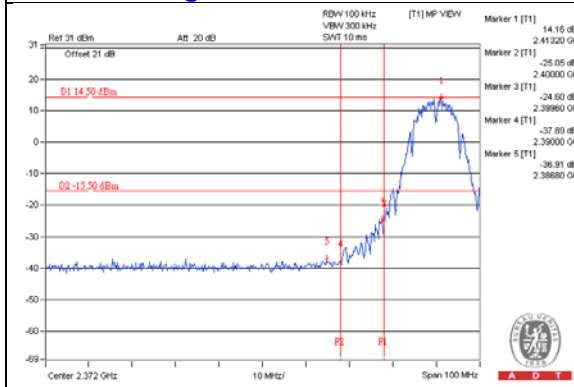

802.11g

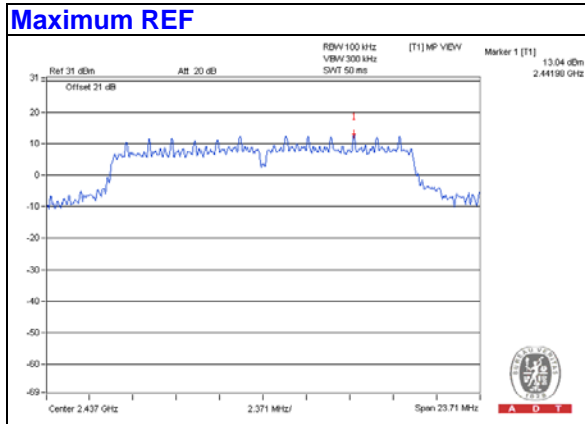

Chain 0

CH 1

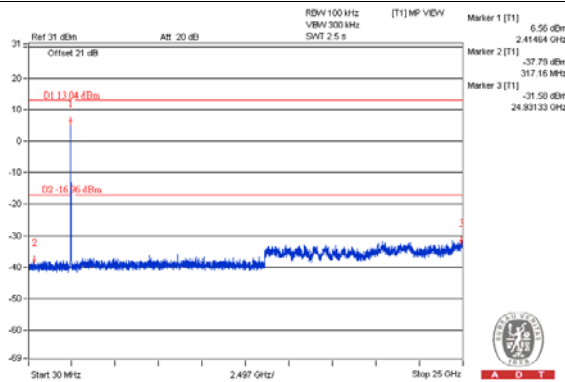

CH 6

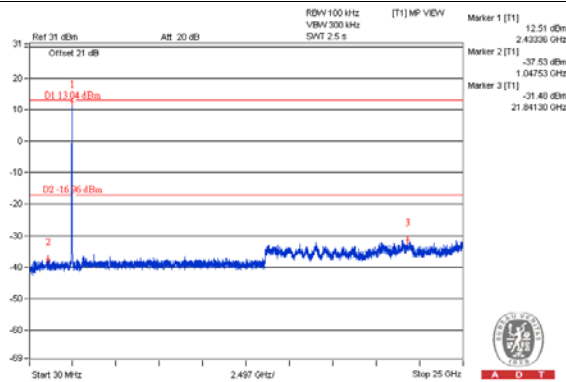

CH 11

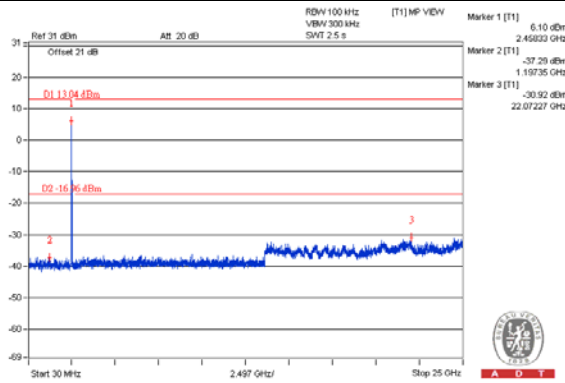

CH 1 Band edge

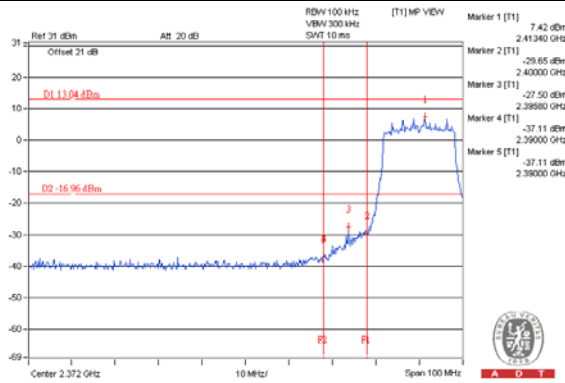

CH 11 Band edge

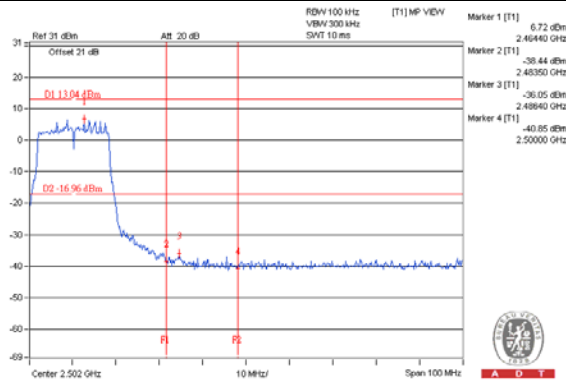

Chain 1

CH 1

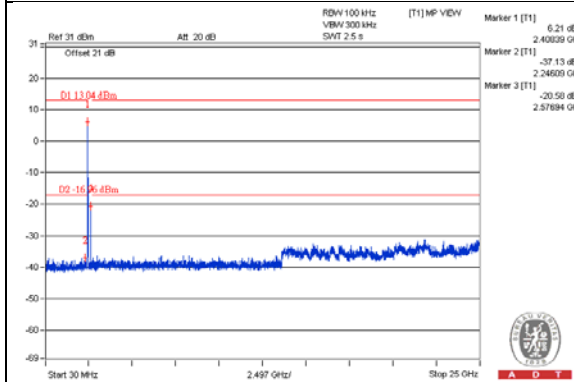

CH 6

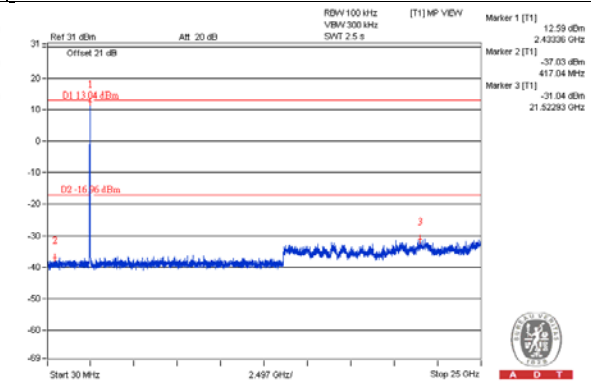

CH 11

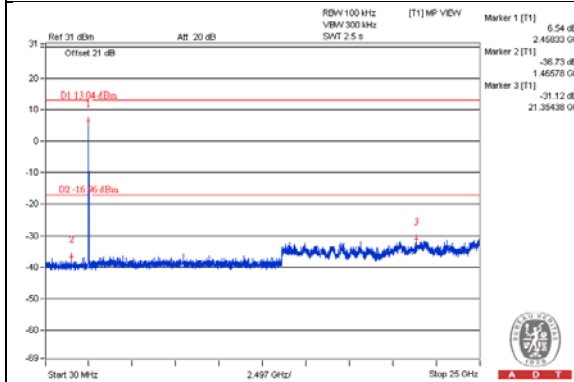

CH 1 Band edge

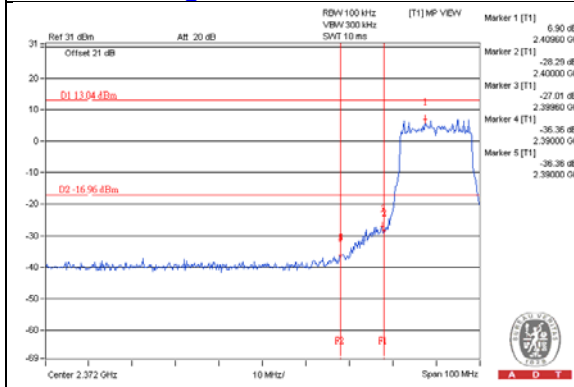

CH 11 Band edge

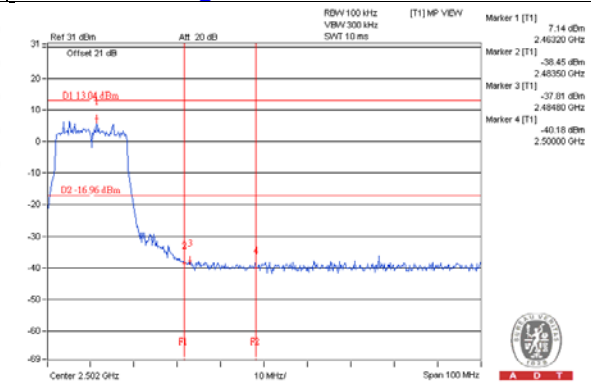

Chain 2

CH 1

CH 6

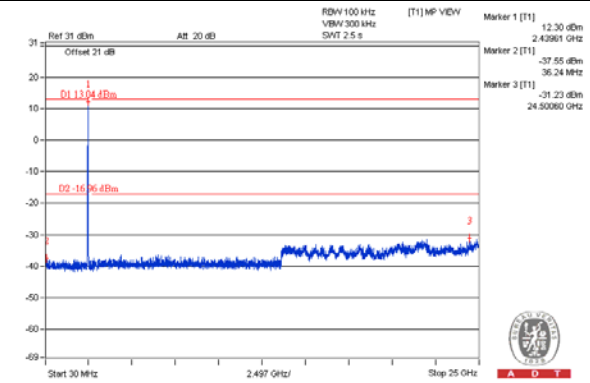
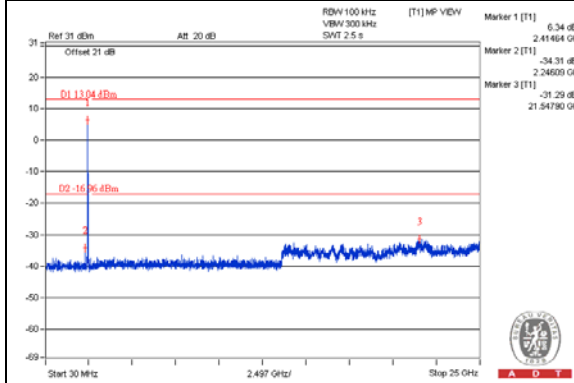

CH 11

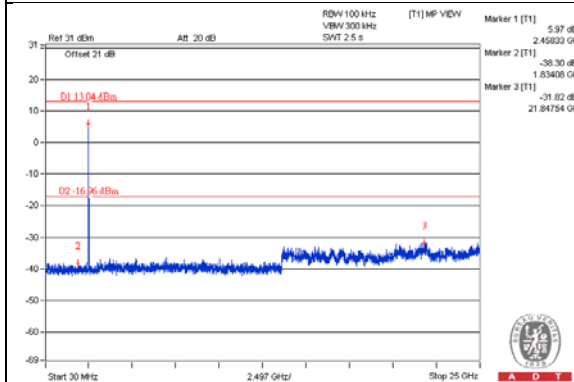

CH 1 Band edge

CH 11 Band edge

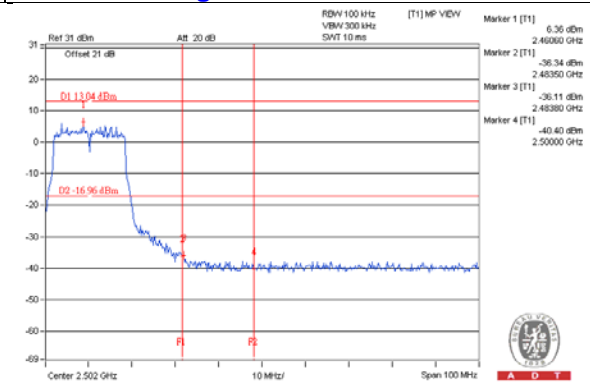
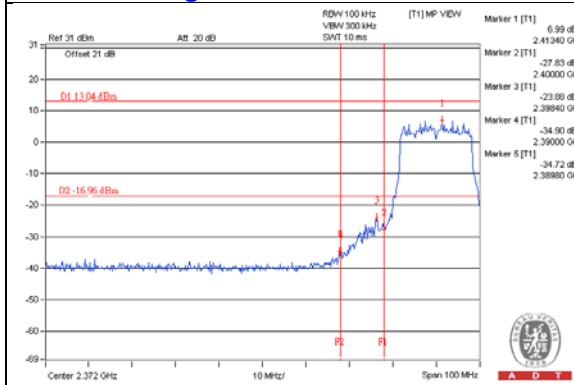

VHT20

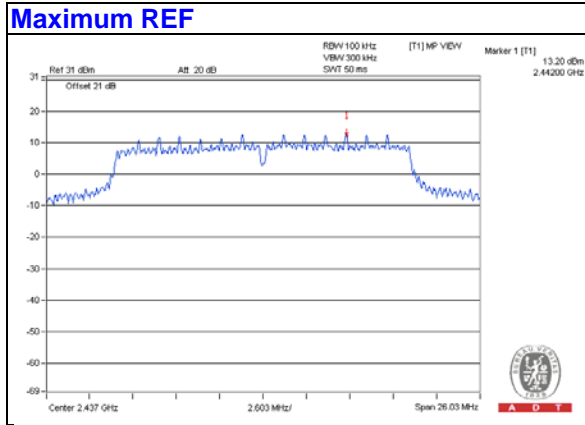

Chain 0

CH 1

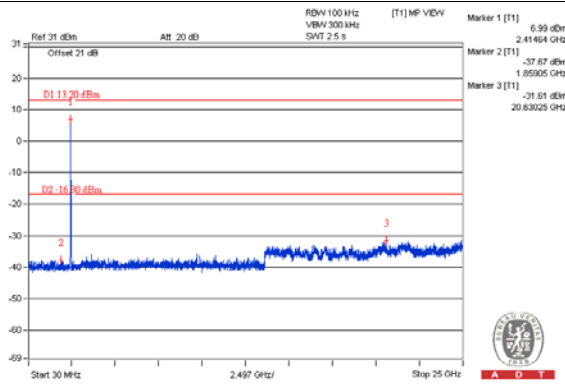

CH 6

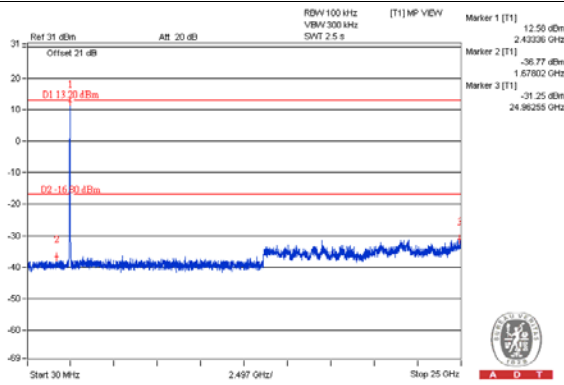

CH 11

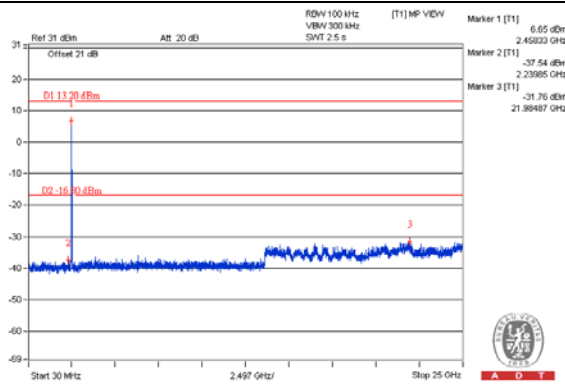

CH 1 Band edge

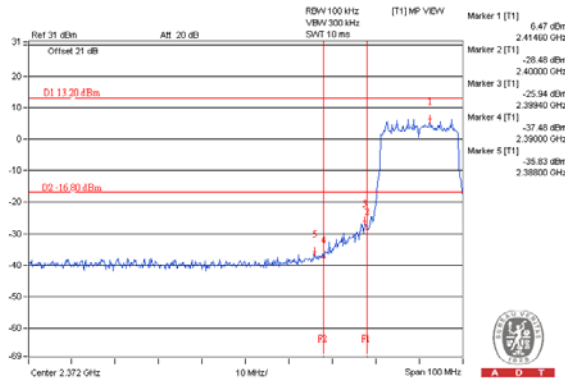

CH 11 Band edge

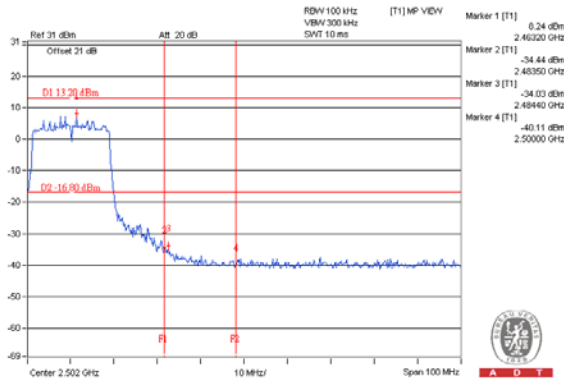

Chain 1

CH 1

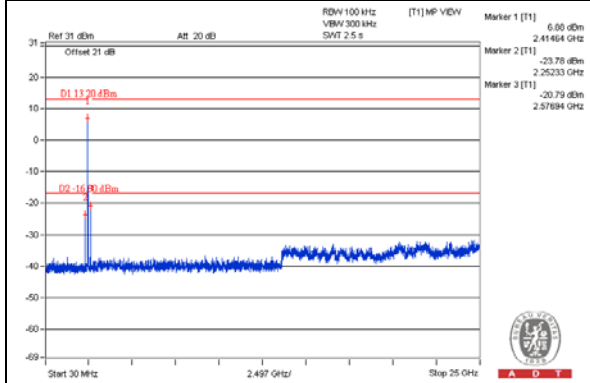

CH 6

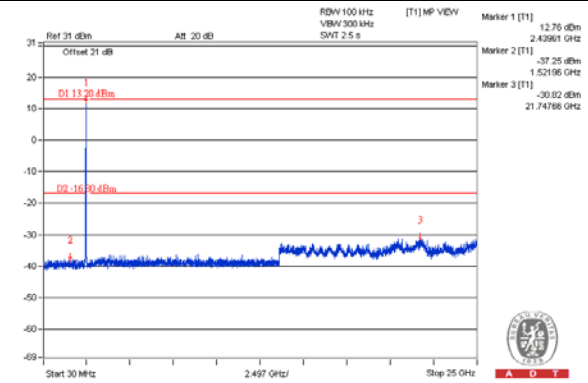

CH 11

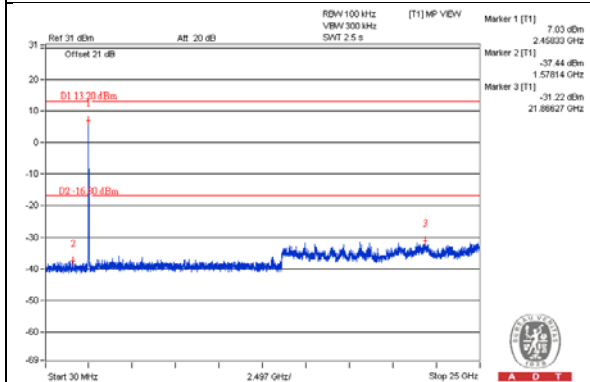

CH 1 Band edge

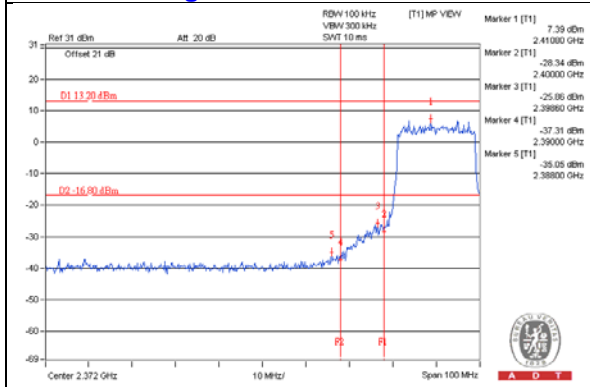

CH 11 Band edge

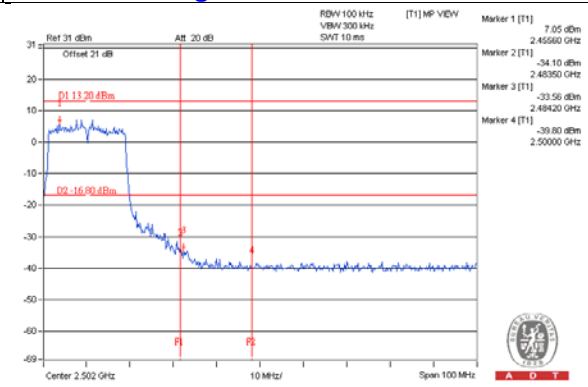

Chain 2

CH 1

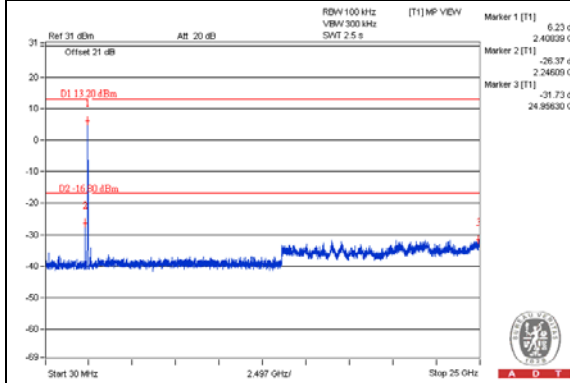

CH 6

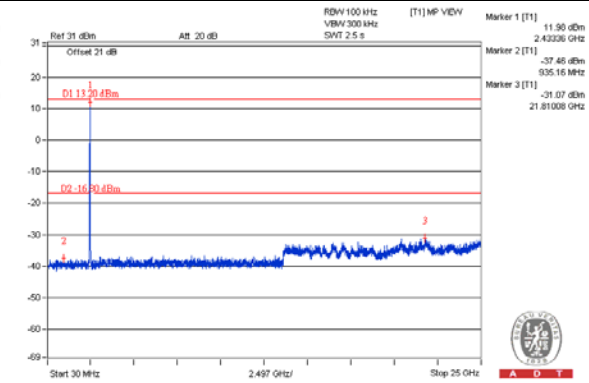

CH 11

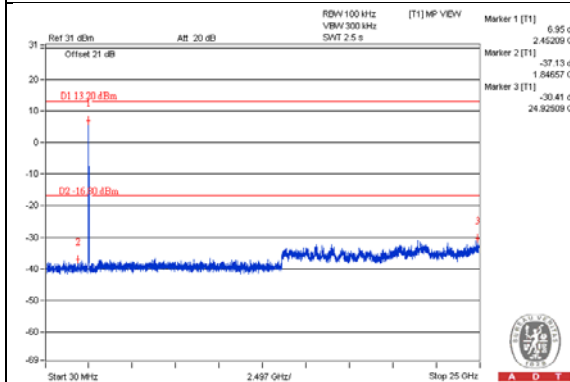

CH 11 Band edge

CH 1 Band edge

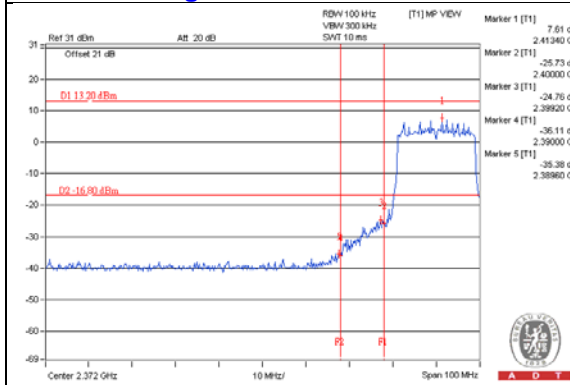

CH 11 Band edge

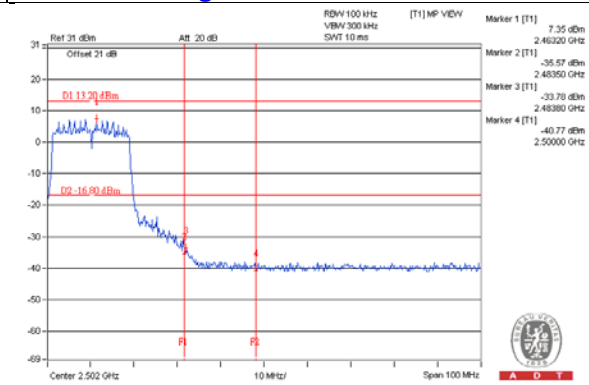

VHT40

Maximum REF

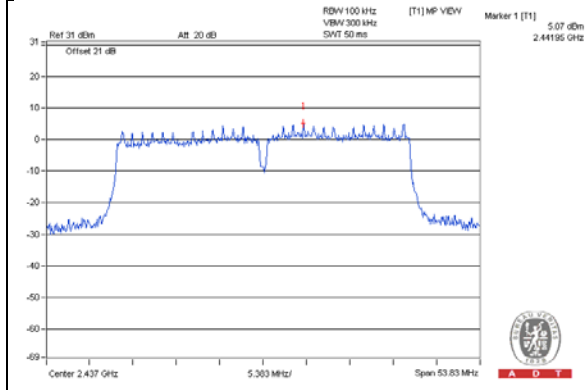

Chain 0

CH 3

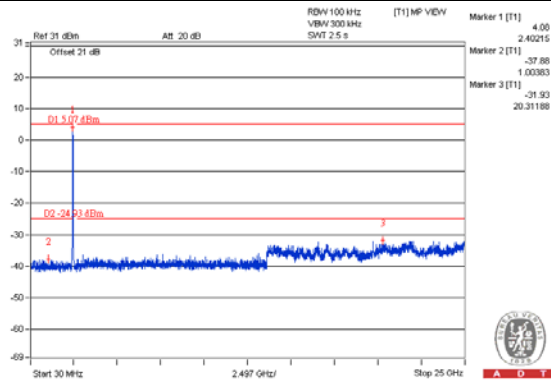

CH 6

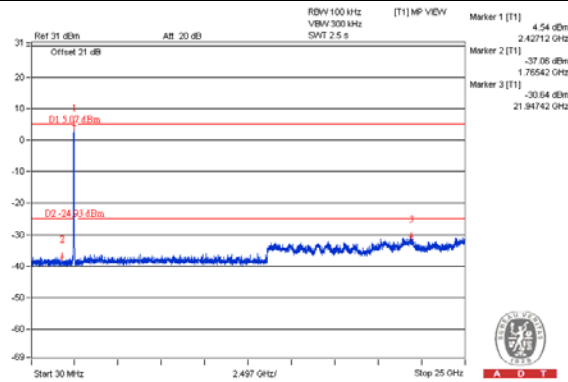

CH 9

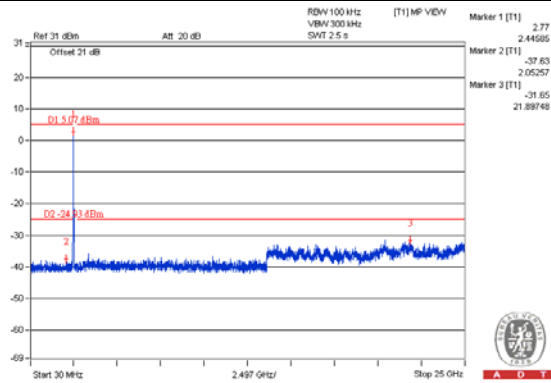

CH 3 Band edge

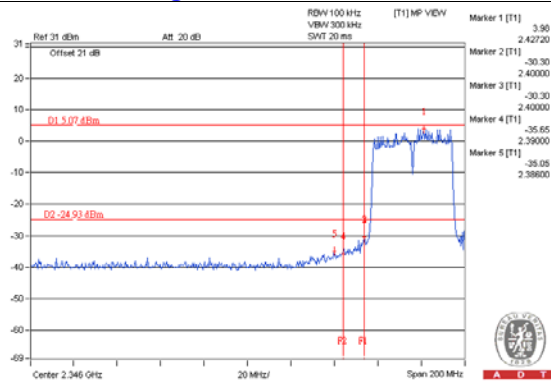

CH 9 Band edge

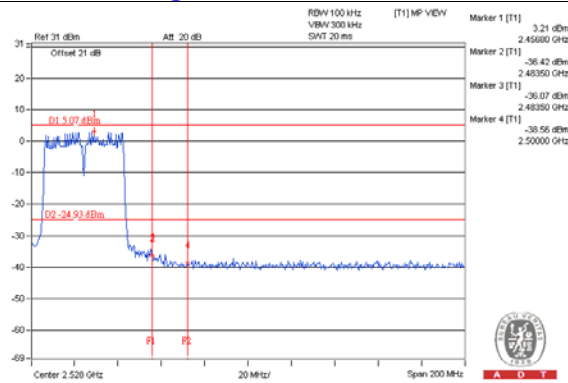

Chain 1
CH 3

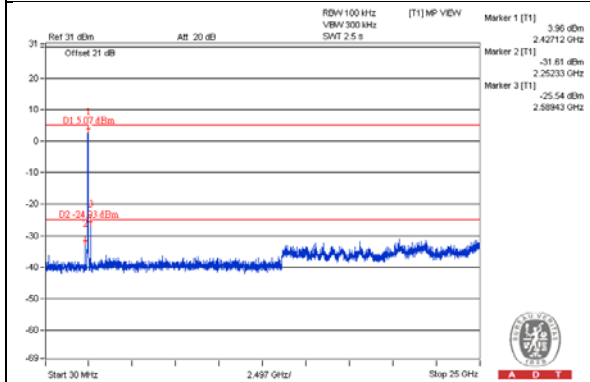

CH 6

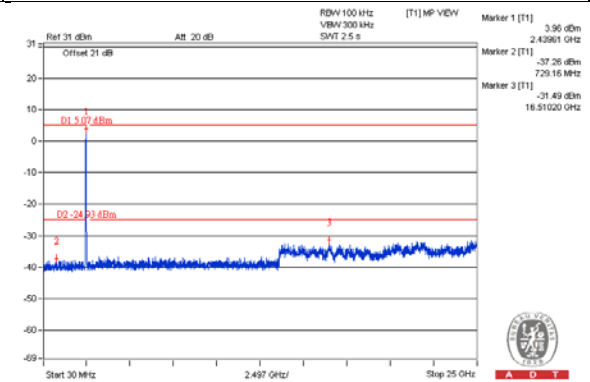

CH 9

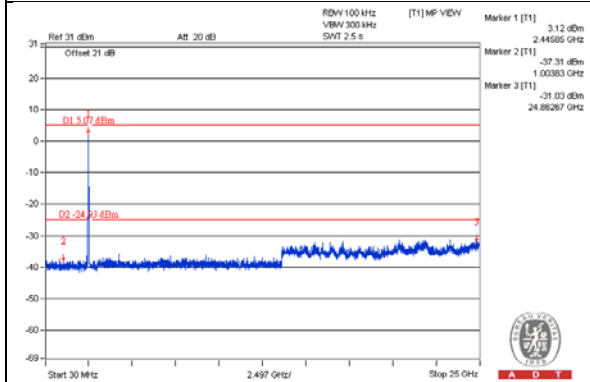

CH 9 Band edge

CH 3 Band edge

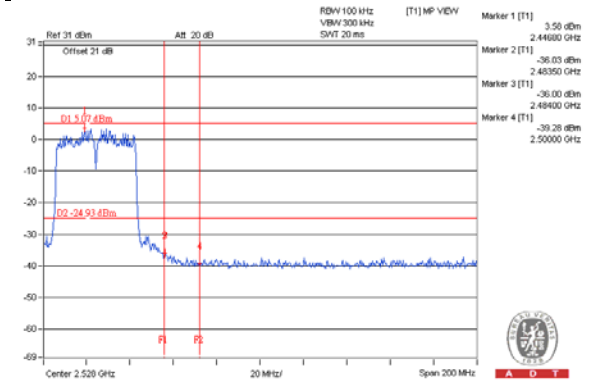
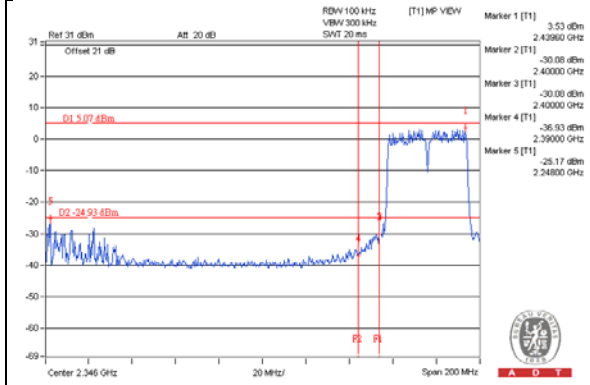

Chain 2

CH 3

CH 6

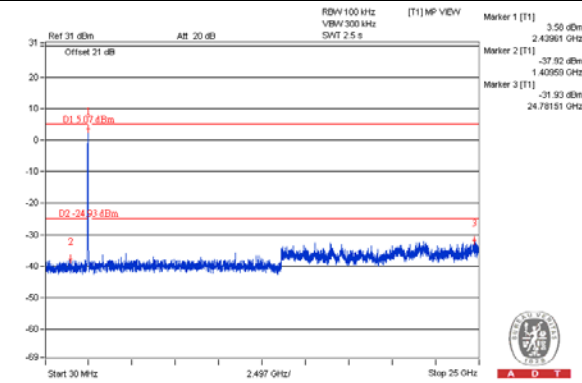
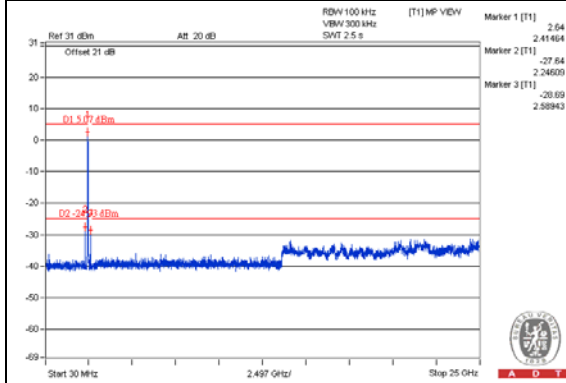

CH 9

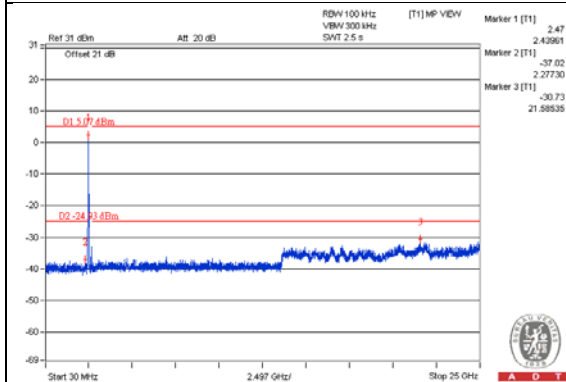

CH 3 Band edge

CH 9 Band edge

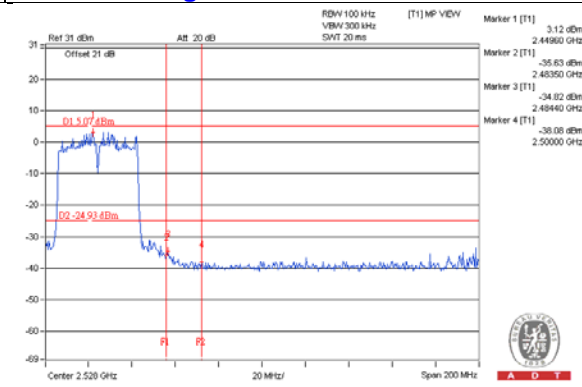
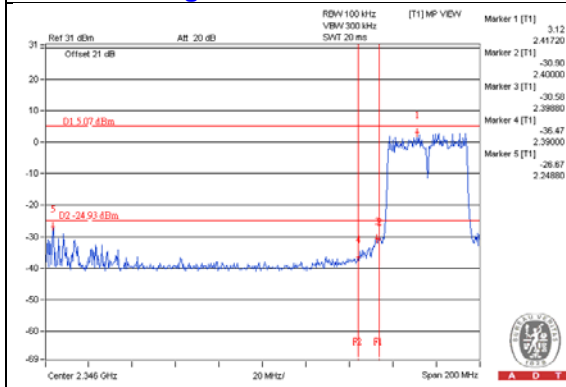

5 Pictures of Test Arrangements

Please refer to the attached file (Test Setup Photo).



Appendix – Information on the Testing Laboratories

We, Bureau Veritas Consumer Products Services (H.K.) Ltd., Taoyuan Branch, were founded in 1988 to provide our best service in EMC, Radio, Telecom and Safety consultation. Our laboratories are accredited and approved according to ISO/IEC 17025.

If you have any comments, please feel free to contact us at the following:

Linko EMC/RF Lab

Tel: 886-2-26052180

Fax: 886-2-26051924

Hsin Chu EMC/RF/Telecom Lab

Tel: 886-3-5935343

Fax: 886-3-5935342

Hwa Ya EMC/RF/Safety Lab

Tel: 886-3-3183232

Fax: 886-3-3270892

Email: service.adt@tw.bureauveritas.com

Web Site: www.bureauveritas-adt.com

The address and road map of all our labs can be found in our web site also.

--- END ---