



FCC Radio Test Report

FCC ID: W59XAP1500

This report concerns (check one): Original Grant Class II Change

Issued Date : Nov. 06, 2013
Project No. : 1310C127
Equipment : High Power Dual Band Wireless 900N
Low Profile Access Point
Model Name : XAP-1500
Applicant : Luxul Wireless
Address : 14203 Minuteman Drive, Suite 201,
Draper, UT USA

Tested by: Neutron Engineering Inc. EMC Laboratory

Date of Receipt: Oct. 22, 2013

Date of Test: Oct. 22, 2013~ Nov. 05, 2013

Testing Engineer : David Mao
(David Mao)
Technical Manager : Leo Hung
(Leo Hung)
Authorized Signatory : Steven Lu
(Steven Lu)

Neutron Engineering Inc.

No.3, Jinshagang 1st Road, ShiXia,

Dalang Town, Dong Guan, China.

TEL: 0769-8318-3000

FAX: 0769-8319-6000



Declaration

Neutron represents to the client that testing is done in accordance with standard procedures as applicable and that test instruments used has been calibrated with the standards traceable to National Measurement Laboratory (NML) of **CHINA**, or National Institute of Standards and Technology (**NIST**) of **U.S.A.**

Neutron's reports apply only to the specific samples tested under conditions. It is manufacture's responsibility to ensure that additional production units of this model are manufactured with the identical electrical and mechanical components. **Neutron** shall have no liability for any declarations, inferences or generalizations drawn by the client or others from **Neutron** issued reports.

Neutron's reports must not be used by the client to claim product endorsement by the authorities or any agency of the Government.

This report is the confidential property of the client. As a mutual protection to the clients, the public and **Neutron-self**, extracts from the test report shall not be reproduced except in full with **Neutron's** authorized written approval.

Neutron's laboratory quality assurance procedures are in compliance with the **ISO Guide 17025** requirements, and accredited by the conformity assessment authorities listed in this test report.

Limitation

For the use of the authority's logo is limited unless the Test Standard(s)/Scope(s)/Item(s) mentioned in this test report is (are) included in the conformity assessment authorities acceptance respective.



Table of Contents	Page
1 . CERTIFICATION	6
2 . SUMMARY OF TEST RESULTS	7
2.1 TEST FACILITY	8
2.2 MEASUREMENT UNCERTAINTY	8
3 . GENERAL INFORMATION	9
3.1 GENERAL DESCRIPTION OF EUT	9
3.2 DESCRIPTION OF TEST MODES	11
3.3 TABLE OF PARAMETERS OF TEXT SOFTWARE SETTING	12
3.4 BLOCK DIGRAM SHOWING THE CONFIGURATION OF SYSTEM TESTED	13
3.5 DESCRIPTION OF SUPPORT UNITS	14
4 . EMC EMISSION TEST	15
4.1 CONDUCTED EMISSION MEASUREMENT	15
4.1.1 POWER LINE CONDUCTED EMISSION LIMITS	15
4.1.2 MEASUREMENT INSTRUMENTS LIST AND SETTING	15
4.1.3 TEST PROCEDURE	16
4.1.4 DEVIATION FROM TEST STANDARD	16
4.1.5 TEST SETUP	16
4.1.6 EUT OPERATING CONDITIONS	16
4.1.7 TEST RESULTS	17
4.2 RADIATED EMISSION MEASUREMENT	20
4.2.1 RADIATED EMISSION LIMITS	20
4.2.2 MEASUREMENT INSTRUMENTS LIST ANS SETTING	21
4.2.3 TEST PROCEDURE	21
4.2.4 DEVIATION FROM TEST STANDARD	21
4.2.5 TEST SETUP	22
4.2.6 EUT OPERATING CONDITIONS	23
4.2.7 TEST RESULTS (BETWEEN 30 – 1000 MHZ)	24
4.2.8 TEST RESULTS (ABOVE 1000 MHZ)	31
5 . BANDWIDTH TEST	63
5.1 APPLIED PROCEDURES / LIMIT	63
5.1.1 MEASUREMENT INSTRUMENTS LIST	63
5.1.2 TEST PROCEDURE	63
5.1.3 DEVIATION FROM STANDARD	63
5.1.4 TEST SETUP	63
5.1.5 EUT OPERATION CONDITIONS	63
5.1.6 TEST RESULTS	64
6 . MAXIMUM OUTPUT POWER TEST	70



Table of Contents	Page
6.1 APPLIED PROCEDURES / LIMIT	70
6.1.1 MEASUREMENT INSTRUMENTS LIST	70
6.1.2 TEST PROCEDURE	70
6.1.3 DEVIATION FROM STANDARD	70
6.1.4 TEST SETUP	70
6.1.5 EUT OPERATION CONDITIONS	70
6.1.6 TEST RESULTS	71
7 . ANTENNA CONDUCTED SPURIOUS EMISSION	74
7.1 APPLIED PROCEDURES / LIMIT	74
7.1.1 MEASUREMENT INSTRUMENTS LIST	74
7.1.2 TEST PROCEDURE	74
7.1.3 DEVIATION FROM STANDARD	74
7.1.4 TEST SETUP	75
7.1.5 EUT OPERATION CONDITIONS	75
7.1.6 TEST RESULTS	76
8 . POWER SPECTRAL DENSITY TEST	108
8.1 APPLIED PROCEDURES / LIMIT	108
8.1.1 MEASUREMENT INSTRUMENTS LIST	108
8.1.2 TEST PROCEDURE	108
8.1.3 DEVIATION FROM STANDARD	108
8.1.4 TEST SETUP	108
8.1.5 EUT OPERATION CONDITIONS	108
8.1.6 TEST RESULTS	109
9 . EUT TEST PHOTO	125



REPORT ISSUED HISTORY

Issued No.	Description	Issued Date
NEI-FCCP-3-1310C127	Original Issue.	Nov. 06, 2013



1. CERTIFICATION

Equipment : High Power Dual Band Wireless 900N Low Profile Access Point
Brand Name : Luxul Xen™
Model Name : XAP-1500
Applicant : Luxul Wireless
Date of Test : Oct. 22, 2013~ Nov. 05, 2013
Test Item : ENGINEERING SAMPLE
Standard(s) : FCC Part15, Subpart C(15.247) / ANSI C63.4-2009

The above equipment has been tested and found compliance with the requirement of the relative standards by Neutron Engineering Inc. EMC Laboratory.

The test data, data evaluation, and equipment configuration contained in our test report (Ref No. NEI-FCCP-3-1310C127) were obtained utilizing the test procedures, test instruments, test sites that has been accredited by the Authority of TAF according to the ISO-17025 quality assessment standard and technical standard(s).

Test result included in this report is only for the 5745~5825MHz part of the product.



2. SUMMARY OF TEST RESULTS

Test procedures according to the technical standard(s):

Applied Standard(s): FCC Part15 (15.247) , Subpart C				
Standard(s)	Section	Test Item	Judgment	Remark
15.207		Conducted Emission	PASS	
15.247(d)		Antenna conducted Spurious Emission	PASS	
15.247(a)(2)		6dB Bandwidth	PASS	
15.247(b)(3)		Peak Output Power	PASS	
15.247(e)		Power Spectral Density	PASS	
15.203		Antenna Requirement	PASS	
15.209/15.205		Transmitter Radiated Emissions	PASS	

NOTE:

- (1) " N/A" denotes test is not applicable in this test report.
- (2) The test follows FCC KDB Publication No. 558074 D01 DTS Meas Guidance v03r01 (Measurement Guidelines of DTS)



2.1 TEST FACILITY

The test facilities used to collect the test data in this report is **DG-C02/DG-CB03** at the location of No.3, Jinshagang 1st Road, ShiXia, Dalang Town, Dong Guan, China.523792
 Neutron's test firm number for FCC: 319330

2.2 MEASUREMENT UNCERTAINTY

Where relevant, the following measurement uncertainty levels have been estimated for tests performed on the EUT as specified in CISPR 16-4-2:

The reported uncertainty of measurement $y \pm U$ where expanded uncertainty U is based on a standard uncertainty multiplied by a coverage factor of $k=2$, providing a level of confidence of approximately 95 %.

A. Conducted Measurement :

Test Site	Method	Measurement Frequency Range	U , (dB)	NOTE
DG-C02	CISPR	150 KHz ~ 30MHz	1.94	

B. Radiated Measurement :

Test Site	Method	Measurement Frequency Range	Ant. H / V	U , (dB)	NOTE
DG-CB03	CISPR	9KHz~30MHz	V	3.79	
		9KHz~30MHz	H	3.57	
		30MHz ~ 200MHz	V	3.82	
		30MHz ~ 200MHz	H	3.60	
		200MHz ~ 1,000MHz	V	3.86	
		200MHz ~ 1,000MHz	H	3.94	
		1GHz~18GHz	V	3.12	
		1GHz~18GHz	H	3.68	
		18GHz~40GHz	V	4.15	
		18GHz~40GHz	H	4.14	



3. GENERAL INFORMATION

3.1 GENERAL DESCRIPTION OF EUT

Equipment	High Power Dual Band Wireless 900N Low Profile Access Point	
Brand Name	Luxul Xen™	
Model Name	XAP-1500	
Model Different	N/A	
Product Description	Operation Frequency	5745~5825 MHz
	Modulation Technology	802.11a/n:OFDM
	Bit Rate of Transmitter	900Mbps
	Number of Channel	5 CH, Please see note 2.(Page 10)
	Antenna Designation	Please see note 3.(Page 10)
	Antenna Gain(Peak)	
	Output Power (Max.)	802.11a: 22.70dBm 802.11n (20M): 27.46dBm 802.11n (40M): 27.64dBm
More details of EUT technical specification, please refer to the User's Manual.		
Power Source	PoE Power Supply. Manufacturer: Fo Shan Great Power Co., Ltd Model: GRT-480125A	
Power Rating	I/P: AC 100-240V~50/60Hz O/P: DC 48V 1250mA	
Connecting I/O Port(s)	Please refer to the User's Manual.	

Note:

1. For a more detailed features description, please refer to the manufacturer's specifications or the User's Manual.



2.

802.11a / 802.11n 20M					
Channel	Frequency (MHz)	Channel	Frequency (MHz)	Channel	Frequency (MHz)
149	5745	153	5765	157	5785
161	5805	165	5825		

802.11n 40M			
Channel	Frequency (MHz)	Channel	Frequency (MHz)
151	5755	159	5795

3. Antenna Specification:

Ant.	Manufacturer	Model Name	Antenna Type	Connector	Gain (dBi)
0		Q5078	Internal Antenna	N/A	5.0
1		Q5078	Internal Antenna	N/A	5.0
2		Q5078	Internal Antenna	N/A	5.0

Note:

The EUT incorporates a MIMO function. Physically, the EUT provides three completed transmitters and three receivers (3T3R). all transmit signals are completely uncorrelated, then, Direction gain = GANT, that is Directional gain=5.0dBi

4.

Operating Mode	1TX	3TX
802.11a	V (ANT 0 or ANT 1 or ANT 2)	-
802.11n(20MHz)	-	V (ANT 0 + ANT 1 + ANT 2)
802.11n(40MHz)	-	V (ANT 0 + ANT 1 + ANT 2)



3.2 DESCRIPTION OF TEST MODES

To investigate the maximum EMI emission characteristics generates from EUT, the test system was pre-scanning tested base on the consideration of following EUT operation mode or test configuration mode which possible have effect on EMI emission level. Each of these EUT operation mode(s) or test configuration mode(s) mentioned above was evaluated respectively.

Pretest Mode	Description
Mode 1	TX A Mode Channel 149/157/165
Mode 2	TX N20 Mode Channel 149/157/165
Mode 3	TX N40 Mode Channel 151/159
Mode 7	TX Mode

The EUT system operated these modes were found to be the worst case during the pre-scanning test as following:

For Conducted Test	
Final Test Mode	Description
Mode 7	TX Mode

For Radiated Test	
Final Test Mode	Description
Mode 1	TX A Mode Channel 149/157/165
Mode 2	TX N20 Mode Channel 149/157/165
Mode 3	TX N40 Mode Channel 151/159

Note: For radiated below 1G test, the 802.11a mode is found to be the worst case and recorded.



3.3 TABLE OF PARAMETERS OF TEXT SOFTWARE SETTING

During testing channel & power controlling software provided by the customer was used to control the operating channel as well as the output power level. The RF output power selection is for the setting of RF output power expected by the customer and is going to be fixed on the firmware of the final end product

Test software version	MTool_2.0.0.3		
Frequency	5745 MHz	5785 MHz	5825MHz
TX A Mode	64	64	64
TX N20 Mode	42	46	46

Test software version	MTool_2.0.0.3	
Frequency	5745 MHz	5825MHz
TX N40 Mode	60	62



3.4 BLOCK DIGRAM SHOWING THE CONFIGURATION OF SYSTEM TESTED

Conducted TX Mode:

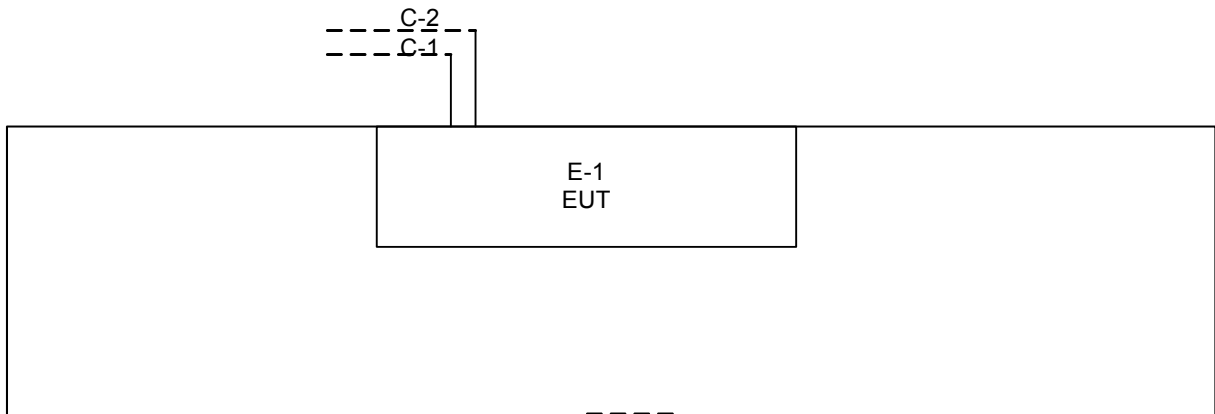

Control Room

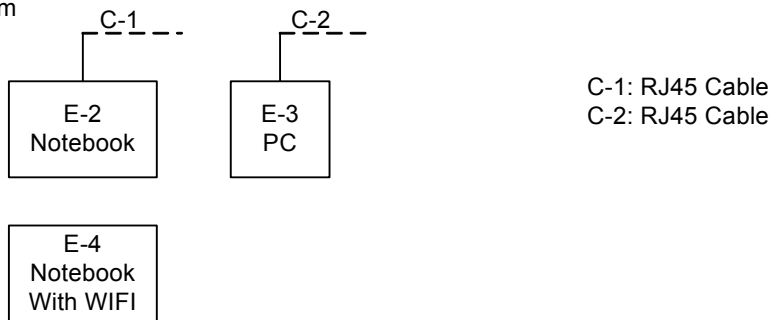

Radiated TX Mode:

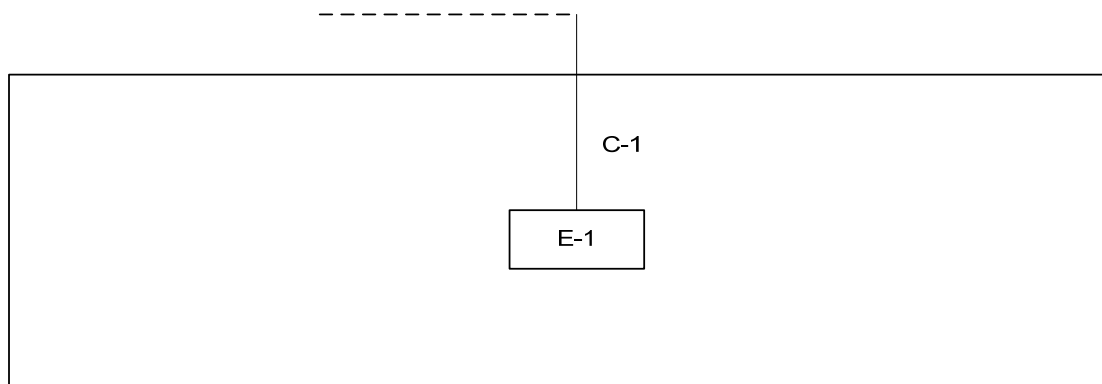

Control Room

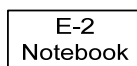

C-1: RJ45 Cable



3.5 DESCRIPTION OF SUPPORT UNITS

The EUT has been tested as an independent unit together with other necessary accessories or support units. The following support units or accessories were used to form a representative test configuration during the tests.

Item	Equipment	Mfr/Brand	Model/Type No.	FCC ID	Series No.	Note
E-1	High Power Dual Band Wireless 900N Low Profile Access Point	Luxul Xen™	XAP-1500	W59XAP1500	N/A	EUT
E-2	Notebook	Dell	INSPIRON 1420	DOC	JX193A01SD C2	
E-3	PC	Dell	745	DOC	J8K832X	
E-4	Notebook	ASUS	F9Eseries	DOC	7AN0AS3013 31	

Item	Shielded Type	Ferrite Core	Length	Note
C-1	NO	NO	10m	
C-2	NO	NO	10m	

Note:

- (1) For detachable type I/O cable should be specified the length in m in 『Length』 column.



4. EMC EMISSION TEST

4.1 CONDUCTED EMISSION MEASUREMENT

4.1.1 POWER LINE CONDUCTED EMISSION Limits (Frequency Range 150KHz-30MHz)

FREQUENCY (MHz)	Class A (dBuV)		Class B (dBuV)		Standard
	Quasi-peak	Average	Quasi-peak	Average	
0.15 -0.5	79.0	66.0	66 - 56 *	56 - 46 *	CISPR
0.50 -5.0	73.00	60.00	56.00	46.00	CISPR
5.0 -30.0	73.00	60.00	60.00	50.00	CISPR

0.15 -0.5	79.00	66.00	66 - 56 *	56 - 46 *	FCC
0.50 -5.0	73.00	60.00	56.00	46.00	FCC
5.0 -30.0	73.00	60.00	60.00	50.00	FCC

Note:

- (1) The tighter limit applies at the band edges.
- (2) The limit of " * " marked band means the limitation decreases linearly with the logarithm of the frequency in the range.

4.1.2 MEASUREMENT INSTRUMENTS LIST AND SETTING

Item	Kind of Equipment	Manufacturer	Type No.	Serial No.	Calibrated until
1	LISN	EMCO	3816/2	00052765	Apr. 25, 2014
2	LISN	R&S	ENV216	100087	Nov.16, 2013
3	Test Cable	N/A	C_17	N/A	Mar.15, 2014
4	EMI TEST RECEIVER	R&S	ESCS30	826547/022	Apr. 25, 2014
5	50Ω Terminator	SHX	TF2-3G-A	08122902	Apr. 25, 2014

Remark: "N/A" denotes no model name, serial no. or calibration specified.
All calibration period of equipment list is one year.

The following table is the setting of the receiver

Receiver Parameters	Setting
Attenuation	10 dB
Start Frequency	0.15 MHz
Stop Frequency	30 MHz
IF Bandwidth	9 kHz

4.1.3 TEST PROCEDURE

- The EUT was placed 0.8 meters from the horizontal ground plane with EUT being connected to the power mains through a line impedance stabilization network (LISN). All other support equipments powered from additional LISN(s). The LISN provide 50 Ohm/ 50uH of coupling impedance for the measuring instrument.
- Interconnecting cables that hang closer than 40 cm to the ground plane shall be folded back and forth in the center forming a bundle 30 to 40 cm long.
- I/O cables that are not connected to a peripheral shall be bundled in the center. The end of the cable may be terminated, if required, using the correct terminating impedance. The overall length shall not exceed 1 m.
- LISN at least 80 cm from nearest part of EUT chassis.
- For the actual test configuration, please refer to the related Item –EUT Test Photos.

4.1.4 DEVIATION FROM TEST STANDARD

No deviation

4.1.5 TEST SETUP

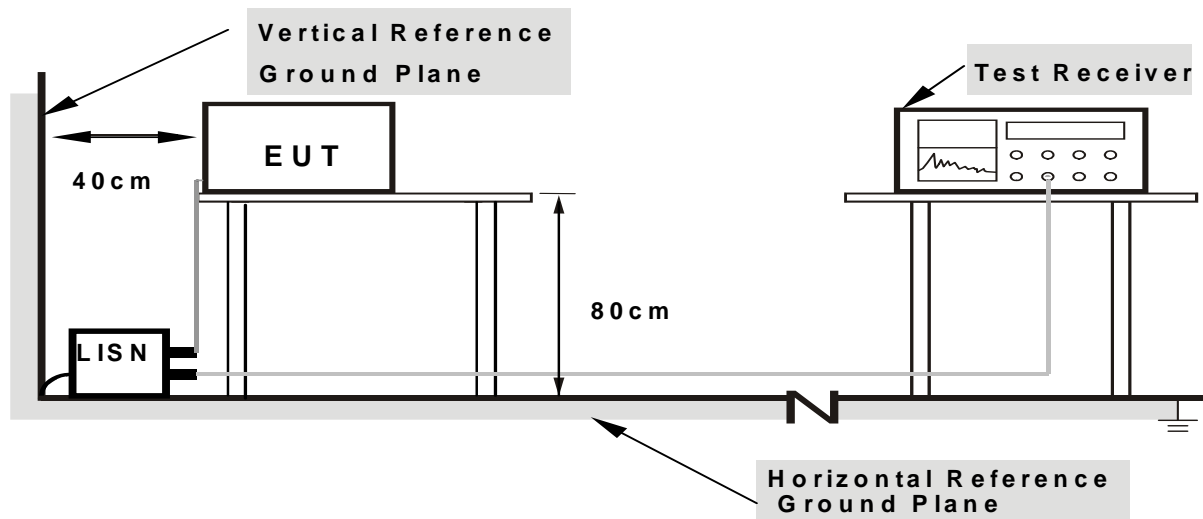

Note: 1. Support units were connected to second LISN.

2. Both of LISNs (AMN) are 80 cm from EUT and at least 80 from other units and other metal planes

4.1.6 EUT OPERATING CONDITIONS

The EUT was configured for testing in a typical fashion (as a customer would normally use it). The EUT was programmed to be in continuously transmitting/TX mode.



4.1.7 TEST RESULTS

Remark:

- (1) All readings are QP Mode value unless otherwise stated AVG in column of『Note』. If the QP Mode Measured value compliance with the QP Limits and lower than AVG Limits, the EUT shall be deemed to meet both QP & AVG Limits and then only QP Mode was measured, but AVG Mode didn't perform ◦ In this case, a “ * ” marked in AVG Mode column of Interference Voltage Measured ◦
- (2) Measuring frequency range from 150KHz to 30MHz ◦



Neutron Engineering Inc.

EUT:	High Power Dual Band Wireless 900N Low Profile Access Point	Model Name :	XAP-1500
Temperature:	25 °C	Relative Humidity:	50 %
Test Power:	AC 120V/60Hz	Phase:	Line
Test Mode:	TX Mode		

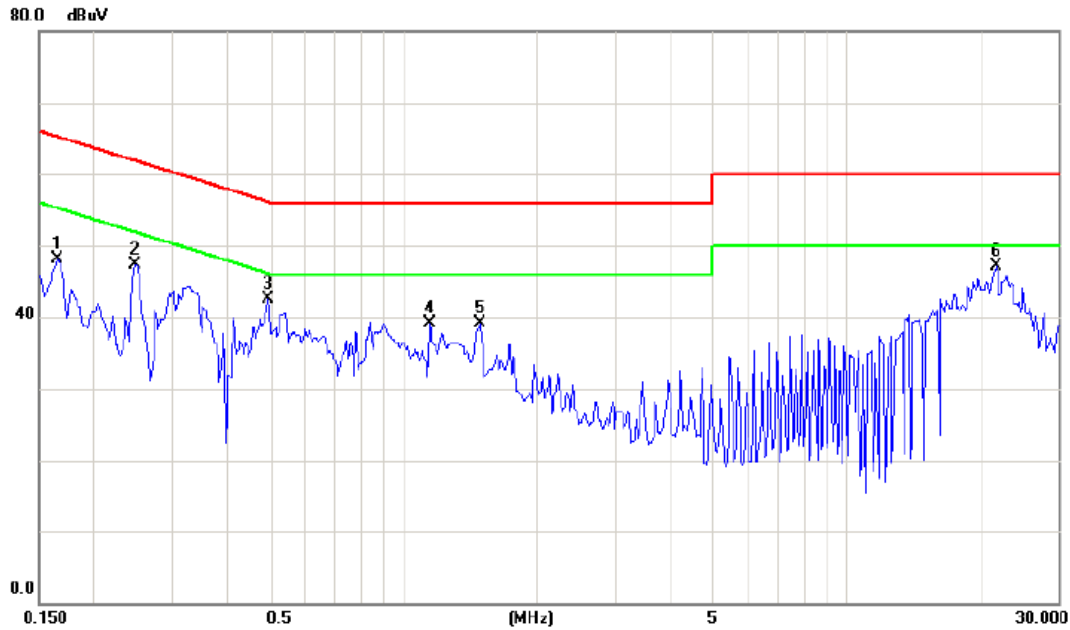

No.	Mk.	Freq. MHz	Reading Level dBuV	Correct Factor dB	Measure- ment dBuV	Limit dBuV	Over dB	Detector	Comment
1		0.1650	38.27	9.77	48.04	65.21	-17.17	peak	
2		0.2467	37.60	9.74	47.34	61.87	-14.53	peak	
3		0.4914	32.75	9.70	42.45	56.14	-13.69	peak	
4		1.1411	29.42	9.70	39.12	56.00	-16.88	peak	
5		1.4795	29.33	9.69	39.02	56.00	-16.98	peak	
6	*	21.7150	37.21	9.88	47.09	60.00	-12.91	peak	



Neutron Engineering Inc.

EUT:	High Power Dual Band Wireless 900N Low Profile Access Point	Model Name :	XAP-1500
Temperature:	25 °C	Relative Humidity:	50 %
Test Power:	AC 120V/60Hz	Phase:	Neutral
Test Mode:	TX Mode		

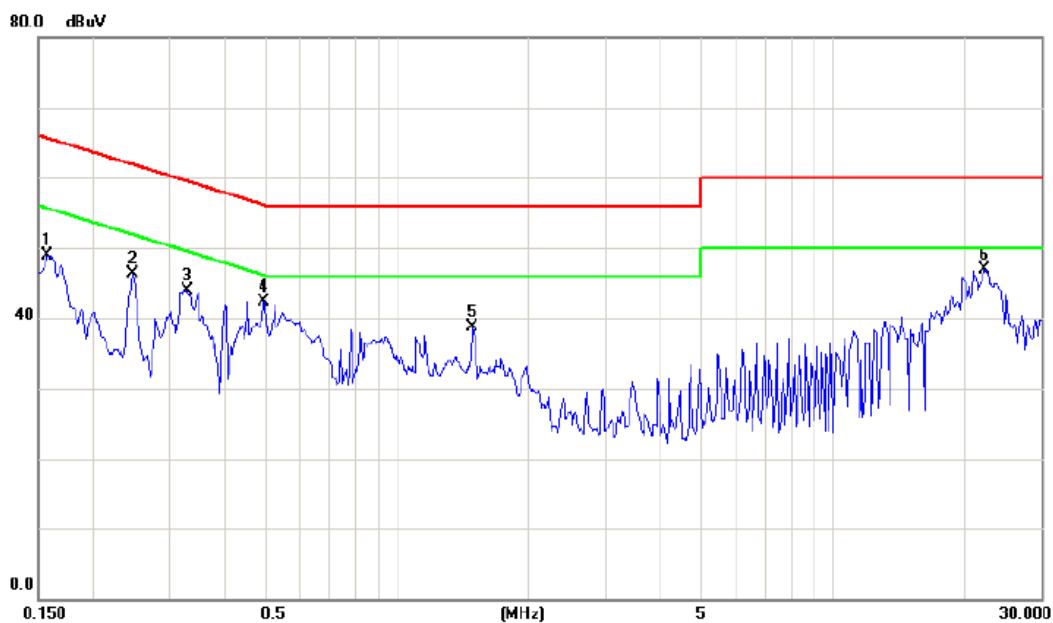

No.	Mk.	Freq. MHz	Reading Level dBuV	Correct Factor dB	Measure- ment dBuV	Limit dBuV	Over dB	Detector	Comment
1		0.1572	39.21	9.78	48.99	65.61	-16.62	peak	
2		0.2467	36.62	9.74	46.36	61.87	-15.51	peak	
3		0.3285	34.22	9.73	43.95	59.49	-15.54	peak	
4		0.4914	32.69	9.70	42.39	56.14	-13.75	peak	
5		1.4795	29.09	9.69	38.78	56.00	-17.22	peak	
6	*	22.1800	37.11	9.89	47.00	60.00	-13.00	peak	



4.2 RADIATED EMISSION MEASUREMENT

4.2.1 RADIATED EMISSION LIMITS (Frequency Range 9KHz-1000MHz)

20dB in any 100 KHz bandwidth outside the operating frequency band. In case the emission fall within the restricted band specified on 15.205(a), then the 15.209(a) limit in the table below has to be followed.

Frequency (MHz)	Field Strength (microvolts/meter)	Measurement Distance (meters)
0.009~0.490	2400/F(KHz)	300
0.490~1.705	24000/F(KHz)	30
1.705~30.0	30	30
30~88	100	3
88~216	150	3
216~960	200	3
960~1000	500	3

LIMITS OF RADIATED EMISSION MEASUREMENT (Above 1000MHz)

Frequency (MHz)	(dBuV/m) (at 3 meters)	
	PEAK	AVERAGE
Above 1000	74	54

Notes:

- (1) The limit for radiated test was performed according to FCC PART 15C.
- (2) The tighter limit applies at the band edges.
- (3) Emission level (dBuV/m)=20log Emission level (uV/m).

Spectrum Parameter	Setting
Attenuation	Auto
Start Frequency	1000 MHz
Stop Frequency	10th carrier harmonic
RB / VB (Emission in restricted band)	1MHz / 1MHz for Peak, 1 MHz / 10Hz for Average

Receiver Parameter	Setting
Attenuation	Auto
Start ~ Stop Frequency	9kHz~90kHz for PK/AVG detector
Start ~ Stop Frequency	90kHz~110kHz for QP detector
Start ~ Stop Frequency	110kHz~490kHz for PK/AVG detector
Start ~ Stop Frequency	490kHz~30MHz for QP detector
Start ~ Stop Frequency	30MHz~1000MHz for QP detector



4.2.2 MEASUREMENT INSTRUMENTS LIST AND SETTING

Item	Kind of Equipment	Manufacturer	Type No.	Serial No.	Calibrated until
1	Antenna	Schwarzbeck	VULB9160	9160-3232	Apr. 25, 2014
2	Amplifier	HP	8447D	2944A09673	Apr. 25, 2014
3	Test Receiver	R&S	ESCI	100382	Apr. 25, 2014
4	Test Cable	N/A	C-01_CB03	N/A	Jul. 02, 2014
5	Antenna	ETS	3115	00075789	Apr. 25, 2014
6	Amplifier	Agilent	8449B	3008A02274	Apr. 25, 2014
7	Spectrum	Agilent	E4408B	US39240143	Nov. 16, 2013
8	Test Cable	HUBER+SUHNER	C-45	N/A	Apr. 30, 2014
9	Controller	CT	SC100	N/A	N/A
10	Horn Antenna	EMCO	3115	9605-4803	Apr. 25, 2014
11	Active Loop Antenna	R&S	HFH2-Z2	830749/020	Apr. 25, 2014
12	Broad-Band Horn Antenna	Schwarzbeck	BBHA 9170	9170319	Oct. 22, 2014

Remark: "N/A" denotes no model name, serial no. or calibration specified.

All calibration period of Equipment List is One Year.

4.2.3 TEST PROCEDURE

- a. The measuring distance of at 1.5 m shall be used for measurements at frequency up to 1GHz. For frequencies above 1GHz, any suitable measuring distance may be used.
- b. The EUT was placed on the top of a rotating table 0.8 meters above the ground at a 3 meter semi-anechoic chamber. The table was rotated 360 degrees to determine the position of the highest radiation.
- c. The height of the equipment or of the substitution antenna shall be 0.8 m; the height of the test antenna shall vary between 1 m to 4 m. Both horizontal and vertical polarizations of the antenna are set to make the measurement.
- d. The initial step in collecting conducted emission data is a spectrum analyzer peak detector mode pre-scanning the measurement frequency range. Significant peaks are then marked and then Quasi Peak detector mode re-measured.
- e. If the Peak Mode measured value compliance with and lower than Quasi Peak Mode Limit, the EUT shall be deemed to meet QP Limits and then no additional QP Mode measurement performed.
- f. For the actual test configuration, please refer to the related Item –EUT Test Photos.

4.2.4 DEVIATION FROM TEST STANDARD

No deviation

4.2.5 TEST SETUP

(A) Radiated Emission Test Set-Up Frequency Below 1 GHz

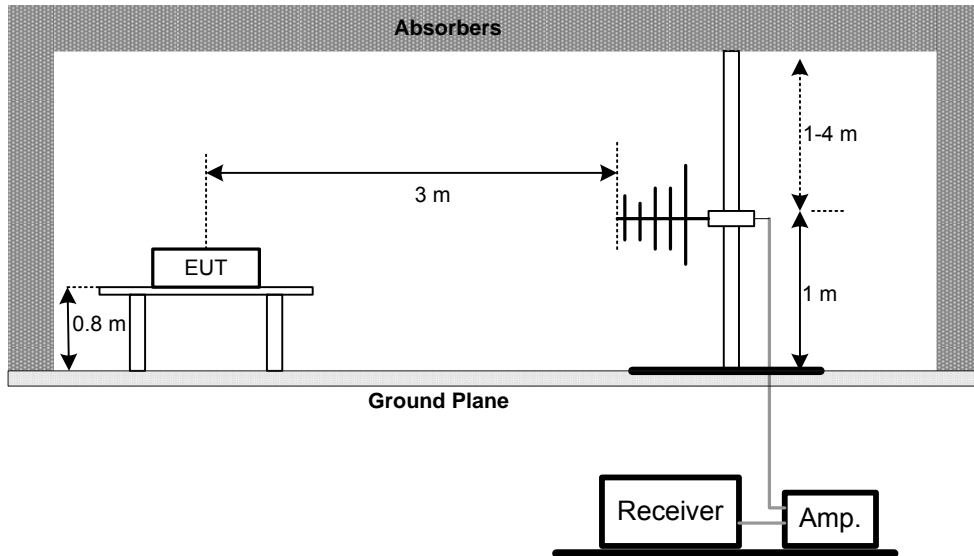

(B) Radiated Emission Test Set-Up Frequency Above 1 GHz

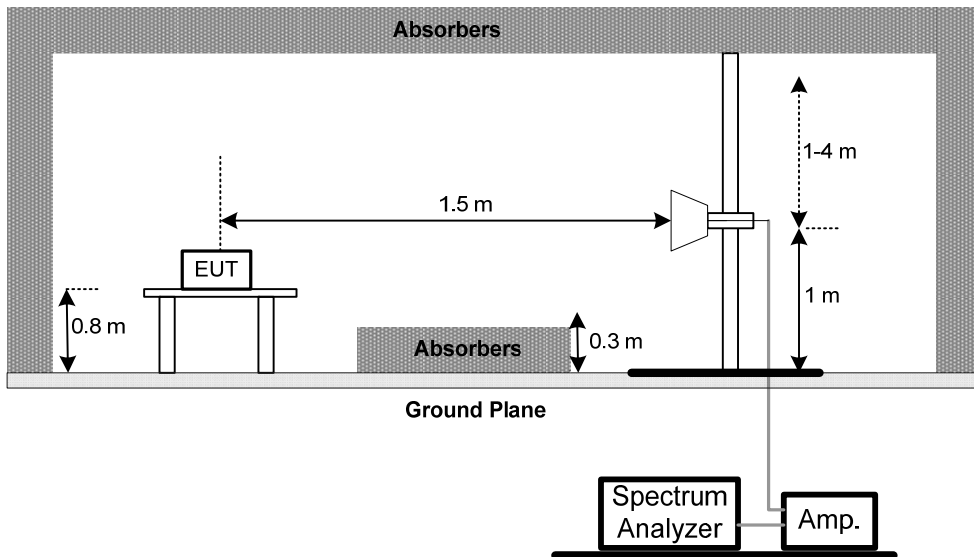

(C) For radiated emissions below 30MHz

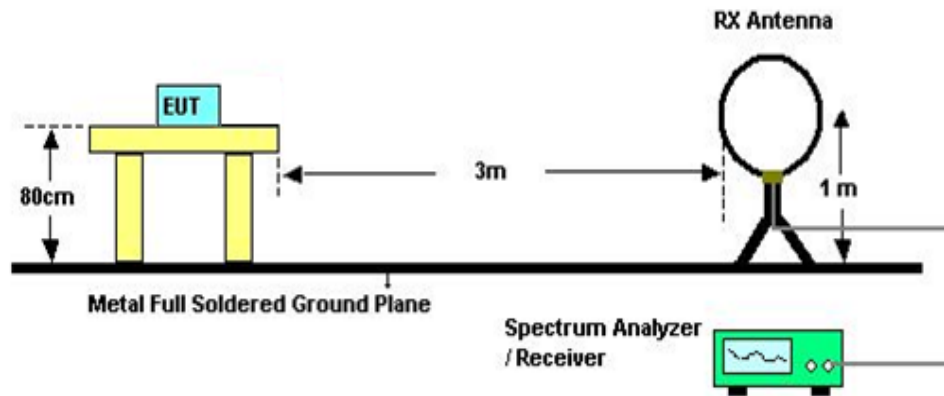

4.2.6 EUT OPERATING CONDITIONS

The EUT tested system was configured as the statements of 4.1.6 Unless otherwise a special operating condition is specified in the follows during the testing.



4.2.7 TEST RESULTS (BETWEEN 30 – 1000 MHZ)

Remark:

- (1) Reading in which marked as QP or Peak means measurements by using are Quasi-Peak Mode or Peak Mode with Detector BW=120KHz ; SPA setting in RBW=120KHz, VBW =120KHz, Swp. Time = 0.3 sec./MHz ◦
- (2) All readings are Peak unless otherwise stated QP in column of 『Note』 . Peak denotes that the Peak reading compliance with the QP Limits and then QP Mode measurement didn't perform ◦
- (3) Measuring frequency range from 30MHz to 1000MHz ◦
- (4) If the peak scan value lower limit more than 20dB, then this signal data does not show in table ◦



EUT:	High Power Dual Band Wireless 900N Low Profile Access Point	Model Name :	XAP-1500
Temperature:	25°C	Relative Humidity:	58 %
Test Voltage :	AC 120V/60Hz	Phase:	Vertical
Test Mode :	TX A Mode 5745MHz		

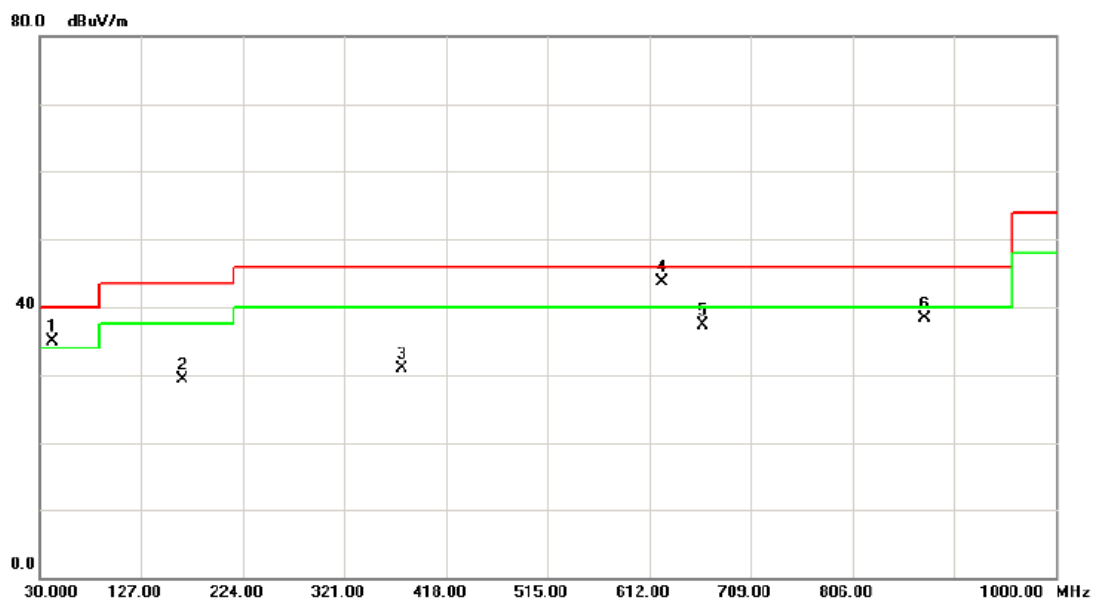

No.	Mk.	Freq. MHz	Reading Level dBuV	Correct Factor dB	Measure- ment dBuV/m	Limit dBuV/m	Over dB	Detector	Comment
1	!	42.6100	49.23	-14.39	34.84	40.00	-5.16	peak	
2		165.8000	42.44	-13.11	29.33	43.50	-14.17	peak	
3		375.3200	41.54	-10.66	30.88	46.00	-15.12	peak	
4	*	624.6100	50.47	-6.86	43.61	46.00	-2.39	peak	
5		662.4400	42.71	-5.38	37.33	46.00	-8.67	peak	
6		874.8700	40.83	-2.48	38.35	46.00	-7.65	peak	



EUT:	High Power Dual Band Wireless 900N Low Profile Access Point	Model Name :	XAP-1500
Temperature:	25°C	Relative Humidity:	58 %
Test Voltage :	AC 120V/60Hz	Phase:	Horizontal
Test Mode :	TX A Mode 5745MHz		

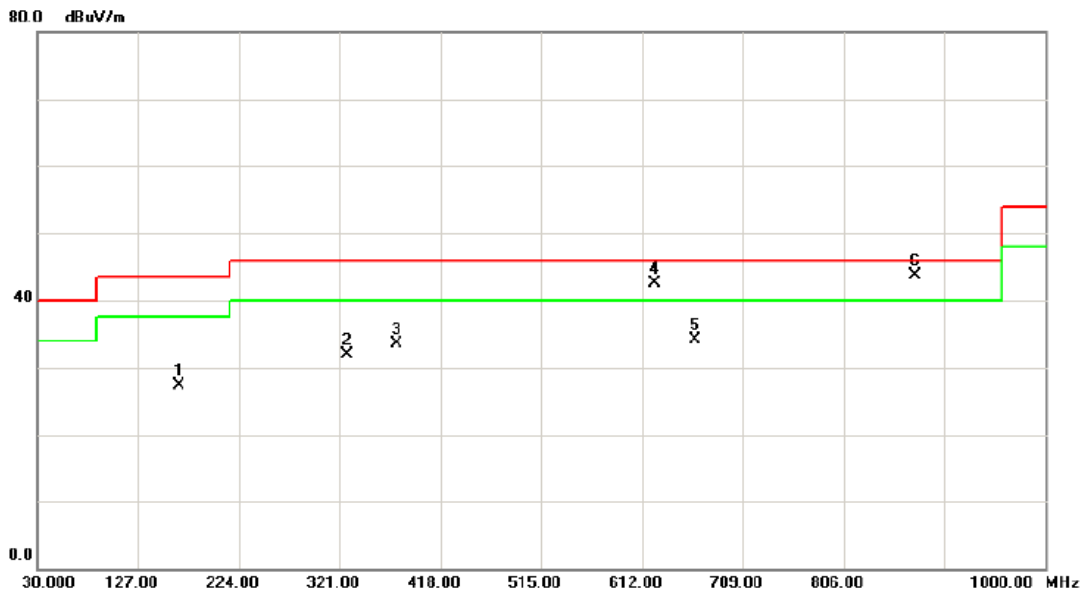

No. Mk.	Freq. MHz	Reading Level dBuV	Correct Factor dB	Measurement dBuV/m	Limit dBuV/m	Over dB	Detector	Comment
1	165.8000	40.41	-13.11	27.30	43.50	-16.20	peak	
2	327.7900	43.28	-11.37	31.91	46.00	-14.09	peak	
3	375.3200	44.15	-10.66	33.49	46.00	-12.51	peak	
4	624.6100	49.39	-6.86	42.53	46.00	-3.47	peak	
5	662.4400	39.51	-5.38	34.13	46.00	-11.87	peak	
6	874.8700	46.26	-2.48	43.78	46.00	-2.22	peak	



EUT:	High Power Dual Band Wireless 900N Low Profile Access Point	Model Name :	XAP-1500
Temperature:	25°C	Relative Humidity:	58 %
Test Voltage :	AC 120V/60Hz	Phase:	Vertical
Test Mode :	TX A Mode 5785MHz		

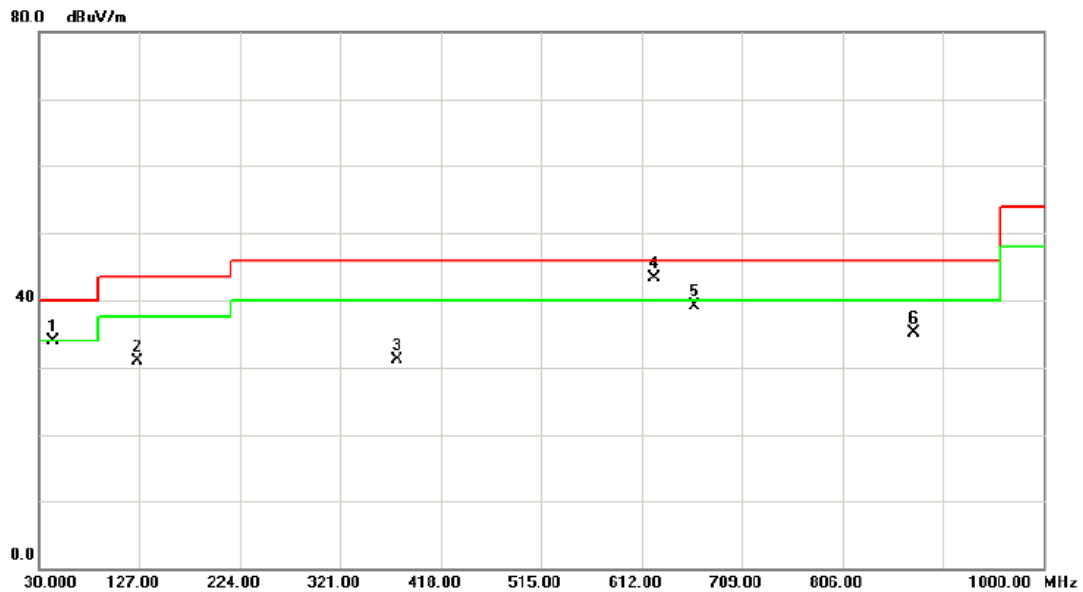

No. Mk.	Freq. MHz	Reading Level dBuV	Correct Factor dB	Measurement dBuV/m	Limit dBuV/m	Over dB	Detector	Comment
1	43.5800	48.19	-14.22	33.97	40.00	-6.03	peak	
2	125.0600	44.51	-13.61	30.90	43.50	-12.60	peak	
3	375.3200	41.72	-10.66	31.06	46.00	-14.94	peak	
4 *	624.6100	50.18	-6.86	43.32	46.00	-2.68	peak	
5	662.4400	44.46	-5.38	39.08	46.00	-6.92	peak	
6	874.8700	37.63	-2.48	35.15	46.00	-10.85	peak	



EUT:	High Power Dual Band Wireless 900N Low Profile Access Point	Model Name :	XAP-1500
Temperature:	25°C	Relative Humidity:	58 %
Test Voltage :	AC 120V/60Hz	Phase:	Horizontal
Test Mode :	TX A Mode 5785MHz		

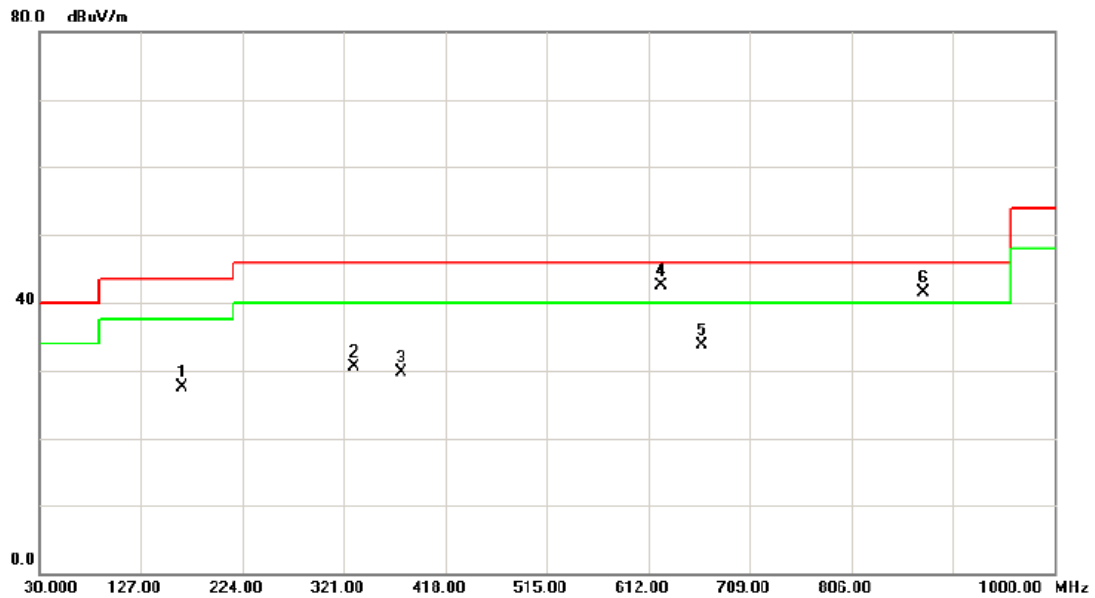

No.	Mk.	Freq. MHz	Reading Level dBuV	Correct Factor dB	Measure- ment dBuV/m	Limit dBuV/m	Over dB	Detector	Comment
1		165.8000	40.64	-13.11	27.53	43.50	-15.97	peak	
2		330.7000	41.92	-11.37	30.55	46.00	-15.45	peak	
3		375.3200	40.33	-10.66	29.67	46.00	-16.33	peak	
4	*	624.6100	49.38	-6.86	42.52	46.00	-3.48	peak	
5		662.4400	39.11	-5.38	33.73	46.00	-12.27	peak	
6	!	874.8700	44.01	-2.48	41.53	46.00	-4.47	peak	



EUT:	High Power Dual Band Wireless 900N Low Profile Access Point	Model Name :	XAP-1500
Temperature:	25°C	Relative Humidity:	58 %
Test Voltage :	AC 120V/60Hz	Phase:	Vertical
Test Mode :	TX A Mode 5825MHz		

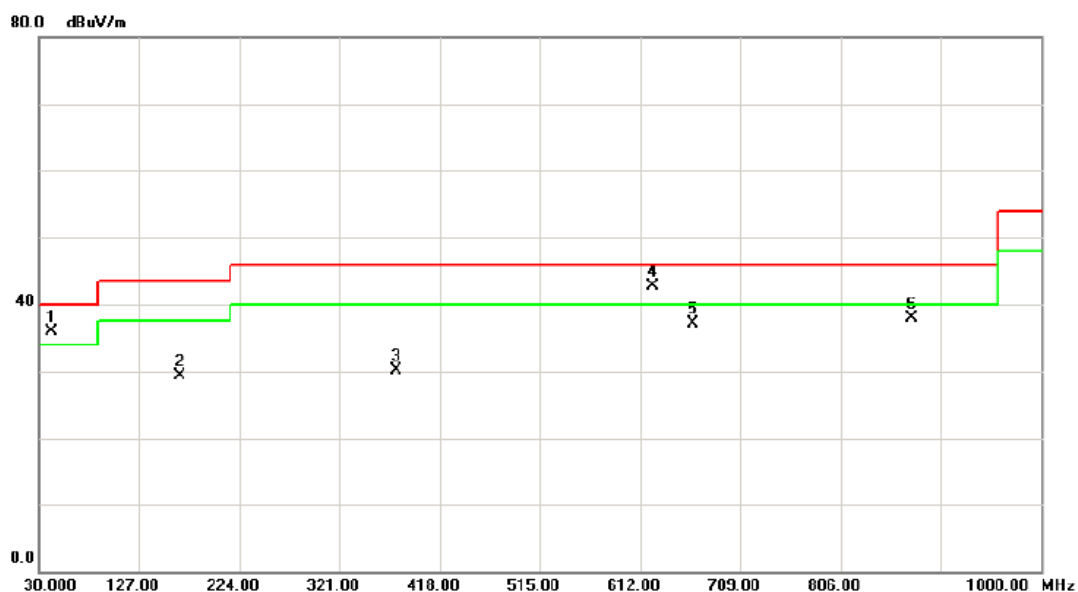

No.	Mk.	Freq. MHz	Reading Level dBuV	Correct Factor dB	Measure- ment dBuV/m	Limit dBuV/m	Over dB	Detector	Comment
1	!	41.6400	50.48	-14.51	35.97	40.00	-4.03	peak	
2		165.8000	42.40	-13.11	29.29	43.50	-14.21	peak	
3		375.3200	40.81	-10.66	30.15	46.00	-15.85	peak	
4	*	624.6100	49.63	-6.86	42.77	46.00	-3.23	peak	
5		662.4400	42.58	-5.38	37.20	46.00	-8.80	peak	
6		874.8700	40.42	-2.48	37.94	46.00	-8.06	peak	



EUT:	High Power Dual Band Wireless 900N Low Profile Access Point	Model Name :	XAP-1500
Temperature:	25°C	Relative Humidity:	58 %
Test Voltage :	AC 120V/60Hz	Phase:	Horizontal
Test Mode :	TX A Mode 5825MHz		

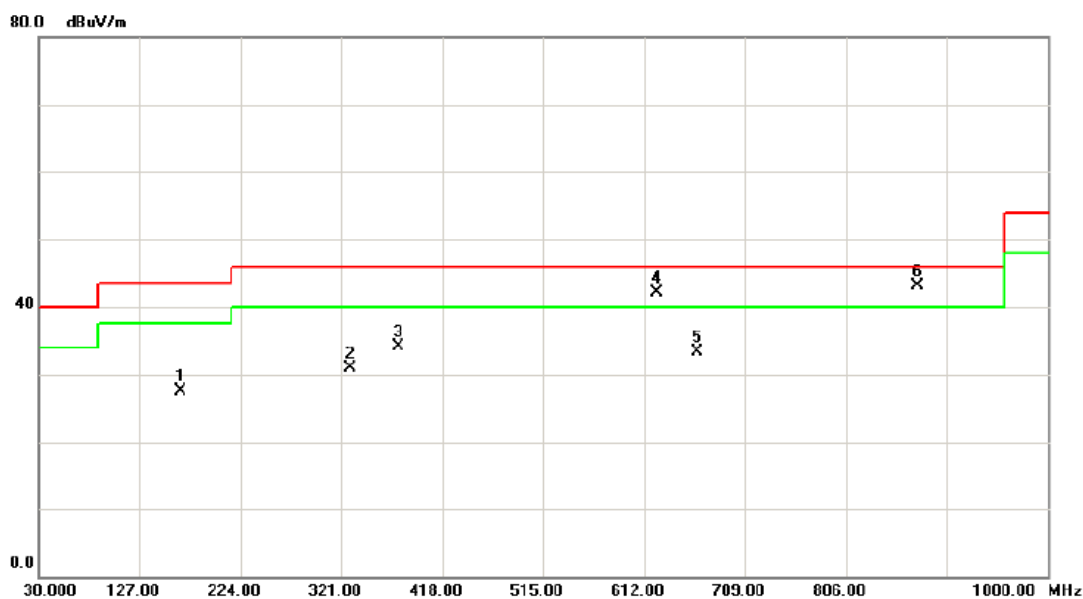

No. Mk.	Freq. MHz	Reading Level dBuV	Correct Factor dB	Measurement dBuV/m	Limit dBuV/m	Over dB	Detector	Comment
1	165.8000	40.64	-13.11	27.53	43.50	-15.97	peak	
2	329.7300	42.32	-11.38	30.94	46.00	-15.06	peak	
3	375.3200	44.80	-10.66	34.14	46.00	-11.86	peak	
4 !	624.6100	48.88	-6.86	42.02	46.00	-3.98	peak	
5	662.4400	38.62	-5.38	33.24	46.00	-12.76	peak	
6 *	874.8700	45.51	-2.48	43.03	46.00	-2.97	peak	



4.2.8 TEST RESULTS (ABOVE 1000 MHZ)

EUT:	High Power Dual Band Wireless 900N Low Profile Access Point	Model Name :	XAP-1500
Temperature:	25 °C	Relative Humidity:	58 %
Pressure:	1010 hPa	Test Voltage :	AC 120V/60Hz
Test Mode :	TX A Mode 5745MHz		

Freq. (MHz)	Ant.Pol. H/V	Reading		Ant./CF CF(dB)	Act.		Limit		Note
		Peak (dBuV)	AV (dBuV)		Peak (dBuV/m)	AV (dBuV/m)	Peak (dBuV/m)	AV (dBuV/m)	
#5725.00	V	15.08	6.02	44.34	59.42	50.36	80.05	71.62	X/E
5741.50	V	55.65	47.22	44.40	100.05	91.62			X/F
11492.50	V	33.48	27.06	18.47	51.95	45.53	74.00	54.00	X/H

Remark:

- (1) All readings are Peak unless otherwise stated QP in column of 『Note』 . Peak denotes that the Peak reading compliance with the QP Limits and then QP Mode measurement didn't perform ◦
- (2) Measuring frequency range from 30MHz to 1000MHz or the 10th harmonic of highest fundamental frequency ◦“F” denotes fundamental frequency; “H” denotes spurious frequency. “E” denotes band edge frequency. (This judgment method includes the Band Edge Requirement.)
- (3) Radiated emissions measured in frequency range above 1000MHz were made with an instrument using Peak detector mode and AV detector mode of the emission ◦
- (4) Data of measurement within this frequency range shown “ * ” in the table above means the reading of emissions are attenuated more than 20dB below the permissible limits or the field strength is too small to be measured.
- (5) A preamp and high pass filter were used for this test in order to provide sufficient measurement sensitivity.
- (6) EUT Orthogonal Axis:
“X” - denotes Laid on Table ; “Y” - denotes Vertical Stand ; “Z” - denotes Side Stand
- (7) During the measurements above 1 GHz it is taken care of that the EUT is always within the 3 dB cone of radiation BW of the used antenna
- (8) “#” The radiated frequency is out of the restricted band. Limit line= fundamental - 20dB



TX CH149 (Above 1000 MHz, Vertical)

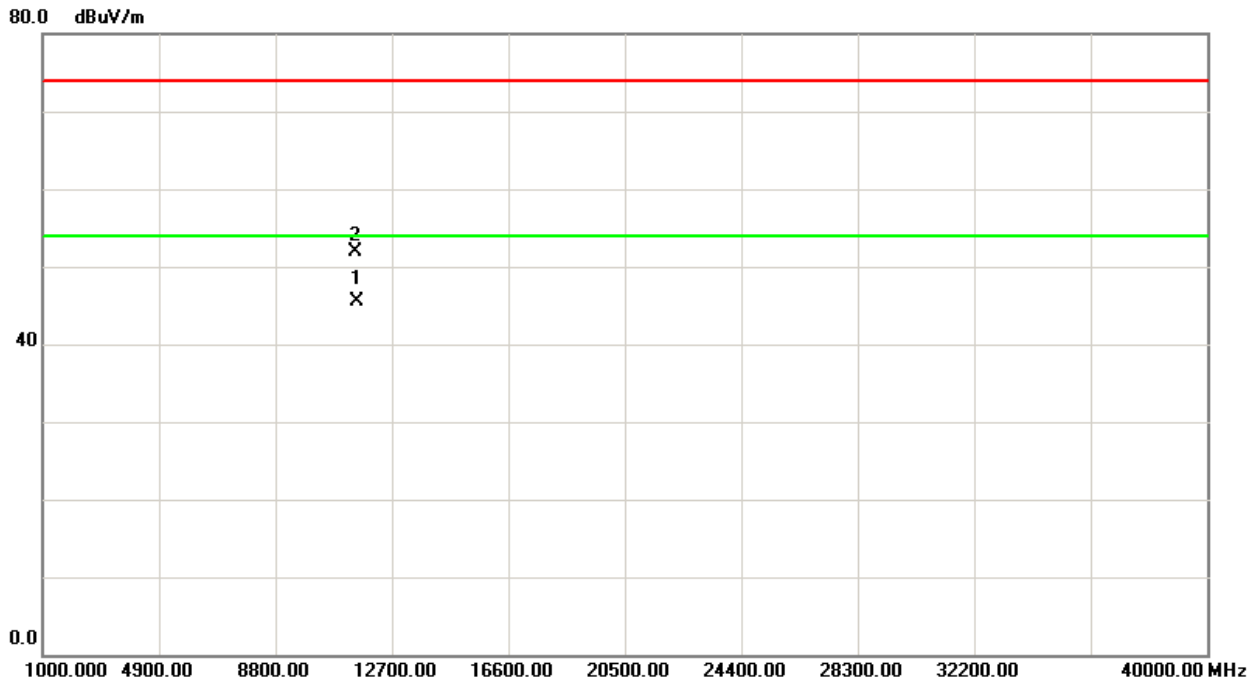
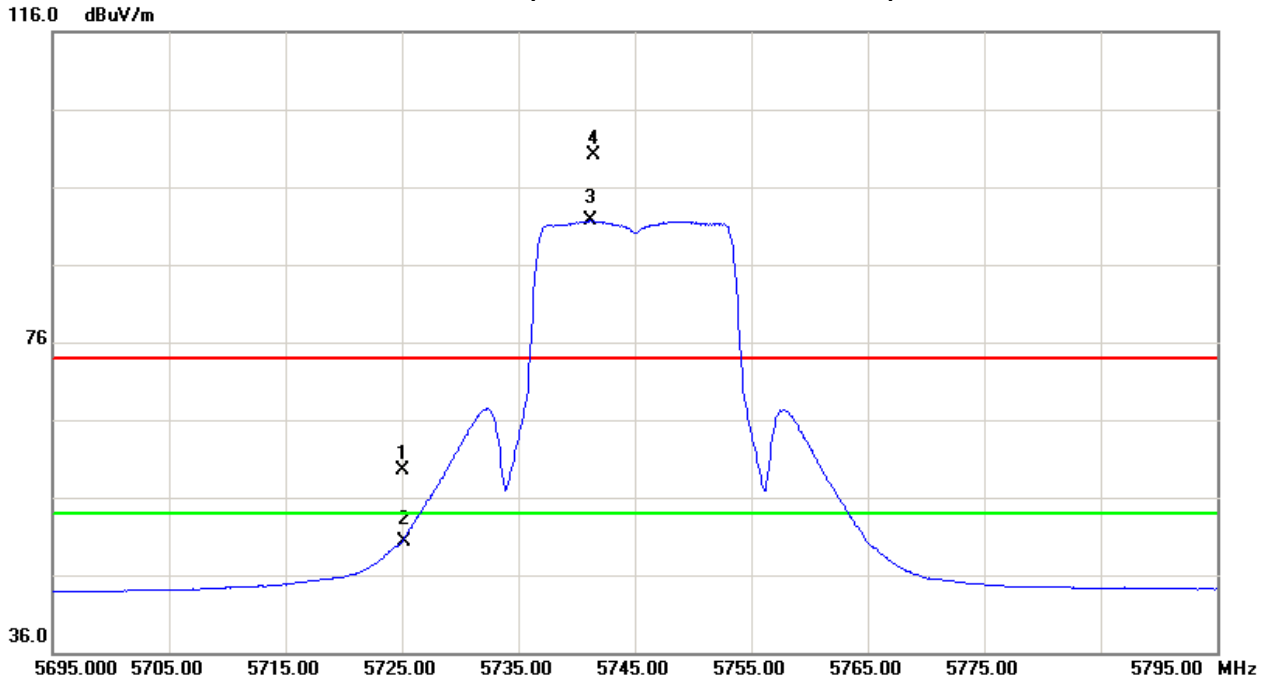



EUT:	High Power Dual Band Wireless 900N Low Profile Access Point	Model Name :	XAP-1500
Temperature:	25 °C	Relative Humidity:	58 %
Pressure:	1010 hPa	Test Voltage :	AC 120V/60Hz
Test Mode :	TX A Mode 5745MHz		

Freq. (MHz)	Ant.Pol. H/V	Reading		Ant./CF CF(dB)	Act.		Limit		Note
		Peak (dBuV)	AV (dBuV)		Peak (dBuV/m)	AV (dBuV/m)	Peak (dBuV/m)	AV (dBuV/m)	
# 5725.00	H	10.97	0.75	44.34	55.31	45.09	70.81	62.30	X/E
5751.00	H	46.41	37.90	44.40	90.81	82.30			X/F
11486.50	H	30.26	25.14	18.46	48.72	43.60	74.00	54.00	X/H

Remark:

- (1) All readings are Peak unless otherwise stated QP in column of 『Note』 . Peak denotes that the Peak reading compliance with the QP Limits and then QP Mode measurement didn't perform ◦
- (2) Measuring frequency range from 30MHz to 1000MHz or the 10th harmonic of highest fundamental frequency ◦ "F" denotes fundamental frequency; "H" denotes spurious frequency. "E" denotes band edge frequency. (This judgment method includes the Band Edge Requirement.)
- (3) Radiated emissions measured in frequency range above 1000MHz were made with an instrument using Peak detector mode and AV detector mode of the emission ◦
- (4) Data of measurement within this frequency range shown " * " in the table above means the reading of emissions are attenuated more than 20dB below the permissible limits or the field strength is too small to be measured.
- (5) A preamp and high pass filter were used for this test in order to provide sufficient measurement sensitivity.
- (6) EUT Orthogonal Axis:
"X" - denotes Laid on Table ; "Y" - denotes Vertical Stand ; "Z" - denotes Side Stand
- (7) During the measurements above 1 GHz it is taken care of that the EUT is always within the 3 dB cone of radiation BW of the used antenna
- (8) "#" The radiated frequency is out of the restricted band. Limit line= fundamental - 20dB



TX CH149 (Above 1000 MHz, Horizontal)

116.0 dBuV/m

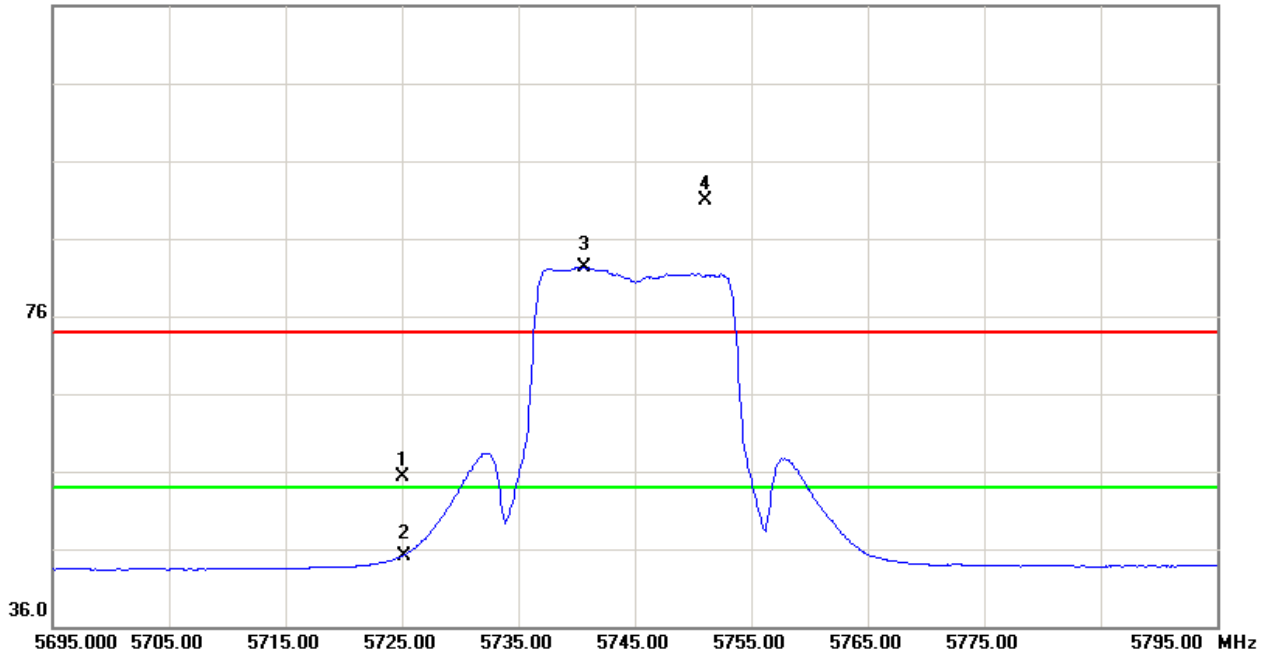

80.0 dBuV/m

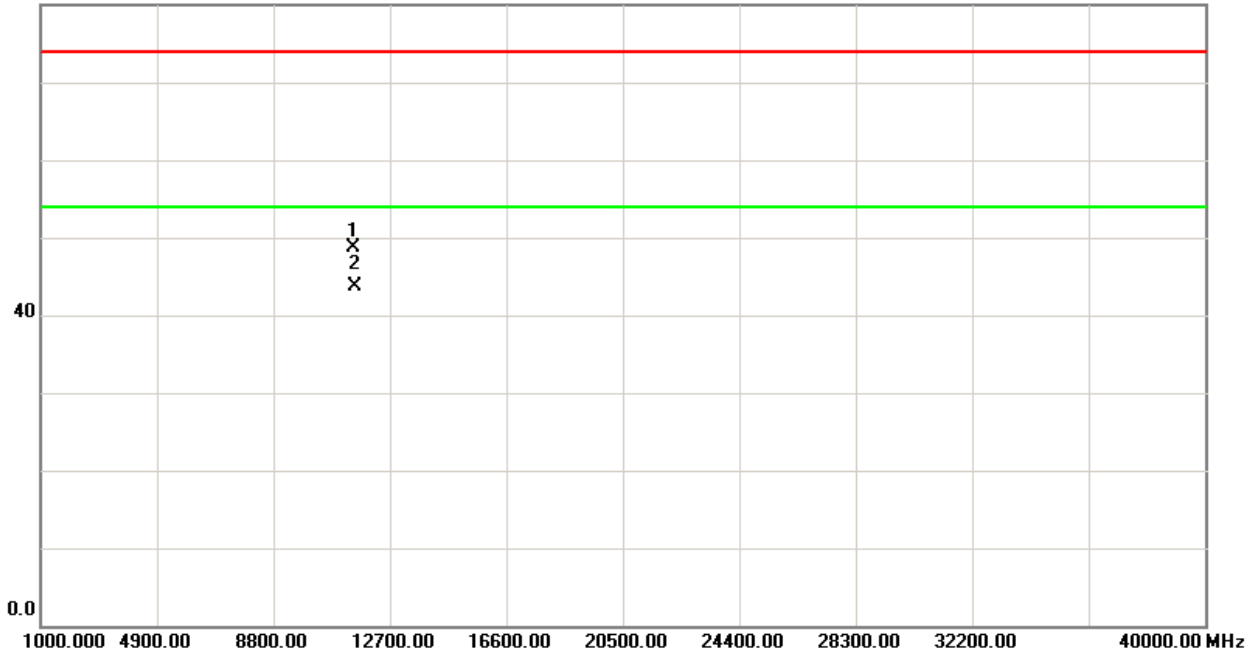



EUT:	High Power Dual Band Wireless 900N Low Profile Access Point	Model Name :	XAP-1500
Temperature:	25 °C	Relative Humidity:	58 %
Pressure:	1010 hPa	Test Voltage :	AC 120V/60Hz
Test Mode :	TX A Mode 5785MHz		

Freq. (MHz)	Ant.Pol. H/V	Reading		Ant./CF CF(dB)	Act.		Limit		Note
		Peak (dBuV)	AV (dBuV)		Peak (dBuV/m)	AV (dBuV/m)	Peak (dBuV/m)	AV (dBuV/m)	
5788.50	V	57.17	48.37	44.57	101.74	92.94			X/F
11573.20	V	33.36	26.75	18.67	52.03	45.42	74.00	54.00	X/H

Remark:

- (1) All readings are Peak unless otherwise stated QP in column of 『Note』 . Peak denotes that the Peak reading compliance with the QP Limits and then QP Mode measurement didn't perform ◦
- (2) Measuring frequency range from 30MHz to 1000MHz or the 10th harmonic of highest fundamental frequency ◦ "F" denotes fundamental frequency; "H" denotes spurious frequency. "E" denotes band edge frequency. (This judgment method includes the Band Edge Requirement.)
- (3) Radiated emissions measured in frequency range above 1000MHz were made with an instrument using Peak detector mode and AV detector mode of the emission ◦
- (4) Data of measurement within this frequency range shown " * " in the table above means the reading of emissions are attenuated more than 20dB below the permissible limits or the field strength is too small to be measured.
- (5) A preamp and high pass filter were used for this test in order to provide sufficient measurement sensitivity.
- (6) EUT Orthogonal Axis:
"X" - denotes Laid on Table ; "Y" - denotes Vertical Stand ; "Z" - denotes Side Stand
- (7) During the measurements above 1 GHz it is taken care of that the EUT is always within the 3 dB cone of radiation BW of the used antenna



TX CH157 (Above 1000 MHz, Vertical)

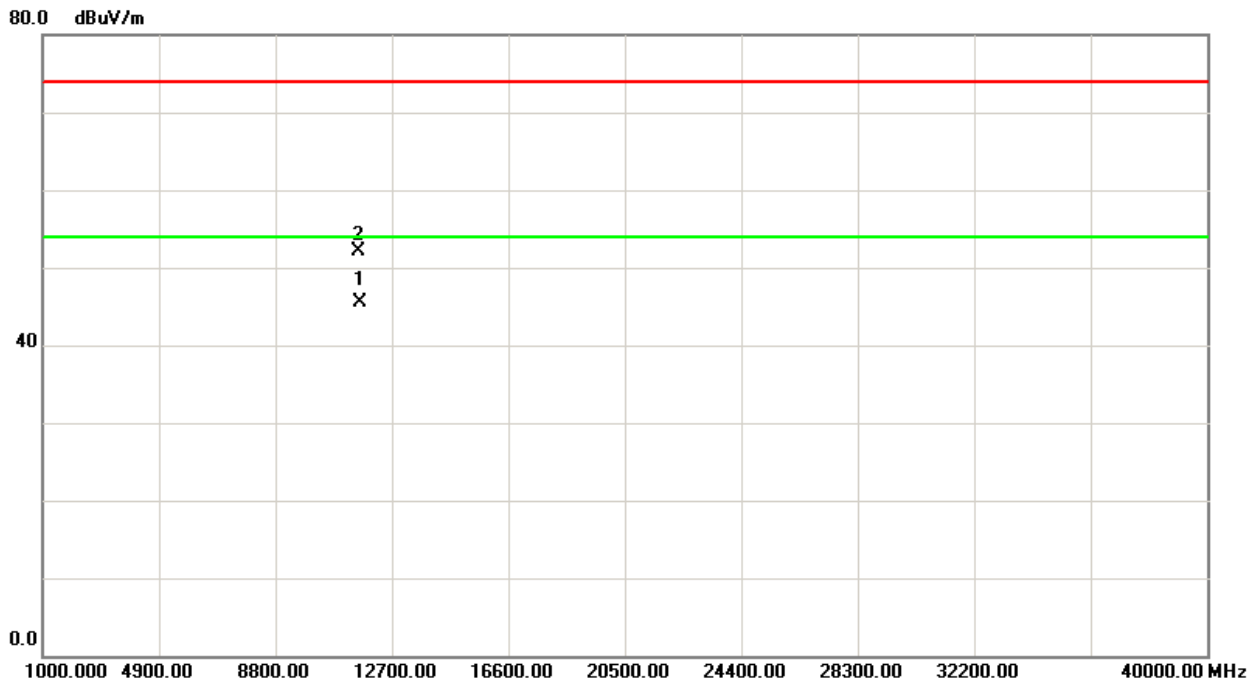
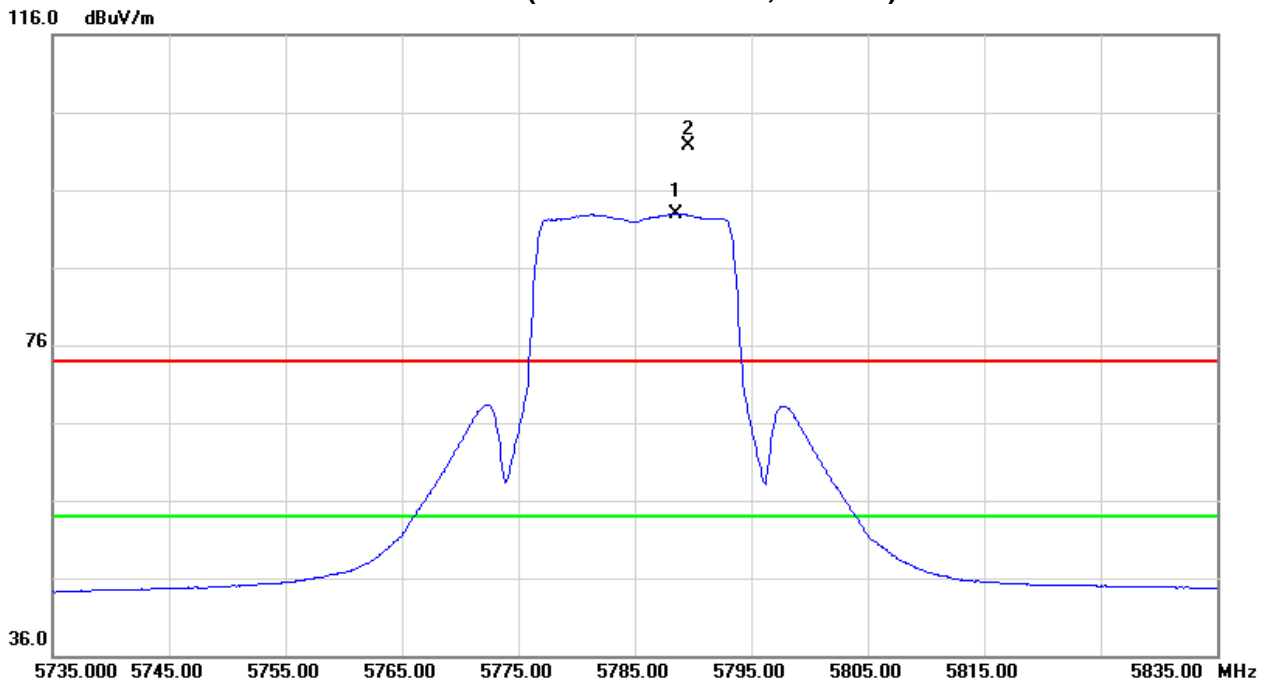



EUT:	High Power Dual Band Wireless 900N Low Profile Access Point	Model Name :	XAP-1500
Temperature:	25 °C	Relative Humidity:	58 %
Pressure:	1010 hPa	Test Voltage :	AC 120V/60Hz
Test Mode :	TX A Mode 5785MHz		

Freq. (MHz)	Ant.Pol. H/V	Reading		Ant./CF CF(dB)	Act.		Limit		Note
		Peak (dBuV)	AV (dBuV)		Peak (dBuV/m)	AV (dBuV/m)	Peak (dBuV/m)	AV (dBuV/m)	
778.60	H	44.47	37.33	44.54	89.01	81.87			X/F
11571.50	H	30.05	23.54	18.67	48.72	42.21	74.00	54.00	X/H

Remark:

- (1) All readings are Peak unless otherwise stated QP in column of 『Note』 . Peak denotes that the Peak reading compliance with the QP Limits and then QP Mode measurement didn't perform ◦
- (2) Measuring frequency range from 30MHz to 1000MHz or the 10th harmonic of highest fundamental frequency ◦ "F" denotes fundamental frequency; "H" denotes spurious frequency. "E" denotes band edge frequency. (This judgment method includes the Band Edge Requirement.)
- (3) Radiated emissions measured in frequency range above 1000MHz were made with an instrument using Peak detector mode and AV detector mode of the emission ◦
- (4) Data of measurement within this frequency range shown " * " in the table above means the reading of emissions are attenuated more than 20dB below the permissible limits or the field strength is too small to be measured.
- (5) A preamp and high pass filter were used for this test in order to provide sufficient measurement sensitivity.
- (6) EUT Orthogonal Axis:
"X" - denotes Laid on Table ; "Y" - denotes Vertical Stand ; "Z" - denotes Side Stand
- (7) During the measurements above 1 GHz it is taken care of that the EUT is always within the 3 dB cone of radiation BW of the used antenna



TX CH157 (Above 1000 MHz, Horizontal)

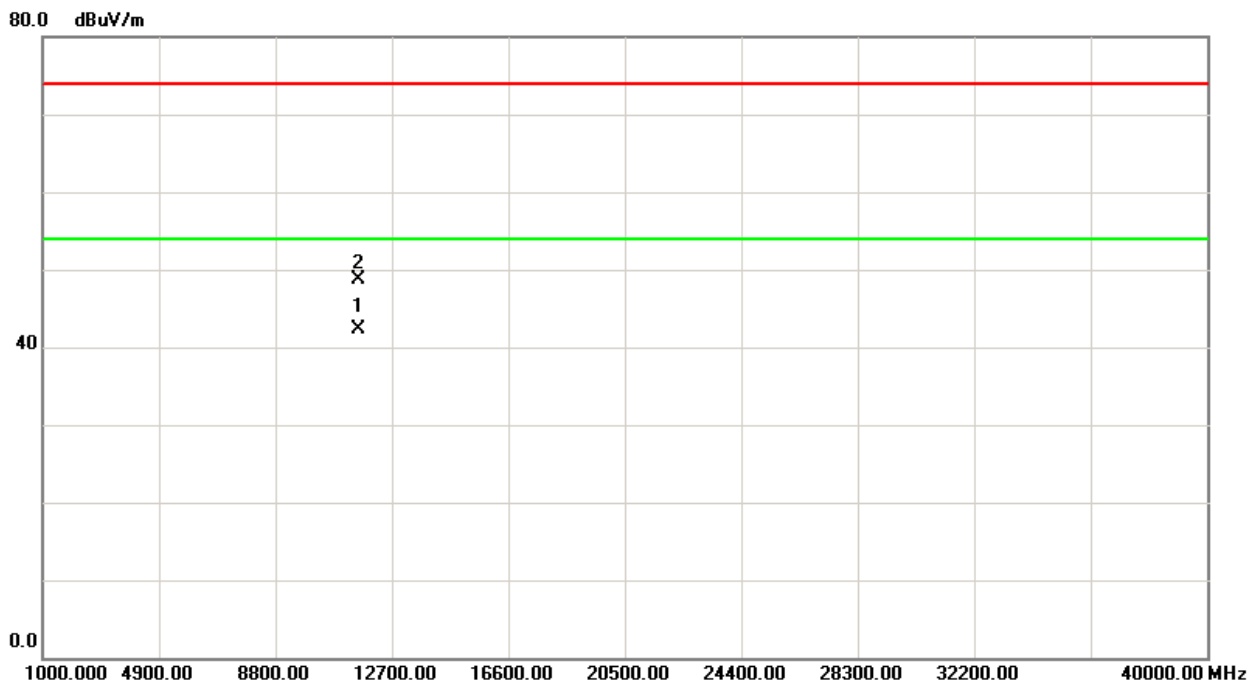
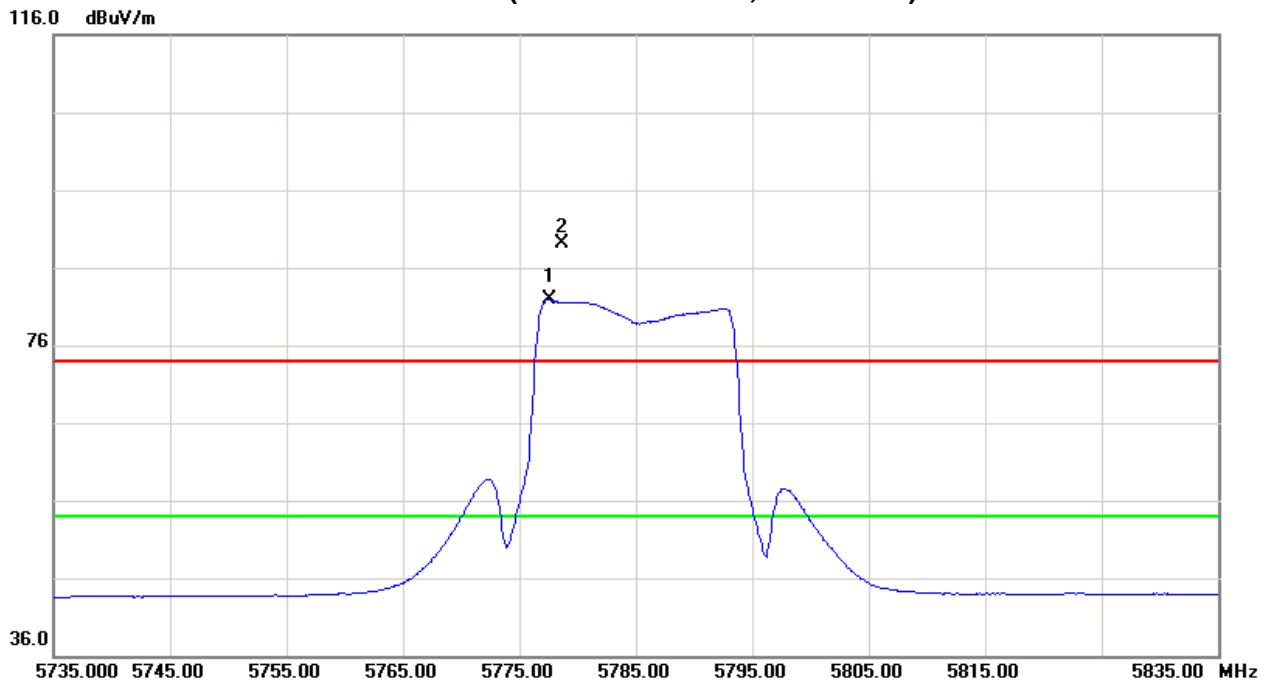



EUT:	High Power Dual Band Wireless 900N Low Profile Access Point	Model Name :	XAP-1500
Temperature:	25 °C	Relative Humidity:	58 %
Pressure:	1010 hPa	Test Voltage :	AC 120V/60Hz
Test Mode :	TX A Mode 5825MHz		

Freq. (MHz)	Ant.Pd. HV	Reading		Ant./CF CF(dB)	Act.		Limit		Note
		Peak (dBuV)	AV (dBuV)		Peak (dBuV/m)	AV (dBuV/m)	Peak (dBuV/m)	AV (dBuV/m)	
5824.90	V	56.73	48.61	44.69	101.42	93.30			X/F
#5850.00	V	13.63	2.03	44.78	58.41	46.81	81.42	73.30	X/E
11651.60	V	32.85	26.03	18.87	51.72	44.90	74.00	54.00	X/H

Remark:

- (1) All readings are Peak unless otherwise stated QP in column of 『Note』 . Peak denotes that the Peak reading compliance with the QP Limits and then QP Mode measurement didn't perform ◦
- (2) Measuring frequency range from 30MHz to 1000MHz or the 10th harmonic of highest fundamental frequency ◦ "F" denotes fundamental frequency; "H" denotes spurious frequency. "E" denotes band edge frequency. (This judgment method includes the Band Edge Requirement.)
- (3) Radiated emissions measured in frequency range above 1000MHz were made with an instrument using Peak detector mode and AV detector mode of the emission ◦
- (4) Data of measurement within this frequency range shown " * " in the table above means the reading of emissions are attenuated more than 20dB below the permissible limits or the field strength is too small to be measured.
- (5) A preamp and high pass filter were used for this test in order to provide sufficient measurement sensitivity.
- (6) EUT Orthogonal Axis:
"X" - denotes Laid on Table ; "Y" - denotes Vertical Stand ; "Z" - denotes Side Stand
- (7) During the measurements above 1 GHz it is taken care of that the EUT is always within the 3 dB cone of radiation BW of the used antenna
- (8) "#" The radiated frequency is out of the restricted band. Limit line= fundamental - 20dB



TX CH165 (Above 1000 MHz, Vertical)

116.0 dBuV/m

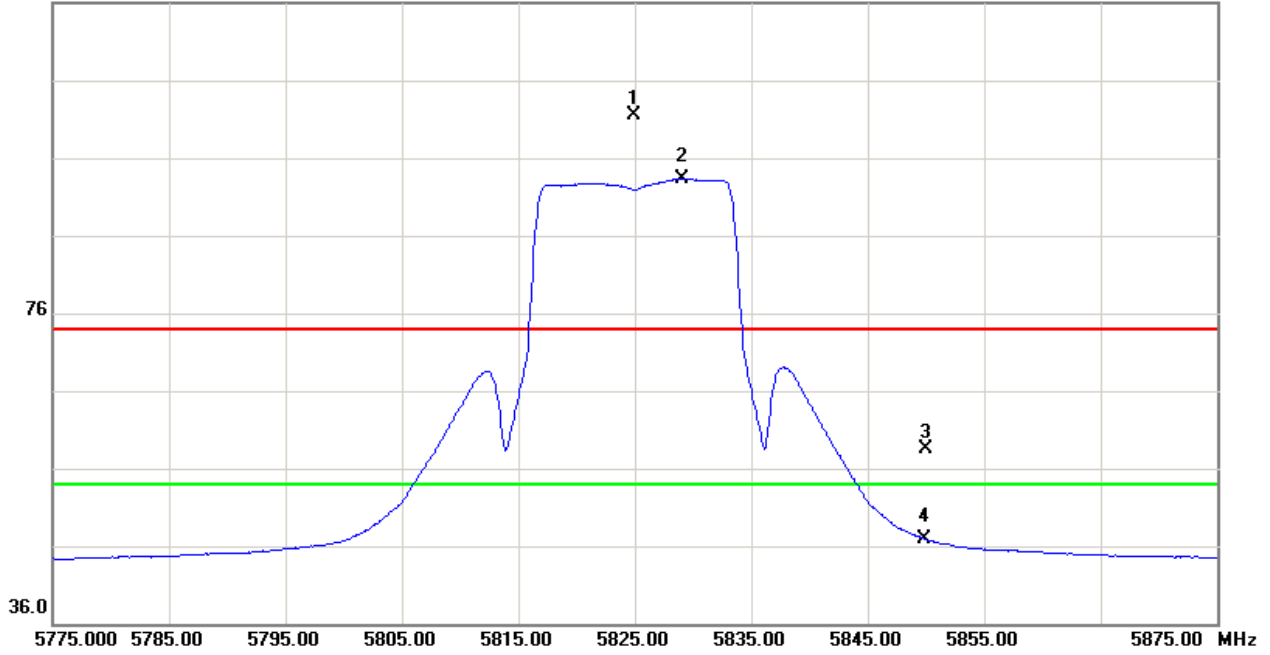

80.0 dBuV/m

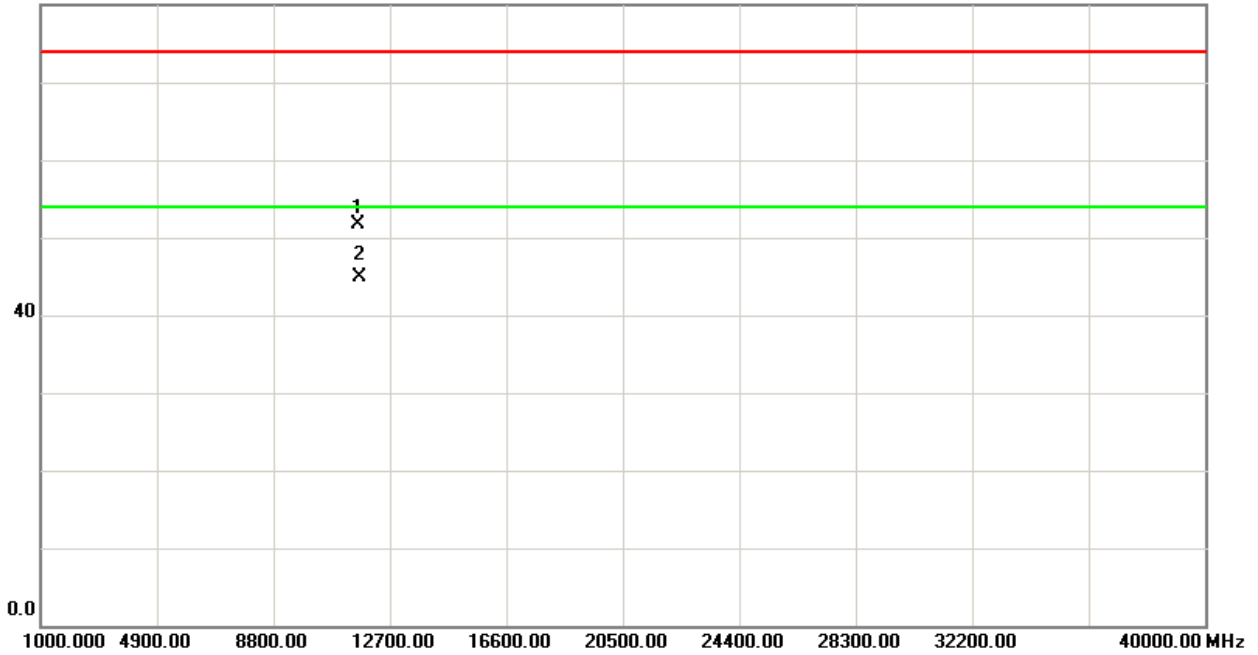



EUT:	High Power Dual Band Wireless 900N Low Profile Access Point	Model Name :	XAP-1500
Temperature:	25 °C	Relative Humidity:	58 %
Pressure:	1010 hPa	Test Voltage :	AC 120V/60Hz
Test Mode :	TX A Mode 5825MHz		

Freq. (MHz)	Ant.Pd. HV	Reading		Ant./CF CF(dB)	Act.		Limit		Note
		Peak (dBuV)	AV (dBuV)		Peak (dBuV/m)	AV (dBuV/m)	Peak (dBuV/m)	AV (dBuV/m)	
5828.30	H	44.39	37.00	44.70	89.09	81.70			X/F
#5850.00	H	14.70	5.21	44.78	59.48	49.99	69.09	61.70	X/E
11653.20	H	30.52	23.68	18.87	49.39	42.55	74.00	54.00	X/H

Remark:

- (1) All readings are Peak unless otherwise stated QP in column of 『Note』 . Peak denotes that the Peak reading compliance with the QP Limits and then QP Mode measurement didn't perform ◦
- (2) Measuring frequency range from 30MHz to 1000MHz or the 10th harmonic of highest fundamental frequency ◦ "F" denotes fundamental frequency; "H" denotes spurious frequency. "E" denotes band edge frequency. (This judgment method includes the Band Edge Requirement.)
- (3) Radiated emissions measured in frequency range above 1000MHz were made with an instrument using Peak detector mode and AV detector mode of the emission ◦
- (4) Data of measurement within this frequency range shown " * " in the table above means the reading of emissions are attenuated more than 20dB below the permissible limits or the field strength is too small to be measured.
- (5) A preamp and high pass filter were used for this test in order to provide sufficient measurement sensitivity.
- (6) EUT Orthogonal Axis:
"X" - denotes Laid on Table ; "Y" - denotes Vertical Stand ; "Z" - denotes Side Stand
- (7) During the measurements above 1 GHz it is taken care of that the EUT is always within the 3 dB cone of radiation BW of the used antenna
- (8) "#" The radiated frequency is out of the restricted band. Limit line= fundamental - 20dB



TX CH165 (Above 1000 MHz, Horizontal)

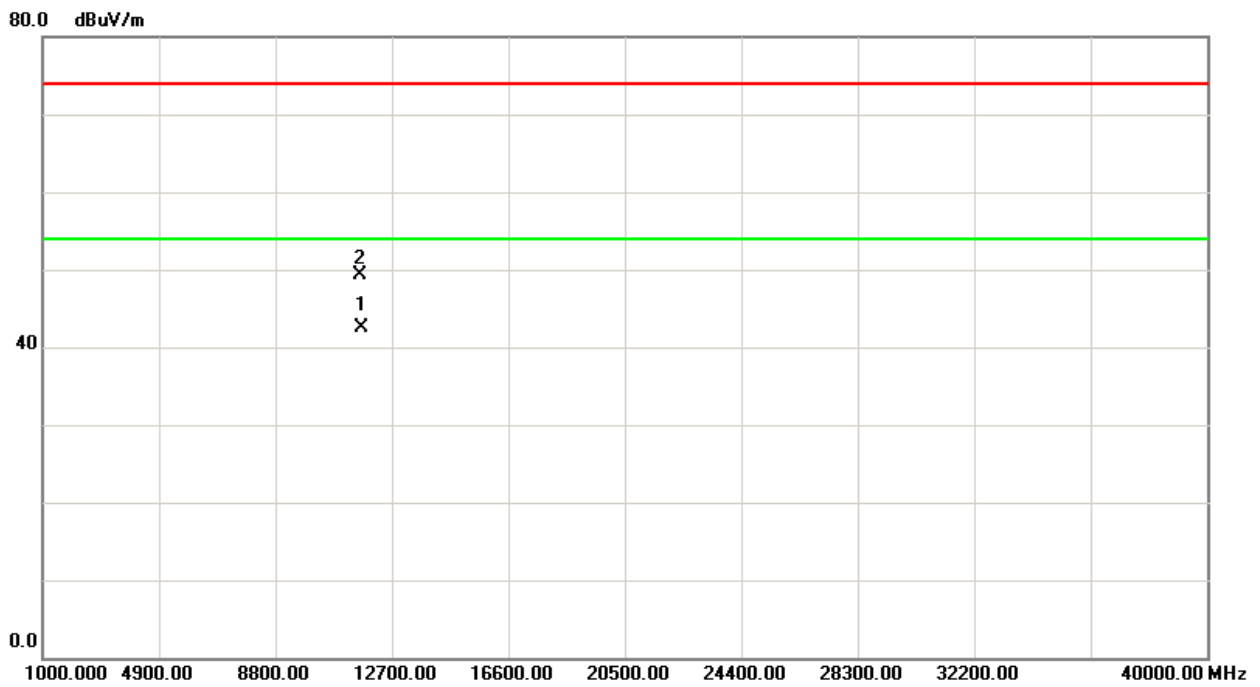
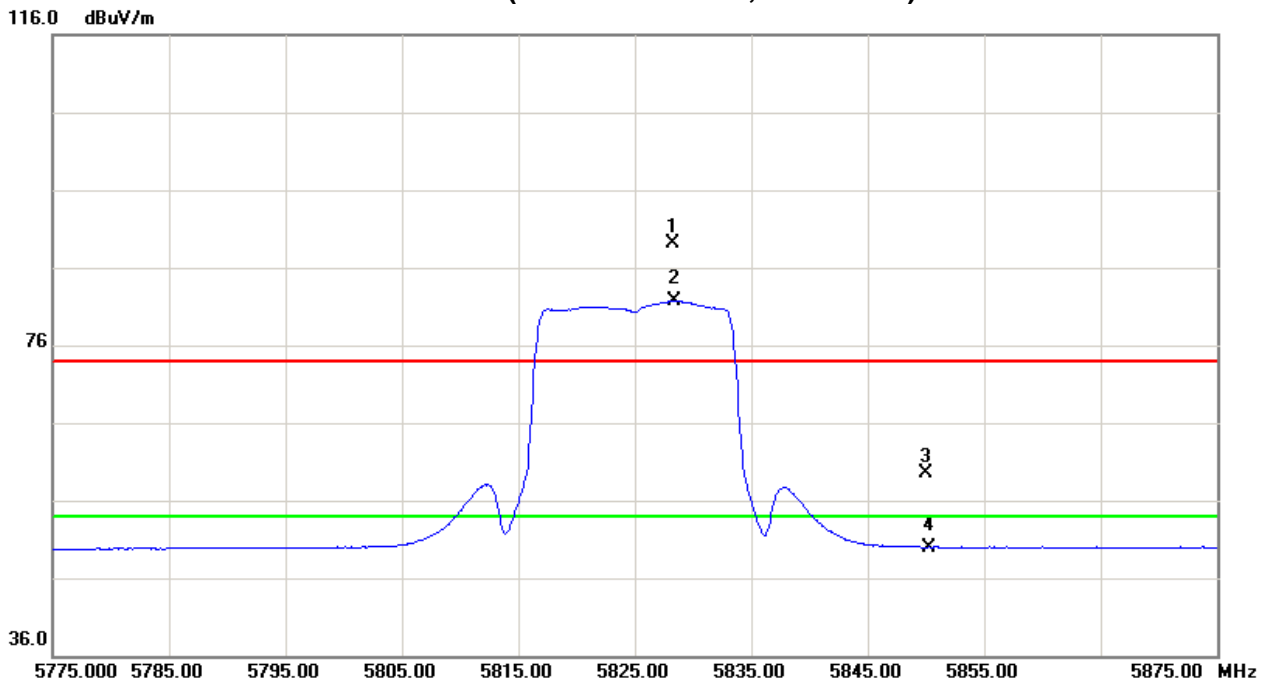



EUT:	High Power Dual Band Wireless 900N Low Profile Access Point	Model Name :	XAP-1500
Temperature:	25 °C	Relative Humidity:	58 %
Pressure:	1010 hPa	Test Voltage :	AC 120V/60Hz
Test Mode :	TX N20 Mode 5745MHz		

Freq. (MHz)	Ant.Pol. H/V	Reading		Ant./CF CF(dB)	Act.		Limit		Note
		Peak (dBuV)	AV (dBuV)		Peak (dBuV/m)	AV (dBuV/m)	Peak (dBuV/m)	AV (dBuV/m)	
# 5725.00	V	18.95	9.72	44.34	63.29	54.06	84.88	74.77	X/E
5749.20	V	60.48	50.37	44.40	104.88	94.77			X/F
11491.50	V	32.96	26.75	18.47	51.43	45.22	74.00	54.00	X/H

Remark:

- (1) All readings are Peak unless otherwise stated QP in column of 『Note』 . Peak denotes that the Peak reading compliance with the QP Limits and then QP Mode measurement didn't perform ◦
- (2) Measuring frequency range from 30MHz to 1000MHz or the 10th harmonic of highest fundamental frequency ◦ "F" denotes fundamental frequency; "H" denotes spurious frequency. "E" denotes band edge frequency. (This judgment method includes the Band Edge Requirement.)
- (3) Radiated emissions measured in frequency range above 1000MHz were made with an instrument using Peak detector mode and AV detector mode of the emission ◦
- (4) Data of measurement within this frequency range shown " * " in the table above means the reading of emissions are attenuated more than 20dB below the permissible limits or the field strength is too small to be measured.
- (5) A preamp and high pass filter were used for this test in order to provide sufficient measurement sensitivity.
- (6) EUT Orthogonal Axis:
"X" - denotes Laid on Table ; "Y" - denotes Vertical Stand ; "Z" - denotes Side Stand
- (7) During the measurements above 1 GHz it is taken care of that the EUT is always within the 3 dB cone of radiation BW of the used antenna
- (8) "#" The radiated frequency is out of the restricted band. Limit line= fundamental - 20dB



TX CH149 (Above 1000 MHz, Vertical)

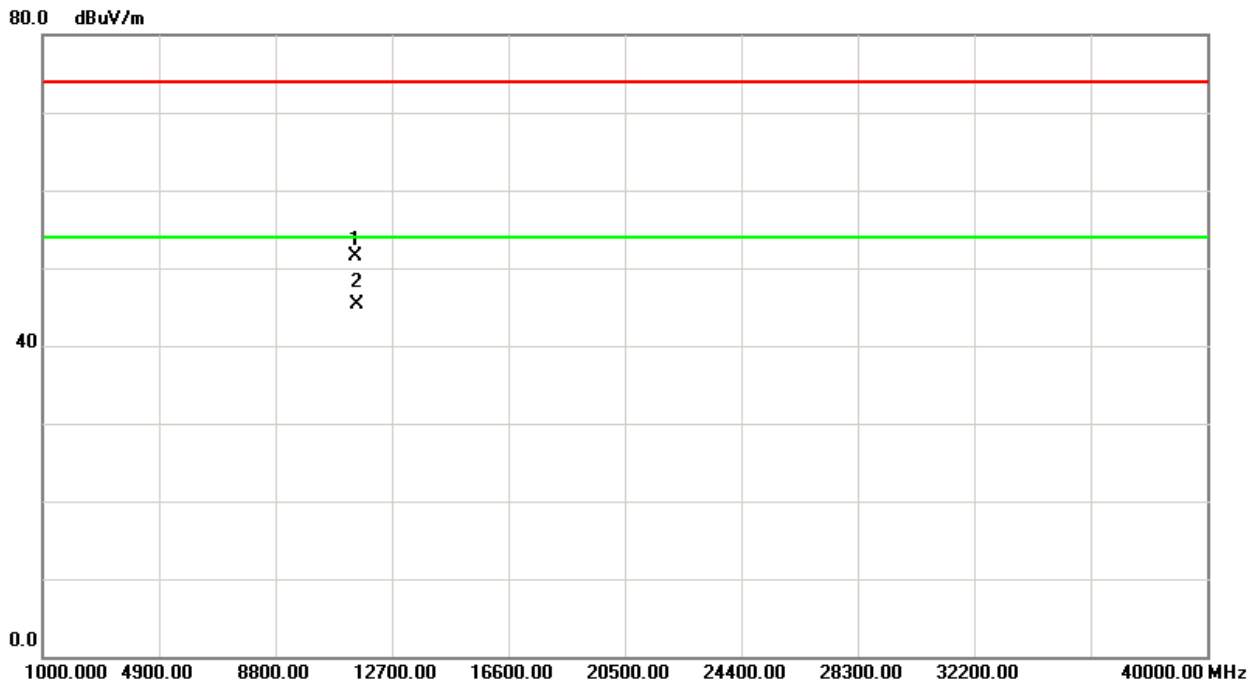
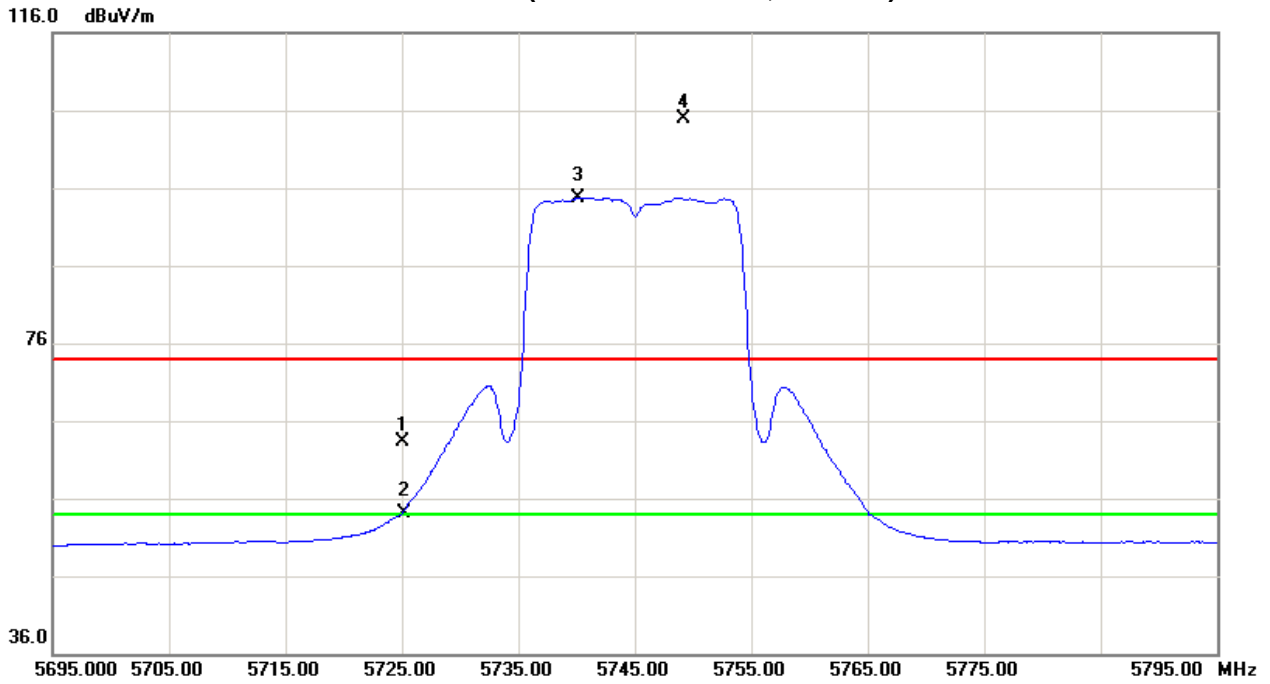



EUT:	High Power Dual Band Wireless 900N Low Profile Access Point	Model Name :	XAP-1500
Temperature:	25 °C	Relative Humidity:	58 %
Pressure:	1010 hPa	Test Voltage :	AC 120V/60Hz
Test Mode :	TX N20 Mode 5745MHz		

Freq. (MHz)	Ant.Pol. H/V	Reading		Ant./CF CF(dB)	Act.		Limit		Note
		Peak (dBuV)	AV (dBuV)		Peak (dBuV/m)	AV (dBuV/m)	Peak (dBuV/m)	AV (dBuV/m)	
# 5725.00	H	14.50	5.54	44.34	58.84	49.88	72.74	62.32	X/E
5740.10	H	48.34	37.92	44.40	92.74	82.32			X/F
11491.50	H	31.26	25.48	18.47	49.73	43.95	74.00	54.00	X/H

Remark:

- (1) All readings are Peak unless otherwise stated QP in column of 『Note』 . Peak denotes that the Peak reading compliance with the QP Limits and then QP Mode measurement didn't perform ◦
- (2) Measuring frequency range from 30MHz to 1000MHz or the 10th harmonic of highest fundamental frequency ◦ "F" denotes fundamental frequency; "H" denotes spurious frequency. "E" denotes band edge frequency. (This judgment method includes the Band Edge Requirement.)
- (3) Radiated emissions measured in frequency range above 1000MHz were made with an instrument using Peak detector mode and AV detector mode of the emission ◦
- (4) Data of measurement within this frequency range shown " * " in the table above means the reading of emissions are attenuated more than 20dB below the permissible limits or the field strength is too small to be measured.
- (5) A preamp and high pass filter were used for this test in order to provide sufficient measurement sensitivity.
- (6) EUT Orthogonal Axis:
"X" - denotes Laid on Table ; "Y" - denotes Vertical Stand ; "Z" - denotes Side Stand
- (7) During the measurements above 1 GHz it is taken care of that the EUT is always within the 3 dB cone of radiation BW of the used antenna
- (8) "#" The radiated frequency is out of the restricted band. Limit line= fundamental - 20dB



TX CH149 (Above 1000 MHz, Horizontal)

116.0 dBuV/m

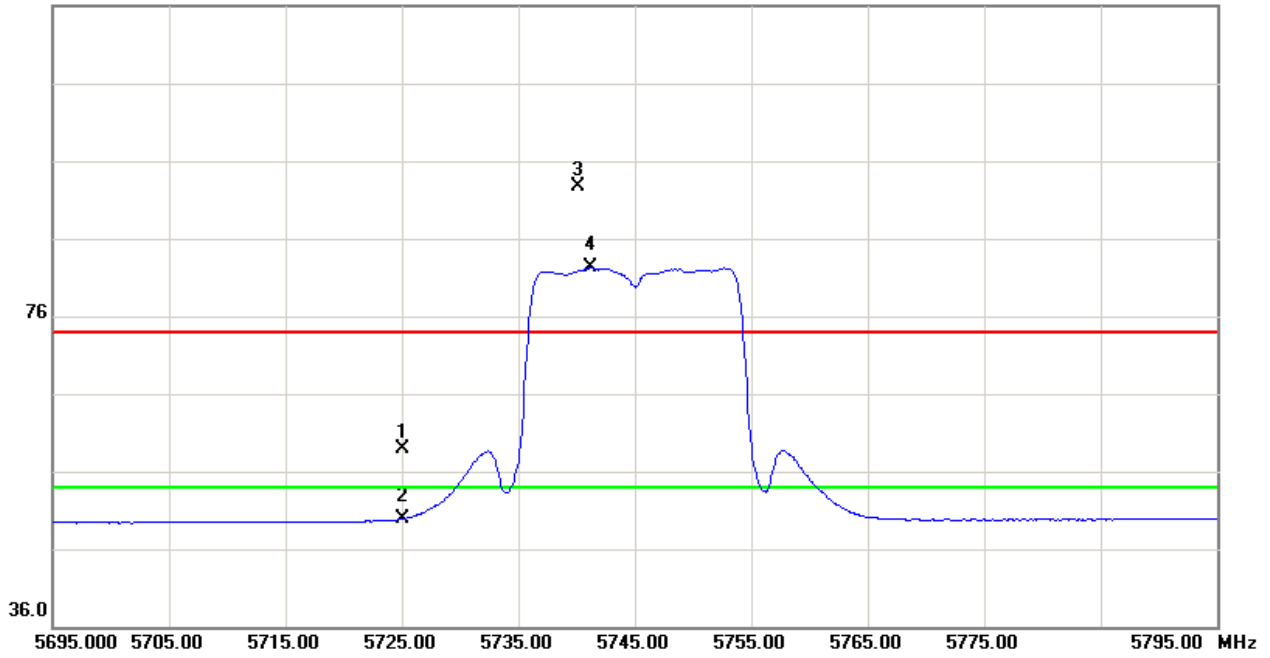

80.0 dBuV/m

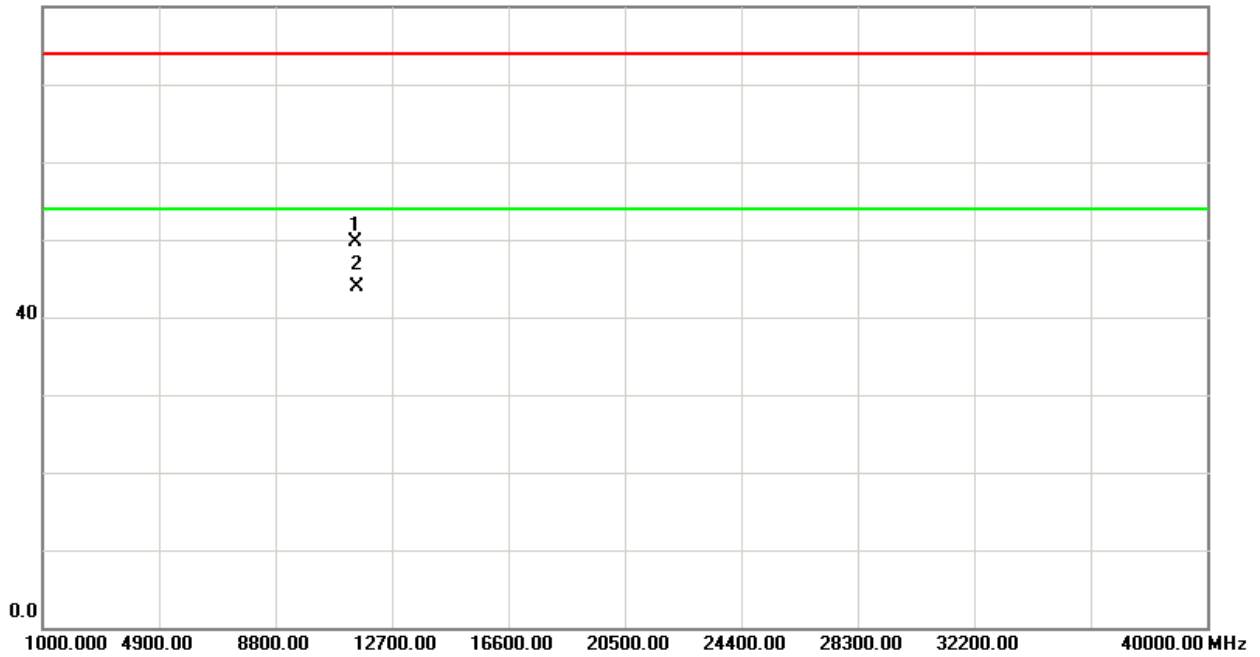



EUT:	High Power Dual Band Wireless 900N Low Profile Access Point	Model Name :	XAP-1500
Temperature:	25 °C	Relative Humidity:	58 %
Pressure:	1010 hPa	Test Voltage :	AC 120V/60Hz
Test Mode :	TX N20 Mode 5785MHz		

Freq. (MHz)	Ant.Pol. H/V	Reading		Ant./CF CF(dB)	Act.		Limit		Note
		Peak (dBuV)	AV (dBuV)		Peak (dBuV/m)	AV (dBuV/m)	Peak (dBuV/m)	AV (dBuV/m)	
5781.80	V	58.79	48.92	44.55	103.34	93.47			X/F
11569.33	V	32.84	26.15	18.67	51.51	44.82	74.00	54.00	X/H

Remark:

- (1) All readings are Peak unless otherwise stated QP in column of 『Note』 . Peak denotes that the Peak reading compliance with the QP Limits and then QP Mode measurement didn't perform ◦
- (2) Measuring frequency range from 30MHz to 1000MHz or the 10th harmonic of highest fundamental frequency ◦ "F" denotes fundamental frequency; "H" denotes spurious frequency. "E" denotes band edge frequency. (This judgment method includes the Band Edge Requirement.)
- (3) Radiated emissions measured in frequency range above 1000MHz were made with an instrument using Peak detector mode and AV detector mode of the emission ◦
- (4) Data of measurement within this frequency range shown " * " in the table above means the reading of emissions are attenuated more than 20dB below the permissible limits or the field strength is too small to be measured.
- (5) A preamp and high pass filter were used for this test in order to provide sufficient measurement sensitivity.
- (6) EUT Orthogonal Axis:
"X" - denotes Laid on Table ; "Y" - denotes Vertical Stand ; "Z" - denotes Side Stand
- (7) During the measurements above 1 GHz it is taken care of that the EUT is always within the 3 dB cone of radiation BW of the used antenna



TX CH157 (Above 1000 MHz, Vertical)

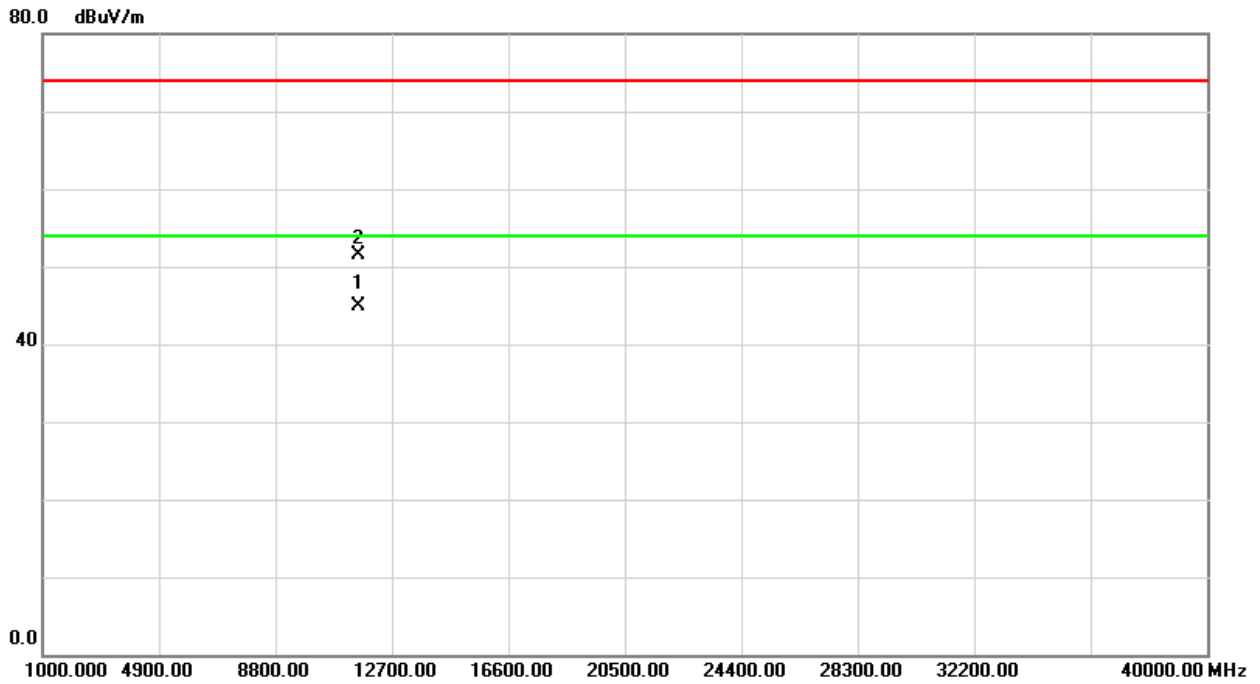
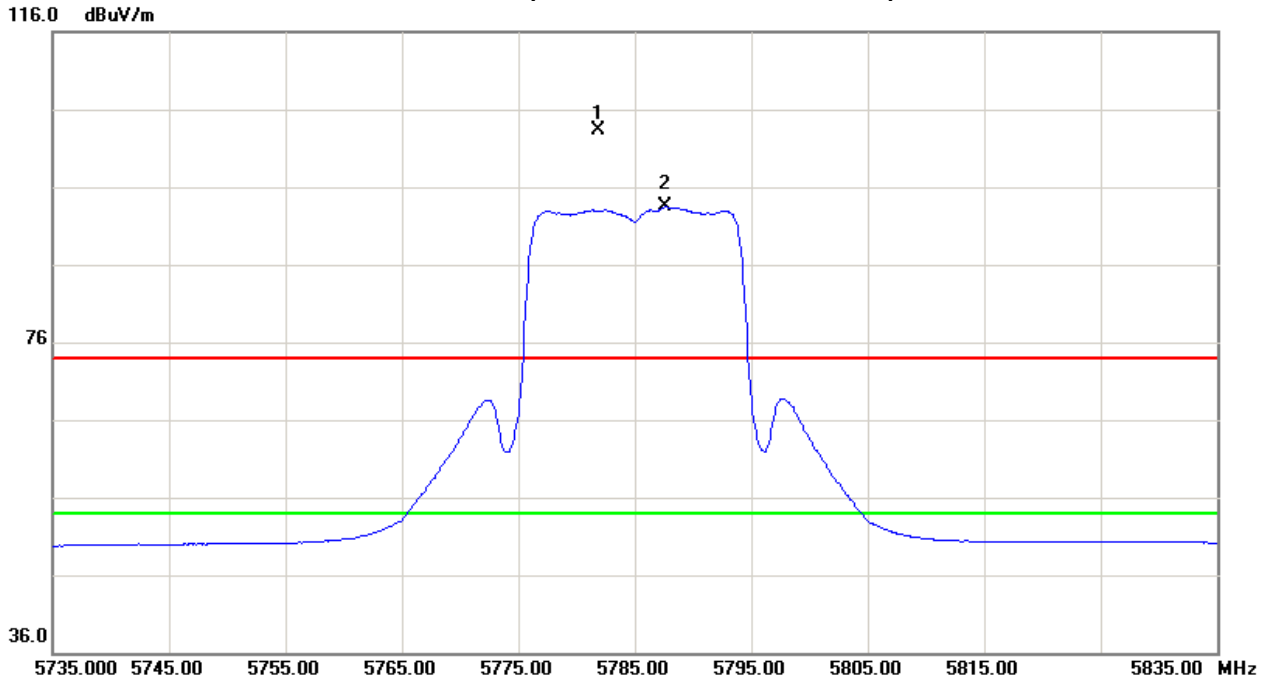



EUT:	High Power Dual Band Wireless 900N Low Profile Access Point	Model Name :	XAP-1500
Temperature:	25 °C	Relative Humidity:	58 %
Pressure:	1010 hPa	Test Voltage :	AC 120V/60Hz
Test Mode :	TX N20 Mode 5785MHz		

Freq. (MHz)	Ant.Pol. H/V	Reading		Ant./CF CF(dB)	Act.		Limit		Note
		Peak (dBuV)	AV (dBuV)		Peak (dBuV/m)	AV (dBuV/m)	Peak (dBuV/m)	AV (dBuV/m)	
5777.70	H	47.87	37.87	44.53	92.40	82.40			X/F
11573.80	H	29.87	23.11	18.67	48.54	41.78	74.00	54.00	X/H

Remark:

- (1) All readings are Peak unless otherwise stated QP in column of 『Note』 . Peak denotes that the Peak reading compliance with the QP Limits and then QP Mode measurement didn't perform ◦
- (2) Measuring frequency range from 30MHz to 1000MHz or the 10th harmonic of highest fundamental frequency ◦ "F" denotes fundamental frequency; "H" denotes spurious frequency. "E" denotes band edge frequency. (This judgment method includes the Band Edge Requirement.)
- (3) Radiated emissions measured in frequency range above 1000MHz were made with an instrument using Peak detector mode and AV detector mode of the emission ◦
- (4) Data of measurement within this frequency range shown " * " in the table above means the reading of emissions are attenuated more than 20dB below the permissible limits or the field strength is too small to be measured.
- (5) A preamp and high pass filter were used for this test in order to provide sufficient measurement sensitivity.
- (6) EUT Orthogonal Axis:
"X" - denotes Laid on Table ; "Y" - denotes Vertical Stand ; "Z" - denotes Side Stand
- (7) During the measurements above 1 GHz it is taken care of that the EUT is always within the 3 dB cone of radiation BW of the used antenna



TX CH157 (Above 1000 MHz, Horizontal)

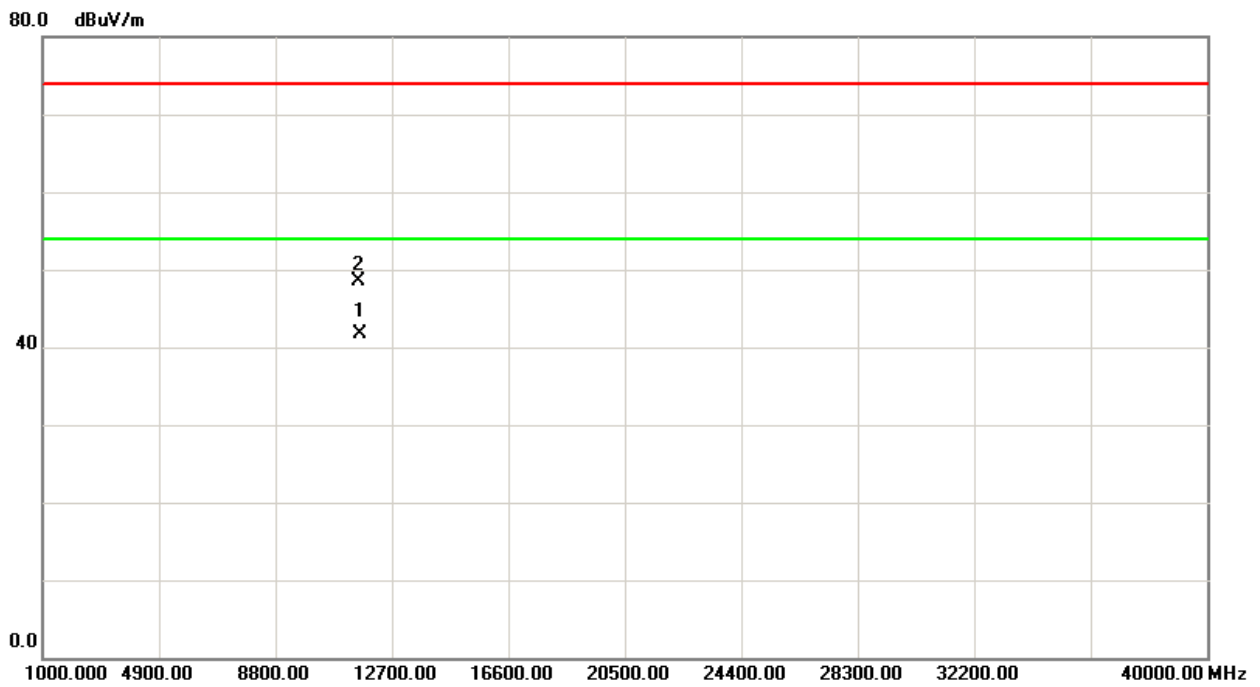
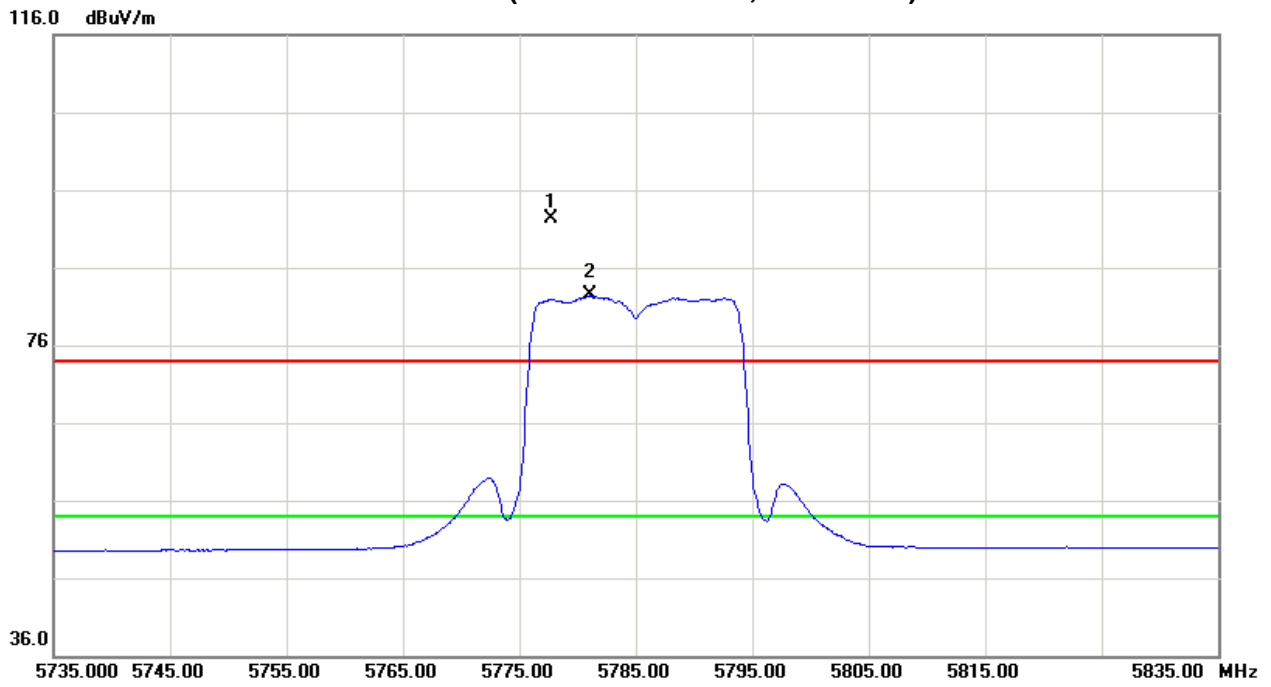



EUT:	High Power Dual Band Wireless 900N Low Profile Access Point	Model Name :	XAP-1500
Temperature:	25 °C	Relative Humidity:	58 %
Pressure:	1010 hPa	Test Voltage :	AC 120V/60Hz
Test Mode :	TX N20 Mode 5825MHz		

Freq. (MHz)	Ant.Pol. H/V	Reading		Ant./CF CF(dB)	Act.		Limit		Note
		Peak (dBuV)	AV (dBuV)		Peak (dBuV/m)	AV (dBuV/m)	Peak (dBuV/m)	AV (dBuV/m)	
5827.20	V	59.64	48.43	44.70	104.34	93.13			X/F
#5850.00	V	13.80	6.02	44.78	58.58	50.80	84.34	73.13	X/E
11649.20	V	32.26	25.42	18.87	51.13	44.29	74.00	54.00	X/H

Remark:

- (1) All readings are Peak unless otherwise stated QP in column of 『Note』 . Peak denotes that the Peak reading compliance with the QP Limits and then QP Mode measurement didn't perform ◦
- (2) Measuring frequency range from 30MHz to 1000MHz or the 10th harmonic of highest fundamental frequency ◦ "F" denotes fundamental frequency; "H" denotes spurious frequency. "E" denotes band edge frequency. (This judgment method includes the Band Edge Requirement.)
- (3) Radiated emissions measured in frequency range above 1000MHz were made with an instrument using Peak detector mode and AV detector mode of the emission ◦
- (4) Data of measurement within this frequency range shown " * " in the table above means the reading of emissions are attenuated more than 20dB below the permissible limits or the field strength is too small to be measured.
- (5) A preamp and high pass filter were used for this test in order to provide sufficient measurement sensitivity.
- (6) EUT Orthogonal Axis:
"X" - denotes Laid on Table ; "Y" - denotes Vertical Stand ; "Z" - denotes Side Stand
- (7) During the measurements above 1 GHz it is taken care of that the EUT is always within the 3 dB cone of radiation BW of the used antenna
- (8) "#" The radiated frequency is out of the restricted band. Limit line= fundamental - 20dB



TX CH165 (Above 1000 MHz, Vertical)

116.0 dBuV/m

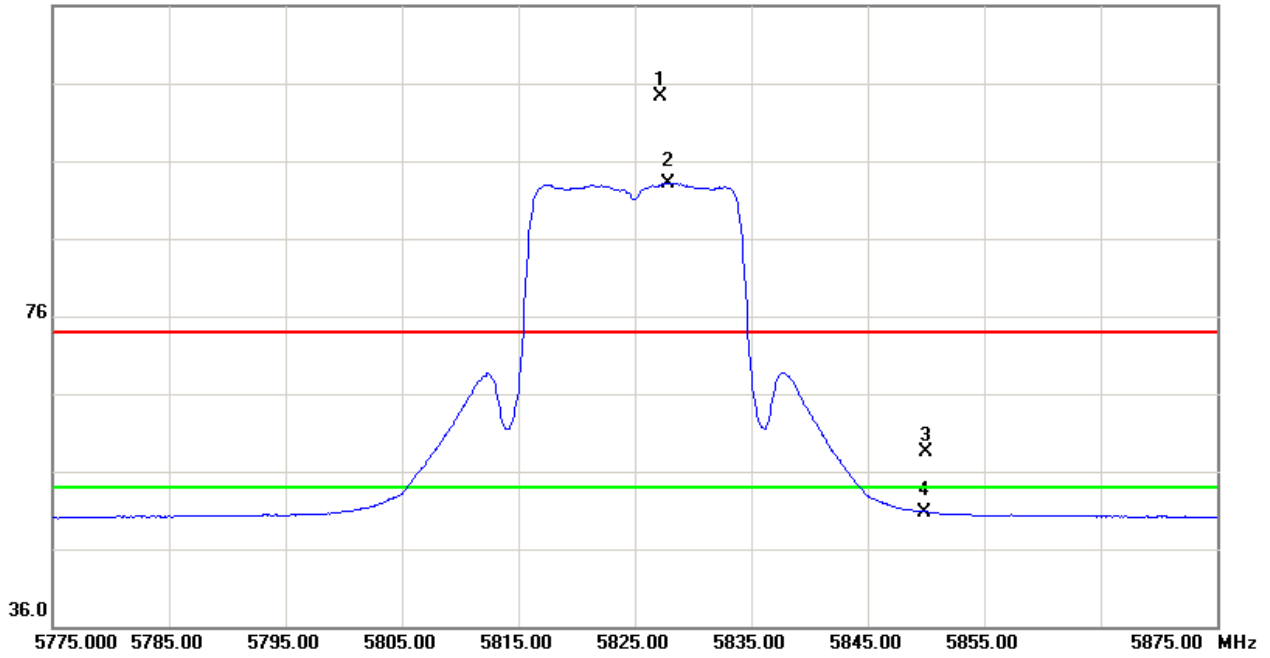

80.0 dBuV/m

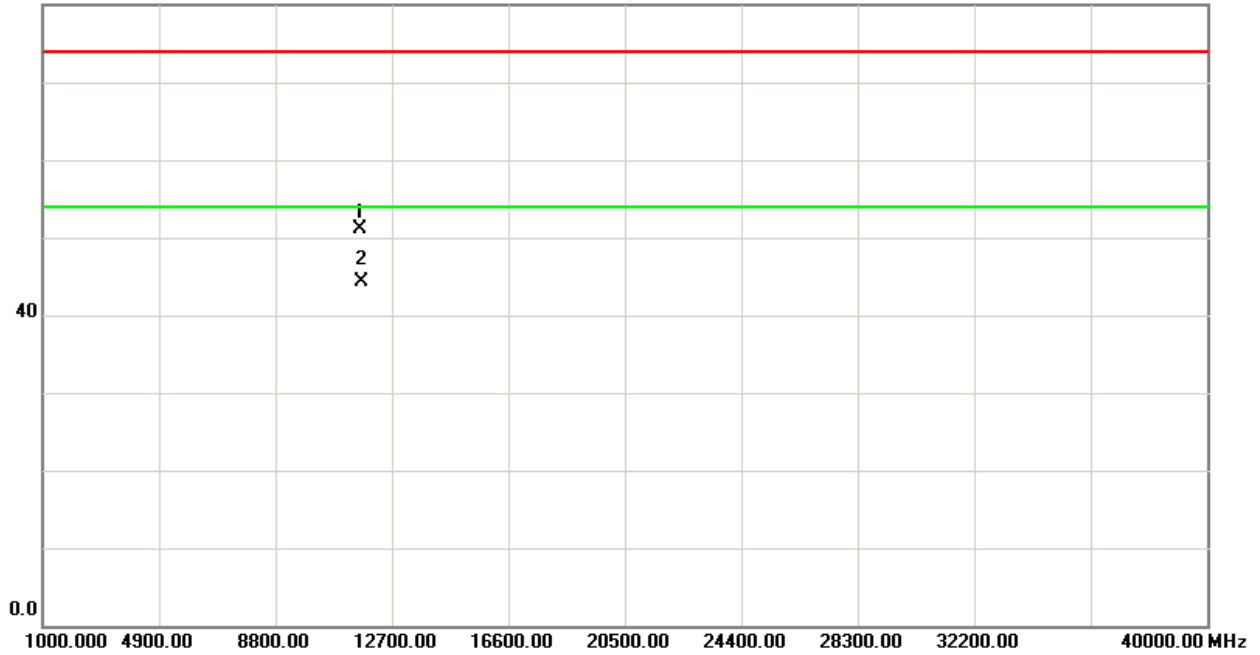



EUT:	High Power Dual Band Wireless 900N Low Profile Access Point	Model Name :	XAP-1500
Temperature:	25 °C	Relative Humidity:	58 %
Pressure:	1010 hPa	Test Voltage :	AC 120V/60Hz
Test Mode :	TX N20 Mode 5825MHz		

Freq. (MHz)	Ant.Pol. H/V	Reading		Ant./CF CF(dB)	Act.		Limit		Note
		Peak (dBuV)	AV (dBuV)		Peak (dBuV/m)	AV (dBuV/m)	Peak (dBuV/m)	AV (dBuV/m)	
5818.10	H	47.97	37.15	44.66	92.63	81.81			X/F
#5850.00	H	13.01	5.25	44.78	57.79	50.03	72.63	61.81	X/E
11653.50	H	30.02	23.14	18.87	48.89	42.01	74.00	54.00	X/H

Remark:

- (1) All readings are Peak unless otherwise stated QP in column of 『Note』 . Peak denotes that the Peak reading compliance with the QP Limits and then QP Mode measurement didn't perform ◦
- (2) Measuring frequency range from 30MHz to 1000MHz or the 10th harmonic of highest fundamental frequency ◦ "F" denotes fundamental frequency; "H" denotes spurious frequency. "E" denotes band edge frequency. (This judgment method includes the Band Edge Requirement.)
- (3) Radiated emissions measured in frequency range above 1000MHz were made with an instrument using Peak detector mode and AV detector mode of the emission ◦
- (4) Data of measurement within this frequency range shown " * " in the table above means the reading of emissions are attenuated more than 20dB below the permissible limits or the field strength is too small to be measured.
- (5) A preamp and high pass filter were used for this test in order to provide sufficient measurement sensitivity.
- (6) EUT Orthogonal Axis:
"X" - denotes Laid on Table ; "Y" - denotes Vertical Stand ; "Z" - denotes Side Stand
- (7) During the measurements above 1 GHz it is taken care of that the EUT is always within the 3 dB cone of radiation BW of the used antenna
- (8) "#" The radiated frequency is out of the restricted band. Limit line= fundamental - 20dB



TX CH165 (Above 1000 MHz, Horizontal)

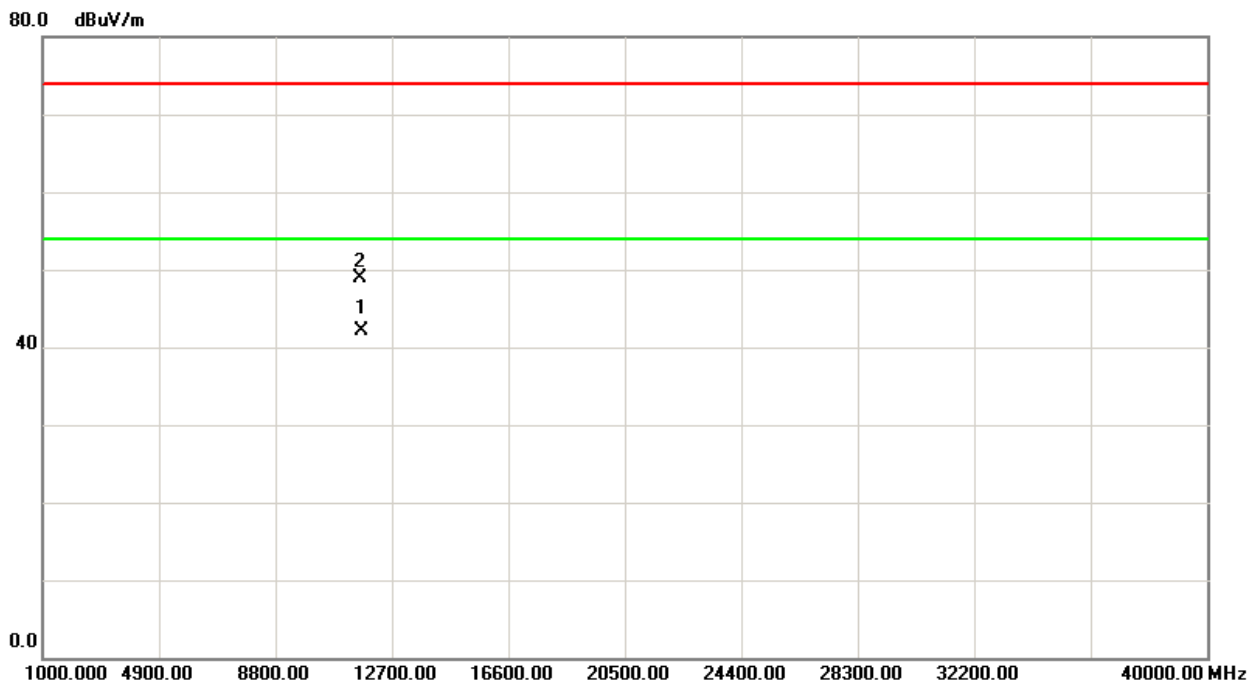
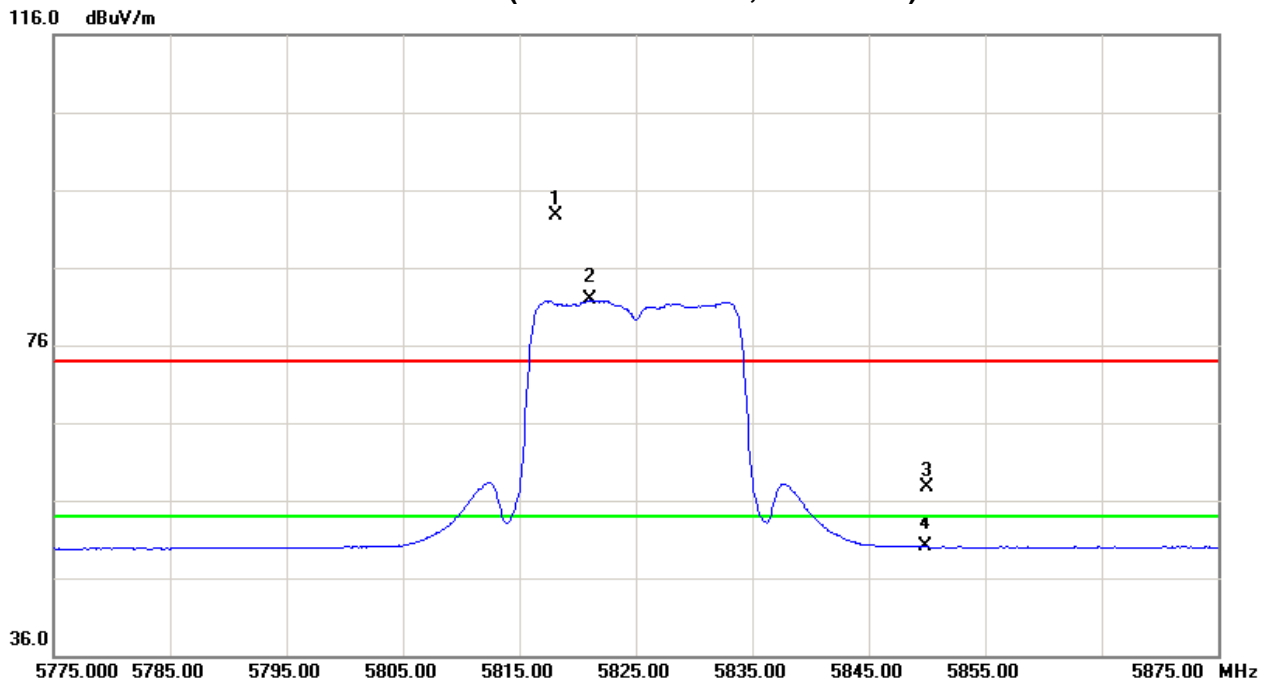



EUT:	High Power Dual Band Wireless 900N Low Profile Access Point	Model Name :	XAP-1500
Temperature:	25 °C	Relative Humidity:	58 %
Pressure:	1010 hPa	Test Voltage :	AC 120V/60Hz
Test Mode :	TX N40 Mode 5755MHz		

Freq. (MHz)	Ant.Pol. H/V	Reading		Ant./CF CF(dB)	Act.		Limit		Note
		Peak (dBuV)	AV (dBuV)		Peak (dBuV/m)	AV (dBuV/m)	Peak (dBuV/m)	AV (dBuV/m)	
# 5725.00	V	20.09	10.70	44.34	64.43	55.04	85.72	74.50	X/E
5757.20	V	61.27	50.05	44.45	105.72	94.50			X/F
11462.80	V	32.69	25.35	18.40	51.09	43.75	74.00	54.00	X/H

Remark:

- (1) All readings are Peak unless otherwise stated QP in column of 『Note』 . Peak denotes that the Peak reading compliance with the QP Limits and then QP Mode measurement didn't perform ◦
- (2) Measuring frequency range from 30MHz to 1000MHz or the 10th harmonic of highest fundamental frequency ◦“F” denotes fundamental frequency; “H” denotes spurious frequency. “E” denotes band edge frequency. (This judgment method includes the Band Edge Requirement.)
- (3) Radiated emissions measured in frequency range above 1000MHz were made with an instrument using Peak detector mode and AV detector mode of the emission ◦
- (4) Data of measurement within this frequency range shown “ * ” in the table above means the reading of emissions are attenuated more than 20dB below the permissible limits or the field strength is too small to be measured.
- (5) A preamp and high pass filter were used for this test in order to provide sufficient measurement sensitivity.
- (6) EUT Orthogonal Axis:
“X” - denotes Laid on Table ; “Y” - denotes Vertical Stand ; “Z” - denotes Side Stand
- (7) During the measurements above 1 GHz it is taken care of that the EUT is always within the 3 dB cone of radiation BW of the used antenna
- (8) “#” The radiated frequency is out of the restricted band. Limit line= fundamental - 20dB



TX CH151 (Above 1000 MHz, Vertical)

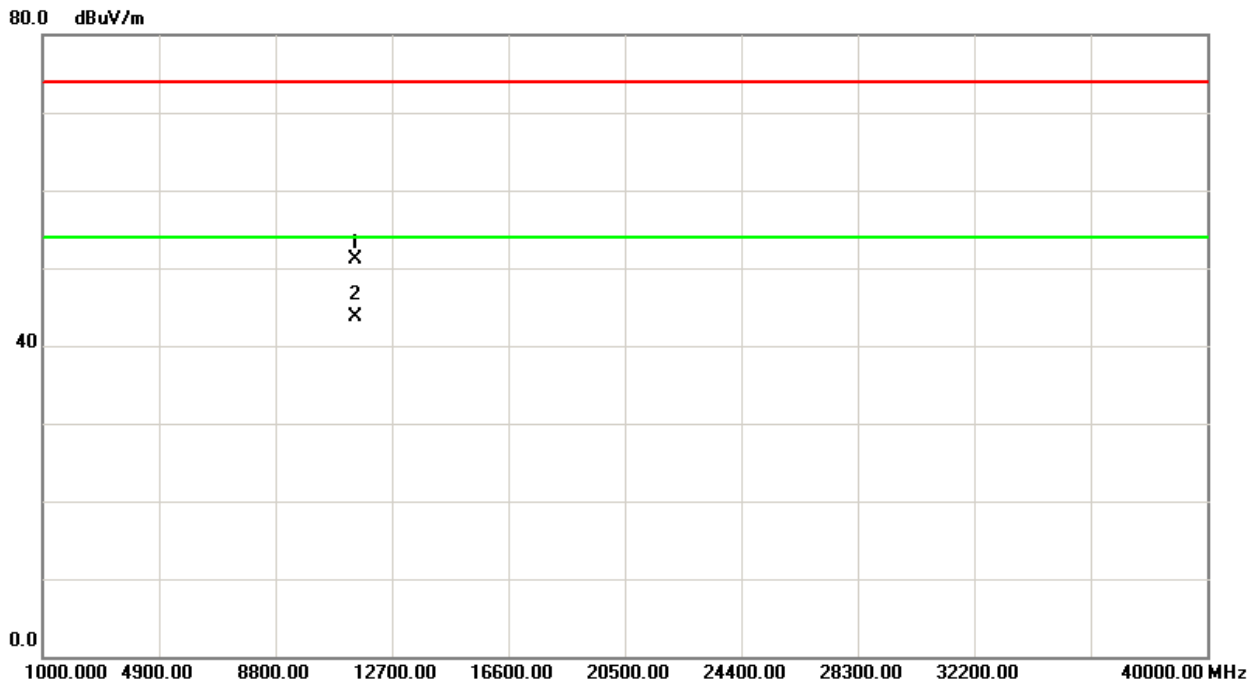
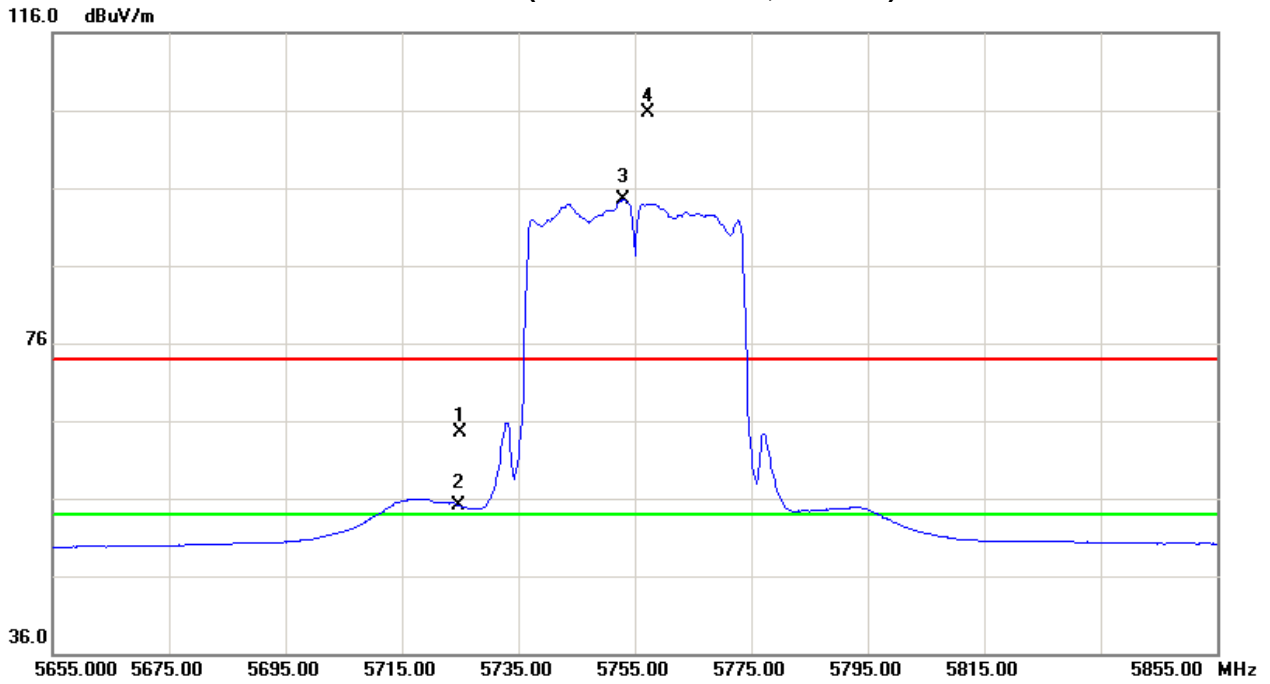



EUT:	High Power Dual Band Wireless 900N Low Profile Access Point	Model Name :	XAP-1500
Temperature:	25 °C	Relative Humidity:	58 %
Pressure:	1010 hPa	Test Voltage :	AC 120V/60Hz
Test Mode :	TX N40 Mode 5755MHz		

Freq. (MHz)	Ant.Pol. H/V	Reading		Ant./CF CF(dB)	Act.		Limit		Note
		Peak (dBuV)	AV (dBuV)		Peak (dBuV/m)	AV (dBuV/m)	Peak (dBuV/m)	AV (dBuV/m)	
# 5725.00	H	15.86	5.64	44.34	60.20	49.98	74.63	62.92	X/E
5758.80	H	50.16	38.45	44.47	94.63	82.92			X/F
11512.50	H	30.62	24.27	18.52	49.14	42.79	74.00	54.00	X/H

Remark:

- (1) All readings are Peak unless otherwise stated QP in column of 『Note』 . Peak denotes that the Peak reading compliance with the QP Limits and then QP Mode measurement didn't perform ◦
- (2) Measuring frequency range from 30MHz to 1000MHz or the 10th harmonic of highest fundamental frequency ◦ "F" denotes fundamental frequency; "H" denotes spurious frequency. "E" denotes band edge frequency. (This judgment method includes the Band Edge Requirement.)
- (3) Radiated emissions measured in frequency range above 1000MHz were made with an instrument using Peak detector mode and AV detector mode of the emission ◦
- (4) Data of measurement within this frequency range shown " * " in the table above means the reading of emissions are attenuated more than 20dB below the permissible limits or the field strength is too small to be measured.
- (5) A preamp and high pass filter were used for this test in order to provide sufficient measurement sensitivity.
- (6) EUT Orthogonal Axis:
"X" - denotes Laid on Table ; "Y" - denotes Vertical Stand ; "Z" - denotes Side Stand
- (7) During the measurements above 1 GHz it is taken care of that the EUT is always within the 3 dB cone of radiation BW of the used antenna
- (8) "#" The radiated frequency is out of the restricted band. Limit line= fundamental - 20dB



TX CH151 (Above 1000 MHz, Horizontal)

116.0 dBuV/m

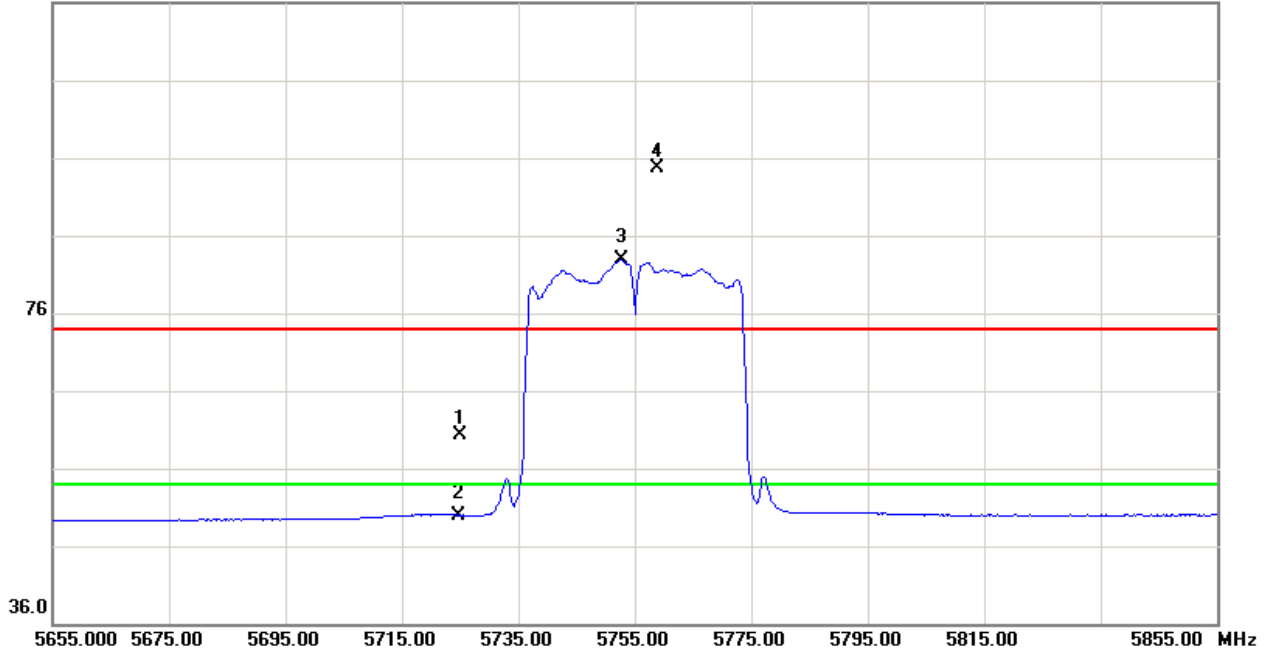

80.0 dBuV/m

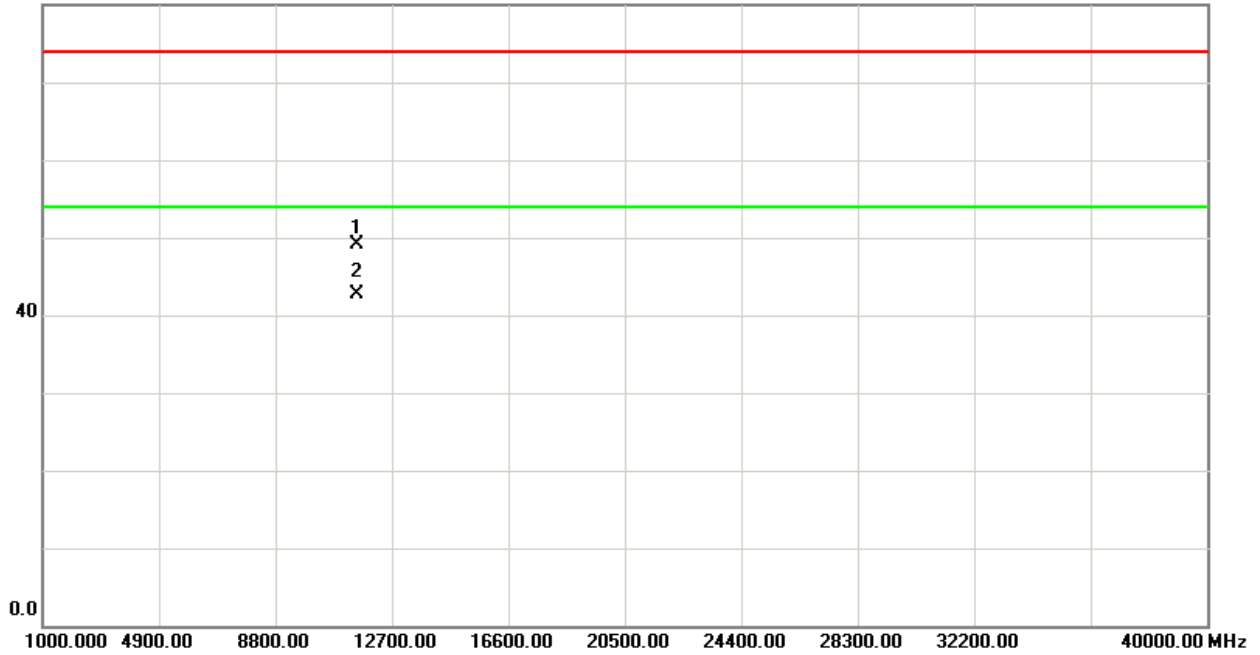



EUT:	High Power Dual Band Wireless 900N Low Profile Access Point	Model Name :	XAP-1500
Temperature:	25 °C	Relative Humidity:	58 %
Pressure:	1010 hPa	Test Voltage :	AC 120V/60Hz
Test Mode :	TX N40 Mode 5795MHz		

Freq. (MHz)	Ant.Pol. H/V	Reading		Ant./CF CF(dB)	Act.		Limit		Note
		Peak (dBuV)	AV (dBuV)		Peak (dBuV/m)	AV (dBuV/m)	Peak (dBuV/m)	AV (dBuV/m)	
5792.00	V	61.49	50.16	44.58	106.07	94.74			X/F
#5850.00	V	14.53	6.17	44.78	44.78	50.95	86.07	74.74	X/E
11589.70	V	32.50	25.69	18.72	51.22	44.41	74.00	54.00	X/H

Remark:

- (1) All readings are Peak unless otherwise stated QP in column of 『Note』 . Peak denotes that the Peak reading compliance with the QP Limits and then QP Mode measurement didn't perform ◦
- (2) Measuring frequency range from 30MHz to 1000MHz or the 10th harmonic of highest fundamental frequency ◦ "F" denotes fundamental frequency; "H" denotes spurious frequency. "E" denotes band edge frequency. (This judgment method includes the Band Edge Requirement.)
- (3) Radiated emissions measured in frequency range above 1000MHz were made with an instrument using Peak detector mode and AV detector mode of the emission ◦
- (4) Data of measurement within this frequency range shown " * " in the table above means the reading of emissions are attenuated more than 20dB below the permissible limits or the field strength is too small to be measured.
- (5) A preamp and high pass filter were used for this test in order to provide sufficient measurement sensitivity.
- (6) EUT Orthogonal Axis:
"X" - denotes Laid on Table ; "Y" - denotes Vertical Stand ; "Z" - denotes Side Stand
- (7) During the measurements above 1 GHz it is taken care of that the EUT is always within the 3 dB cone of radiation BW of the used antenna
- (8) "#" The radiated frequency is out of the restricted band. Limit line= fundamental - 20dB



TX CH159 (Above 1000 MHz, Vertical)

116.0 dBuV/m

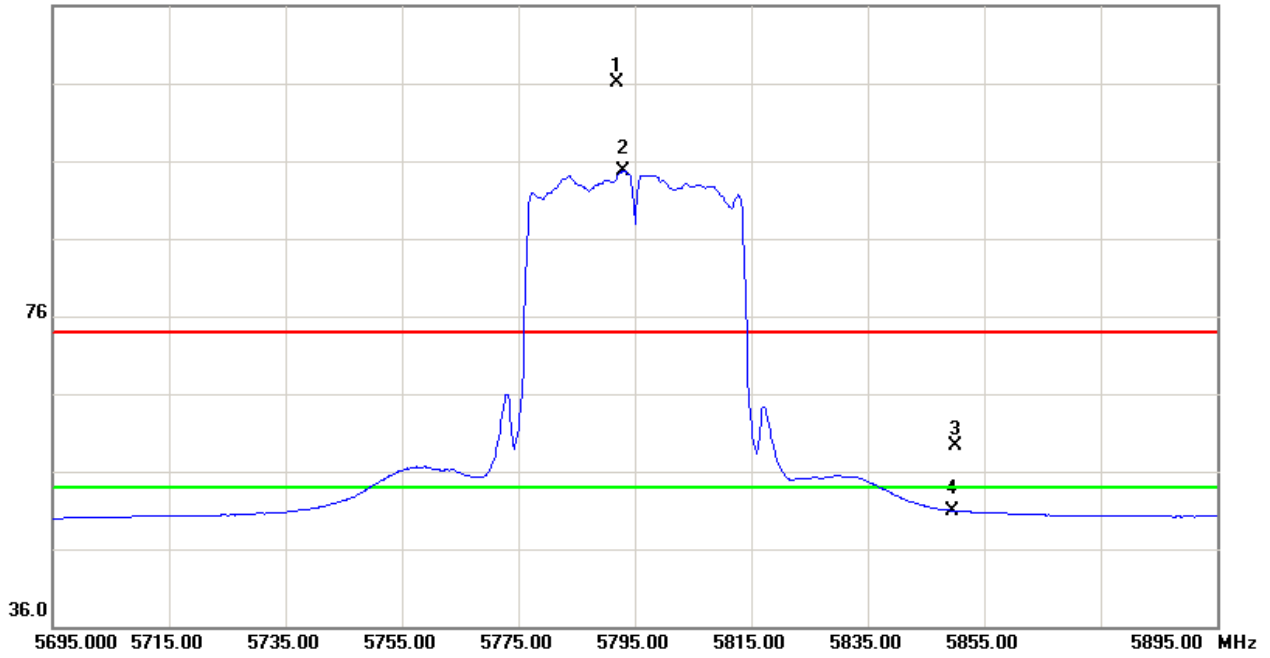

80.0 dBuV/m

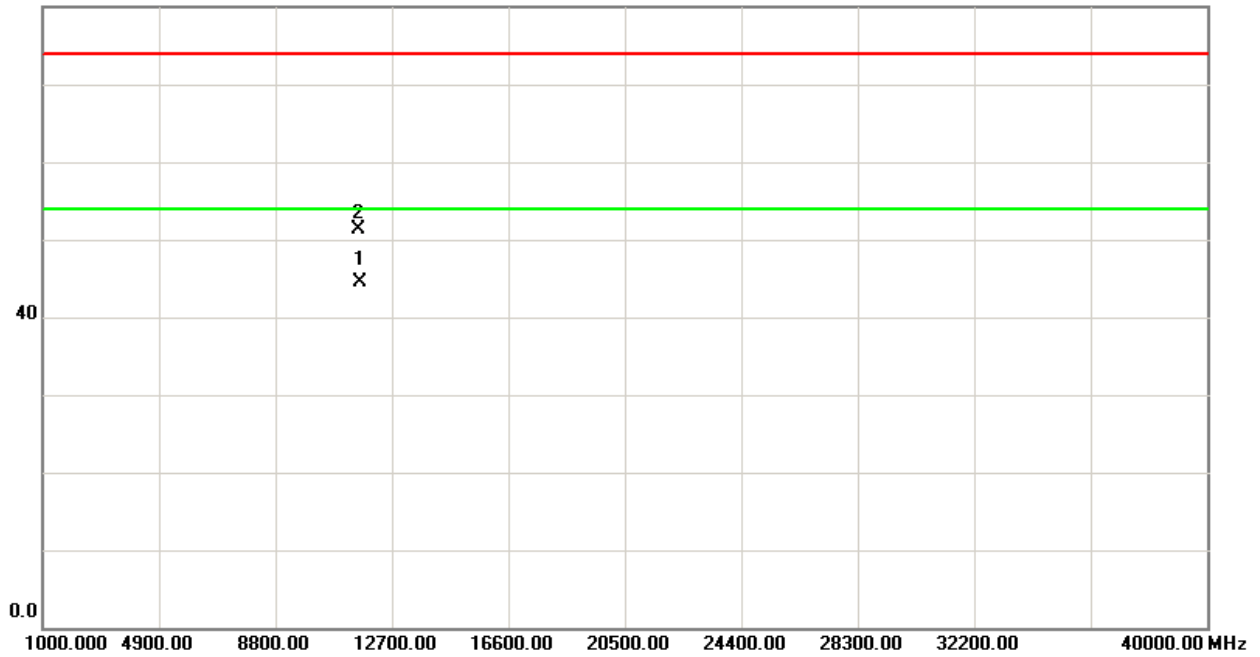



EUT:	High Power Dual Band Wireless 900N Low Profile Access Point	Model Name :	XAP-1500
Temperature:	25 °C	Relative Humidity:	58 %
Pressure:	1010 hPa	Test Voltage :	AC 120V/60Hz
Test Mode :	TX N40 Mode 5795MHz		

Freq. (MHz)	Ant.Pol. H/V	Reading		Ant./CF CF(dB)	Act.		Limit		Note
		Peak (dBuV)	AV (dBuV)		Peak (dBuV/m)	AV (dBuV/m)	Peak (dBuV/m)	AV (dBuV/m)	
5782.40	H	49.27	37.58	44.55	93.82	82.13			X/F
#5850.00	H	14.90	5.27	44.78	59.68	50.05	73.82	62.13	X/E
11596.80	H	29.33	22.68	18.74	48.07	41.42	74.00	54.00	X/H

Remark:

- (1) All readings are Peak unless otherwise stated QP in column of 『Note』 . Peak denotes that the Peak reading compliance with the QP Limits and then QP Mode measurement didn't perform ◦
- (2) Measuring frequency range from 30MHz to 1000MHz or the 10th harmonic of highest fundamental frequency ◦ "F" denotes fundamental frequency; "H" denotes spurious frequency. "E" denotes band edge frequency. (This judgment method includes the Band Edge Requirement.)
- (3) Radiated emissions measured in frequency range above 1000MHz were made with an instrument using Peak detector mode and AV detector mode of the emission ◦
- (4) Data of measurement within this frequency range shown " * " in the table above means the reading of emissions are attenuated more than 20dB below the permissible limits or the field strength is too small to be measured.
- (5) A preamp and high pass filter were used for this test in order to provide sufficient measurement sensitivity.
- (6) EUT Orthogonal Axis:
"X" - denotes Laid on Table ; "Y" - denotes Vertical Stand ; "Z" - denotes Side Stand
- (7) During the measurements above 1 GHz it is taken care of that the EUT is always within the 3 dB cone of radiation BW of the used antenna
- (8) "#" The radiated frequency is out of the restricted band. Limit line= fundamental - 20dB



TX CH159 (Above 1000 MHz, Horizontal)

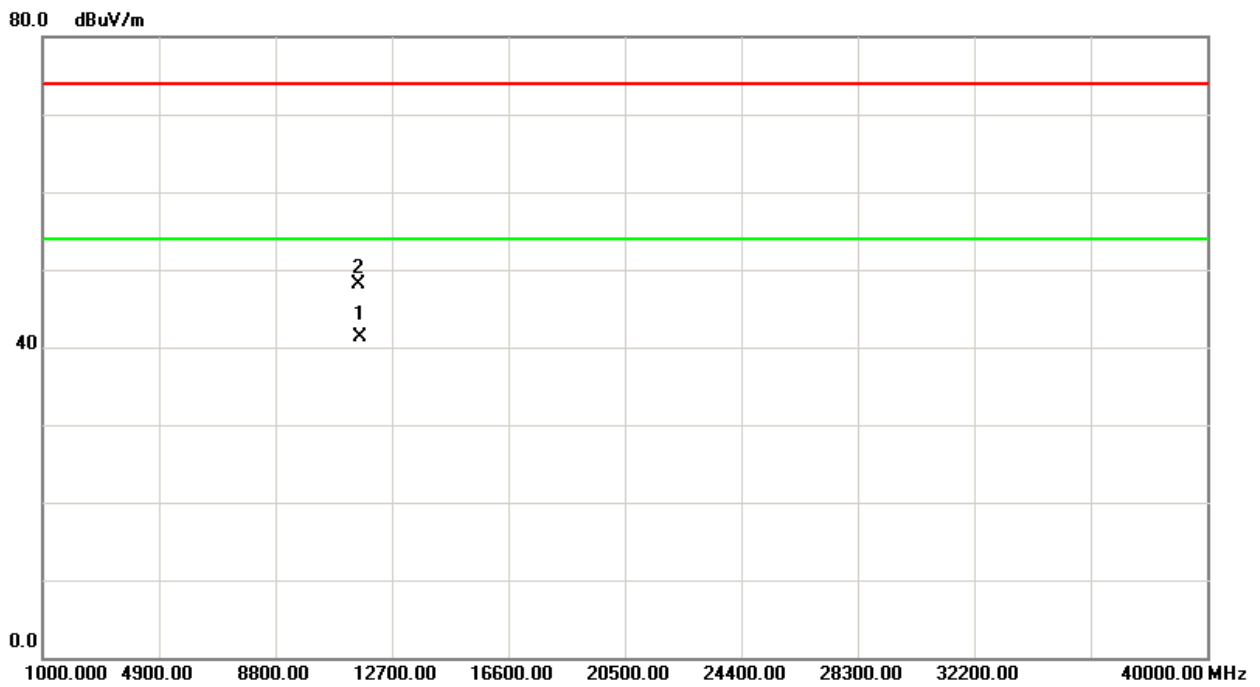
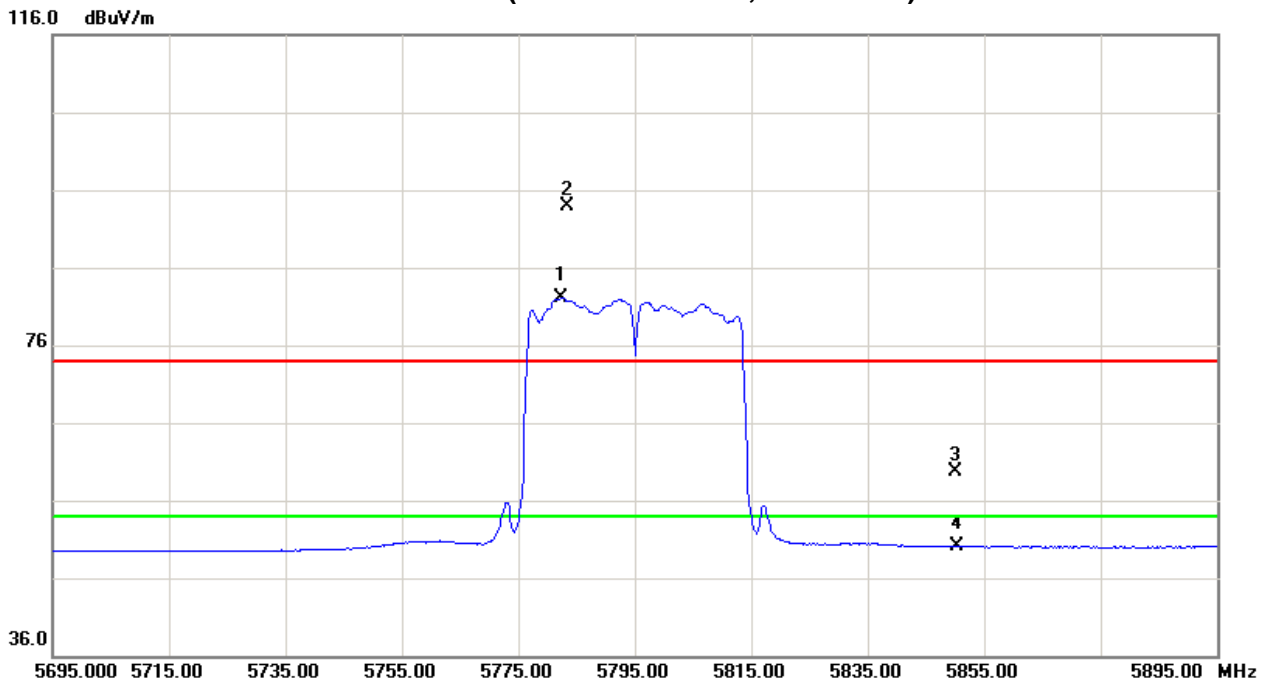



5. BANDWIDTH TEST

5.1 Applied procedures / limit

FCC Part15 (15.247) , Subpart C				
Section	Test Item	Limit	Frequency Range (MHz)	Result
15.247(a)(2)	Bandwidth	N/A	5725 - 5825	PASS

5.1.1 MEASUREMENT INSTRUMENTS LIST

Item	Kind of Equipment	Manufacturer	Type No.	Serial No.	Calibrated until
1	Spectrum Analyzer	R&S	FSP 40	100185	Nov. 16, 2013

Remark: "N/A" denotes no model name, serial no. or calibration specified.
 All calibration period of Equipment List is One Year.

5.1.2 TEST PROCEDURE

- a. The EUT was directly connected to the spectrum analyzer and antenna output port as show in the block diagram below,
- b. Spectrum Setting : RBW= 100KHz, VBW=300KHz, Sweep time = Auto

5.1.3 DEVIATION FROM STANDARD

No deviation.

5.1.4 TEST SETUP



5.1.5 EUT OPERATION CONDITIONS

The EUT tested system was configured as the statements of 4.1.6 Unless otherwise a special operating condition is specified in the follows during the testing.



5.1.6 TEST RESULTS

EUT:	High Power Dual Band Wireless 900N Low Profile Access Point	Model Name. :	XAP-1500
Temperature:	25 °C	Relative Humidity:	58 %
Pressure:	1010 hPa	Test Voltage :	AC 120V/60Hz
Test Mode :	TX A Mode /CH149, CH157, CH165		

Test Channel	Frequency (MHz)	6dB Bandwidth (MHz)	99% Occupied Bandwidth (MHz)	Test Result
CH149	5745	16.52	16.60	PASS
CH157	5785	16.56	16.60	PASS
CH165	5825	16.60	16.60	PASS

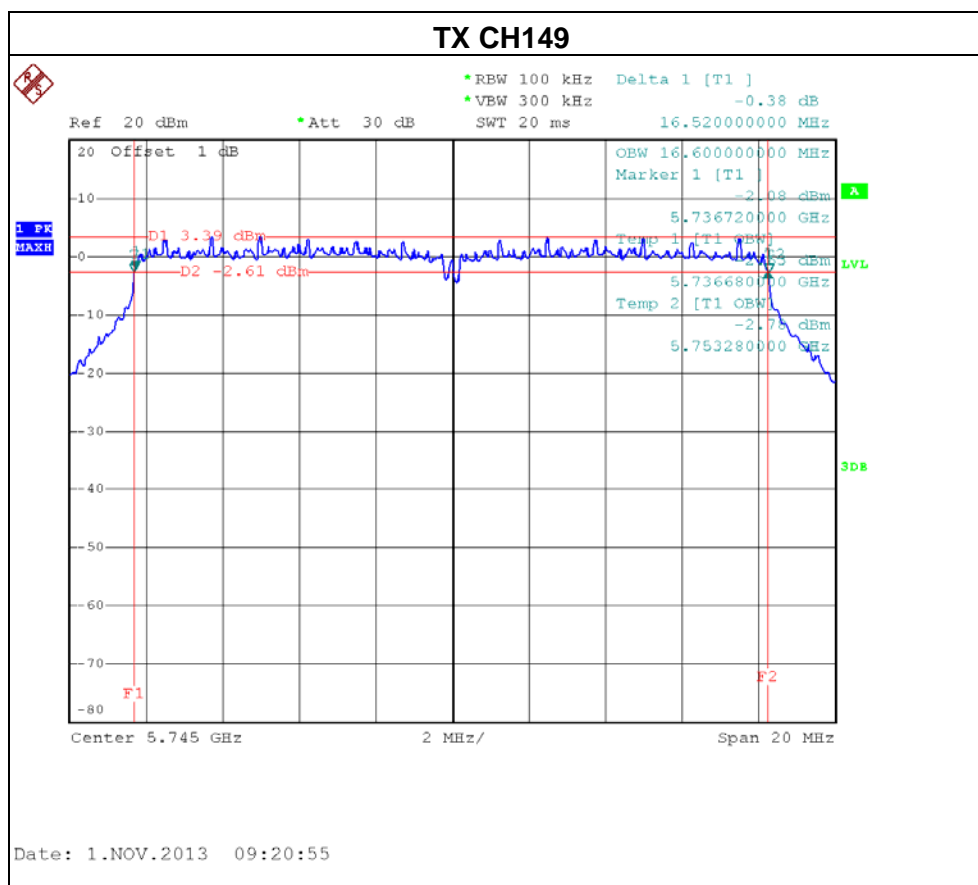

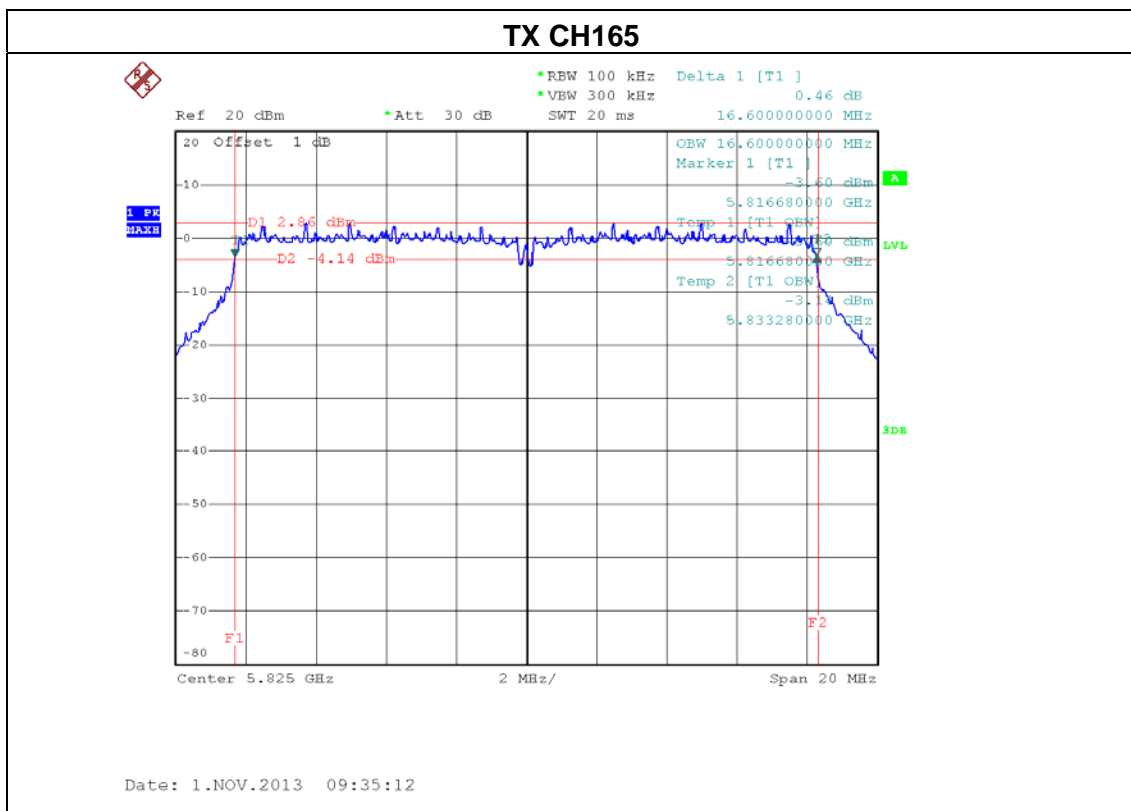
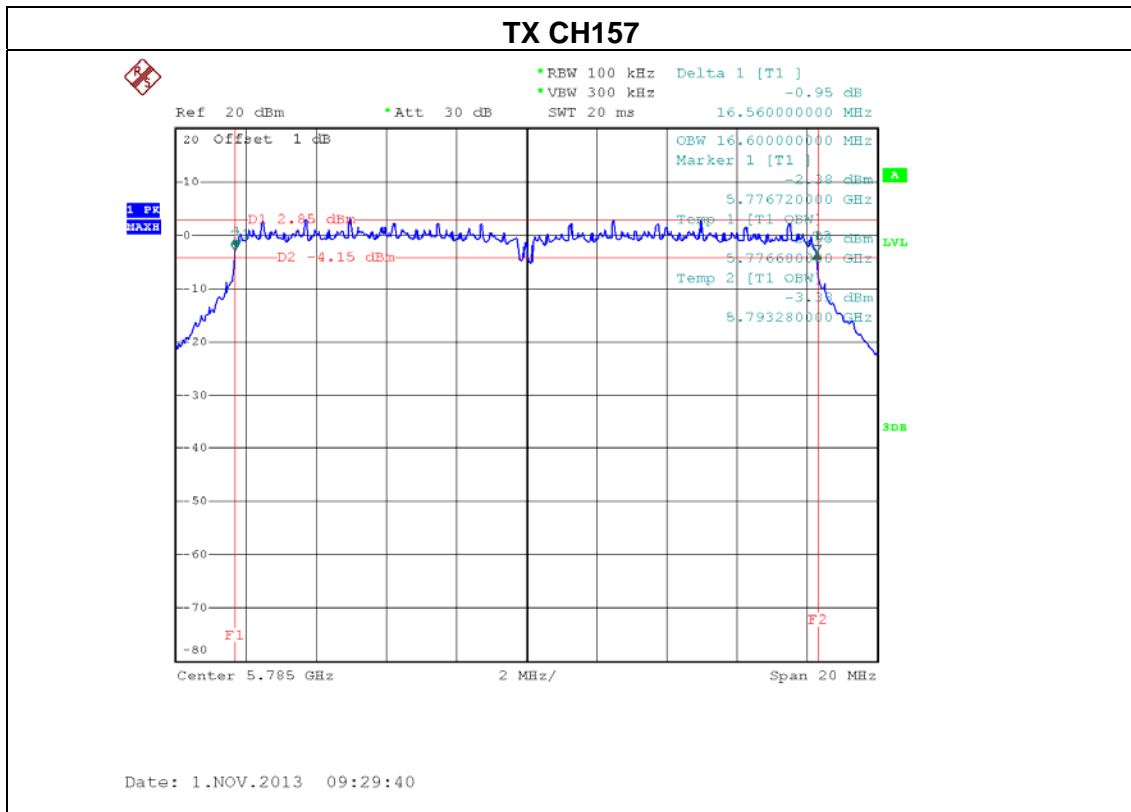

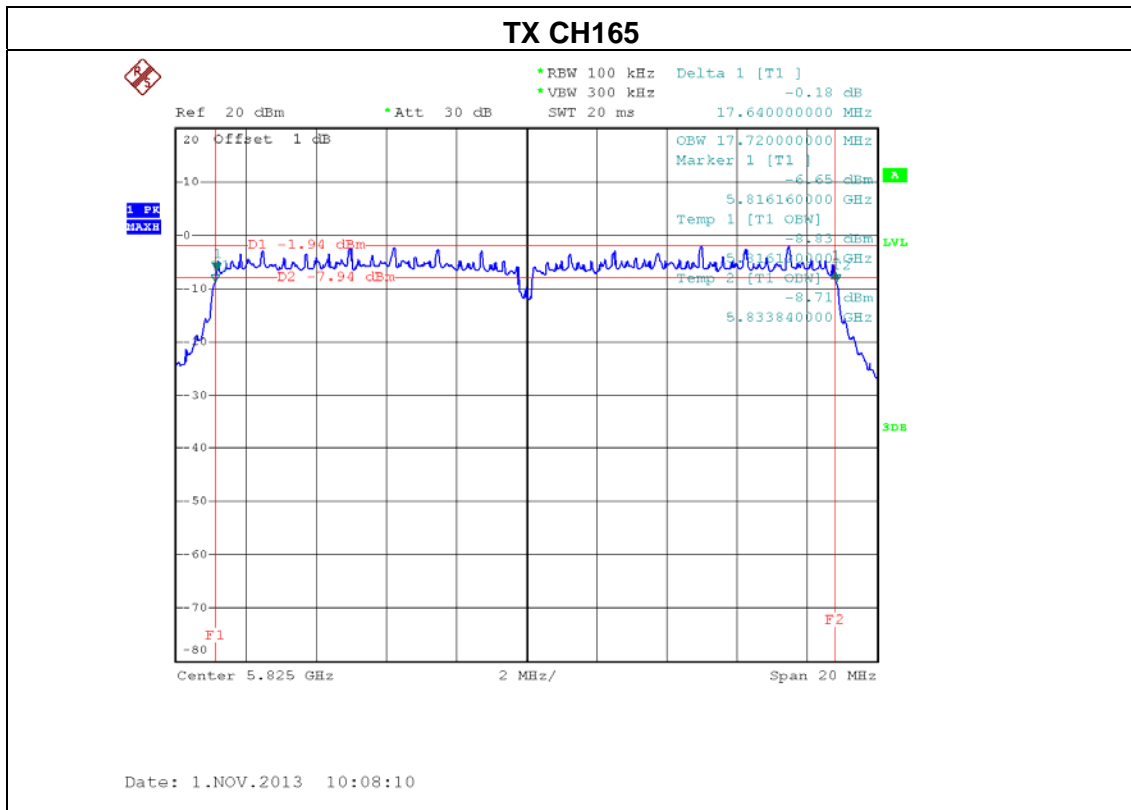
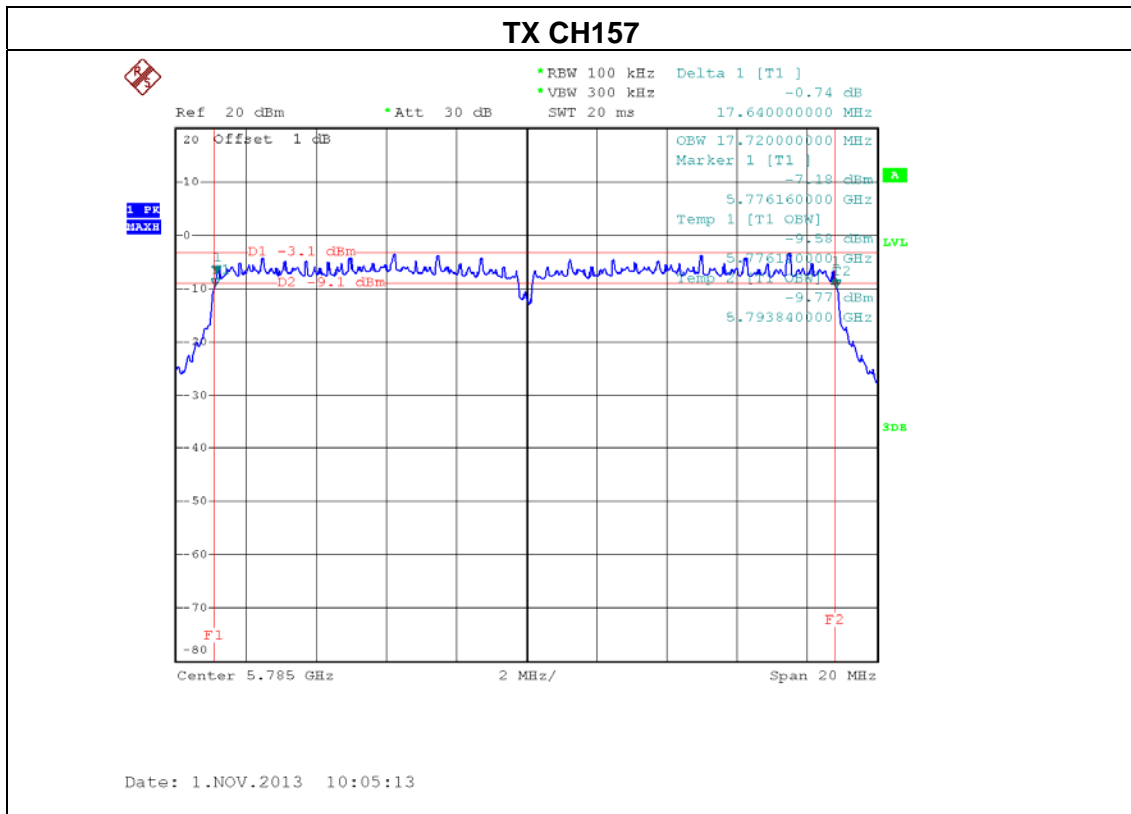



EUT:	High Power Dual Band Wireless 900N Low Profile Access Point	Model Name. :	XAP-1500
Temperature:	25 °C	Relative Humidity:	58 %
Pressure:	1010 hPa	Test Voltage :	AC 120V/60Hz
Test Mode :	TX N40 Mode /CH151, CH159		

Test Channel	Frequency (MHz)	6dB Bandwidth (MHz)	99% Occupied Bandwidth (MHz)	Test Result
CH151	5755	36.40	36.24	PASS
CH159	5795	36.40	36.24	PASS

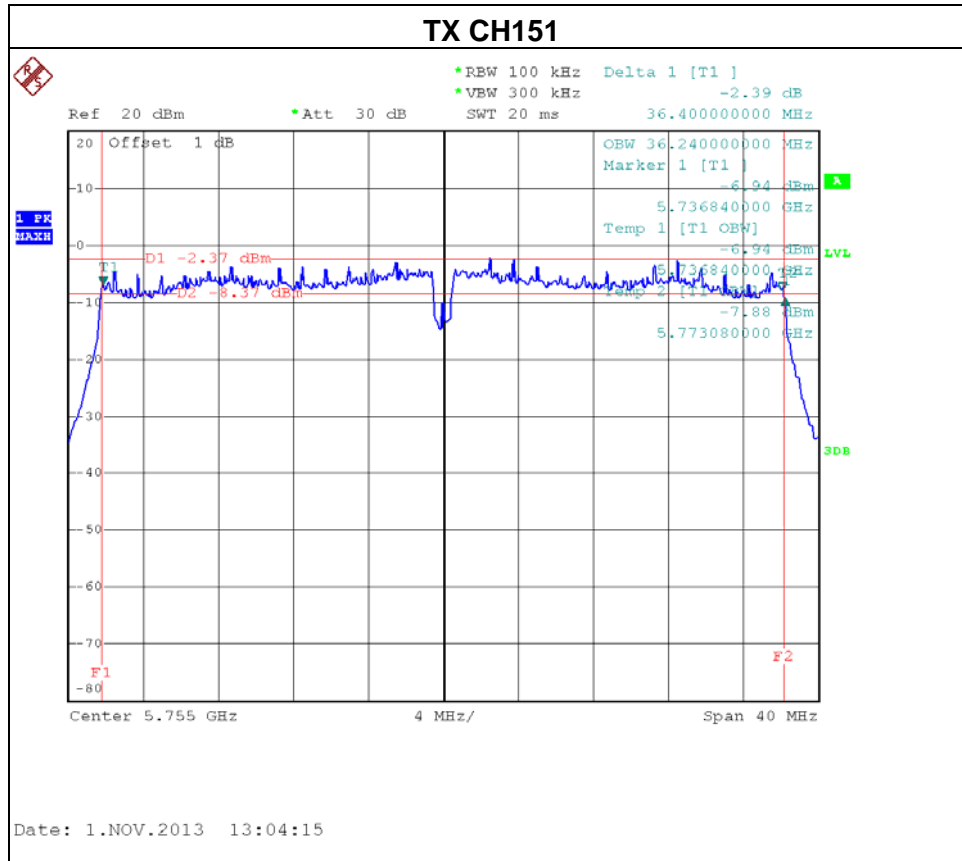

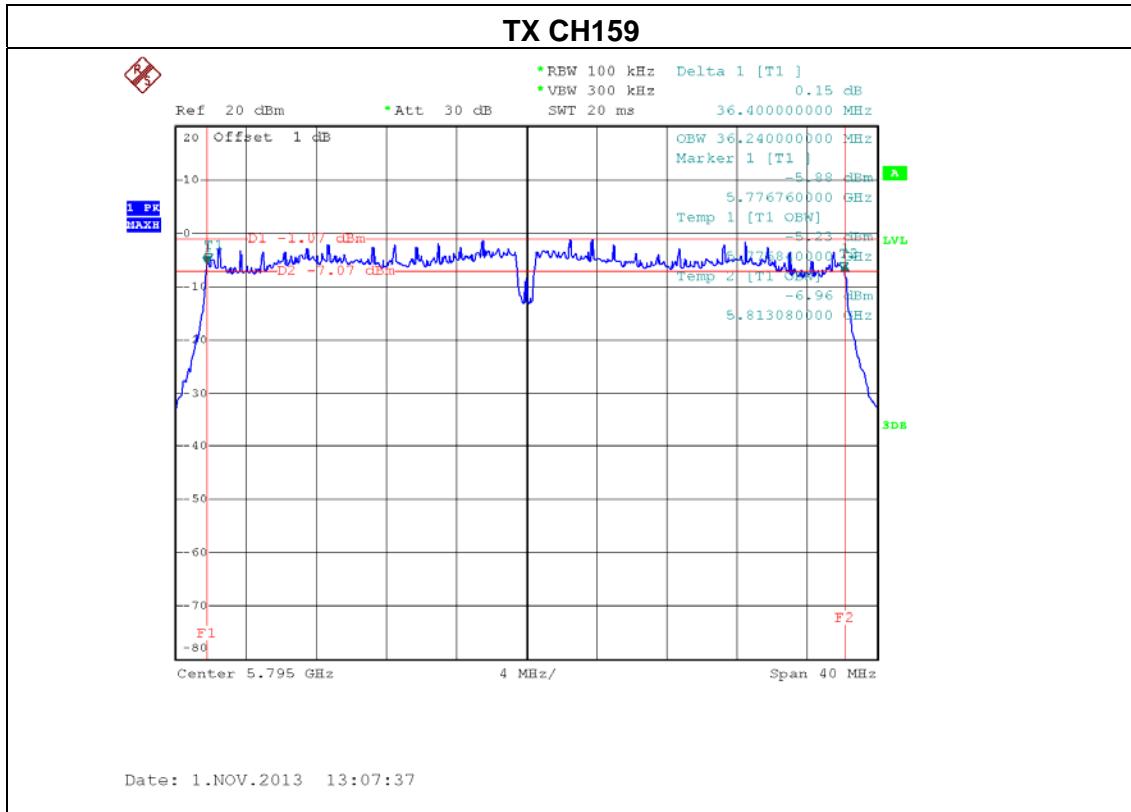



6. MAXIMUM OUTPUT POWER TEST

6.1 Applied procedures / limit

FCC Part15 (15.247) , Subpart C				
Section	Test Item	Limit	Frequency Range (MHz)	Result
15.247(b)(3)	Maximum Output Power	1 watt or 30dBm	5725 - 5825	PASS

6.1.1 MEASUREMENT INSTRUMENTS LIST

Item	Kind of Equipment	Manufacturer	Type No.	Serial No.	Calibrated until
1	P-series Power meter	Agilent	N1911A	MY45100473	Apr. 25, 2014
2	Wireband Power sensor	Agilent	N1921A	MY51100041	Apr. 25, 2014

Remark: "N/A" denotes no model name, serial no. or calibration specified.
 All calibration period of Equipment List is One Year.

6.1.2 TEST PROCEDURE

- a. The EUT was directly connected to the power meter and antenna output port as show in the block diagram below,
- b. The maximum peak conducted output power was performed in accordance with method 9.1.3 of FCC KDB 558074 D01 DTS Meas Guidance v03r01(A,N20,N40 mode) and 662911 D01 Multiple Transmitter Output v01r02(N20,N40 mode)

6.1.3 DEVIATION FROM STANDARD

No deviation.

6.1.4 TEST SETUP

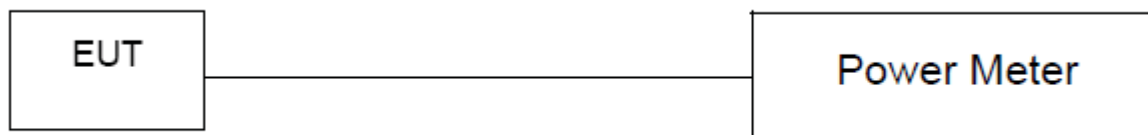

6.1.5 EUT OPERATION CONDITIONS

The EUT tested system was configured as the statements of 4.1.6 Unless otherwise a special operating condition is specified in the follows during the testing.



6.1.6 TEST RESULTS

EUT:	High Power Dual Band Wireless 900N Low Profile Access Point	Model Name :	XAP-1500
Temperature:	25 °C	Relative Humidity:	58 %
Pressure:	1010 hPa	Test Voltage :	AC 120V/60Hz
Test Mode :	TX A Mode /CH149, CH157, CH165		

Test Channel	Frequency (MHz)	Maximum Output Power (dBm)	LIMIT (dBm)	LIMIT (W)
CH149	5745 MHz	22.70	30	1
CH157	5785 MHz	22.54	30	1
CH165	5825 MHz	22.69	30	1



EUT:	High Power Dual Band Wireless 900N Low Profile Access Point	Model Name :	XAP-1500
Temperature:	25 °C	Relative Humidity:	58 %
Pressure:	1010 hPa	Test Voltage :	AC 120V/60Hz
Test Mode :	TX N20 Mode /CH149, CH157, CH165		

ANT 0				
Test Channel	Frequency (MHz)	Maximum Output Power (dBm)	LIMIT (dBm)	LIMIT (W)
CH149	5745 MHz	17.58	30	1
CH157	5785 MHz	17.86	30	1
CH165	5825 MHz	17.75	30	1

ANT 1				
Test Channel	Frequency (MHz)	Maximum Output Power (dBm)	LIMIT (dBm)	LIMIT (W)
CH149	5745 MHz	17.35	30	1
CH157	5785 MHz	17.44	30	1
CH165	5825 MHz	17.57	30	1

ANT 2				
Test Channel	Frequency (MHz)	Maximum Output Power (dBm)	LIMIT (dBm)	LIMIT (W)
CH149	5745 MHz	17.69	30	1
CH157	5785 MHz	17.75	30	1
CH165	5825 MHz	17.57	30	1

ANT 0 + ANT 1 + ANT 2				
Test Channel	Frequency (MHz)	Maximum Output Power (dBm)	LIMIT (dBm)	LIMIT (W)
CH149	5745 MHz	27.31	30	1
CH157	5785 MHz	27.46	30	1
CH165	5825 MHz	27.40	30	1

Note: The EUT incorporates a MIMO function. Physically, the EUT provides three completed transmitters and three receivers (3T3R), all transmit signals are completely uncorrelated, then, Directional gain = GANT, that is Directional gain=5dBi.



EUT:	High Power Dual Band Wireless 900N Low Profile Access Point	Model Name :	XAP-1500
Temperature:	25 °C	Relative Humidity:	58 %
Pressure:	1010 hPa	Test Voltage :	AC 120V/60Hz
Test Mode :	TX N40 Mode /CH151, CH159		

ANT 0				
Test Channel	Frequency (MHz)	Maximum Output Power (dBm)	LIMIT (dBm)	LIMIT (W)
CH151	5755 MHz	17.86	30	1
CH159	5795 MHz	17.89	30	1

ANT 1				
Test Channel	Frequency (MHz)	Maximum Output Power (dBm)	LIMIT (dBm)	LIMIT (W)
CH151	5755 MHz	17.76	30	1
CH159	5795 MHz	17.82	30	1

ANT 2				
Test Channel	Frequency (MHz)	Maximum Output Power (dBm)	LIMIT (dBm)	LIMIT (W)
CH151	5755 MHz	17.93	30	1
CH159	5795 MHz	17.92	30	1

ANT 0 + ANT 1 + ANT 2				
Test Channel	Frequency (MHz)	Maximum Output Power (dBm)	LIMIT (dBm)	LIMIT (W)
CH151	5755 MHz	27.62	30	1
CH159	5795 MHz	27.64	30	1

Note: The EUT incorporates a MIMO function. Physically, the EUT provides three completed transmitters and three receivers (3T3R), all transmit signals are completely uncorrelated, then, Directional gain = G_{ANT} , that is Directional gain=5dBi..



7. ANTENNA CONDUCTED SPURIOUS EMISSION

7.1 Applied procedures / limit

20dB in any 100 KHz bandwidth outside the operating frequency band, In case the emission fall within the restricted band specified on 15.205(a), then the 15.209(a) limit in the table below has to be followed.

Frequency (MHz)	Field Strength (microvolts/meter)	Measurement Distance (meters)
0.009~0.490	2400/F(KHz)	300
0.490~1.705	24000/F(KHz)	30
1.705~30.0	30	30
30~88	100	3
88~216	150	3
216~960	200	3
960~1000	500	3

LIMITS OF RADIATED EMISSION MEASUREMENT (Above 1000MHz)

Frequency (MHz)	(dBuV/m) (at 3 meters)	
	Peak	Average
Above 1000	74	54

7.1.1 MEASUREMENT INSTRUMENTS LIST

Item	Kind of Equipment	Manufacturer	Type No.	Serial No.	Calibrated until
1	Spectrum Analyzer	R&S	FSP 40	100185	Nov. 16, 2013

Remark: "N/A" denotes no model name, serial no. or calibration specified.

All calibration period of Equipment List is One Year.

7.1.2 TEST PROCEDURE

- a. The EUT was directly connected to the spectrum analyzer and antenna output port as show in the block diagram below,
- b. Spectrum Setting : RBW= 100KHz, VBW=300KHz, Sweep time =20 ms.

7.1.3 DEVIATION FROM STANDARD

No deviation.



7.1.4 TEST SETUP

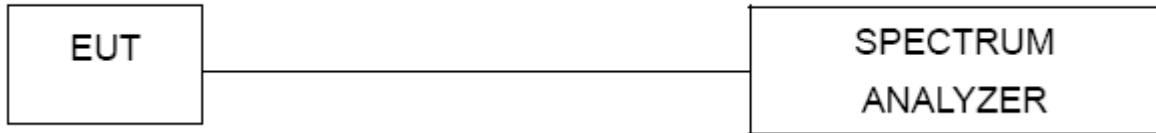

7.1.5 EUT OPERATION CONDITIONS

The EUT tested system was configured as the statements of 4.1.6 Unless otherwise a special operating condition is specified in the follows during the testing.



7.1.6 TEST RESULTS

EUT:	High Power Dual Band Wireless 900N Low Profile Access Point	Model Name :	XAP-1500
Temperature:	25 °C	Relative Humidity:	58 %
Pressure:	1010 hPa	Test Voltage :	AC 120V/60Hz
Test Mode :	TX A Mode /CH149, CH157, CH165		

Channel of Worst Data: CH149			
The max. radio frequency power in any 100kHz bandwidth outside the frequency band		The max. radio frequency power in any 100 kHz bandwidth within the frequency band.	
FREQUENCY(MHz)	POWER(dBm)	FREQUENCY(MHz)	POWER(dBm)
5724.40	-30.99	5851.80	-44.44
Result			
In any 100kHz bandwidth outside the frequency band, the radio frequency power is at least 20dB below that in the 100kHz bandwidth within the band that contains the highest level of the desired power.			

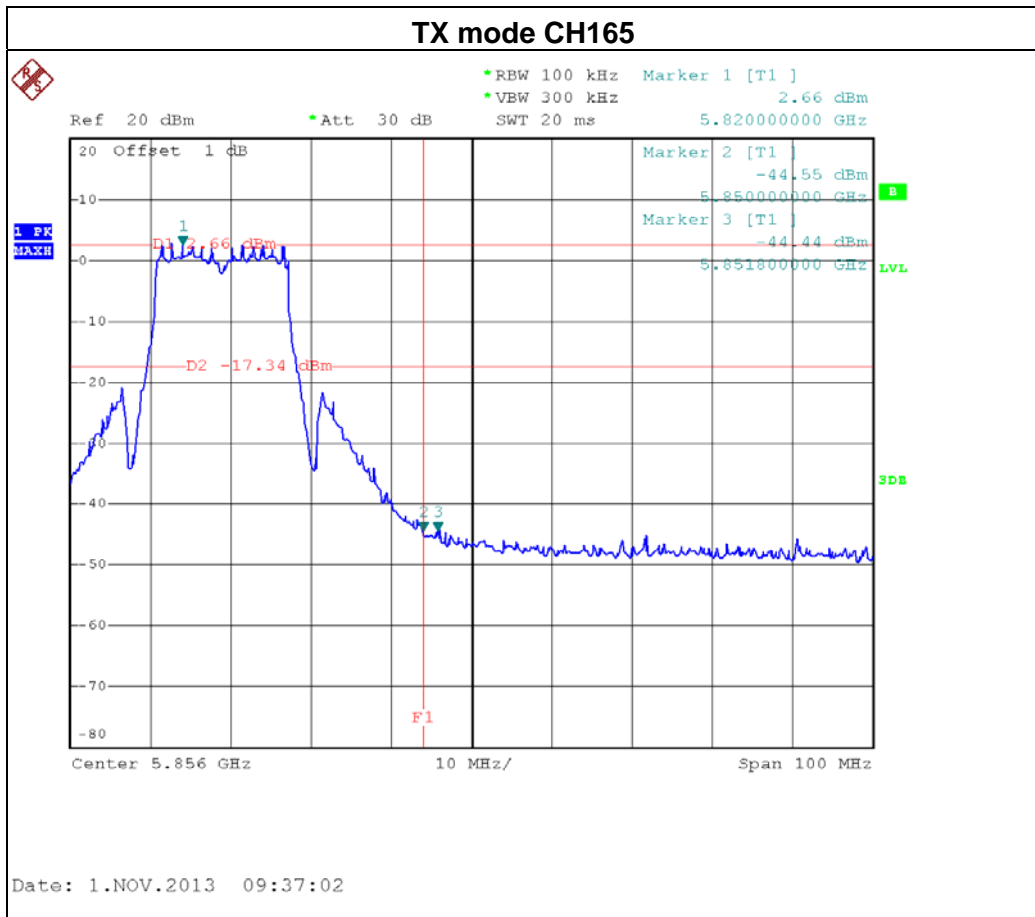
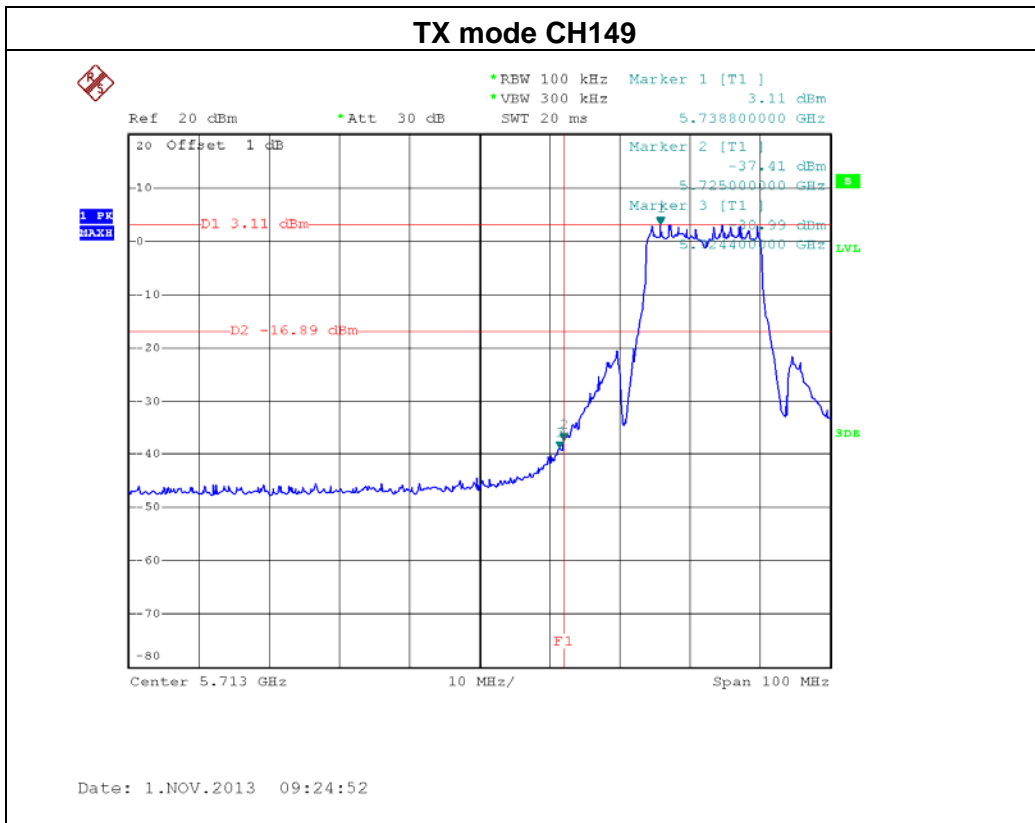

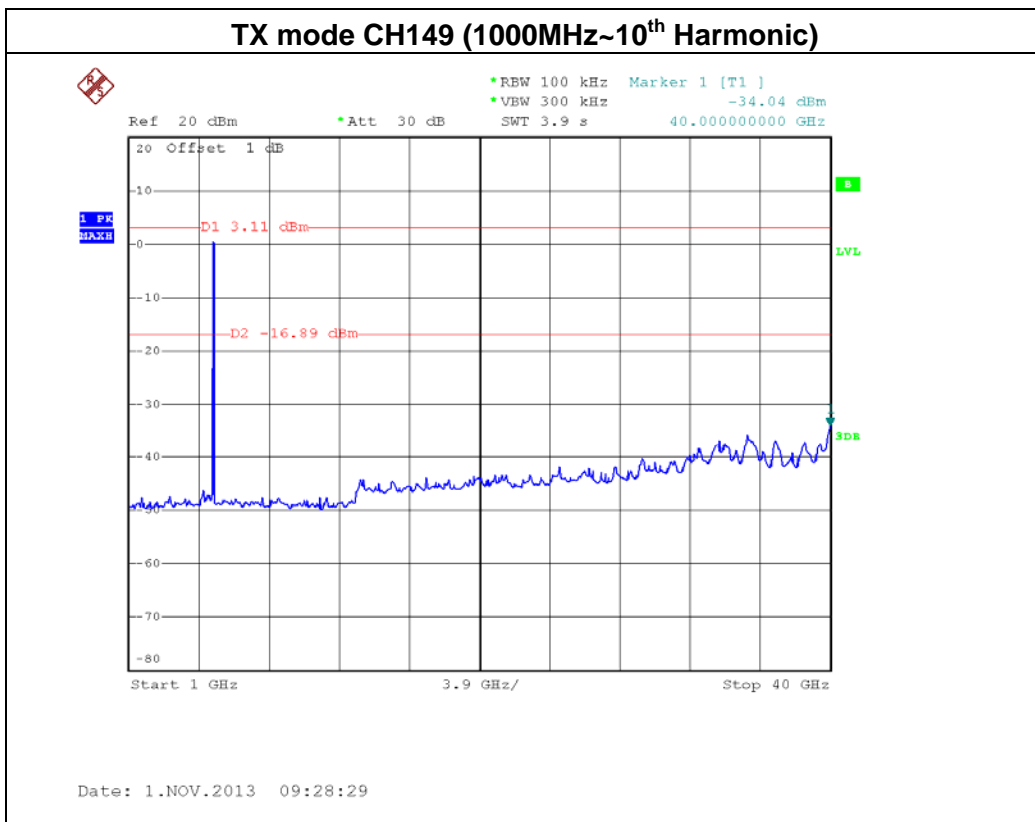
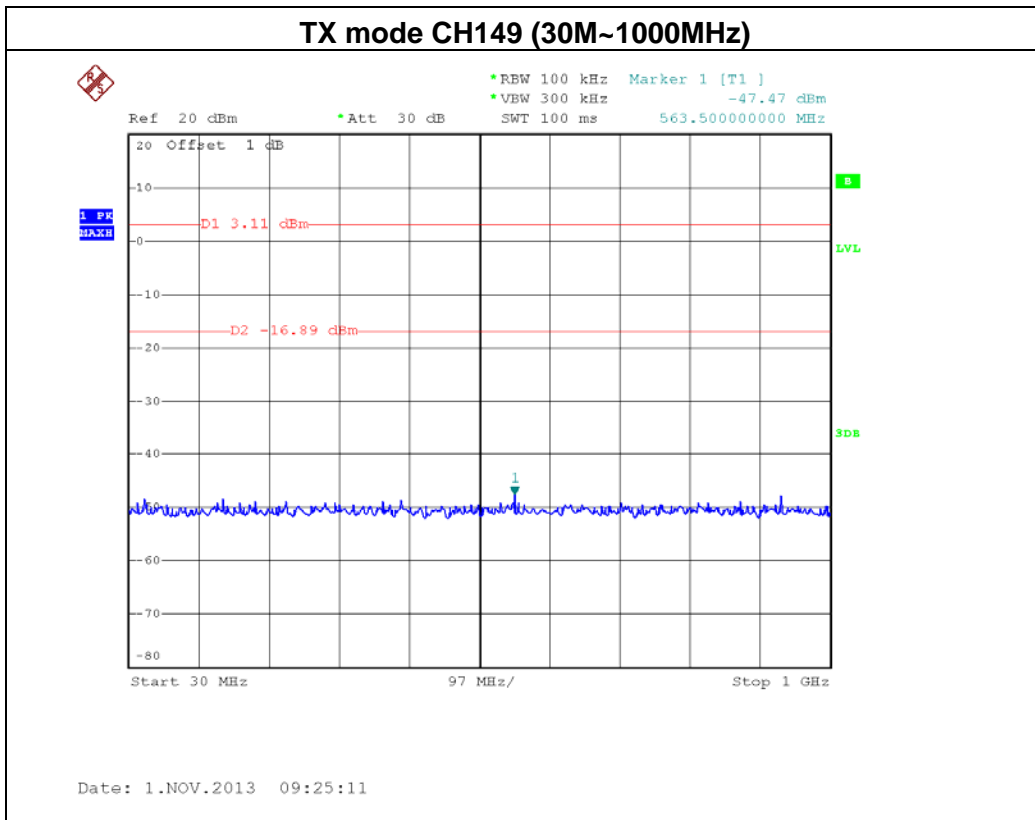

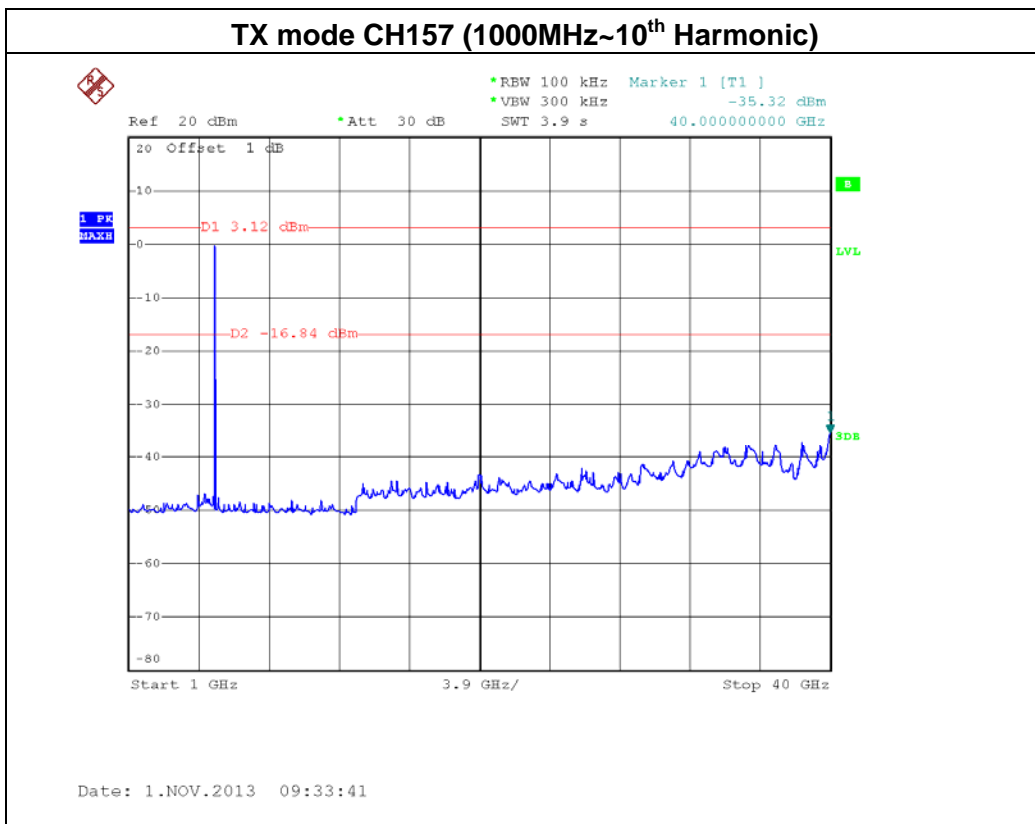
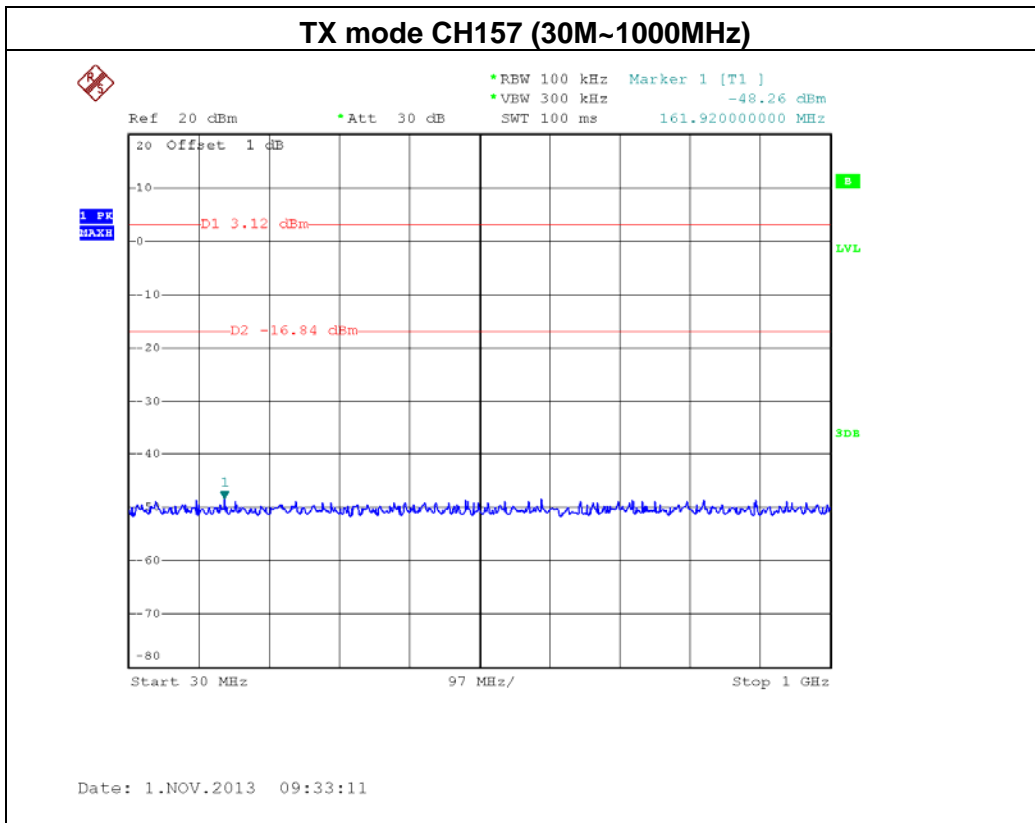

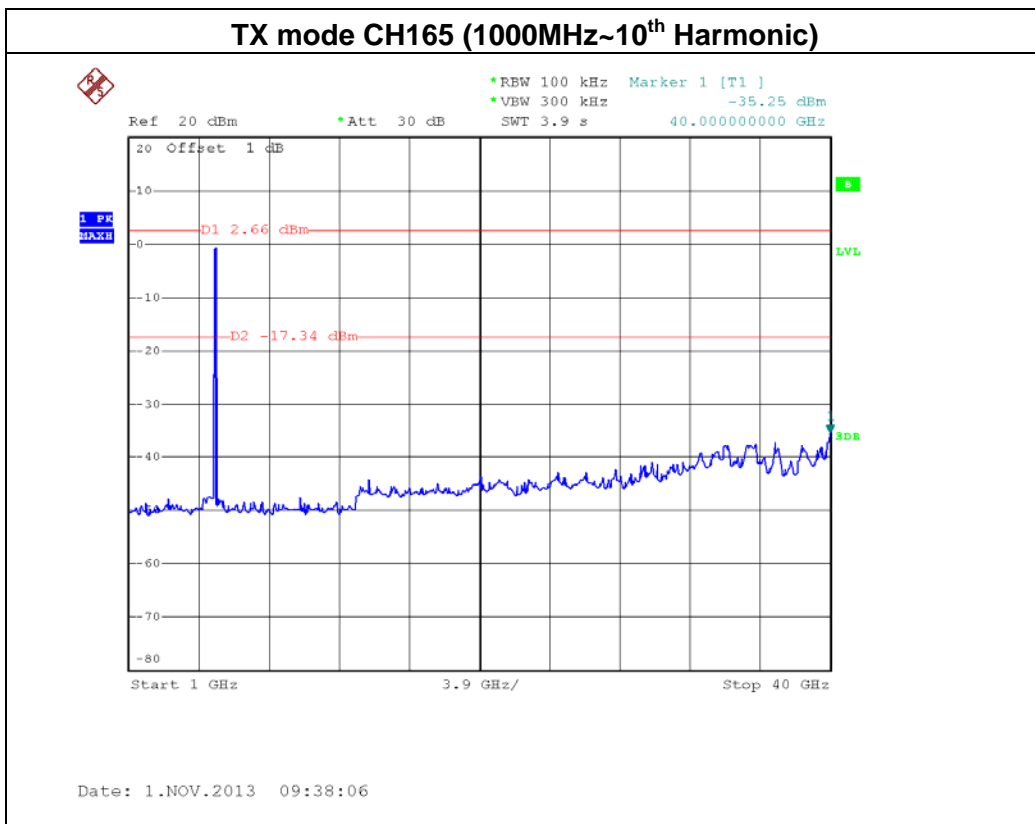
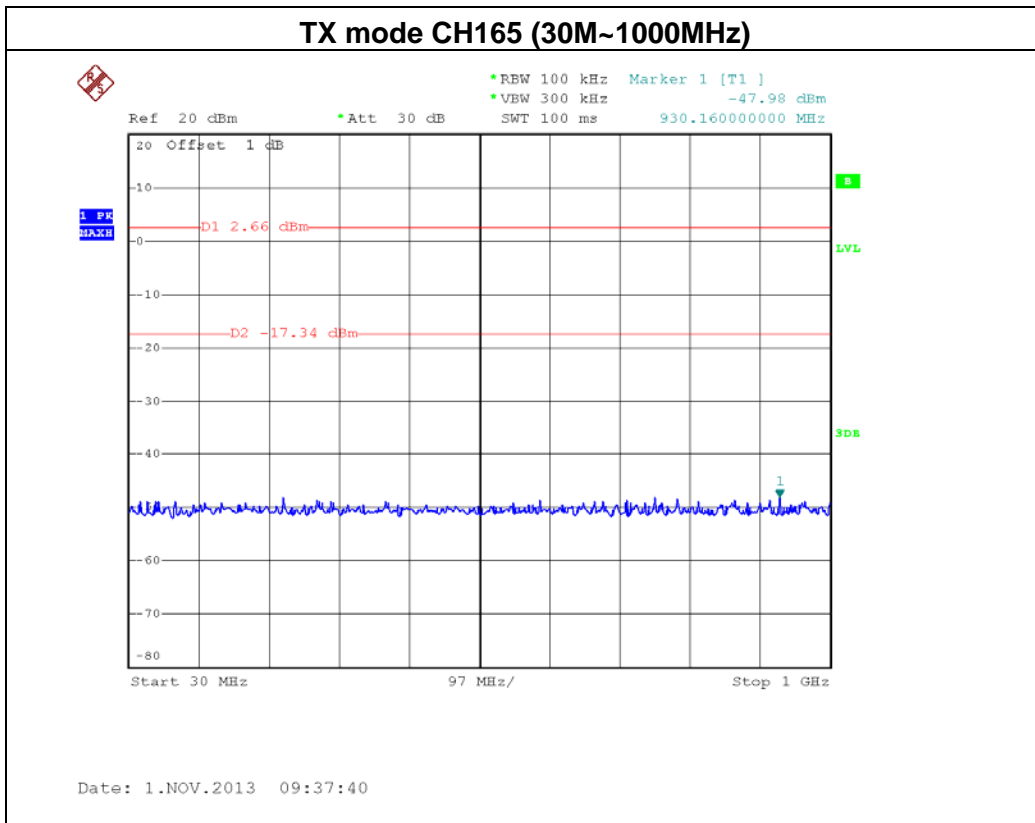



EUT:	High Power Dual Band Wireless 900N Low Profile Access Point	Model Name :	XAP-1500
Temperature:	25 °C	Relative Humidity:	58 %
Pressure:	1010 hPa	Test Voltage :	AC 120V/60Hz
Test Mode :	TX N20Mode /CH149, CH157, CH165 / ANT 0		

Channel of Worst Data: CH149			
The max. radio frequency power in any 100kHz bandwidth outside the frequency band		The max. radio frequency power in any 100 kHz bandwidth within the frequency band.	
FREQUENCY(MHz)	POWER(dBm)	FREQUENCY(MHz)	POWER(dBm)
5721.80	-46.00	5863.40	-46.52

Result

In any 100kHz bandwidth outside the frequency band, the radio frequency power is at least 20dB below that in the 100kHz bandwidth within the band that contains the highest level of the desired power.

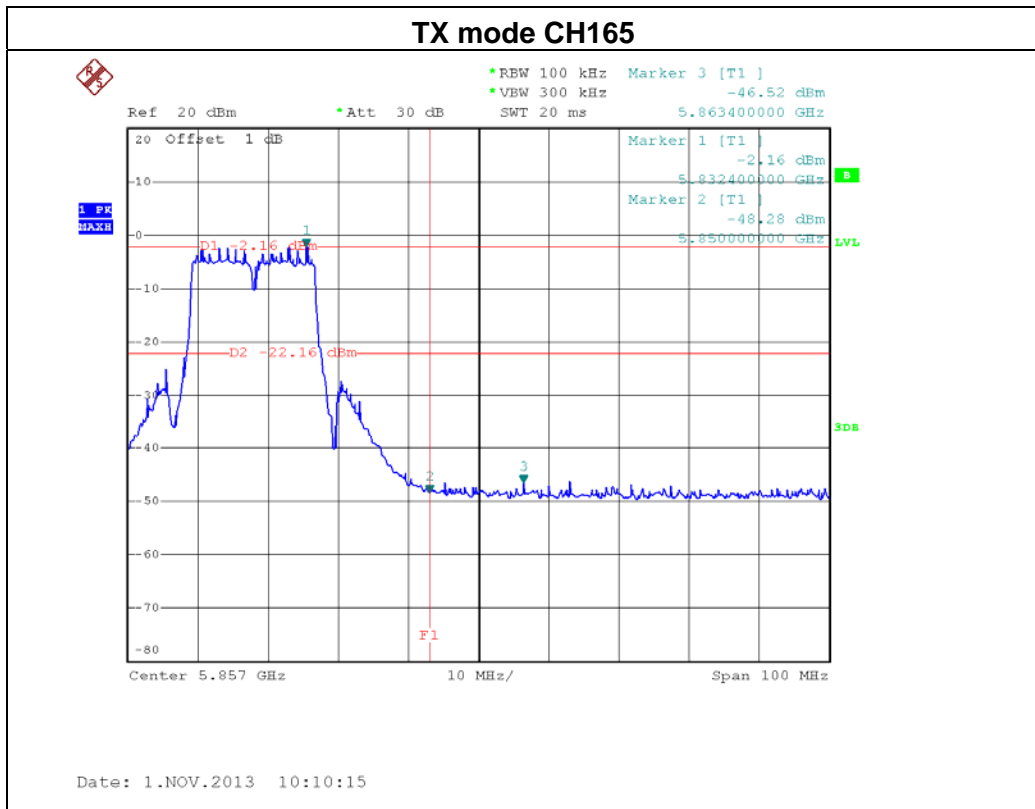
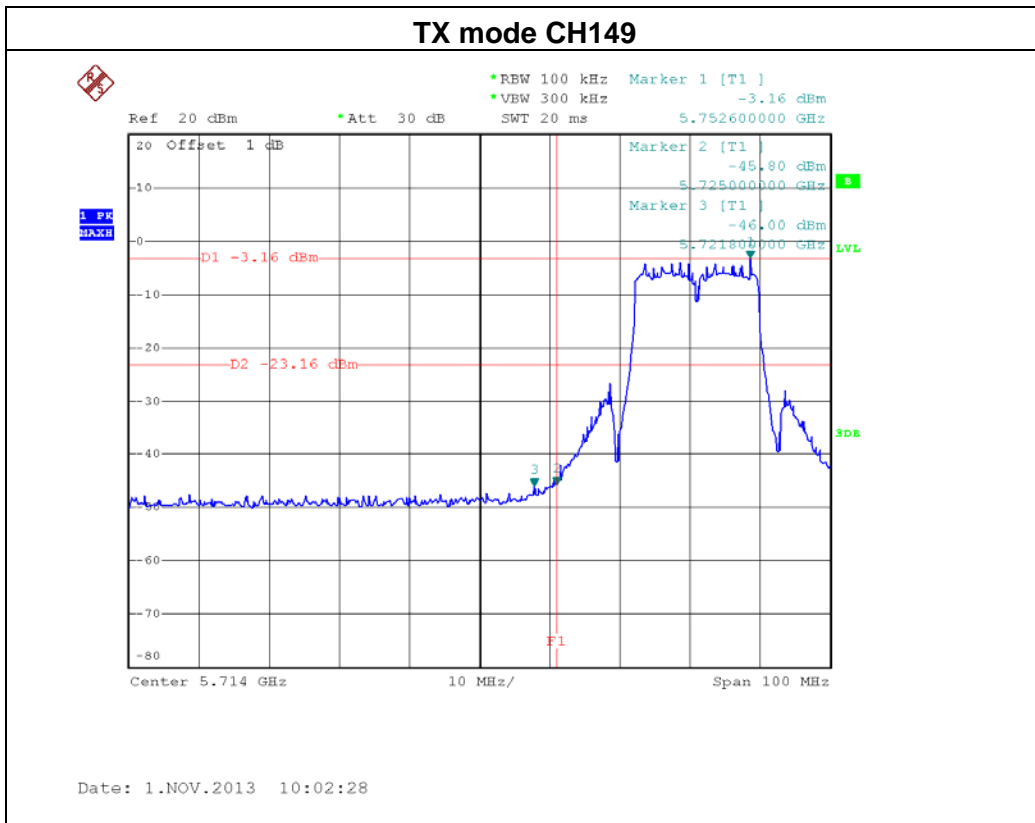

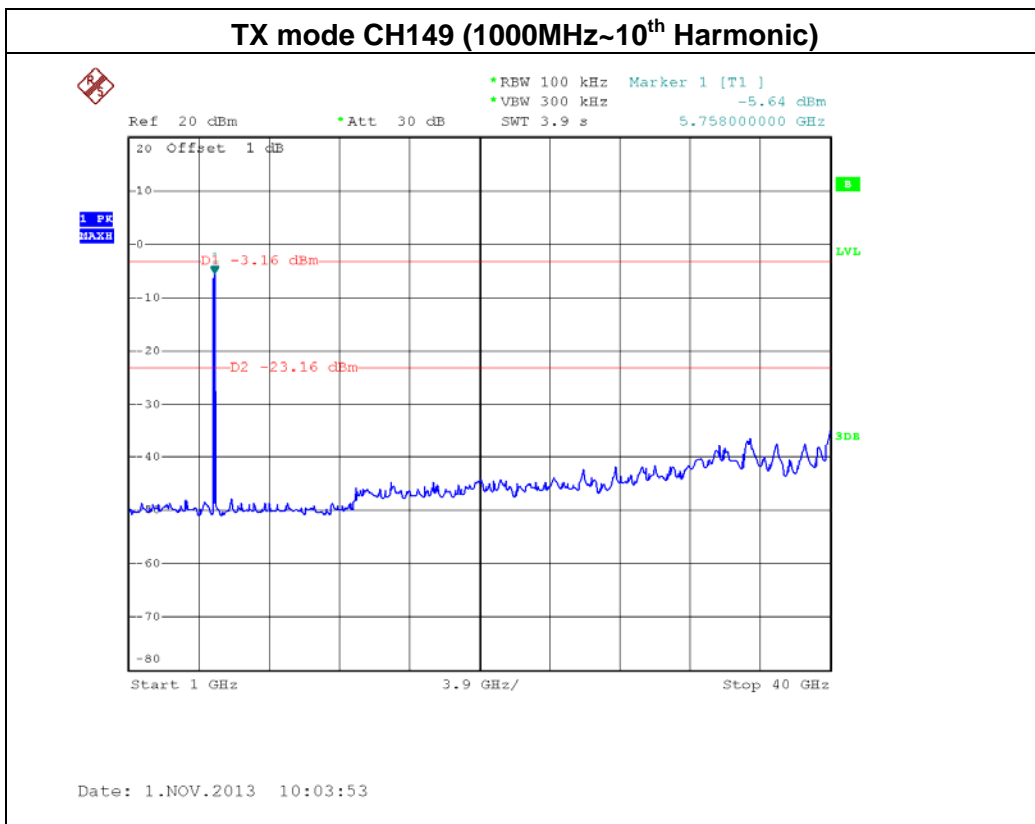
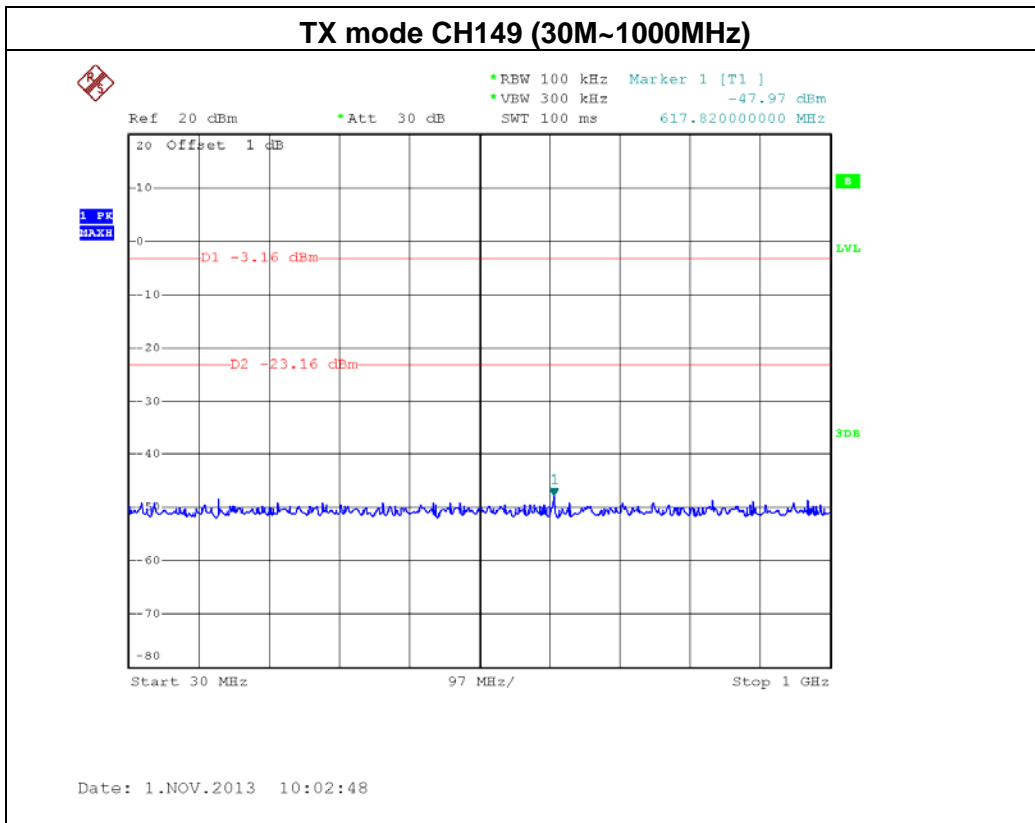

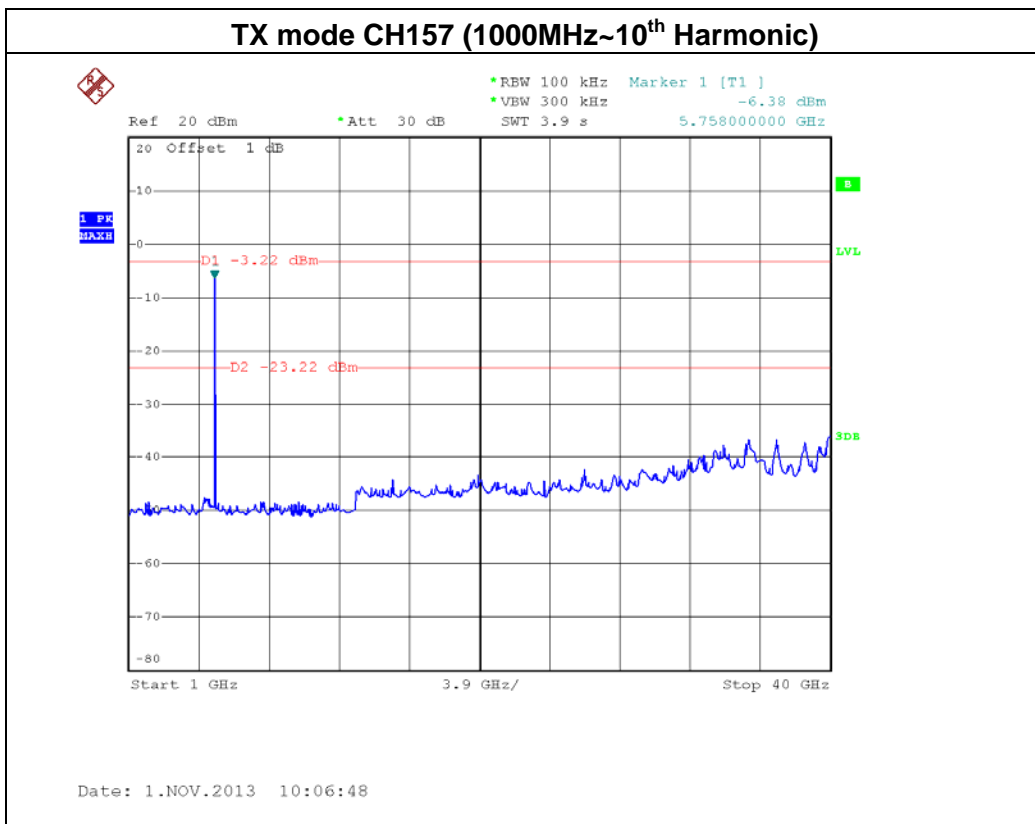
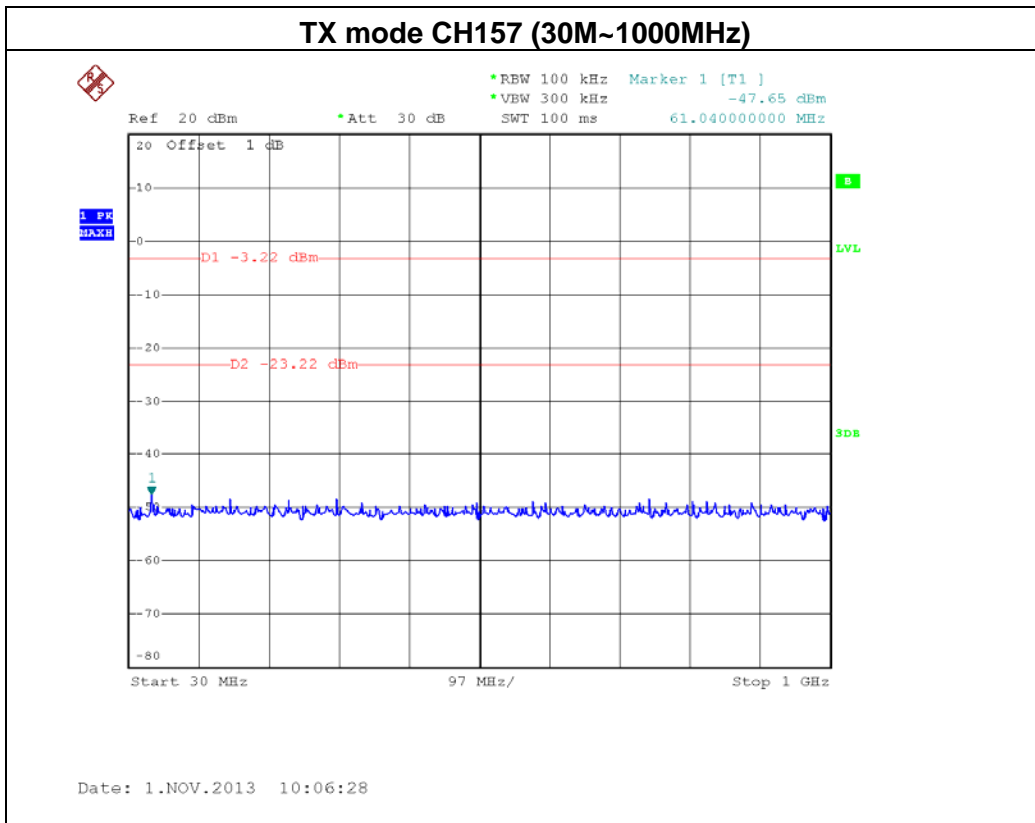

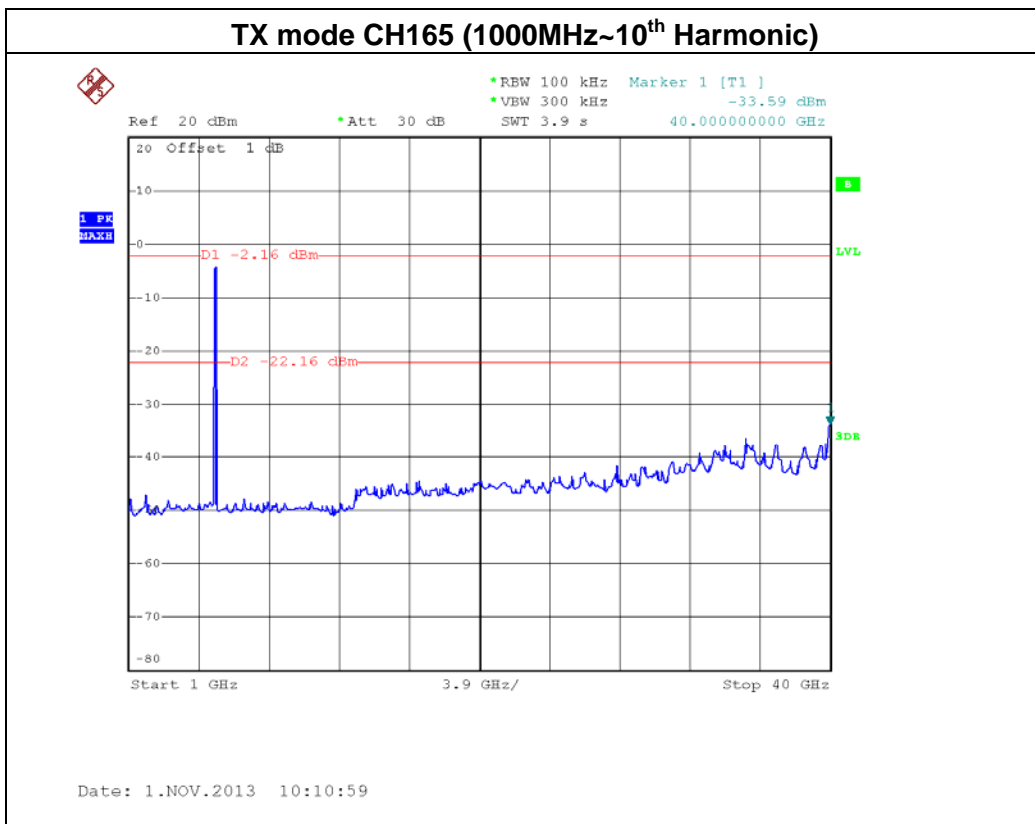
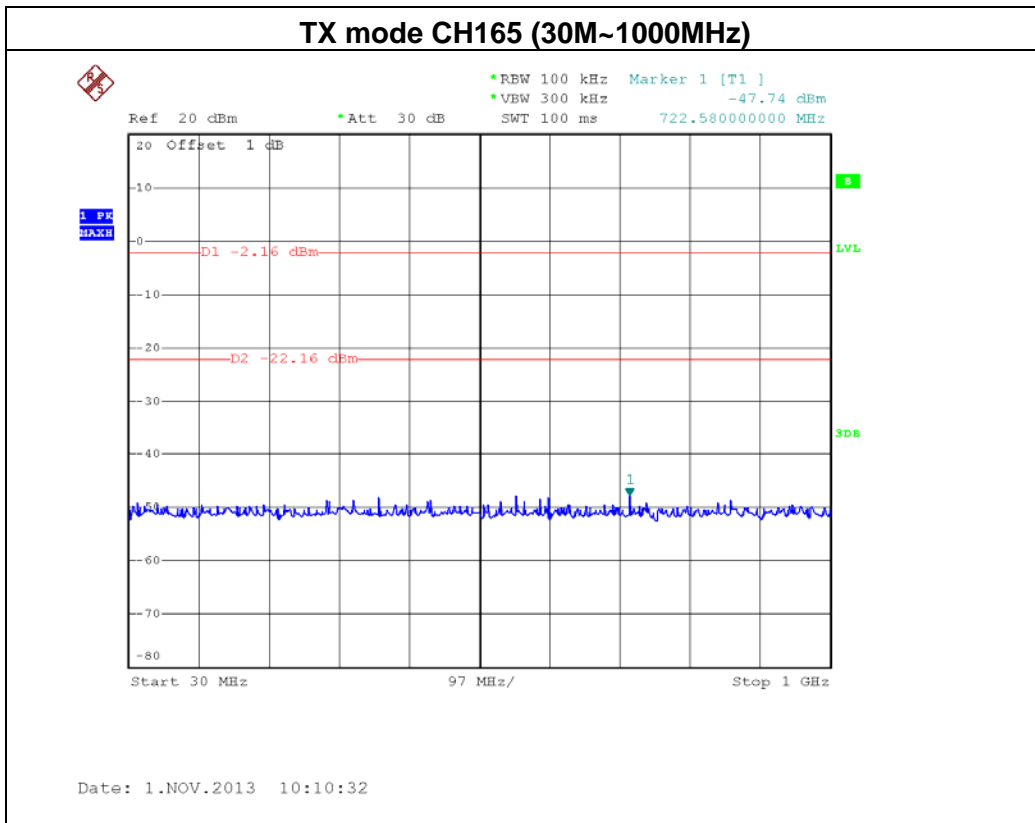



EUT:	High Power Dual Band Wireless 900N Low Profile Access Point	Model Name :	XAP-1500
Temperature:	25 °C	Relative Humidity:	58 %
Pressure:	1010 hPa	Test Voltage :	AC 120V/60Hz
Test Mode :	TX N20 Mode /CH149, CH157, CH165 / ANT 1		

Channel of Worst Data: CH149

The max. radio frequency power in any 100kHz bandwidth outside the frequency band		The max. radio frequency power in any 100 kHz bandwidth within the frequency band.	
FREQUENCY(MHz)	POWER(dBm)	FREQUENCY(MHz)	POWER(dBm)
5725.00	-43.06	5852.20	-46.75

Result

In any 100kHz bandwidth outside the frequency band, the radio frequency power is at least 20dB below that in the 100kHz bandwidth within the band that contains the highest level of the desired power.

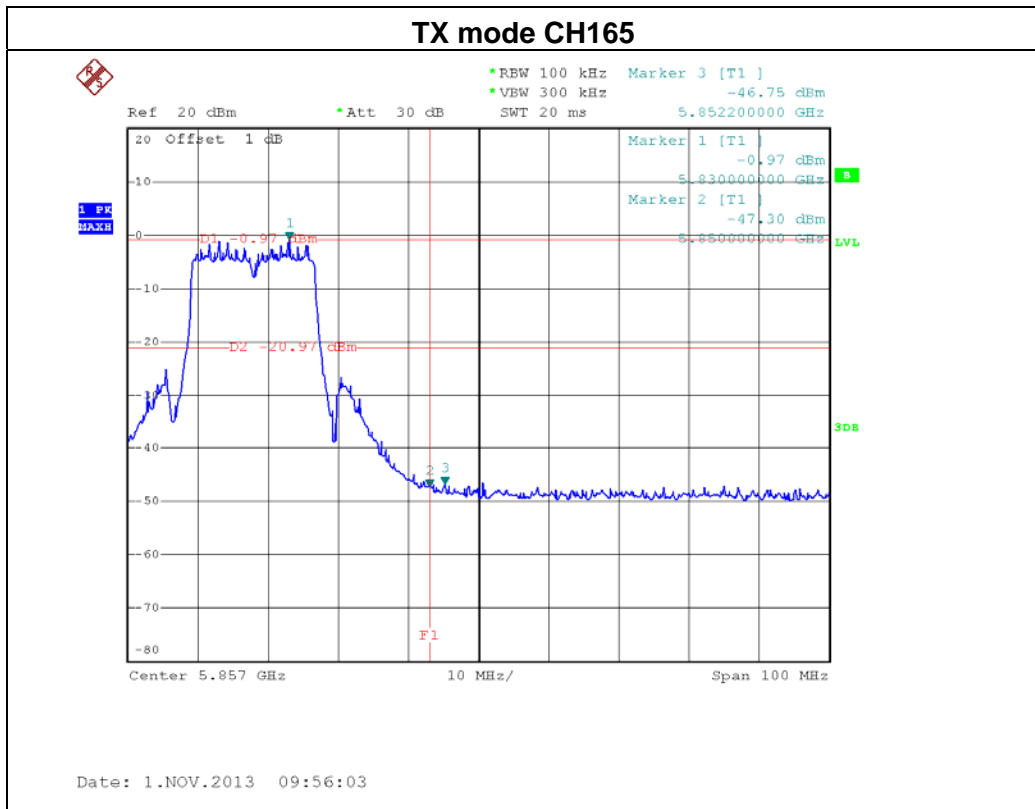
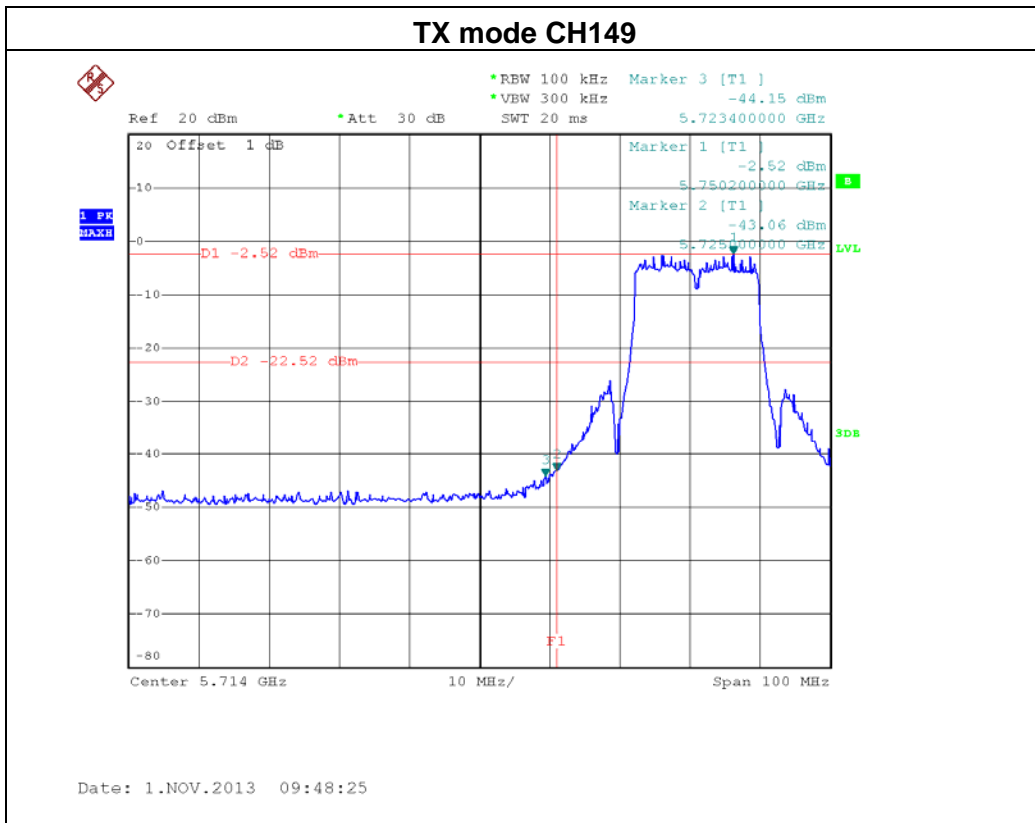

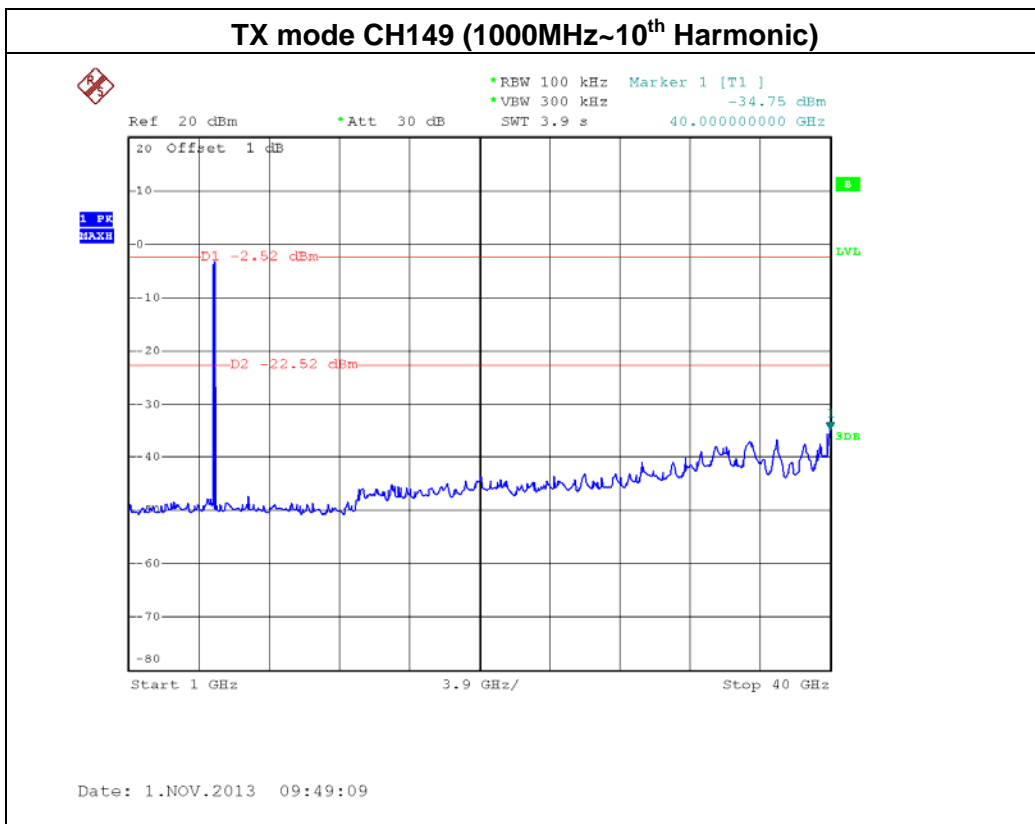
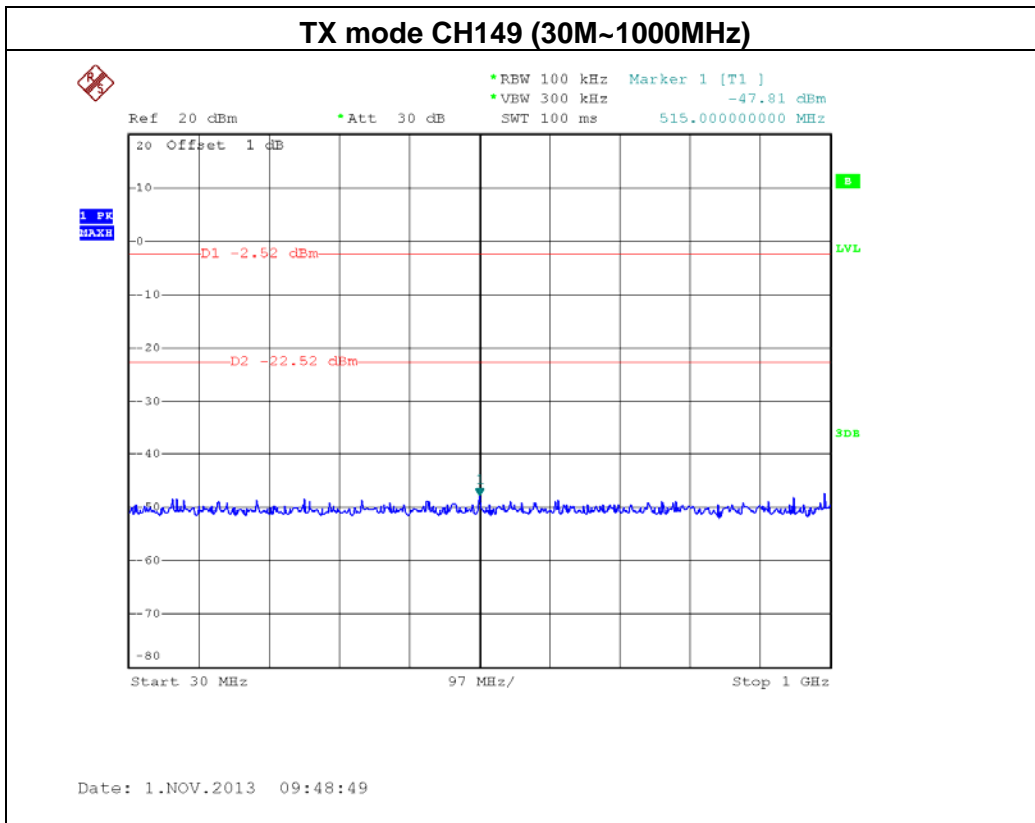

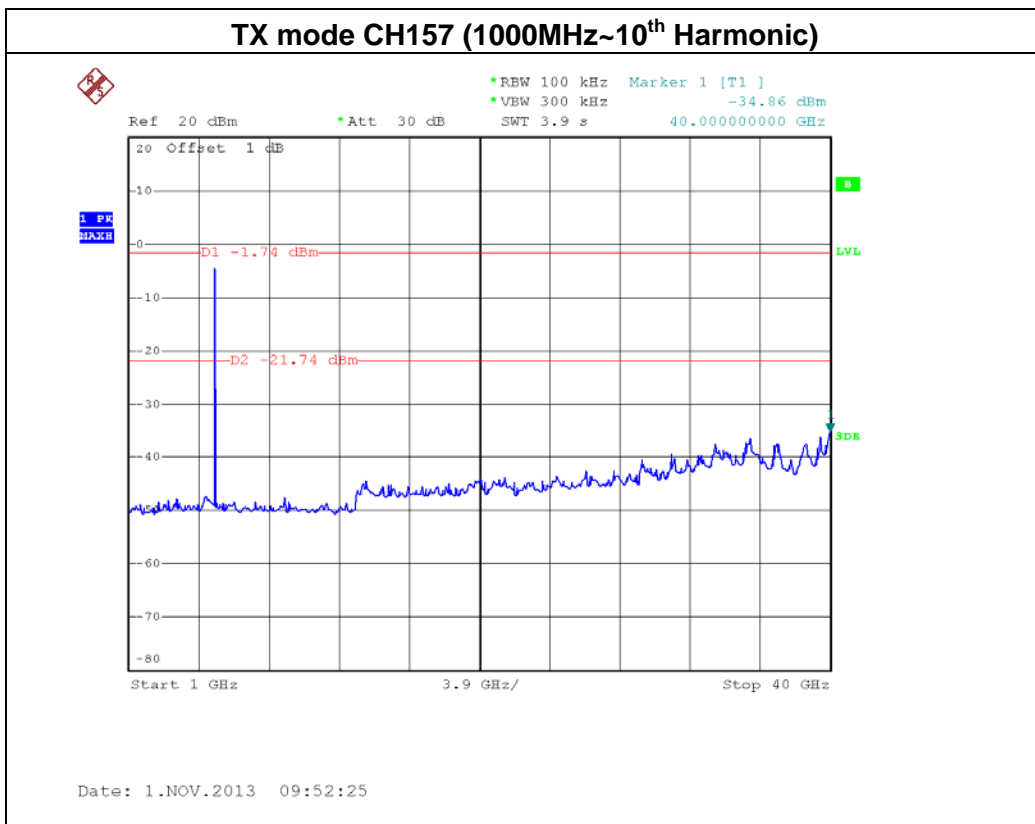
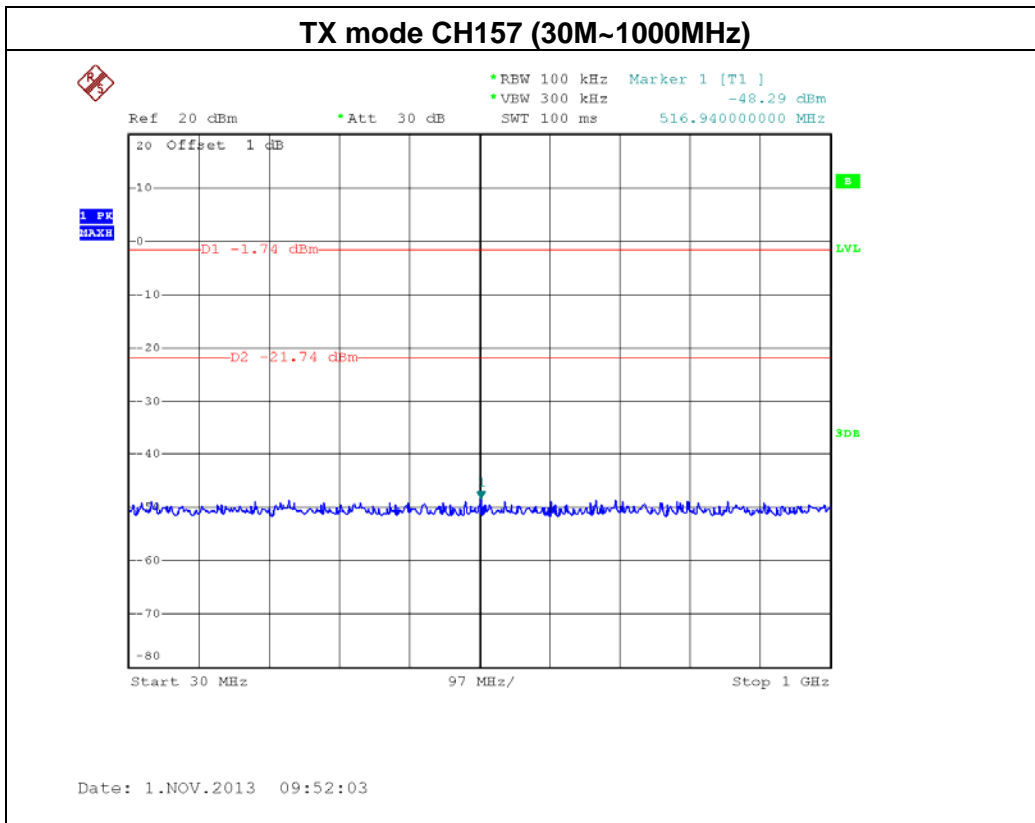

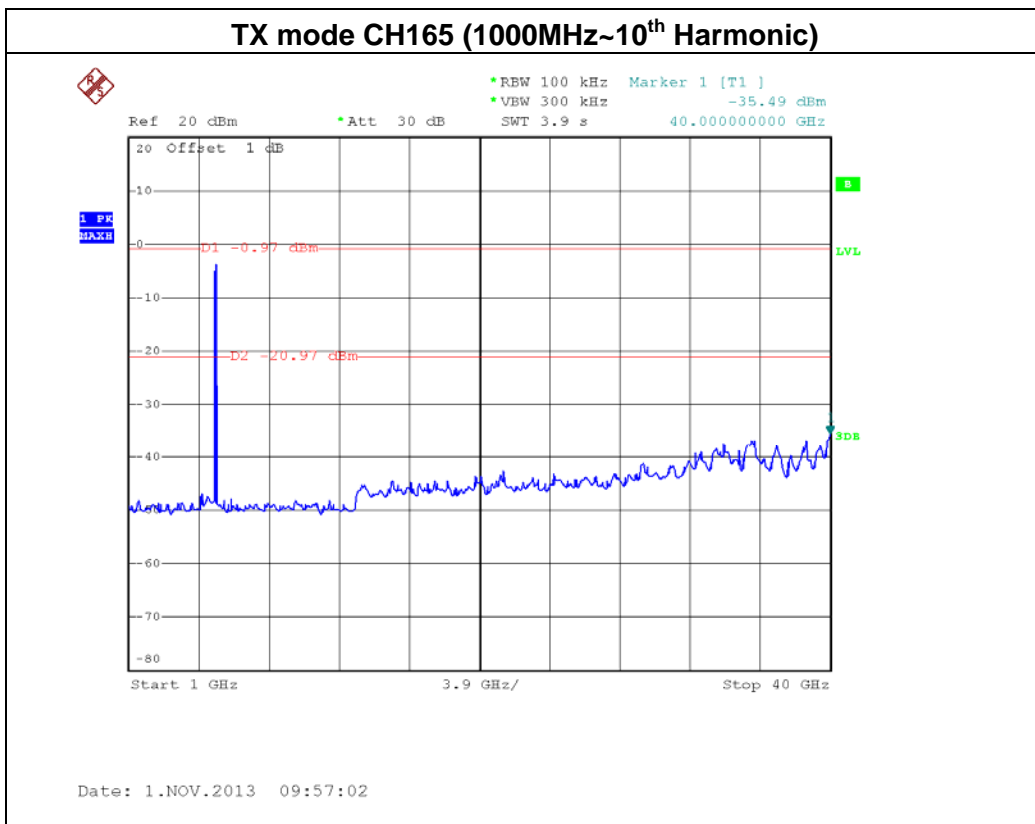
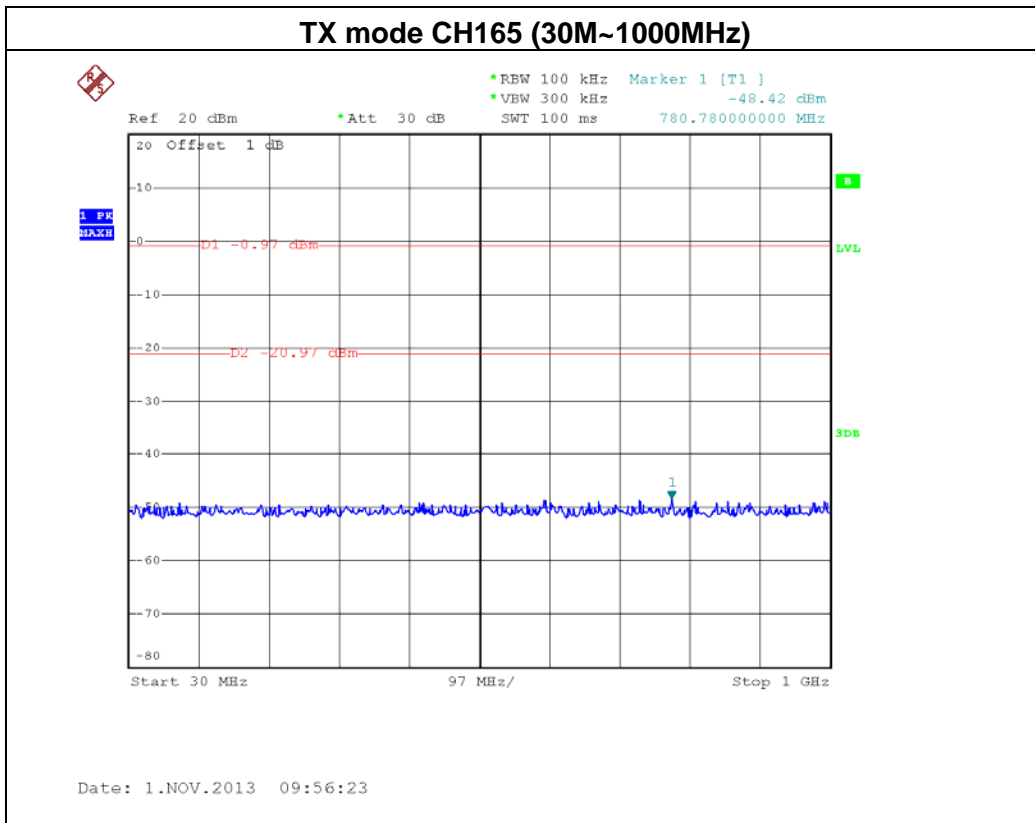



EUT:	High Power Dual Band Wireless 900N Low Profile Access Point	Model Name :	XAP-1500
Temperature:	25 °C	Relative Humidity:	58 %
Pressure:	1010 hPa	Test Voltage :	AC 120V/60Hz
Test Mode :	TX N20 Mode /CH149, CH157, CH165 / ANT 2		

Channel of Worst Data: CH149			
The max. radio frequency power in any 100kHz bandwidth outside the frequency band		The max. radio frequency power in any 100 kHz bandwidth within the frequency band.	
FREQUENCY(MHz)	POWER(dBm)	FREQUENCY(MHz)	POWER(dBm)
5724.40	-45.14	5854.60	-46.13

Result

In any 100kHz bandwidth outside the frequency band, the radio frequency power is at least 20dB below that in the 100kHz bandwidth within the band that contains the highest level of the desired power.

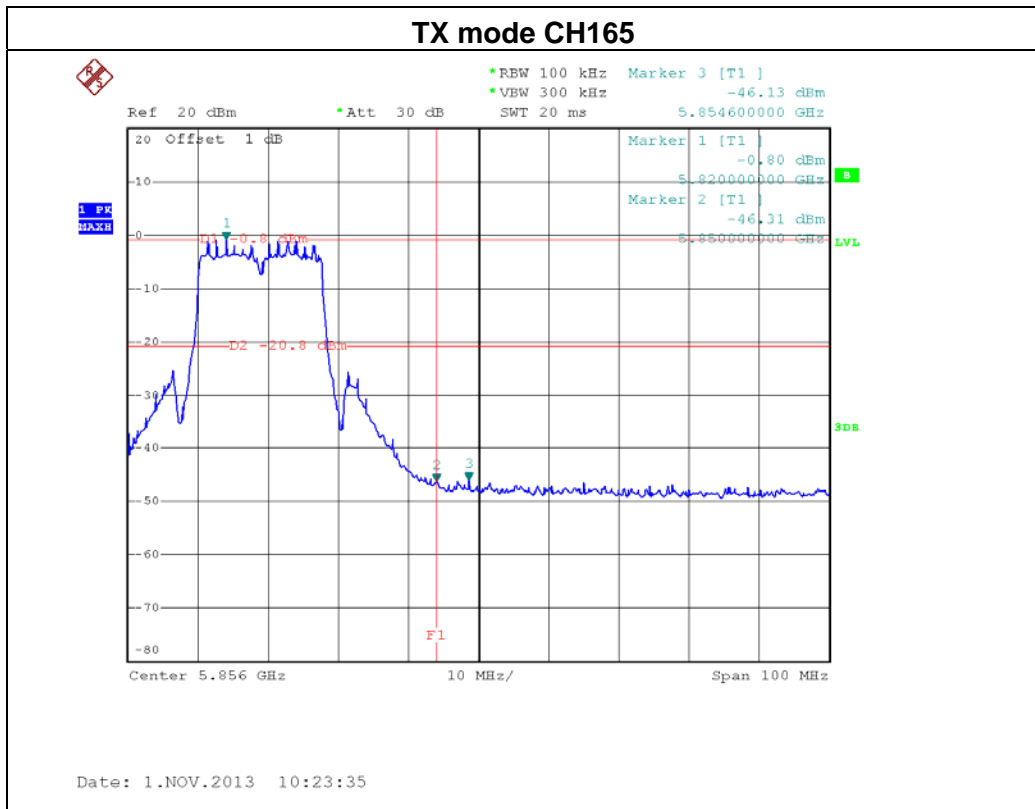
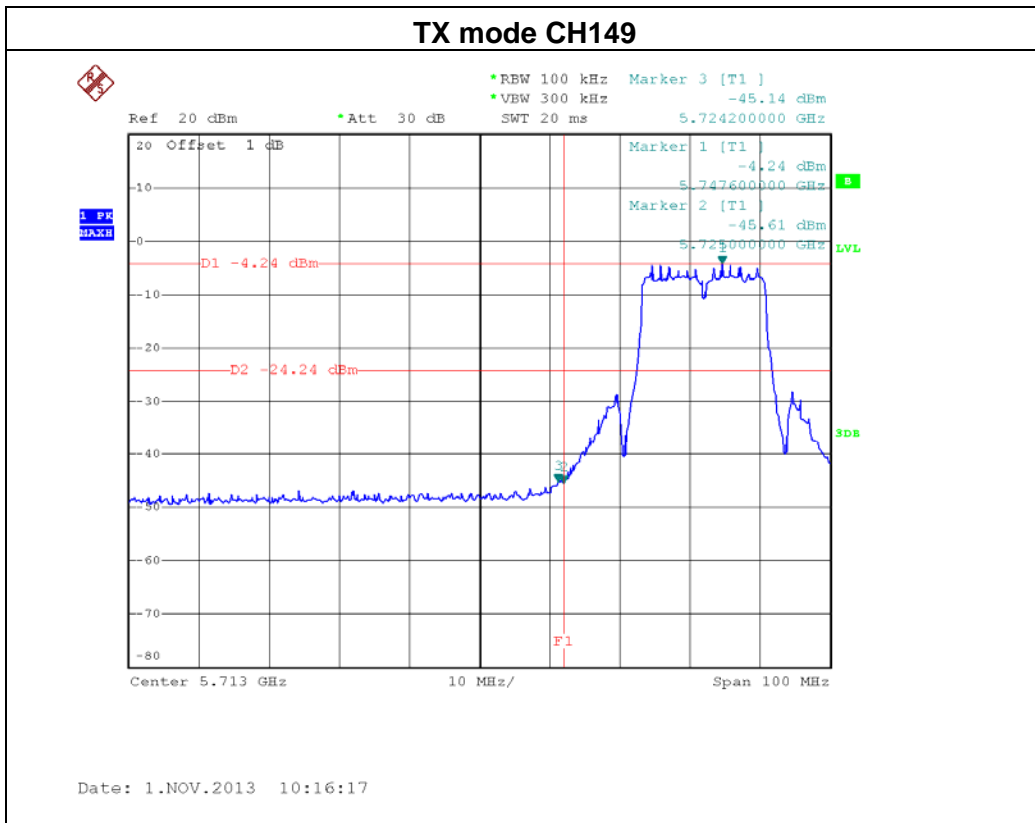

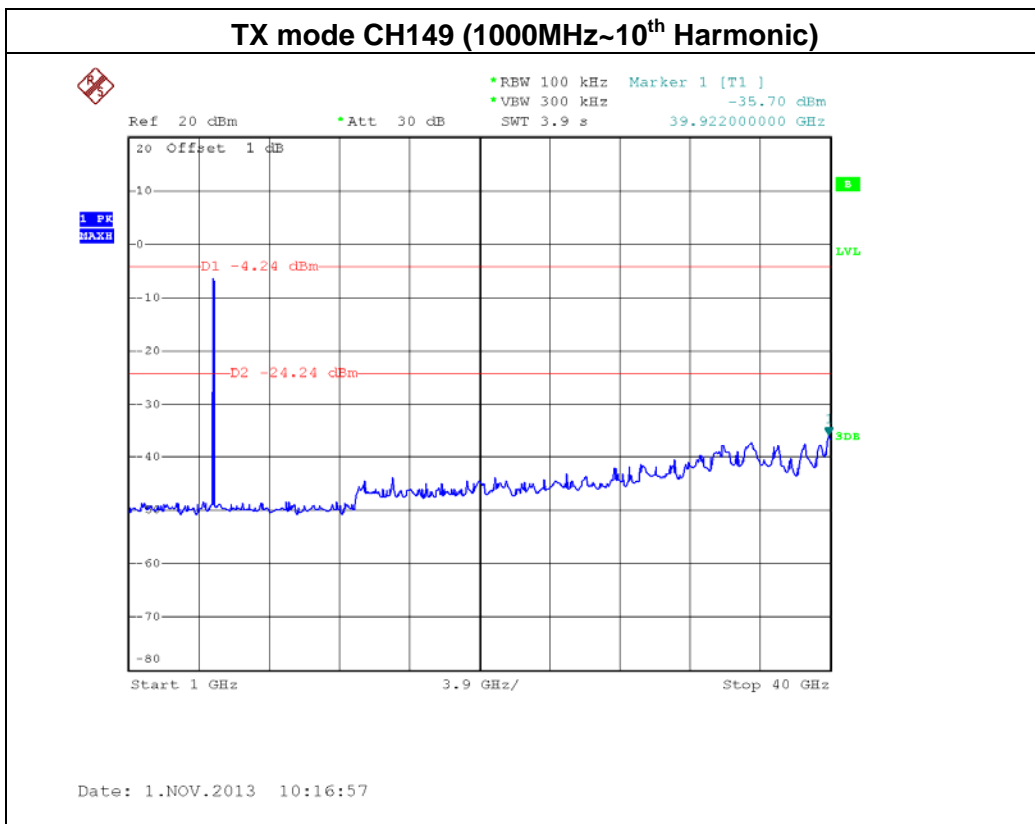
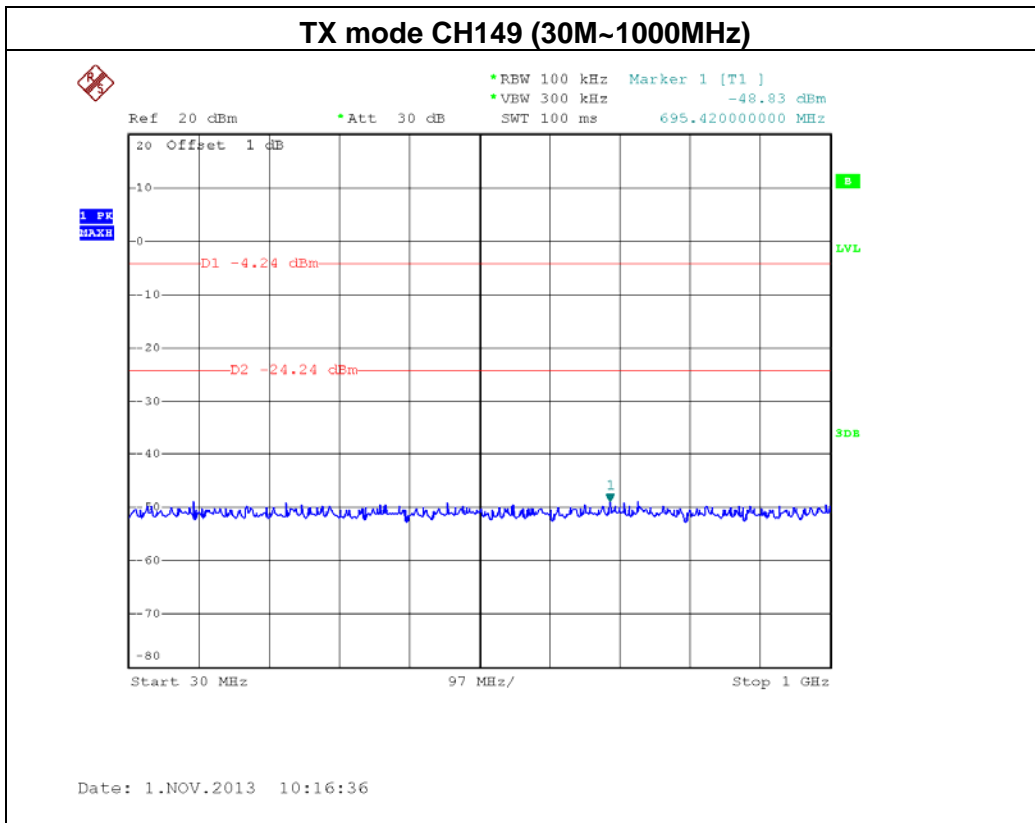

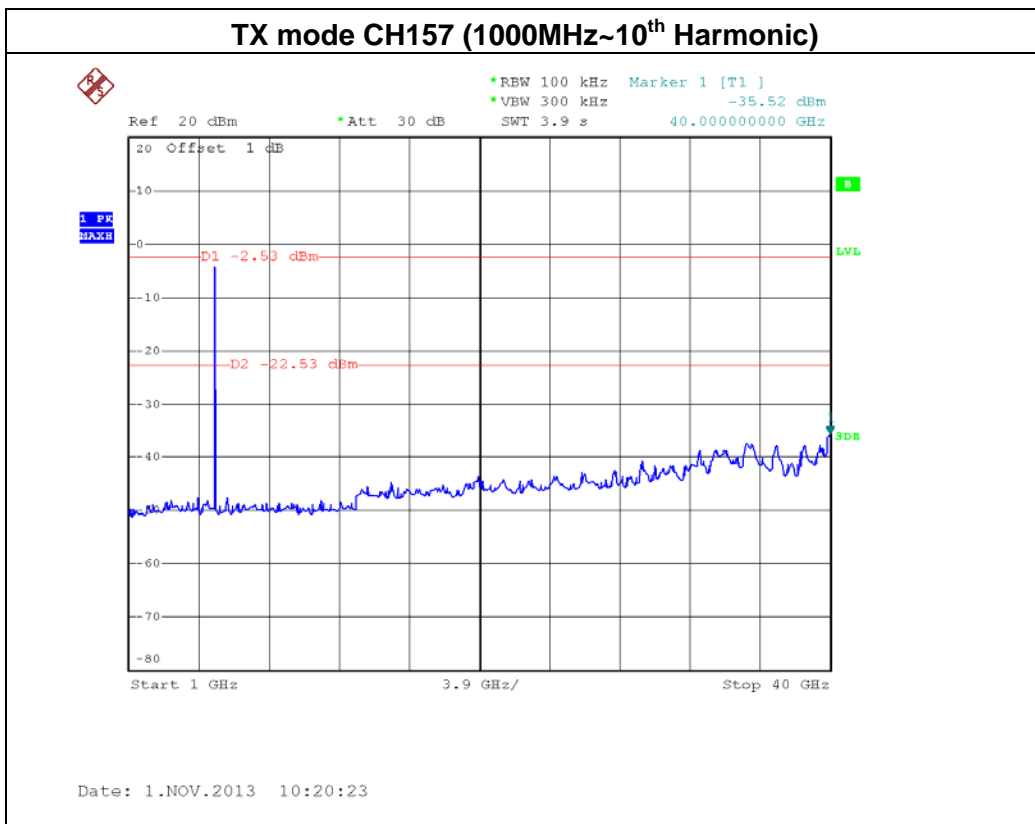
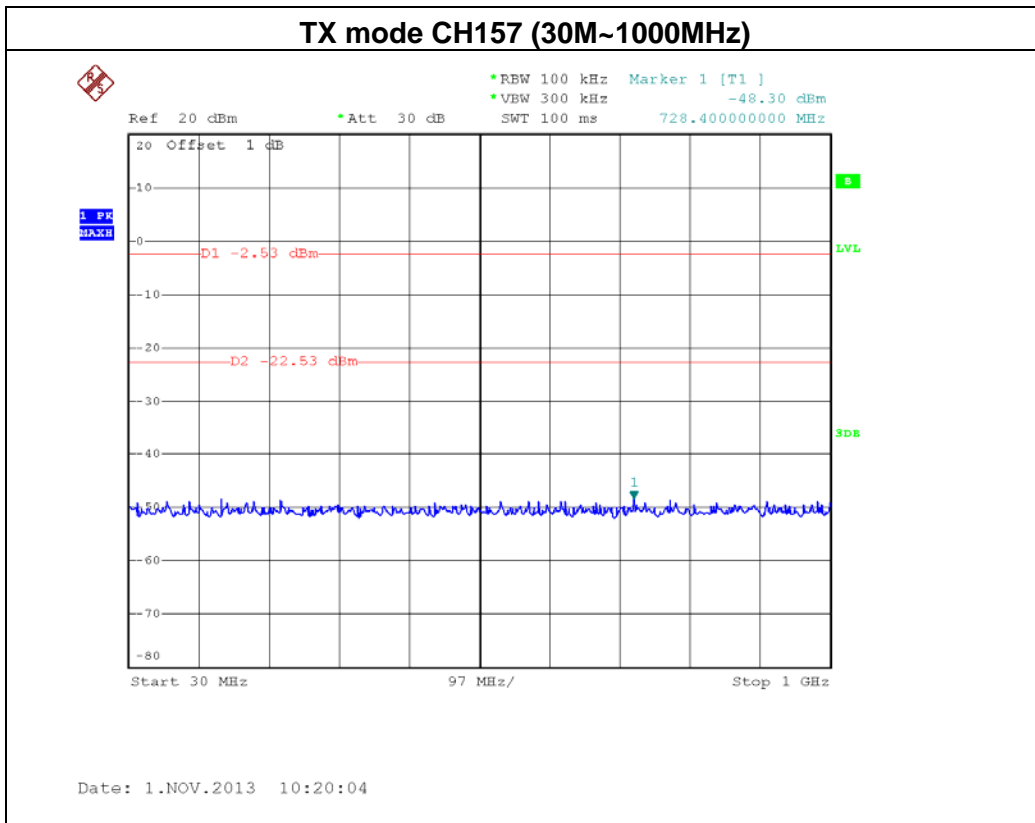

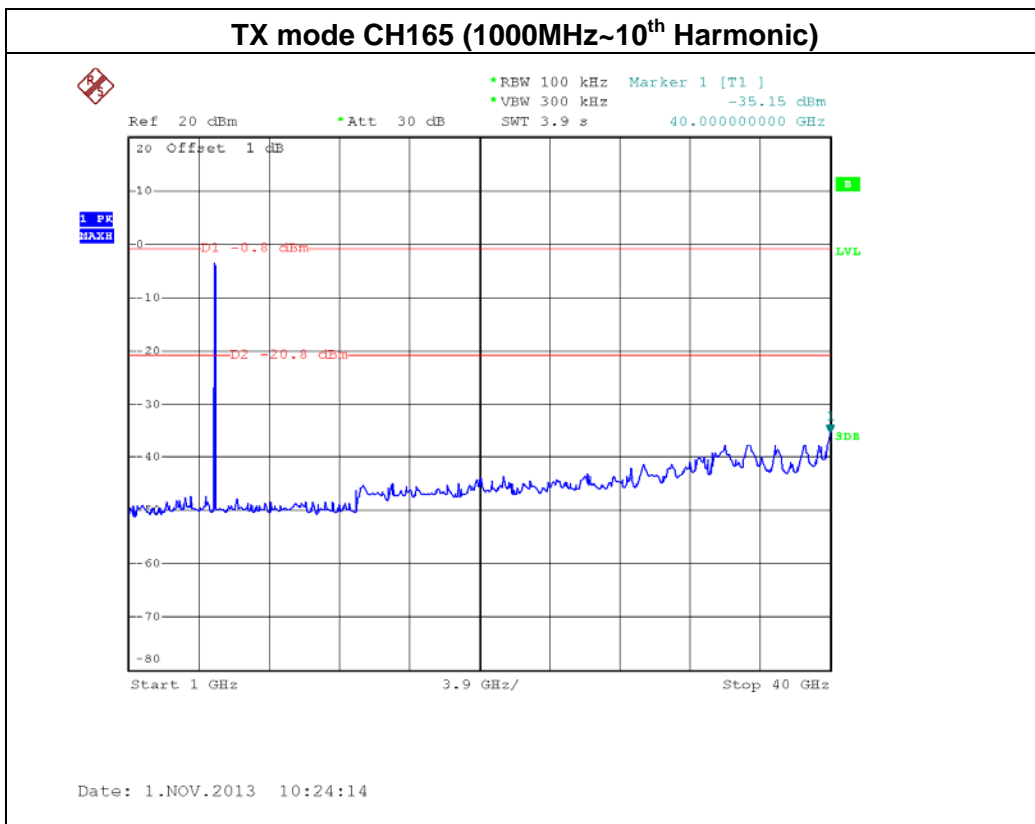
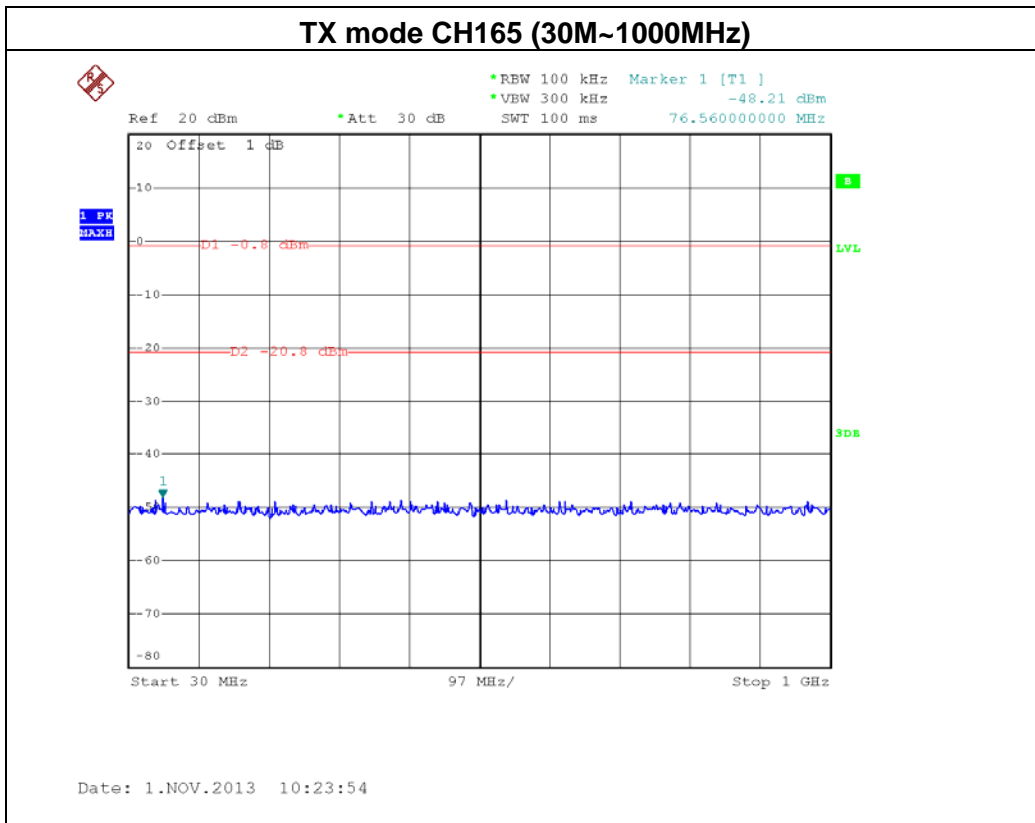



EUT:	High Power Dual Band Wireless 900N Low Profile Access Point	Model Name :	XAP-1500
Temperature:	25 °C	Relative Humidity:	58 %
Pressure:	1010 hPa	Test Voltage :	AC 120V/60Hz
Test Mode :	TX N40 Mode /CH151, CH159 / ANT 0		

Channel of Worst Data: CH151			
The max. radio frequency power in any 100kHz bandwidth outside the frequency band		The max. radio frequency power in any 100 kHz bandwidth within the frequency band.	
FREQUENCY(MHz)	POWER(dBm)	FREQUENCY(MHz)	POWER(dBm)
5719.80	-42.94	5853.00	-46.49

Result

In any 100kHz bandwidth outside the frequency band, the radio frequency power is at least 20dB below that in the 100kHz bandwidth within the band that contains the highest level of the desired power.

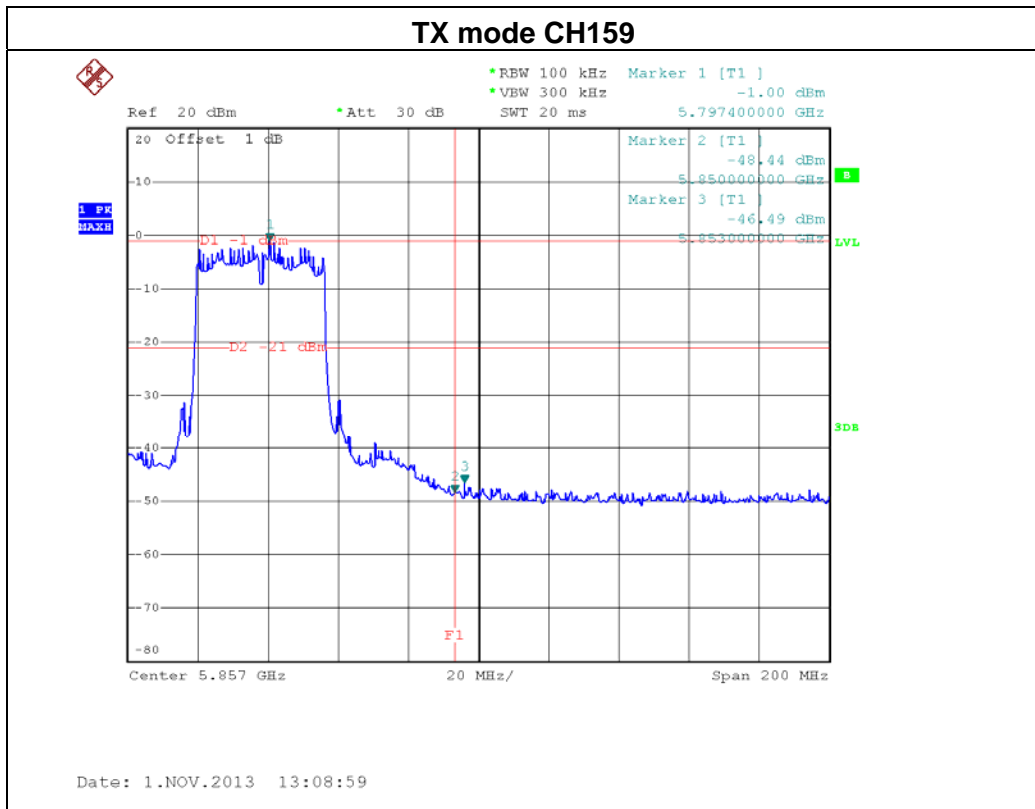
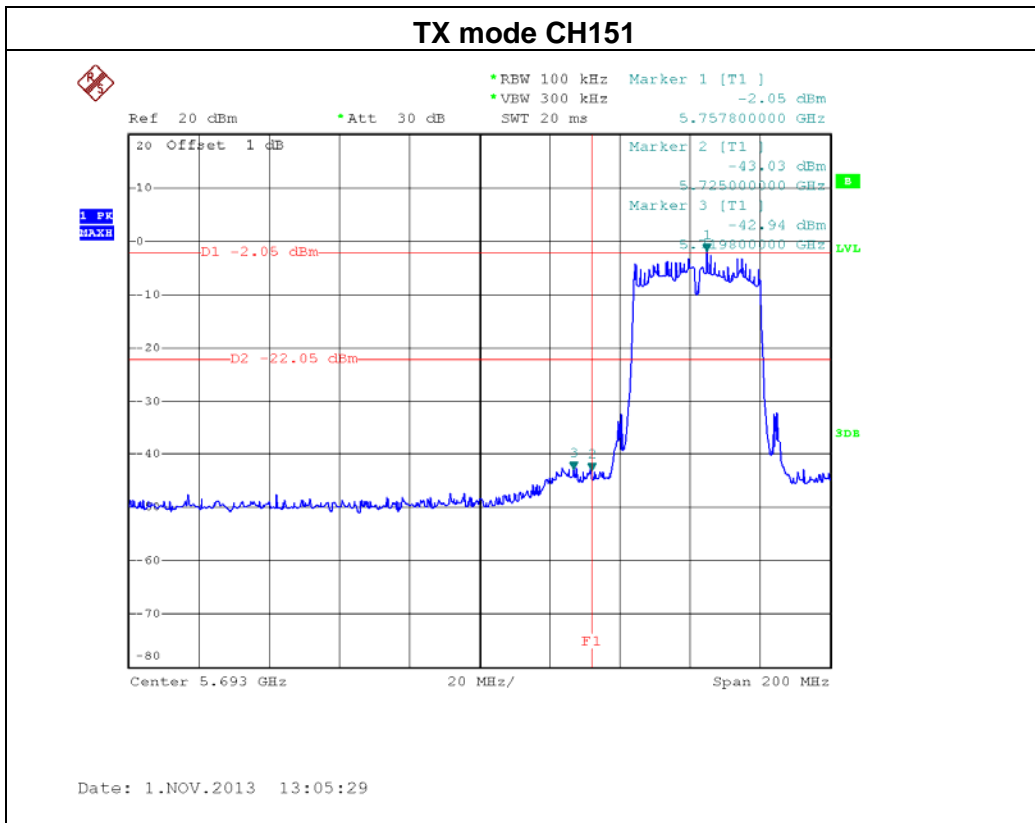

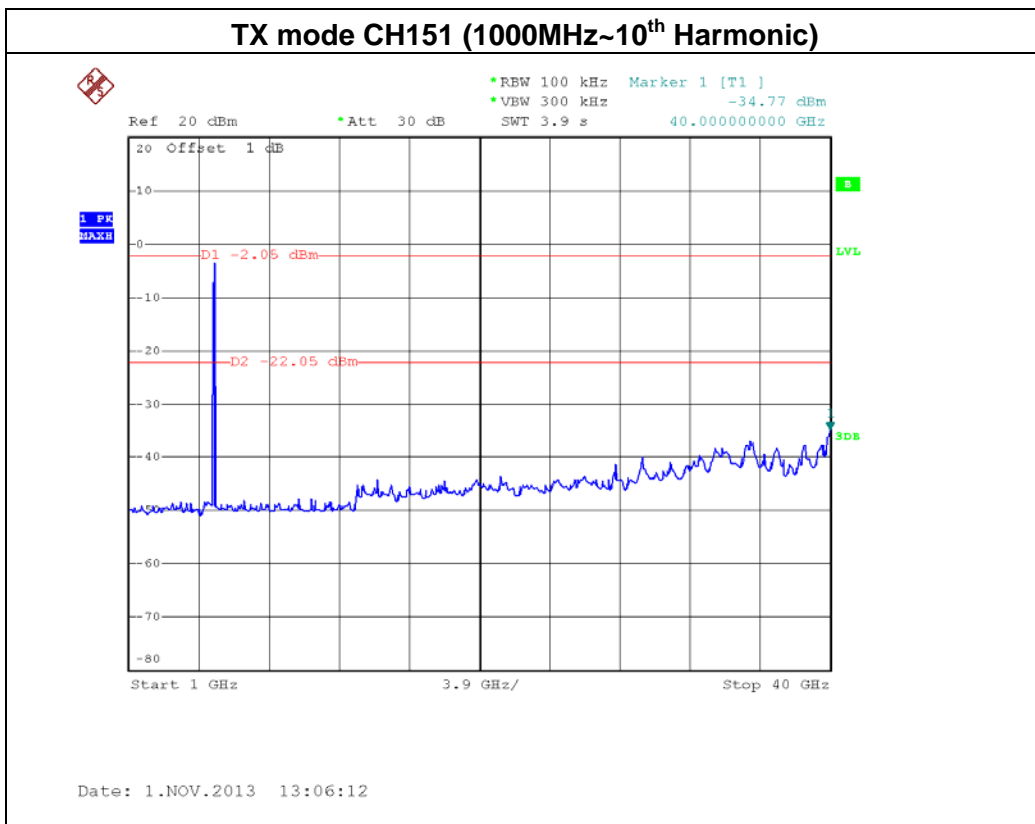
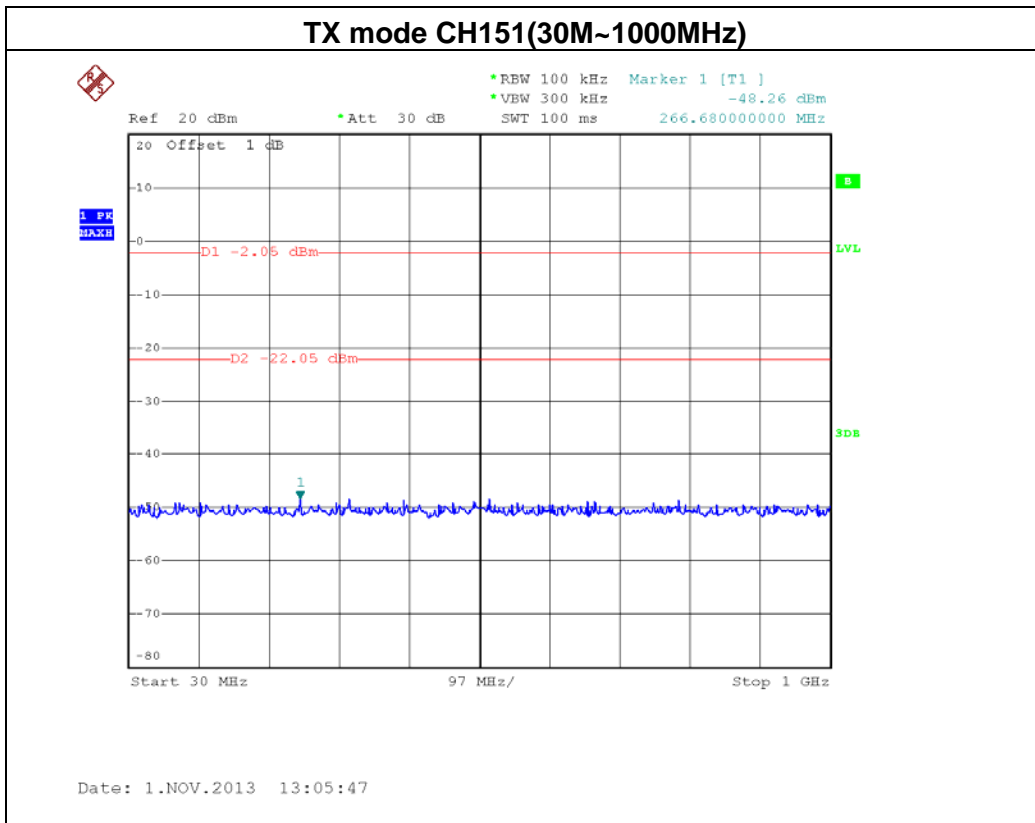

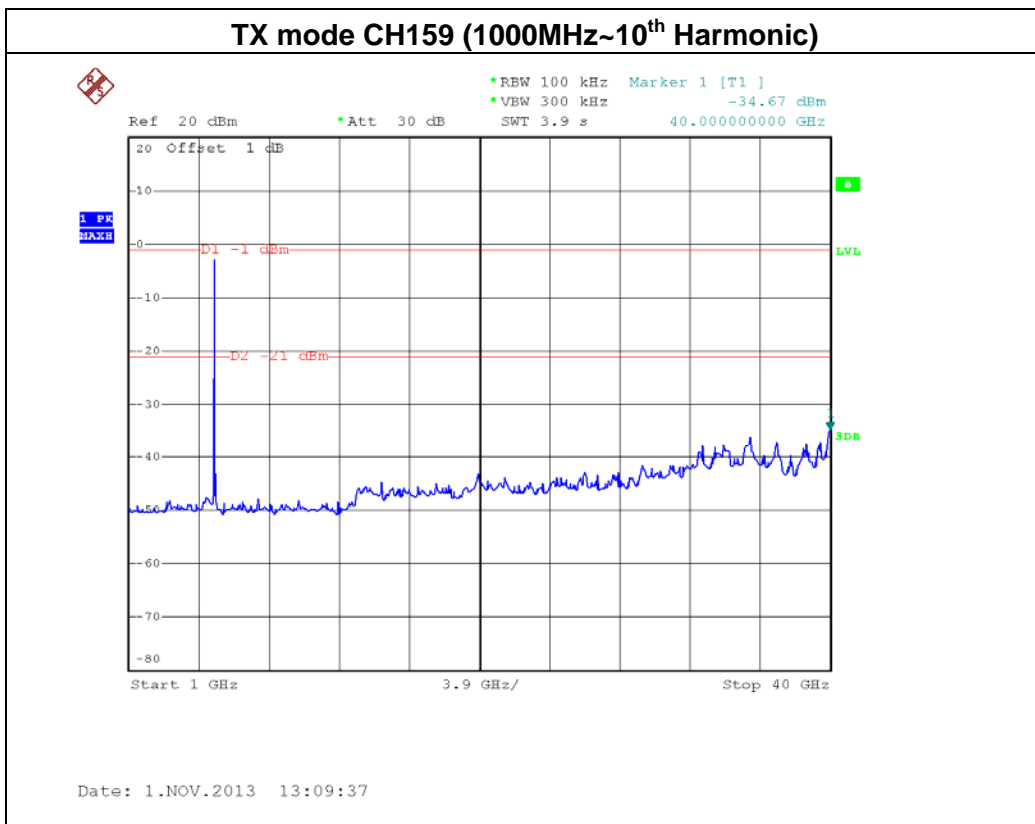
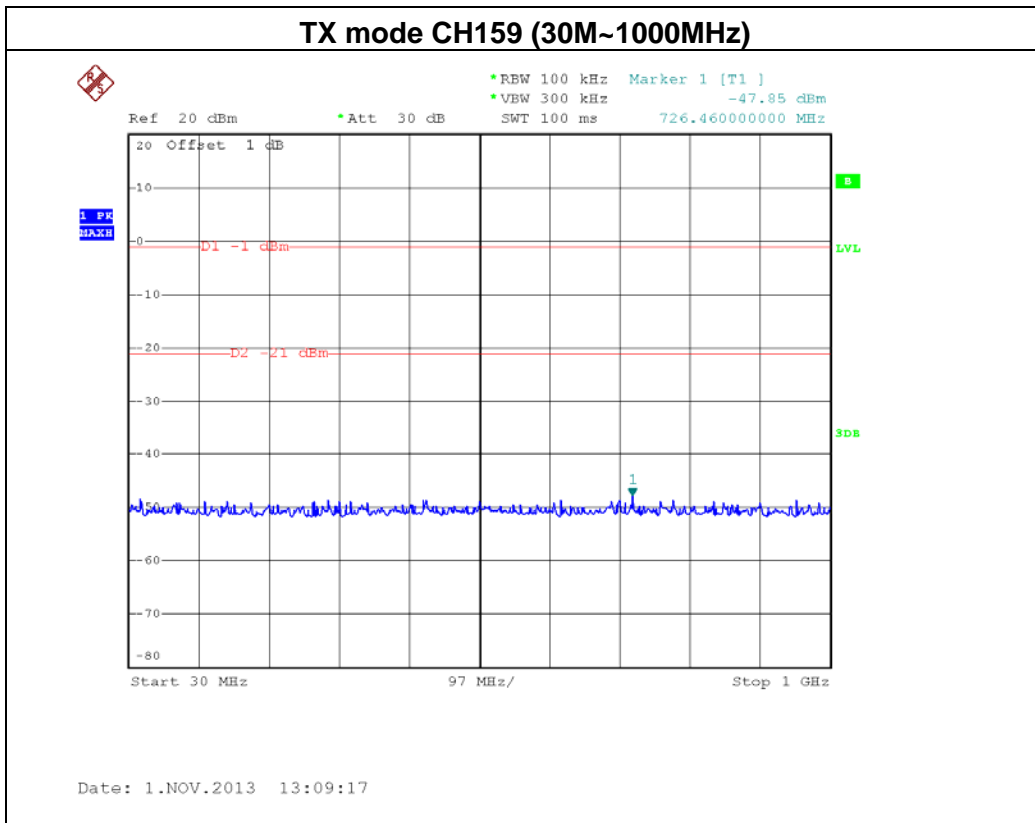



EUT:	High Power Dual Band Wireless 900N Low Profile Access Point	Model Name :	XAP-1500
Temperature:	25 °C	Relative Humidity:	58 %
Pressure:	1010 hPa	Test Voltage :	AC 120V/60Hz
Test Mode :	TX N40 Mode /CH151, CH159 / ANT 1		

Channel of Worst Data: CH151

The max. radio frequency power in any 100kHz bandwidth outside the frequency band		The max. radio frequency power in any 100 kHz bandwidth within the frequency band.	
FREQUENCY(MHz)	POWER(dBm)	FREQUENCY(MHz)	POWER(dBm)
5722.60	-36.90	5852.60	-45.74

Result

In any 100kHz bandwidth outside the frequency band, the radio frequency power is at least 20dB below that in the 100kHz bandwidth within the band that contains the highest level of the desired power.

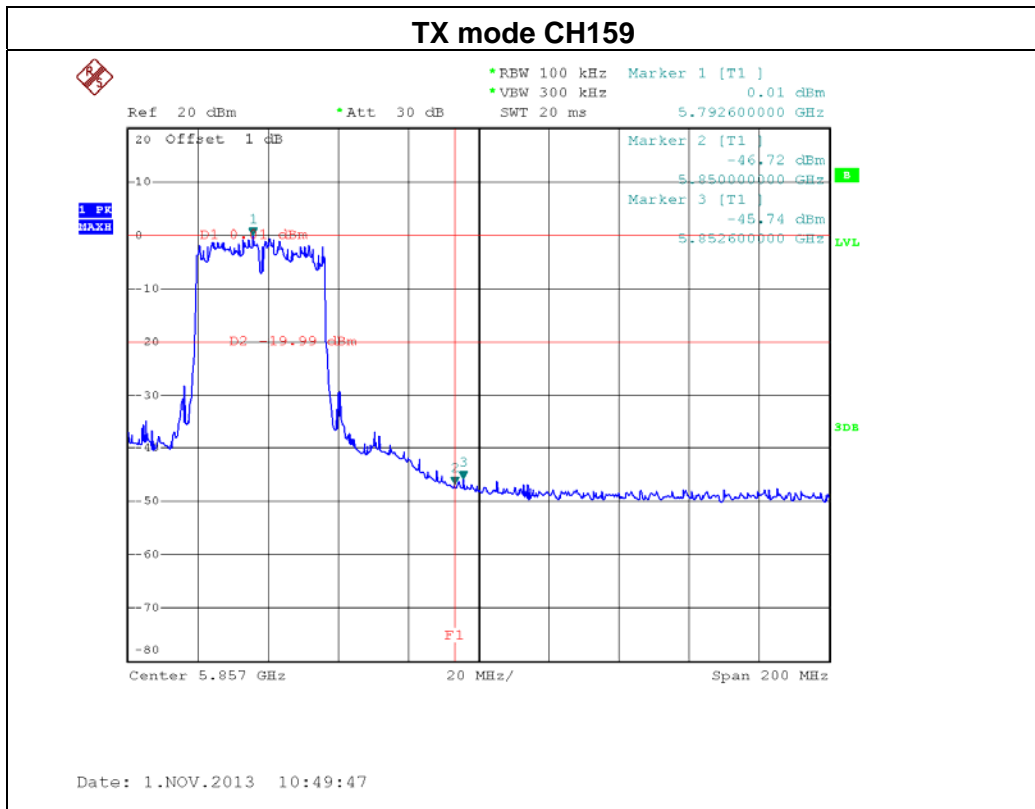
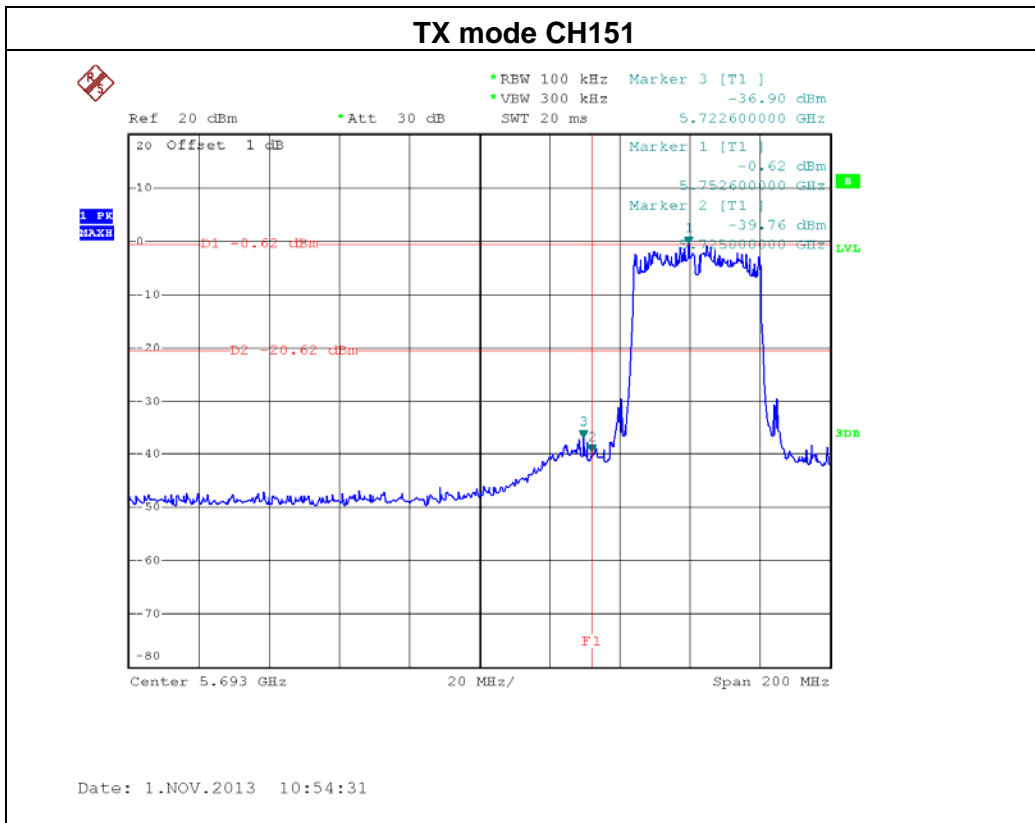

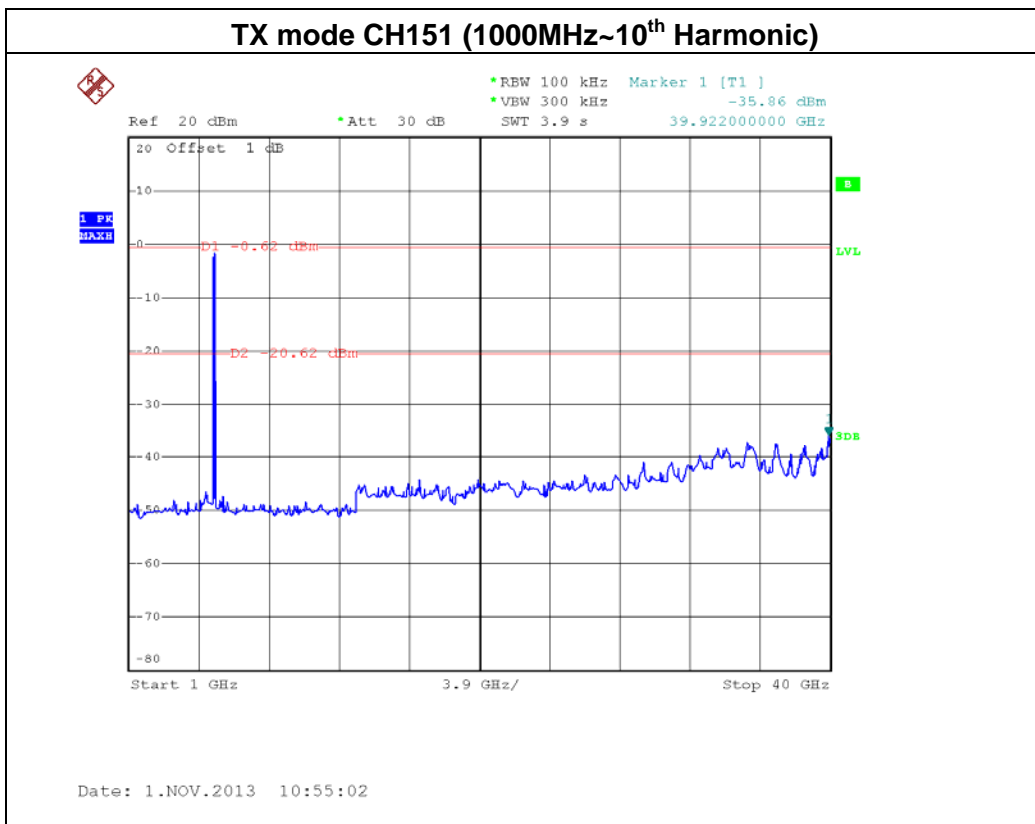
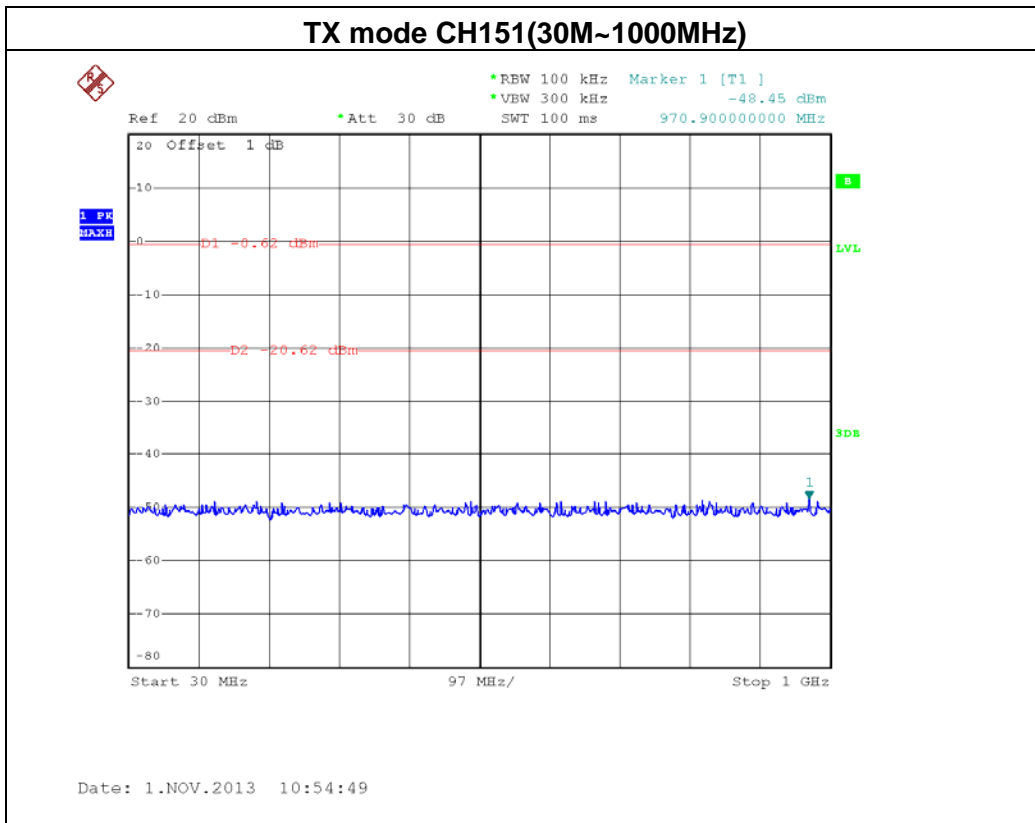

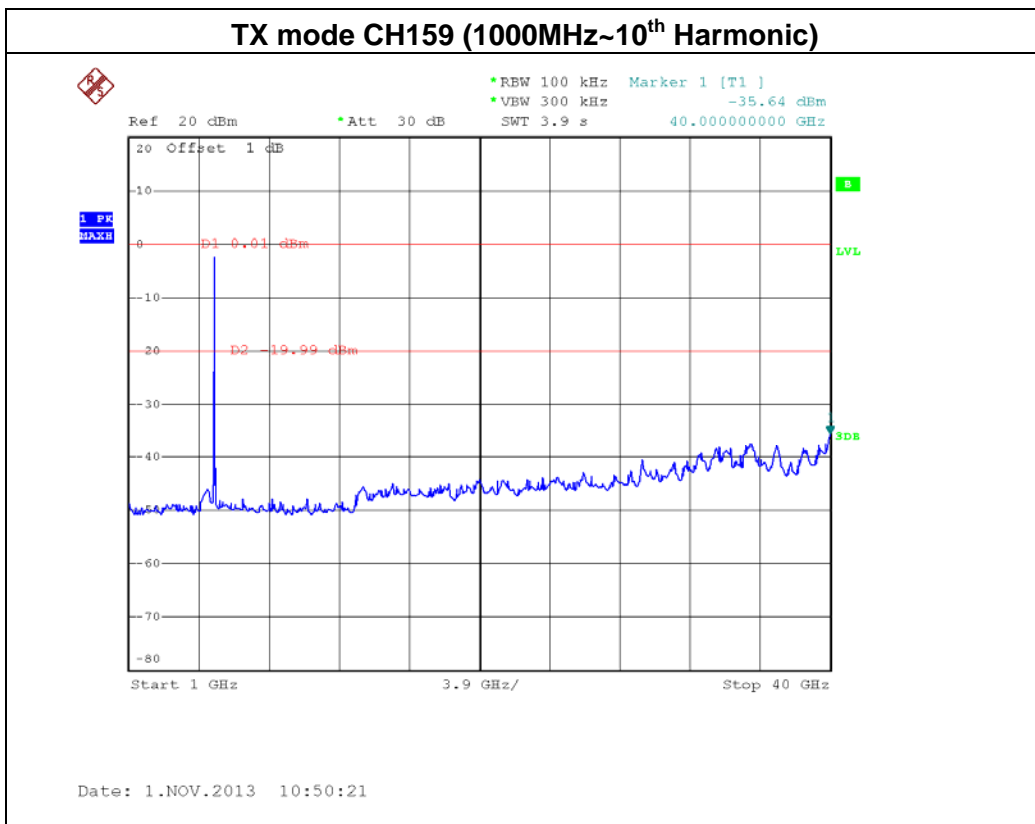
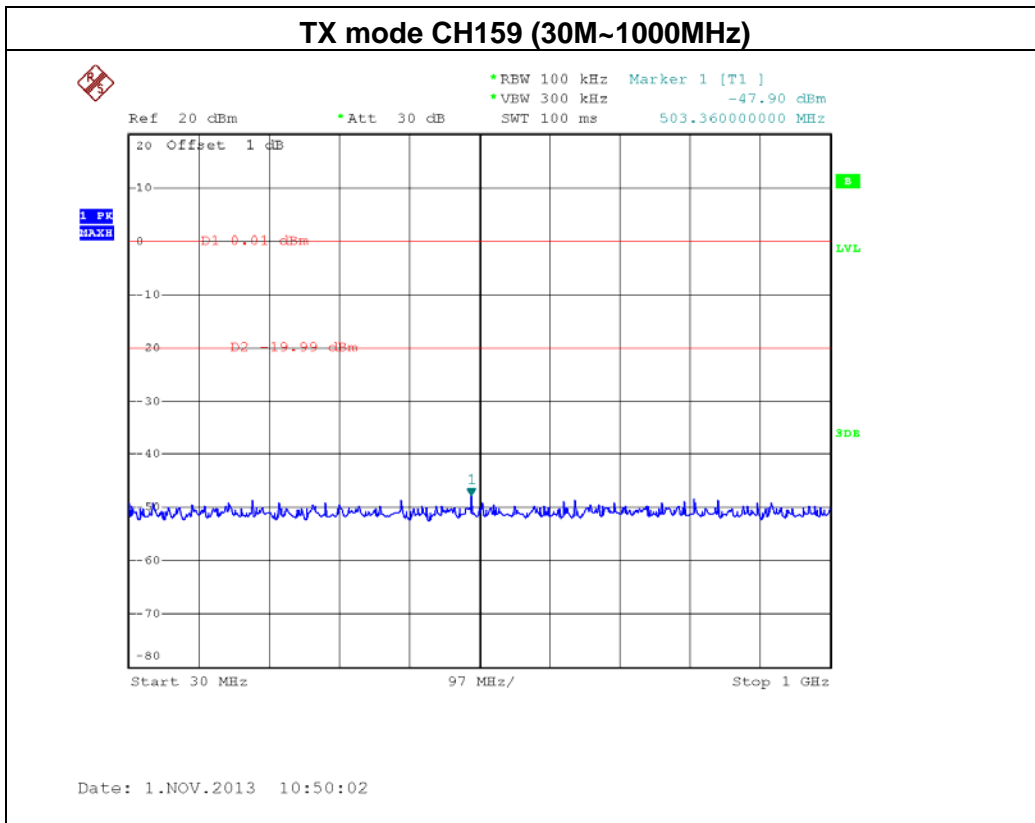



EUT:	High Power Dual Band Wireless 900N Low Profile Access Point	Model Name :	XAP-1500
Temperature:	25 °C	Relative Humidity:	58 %
Pressure:	1010 hPa	Test Voltage :	AC 120V/60Hz
Test Mode :	TX N40 Mode /CH151, CH159 / ANT 2		

Channel of Worst Data: CH151			
The max. radio frequency power in any 100kHz bandwidth outside the frequency band		The max. radio frequency power in any 100 kHz bandwidth within the frequency band.	
FREQUENCY(MHz)	POWER(dBm)	FREQUENCY(MHz)	POWER(dBm)
5721.40	-41.39	5868.20	-47.71

Result

In any 100kHz bandwidth outside the frequency band, the radio frequency power is at least 20dB below that in the 100kHz bandwidth within the band that contains the highest level of the desired power.

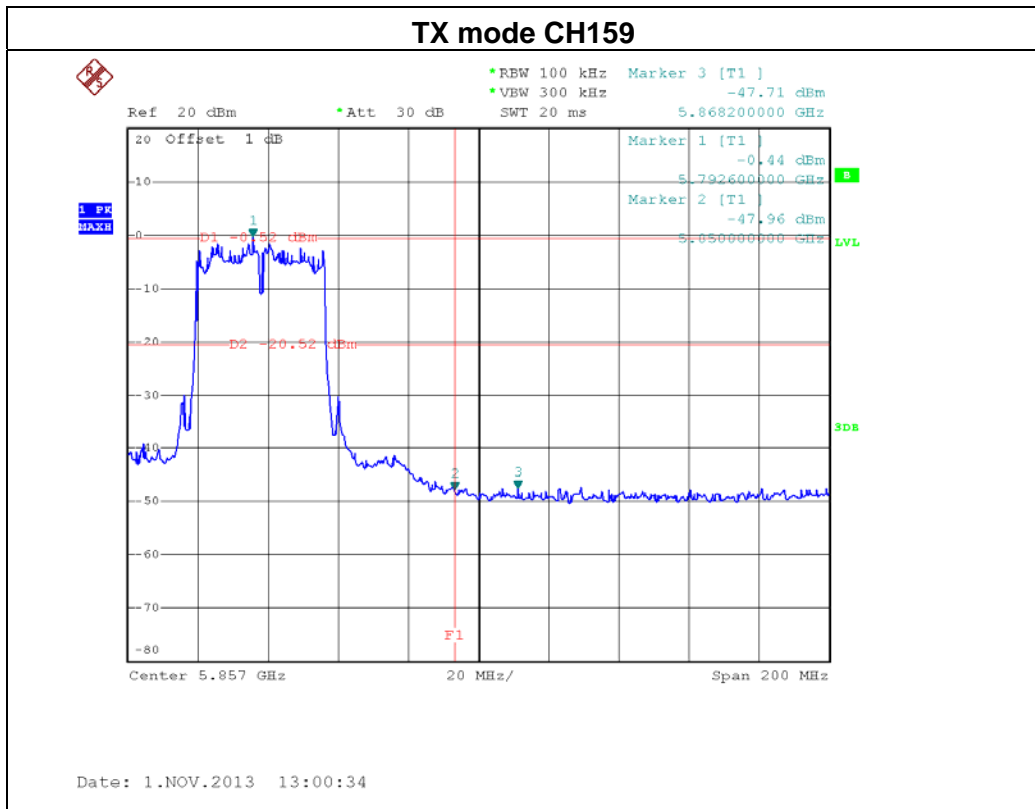
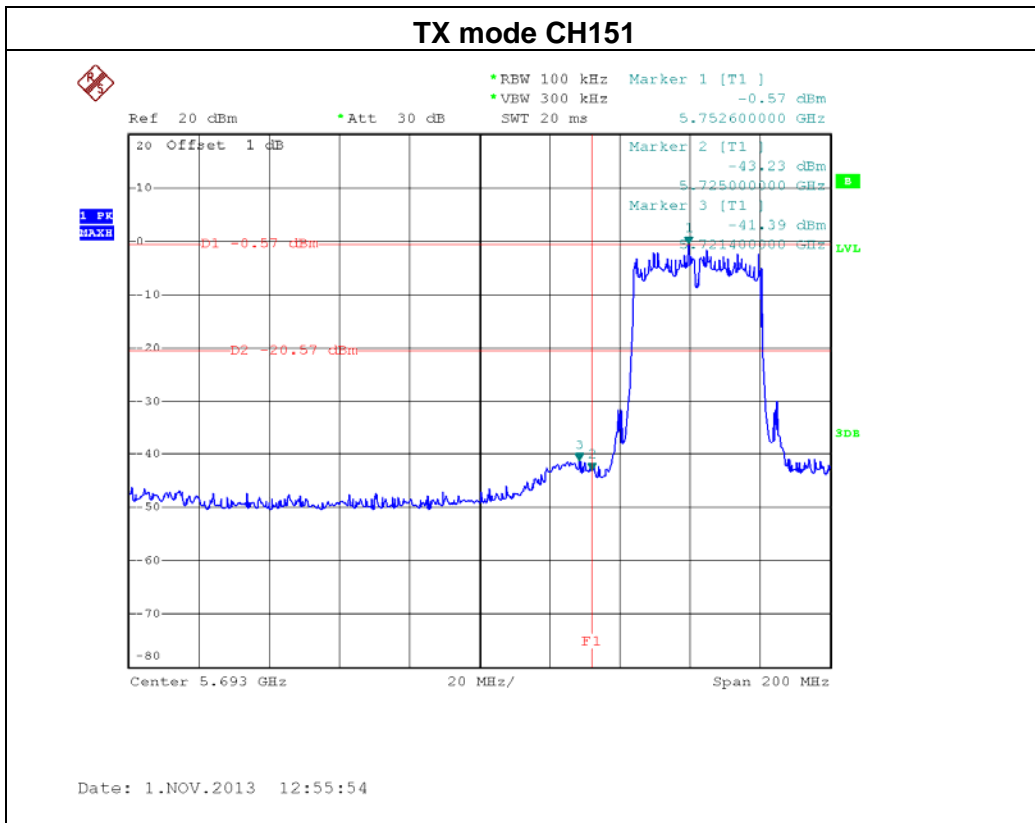

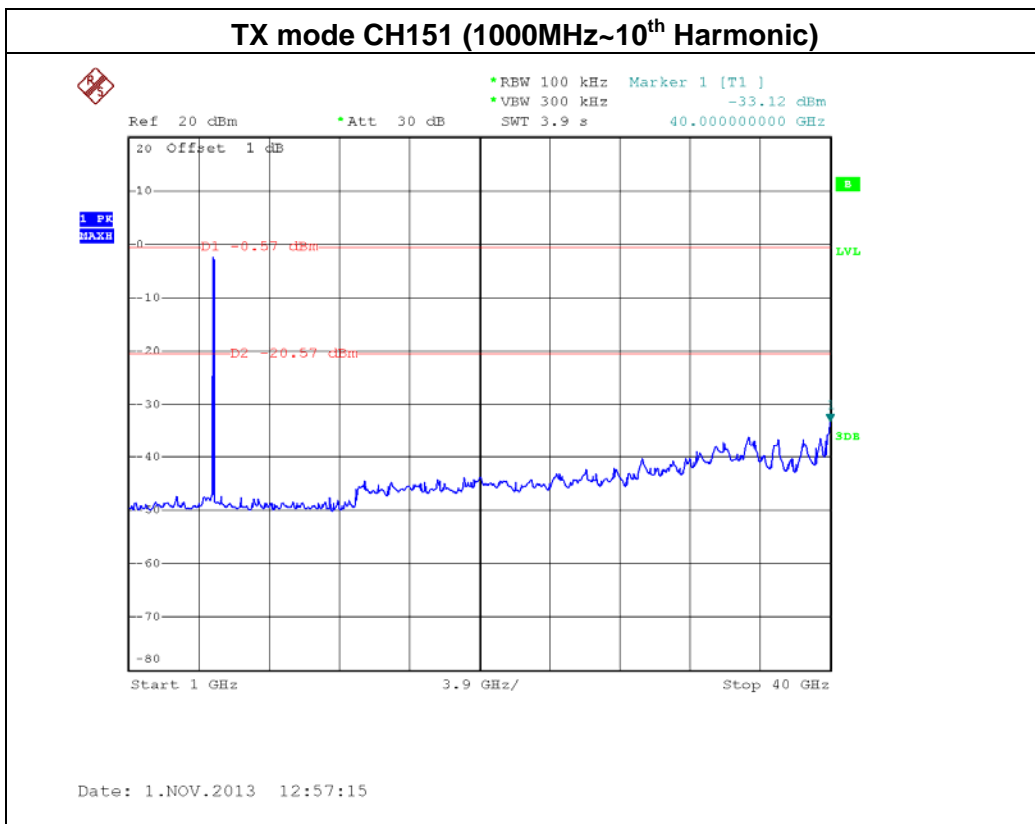
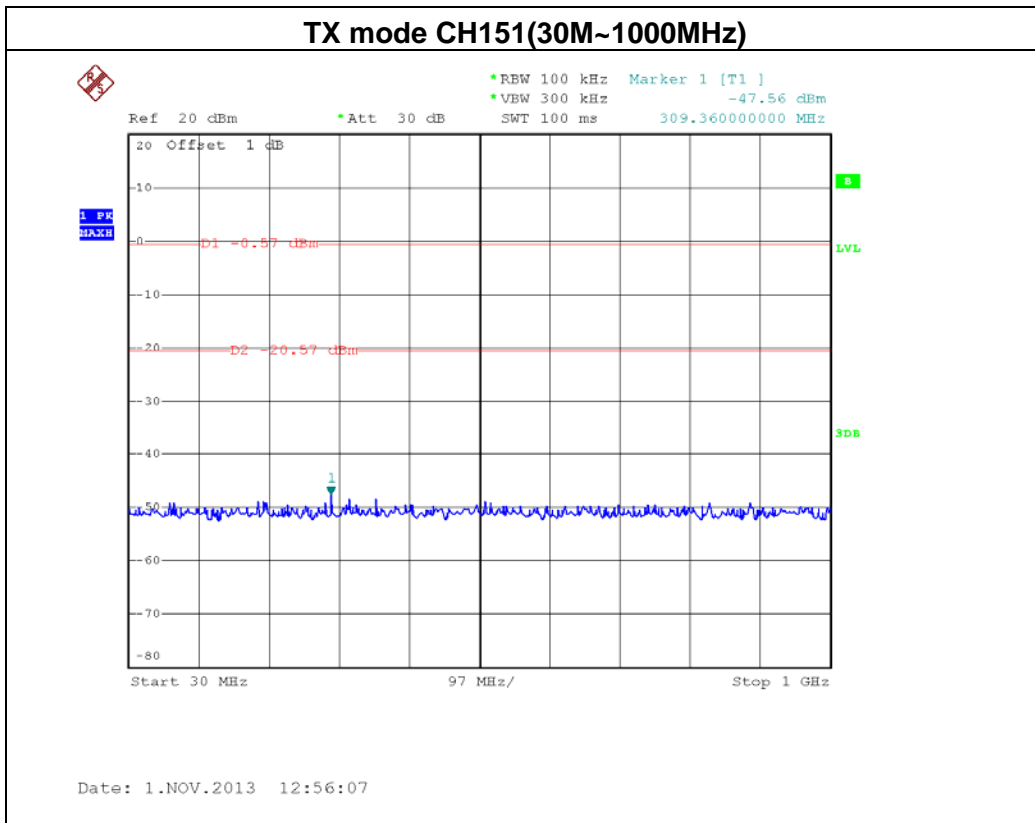

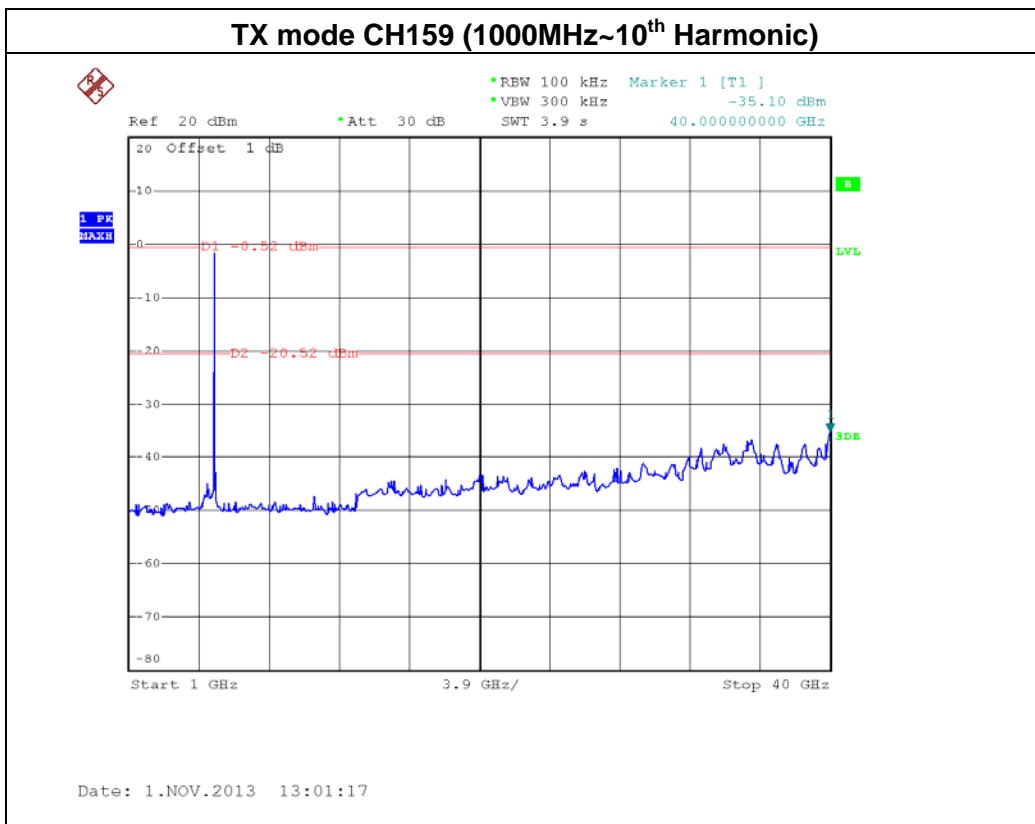
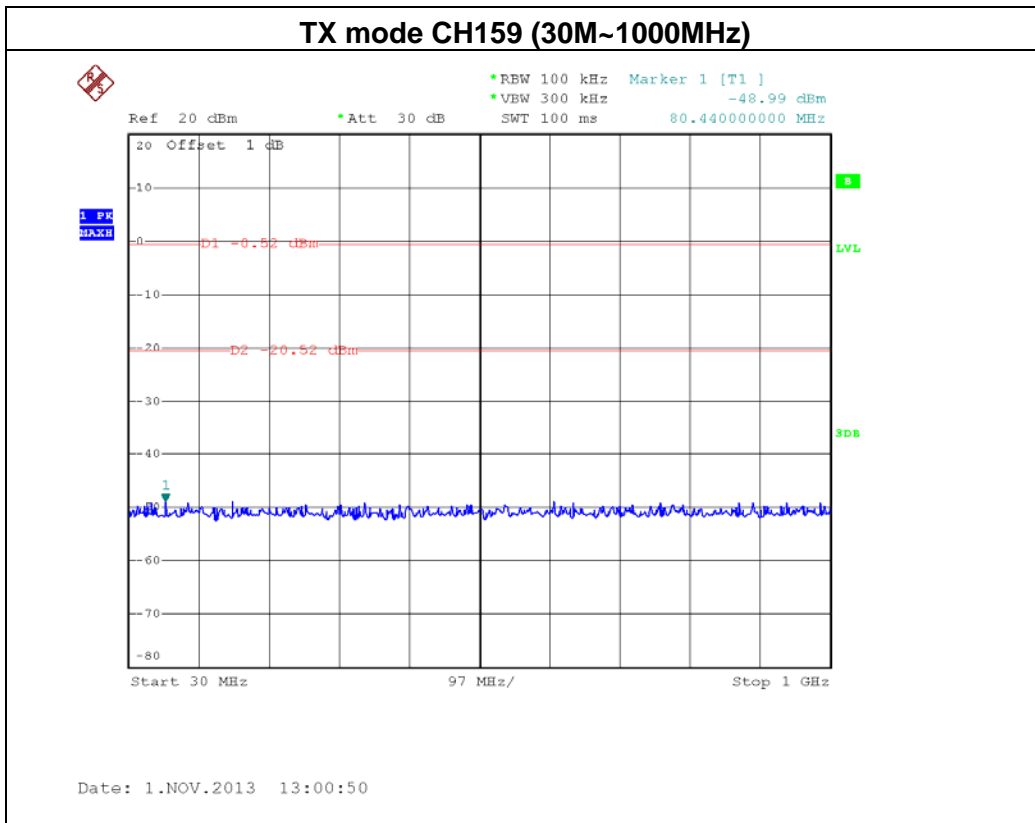



8. POWER SPECTRAL DENSITY TEST

8.1 Applied procedures / limit

FCC Part15 (15.247) , Subpart C				
Section	Test Item	Limit	Frequency Range (MHz)	Result
15.247(e)	Power Spectral Density	8 dBm (in any 3KHz)	5745 - 5825	PASS

8.1.1 MEASUREMENT INSTRUMENTS LIST

Item	Kind of Equipment	Manufacturer	Type No.	Serial No.	Calibrated until
1	Spectrum Analyzer	R&S	FSP 40	100185	Nov. 16, 2013

Remark: "N/A" denotes no model name, serial no. or calibration specified.
 All calibration period of Equipment List is One Year.

8.1.2 TEST PROCEDURE

- a. The EUT was directly connected to the spectrum analyzer and antenna output port as show in the block diagram below,
- b. Spectrum Setting : RBW=3KHz, VBW=10KHz, Sweep time = auto.
- c. The power spectral density was performed in accordance with method 10.2 of FCC KDB 558074 D01 DTS Meas Guidance v03r01 (A, N20, N40 mode) and 662911 D01 Multiple Transmitter Output v01r02. (N20,N40 mode)

8.1.3 DEVIATION FROM STANDARD

No deviation.

8.1.4 TEST SETUP

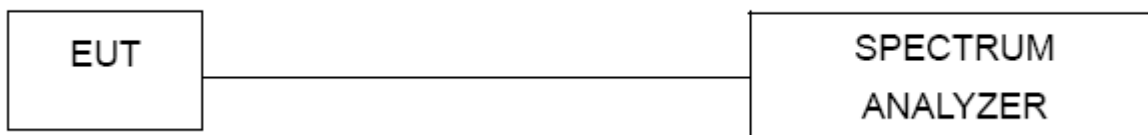

8.1.5 EUT OPERATION CONDITIONS

The EUT tested system was configured as the statements of 4.1.6 Unless otherwise a special operating condition is specified in the follows during the testing.



8.1.6 TEST RESULTS

EUT:	High Power Dual Band Wireless 900N Low Profile Access Point	Model Name :	XAP-1500
Temperature:	23 °C	Relative Humidity:	51 %
Pressure:	1010 hPa	Test Voltage :	AC 120V/60Hz
Test Mode :	TX A Mode /CH149, CH157, CH165		

Test Channel	Frequency (MHz)	Power Density (dBm)	LIMIT (dBm)
CH149	5745 MHz	-4.46	8
CH157	5785 MHz	-5.39	8
CH165	5825 MHz	-5.44	8

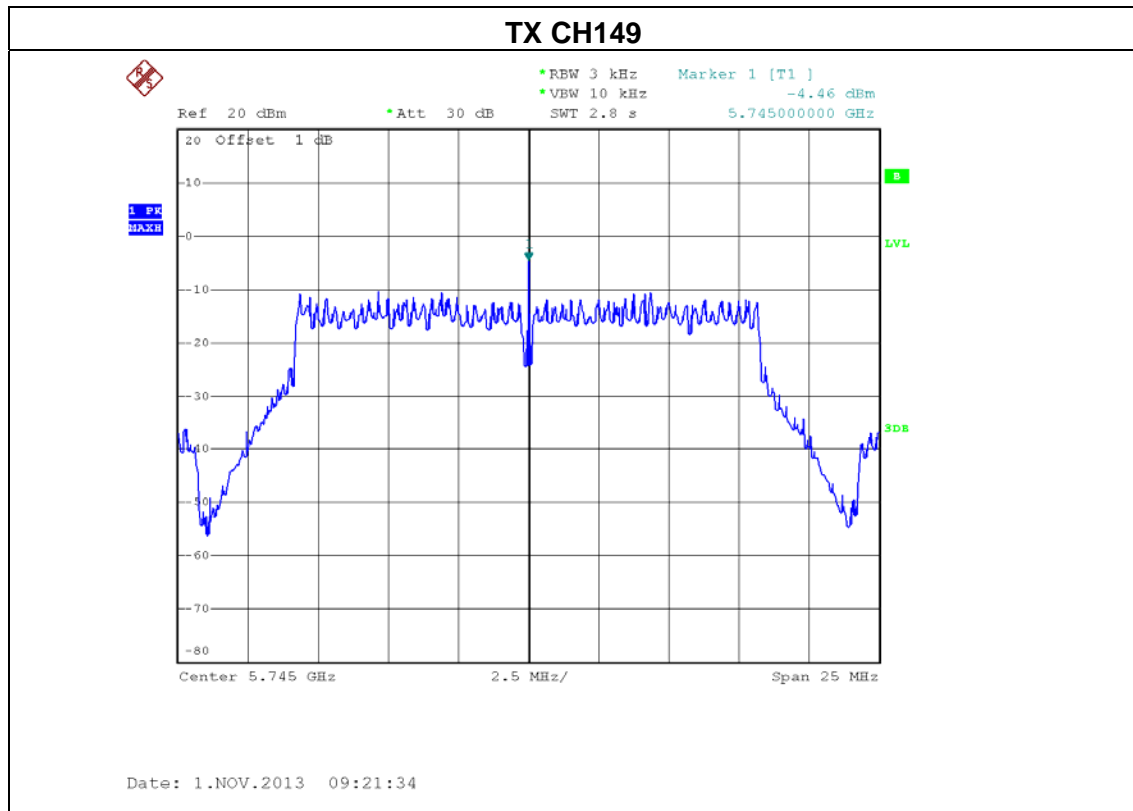

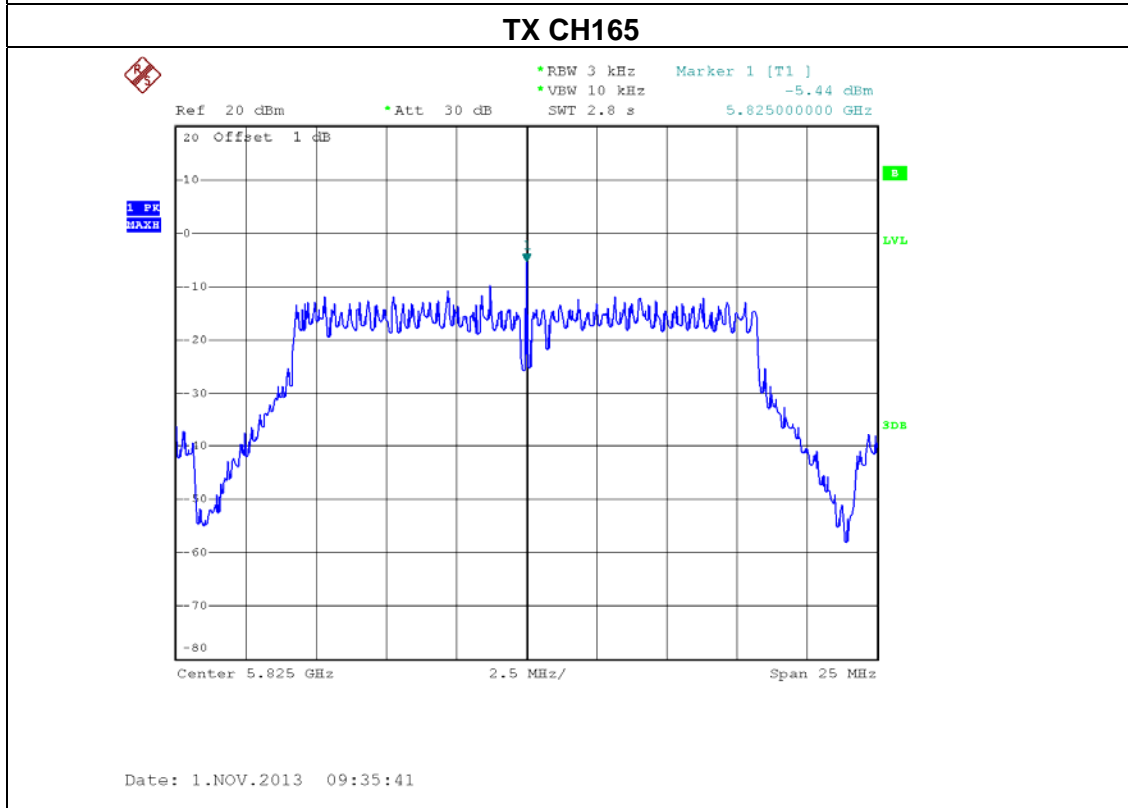
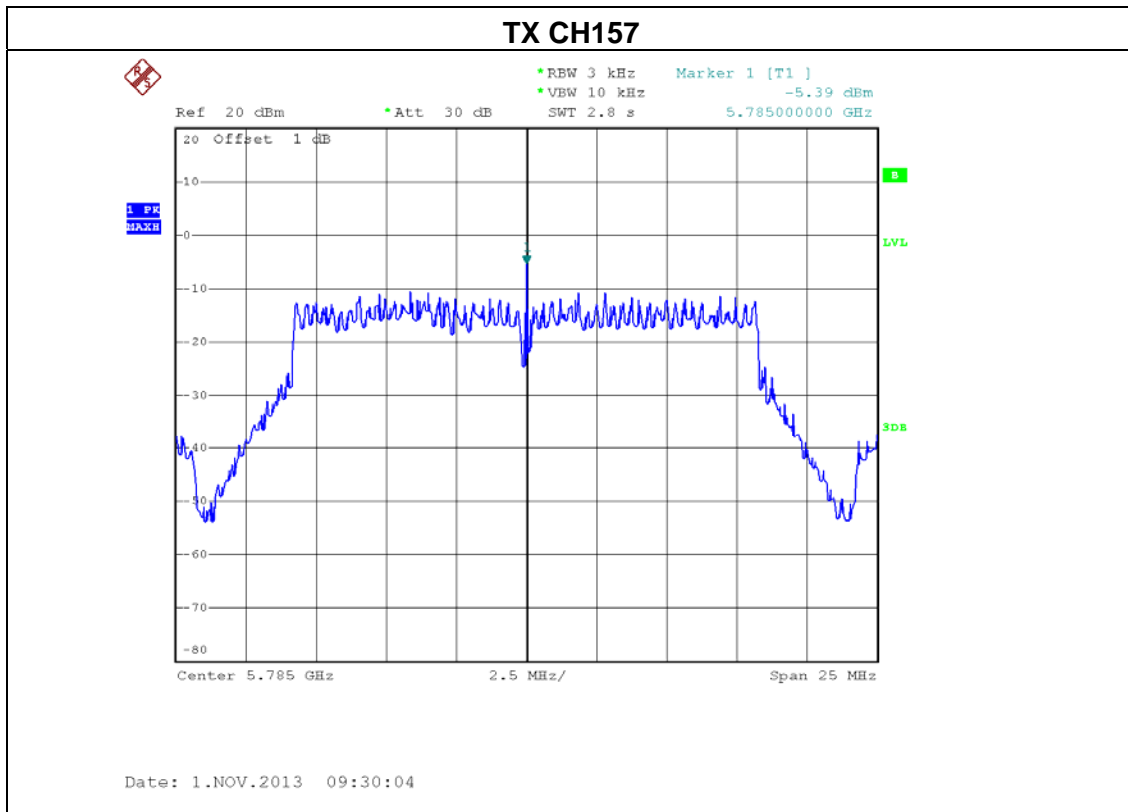



EUT:	High Power Dual Band Wireless 900N Low Profile Access Point	Model Name :	XAP-1500
Temperature:	23 °C	Relative Humidity:	51 %
Pressure:	1010 hPa	Test Voltage :	AC 120V/60Hz
Test Mode :	TX N20 Mode /CH149, CH157, CH165 / ANT 0		

Test Channel	Frequency (MHz)	Power Density (dBm)	LIMIT (dBm)
CH149	5745 MHz	-17.62	8
CH157	5785 MHz	-17.80	8
CH165	5825 MHz	-16.42	8

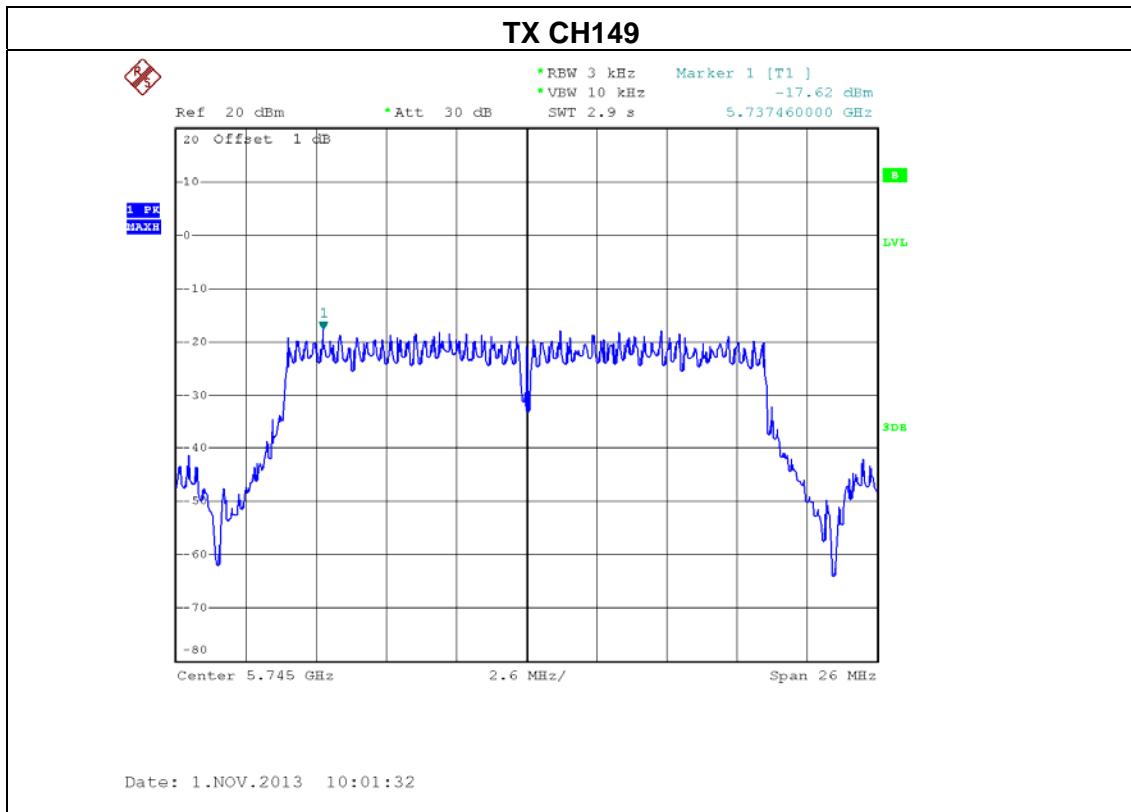

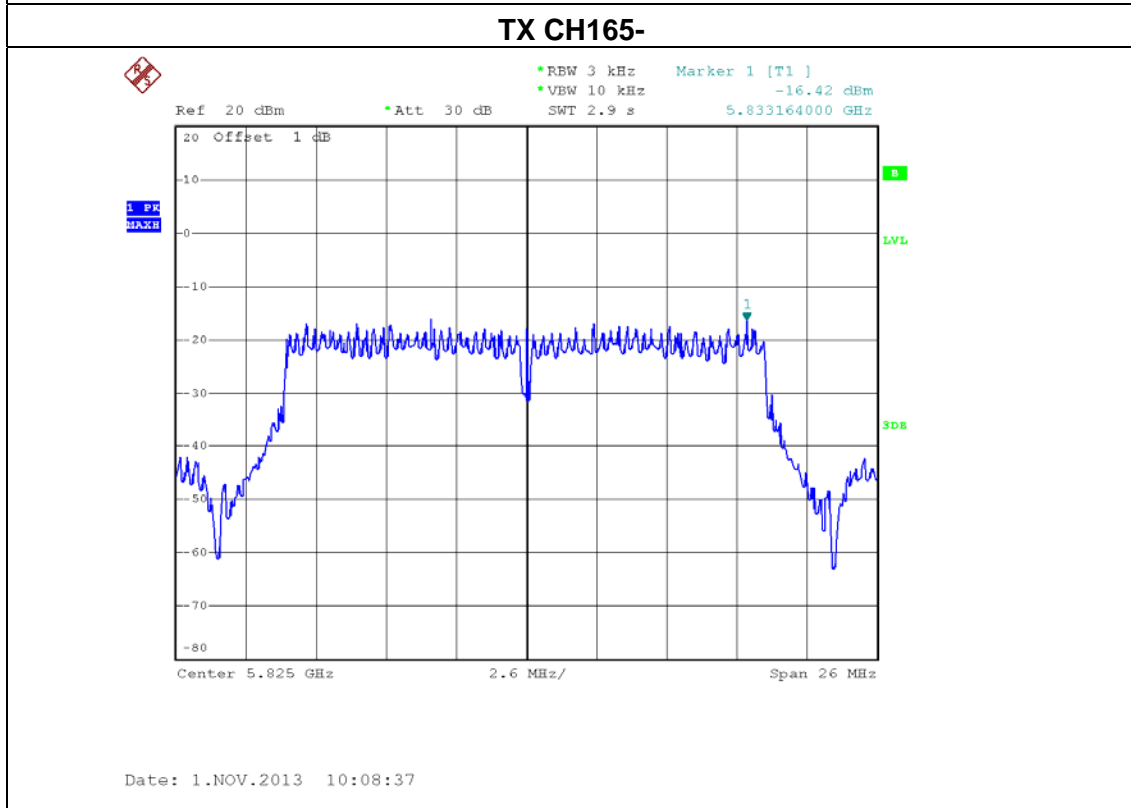
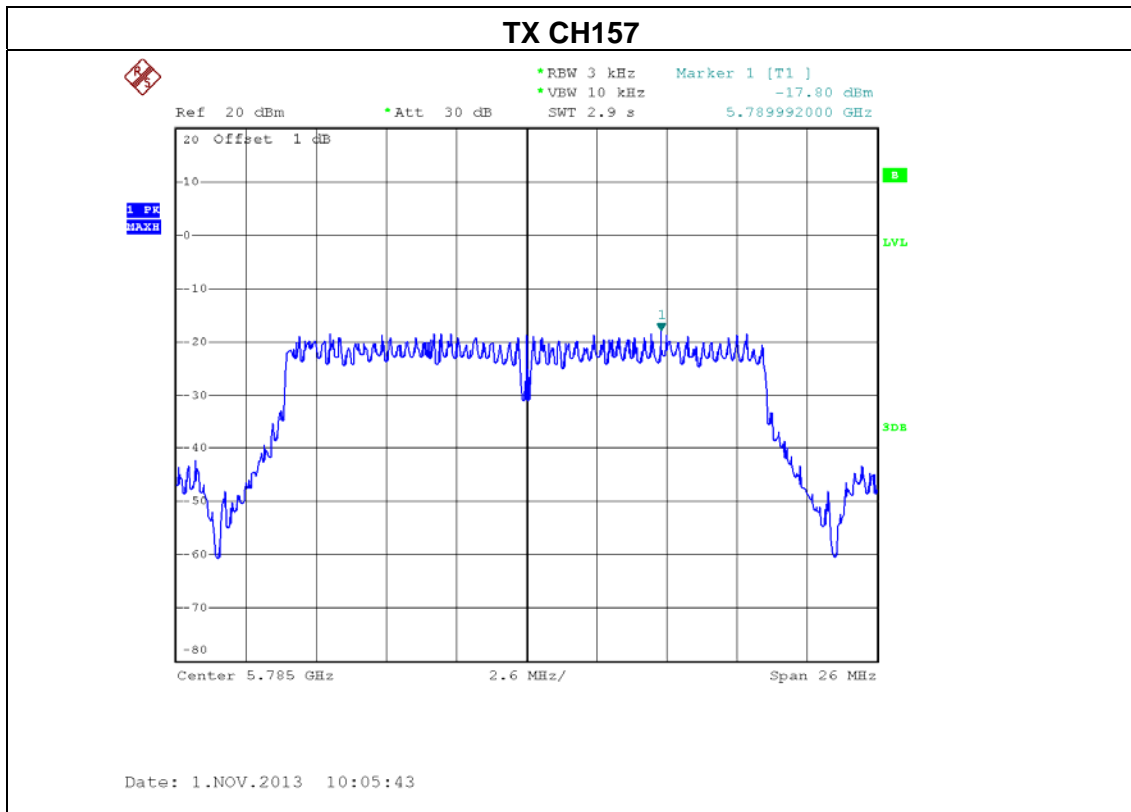



EUT:	High Power Dual Band Wireless 900N Low Profile Access Point	Model Name :	XAP-1500
Temperature:	23 °C	Relative Humidity:	51 %
Pressure:	1010 hPa	Test Voltage :	AC 120V/60Hz
Test Mode :	TX N20 Mode /CH149, CH157, CH165 / ANT 1		

Test Channel	Frequency (MHz)	Power Density (dBm)	LIMIT (dBm)
CH149	5745 MHz	-16.30	8
CH157	5785 MHz	-15.12	8
CH165	5825 MHz	-15.36	8

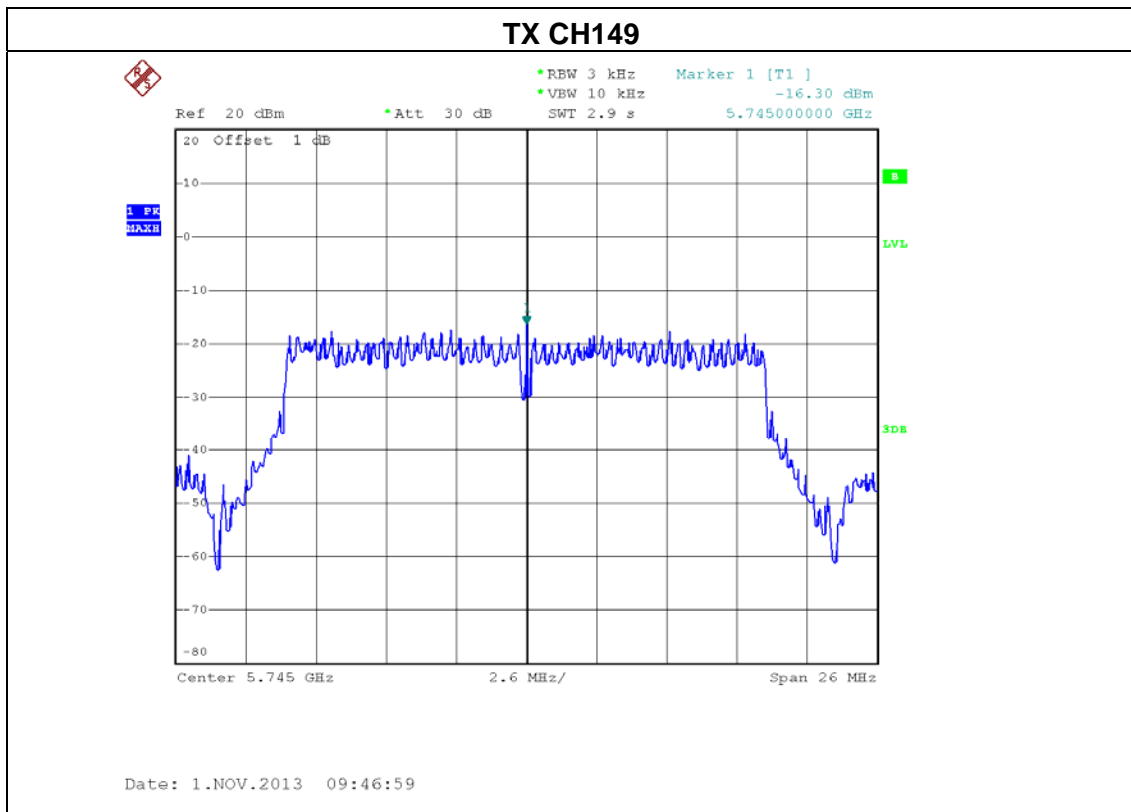

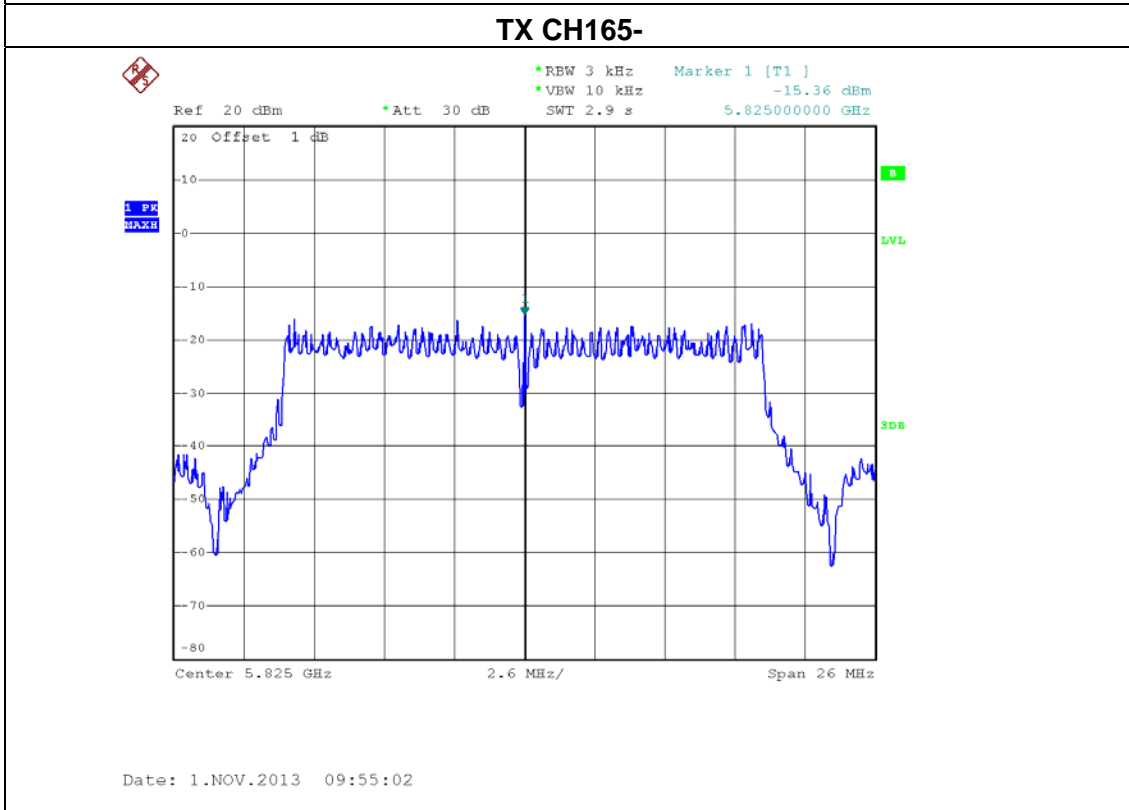
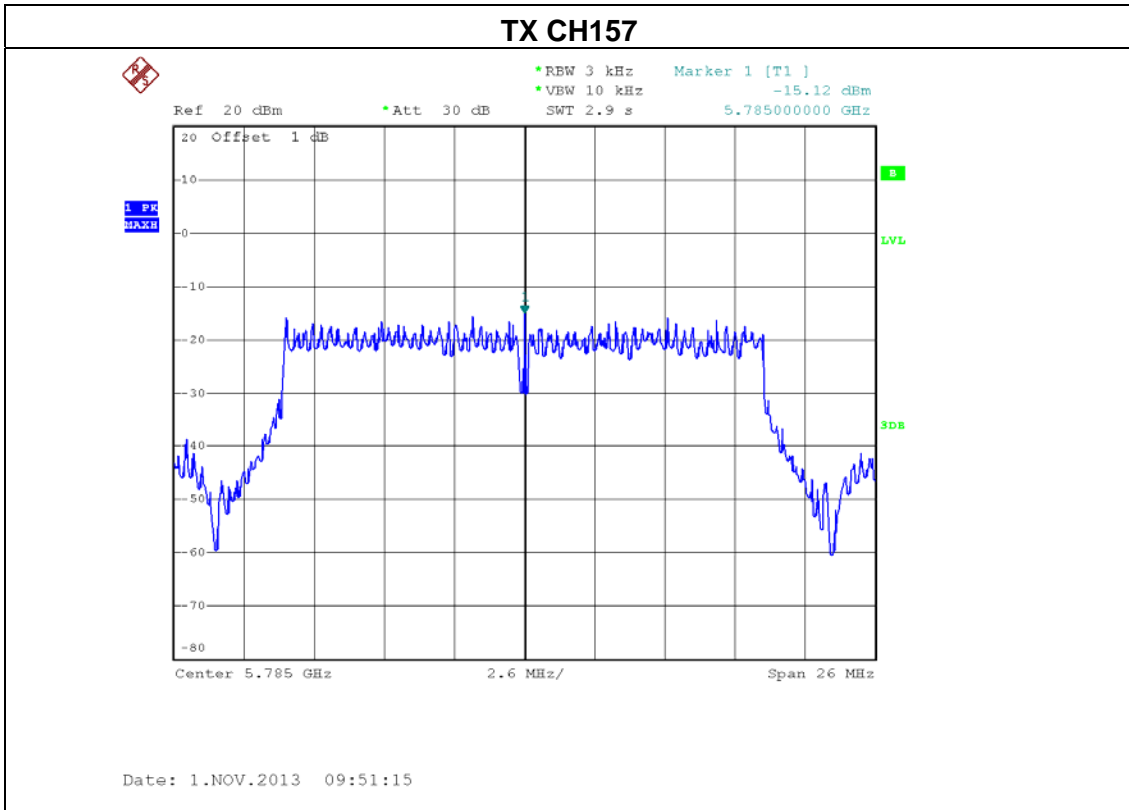



EUT:	High Power Dual Band Wireless 900N Low Profile Access Point	Model Name :	XAP-1500
Temperature:	23 °C	Relative Humidity:	51 %
Pressure:	1010 hPa	Test Voltage :	AC 120V/60Hz
Test Mode :	TX N20 Mode /CH149, CH157, CH165 / ANT 2		

Test Channel	Frequency (MHz)	Power Density (dBm)	LIMIT (dBm)
CH149	5745 MHz	-17.52	8
CH157	5785 MHz	-13.15	8
CH165	5825 MHz	-14.61	8

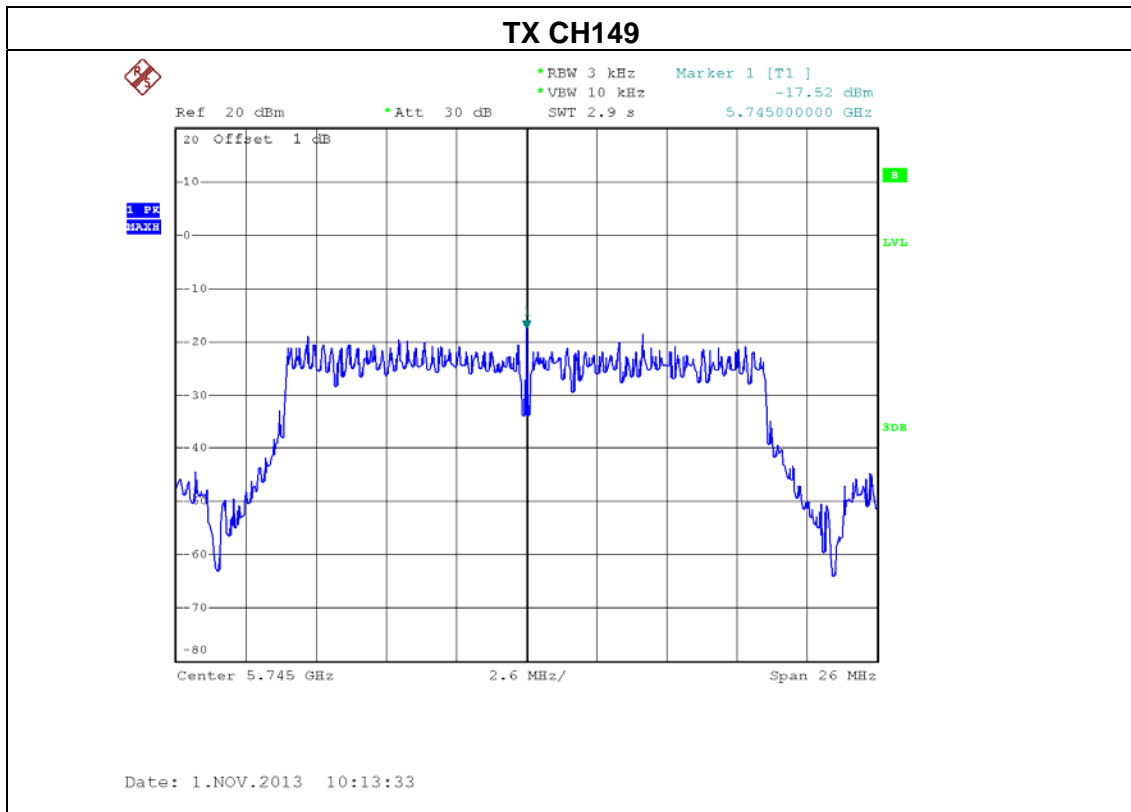

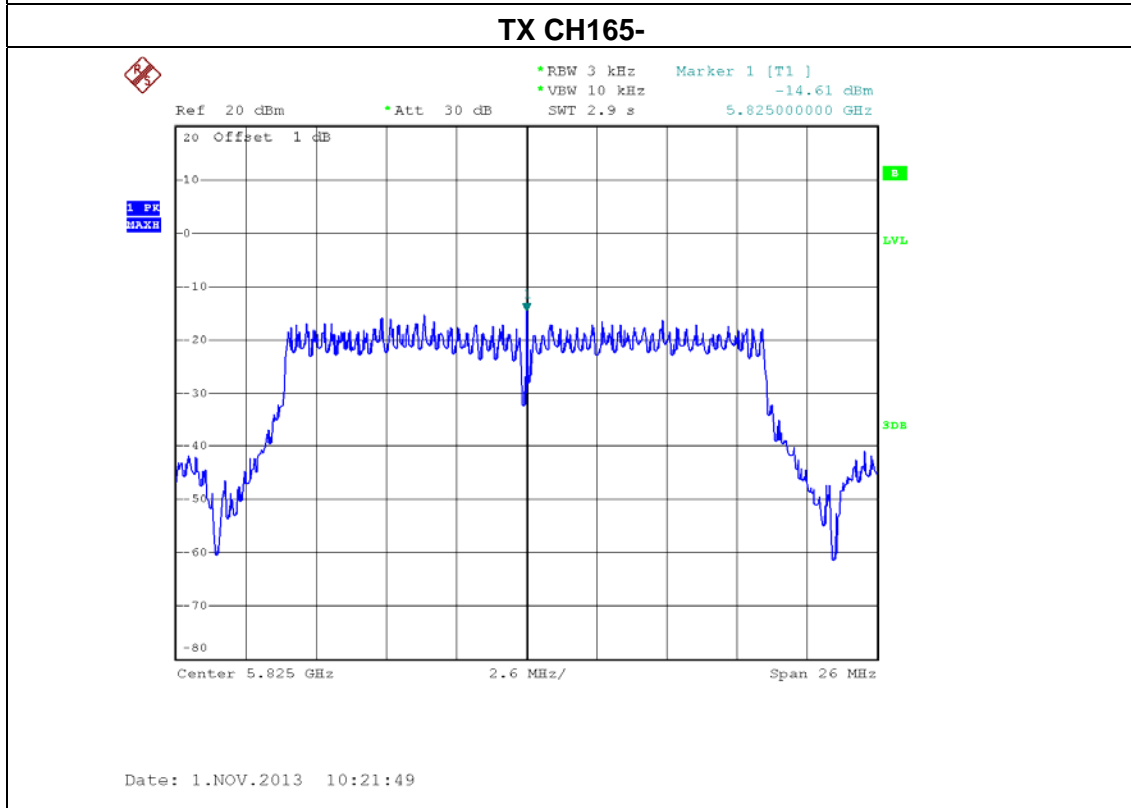
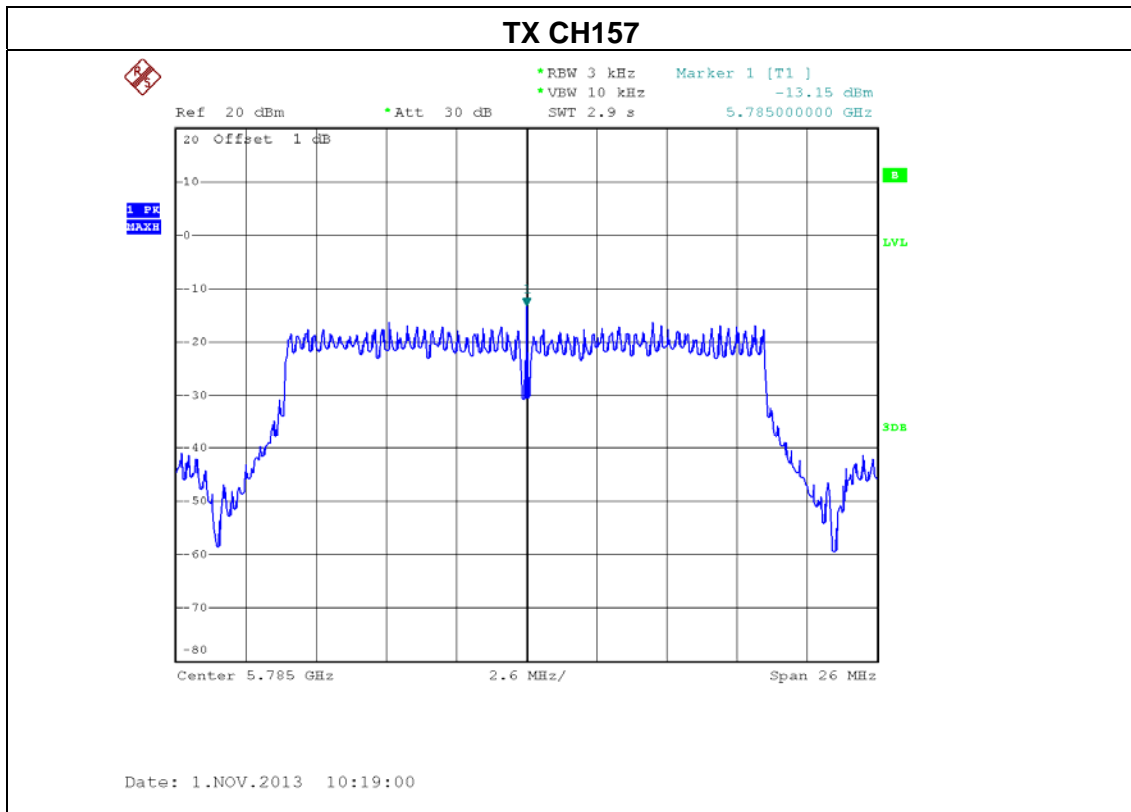



EUT:	High Power Dual Band Wireless 900N Low Profile Access Point	Model Name :	XAP-1500
Temperature:	23 °C	Relative Humidity:	51 %
Pressure:	1010 hPa	Test Voltage :	AC 120V/60Hz
Test Mode :	TX N20 Mode /CH149, CH157, CH165 / ANT 0 + ANT 1+ ANT 2		

Test Channel	Frequency (MHz)	Power Density (dBm)	LIMIT (dBm)
CH149	5745 MHz	-12.33	8
CH157	5785 MHz	-10.19	8
CH165	5825 MHz	-10.63	8

Note: The EUT incorporates a MIMO function. Physically, the EUT provides three completed transmitters and three receivers (3T3R), all transmit signals are completely uncorrelated, then, **Direction gain = G_{ANT}** , that is Directional gain=5dBi.



EUT:	High Power Dual Band Wireless 900N Low Profile Access Point	Model Name :	XAP-1500
Temperature:	23 °C	Relative Humidity:	51 %
Pressure:	1010 hPa	Test Voltage :	AC 120V/60Hz
Test Mode :	TX N40 Mode /CH151, CH159 / ANT 0		

Test Channel	Frequency (MHz)	Power Density (dBm)	LIMIT (dBm)
CH151	5755 MHz	-16.69	8
CH159	5795 MHz	-14.40	8

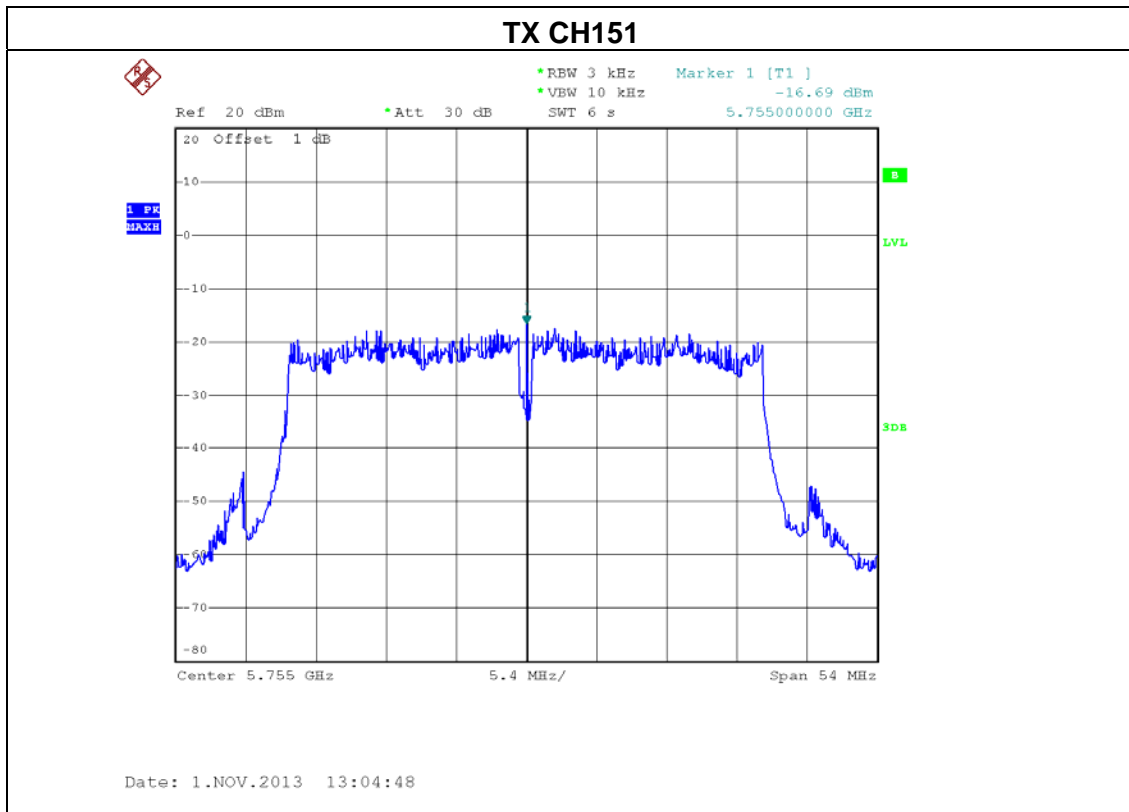

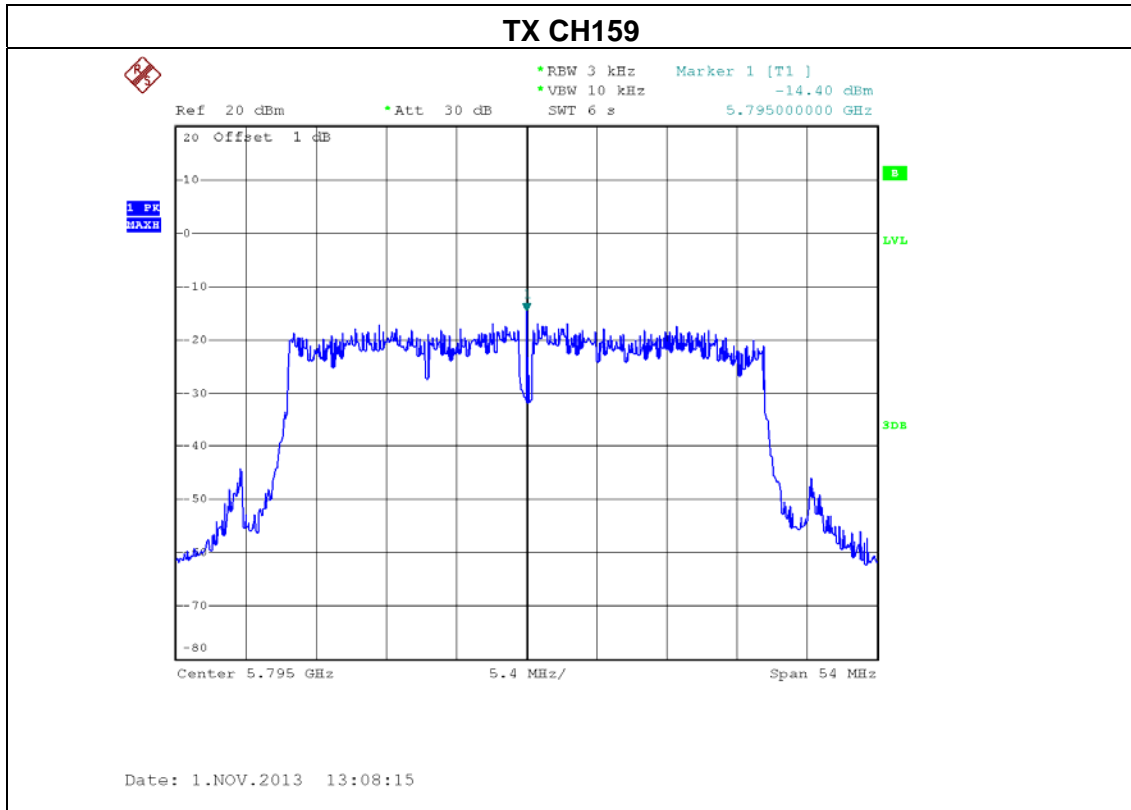



EUT:	High Power Dual Band Wireless 900N Low Profile Access Point	Model Name :	XAP-1500
Temperature:	23 °C	Relative Humidity:	51 %
Pressure:	1010 hPa	Test Voltage :	AC 120V/60Hz
Test Mode :	TX N40 Mode /CH151, CH159 / ANT 1		

Test Channel	Frequency (MHz)	Power Density (dBm)	LIMIT (dBm)
CH151	5755 MHz	-12.78	8
CH159	5795 MHz	-12.59	8

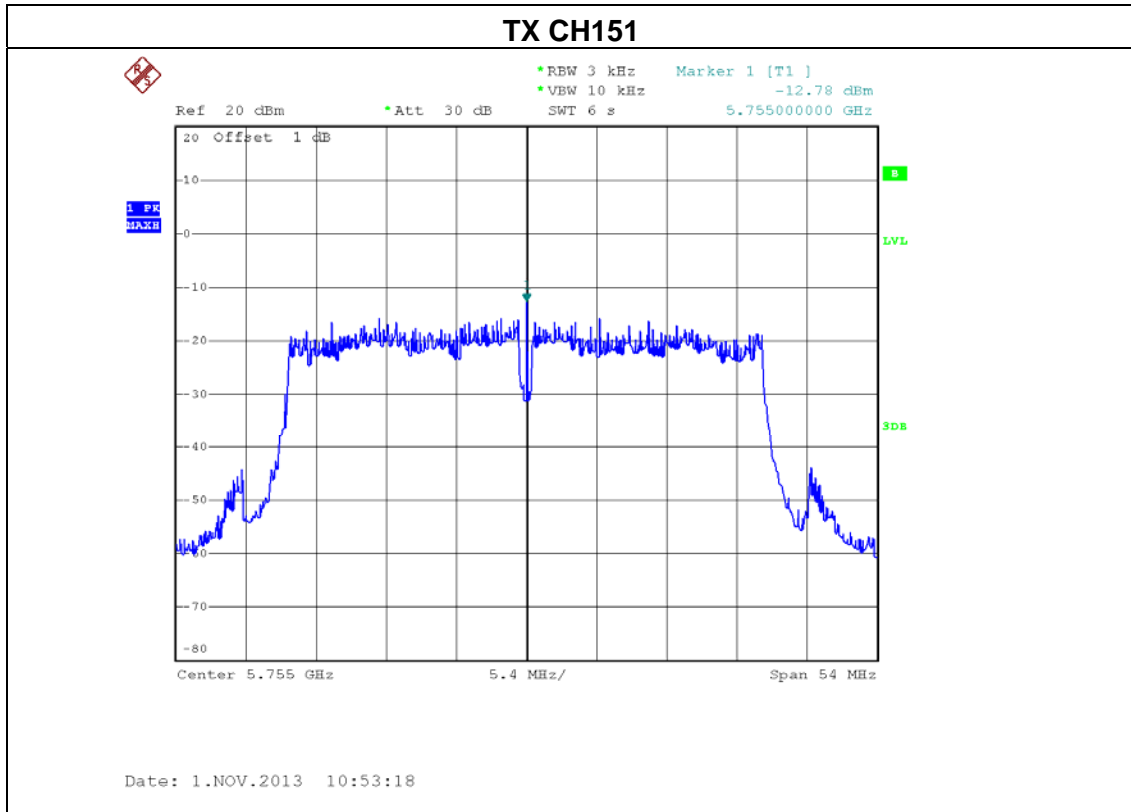

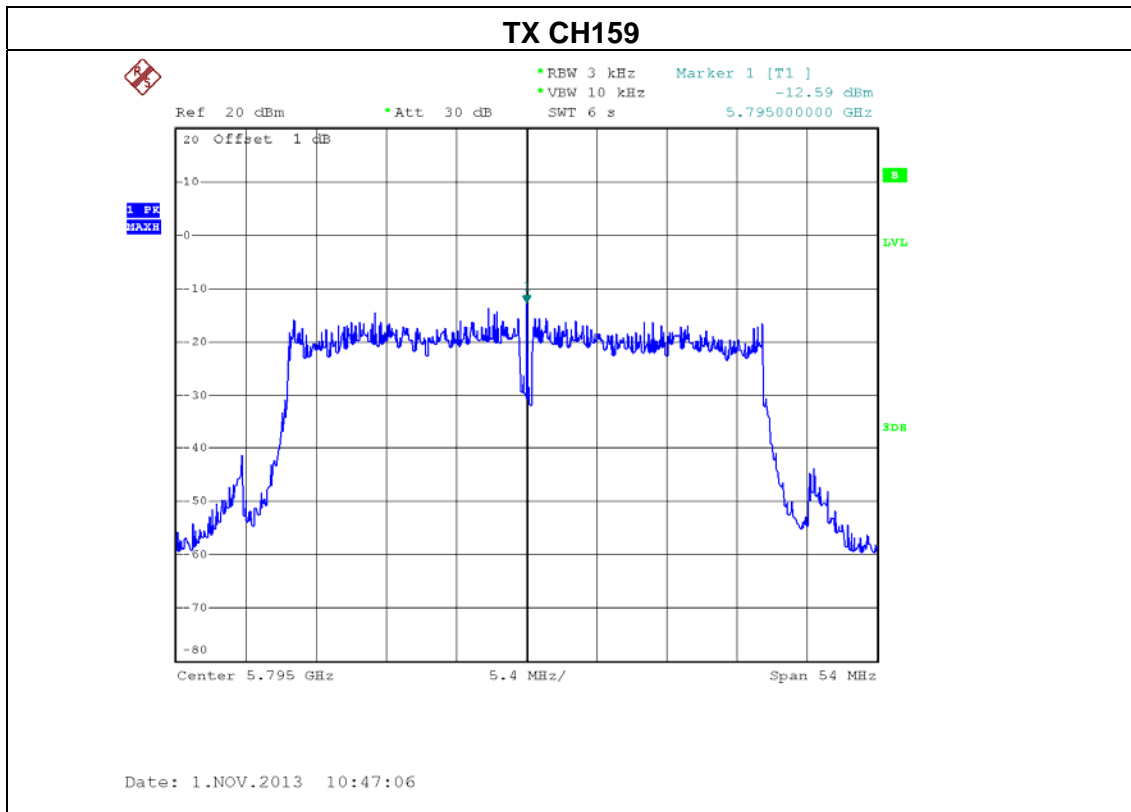



EUT:	High Power Dual Band Wireless 900N Low Profile Access Point	Model Name :	XAP-1500
Temperature:	23 °C	Relative Humidity:	51 %
Pressure:	1010 hPa	Test Voltage :	AC 120V/60Hz
Test Mode :	TX N40 Mode /CH151, CH159 / ANT 2		

Test Channel	Frequency (MHz)	Power Density (dBm)	LIMIT (dBm)
CH151	5755 MHz	-12.26	8
CH159	5795 MHz	-15.07	8

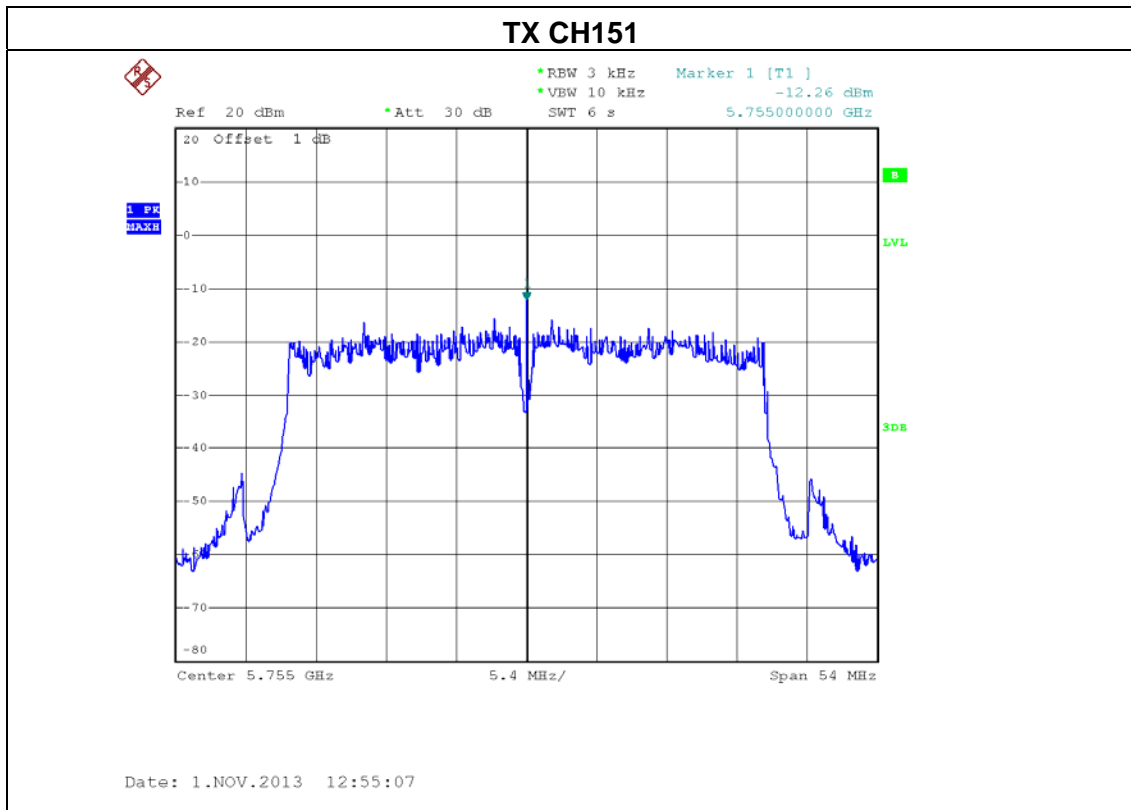

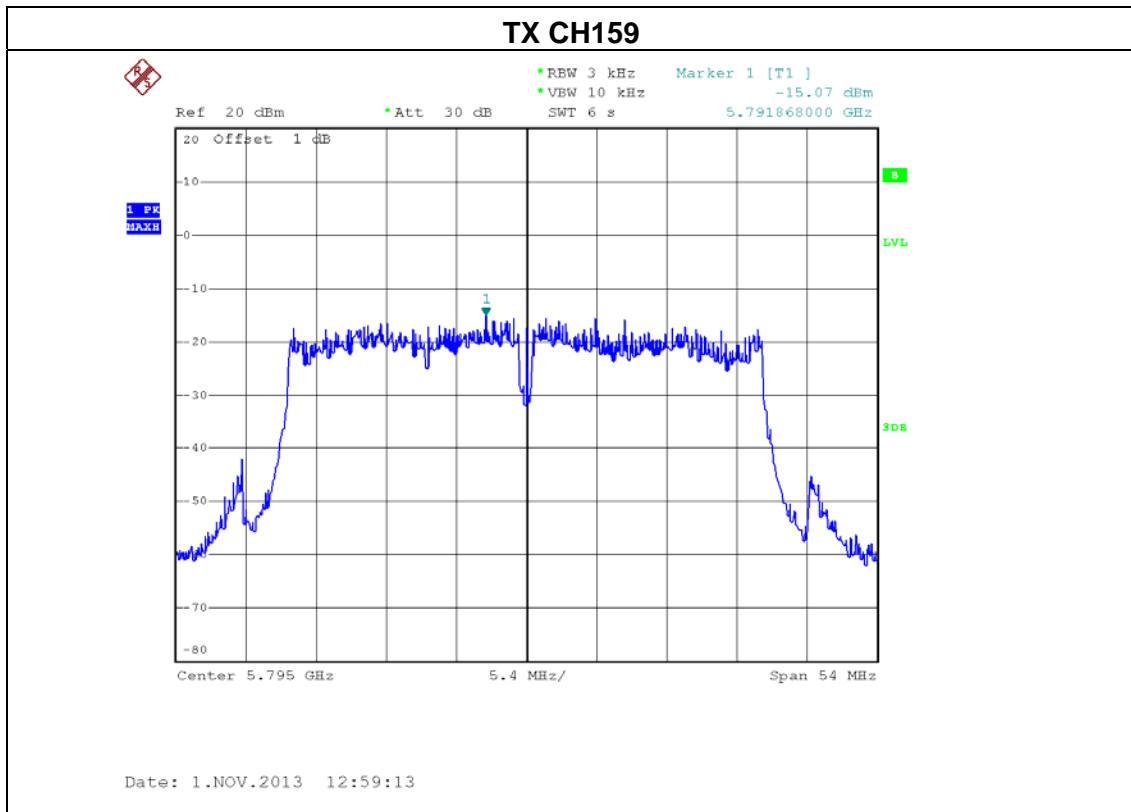



EUT:	High Power Dual Band Wireless 900N Low Profile Access Point	Model Name :	XAP-1500
Temperature:	23 °C	Relative Humidity:	51 %
Pressure:	1010 hPa	Test Voltage :	AC 120V/60Hz
Test Mode :	TX N40 Mode /CH151, CH159 / ANT 0+ANT 1+ANT 2		

Test Channel	Frequency (MHz)	Power Density (dBm)	LIMIT (dBm)
CH151	5755 MHz	-8.74	8
CH159	5795 MHz	-9.27	8

Note: The EUT incorporates a MIMO function. Physically, the EUT provides three completed transmitters and three receivers (3T3R), all transmit signals are completely uncorrelated, then, **Direction gain = G_{ANT}** , that is Directional gain=5dBi..



9. EUT TEST PHOTO

Conducted Measurement Photos



**Radiated Measurement Photos
30M~1000MHz**

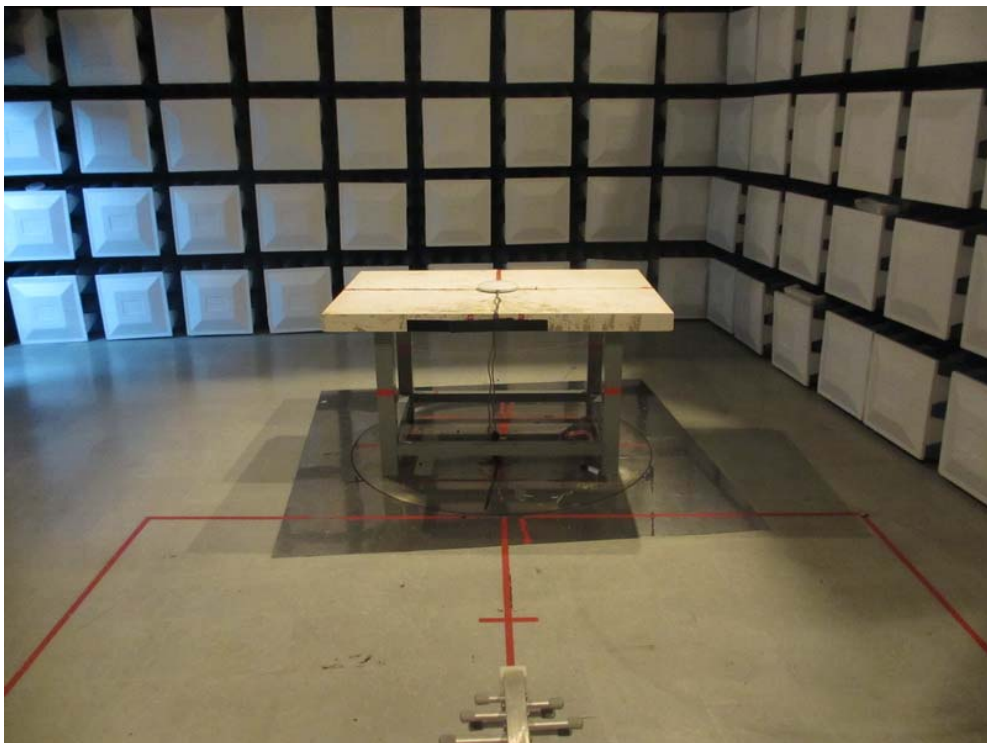
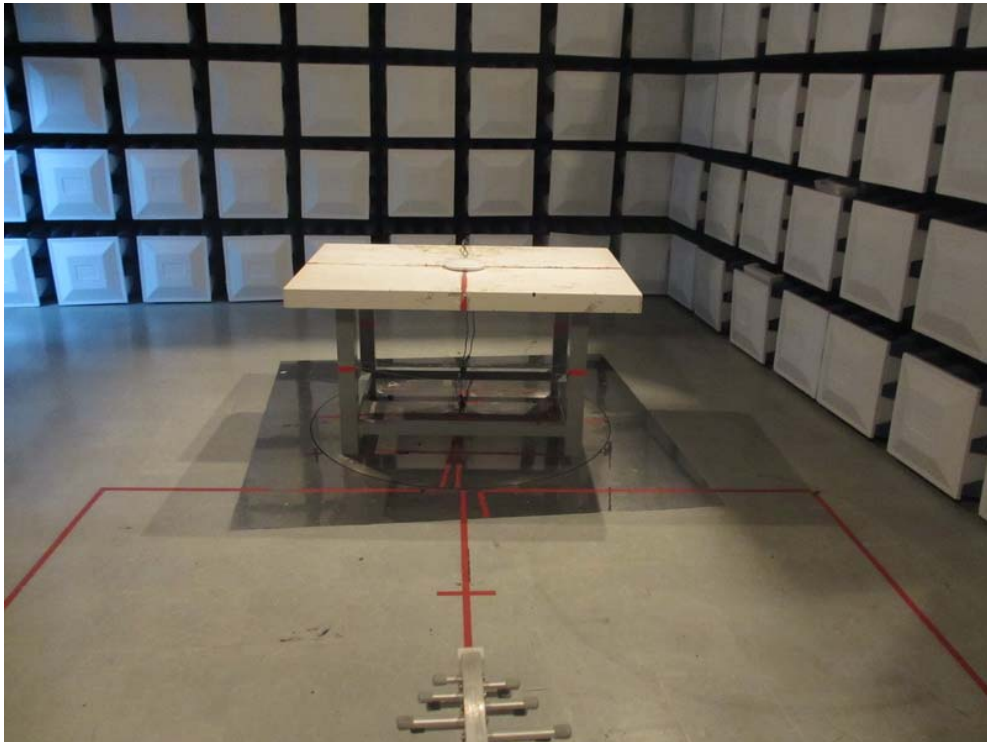



**Radiated Measurement Photos
Above 1000MHz**

