



Digital Photo Printer

# **P910L**

---

Operation Manual

HiTi Digital, Inc.

## Handling of this Manual

1. All rights reserved. No part of this operation manual covered by the copyright herein maybe reproduced or copied in any form or by any means, including translation, without the written permission of HiTi Digital, Inc.
2. The specifications in this operation manual are subject to change without prior notice.
3. In case of having any difficulties or finding the fault in this manual, your information to HiTi Digital will be highly appreciated.

## Introduction

This manual describes detailed instructions for handling of and basic operation of Digital Photo Printer P910L.

We will describe this product as “the printer” in the manual.

Read this manual thoroughly to understand how to install and operate the printer before using it.

### Notice

- Keep this manual near the printer and operators can refer to this manual periodically.
- In case, lost or damaged this manual, contact your dealers.
- In the case of transfer, do not forget to put this manual together with the printer.

# CONTENTS

## PREFACE

<b>Chapter 1. Important Safety Instruction</b> . . . . .	1-1
Environments . . . . .	1-1
Handling Instruction . . . . .	1-2
Handling Instruction for Consumable and Printed Output . . . . .	1-3
<b>Chapter 2. Installing and Set Up</b> . . . . .	2-1
Unpacking and Checking the Accessories . . . . .	2-1
Parts Name and Function . . . . .	2-2
Printer Status Lamps Name and Printer Status . . . . .	2-3
Fixing Anti-tip Plate . . . . .	2-3
Connecting Power Cable . . . . .	2-4
Connecting USB Cable . . . . .	2-4
Connecting Personal Computer . . . . .	2-4
Setting Ink Ribbon . . . . .	2-5
Loading Paper . . . . .	2-6
Installing Dust Box . . . . .	2-7
Transporting the Printer . . . . .	2-7
<b>Chapter 3. Routine Maintenance</b> . . . . .	3-1
Cleaning of Thermal Head, Platen . . . . .	3-1
Cleaning of Outer Cover . . . . .	3-2
Cleaning of Filter . . . . .	3-2
<b>Chapter 4. Error Handling</b> . . . . .	4-1
Printer Status Lamps are displayed in red . . . . .	4-1
Failure Symptoms . . . . .	4-1
Paper Jam . . . . .	4-2
Power Supply Interrupted during Printing . . . . .	4-2
When the Ribbon is snapped . . . . .	4-2
<b>Chapter 5. In order to more comfortably use</b> . . . . .	5-1
Paper Pre-Cut function can be turned off through the printer driver . . . . .	5-1
For longer Printer usage . . . . .	5-1
For the customers in the U.S.A. . . . .	5-2
For the customers in Canada . . . . .	5-2
For the customers in Europe . . . . .	5-2
<b>Specification</b> . . . . .	6-1
<b>After-sales Service</b> . . . . .	6-1



# Chapter 1. Important Safety Instruction

This manual provides detailed instructions for the safety use of the printer. Read this manual before operating the printer to ensure to have proper use.

- ◆ In this manual, there are notes that require special attention.
- ◆ For your safety operation, Safety notices are separated as follows;



Warning: Inappropriate handling can cause the death or serious wound.



Caution: Inappropriate handling can cause the wound for the users and/or cause the physical damage.

Attention: Explanation about the cause of the trouble and the environmental condition.

- ◆ It is difficult to forecast all the danger in setting and use of the printer. Therefore, warnings in this Operation Manual, in the other documents on the printer cannot cover all the cases. In case of performing the operation or maintenance which are not described in this manual, all the concern for the safety have to be taken care of at the customer side.
- ◆ Operations and the notification for the maintenance described in this manual and other documents are for the proper use of the printer. In case of using the printer for the other purpose, all the concern for the safety has to be taken care of at the customer side.
- ◆ Do not perform the operation which are prohibited in this manual and other documents.
- ◆ The contents that cannot be printed due to a failure while using the use of this printer are not guaranteed.

## Environments

To use the printer safety, please pay attention to the followings:



Caution: Do not let children to touch the printer or the cables. It can cause accidents or electric shock.



Caution: Do not place the printer under humid or dusty place. It can cause a fire, electric shock or printer problem. Do not place the printer with dust, sand and high humidity such as bathing place, bathroom, hot spring, on the street.



Caution: Do not place the printer on rickety place and/or inclined place. Printer may fall down or tumble and it can cause injury.



Warning: Do not insert or fall the metallic items or flammable items into the printer through the openings of the printer, it can cause the fire and electric shock.



Warning: Do not put vase, flowerpot, and cup with water inside or metric items. In case the water spilt or metric items fall into the printer, it can cause the fire and electric shock.



Warning: Do not block the openings of the printer. In case, the opening blocked, the heat will remain inside and it can cause the fire.

Attention: Do not place the printer under the low temperature such as ski resort, skating rink or open-air with direct sunlight.

# Chapter 1. Important Safety Instruction

## Handling Instruction

In handling the printer, please pay attention to the followings:



Warning: Lift the printer from its box and put it onto a flat table or desk.



Warning: At nearly 13.5Kg, the printer is too heavy to be lifted by one person.  
Also please take a good care of your hands and fingers when lifting the printer from the box.



Warning: Be careful when you transport the printer on the slippery floor.



Warning: In case you drop the printer, firstly turn off the power of the printer and remove the power cable, then contact the dealers or service center. To use the printer without any checking, can cause the fire or electric shock.



Warning: Secure the power cable firmly.



Warning: This product must be grounded, and always used with only the specified power cable or the power cable accompanying this product.  
If the product is used without ground, and current leakage occurs, fire or electrical shock is most likely to result, and also cause signal-receiving interference to a radio, a television receiver, and other similar electric appliances.  
If the proper grounding connection is not possible, please contact to the dealers or service center.



Warning: Do not attempt to service the printer beyond the instruction specified in this document. In case, impossible to recover from the problem, please contact to the dealers or service center.



Warning: The thermal head reaches high temperature during operation but this is normal. Do not touch the thermal head.



Warning: Do not dismantle or remodel the printer.  
Some sections of the printer contain a high voltage or become very hot. Ignoring this warning may cause electric shock, fire, or burns.

Attention: Touching the surface of the thermal directly can cause the damage to thermal head. When a hard object get into the printer, it can cause the damage to the printer mechanism. In such case, please do not use the printer.

Attention: At installation, appropriate interface cable will be required with your computer.

# Chapter 1. Important Safety Instruction

---

## Handling Instruction for Consumable and Printed Output

In handling the ink ribbon, paper and printed output, please pay attention to the followings:

### Attention: Paper Handling

- Use the paper specified by HiTi Digital.
- Store the paper flat.
- Store the paper in a dry and dark place to avoid the direct Sunlight.  
(Temperature less than 30°C, Humidity less than 60%).
- Do not touch the paper surface before printing to avoid the fingerprints.

### Attention: Ink Ribbon Handling

- Use the ink ribbon specified by HiTi Digital.
- Store the ink ribbon in cool place to avoid the direct sunlight.  
(Temperature less than 30°C, Humidity less than 60%)

### Attention: Printed Output Handling

- Store the printed output in a dark place to avoid the direct sunlight.
- Store the printed output away from the organic fluid such as benzene, thinner and alcohol which may change or deteriorate the colors.



Caution: When abandon the ink ribbon, please handle it as harmful industrial waste.



Caution: Be careful not to injure your hands with the paper edge when handling paper.



Caution: If you do not use the printer for a long time, please remove the paper and the ink ribbon from the printer.





## Chapter 2. Installing and Set Up

This chapter explains the unpacking and set up of the printer.

Before proceeding to this chapter, please make sure to read Chapter 1. Important Safety Instruction.

### Unpacking and Checking the Accessories

1. Open the box and remove the box containing the accessories and protection materials.

Attention: Keep the packaging materials. The box and protection materials are necessary when moving or transporting the printer. Make sure that they are retained.

2. Take out the printer by holding bottom of the printer.

Caution: This printer weighs about 13.5Kg. Please handle it carefully.  
When lifting the printer, always hold bottom of printer. Otherwise, the printer may be damaged.

3. Take out the accessories from the accessory box and check the contents.

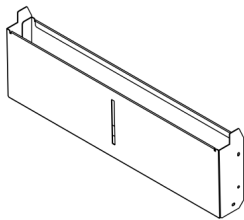

Dust Box

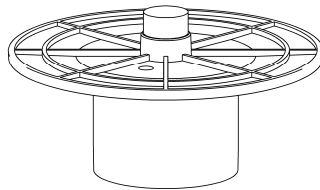

Paper Flange (White)

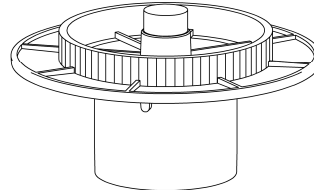

Paper Flange (Blue)

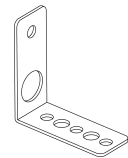

Anti-tip Plate

# Chapter 2. Installing and Set Up

## Parts Name and Function

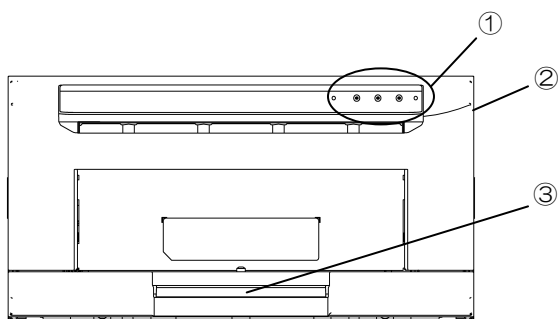

(Front View)

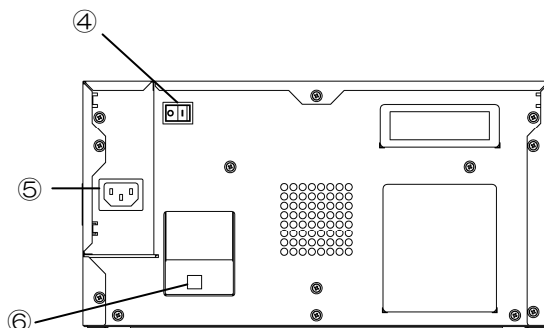

(Rear View)

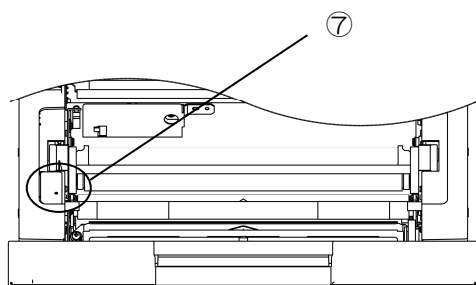

(Front Internal View)

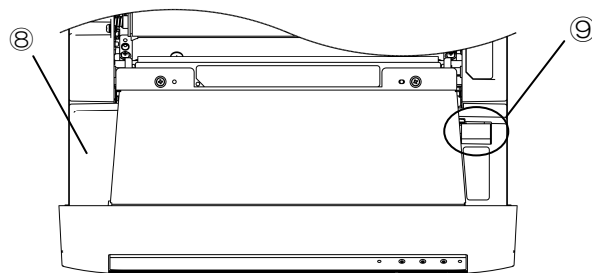

(Upper Internal View)

No.	Name	Function
①	Printer Status Lamps	Printer status display lamps are located on the panel.
②	Drawer Unit	Open the drawer unit when replacing an ink ribbon or paper, or when performing maintenance.
③	Drawer Lever	When open the drawer unit, hold this lever.
④	Power Switch	This switch turns on/off the power of the printer. When the “ ” marked side of the switch is pressed, the power is turned on. When the “o” marked side of the switch is pressed, the power is turned off. <Caution> Once the printer is turned off, wait at least 3 seconds before turning it on again.
⑤	Power Connector	To be used to connect the power cable.
⑥	USB Connector	To be used to connect the USB cable.
⑦	Paper Setting Lamp	When setting the paper, insert the paper until the lamp is lit. When the lamp blinks, remove the paper until the lamp goes off.
⑧	Open Guide Unit	Open the drawer unit when replacing paper, or when performing maintenance.
⑨	Open Guide Lever	When open the open guide unit, hold this lever.

## Chapter 2. Installing and Set Up

### Printer Status Lamps Name and Printer Status

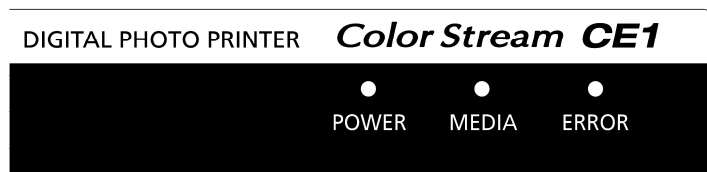

Printer status lamp display ●:on, ○:off, \*:flashing

LED Display			Description
POWER	MEDIA	ERROR	
○	○	○	The power of printer is off.
*	○	○	The printer is initializing after turn on the power Thermal head is cooled/heated on printing.
●	○	○	The printer is ready If you leave the printer of ready state for 5 minutes, the printer goes into standby mode automatically.
●	○	*	The drawer unit is opened.
●	○	●	Paper jam occurred. The printer mechanical section is faulty. Trouble of printer control board.
●	*	●	The ink ribbon loaded is not supported.
●	●	●	The paper is not set. Out of the paper. The ink ribbon is not loaded. The ink ribbon is empty.
●	*	○	The printer is loading the paper or the ink ribbon.

### Fixing Anti-tip Plate

1. Use a Phillips screwdriver to fix the anti-tip place to the back of the printer.

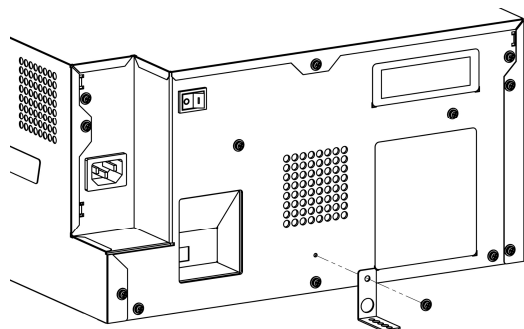

2. Install the printer with the anti-tip place and fix it onto the wooden.

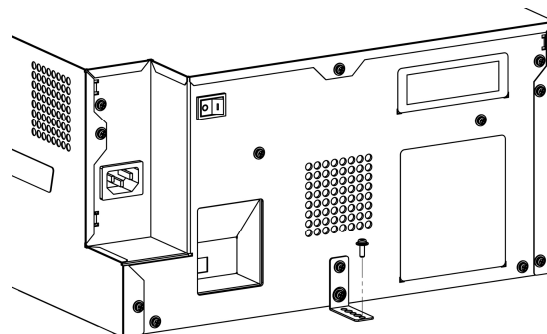

## Chapter 2. Installing and Set Up

### Connecting Power Cable

Insert the power cable attached to the printer into the power connector located on the rear of the printer.

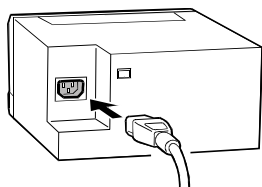

Warning: Make sure to turn off the power of the printer before inserting the power cable.



Warning: Make sure to insert the power cable correctly. If not, it can cause the fire or the printer problem.



Warning: Do not insert or remove the power cable with wet hands. It can cause the electric leakage.



Warning: Do not make any damage or any modification to the power cable. Put the heavy items on the power cable, give a strong pull to the power cable and twist the power cable can cause the fire and electric shock.



Warning: When moving the printer, make sure to turn off the power of the printer, remove the power cable in order to have no connection with other devices. Otherwise, the power cable might be damaged and it can cause the fire and electric shock. Also there is a possibility to fall down caught by the cable.



Warning: In case of not using the printer for a long time, remove the power cable for safety.



Warning: Avoid “piled up” connection. It can cause the fire and electric shock.

### Connecting USB Cable

Connect the USB cable from the personal computer to the USB connector located on the left rear side of the printer.

Be sure to insert the USB cable all the way.

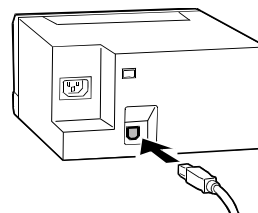

Attention: To remove the USB cable, make sure that the printer is in the waiting status. Removing the USB cable during data transfer may not be able to print data correctly.

# Chapter 2. Installing and Set Up

## Setting Ink Ribbon

1. Remove dust box.

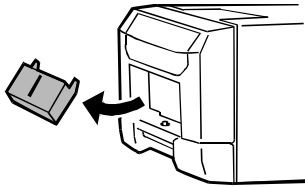

2. Carefully lift the drawer lever and pull the drawer unit.

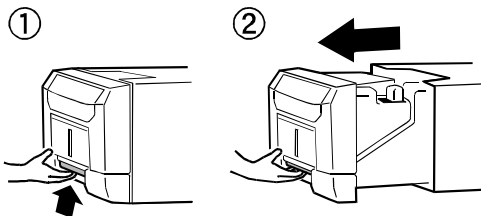

Attention: Do not open the drawer unit quickly or with unnecessary force. Do not press the drawer unit or place a heavy object other than paper after opening the drawer unit.

4. Take the slack the ink ribbon by turning the ink ribbon supply core.

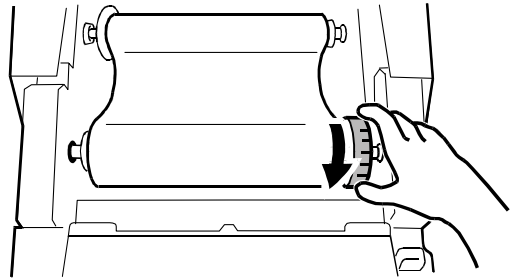

3. Set the ink ribbon to drawer unit as shown

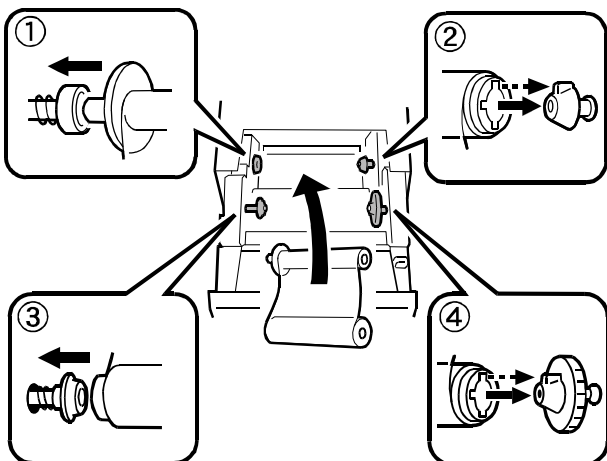

## Chapter 2. Installing and Set Up

### Loading Paper

Turn on the power of the printer by pressing " | " on the power switch.

1. In the drawer unit pull out, pull the lever to open the open guide unit. Pull out the drawer unit and pull the lever to open the open guide unit.

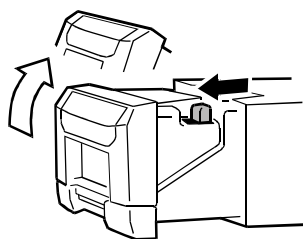

**Attention:** Do not open the drawer unit quickly or with unnecessary force. Do not press the drawer unit or place a heavy object other than paper after opening the drawer unit.

2. Install the paper flange (white) and paper flange (blue).

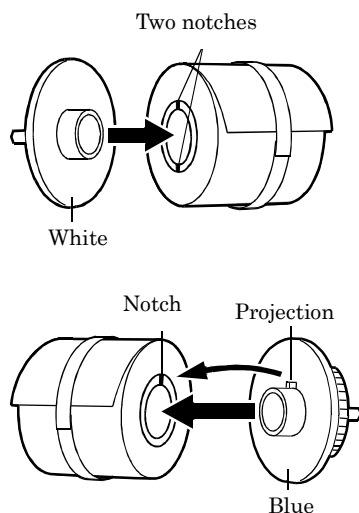

**Caution:** The paper is not set correctly if there is a gap of about 5mm ~ 10mm between the paper flange and paper. Match the notch of the paper flange and the notch of the paper core by rotating the paper flange.

3. Set the paper in the printer.

Set the paper by matching the color of the paper flange and the color of the holder. After setting the paper, remove the seal from the paper.

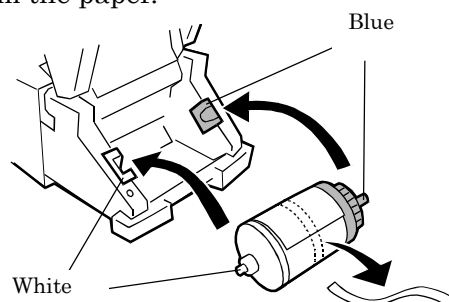

4. Insert the edge of paper under the guide roller by rotating the paper flanges. Insert the paper until the Paper Setting Lamp is lit.

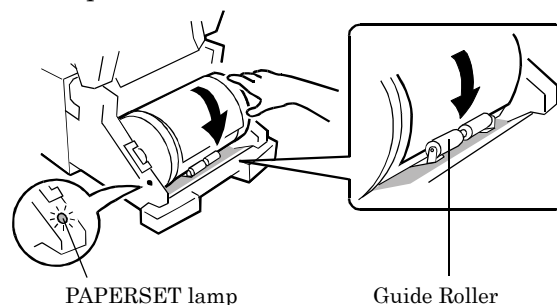

5. Close the open guide unit.

When close the open guide unit, press on the center of the open guide unit.

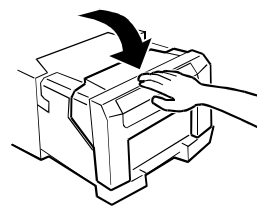

6. Close the drawer unit.

When the drawer unit is closed, initialization starts and four sheets of paper are ejected automatically.



**Caution:** Close the front cover carefully so as not to catch your fingers. Close the drawer unit and later to close the open guide unit. Do not close the drawer unit and the open guide unit quickly.

## Chapter 2. Installing and Set Up

---

### Installing Dust Box

Insert the claw of the dust box first and insert the projected section of the printer in the hole at the bottom of the dust box.

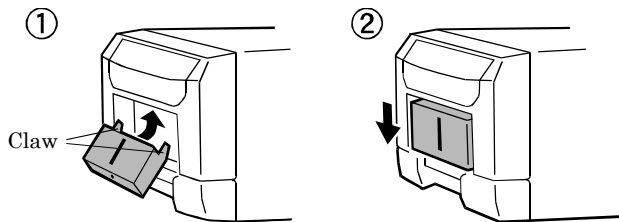

### Transporting the Printer

The following cautions are necessary in transportation of the printer. Since an incorrect transportation method causes a printer fault, follow the correct method.

1. Remove the ink ribbon and paper from the printer before transporting the printer.  
If the ink ribbon or paper cannot be removed due to a fault, consult with the distributor.
2. Use a genuine box.  
If the box used at the purchase cannot be used, consult with your distributor and purchase a new box.

