

TEST REPORT

Test report no.: 1-1120/16-01-03-F

BNetzA-CAB-02/21-102

Testing laboratory

CTC advanced GmbH

Untertuerkheimer Strasse 6 – 10
66117 Saarbruecken / Germany

Phone: + 49 681 5 98 - 0

Fax: + 49 681 5 98 - 9075

Internet: <http://www.ctcadvanced.com>

e-mail: mail@ctcadvanced.com

Accredited Testing Laboratory:

The testing laboratory (area of testing) is accredited according to DIN EN ISO/IEC 17025 (2005) by the Deutsche Akkreditierungsstelle GmbH (DAkkS)

The accreditation is valid for the scope of testing procedures as stated in the accreditation certificate with the registration number: D-PL-12076-01-03

Applicant

Profoto AB

Landsvägen 57
172 65 Sundbyberg / SWEDEN

Phone: +46 (0) 84 47 53 00

Fax: -/-

Contact: Fredric Luthman

e-mail: fredric@hagelund.se

Phone: +46 (0) 70 41 98 90 0

Manufacturer

Profoto AB

Landsvägen 57
172 65 Sundbyberg / SWEDEN

Test standard/s

47 CFR Part 15	Title 47 of the Code of Federal Regulations; Chapter I; Part 15 - Radio frequency devices
RSS - 247 Issue 2	Digital Transmission Systems (DTSs), Frequency Hopping Systems (FHSs) and Licence - Exempt Local Area Network (LE-LAN) Devices
RSS - Gen Issue 5	General Requirements for Compliance of Radio Apparatus

For further applied test standards please refer to section 3 of this test report.

Test Item

Kind of test item:	Proprietary module
Model name:	RMI6
FCC ID:	W4G-RMI6
IC:	8167A-RMI6
Frequency:	DTS band 2400 MHz to 2483.5 MHz
Technology tested:	Proprietary
Antenna:	Integrated antenna
Power supply:	3.0 V DC by two AA-batteries
Temperature range:	-10°C to +55°C



This test report is electronically signed and valid without handwriting signature. For verification of the electronic signatures, the public keys can be requested at the testing laboratory.

Test report authorized:

Marco Bertolino
Lab Manager
Radio Communications & EMC

Test performed:

Mihail Dorongovskij
Lab Manager
Radio Communications & EMC

1 Table of contents

1	Table of contents	2
2	General information	3
2.1	Notes and disclaimer	3
2.2	Application details	3
2.3	Test laboratories sub-contracted	3
3	Test standard/s and references	4
4	Test environment	5
5	Test item	5
5.1	General description	5
5.2	Additional information	5
6	Description of the test setup	6
6.1	Shielded semi anechoic chamber	7
6.2	Shielded fully anechoic chamber	8
6.3	Radiated measurements > 18 GHz	9
6.4	Conducted measurements C.BER system	10
6.5	AC conducted	11
6.6	Conducted measurements C.BER system (only chapter 11.4)	12
7	Sequence of testing	13
7.1	Sequence of testing radiated spurious 9 kHz to 30 MHz	13
7.2	Sequence of testing radiated spurious 30 MHz to 1 GHz	14
7.3	Sequence of testing radiated spurious 1 GHz to 18 GHz	15
7.4	Sequence of testing radiated spurious above 18 GHz	16
8	Measurement uncertainty	17
9	Summary of measurement results	18
10	Additional comments	19
11	Measurement results	20
11.1	Antenna gain	20
11.2	Carrier frequency separation	21
11.3	Number of hopping channels	23
11.4	Time of occupancy (dwell time)	25
11.5	Spectrum bandwidth of a FHSS system	29
11.6	Maximum output power	33
11.7	Detailed spurious emissions @ the band edge – conducted	36
11.8	Band edge compliance radiated	39
11.9	Spurious emissions conducted	42
11.10	Spurious emissions radiated below 30 MHz	46
11.11	Spurious emissions radiated 30 MHz to 1 GHz	49
11.12	Spurious emissions radiated above 1 GHz	54
11.13	Spurious emissions conducted below 30 MHz (AC conducted)	60
12	Observations	63
Annex A	Document history	64
Annex B	Glossary	65
Annex C	Accreditation Certificate	66

2 General information

2.1 Notes and disclaimer

The test results of this test report relate exclusively to the test item specified in this test report. CTC advanced GmbH does not assume responsibility for any conclusions and generalizations drawn from the test results with regard to other specimens or samples of the type of the equipment represented by the test item.

The test report may only be reproduced or published in full. Reproduction or publication of extracts from the report requires the prior written approval of CTC advanced GmbH.

The testing service provided by CTC advanced GmbH has been rendered under the current "General Terms and Conditions for CTC advanced GmbH".

CTC advanced GmbH will not be liable for any loss or damage resulting from false, inaccurate, inappropriate or incomplete product information provided by the customer.

Under no circumstances does the CTC advanced GmbH test report include any endorsement or warranty regarding the functionality, quality or performance of any other product or service provided.

Under no circumstances does the CTC advanced GmbH test report include or imply any product or service warranties from CTC advanced GmbH, including, without limitation, any implied warranties of merchantability, fitness for purpose, or non-infringement, all of which are expressly disclaimed by CTC advanced GmbH.

All rights and remedies regarding vendor's products and services for which CTC advanced GmbH has prepared this test report shall be provided by the party offering such products or services and not by CTC advanced GmbH. In no case this test report can be considered as a Letter of Approval.

This test report is electronically signed and valid without handwritten signature. For verification of the electronic signatures, the public keys can be requested at the testing laboratory.

This test report replaces the test report with the number 1-1120/16-01-03-E and dated 2018-06-22

2.2 Application details

Chapter 11.4 time of occupancy test:

Date of receipt of order:	2016-07-06
Date of receipt of test item:	2017-03-22
Start of test:	2018-07-03
End of test:	2018-07-03
Person(s) present during the test:	-/-

All remaining tests:

Date of receipt of order:	2016-07-06
Date of receipt of test item:	2017-03-22
Start of test:	2017-06-12
End of test:	2017-08-08
Person(s) present during the test:	-/-

2.3 Test laboratories sub-contracted

None

3 Test standard/s and references

Test standard	Date	Description
47 CFR Part 15	-/-	Title 47 of the Code of Federal Regulations; Chapter I; Part 15 - Radio frequency devices
RSS - 247 Issue 2	February 2017	Digital Transmission Systems (DTSs), Frequency Hopping Systems (FHSs) and Licence - Exempt Local Area Network (LE-LAN) Devices
RSS - Gen Issue 5	April 2018	General Requirements for Compliance of Radio Apparatus

Guidance	Version	Description
ANSI C63.4-2014	-/-	American national standard for methods of measurement of radio-noise emissions from low-voltage electrical and electronic equipment in the range of 9 kHz to 40 GHz
ANSI C63.10-2013	-/-	American national standard of procedures for compliance testing of unlicensed wireless devices

6 Description of the test setup

Typically, the calibrations of the test apparatus are commissioned to and performed by an accredited calibration laboratory. The calibration intervals are determined in accordance with the DIN EN ISO/IEC 17025. In addition to the external calibrations, the laboratory executes comparison measurements with other calibrated test systems or effective verifications. Weekly chamber inspections and range calibrations are performed. Where possible, RF generating and signaling equipment as well as measuring receivers and analyzers are connected to an external high-precision 10 MHz reference (GPS-based or rubidium frequency standard).

In order to simplify the identification of the equipment used at some special tests, some items of test equipment and ancillaries can be provided with an identifier or number in the equipment list below (Lab/Item).

Agenda: Kind of Calibration

k	calibration / calibrated	EK	limited calibration
ne	not required (k, ev, izw, zw not required)	zw	cyclical maintenance (external cyclical maintenance)
ev	periodic self verification	izw	internal cyclical maintenance
Ve	long-term stability recognized	g	blocked for accredited testing
vlk!	Attention: extended calibration interval		
NK!	Attention: not calibrated	*)	next calibration ordered / currently in progress

6.1 Shielded semi anechoic chamber

The radiated measurements are performed in vertical and horizontal plane in the frequency range from 9 kHz to 1 GHz in semi-anechoic chambers. The EUT is positioned on a non-conductive support with a height of 0.80 m above a conductive ground plane that covers the whole chamber. The receiving antennas are confirmed with specifications ANSI C63. These antennas can be moved over the height range between 1.0 m and 4.0 m in order to search for maximum field strength emitted from EUT. The measurement distances between EUT and receiving antennas are indicated in the test setups for the various frequency ranges. For each measurement, the EUT is rotated in all three axes until the maximum field strength is received. The wanted and unwanted emissions are received by spectrum analyzers where the detector modes and resolution bandwidths over various frequency ranges are set according to requirement ANSI C63.

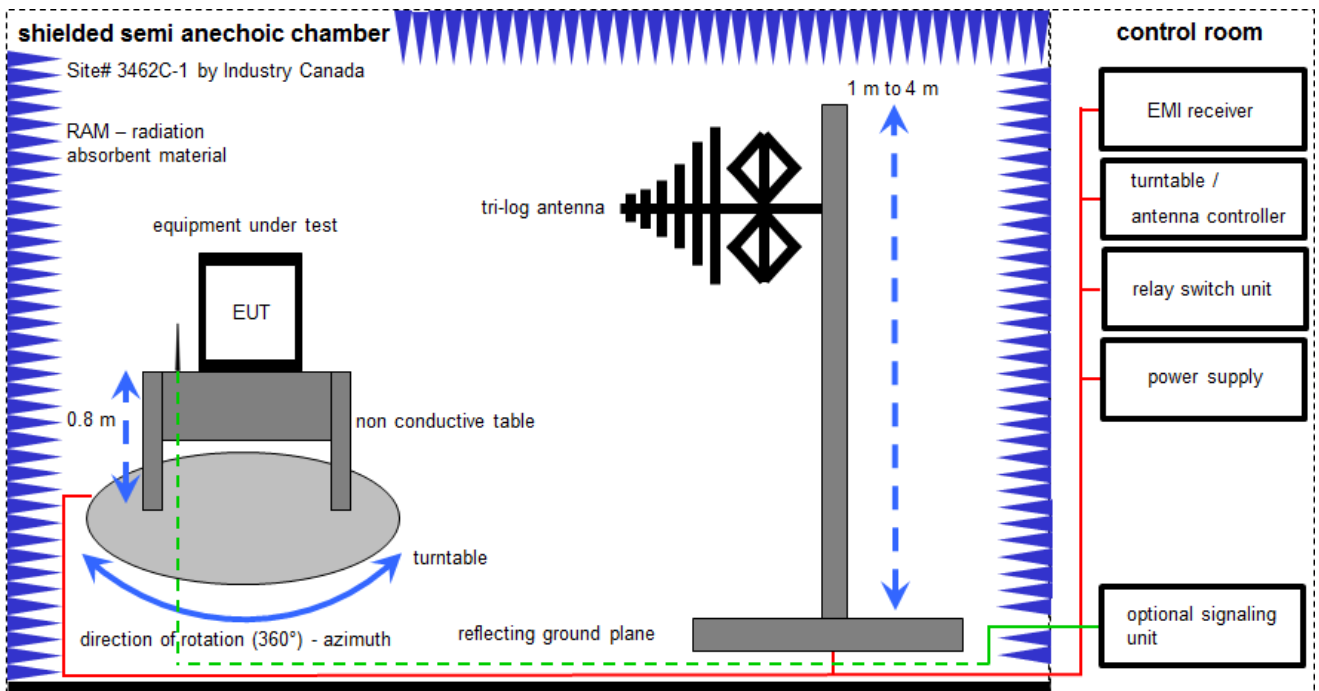

Measurement distance: tri-log antenna 10 meter

$$FS = UR + CL + AF$$

(FS-field strength; UR-voltage at the receiver; CL-loss of the cable; AF-antenna factor)

Example calculation:

$$FS [dB\mu V/m] = 12.35 [dB\mu V/m] + 1.90 [dB] + 16.80 [dB/m] = 31.05 [dB\mu V/m] (35.69 \mu V/m)$$

Equipment table:

No.	Lab / Item	Equipment	Type	Manufact.	Serial No.	INV. No Cetecom	Kind of Calibration	Last Calibration	Next Calibration
1	A	Switch-Unit	3488A	HP	2719A14505	300000368	ev	-/-	-/-
2	A	EMI Test Receiver	ESCI 3	R&S	100083	300003312	k	01.02.2017	31.01.2018
3	A	Antenna Tower	Model 2175	ETS-Lindgren	64762	300003745	izw	-/-	-/-
4	A	Positioning Controller	Model 2090	ETS-Lindgren	64672	300003746	izw	-/-	-/-
5	A	Turntable Interface-Box	Model 105637	ETS-Lindgren	44583	300003747	izw	-/-	-/-
6	A	TRILOG Broadband Test-Antenna 30 MHz – 3 GHz	VULB9163	Schwarzbeck	295	300003787	k	25.04.2016	25.04.2018

6.2 Shielded fully anechoic chamber

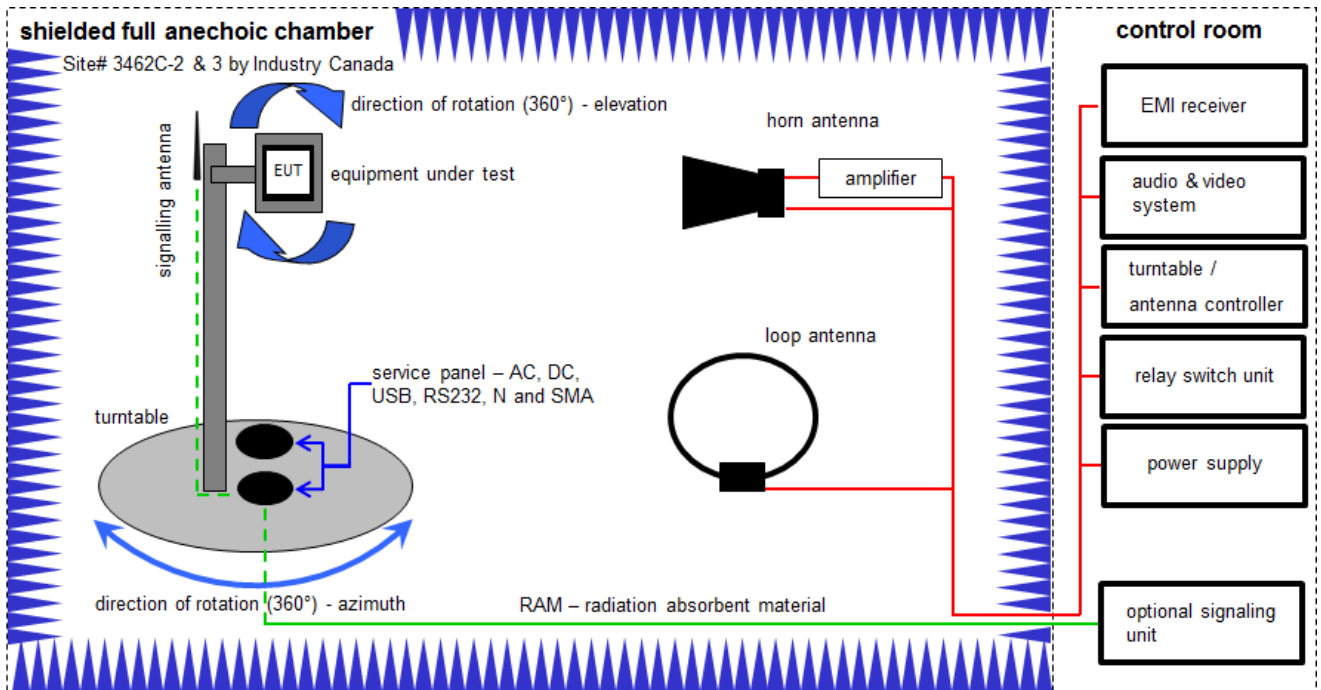

Measurement distance: horn antenna 3 meter; loop antenna 3 meter / 1 meter

$$FS = UR + CA + AF$$

(FS-field strength; UR-voltage at the receiver; CA-loss of the signal path; AF-antenna factor)

Example calculation:

$$FS [dB\mu V/m] = 40.0 [dB\mu V/m] + (-35.8) [dB] + 32.9 [dB/m] = 37.1 [dB\mu V/m] (71.61 \mu V/m)$$

Equipment table:

No.	Lab / Item	Equipment	Type	Manufact.	Serial No.	INV. No Cetecom	Kind of Calibration	Last Calibration	Next Calibration
1	A	Double-Ridged Waveguide Horn Antenna 1-18.0GHz	3115	EMCO	9709-5290	300000212	k	13.08.2015	13.08.2017
2	A,B,C	Anechoic chamber	FAC 3/5m	MWB / TDK	87400/02	300000996	ev	-/-	-/-
3	A,B,C	Switch / Control Unit	3488A	HP	*	300000199	ne	-/-	-/-
4	C	Active Loop Antenna 10 kHz to 30 MHz	6502	EMCO	2210	300001015	k	20.05.2017	20.05.2019
5	A	Amplifier	js42-00502650-28-5a	Parzich GMBH	928979	300003143	ne	-/-	-/-
6	A	Band Reject filter	WRCG2400/2483-2375/2505-50/10SS	Wainwright	11	300003351	ev	-/-	-/-
7	A	Highpass Filter	WHKX7.0/18G-8SS	Wainwright	18	300003789	ne	-/-	-/-
8	A,B,C	4U RF Switch Platform	L4491A	Agilent Technologies	MY50000037	300004509	ne	-/-	-/-
9	A, B, C	EMI Test Receiver 20Hz- 26,5GHz	ESU26	R&S	100037	300003555	k	31.01.2017	30.01.2018
10	A, B	TRILOG Broadband Test-Antenna 30 MHz – 3 GHz	VULB9163	Schwarzbeck	371	30000	vKI!	29.10.2014	29.10.2017

6.3 Radiated measurements > 18 GHz

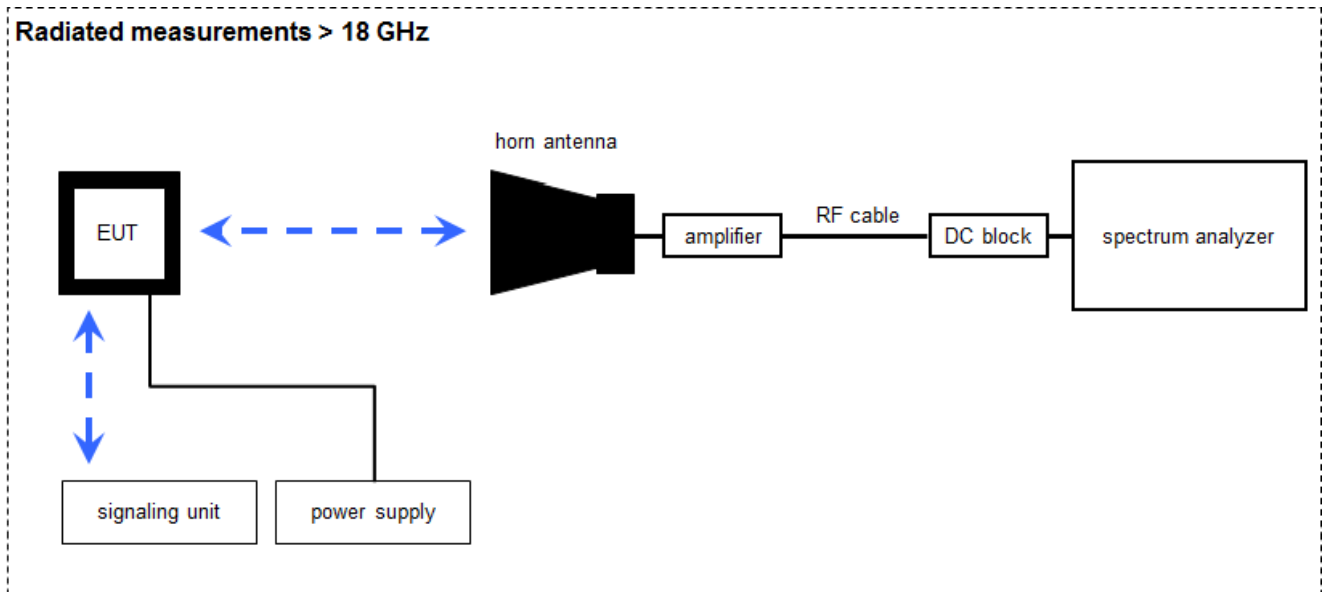

Measurement distance: horn antenna 50 cm

$$FS = UR + CA + AF$$

(FS-field strength; UR-voltage at the receiver; CA-loss signal path & distance correction; AF-antenna factor)

Example calculation:

$$FS [dB\mu V/m] = 40.0 [dB\mu V/m] + (-60.1) [dB] + 36.74 [dB/m] = 16.64 [dB\mu V/m] (6.79 \mu V/m)$$

Equipment table:

No.	Lab / Item	Equipment	Type	Manufacturer	Serial No.	INV. No.	Kind of Calibration	Last Calibration	Next Calibration
1	A	Std. Gain Horn Antenna 18.0 to 26.5 GHz	638	Narda	-/-	300000486	k	10.09.2015	10.09.2017
2	A	Signal Analyzer 40 GHz	FSV40	R&S	101042	300004517	k	27.01.2017	26.01.2018
3	A	Amplifier 2-40 GHz	JS32-02004000-57-5P	MITEQ	1777200	300004541	ev	-/-	-/-
4	A	RF-Cable	ST18/SMAm/SMAm/48	Huber & Suhner	Batch no. 600918	400001182	ev	-/-	-/-
5	A	RF-Cable	ST18/SMAm/SMAm/48	Huber & Suhner	Batch no. 127377	400001183	ev	-/-	-/-
6	A	DC-Blocker 0.1-40 GHz	8141A	Inmet	-/-	400001185	ev	-/-	-/-

6.4 Conducted measurements C.BER system

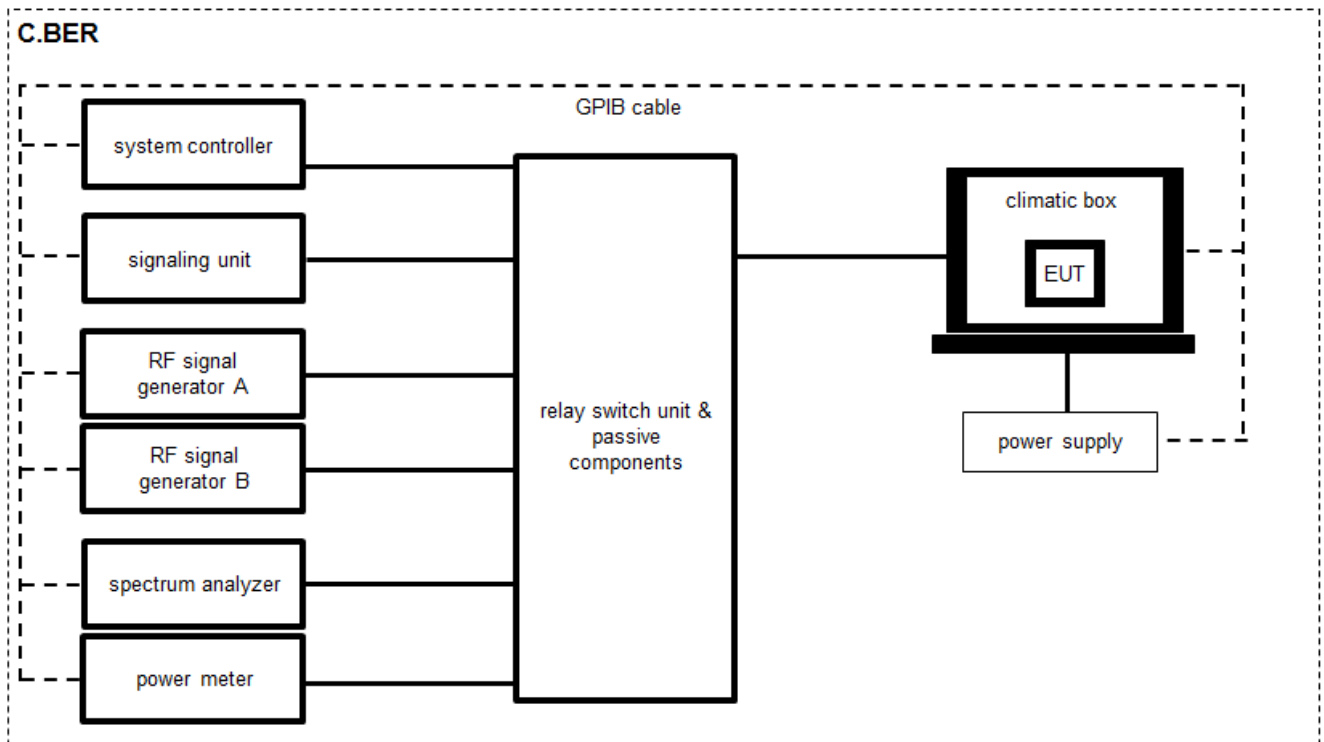

OP = AV + CA
(OP-output power; AV-analyzer value; CA-loss signal path)

Example calculation:

OP [dBm] = 6.0 [dBm] + 11.7 [dB] = 17.7 [dBm] (58.88 mW)

Equipment table:

No.	Lab / Item	Equipment	Type	Manufact.	Serial No.	INV. No Cetecom	Kind of Calibration	Last Calibration	Next Calibration
1	A	Switch / Control Unit	3488A	HP		300001691	ne	-/-	-/-
2	A	Signal Analyzer 30GHz	FSV30	R&S	103170	300004855	k	30.01.2017	29.01.2019
3	A	Directional Coupler	101020010	Krytar	70215	300002840	ev	-/-	-/-
4	A	DC-Blocker	8143	Inmet Corp.	none	300002842	ne	-/-	-/-
5	A	Powersplitter	6005-3	Inmet Corp.	none	300002841	ev	-/-	-/-
6	A	RF-Cable	ST18/SMAm/SMAm/72	Huber & Suhner	Batch no. 605505	400001187	ev	-/-	-/-
7	A	RF-Cable	Sucoflex 104	Huber & Suhner	147636/4	400001188	ev	-/-	-/-

6.5 AC conducted

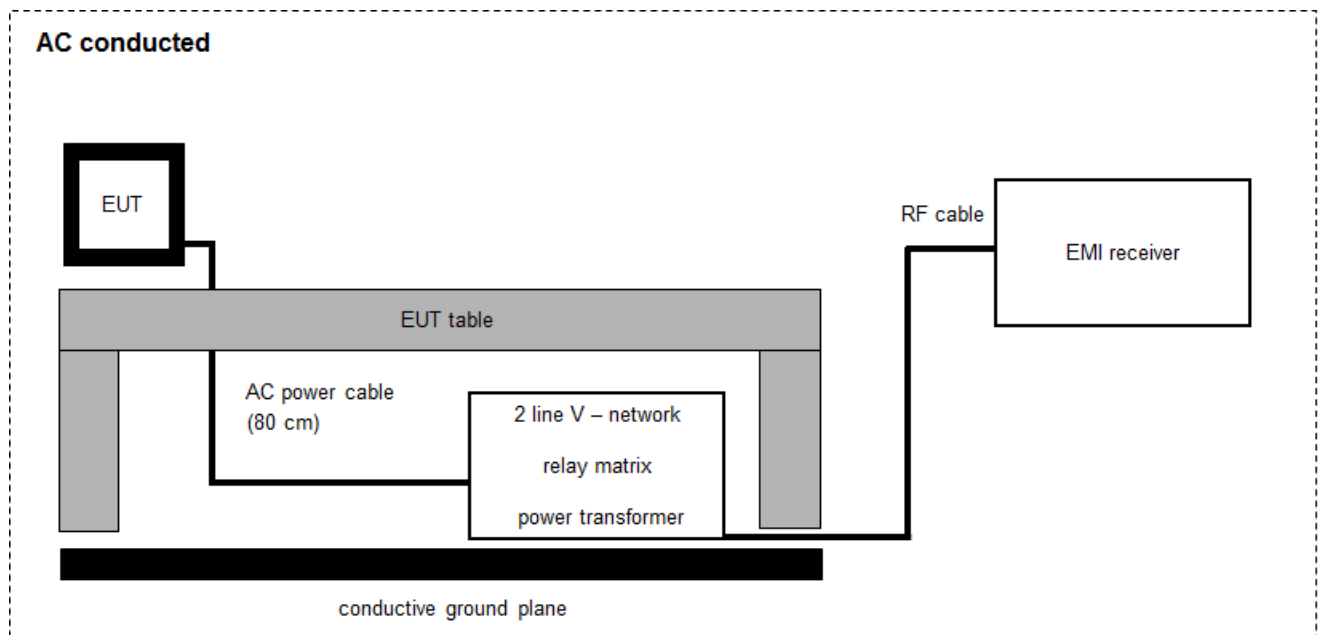

$$FS = UR + CF + VC$$

(FS-field strength; UR-voltage at the receiver; CR-loss of the cable and filter; VC-correction factor of the ISN)

Example calculation:

$$FS [dB\mu V/m] = 37.62 [dB\mu V/m] + 9.90 [dB] + 0.23 [dB] = 47.75 [dB\mu V/m] (244.06 \mu V/m)$$

Equipment table:

No.	Lab / Item	Equipment	Type	Manufacturer	Serial No.	INV. No.	Kind of Calibration	Last Calibration	Next Calibration
1	A	Two-line V-Network (LISN) 9 kHz to 30 MHz	ESH3-Z5	R&S	893045/004	300000584	k	31.01.2017	30.01.2018
2	A	RF-Filter-section	85420E	HP	3427A00162	300002214	k	27.11.2006	-/-
3	A	EM-Injection Clamp	FCC-203i	emv	232	300000626	ev	18.05.2001	-/-
4	A	AC-Spannungsquelle variabel	MV2616-V	EM-Test	0397-12	300003259	k	11.12.2015	11.12.2017
5	A	Hochpass 150 kHz	EZ-25	R&S	100010	300003798	ev	08.04.2008	-/-
6	A	Signal Analyzer 40 GHz	FSV40	R&S	101042	300004517	k	27.01.2017	26.01.2018

6.6 Conducted measurements C.BER system (only chapter 11.4)

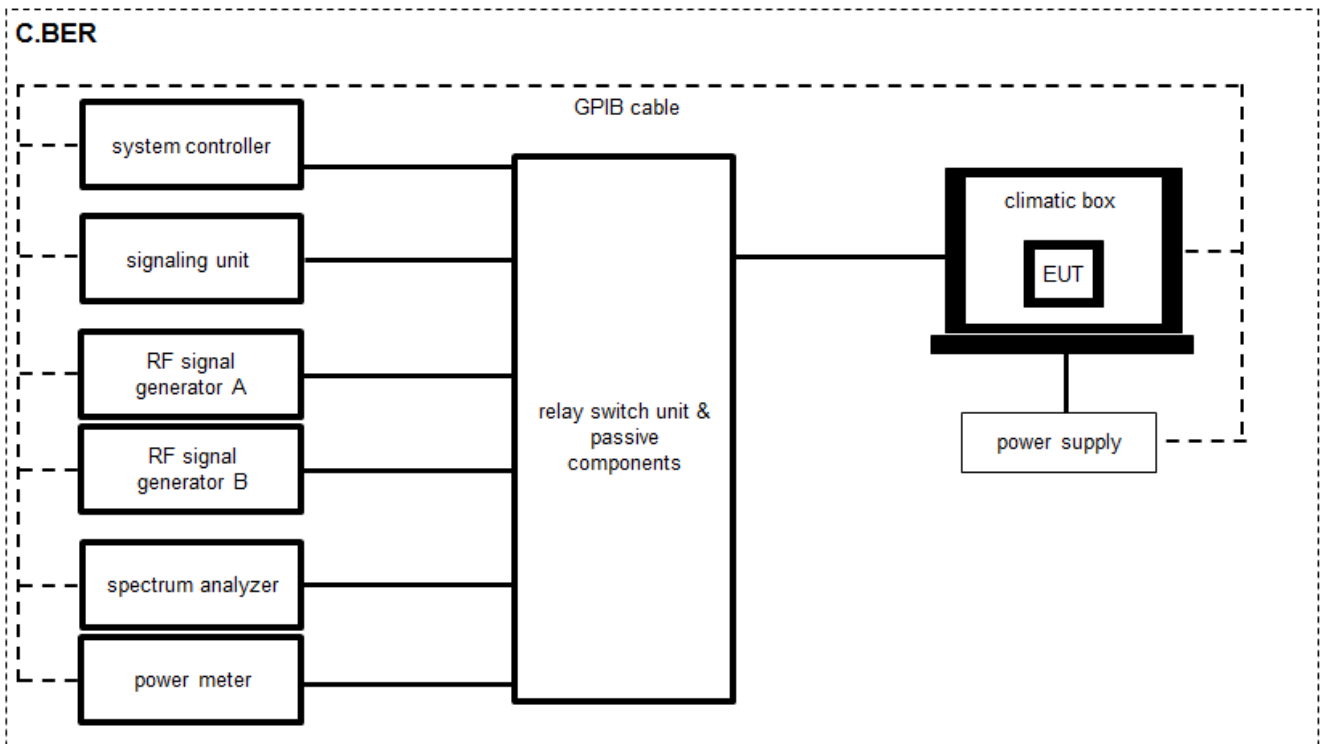

OP = AV + CA
(OP-output power; AV-analyzer value; CA-loss signal path)

Example calculation:

OP [dBm] = 6.0 [dBm] + 11.7 [dB] = 17.7 [dBm] (58.88 mW)

Equipment table:

No.	Lab / Item	Equipment	Type	Manufacturer	Serial No.	INV. No.	Kind of Calibration	Last Calibration	Next Calibration
1	A	Spectrum Analyzer	FSV30	Rohde & Schwarz	103809	300005359	k	04.04.2017	03.04.2019
2	A	Relay Switch Matrix	RSM-1	CTC	1	400001355	ev	07.02.2018	06.02.2019
3	A	RF-Cable	ST18/SMAM/SMAM /48	Huber & Suhner	Batch no. 699866	400001189	k	-/-	-/-
4	A	RF-Cable	ST18/SMAM/SMAM /48	Huber & Suhner	Batch no. 14844	400001190	k	-/-	-/-

7 Sequence of testing

7.1 Sequence of testing radiated spurious 9 kHz to 30 MHz

Setup

- The equipment is set up to simulate normal operation mode as described in the user manual or defined by the manufacturer.
- If the EUT is a tabletop system, a 2-axis positioner with 1.5 m height is used.
- If the EUT is a floor standing device, it is placed directly on the turn table.
- Auxiliary equipment and cables are positioned to simulate normal operation conditions as described in ANSI C 63.4.
- The AC power port of the EUT (if available) is connected to a power outlet below the turntable.
- Measurement distance is 3 m (see ANSI C 63.4) – see test details.
- EUT is set into operation.

Premeasurement

- The turntable rotates from 0° to 315° using 45° steps.
- The antenna height is 1.5 m.
- At each turntable position the analyzer sweeps with positive-peak detector to find the maximum of all emissions.

Final measurement

- Identified emissions during the premeasurement are maximized by the software by rotating the turntable from 0° to 360°. In case of the 2-axis positioner is used the elevation axis is also rotated from 0° to 360°.
- The final measurement is done in the position (turntable and elevation) causing the highest emissions with quasi-peak (as described in ANSI C 63.4).
- Final levels, frequency, measuring time, bandwidth, turntable position, correction factor, margin to the limit and limit will be recorded. A plot with the graph of the premeasurement and the limit is stored.

7.2 Sequence of testing radiated spurious 30 MHz to 1 GHz

Setup

- The equipment is set up to simulate normal operation mode as described in the user manual or defined by the manufacturer.
- If the EUT is a tabletop system, a table with 0.8 m height is used, which is placed on the ground plane.
- If the EUT is a floor standing device, it is placed on the ground plane with insulation between both.
- Auxiliary equipment and cables are positioned to simulate normal operation conditions as described in ANSI C 63.4.
- The AC power port of the EUT (if available) is connected to a power outlet below the turntable.
- Measurement distance is 10 m or 3 m (see ANSI C 63.4) – see test details.
- EUT is set into operation.

Premeasurement

- The turntable rotates from 0° to 315° using 45° steps.
- The antenna is polarized vertical and horizontal.
- The antenna height changes from 1 m to 3 m.
- At each turntable position, antenna polarization and height the analyzer sweeps three times in peak to find the maximum of all emissions.

Final measurement

- The final measurement is performed for at least six highest peaks according to the requirements of the ANSI C63.4.
- Based on antenna and turntable positions at which the peak values are measured the software maximize the peaks by changing turntable position $\pm 45^\circ$ and antenna height between 1 and 4 m.
- The final measurement is done with quasi-peak detector (as described in ANSI C 63.4).
- Final levels, frequency, measuring time, bandwidth, antenna height, antenna polarization, turntable angle, correction factor, margin to the limit and limit are recorded. A plot with the graph of the premeasurement with marked maximum final results and the limit is stored.

7.3 Sequence of testing radiated spurious 1 GHz to 18 GHz

Setup

- The equipment is set up to simulate normal operation mode as described in the user manual or defined by the manufacturer.
- If the EUT is a tabletop system, a 2-axis positioner with 1.5 m height is used.
- If the EUT is a floor standing device, it is placed directly on the turn table.
- Auxiliary equipment and cables are positioned to simulate normal operation conditions as described in ANSI C 63.4.
- The AC power port of the EUT (if available) is connected to a power outlet below the turntable.
- Measurement distance is 3 m (see ANSI C 63.4) – see test details.
- EUT is set into operation.

Premeasurement

- The turntable rotates from 0° to 315° using 45° steps.
- The antenna is polarized vertical and horizontal.
- The antenna height is 1.5 m.
- At each turntable position and antenna polarization the analyzer sweeps with positive peak detector to find the maximum of all emissions.

Final measurement

- The final measurement is performed for at least six highest peaks according to the requirements of the ANSI C63.4.
- Based on antenna and turntable positions at which the peak values are measured the software maximizes the peaks by rotating the turntable from 0° to 360°. This measurement is repeated for different EUT-table positions (0° to 150° in 30°-steps) and for both antenna polarizations.
- The final measurement is done in the position (turntable, EUT-table and antenna polarization) causing the highest emissions with Peak and RMS detector (as described in ANSI C 63.4).
- Final levels, frequency, measuring time, bandwidth, turntable position, EUT-table position, antenna polarization, correction factor, margin to the limit and limit are recorded. A plot with the graph of the premeasurement with marked maximum final results and the limit is stored.

7.4 Sequence of testing radiated spurious above 18 GHz

Setup

- The equipment is set up to simulate normal operation mode as described in the user manual or defined by the manufacturer.
- Auxiliary equipment and cables are positioned to simulate normal operation conditions as described in ANSI C 63.4.
- The AC power port of the EUT (if available) is connected to a power outlet.
- The measurement distance is as appropriate (e.g. 0.5 m).
- The EUT is set into operation.

Premeasurement

- The test antenna is handheld and moved carefully over the EUT to cover the EUT's whole sphere and different polarizations of the antenna.

Final measurement

- The final measurement is performed at the position and antenna orientation causing the highest emissions with Peak and RMS detector (as described in ANSI C 63.4).
- Final levels, frequency, measuring time, bandwidth, correction factor, margin to the limit and limit are recorded. A plot with the graph of the premeasurement and the limit is stored.

8 Measurement uncertainty

Measurement uncertainty	
Test case	Uncertainty
Antenna gain	± 3 dB
Carrier frequency separation	± 21.5 kHz
Number of hopping channels	-/-
Time of occupancy	-/-
Spectrum bandwidth	± 21.5 kHz absolute; ± 15.0 kHz relative
Maximum output power	± 1 dB
Detailed conducted spurious emissions @ the band edge	± 1 dB
Band edge compliance radiated	± 3 dB
Spurious emissions conducted	± 3 dB
Spurious emissions radiated below 30 MHz	± 3 dB
Spurious emissions radiated 30 MHz to 1 GHz	± 3 dB
Spurious emissions radiated 1 GHz to 12.75 GHz	± 3.7 dB
Spurious emissions radiated above 12.75 GHz	± 4.5 dB
Spurious emissions conducted below 30 MHz (AC conducted)	± 2.6 dB

9 Summary of measurement results

<input checked="" type="checkbox"/>	No deviations from the technical specifications were ascertained
<input type="checkbox"/>	There were deviations from the technical specifications ascertained
<input type="checkbox"/>	This test report is only a partial test report. The content and verdict of the performed test cases are listed below.

TC Identifier	Description	Verdict	Date	Remark
RF-Testing	CFR Part 15 RSS – 247, Issue 2	See table!	2018-07-05	-/-

Test specification clause	Test case	Temperature conditions	Power source voltages	Mode	C	NC	NA	NP	Remark
§15.247(b)(4) RSS – 247 / 5.4 (2)	Antenna gain	Nominal	Nominal	MSK	<input checked="" type="checkbox"/>	<input type="checkbox"/>	<input type="checkbox"/>	<input type="checkbox"/>	-/-
§15.247(a)(1) RSS – 247 / 5.1 (2)	Carrier frequency separation	Nominal	Nominal	MSK	<input checked="" type="checkbox"/>	<input type="checkbox"/>	<input type="checkbox"/>	<input type="checkbox"/>	-/-
§15.247(a)(1) RSS – 247 / 5.1 (4)	Number of hopping channels	Nominal	Nominal	MSK	<input checked="" type="checkbox"/>	<input type="checkbox"/>	<input type="checkbox"/>	<input type="checkbox"/>	-/-
§15.247(a)(1) (iii) RSS – 247 / 5.1 (4)	Time of occupancy (dwell time)	Nominal	Nominal	MSK	<input checked="" type="checkbox"/>	<input type="checkbox"/>	<input type="checkbox"/>	<input type="checkbox"/>	-/-
§15.247(a)(1) RSS – 247 / 5.1 (1)	Spectrum bandwidth of a FHSS system bandwidth	Nominal	Nominal	MSK	<input checked="" type="checkbox"/>	<input type="checkbox"/>	<input type="checkbox"/>	<input type="checkbox"/>	-/-
§15.247(b)(1) RSS – 247 / 5.4 (2)	Maximum output power	Nominal	Nominal	MSK	<input checked="" type="checkbox"/>	<input type="checkbox"/>	<input type="checkbox"/>	<input type="checkbox"/>	-/-
§15.247(d) RSS – 247 / 5.5	Detailed spurious emissions @ the band edge – conducted	Nominal	Nominal	MSK	<input checked="" type="checkbox"/>	<input type="checkbox"/>	<input type="checkbox"/>	<input type="checkbox"/>	-/-
§15.205 RSS – 247 / 5.5 RSS – Gen	Band edge compliance radiated	Nominal	Nominal	MSK	<input checked="" type="checkbox"/>	<input type="checkbox"/>	<input type="checkbox"/>	<input type="checkbox"/>	-/-
§15.247(d) RSS – 247 / 5.5	Spurious emissions conducted	Nominal	Nominal	MSK	<input checked="" type="checkbox"/>	<input type="checkbox"/>	<input type="checkbox"/>	<input type="checkbox"/>	-/-
§15.209(a) RSS – Gen	Spurious emissions radiated below 30 MHz	Nominal	Nominal	MSK	<input checked="" type="checkbox"/>	<input type="checkbox"/>	<input type="checkbox"/>	<input type="checkbox"/>	-/-
§15.247(d) RSS – 247 / 5.5 §15.109 RSS – Gen	Spurious emissions radiated 30 MHz to 1 GHz	Nominal	Nominal	MSK RX mode	<input checked="" type="checkbox"/>	<input type="checkbox"/>	<input type="checkbox"/>	<input type="checkbox"/>	-/-
§15.247(d) RSS – 247 / 5.5 §15.109 RSS – Gen	Spurious emissions radiated above 1 GHz	Nominal	Nominal	MSK RX mode	<input checked="" type="checkbox"/>	<input type="checkbox"/>	<input type="checkbox"/>	<input type="checkbox"/>	-/-
§15.107(a) §15.207	Conducted emissions below 30 MHz (AC conducted)	Nominal	Nominal		<input checked="" type="checkbox"/>	<input type="checkbox"/>	<input type="checkbox"/>	<input type="checkbox"/>	-/-

Note: C = Compliant; NC = Not compliant; NA = Not applicable; NP = Not performed

10 Additional comments

Reference documents: promote_air_FHSS_radiosystem_rev_A4
Test report no. 1-1120/16-01-02

Special test descriptions: None

Configuration descriptions: **All TX measurements were performed with a power setting of 18 dBm (Power level P1), only measurements on highest channel were performed with 6 dBm power setting (Power level P4) because otherwise it was not compliant with the band edge limitations.**

Test mode: Special software is used.
EUT is transmitting pseudo random data by itself

Antennas and transmit operating modes: Operating mode 1 (single antenna)

- Equipment with 1 antenna,
- Equipment with 2 diversity antennas operating in switched diversity mode by which at any moment in time only 1 antenna is used,
- Smart antenna system with 2 or more transmit/receive chains, but operating in a mode where only 1 transmit/receive chain is used)

11 Measurement results

11.1 Antenna gain

Measurement:

The antenna gain of the complete system is calculated by the difference of radiated power in EIRP and the conducted power of the module.

Measurement parameters	
Detector	Peak
Sweep time	Auto
Resolution bandwidth	3 MHz
Video bandwidth	3 MHz
Span	5 MHz
Trace mode	Max hold
Test setup	See sub clause 6.2 B (radiated) See sub clause 6.4 A (conducted)
Measurement uncertainty	See sub clause 8

Limits:

FCC	IC
6 dBi / > 6 dBi output power and power density reduction required	

Results: Values taken from Test report no. 1-1120/16-01-02

	lowest channel 2404 MHz	middle channel 2447 MHz	highest channel 2479.3 MHz
Gain [dBi]	-0.2	0.0	0.2

11.2 Carrier frequency separation

Description:

Measurement of the carrier frequency separation of a hopping system. The carrier frequency separation is constant for all modulation-modes. EUT in hopping mode.

Measurement parameters	
Detector	Peak
Sweep time	Auto
Resolution bandwidth	100 kHz
Video bandwidth	300 kHz
Span	4 MHz
Trace mode	Max hold
Test setup	See sub clause 6.4 A
Measurement uncertainty	See sub clause 8

Limits:

FCC	IC
Carrier frequency separation	
Minimum 25 kHz or two-thirds of the 20 dB bandwidth of the hopping system whichever is greater.	

Result:

Carrier frequency separation	~ 3 MHz
------------------------------	---------

Plot:

Plot 1: Carrier frequency separation

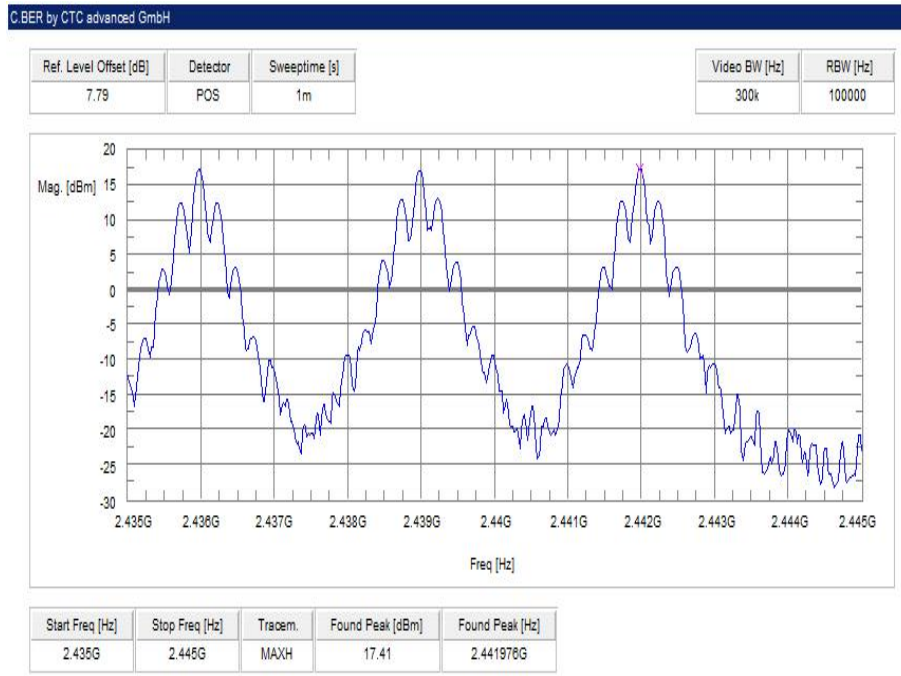

11.3 Number of hopping channels

Description:

Measurement of the total number of used hopping channels. The number of hopping channels is constant for all modulation-modes. EUT in hopping mode.

Measurement parameters	
Detector	Peak
Sweep time	Auto
Resolution bandwidth	500 kHz
Video bandwidth	500 kHz
Span	Plot 1: 2400 – 2445 MHz Plot 2: 2445 – 2485 MHz
Trace mode	Max hold
Test setup	See sub clause 6.4 A
Measurement uncertainty	See sub clause 8

Limits:

FCC	IC
Number of hopping channels	
At least 15 non overlapping hopping channels	

Result:

Number of hopping channels	22
----------------------------	----

Plots:

Plot 1: Number of hopping channels

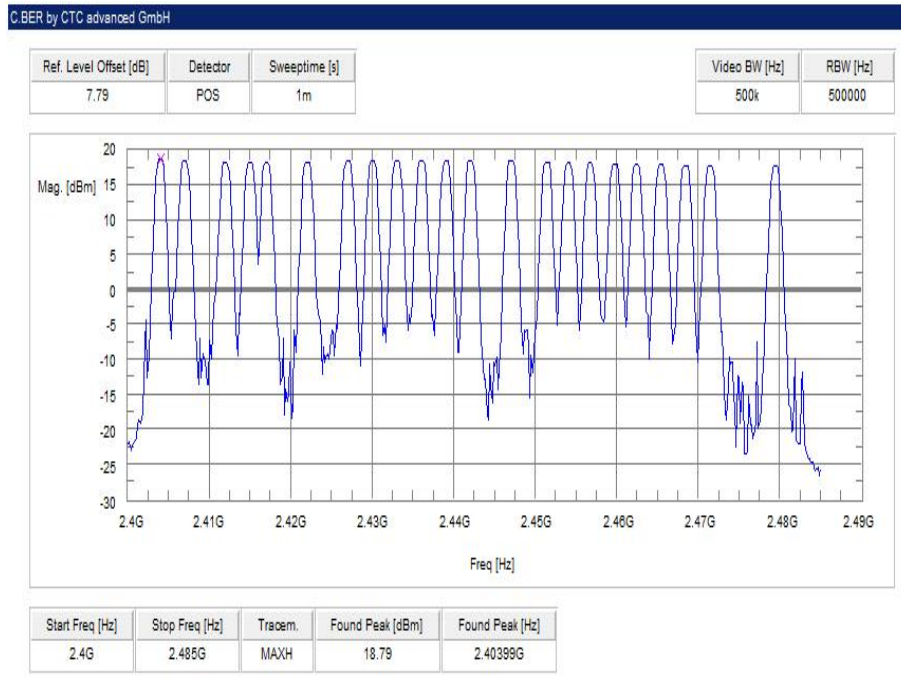

11.4 Time of occupancy (dwell time)

Measurement parameters	
Detector	Peak
Sweep time	10 ms / 8.8 s
Resolution bandwidth	200 kHz
Video bandwidth	200 kHz
Trace mode	Max hold
Span	Zero span
Additional EUT parameters:	Hopping on
Test setup	See sub clause 6.6 A
Measurement uncertainty	See sub clause 8

Results:

<i>Channel frequency [MHz]</i>	<i>Measured pulse width [ms]</i>	Number of hops during observation time 8.8s	<i>Calculated staying time[ms]</i>
2404.0	0.551	56	30.9
2427.0	0.536	56	30.0
2479.3	0.551	56	30.9

Limits:

FCC	IC
Time of occupancy (dwell time)	
The frequency hopping operation shall have an average time of occupancy on any frequency not exceeding 0.4 seconds within a duration in seconds equal to the number of hopping frequencies multiplied by 0.4.	

Plots:

Plot 1: 2404 MHz, Zero span, pulse width

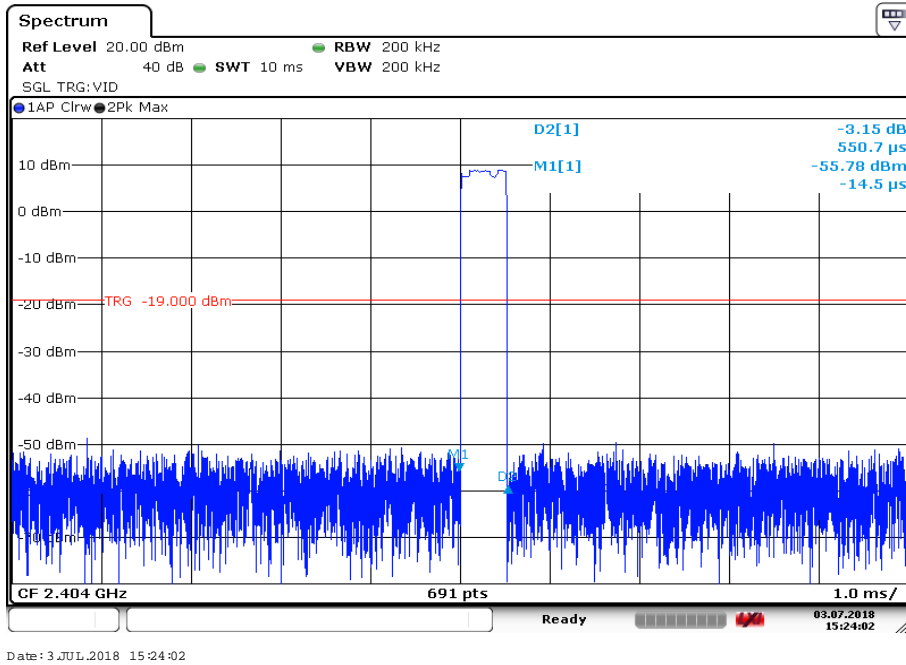

Plot 2: 2427 MHz, Zero span, pulse width

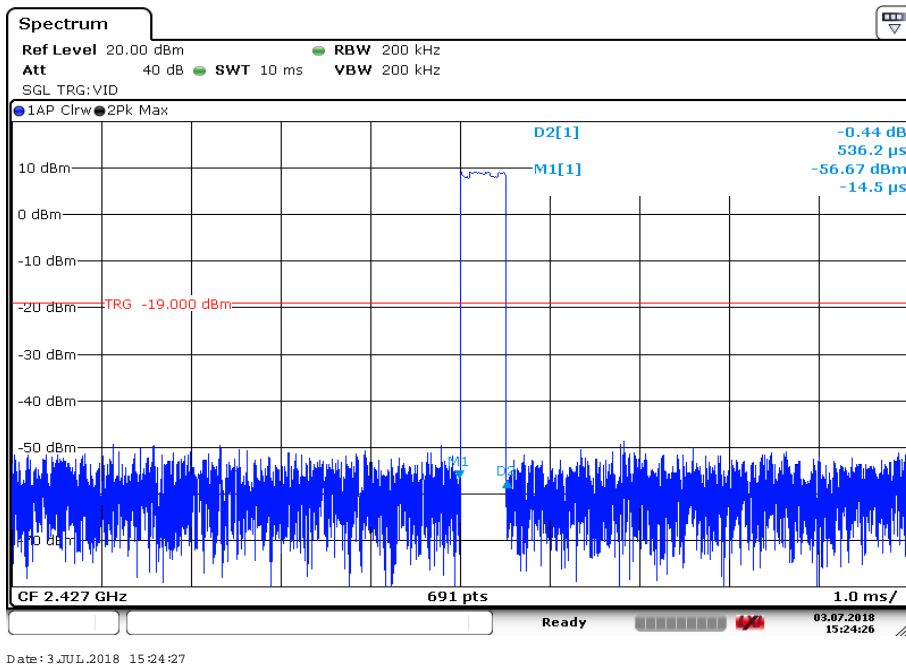

Plot 3: 2479.3 MHz, Zero span, pulse width

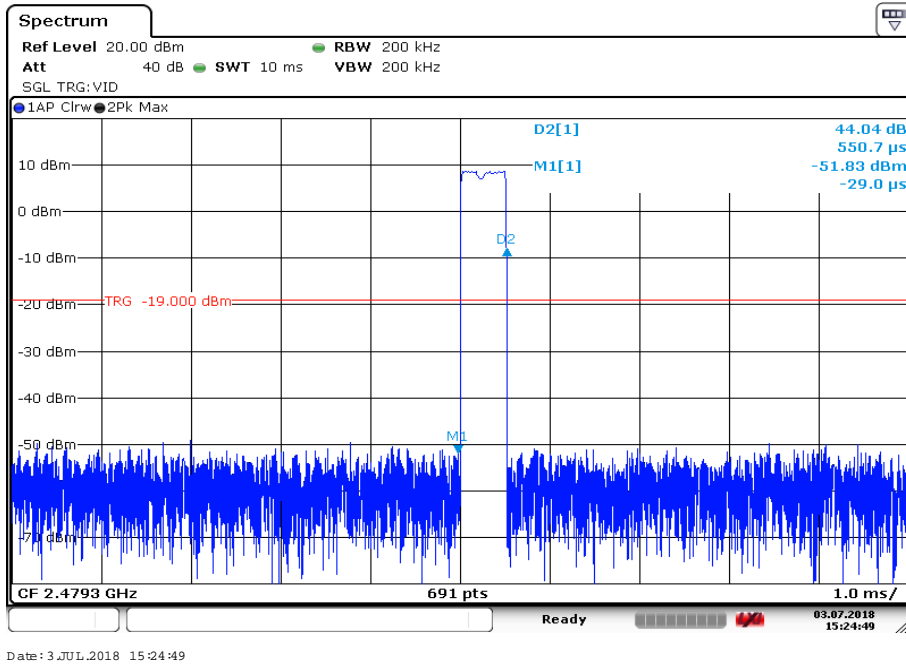

Plot 4: 2404 MHz, 8.8 s sweep

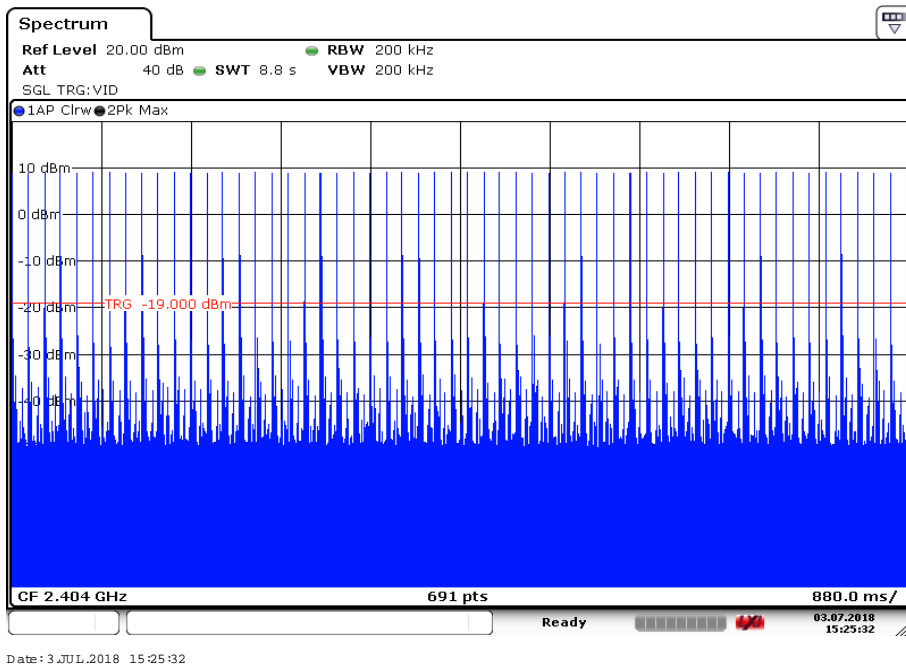

Plot 5: 2427 MHz, 8.8 s sweep

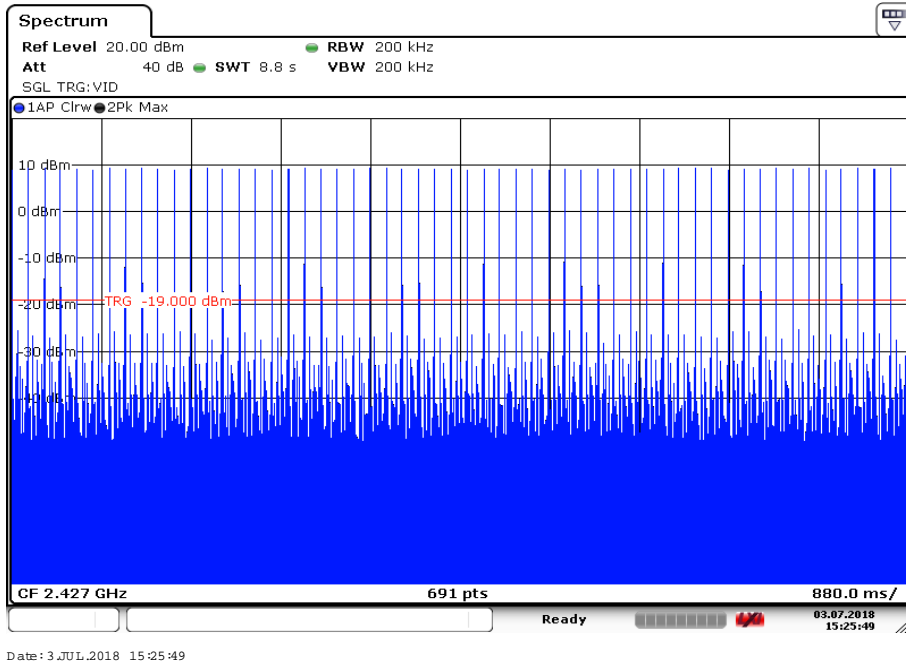

Plot 6: 2479.3 MHz, 8.8 s sweep

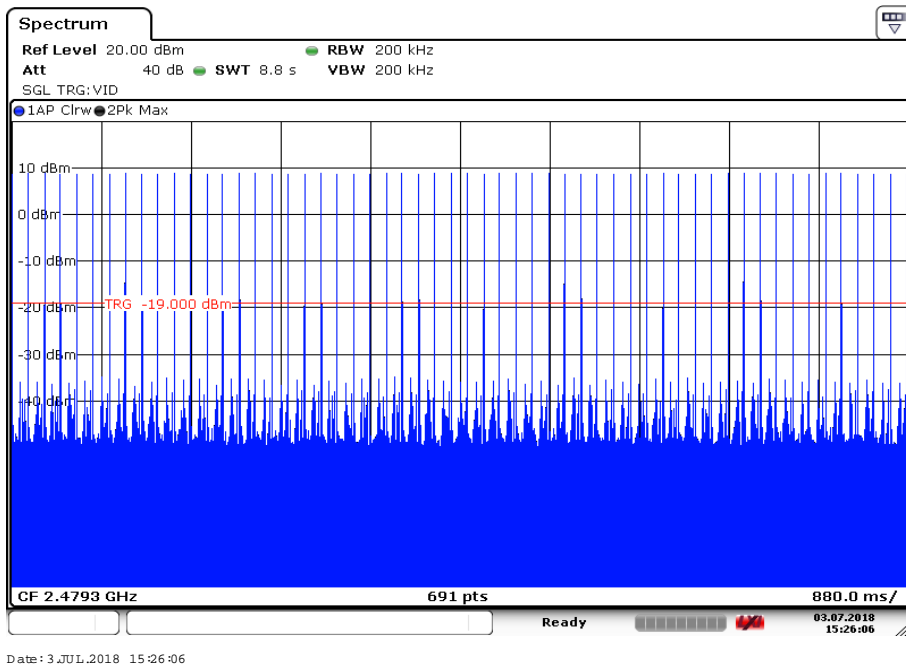

11.5 Spectrum bandwidth of a FHSS system

Description:

Measurement of the 20dB bandwidth and 99% bandwidth of the modulated signal. The measurement is performed according to the "Measurement Guidelines" (DA 00-705, March 30, 2000). EUT in single channel mode.

Measurement parameters	
Detector	Peak
Sweep time	Auto
Resolution bandwidth	30 kHz
Video bandwidth	100 kHz
Span	3 MHz
Trace mode	Max hold
Test setup	See sub clause 6.4 A
Measurement uncertainty	See sub clause 8

Limits:

FCC	IC
Spectrum bandwidth of a FHSS system	
< 4500 kHz	

Results:

Frequency	20 dB bandwidth [kHz]		
	2404.0 MHz	2427.0 MHz	2479.3 MHz
	1210	1200	1200

Results:

Frequency	99 % bandwidth [kHz]		
	2404.0 MHz	2427.0 MHz	2479.3 MHz
	1207	1187	1167

Plots:

Plot 1: lowest channel – 2404.0 MHz

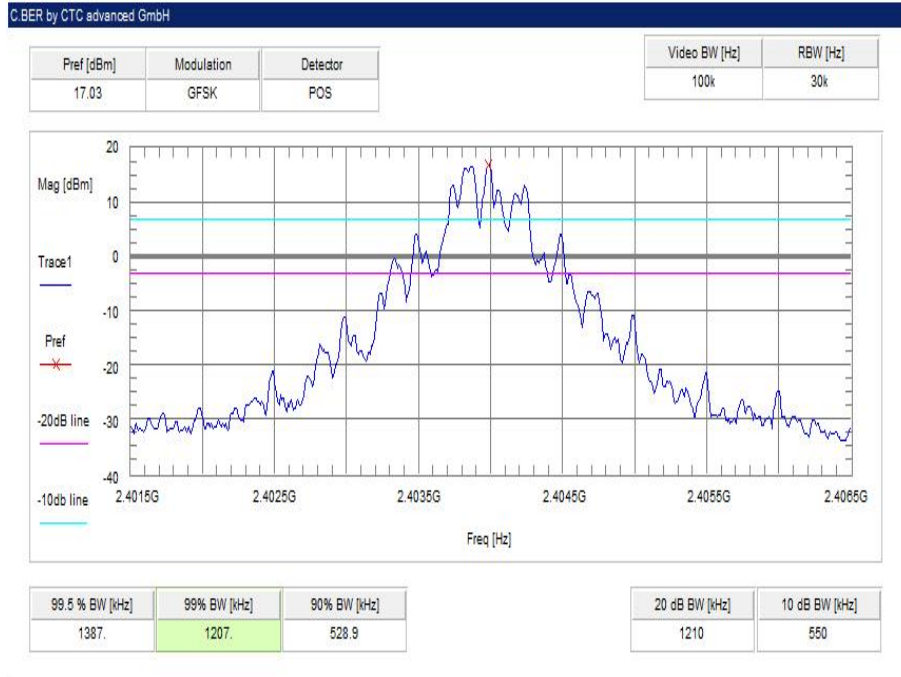

Plot 2: middle channel – 2427.0 MHz

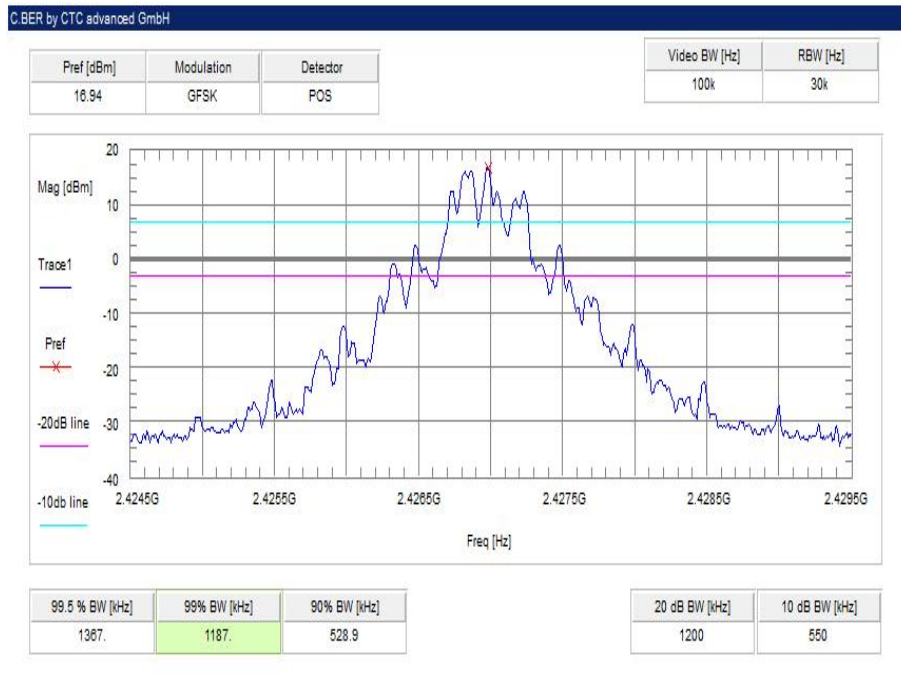

Plot 3: highest channel – 2479.3 MHz

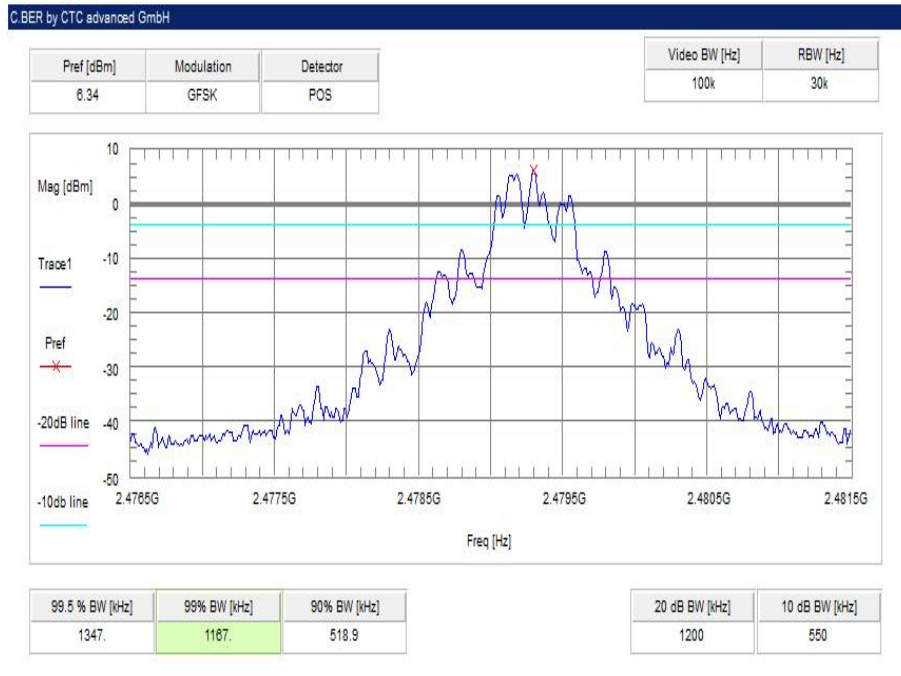

11.6 Maximum output power

Description:

Measurement of the maximum output power conducted and radiated. EUT in single channel mode. The measurement is performed according to the ANSI C63.10.

Measurement parameters	
Detector	Peak
Sweep time	Auto
Resolution bandwidth	3 MHz
Video bandwidth	10 MHz
Span	6 MHz
Trace mode	Max hold
Test setup	See sub clause 6.4 A
Measurement uncertainty	See sub clause 8

Limits:

FCC	IC
Maximum output power	
[Conducted: 0.125 W – antenna gain max. 6 dBi] Systems using more than 75 hopping channels: Conducted: 1.0 W – antenna gain max. 6 dBi	

Results:

Frequency	Maximum output power conducted [dBm]		
	2404.0 MHz	2427.0 MHz	2479.3 MHz
	19.1	18.7	8.1

Plots:

Plot 1: lowest channel – 2404.0 MHz

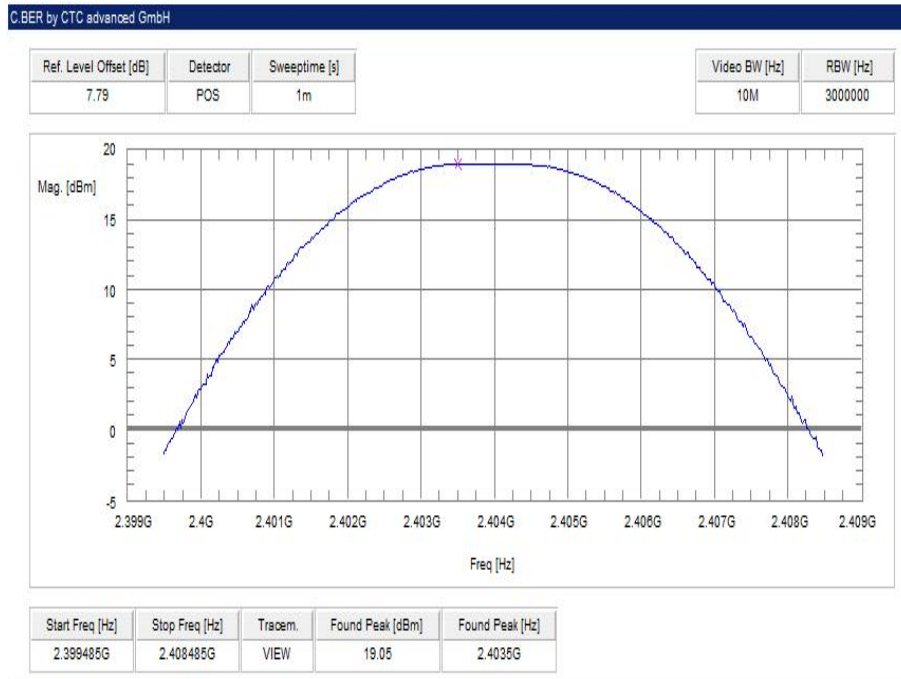

Plot 2: middle channel – 2427.0 MHz

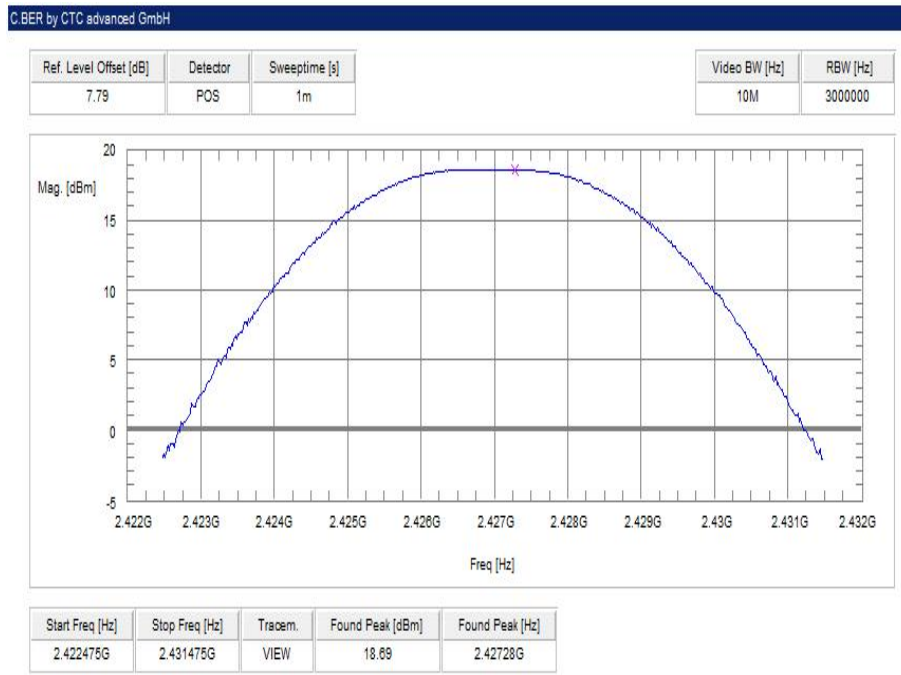

Plot 3: highest channel – 2479.3 MHz

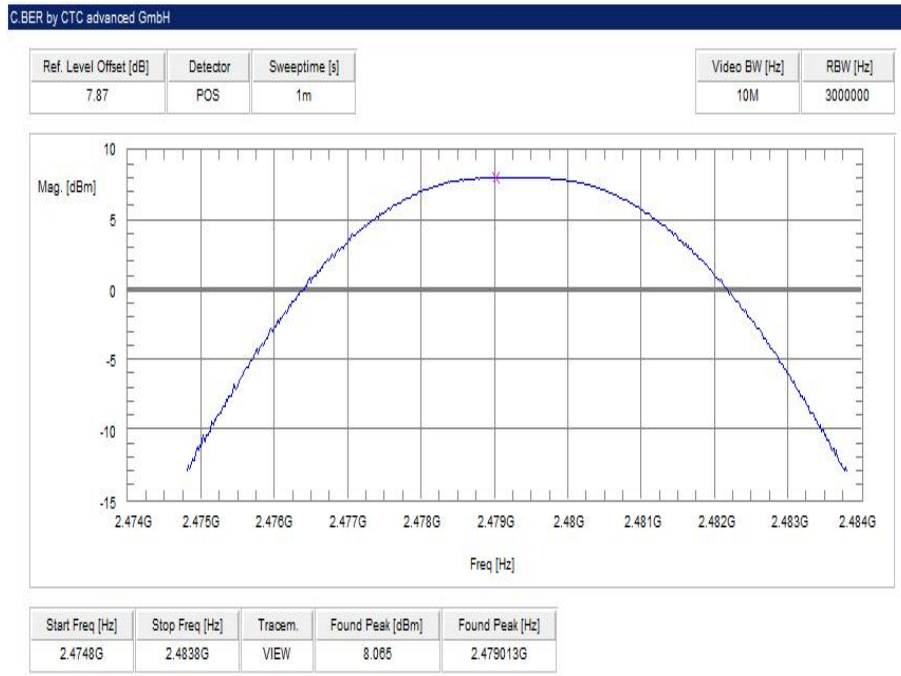

11.7 Detailed spurious emissions @ the band edge – conducted

Description:

Measurement of the conducted band edge compliance. EUT is measured at the lower and upper band edge in single channel and hopping mode. The measurement is repeated for all modulations.

Measurement parameters	
Detector	Peak
Sweep time	Auto
Resolution bandwidth	100 kHz
Video bandwidth	300 kHz / 500 kHz
Span	Lower Band Edge: 2395 – 2405 MHz Upper Band Edge: 2478 – 2489 MHz
Trace mode	Max hold
Test setup	See sub clause 6.4 A
Measurement uncertainty	See sub clause 8

Limits:

FCC	IC
In any 100 kHz bandwidth outside the frequency band in which the spread spectrum or digitally modulated intentional radiator is operating, the radio frequency power that is produced by the intentional radiator shall be at least 20 dB below that in the 100 kHz bandwidth within the band that contains the highest level of the desired power, based on either an RF conducted or a radiated measurement. Attenuation below the general limits specified in Section 15.209(a) is not required.	

Results:

Scenario	Spurious band edge conducted [dB]
Lower band edge – hopping off	> 20 dB
Lower band edge – hopping on	> 20 dB
Upper band edge – hopping off	> 20 dB
Upper band edge – hopping on	> 20 dB

Plots:

Plot 1: Lower band edge – hopping on

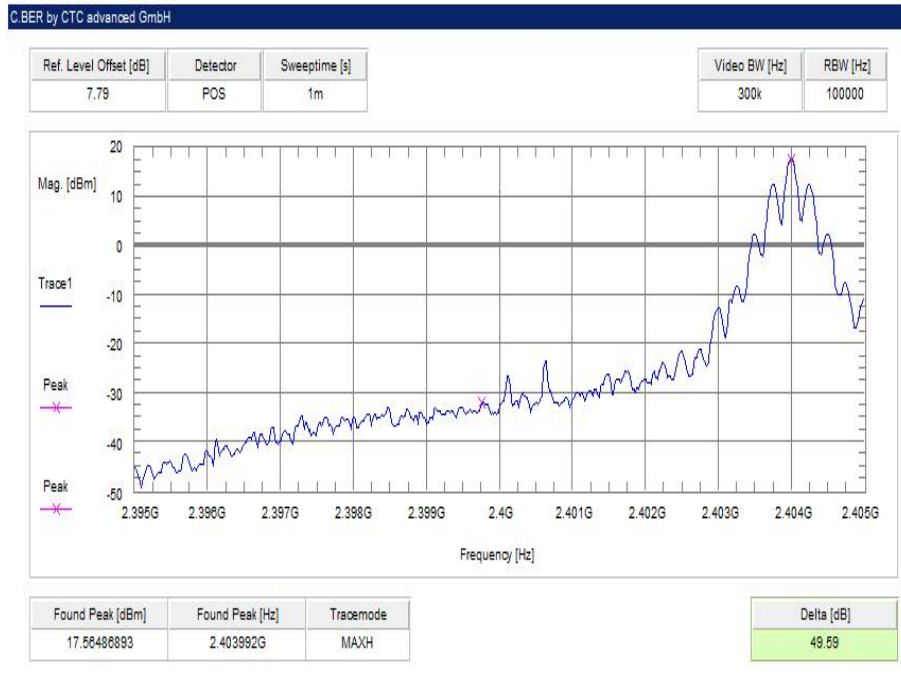

Plot 2: Upper band edge – hopping on

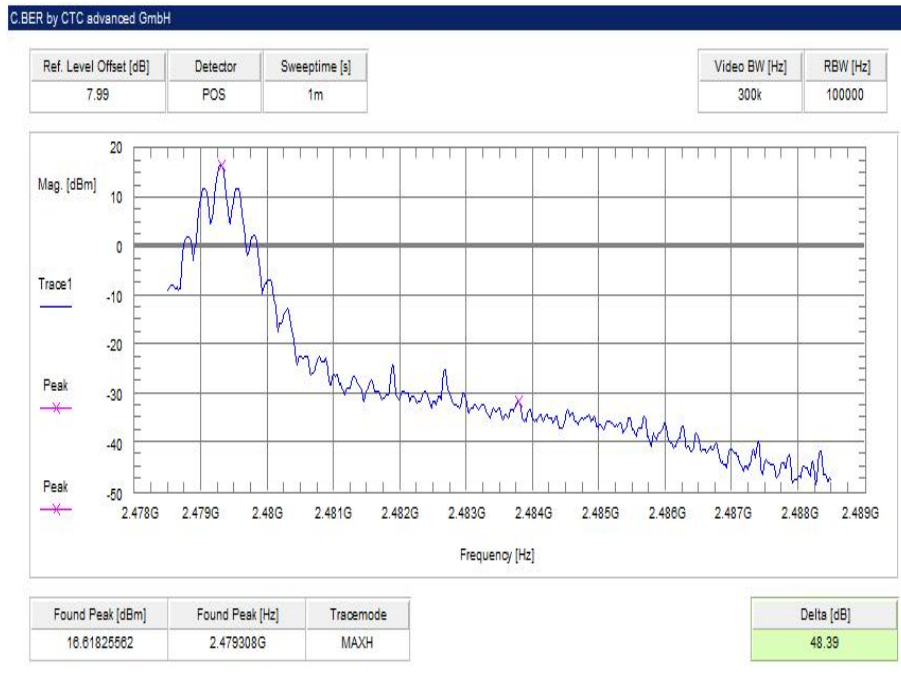

Plot 3: Lower band edge – hopping off

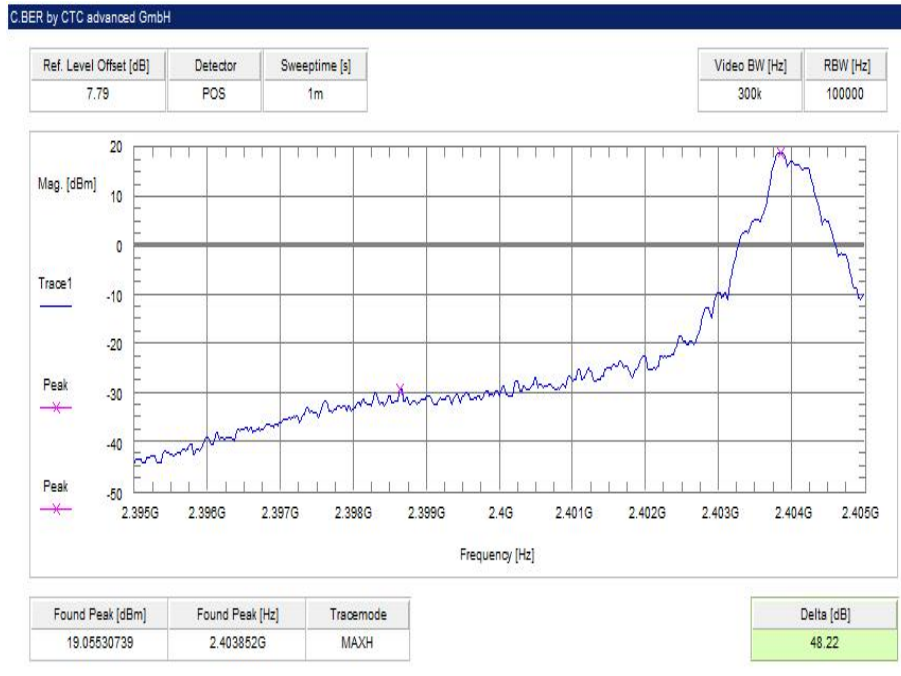

Plot 4: Upper band edge – hopping off

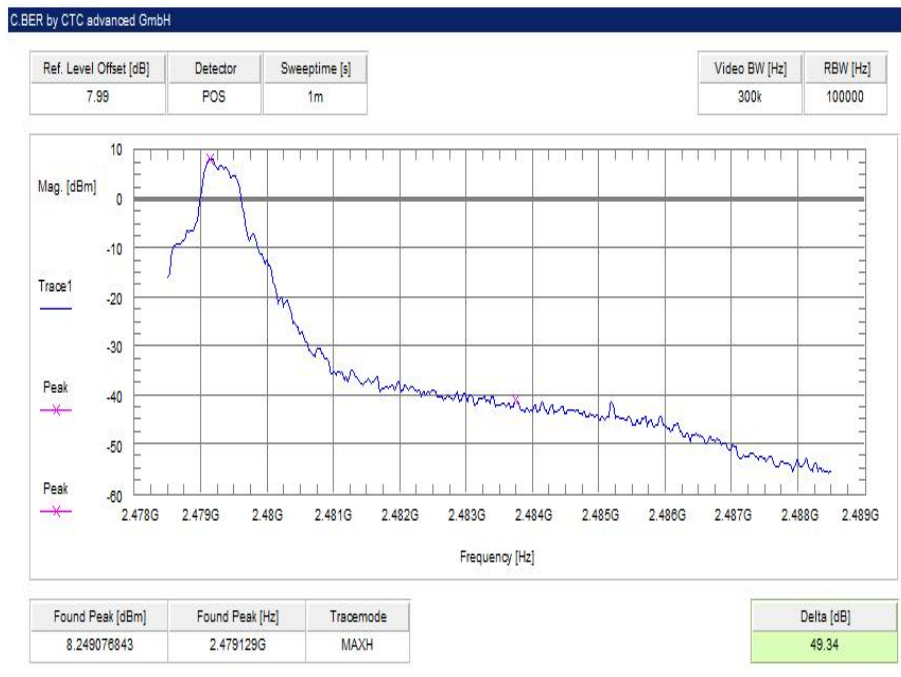

11.8 Band edge compliance radiated

Description:

Measurement of the radiated band edge compliance. The EUT is turned in the position that results in the maximum level at the band edge. Then a sweep over the corresponding restricted band is performed. The EUT is set to single channel mode and the transmit frequency is 2404.0 MHz for the lower restricted band and frequency 2479.3 MHz for the upper restricted band. Measurement distance is 3m.

Measurement parameters	
Detector	Peak / RMS
Sweep time	Auto
Resolution bandwidth	1 MHz
Video bandwidth	3 MHz
Span	Lower Band: 2370 – 2400 MHz Upper Band: 2480 – 2500 MHz
Trace mode	Max hold
Test setup	See sub clause 6.2 B
Measurement uncertainty	See sub clause 8

Limits:

FCC	IC
Band edge compliance radiated	
<p>In any 100 kHz bandwidth outside the frequency band in which the spread spectrum or digitally modulated intentional radiator is operating, the radio frequency power that is produced by the intentional radiator shall be at least 20 dB below that in the 100 kHz bandwidth within the band that contains the highest level of the desired power, based on either an RF conducted or a radiated measurement. Attenuation below the general limits specified in Section 15.209(a) is not required. In addition, radiated emissions which fall in the restricted bands, as defined in Section 15.205(a), must also comply with the radiated emission limits specified in Section 15.209(a) (see Section 5.205(c)).</p>	
54 dBµV/m AVG 74 dBµV/m Peak	

Results:

Scenario	Band edge compliance radiated [dB μ V/m]
Modulation	MSK
Lower restricted band	62.4 (peak) 17.2* (AVG)
Upper restricted band	65.9 (peak) 17.7* (AVG)

*Average correction factor:

$$F = 20 * \log (\text{dwell time}^* / 100 \text{ ms})$$

*with Txon time as dwell time!

The maximum dwell time (see Chapter 11.4) is 0.55 ms.

In a period of 100 ms, we have a maximum of 1 transmission and that implies a correction factor for spurious measurement emissions:

$$F = 20 * \log (1 * 0.55 / 100) = -45.2 \text{ dB}$$

Plots:

Plot 1: Lower band edge, vertical & horizontal polarization, 18 dBm power setting

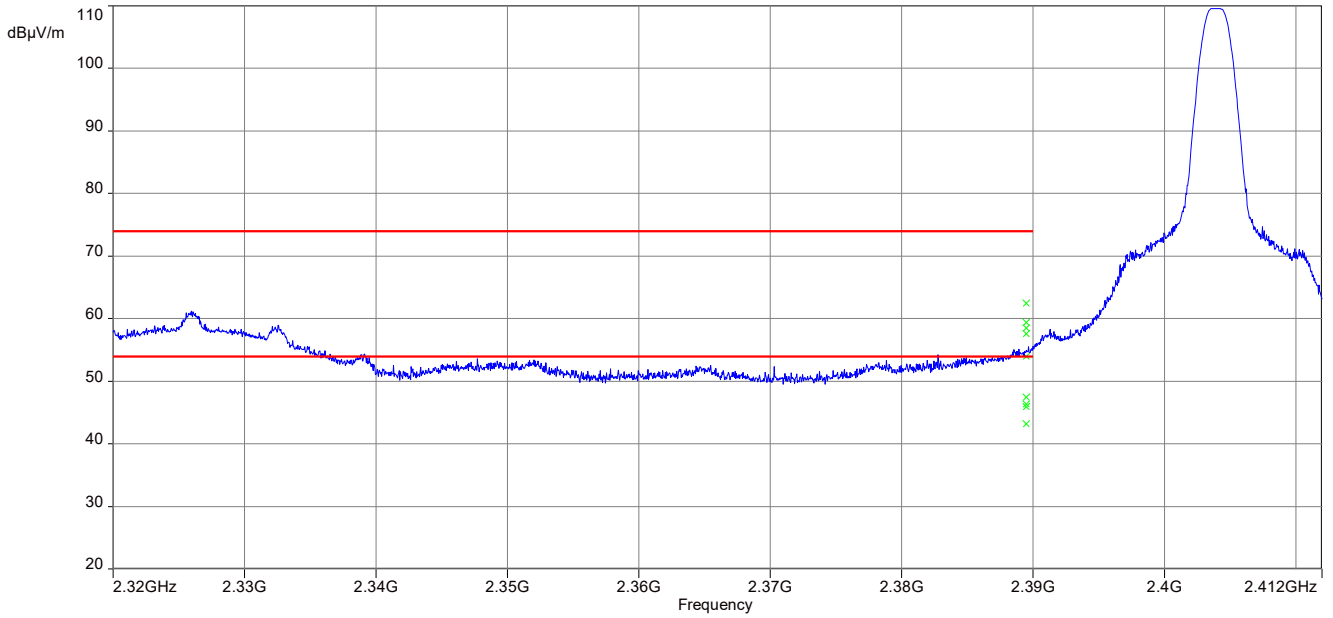

Plot 2: Upper band edge, vertical & horizontal polarization, 6 dBm power setting

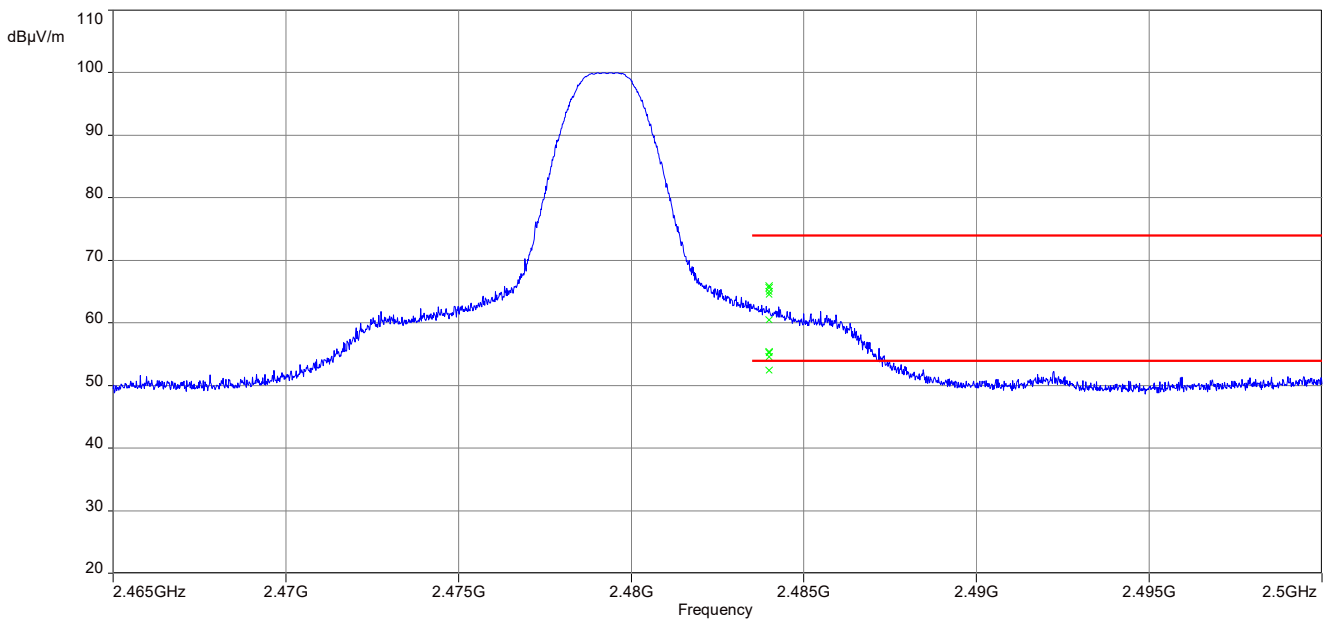

11.9 Spurious emissions conducted

Description:

Measurement of the conducted spurious emissions in transmit mode. The EUT is set to single channel mode.

Measurement parameters	
Detector	Peak
Sweep time	Auto
Resolution bandwidth	100 kHz
Video bandwidth	300 kHz
Span	9 kHz to 25 GHz
Trace mode	Max hold
Test setup	See sub clause 6.4 A
Measurement uncertainty	See sub clause 8

Limits:

FCC	IC
TX spurious emissions conducted	
<p>In any 100 kHz bandwidth outside the frequency band in which the spread spectrum or digitally modulated intentional radiator is operating, the radio frequency power that is produced by the intentional radiator shall be at least 20 dB below that in the 100 kHz bandwidth within the band that contains the highest level of the desired power, based on either an RF conducted or a radiated measurement. Attenuation below the general limits specified in Section 15.209(a) is not required</p>	

Results:

TX spurious emissions conducted					
f [MHz]		amplitude of emission [dBm]	limit max. allowed emission power	actual attenuation below frequency of operation [dB]	results
2404.0		18.9	30 dBm		Operating frequency
All detected emissions are below the -20 dBc criteria. Please take a look at the plot!			-20 dBc		compliant
2427.0		18.7	30 dBm		Operating frequency
All detected emissions are below the -20 dBc criteria. Please take a look at the plot!			-20 dBc		compliant
2479.3		7.9	30 dBm		Operating frequency
All detected emissions are below the -20 dBc criteria. Please take a look at the plot!			-20 dBc		compliant

Plots:

Plot 1: lowest channel – 2404.0 MHz

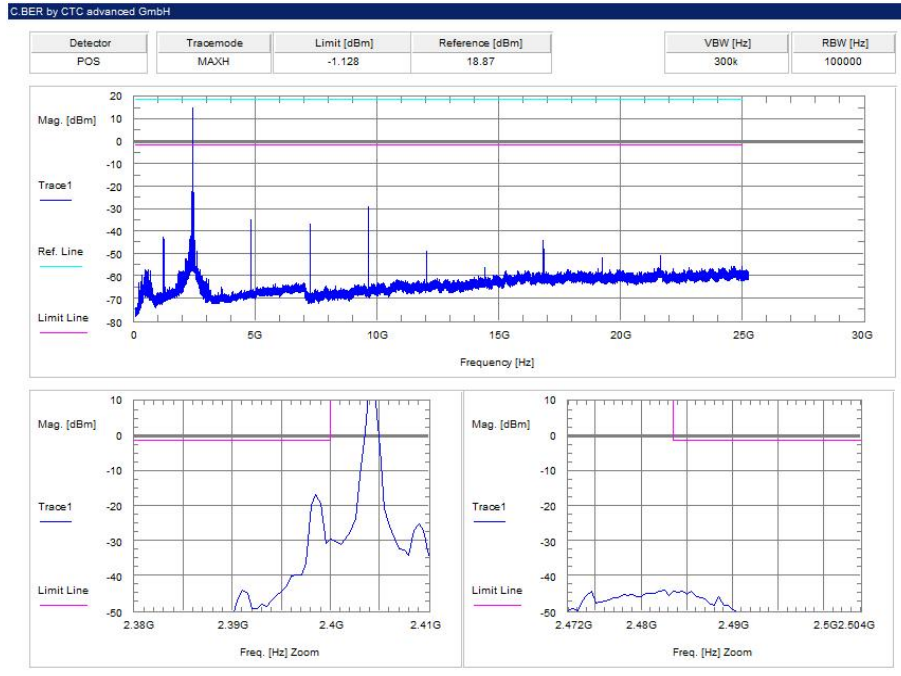

Plot 2: middle channel – 2427.0 MHz

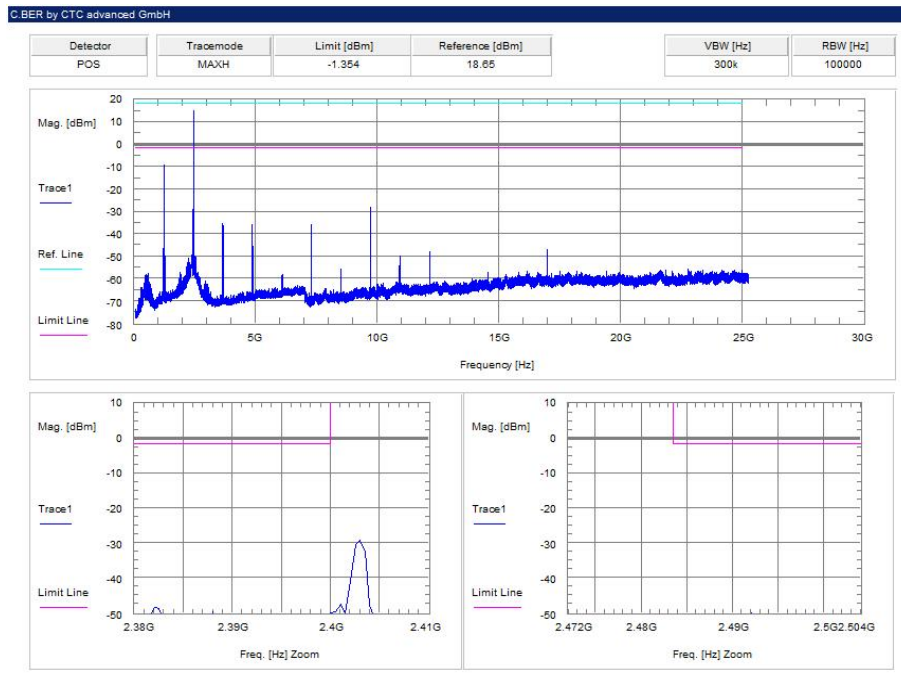

Plot 3: highest channel – 2479.3 MHz

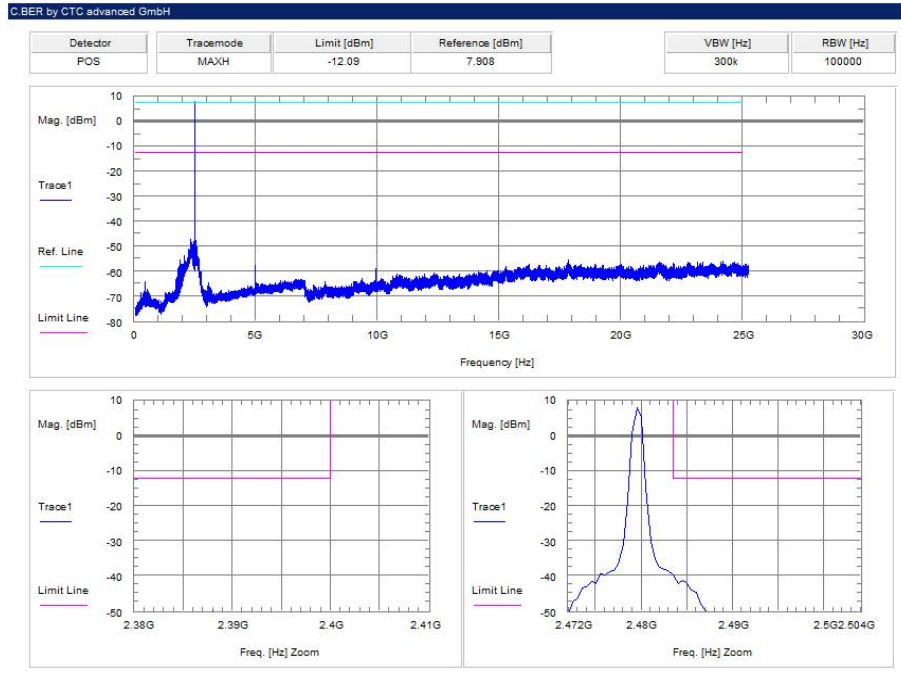

11.10 Spurious emissions radiated below 30 MHz

Description:

Measurement of the radiated spurious emissions in transmit mode below 30 MHz. The EUT is set to single channel mode. The limits are recalculated to a measurement distance of 3 m according the ANSI C63.10.

Measurement parameters	
Detector	Peak / Quasi peak
Sweep time	Auto
Resolution bandwidth	F < 150 kHz: 200 Hz F > 150 kHz: 9 kHz
Video bandwidth	F < 150 kHz: 1 kHz F > 150 kHz: 100 kHz
Span	9 kHz to 30 MHz
Trace mode	Max hold
Test setup	See sub clause 6.2 C
Measurement uncertainty	See sub clause 8

Limits:

FCC		IC
TX spurious emissions radiated below 30 MHz		
Frequency (MHz)	Field strength (dBµV/m)	Measurement distance
0.009 – 0.490	2400/F(kHz)	300
0.490 – 1.705	24000/F(kHz)	30
1.705 – 30.0	30	30

Results:

TX spurious emissions radiated below 30 MHz [dBµV/m]		
F [MHz]	Detector	Level [dBµV/m]
All detected emissions are more than 20 dB below the limit.		

Plots:

Plot 1: 9 kHz to 30 MHz, 2404.0 MHz, transmit mode

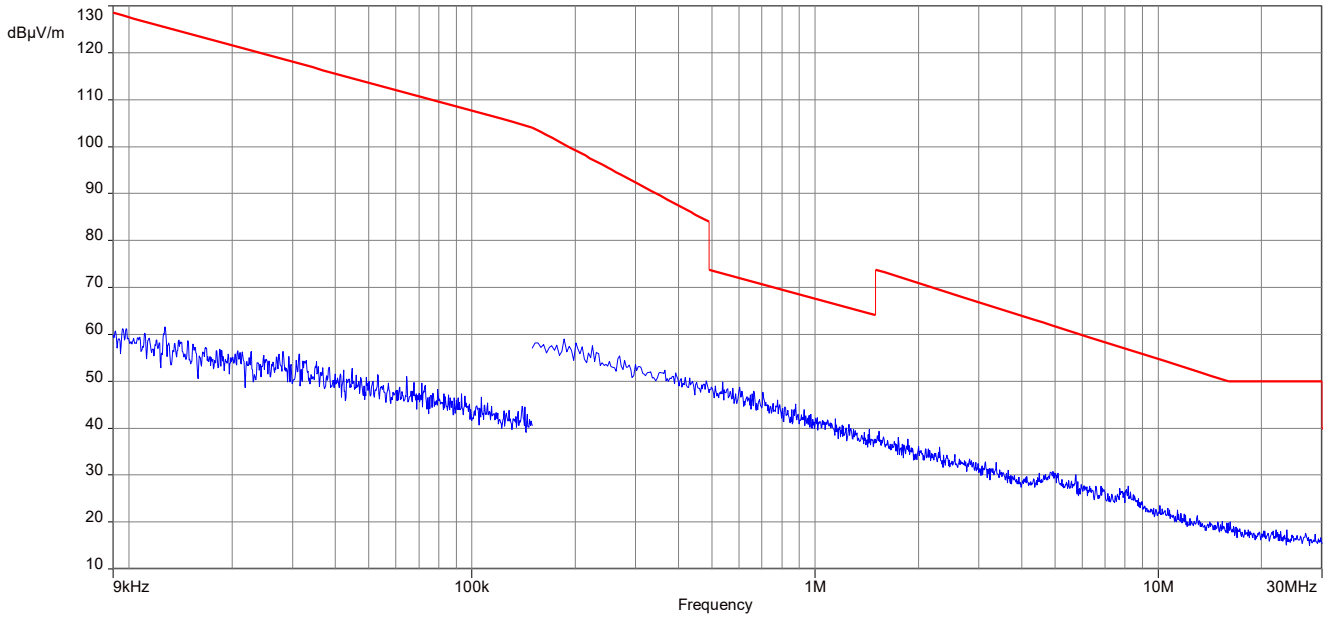

Plot 2: 9 kHz to 30 MHz, 2427.0 MHz, transmit mode

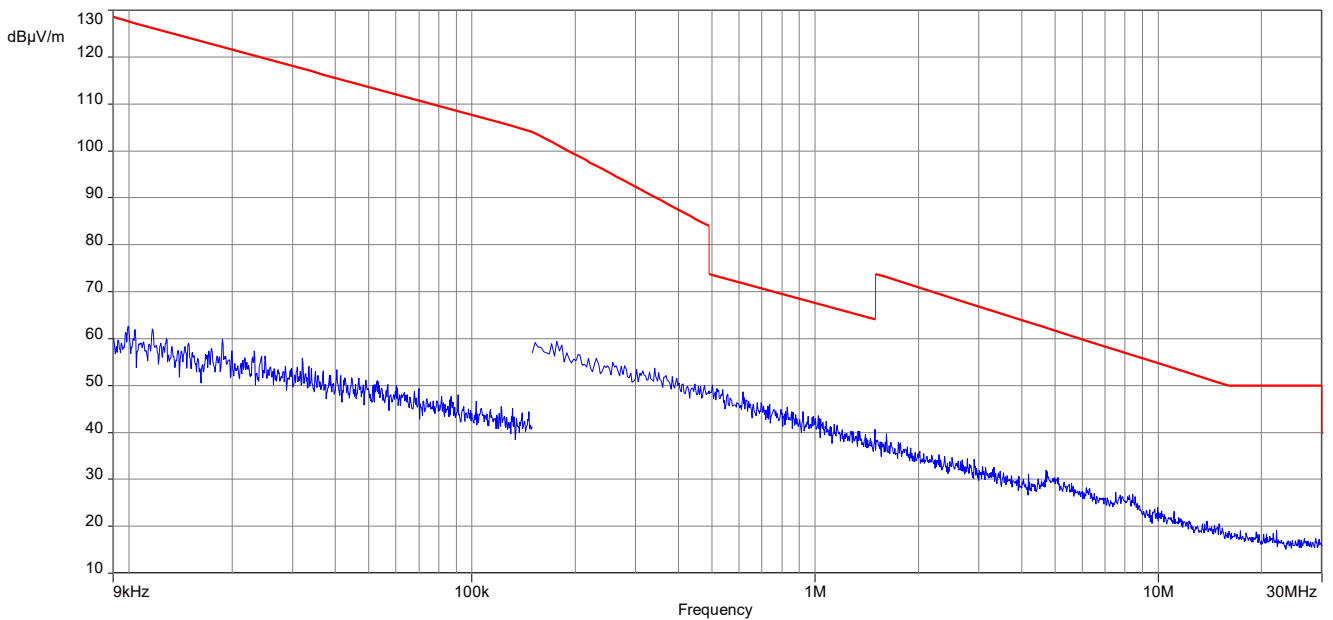

Plot 3: 9 kHz to 30 MHz, 2479.3 MHz, transmit mode

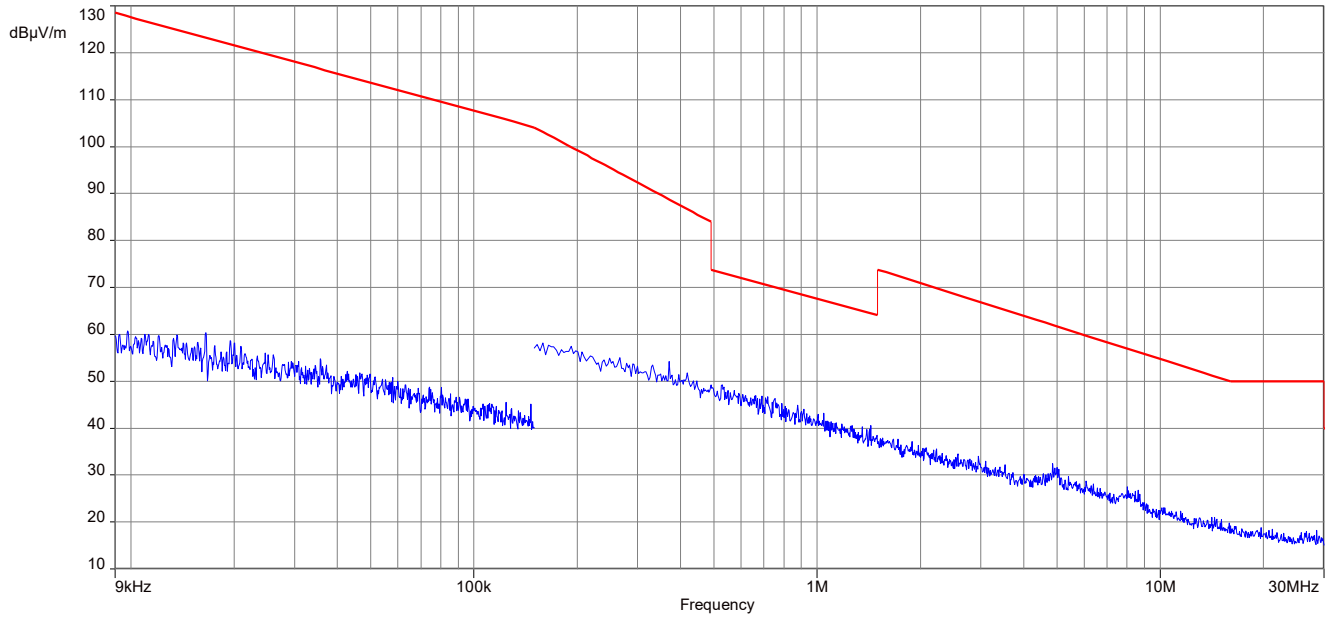

11.11 Spurious emissions radiated 30 MHz to 1 GHz

Description:

Measurement of the radiated spurious emissions in transmit mode. The EUT is set to single channel mode.

Measurement parameters	
Detector	Peak / Quasi Peak
Sweep time	Auto
Resolution bandwidth	3 x VBW
Video bandwidth	120 kHz
Span	30 MHz to 1 GHz
Trace mode	Max hold
Test setup	See sub clause 6.1 A
Measurement uncertainty	See sub clause 8

Limits:

FCC		IC	
TX spurious emissions radiated			
In any 100 kHz bandwidth outside the frequency band in which the spread spectrum or digitally modulated intentional radiator is operating, the radio frequency power that is produced by the intentional radiator shall be at least 20 dB below that in the 100 kHz bandwidth within the band that contains the highest level of the desired power, based on either an RF conducted or a radiated measurement. Attenuation below the general limits specified in Section 15.209(a) is not required. In addition, radiated emissions which fall in the restricted bands, as defined in §15.205(a), must also comply with the radiated emission limits specified in §15.209(a) (see §15.205(c)).			
§15.209			
Frequency (MHz)	Field strength (dBµV/m)	Measurement distance	
30 – 88	30.0	10	
88 – 216	33.5	10	
216 – 960	36.0	10	
Above 960	54.0	3	

Plots: Transmit mode

Plot 1: 30 MHz to 1 GHz, TX mode, 2404 MHz, vertical & horizontal polarization

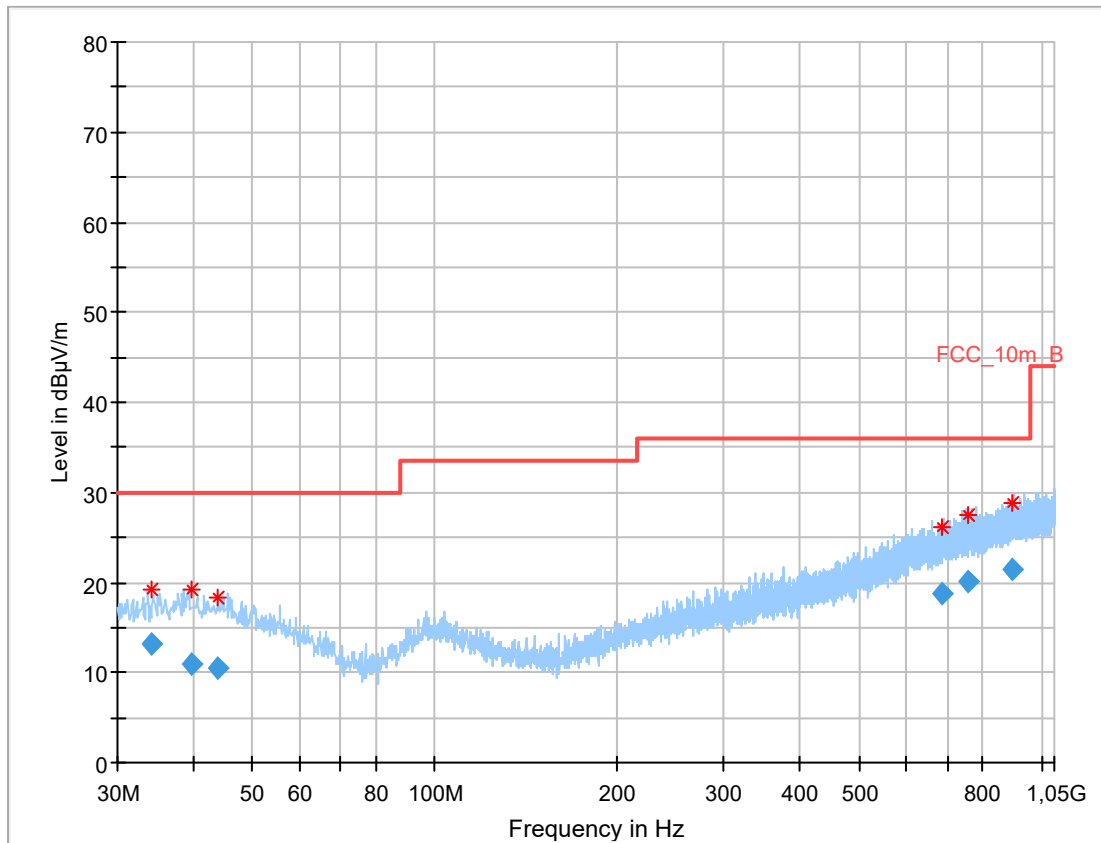

Final results:

Frequency (MHz)	QuasiPeak (dBµV/m)	Limit (dBµV/m)	Margin (dB)	Meas. Time (ms)	Bandwidth (kHz)	Height (cm)	Pol	Azimuth (deg)	Corr. (dB)
34.016700	13.25	30.00	16.75	1000.0	120.000	101.0	V	171.0	13.7
39.856200	10.96	30.00	19.04	1000.0	120.000	170.0	V	260.0	14.0
43.791750	10.40	30.00	19.60	1000.0	120.000	101.0	V	261.0	13.9
683.165400	18.88	36.00	17.12	1000.0	120.000	170.0	V	260.0	21.4
758.126400	20.15	36.00	15.85	1000.0	120.000	170.0	V	170.0	22.7
894.773550	21.37	36.00	14.63	1000.0	120.000	101.0	H	280.0	24.0

Plot 2: 30 MHz to 1 GHz, TX mode, 2427.0 MHz, vertical & horizontal polarization

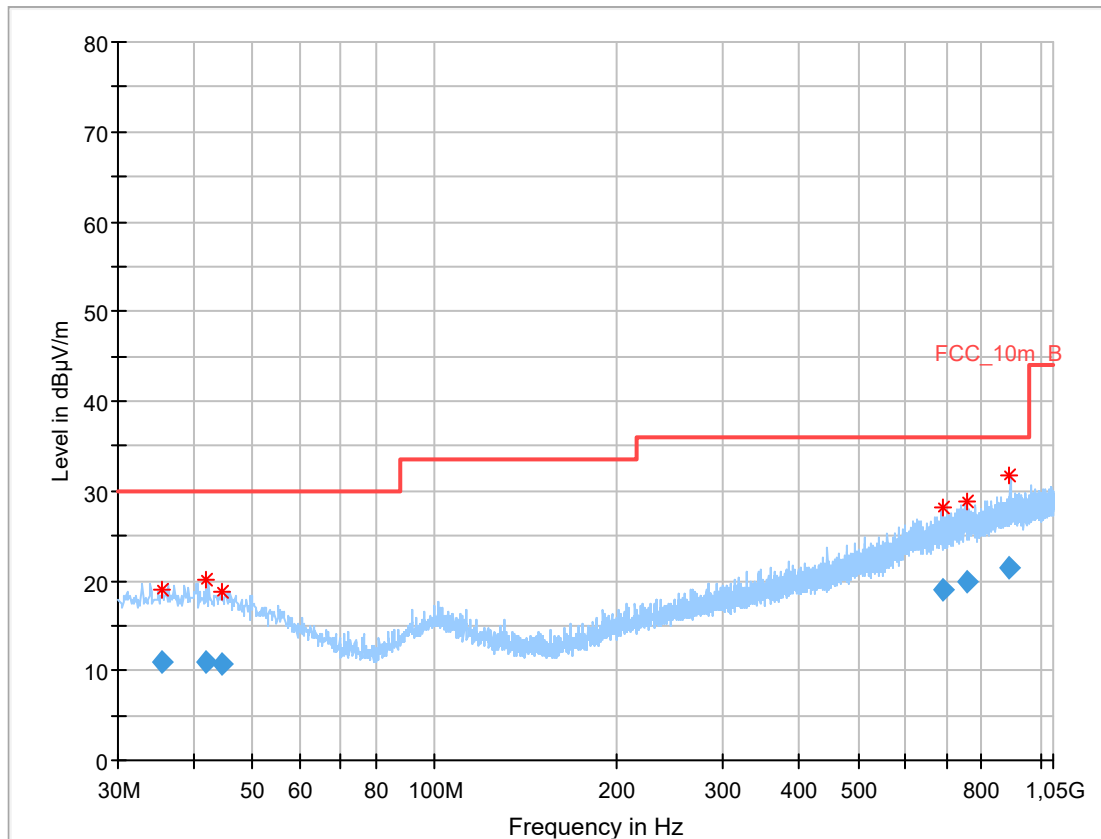

Final results:

Frequency (MHz)	QuasiPeak (dBµV/m)	Limit (dBµV/m)	Margin (dB)	Meas. Time (ms)	Bandwidth (kHz)	Height (cm)	Pol	Azimuth (deg)	Corr. (dB)
35.580750	10.91	30.00	19.09	1000.0	120.000	98.0	H	328.0	13.8
41.956950	11.05	30.00	18.95	1000.0	120.000	101.0	V	56.0	14.0
44.685900	10.68	30.00	19.32	1000.0	120.000	101.0	V	186.0	13.9
691.431450	18.94	36.00	17.06	1000.0	120.000	98.0	H	43.0	21.5
755.105400	19.99	36.00	16.01	1000.0	120.000	185.0	H	93.0	22.7
891.076800	21.37	36.00	14.63	1000.0	120.000	185.0	V	93.0	24.0

Plot 3: 30 MHz to 1 GHz, TX mode, 2479.3 MHz , vertical & horizontal polarization

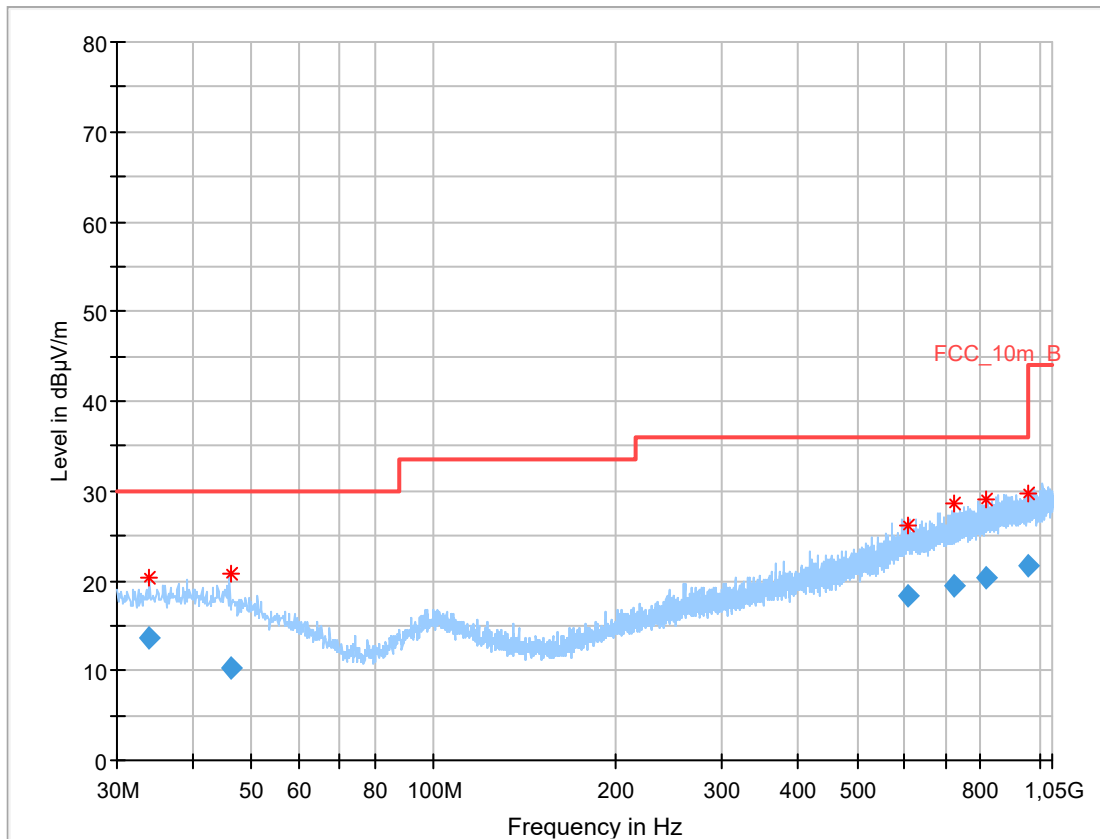

Final results:

Frequency (MHz)	QuasiPeak (dBµV/m)	Limit (dBµV/m)	Margin (dB)	Meas. Time (ms)	Bandwidth (kHz)	Height (cm)	Pol	Azimuth (deg)	Corr. (dB)
34.005300	13.57	30.00	16.43	1000.0	120.000	101.0	V	268.0	13.7
46.222200	10.17	30.00	19.83	1000.0	120.000	101.0	V	181.0	13.5
607.775400	18.24	36.00	17.76	1000.0	120.000	185.0	V	165.0	20.8
722.888100	19.52	36.00	16.48	1000.0	120.000	185.0	V	264.0	22.1
816.595650	20.38	36.00	15.62	1000.0	120.000	185.0	V	143.0	23.0
957.847800	21.58	36.00	14.42	1000.0	120.000	101.0	H	257.0	24.3

Plots: Receiver mode

Plot 1: 30 MHz to 1 GHz, RX / idle – mode, vertical & horizontal polarization

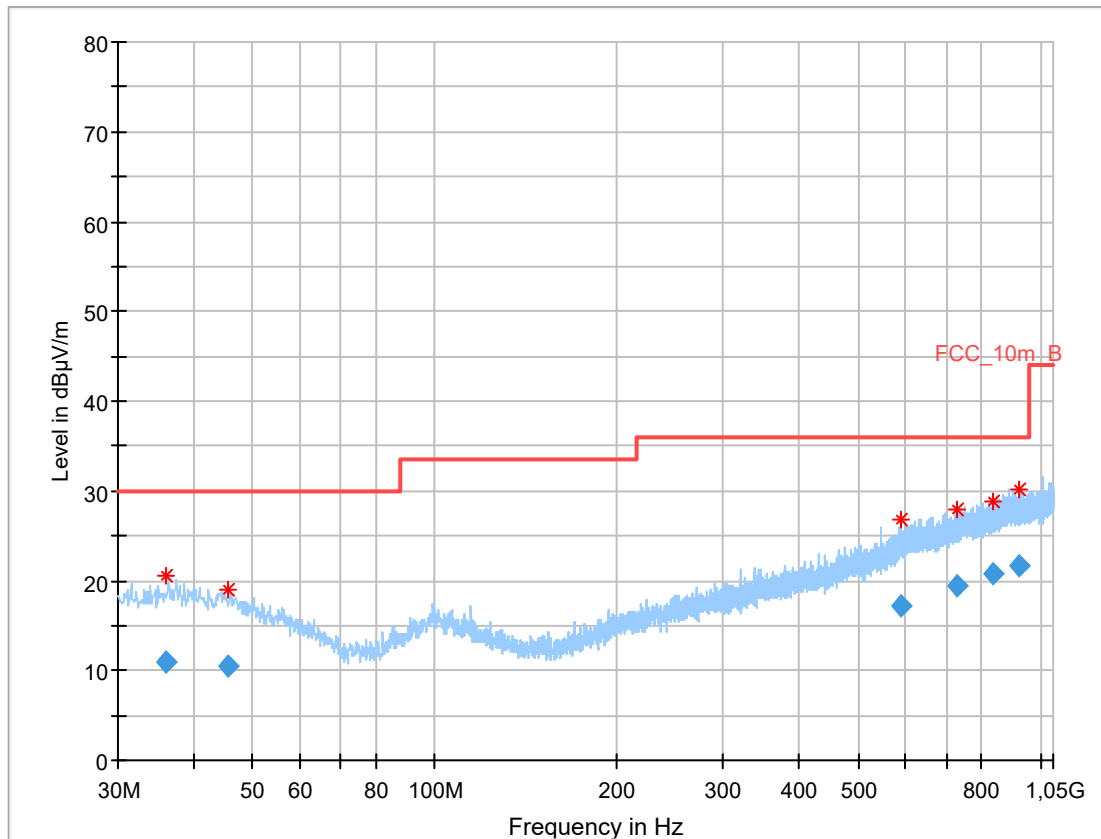

Final results:

Frequency (MHz)	QuasiPeak (dBµV/m)	Limit (dBµV/m)	Margin (dB)	Meas. Time (ms)	Bandwidth (kHz)	Height (cm)	Pol	Azimuth (deg)	Corr. (dB)
36.036750	11.04	30.00	18.96	1000.0	120.000	98.0	H	0.0	13.8
45.689550	10.51	30.00	19.49	1000.0	120.000	185.0	H	353.0	13.7
590.370750	17.31	36.00	18.69	1000.0	120.000	185.0	V	174.0	20.4
725.875800	19.54	36.00	16.46	1000.0	120.000	98.0	V	121.0	22.1
836.488050	20.70	36.00	15.30	1000.0	120.000	100.0	H	272.0	23.3
920.521500	21.57	36.00	14.43	1000.0	120.000	185.0	H	109.0	24.2

11.12 Spurious emissions radiated above 1 GHz

Description:

Measurement of the radiated spurious emissions in transmit mode. The EUT is set to single channel mode.

Measurement parameters	
Detector	Peak / RMS
Sweep time	Auto
Resolution bandwidth	1 MHz
Video bandwidth	3 x RBW
Span	1 GHz to 26 GHz
Trace mode	Max hold
Test setup	See sub clause 6.2 A (1 GHz – 18 GHz) See sub clause 6.3 A (18 GHz – 26 GHz)
Measurement uncertainty	See sub clause 8

Limits:

FCC		IC	
TX spurious emissions radiated			
In any 100 kHz bandwidth outside the frequency band in which the spread spectrum or digitally modulated intentional radiator is operating, the radio frequency power that is produced by the intentional radiator shall be at least 20 dB below that in the 100 kHz bandwidth within the band that contains the highest level of the desired power, based on either an RF conducted or a radiated measurement. Attenuation below the general limits specified in Section 15.209(a) is not required. In addition, radiated emissions which fall in the restricted bands, as defined in §15.205(a), must also comply with the radiated emission limits specified in §15.209(a) (see §15.205(c)).			
§15.209			
Frequency (MHz)	Field strength (dBµV/m)	Measurement distance	
Above 960	54.0	3	

Results: Transmitter mode

TX spurious emissions radiated [dBµV/m]								
2404.0 MHz			2427.0 MHz			2479.3 MHz		
F [MHz]	Detector	Level [dBµV/m]	F [MHz]	Detector	Level [dBµV/m]	F [MHz]	Detector	Level [dBµV/m]
2247	Peak	58.1	2271	Peak	57.6	2323	Peak	53.0
	AVG	53.6		AVG	46.5		AVG	43.7
4808	Peak	62.9	4954	Peak	60.7	4958	Peak	61.3
	AVG	17.7**		AVG	15.5**		AVG	16.1**
7212	Peak	*	7280	Peak	61.1	7437	Peak	64.3
	AVG			AVG	15.9**		AVG	19.1**
9616	Peak	*	9706	Peak	*	9916	Peak	*
	AVG			AVG			AVG	
12020	Peak	59.4	12134	Peak	55.7	12396	Peak	62.6
	AVG	14.2**		AVG	10.5**		AVG	17.4**
	Peak			Peak			Peak	
	AVG			AVG			AVG	

*Not rated because the emission frequency is not in a restricted band.

**Average correction factor:

$$F = 20 * \log (\text{dwell time}^* / 100 \text{ ms})$$

*with Txon time as dwell time!

The maximum dwell time (see Chapter 11.4) is 0.55 ms.

In a period of 100 ms, we have a maximum of 1 transmission and that implies a correction factor for spurious measurement emissions:

$$F = 20 * \log (1 * 0.55 / 100) = -45.2 \text{ dB}$$

Results: Receiver mode

RX spurious emissions radiated [dBµV/m]		
F [MHz]	Detector	Level [dBµV/m]
4960	Peak	51.0
	AVG	44.2

Note: The limit was recalculated with 20 dB / decade (Part 15.31) for all radiated spurious emissions 30 MHz to 1 GHz from 3 meter limit to a 10 meter distance. (40dB/decade for emissions < 30MHz)

Plot 3: 1 GHz to 18 GHz, TX mode, 2427.0 MHz, vertical & horizontal polarization

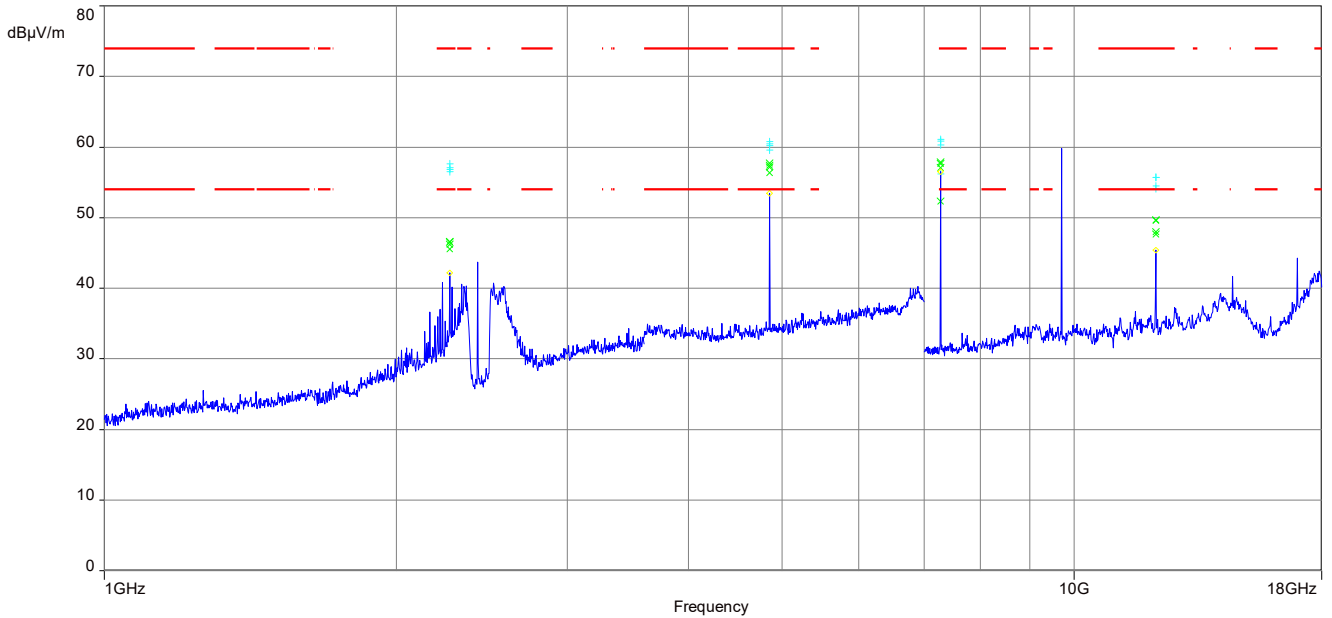

The carrier signal is notched with a 2.4 GHz band rejection filter.

Plot 4: 18 GHz to 26 GHz, TX mode, 2427.0 MHz, vertical & horizontal polarization

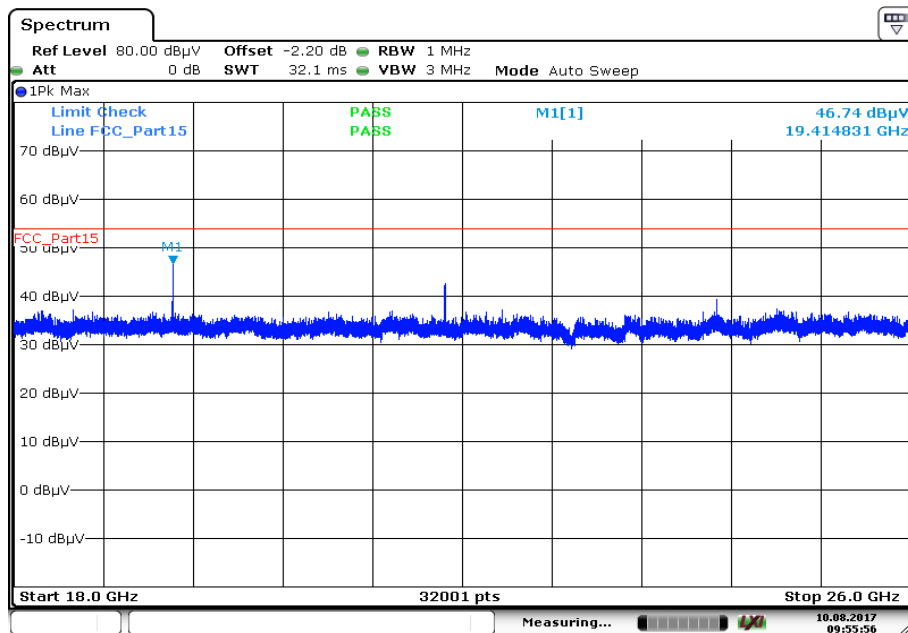

Date: 10.AUG.2017 09:55:56

Plot 5: 1 GHz to 18 GHz, TX mode, 2479.3 MHz, vertical & horizontal polarization

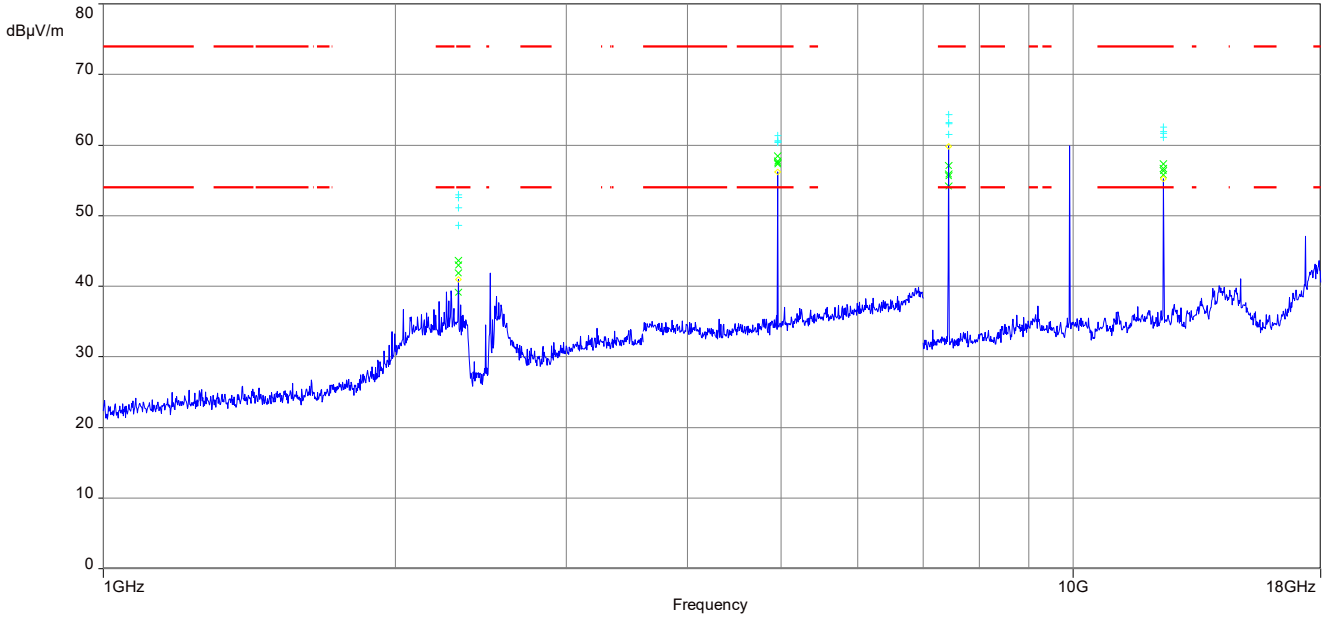

The carrier signal is notched with a 2.4 GHz band rejection filter.

Plot 6: 18 GHz to 26 GHz, TX mode, 2479.3 MHz, vertical & horizontal polarization

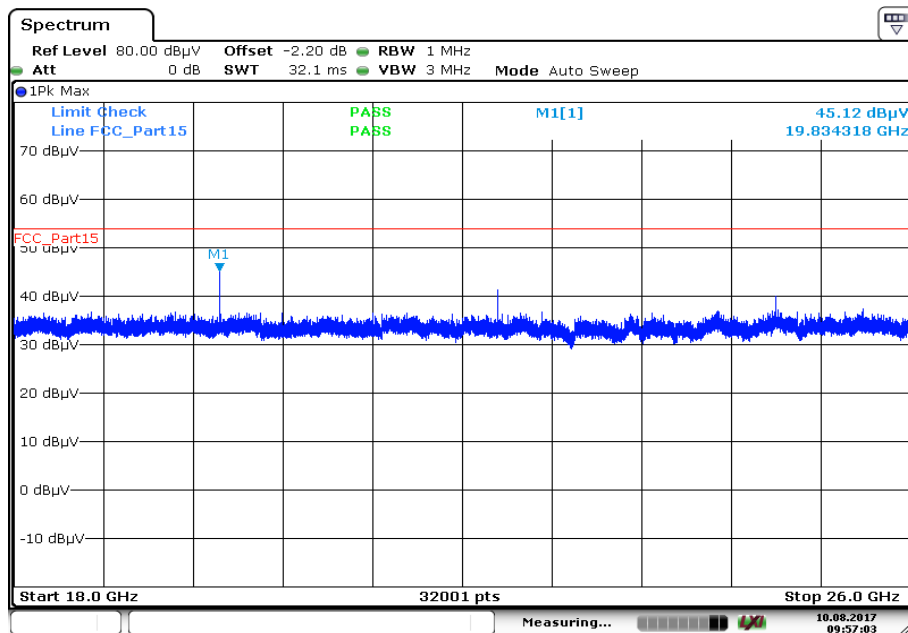

Date: 10.AUG.2017 09:57:02

Plots: Receiver mode

Plot 1: 1 GHz to 18 GHz, RX / idle – mode, vertical & horizontal polarization

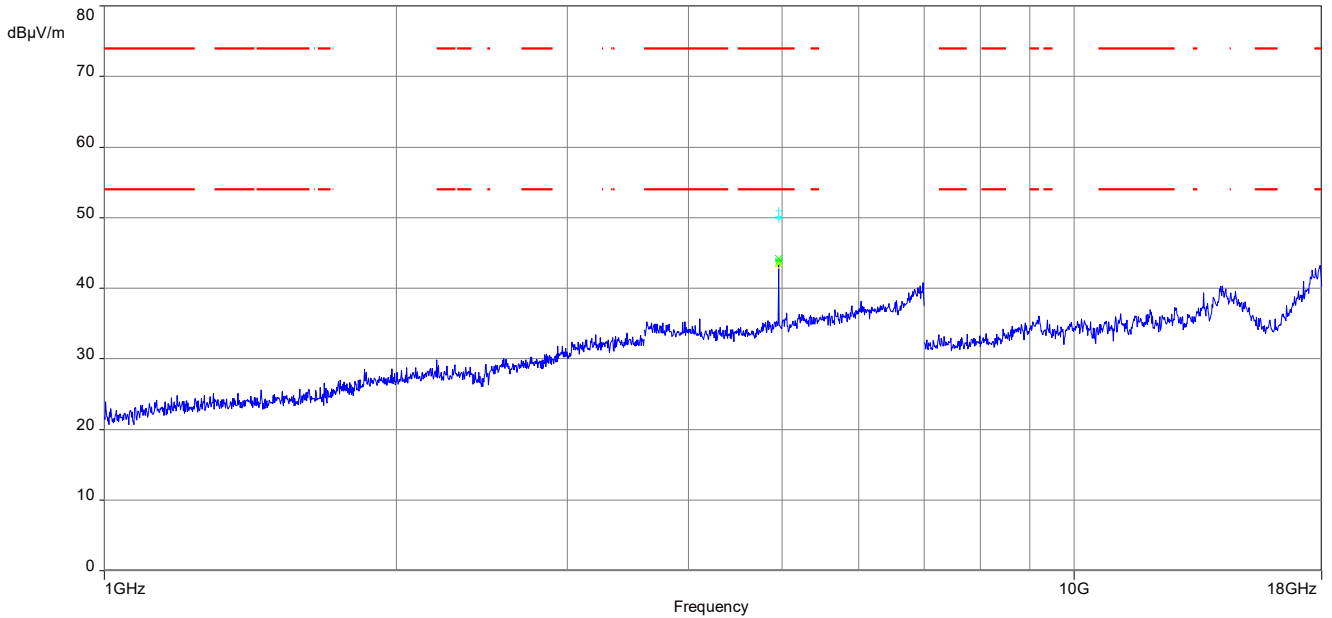

Plot 2: 18 GHz to 26 GHz, RX / idle – mode, vertical & horizontal polarization

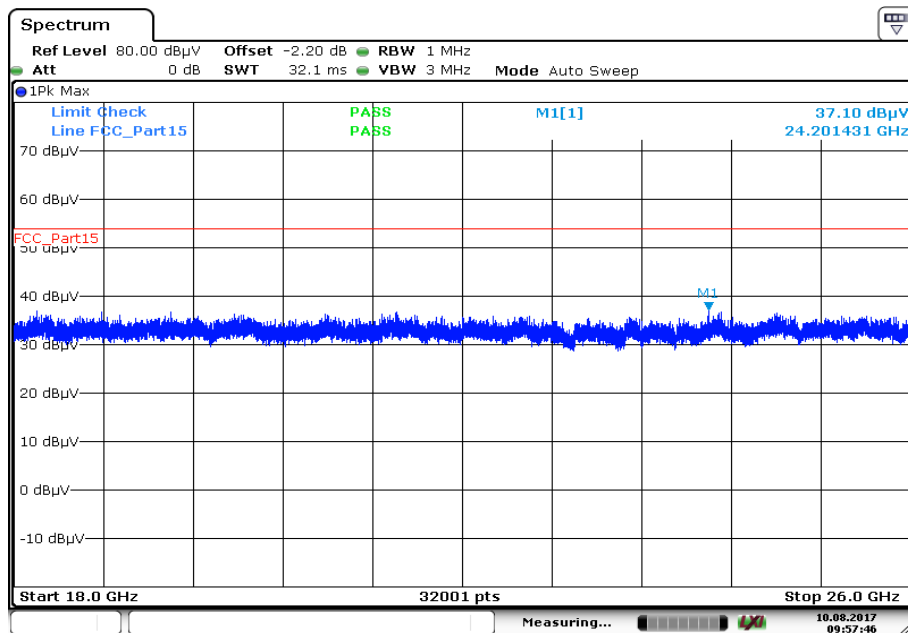

Date: 10.AUG.2017 09:57:46

11.13 Spurious emissions conducted below 30 MHz (AC conducted)

Description:

Measurement of the conducted spurious emissions in transmit mode below 30 MHz. The EUT is set to single channel mode and the transmit channel is channel 39. This measurement is representative for all channels and modes. If critical peaks are found channel 00 and channel 78 will be measured too. The measurement is performed in the mode with the highest output power. Both power lines, phase and neutral line, are measured. Found peaks are remeasured with average and quasi peak detection to show compliance to the limits.

Measurement parameters	
Detector	Peak - Quasi peak / average
Sweep time	Auto
Resolution bandwidth	F < 150 kHz: 200 Hz F > 150 kHz: 9 kHz
Video bandwidth	F < 150 kHz: 1 kHz F > 150 kHz: 100 kHz
Span	9 kHz to 30 MHz
Trace mode	Max hold
Test setup	See sub clause 6.5. A
Measurement uncertainty	See sub clause 8

Limits:

FCC		IC	
TX spurious emissions conducted < 30 MHz			
Frequency (MHz)	Quasi-peak (dBµV/m)	Average (dBµV/m)	
0.15 – 0.5	66 to 56*	56 to 46*	
0.5 – 5	56	46	
5 – 30.0	60	50	

*Decreases with the logarithm of the frequency

Results:

Spurious emissions conducted < 30 MHz [dBµV/m]		
F [MHz]	Detector	Level [dBµV/m]
No emissions detected		

Plots:

Plot 1: 150 kHz to 30 MHz, phase line

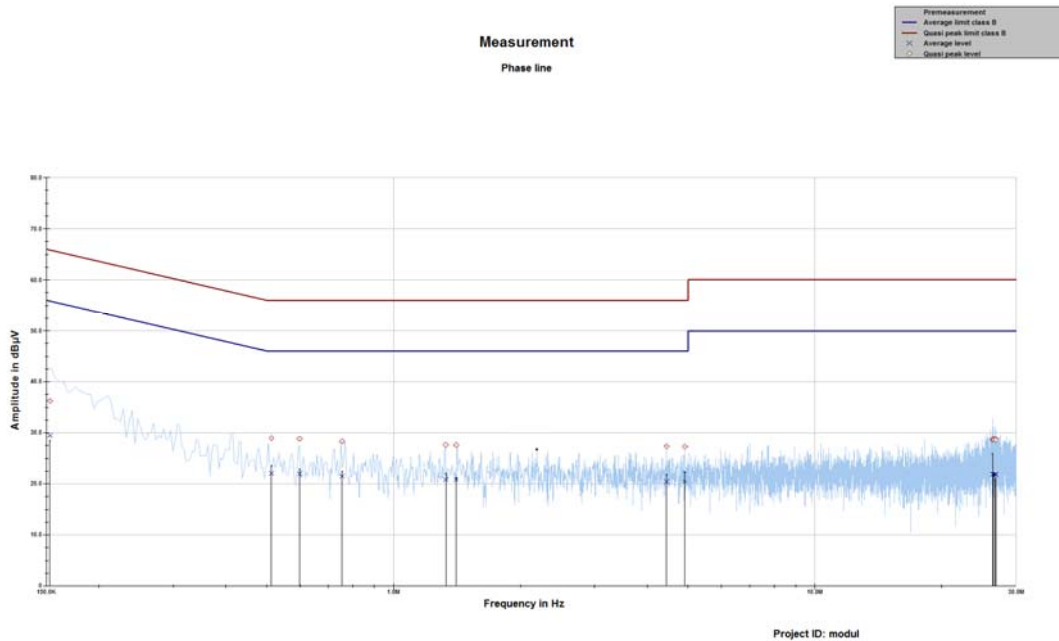

Final results:

Frequency MHz	Quasi peak level dBµV	Margin quasi peak dB	Limit QP dBµV	Average level dBµV	Margin average dB	Limit AV dBµV
0.152919	36.26	29.58	65.840	29.48	26.44	55.917
0.513228	28.94	27.06	56.000	22.06	23.94	46.000
0.598676	28.83	27.17	56.000	21.98	24.02	46.000
0.754911	28.31	27.69	56.000	21.51	24.49	46.000
1.329878	27.66	28.34	56.000	20.83	25.17	46.000
1.407881	27.61	28.39	56.000	20.78	25.22	46.000
4.445538	27.37	28.63	56.000	20.44	25.56	46.000
4.908934	27.28	28.72	56.000	20.45	25.55	46.000
26.397614	28.71	31.29	60.000	21.87	28.13	50.000
26.504307	28.70	31.30	60.000	21.89	28.11	50.000
26.789251	28.82	31.18	60.000	21.87	28.13	50.000
26.853209	28.63	31.37	60.000	21.85	28.15	50.000

Plot 2: 150 kHz to 30 MHz, neutral line

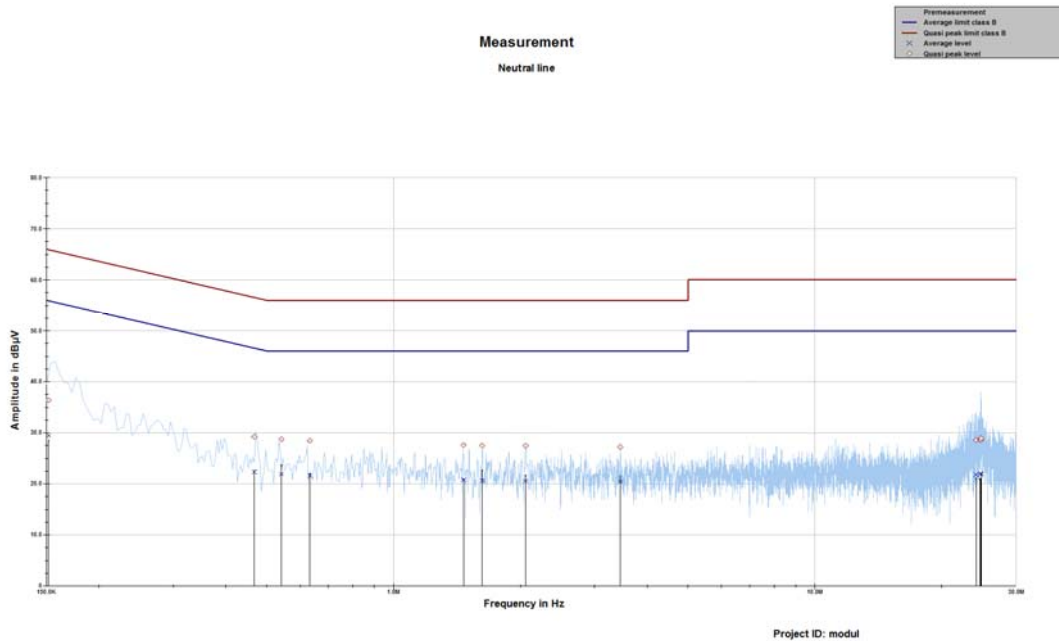

Final results:

Frequency MHz	Quasi peak level dBµV	Margin quasi peak dB	Limit QP dBµV	Average level dBµV	Margin average dB	Limit AV dBµV
0.151722	36.36	29.55	65.905	29.45	26.50	55.951
0.467075	29.21	27.35	56.566	22.35	24.59	46.941
0.541767	28.75	27.25	56.000	21.90	24.10	46.000
0.633190	28.45	27.55	56.000	21.66	24.34	46.000
1.464873	27.62	28.38	56.000	20.76	25.24	46.000
1.623304	27.49	28.51	56.000	20.68	25.32	46.000
2.058110	27.46	28.54	56.000	20.55	25.45	46.000
3.451067	27.23	28.77	56.000	20.45	25.55	46.000
24.114746	28.58	31.42	60.000	21.78	28.22	50.000
24.625695	28.72	31.28	60.000	21.83	28.17	50.000
24.754864	28.60	31.40	60.000	21.98	28.02	50.000
24.787585	28.92	31.08	60.000	21.99	28.01	50.000

12 Observations

No observations except those reported with the single test cases have been made.

Annex A Document history

Version	Applied changes	Date of release
	Initial release	2017-08-10
A	Model name, FCC ID and IC number changed	2017-09-07
B	HVIN changed	2017-09-12
C	Editorial changes	2017-09-25
D	AC conducted results added	2017-10-25
E	Editorial changes	2018-06-22
F	Editorial changes, 11.4 results updated	2018-07-03

Annex B Glossary

EUT	Equipment under test
DUT	Device under test
UUT	Unit under test
GUE	GNSS User Equipment
ETSI	European Telecommunications Standard Institute
EN	European Standard
FCC	Federal Communication Commission
FCC ID	Company Identifier at FCC
IC	Industry Canada
PMN	Product marketing name
HMN	Host marketing name
HVIN	Hardware version identification number
FVIN	Firmware version identification number
EMC	Electromagnetic Compatibility
HW	Hardware
SW	Software
Inv. No.	Inventory number
S/N or SN	Serial number
C	Compliant
NC	Not compliant
NA	Not applicable
NP	Not performed
PP	Positive peak
QP	Quasi peak
AVG	Average
OC	Operating channel
OCW	Operating channel bandwidth
OBW	Occupied bandwidth
OOB	Out of band
DFS	Dynamic frequency selection
CAC	Channel availability check
OP	Occupancy period
NOP	Non occupancy period
DC	Duty cycle
PER	Packet error rate
CW	Clean wave
MC	Modulated carrier
WLAN	Wireless local area network
RLAN	Radio local area network
DSSS	Dynamic sequence spread spectrum
OFDM	Orthogonal frequency division multiplexing
FHSS	Frequency hopping spread spectrum
GNSS	Global Navigation Satellite System
C/N₀	Carrier to noise-density ratio, expressed in dB-Hz

Annex C Accreditation Certificate

first page	last page			
 <p>Deutsche Akkreditierungsstelle GmbH</p> <p>Entrusted according to Section 8 subsection 1 AkkStelleG in connection with Section 1 subsection 1 AkkStelleGBV Signatory to the Multilateral Agreements of EA, ILAC and IAF for Mutual Recognition</p>  <p>Accreditation</p> <p>The Deutsche Akkreditierungsstelle GmbH attests that the testing laboratory CTC advanced GmbH Untertürkheimer Straße 6-10, 66117 Saarbrücken</p> <p>is competent under the terms of DIN EN ISO/IEC 17025:2005 to carry out tests in the following fields: Telecommunication</p> <p>The accreditation certificate shall only apply in connection with the notice of accreditation of 02.06.2017 with the accreditation number D-PL-12076-01 and is valid until 21.04.2021. It comprises the cover sheet, the reverse side of the cover sheet and the following annex with a total of 43 pages.</p> <p>Registration number of the certificate: D-PL-12076-01-03</p> <p>Frankfurt, 02.06.2017</p>  <p>Dipl.-Ing. (FH) Ralf Beyer Head of Division</p> <p>See www.dakks.de</p>	<p>Deutsche Akkreditierungsstelle GmbH</p> <table border="0"> <tr> <td>Office Berlin Spittelmarkt 10 10117 Berlin</td> <td>Office Frankfurt am Main Europa-Allee 52 60327 Frankfurt am Main</td> <td>Office Braunschweig Bundesallee 100 38116 Braunschweig</td> </tr> </table> <p>The publication of extracts of the accreditation certificate is subject to the prior written approval by Deutsche Akkreditierungsstelle GmbH (DAkkS). Exempted is the unchanged form of separate disseminations of the cover sheet by the conformity assessment body mentioned overleaf.</p> <p>No impression shall be made that the accreditation also extends to fields beyond the scope of accreditation attested by DAkkS.</p> <p>The accreditation was granted pursuant to the Act on the Accreditation Body (AkkStelleG) of 31 July 2009 (Federal Law Gazette I p. 2625) and the Regulation (EC) No 765/2008 of the European Parliament and of the Council of 9 July 2008 setting out the requirements for accreditation and market surveillance relating to the marketing of products (Official Journal of the European Union L 218 of 9 July 2008, p. 30). DAkkS is a signatory to the Multilateral Agreements for Mutual Recognition of the European co-operation for Accreditation (EA), International Accreditation Forum (IAF) and International Laboratory Accreditation Cooperation (ILAC). The signatories to these agreements recognise each other's accreditations.</p> <p>The up-to-date state of membership can be retrieved from the following websites: EA: www.european-accreditation.org ILAC: www.ilac.org IAF: www.iaf.nu</p>	Office Berlin Spittelmarkt 10 10117 Berlin	Office Frankfurt am Main Europa-Allee 52 60327 Frankfurt am Main	Office Braunschweig Bundesallee 100 38116 Braunschweig
Office Berlin Spittelmarkt 10 10117 Berlin	Office Frankfurt am Main Europa-Allee 52 60327 Frankfurt am Main	Office Braunschweig Bundesallee 100 38116 Braunschweig		

Note: The current certificate annex is published on the website (link see below) of the Accreditation Body DAkkS or may be received by CTC advanced GmbH on request

<https://www.dakks.de/as/ast/d/D-PL-12076-01-03e.pdf>