



Spectrum Research & Testing Lab., Inc.
No. 101-10, Ling 8,
Shan-Tong Li, Chung-Li
City, Taoyuan, Taiwan

TEST REPORT

Reference No.: A08092401
Report No.: FCCA08092401
FCC ID: W3Q-WL850R
Page: 1 of 73
Date: Nov. 27, 2008

Product Name: Gdium
Model No.: Liberty 1000
Applicant: Dexxon Data Media
79 av Louis Roche 92220 GENNEVILLIERS France
Date of Receipt: Sep. 24, 2008
Finished date of Test: Nov. 24, 2008
Applicable Standards: 47 CFR Part 15, Subpart C
ANSI C63.4: 2003

We, **Spectrum Research & Testing Laboratory Inc.**, hereby certify that one sample of the above was tested in our laboratory with positive results according to the above-mentioned standards. The records in the report are an accurate account of the results. Details of the results are given in the subsequent pages of this report.

Tested By : Wayne Lin , Date: 2008/11/27
(Wayne Lin)

Approved By : [Signature] , Date: 11/27/2008
(Johnson Ho, Director)



NVLAQ[®]

Lab Code: 200099-0
FMNG-059.10 REPORT



Table of Contents

| | | |
|-------|--|----|
| 1. | DOCUMENT POLICY AND TEST STATEMENT | 4 |
| 1.1 | DOCUMENT POLICY | 4 |
| 1.2 | TEST STATEMENT | 4 |
| 1.3 | EUT MODIFICATION | 4 |
| 2. | DESCRIPTION OF EUT AND TEST MODE | 5 |
| 2.1 | GENERAL DESCRIPTION OF EUT | 5 |
| 2.2 | DESCRIPTION OF EUT INTERNAL DEVICE | 6 |
| 2.3 | DESCRIPTION OF TEST MODE | 7 |
| 2.4 | DESCRIPTION OF SUPPORT UNIT | 7 |
| 3. | DESCRIPTION OF APPLIED STANDARDS | 7 |
| 4. | TECHNICAL CHARACTERISTICS TEST | 8 |
| 4.1 | CONDUCTED EMISSION TEST | 8 |
| 4.1.1 | LIMIT | 8 |
| 4.1.2 | TEST EQUIPMENT | 8 |
| 4.1.3 | TEST SETUP | 9 |
| 4.1.4 | TEST PROCEDURE | 9 |
| 4.1.5 | EUT OPERATING CONDITION | 9 |
| 4.1.6 | TEST RESULT | 10 |
| 4.2 | RADIATED EMISSION TEST | 18 |
| 4.2.1 | LIMIT | 18 |
| 4.2.2 | TEST EQUIPMENT | 19 |
| 4.2.3 | TEST SET-UP | 20 |
| 4.2.4 | TEST PROCEDURE | 20 |
| 4.2.5 | EUT OPERATING CONDITION | 20 |
| 4.2.6 | TEST RESULT | 21 |
| 4.3 | 6DB BANDWIDTH TEST | 35 |
| 4.3.1 | LIMIT | 35 |
| 4.3.2 | TEST EQUIPMENT | 35 |
| 4.3.3 | TEST SET-UP | 35 |
| 4.3.4 | TEST PROCEDURE | 35 |
| 4.3.5 | EUT OPERATING CONDITION | 35 |
| 4.3.6 | TEST RESULT | 36 |
| 4.4 | PEAK POWER TEST | 42 |
| 4.4.1 | LIMIT | 42 |
| 4.4.2 | TEST EQUIPMENT | 42 |
| 4.4.3 | TEST SET-UP | 43 |
| 4.4.4 | TEST PROCEDURE | 43 |
| 4.4.5 | EUT OPERATING CONDITION | 43 |
| 4.4.6 | TEST RESULT | 44 |
| 4.5 | BAND EDGE TEST | 50 |
| 4.5.1 | LIMIT | 50 |
| 4.5.2 | TEST EQUIPMENT | 51 |
| 4.5.3 | TEST SET-UP | 52 |
| 4.5.4 | TEST PROCEDURE | 53 |
| 4.5.5 | EUT OPERATING CONDITION | 53 |



Spectrum Research & Testing Lab., Inc.
No. 101-10, Ling 8,
Shan-Tong Li, Chung-Li
City, Taoyuan, Taiwan

TEST REPORT

Reference No.: A08092401
Report No.: FCCA08092401
FCC ID: W3Q-WL850R
Page: 3 of 73
Date: Nov. 27, 2008

| | |
|-------------------------------------|----|
| 4.5.6 TEST RESULT | 54 |
| 4.6 POWER DENSITY TEST | 60 |
| 4.6.1 LIMIT | 60 |
| 4.6.2 TEST EQUIPMENT | 60 |
| 4.6.3 TEST SET-UP | 60 |
| 4.6.4 TEST PROCEDURE | 60 |
| 4.6.5 EUT OPERATING CONDITION | 60 |
| 4.6.6 TEST RESULT | 61 |
| 5. ANTENNA APPLICATION | 67 |
| 5.1 ANTENNA REQUIREMENT | 67 |
| 5.2 RESULT | 67 |
| 6. PHOTOS OF TESTING | 68 |
| 7. TERMS OF ABBREVIATION | 73 |



**Spectrum Research &
Testing Lab., Inc.**
No. 101-10, Ling 8,
Shan-Tong Li, Chung-Li
City, Taoyuan, Taiwan

TEST REPORT

Reference No.: A08092401
Report No.: FCCA08092401
FCC ID: W3Q-WL850R
Page: 4 of 73
Date: Nov. 27, 2008

1. DOCUMENT POLICY AND TEST STATEMENT

1.1 DOCUMENT POLICY

- The report shall not be reproduced except in full, without the written approval of SRT Lab, Inc.
- The report must not be used by the client to claim product certification, approval, or endorsement by NVLAP, NIST, or any agency of the Federal Government.

1.2 TEST STATEMENT

- The test results in the report apply only to the unit tested by SRT Lab.
- There was no deviation from the requirements of test standards during the test.
- AC power source, 120 Vac/60 Hz, was used during the test.

1.3 EUT MODIFICATION

- No modification in SRT Lab.



2. DESCRIPTION OF EUT AND TEST MODE

2.1 GENERAL DESCRIPTION OF EUT

Wireless LAN Card :

| | |
|---------------------------------|---|
| PRODUCT | Gdium |
| MODEL NO. | Liberty 1000 |
| POWER SUPPLY | 3.3V DC form PCI interface |
| CABLE | N/A |
| FREQUENCY BAND | 2412 ~ 2462MHz |
| CARRIER FREQUENCY | 2412 ~ 2462MHz |
| NUMBER OF CHANNEL | 11 |
| CHANNEL SPACING | 5MHz |
| RATED RF OUTPUT POWER | 11 dBm |
| MODULATION TYPE | 802.11b: CCK,DQPSK and DBPSK 802.11g: OFDM |
| BIT RATE OF TRANSMISSION | 802.11g: 6,9,12,18,24,36,48,54Mbit/s 801.11b: 1,2,5.5,11Mbit/s |
| ANTENNA TYPE | 2.4G PIFA antenna |
| ANTENNA GAIN | 2 dBi |

Notebook:

| | |
|--------------------------|---|
| Taille de l'écran | 10" |
| Résolution | 1024 x 600 pixels |
| Processeur | 900 MHz 64bits Loongson™ 2F par STMicroelectronics |
| Carte Vidéo | Puce Silicon Motion SM502 avec 16Mo de mémoire |
| Mémoire vive | 512Mo DDR2 |
| Disque Dur (Amovible) | de 8Go à 16Go de mémoire sur clé usb G-Key |
| Clavier | clavier à touches douces |
| Webcam | 0,3Mpixels |
| Carte Réseau sans fil | WiFi 802.11 b/g |
| Carte Réseau | 10/100 Mbs LAN |
| Autonomie de la batterie | 4 heures / 5000 mAh |
| Lecteur de carte | cartes SD / SD HC |
| USB | 3 ports USB disponibles dont : 2 ports USB 2.0 standards et 1 port USB 2.0 dédié à la G-Key |
| Sortie VGA | 1 sortie VGA 15 broches D-sub avec une résolution sur écran externe de 1280x1024 pixels |
| Sortie Casque | 1 sortie casque pour prise jack de 3,5mm |
| Entrée Micro | 1 entrée pour prise jack micro de 3,5mm |
| Dimensions | 250 x 182 x 32mm |
| Poids | 1,2 kg |



Spectrum Research & Testing Lab., Inc.
No. 101-10, Ling 8,
Shan-Tong Li, Chung-Li
City, Taoyuan, Taiwan

TEST REPORT

Reference No.: A08092401
Report No.: FCCA08092401
FCC ID: W3Q-WL850R
Page: 6 of 73
Date: Nov. 27, 2008

NOTE :

For more detailed information, please refer to the EUT's specification or user's manual provided by manufacturer.

2.2 DESCRIPTION OF EUT INTERNAL DEVICE

| DEVICE | BRAND / MAKER | MODEL | FCC ID/DOC | REMARK |
|--------|---------------|-------|------------|--------|
| N/A | | | | |



2.3 DESCRIPTION OF TEST MODE

11 channels are provided by EUT of wireless. The 3 channels of lower, medium and higher were chosen for test.

There are test modes for each test configuration as below:

| Mode | Modulation Type | Channel | Frequency (MHz) |
|------|-----------------|---------|-----------------|
| 1 | IEEE 802.11g | CH1 | 2412 |
| 2 | | CH6 | 2437 |
| 3 | | CH11 | 2462 |
| 4 | IEEE 802.11b | CH1 | 2412 |
| 5 | | CH6 | 2437 |
| 6 | | CH11 | 2462 |

NOTE :

In Modulation Type : 802.11b: CCK, DQPSK and DBPSK were pre-tested in chamber. The CCK, worst case one, was chosen for conducted and radiated emission test.

2.4 DESCRIPTION OF SUPPORT UNIT

The EUT was configured by the requirement of ANSI C63.4:2003. All interface ports were connected to the appropriate support units via specific cables. The support units and cables are listed below.

| NO | DEVICE | BRAND | MODEL | FCC ID/ DOC | CABLE |
|----|-----------------------|--------|-----------|----------------|----------------------------|
| 1 | Wireless router | D-Link | DI-524 | KA2DI524G | 1.8m unshielded power cord |
| 2 | Wireless access point | D-Link | DWL-700AP | KA2DWL700AP-A2 | 1.8m unshielded power cord |
| 3 | USB Mouse | Tcstar | TCN125 | DOC | 1.4m unshielded data cord |

NOTE : For the actual test configuration, please refer to the photos of testing.

3. DESCRIPTION OF APPLIED STANDARDS

The EUT is a kind of wireless product. According to the specifications provided by the applicant, it must comply with the requirements of the following standards:

47 CFR Part 15, Subpart C
 ANSI C63.4: 2003

All tests have been performed and recorded as the above standards.



TEST REPORT

4. TECHNICAL CHARACTERISTICS TEST

4.1 CONDUCTED EMISSION TEST

4.1.1 LIMIT

| Frequency (MHz) | Class A (dB μ V) | | Class B (dB μ V) | |
|-----------------|----------------------|---------|----------------------|---------|
| | Quasi-peak | Average | Quasi-peak | Average |
| 0.15 - 0.5 | 79 | 66 | 66 - 56 | 56 - 46 |
| 0.50 - 5.0 | 73 | 60 | 56 | 46 |
| 5.0 - 30.0 | 73 | 60 | 60 | 50 |

NOTE :

1. The lower limit shall apply at the transition frequencies.
2. The limit decreases in line with the logarithm of the frequency in the range of 0.15 to 0.50 MHz.

4.1.2 TEST EQUIPMENT

The following test equipment was used for the test:

| EQUIPMENT/ FACILITIES | SPECIFICATIONS | MANUFACTURER | MODEL#/ SERIAL# | DUE DATE OF CAL. & CAL. CENTER |
|--------------------------|------------------------|--------------------|-----------------------------|-----------------------------------|
| EMI TEST RECEIVER | 9 kHz TO 30 MHz | ROHDE & SCHWARZ | ESHS30 / 826003/008 | SEP. 2009 ETC |
| LISN | 50 μ H, 50 ohm | FCC | FCC-LISN-50-25-2 / 01017 | OCT. 2009 ETC |
| LISN | 50 μ H, 50 ohm | FCC | 9252-50-R24-BNC / 951315 | JUN. 2009 ETC |
| 50 OHM TERMINATOR | 50 ohm | HP | 11593A / #2 | OCT. 2009 ETC |
| COAXIAL CABLE | 5M | TIMES | EQM-0159 / #5-5m | AUG. 2009 SRT |
| FILTER | 2 LINE, 30A | FIL.COIL | FC-943 / 771 | NCR |
| GROUND PLANE | 2.3M (H) x 2.4M (W) | SRT | N/A | NCR |
| GROUND PLANE | 2.4M (H) x 2.4M (W) | SRT | N/A | NCR |

NOTE: The calibration interval of the above test equipment is one year and the calibrations are traceable to NML/ROC and NIST/USA.

4.1.3 TEST SETUP

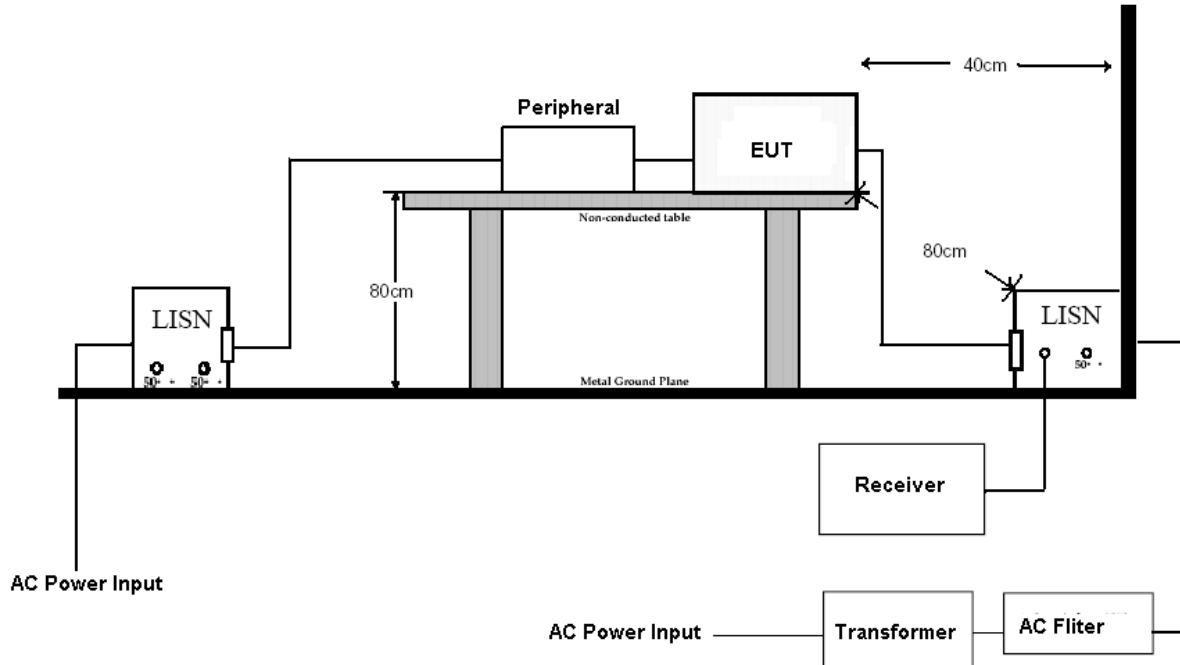

NOTE :

1. The EUT was put on a wooden table with 0.8m heights above ground plane, and 0.4m away from reference ground plane (> 2mx2m).
2. For the actual test configuration, please refer to the photos of testing.
3. The serial no. of the LISN connected to EUT is 01017.
4. The serial no. of the LISN connected to support units is 01018.

4.1.4 TEST PROCEDURE

The EUT was tested according to the requirement of ANSI C63.4:2003 and CISPR22:2003. The frequency spectrum from 0.15 MHz to 30 MHz was investigated. The LISN used was 50 ohm/50μH as specified. All readings were quasi-peak and average values with 10 kHz resolution bandwidth of the test receiver. The EUT system was operated in all typical methods by users. Both lines of the power mains of EUT were measured and the cables connected to EUT and support units were moved to find the maximum emission levels for each frequency.

First, find the margin or higher points at least 6 points by software, then use manual to find the maximum data. The procedure is referred on the test procedure of SRT LAB.

4.1.5 EUT OPERATING CONDITION

Under Linux ran "Ping" program connect with wireless router.



TEST REPORT

4.1.6 TEST RESULT

| | | | |
|--------------------|---------------|------------------|---------------|
| Temperature: | 23 °C | Humidity: | 55 %RH |
| Frequency Range: | 0.15 – 30 MHz | Tested Mode: | Link |
| Receiver Detector: | Q.P. and AV. | Modulation Type: | CCK |
| Tested By: | Wayne Lin | Tested Channel: | N/A |
| Antenna Type: | N/A | Tested Date: | Nov. 06, 2008 |

Power Line Measured : Line

| Freq. (MHz) | Correct. Factor (dB) | Reading Value (dB μ V) | | Emission Level (dB μ V) | | Limit (dB μ V) | | Margin (dB) | |
|-------------|----------------------|----------------------------|-------|-----------------------------|-------|--------------------|-------|-------------|--------|
| | | Q.P. | AV. | Q.P. | AV. | Q.P. | AV. | Q.P. | AV. |
| 0.498 | 0.25 | 40.34 | 26.38 | 40.59 | 26.63 | 56.02 | 46.02 | -15.43 | -19.39 |
| 0.501 | 0.24 | 40.04 | 26.66 | 40.28 | 26.90 | 56.00 | 46.00 | -15.72 | -19.10 |
| 0.514 | 0.24 | 39.76 | 26.20 | 40.00 | 26.44 | 56.00 | 46.00 | -16.00 | -19.56 |
| 1.428 | 0.15 | 38.50 | 30.16 | 38.65 | 30.31 | 56.00 | 46.00 | -17.35 | -15.69 |
| 1.586 | 0.15 | 38.58 | 30.80 | 38.73 | 30.95 | 56.00 | 46.00 | -17.27 | -15.05 |
| 5.071 | 0.22 | 37.82 | 32.01 | 38.04 | 32.23 | 60.00 | 50.00 | -21.96 | -17.77 |

Power Line Measured : Neutral

| Freq. (MHz) | Correct. Factor (dB) | Reading Value (dB μ V) | | Emission Level (dB μ V) | | Limit (dB μ V) | | Margin (dB) | |
|-------------|----------------------|----------------------------|-------|-----------------------------|-------|--------------------|-------|-------------|--------|
| | | Q.P. | AV. | Q.P. | AV. | Q.P. | AV. | Q.P. | AV. |
| 0.204 | 0.28 | 47.38 | 29.59 | 47.66 | 29.87 | 63.43 | 53.43 | -15.77 | -23.56 |
| 0.500 | 0.24 | 40.32 | 26.24 | 40.56 | 26.48 | 55.98 | 45.98 | -15.43 | -19.51 |
| 0.501 | 0.24 | 40.06 | 26.24 | 40.30 | 26.48 | 56.00 | 46.00 | -15.70 | -19.52 |
| 1.210 | 0.14 | 38.84 | 28.20 | 38.98 | 28.34 | 56.00 | 46.00 | -17.02 | -17.66 |
| 1.705 | 0.15 | 38.52 | 30.63 | 38.67 | 30.78 | 56.00 | 46.00 | -17.33 | -15.22 |
| 5.183 | 0.22 | 36.22 | 29.64 | 36.44 | 29.86 | 60.00 | 50.00 | -23.56 | -20.14 |

NOTE :

1. Measurement uncertainty is +/- 2dB
2. Emission level = Reading value + Correction factor
3. Correction Factor = Cable loss + Insertion loss of LISN
4. Margin value = Emission level - Limit
5. The emission of other frequencies was very low against the limit.
6. "-": The Quasi-peak reading value also meets average limit and measurement with the average detector is unnecessary.



| | | | |
|--------------------|---------------|------------------|---------------|
| Temperature: | 23 °C | Humidity: | 55 %RH |
| Frequency Range: | 0.15 – 30 MHz | Tested Mode: | Standby |
| Receiver Detector: | Q.P. and AV. | Modulation Type: | CCK |
| Tested By: | Wayne Lin | Tested Channel: | N/A |
| Antenna Type: | N/A | Tested Date: | Nov. 06, 2008 |

Power Line Measured : Line

| Freq. (MHz) | Correct. Factor (dB) | Reading Value (dB μ V) | | Emission Level (dB μ V) | | Limit (dB μ V) | | Margin (dB) | |
|-------------|----------------------|----------------------------|-------|-----------------------------|-------|--------------------|-------|-------------|--------|
| | | Q.P. | AV. | Q.P. | AV. | Q.P. | AV. | Q.P. | AV. |
| 0.492 | 0.25 | 39.74 | 26.00 | 39.99 | 26.25 | 56.12 | 46.12 | -16.13 | -19.87 |
| 0.501 | 0.24 | 40.52 | 27.33 | 40.76 | 27.57 | 56.00 | 46.00 | -15.24 | -18.43 |
| 0.509 | 0.24 | 40.40 | 26.86 | 40.64 | 27.10 | 56.00 | 46.00 | -15.36 | -18.90 |
| 1.556 | 0.15 | 39.18 | 31.67 | 39.33 | 31.82 | 56.00 | 46.00 | -16.67 | -14.18 |
| 4.645 | 0.21 | 37.38 | 31.26 | 37.59 | 31.47 | 56.00 | 46.00 | -18.41 | -14.53 |
| 5.000 | 0.22 | 37.56 | 31.40 | 37.78 | 31.62 | 56.00 | 46.00 | -18.22 | -14.38 |

Power Line Measured : Neutral

| Freq. (MHz) | Correct. Factor (dB) | Reading Value (dB μ V) | | Emission Level (dB μ V) | | Limit (dB μ V) | | Margin (dB) | |
|-------------|----------------------|----------------------------|-------|-----------------------------|-------|--------------------|-------|-------------|--------|
| | | Q.P. | AV. | Q.P. | AV. | Q.P. | AV. | Q.P. | AV. |
| 0.204 | 0.28 | 47.60 | 29.77 | 47.88 | 30.05 | 63.43 | 53.43 | -15.55 | -23.38 |
| 0.501 | 0.24 | 39.84 | 26.42 | 40.08 | 26.66 | 56.00 | 46.00 | -15.92 | -19.34 |
| 0.509 | 0.24 | 39.80 | 26.00 | 40.04 | 26.24 | 56.00 | 46.00 | -15.96 | -19.76 |
| 1.319 | 0.15 | 38.40 | 30.25 | 38.55 | 30.40 | 56.00 | 46.00 | -17.45 | -15.60 |
| 2.814 | 0.18 | 38.44 | 29.55 | 38.62 | 29.73 | 56.00 | 46.00 | -17.38 | -16.27 |
| 5.000 | 0.22 | 37.38 | 30.97 | 37.60 | 31.19 | 56.00 | 46.00 | -18.40 | -14.81 |

NOTE :

1. Measurement uncertainty is +/- 2dB
2. Emission level = Reading value + Correction factor
3. Correction Factor = Cable loss + Insertion loss of LISN
4. Margin value = Emission level - Limit
5. The emission of other frequencies was very low against the limit.
6. "-": The Quasi-peak reading value also meets average limit and measurement with the average detector is unnecessary.



TEST REPORT

| | | | |
|--------------------|---------------|------------------|---------------|
| Temperature: | 23 °C | Humidity: | 55 %RH |
| Frequency Range: | 0.15 – 30 MHz | Tested Mode: | IEEE 802.11g |
| Receiver Detector: | Q.P. and AV. | Modulation Type: | OFDM |
| Tested By: | Wayne Lin | Tested Channel: | CH1: 2412MHz |
| Antenna Type: | N/A | Tested Date: | Nov. 06, 2008 |

Power Line Measured : Line

| Freq. (MHz) | Correct. Factor (dB) | Reading Value (dB μ V) | | Emission Level (dB μ V) | | Limit (dB μ V) | | Margin (dB) | |
|-------------|----------------------|----------------------------|-------|-----------------------------|-------|--------------------|-------|-------------|--------|
| | | Q.P. | AV. | Q.P. | AV. | Q.P. | AV. | Q.P. | AV. |
| 0.174 | 0.30 | 55.18 | 47.26 | 55.48 | 47.56 | 64.75 | 54.75 | -9.27 | -7.19 |
| 0.177 | 0.30 | 53.92 | 45.79 | 54.22 | 46.09 | 64.61 | 54.61 | -10.39 | -8.52 |
| 0.524 | 0.24 | 38.92 | 37.15 | 39.16 | 37.39 | 56.00 | 46.00 | -16.84 | -8.61 |
| 1.279 | 0.14 | 37.26 | 35.13 | 37.40 | 35.27 | 56.00 | 46.00 | -18.60 | -10.73 |
| 2.675 | 0.17 | 30.42 | 20.65 | 30.59 | 20.82 | 56.00 | 46.00 | -25.41 | -25.18 |
| 6.512 | 0.22 | 23.58 | 10.81 | 23.80 | 11.03 | 60.00 | 50.00 | -36.20 | -38.97 |

Power Line Measured : Neutral

| Freq. (MHz) | Correct. Factor (dB) | Reading Value (dB μ V) | | Emission Level (dB μ V) | | Limit (dB μ V) | | Margin (dB) | |
|-------------|----------------------|----------------------------|-------|-----------------------------|-------|--------------------|-------|-------------|--------|
| | | Q.P. | AV. | Q.P. | AV. | Q.P. | AV. | Q.P. | AV. |
| 0.174 | 0.30 | 53.78 | 46.06 | 54.08 | 46.36 | 64.75 | 54.75 | -10.67 | -8.39 |
| 0.177 | 0.30 | 52.22 | 43.99 | 52.52 | 44.29 | 64.61 | 54.61 | -12.09 | -10.32 |
| 0.524 | 0.24 | 37.60 | 35.72 | 37.84 | 35.96 | 56.00 | 46.00 | -18.16 | -10.04 |
| 2.952 | 0.18 | 38.26 | 33.07 | 38.44 | 33.25 | 56.00 | 46.00 | -17.56 | -12.75 |
| 3.012 | 0.18 | 36.06 | 31.12 | 36.24 | 31.30 | 56.00 | 46.00 | -19.76 | -14.70 |
| 5.041 | 0.22 | 27.26 | 16.65 | 27.48 | 16.87 | 60.00 | 50.00 | -32.52 | -33.13 |

NOTE :

1. Measurement uncertainty is +/- 2dB
2. Emission level = Reading value + Correction factor
3. Correction Factor = Cable loss + Insertion loss of LISN
4. Margin value = Emission level - Limit
5. The emission of other frequencies was very low against the limit.
6. "-": The Quasi-peak reading value also meets average limit and measurement with the average detector is unnecessary.



TEST REPORT

| | | | |
|--------------------|---------------|------------------|---------------|
| Temperature: | 23 °C | Humidity: | 55 %RH |
| Frequency Range: | 0.15 – 30 MHz | Tested Mode: | IEEE 802.11g |
| Receiver Detector: | Q.P. and AV. | Modulation Type: | OFDM |
| Tested By: | Wayne Lin | Tested Channel: | CH6: 2437MHz |
| Antenna Type: | N/A | Tested Date: | Nov. 06, 2008 |

Power Line Measured : Line

| Freq. (MHz) | Correct. Factor (dB) | Reading Value (dB μ V) | | Emission Level (dB μ V) | | Limit (dB μ V) | | Margin (dB) | |
|-------------|----------------------|----------------------------|-------|-----------------------------|-------|--------------------|-------|-------------|--------|
| | | Q.P. | AV. | Q.P. | AV. | Q.P. | AV. | Q.P. | AV. |
| 0.171 | 0.30 | 50.66 | 41.85 | 50.96 | 42.15 | 64.89 | 54.89 | -13.93 | -12.74 |
| 0.174 | 0.30 | 51.92 | 42.78 | 52.22 | 43.08 | 64.75 | 54.75 | -12.53 | -11.67 |
| 0.576 | 0.24 | 41.24 | 38.01 | 41.48 | 38.25 | 56.00 | 46.00 | -14.52 | -7.75 |
| 1.378 | 0.15 | 37.20 | 33.35 | 37.35 | 33.50 | 56.00 | 46.00 | -18.65 | -12.50 |
| 1.438 | 0.15 | 38.06 | 35.34 | 38.21 | 35.49 | 56.00 | 46.00 | -17.79 | -10.51 |
| 5.010 | 0.22 | 26.72 | 20.24 | 26.94 | 20.46 | 60.00 | 50.00 | -33.06 | -29.54 |

Power Line Measured : Neutral

| Freq. (MHz) | Correct. Factor (dB) | Reading Value (dB μ V) | | Emission Level (dB μ V) | | Limit (dB μ V) | | Margin (dB) | |
|-------------|----------------------|----------------------------|-------|-----------------------------|-------|--------------------|-------|-------------|--------|
| | | Q.P. | AV. | Q.P. | AV. | Q.P. | AV. | Q.P. | AV. |
| 0.153 | 0.30 | 50.40 | 29.25 | 50.70 | 29.55 | 65.82 | 55.82 | -15.12 | -26.27 |
| 0.156 | 0.30 | 49.94 | 30.32 | 50.24 | 30.62 | 65.66 | 55.66 | -15.42 | -25.04 |
| 0.576 | 0.24 | 40.98 | 36.98 | 41.22 | 37.22 | 56.00 | 46.00 | -14.78 | -8.78 |
| 1.120 | 0.14 | 39.22 | 35.10 | 39.36 | 35.24 | 56.00 | 46.00 | -16.64 | -10.76 |
| 1.388 | 0.15 | 32.44 | 18.86 | 32.59 | 19.01 | 56.00 | 46.00 | -23.41 | -26.99 |
| 12.714 | 0.24 | 26.74 | 19.81 | 26.98 | 20.05 | 60.00 | 50.00 | -33.02 | -29.95 |

NOTE :

1. Measurement uncertainty is +/- 2dB
2. Emission level = Reading value + Correction factor
3. Correction Factor = Cable loss + Insertion loss of LISN
4. Margin value = Emission level - Limit
5. The emission of other frequencies was very low against the limit.
6. "-": The Quasi-peak reading value also meets average limit and measurement with the average detector is unnecessary.



TEST REPORT

| | | | |
|--------------------|---------------|------------------|---------------|
| Temperature: | 23°C | Humidity: | 55%RH |
| Frequency Range: | 0.15 – 30 MHz | Tested Mode: | IEEE 802.11g |
| Receiver Detector: | Q.P. and AV. | Modulation Type: | OFDM |
| Tested By: | Wayne Lin | Tested Channel: | CH11: 2462MHz |
| Antenna Type: | N/A | Tested Date: | Nov. 06, 2008 |

Power Line Measured : Line

| Freq. (MHz) | Correct. Factor (dB) | Reading Value (dB μ V) | | Emission Level (dB μ V) | | Limit (dB μ V) | | Margin (dB) | |
|-------------|----------------------|----------------------------|-------|-----------------------------|-------|--------------------|-------|-------------|--------|
| | | Q.P. | AV. | Q.P. | AV. | Q.P. | AV. | Q.P. | AV. |
| 0.171 | 0.30 | 50.20 | 39.79 | 50.50 | 40.09 | 64.89 | 54.89 | -14.39 | -14.80 |
| 0.174 | 0.30 | 50.84 | 39.62 | 51.14 | 39.92 | 64.75 | 54.75 | -13.61 | -14.83 |
| 0.576 | 0.24 | 40.38 | 35.58 | 40.62 | 35.82 | 56.00 | 46.00 | -15.38 | -10.18 |
| 1.210 | 0.14 | 39.08 | 33.82 | 39.22 | 33.96 | 56.00 | 46.00 | -16.78 | -12.04 |
| 1.438 | 0.15 | 37.94 | 33.06 | 38.09 | 33.21 | 56.00 | 46.00 | -17.91 | -12.79 |
| 15.154 | 0.25 | 27.14 | 20.97 | 27.39 | 21.22 | 60.00 | 50.00 | -32.61 | -28.78 |

Power Line Measured : Neutral

| Freq. (MHz) | Correct. Factor (dB) | Reading Value (dB μ V) | | Emission Level (dB μ V) | | Limit (dB μ V) | | Margin (dB) | |
|-------------|----------------------|----------------------------|-------|-----------------------------|-------|--------------------|-------|-------------|--------|
| | | Q.P. | AV. | Q.P. | AV. | Q.P. | AV. | Q.P. | AV. |
| 0.156 | 0.30 | 49.30 | 32.69 | 49.60 | 32.99 | 65.66 | 55.66 | -16.06 | -22.67 |
| 0.171 | 0.30 | 50.54 | 39.43 | 50.84 | 39.73 | 64.89 | 54.89 | -14.05 | -15.16 |
| 0.576 | 0.24 | 40.34 | 35.45 | 40.58 | 35.69 | 56.00 | 46.00 | -15.42 | -10.31 |
| 1.210 | 0.14 | 38.32 | 33.39 | 38.46 | 33.53 | 56.00 | 46.00 | -17.54 | -12.47 |
| 1.378 | 0.15 | 37.38 | 32.60 | 37.53 | 32.75 | 56.00 | 46.00 | -18.47 | -13.25 |
| 5.000 | 0.22 | 26.12 | 19.30 | 26.34 | 19.52 | 56.00 | 46.00 | -29.66 | -26.48 |

NOTE :

1. Measurement uncertainty is +/- 2dB
2. Emission level = Reading value + Correction factor
3. Correction Factor = Cable loss + Insertion loss of LISN
4. Margin value = Emission level - Limit
5. The emission of other frequencies was very low against the limit.
6. "-": The Quasi-peak reading value also meets average limit and measurement with the average detector is unnecessary.



| | | | |
|--------------------|---------------|------------------|---------------|
| Temperature: | 23°C | Humidity: | 55 %RH |
| Frequency Range: | 0.15 – 30 MHz | Tested Mode: | IEEE 802.11b |
| Receiver Detector: | Q.P. and AV. | Modulation Type: | CCK |
| Tested By: | Wayne Lin | Tested Channel: | CH1: 2412MHz |
| Antenna Type: | N/A | Tested Date: | Nov. 06, 2008 |

Power Line Measured : Line

| Freq. (MHz) | Correct. Factor (dB) | Reading Value (dB μ V) | | Emission Level (dB μ V) | | Limit (dB μ V) | | Margin (dB) | |
|-------------|----------------------|----------------------------|-------|-----------------------------|-------|--------------------|-------|-------------|--------|
| | | Q.P. | AV. | Q.P. | AV. | Q.P. | AV. | Q.P. | AV. |
| 0.174 | 0.30 | 52.86 | 44.98 | 53.16 | 45.28 | 64.75 | 54.75 | -11.59 | -9.47 |
| 0.177 | 0.30 | 49.30 | 41.78 | 49.60 | 42.08 | 64.61 | 54.61 | -15.01 | -12.53 |
| 0.519 | 0.24 | 38.92 | 37.40 | 39.16 | 37.64 | 56.00 | 46.00 | -16.84 | -8.36 |
| 3.289 | 0.18 | 38.72 | 30.98 | 38.90 | 31.16 | 56.00 | 46.00 | -17.10 | -14.84 |
| 3.754 | 0.19 | 33.76 | 24.44 | 33.95 | 24.63 | 56.00 | 46.00 | -22.05 | -21.37 |
| 6.238 | 0.22 | 29.00 | 18.54 | 29.22 | 18.76 | 60.00 | 50.00 | -30.78 | -31.24 |

Power Line Measured : Neutral

| Freq. (MHz) | Correct. Factor (dB) | Reading Value (dB μ V) | | Emission Level (dB μ V) | | Limit (dB μ V) | | Margin (dB) | |
|-------------|----------------------|----------------------------|-------|-----------------------------|-------|--------------------|-------|-------------|--------|
| | | Q.P. | AV. | Q.P. | AV. | Q.P. | AV. | Q.P. | AV. |
| 0.171 | 0.30 | 52.00 | 44.15 | 52.30 | 44.45 | 64.89 | 54.89 | -12.59 | -10.44 |
| 0.174 | 0.30 | 52.90 | 44.97 | 53.20 | 45.27 | 64.75 | 54.75 | -11.55 | -9.48 |
| 0.692 | 0.22 | 41.56 | 40.41 | 41.78 | 40.63 | 56.00 | 46.00 | -14.22 | -5.37 |
| 1.269 | 0.14 | 39.98 | 38.04 | 40.12 | 38.18 | 56.00 | 46.00 | -15.88 | -7.82 |
| 1.329 | 0.15 | 38.46 | 35.17 | 38.61 | 35.32 | 56.00 | 46.00 | -17.39 | -10.68 |
| 13.830 | 0.25 | 26.30 | 20.14 | 26.55 | 20.39 | 60.00 | 50.00 | -33.45 | -29.61 |

NOTE :

1. Measurement uncertainty is +/- 2dB
2. Emission level = Reading value + Correction factor
3. Correction Factor = Cable loss + Insertion loss of LISN
4. Margin value = Emission level - Limit
5. The emission of other frequencies was very low against the limit.
6. "-": The Quasi-peak reading value also meets average limit and measurement with the average detector is unnecessary.



TEST REPORT

| | | | |
|--------------------|---------------|------------------|---------------|
| Temperature: | 23 °C | Humidity: | 55 %RH |
| Frequency Range: | 0.15 – 30 MHz | Tested Mode: | IEEE 802.11b |
| Receiver Detector: | Q.P. and AV. | Modulation Type: | CCK |
| Tested By: | Wayne Lin | Tested Channel: | CH6: 2437MHz |
| Antenna Type: | N/A | Tested Date: | Nov. 06, 2008 |

Power Line Measured : Line

| Freq. (MHz) | Correct. Factor (dB) | Reading Value (dB μ V) | | Emission Level (dB μ V) | | Limit (dB μ V) | | Margin (dB) | |
|-------------|----------------------|----------------------------|-------|-----------------------------|-------|--------------------|-------|-------------|--------|
| | | Q.P. | AV. | Q.P. | AV. | Q.P. | AV. | Q.P. | AV. |
| 0.171 | 0.30 | 50.20 | 39.52 | 50.50 | 39.82 | 64.89 | 54.89 | -14.39 | -15.07 |
| 0.174 | 0.30 | 50.50 | 39.76 | 50.80 | 40.06 | 64.75 | 54.75 | -13.95 | -14.69 |
| 0.519 | 0.24 | 39.82 | 34.97 | 40.06 | 35.21 | 56.00 | 46.00 | -15.94 | -10.79 |
| 1.329 | 0.15 | 35.10 | 23.84 | 35.25 | 23.99 | 56.00 | 46.00 | -20.75 | -22.01 |
| 1.378 | 0.15 | 37.28 | 32.26 | 37.43 | 32.41 | 56.00 | 46.00 | -18.57 | -13.59 |
| 16.968 | 0.30 | 26.08 | 18.41 | 26.38 | 18.71 | 60.00 | 50.00 | -33.62 | -31.29 |

Power Line Measured : Neutral

| Freq. (MHz) | Correct. Factor (dB) | Reading Value (dB μ V) | | Emission Level (dB μ V) | | Limit (dB μ V) | | Margin (dB) | |
|-------------|----------------------|----------------------------|-------|-----------------------------|-------|--------------------|-------|-------------|--------|
| | | Q.P. | AV. | Q.P. | AV. | Q.P. | AV. | Q.P. | AV. |
| 0.159 | 0.30 | 49.72 | 33.84 | 50.02 | 34.14 | 65.50 | 55.50 | -15.48 | -21.36 |
| 0.171 | 0.30 | 50.24 | 39.80 | 50.54 | 40.10 | 64.89 | 54.89 | -14.35 | -14.79 |
| 0.692 | 0.22 | 40.32 | 36.04 | 40.54 | 36.26 | 56.00 | 46.00 | -15.46 | -9.74 |
| 1.259 | 0.14 | 33.58 | 25.47 | 33.72 | 25.61 | 56.00 | 46.00 | -22.28 | -20.39 |
| 1.438 | 0.15 | 38.16 | 33.45 | 38.31 | 33.60 | 56.00 | 46.00 | -17.69 | -12.40 |
| 14.490 | 0.25 | 26.00 | 17.63 | 26.25 | 17.88 | 60.00 | 50.00 | -33.75 | -32.12 |

NOTE :

1. Measurement uncertainty is +/- 2dB
2. Emission level = Reading value + Correction factor
3. Correction Factor = Cable loss + Insertion loss of LISN
4. Margin value = Emission level - Limit
5. The emission of other frequencies was very low against the limit.
6. "-": The Quasi-peak reading value also meets average limit and measurement with the average detector is unnecessary.



TEST REPORT

| | | | |
|--------------------|---------------|------------------|---------------|
| Temperature: | 23 °C | Humidity: | 53 %RH |
| Frequency Range: | 0.15 – 30 MHz | Tested Mode: | IEEE 802.11b |
| Receiver Detector: | Q.P. and AV. | Modulation Type: | CCK |
| Tested By: | Wayne Lin | Tested Channel: | CH11: 2462MHz |
| Antenna Type: | N/A | Tested Date: | Nov. 06, 2008 |

Power Line Measured : Line

| Freq. (MHz) | Correct. Factor (dB) | Reading Value (dB μ V) | | Emission Level (dB μ V) | | Limit (dB μ V) | | Margin (dB) | |
|-------------|----------------------|----------------------------|-------|-----------------------------|-------|--------------------|-------|-------------|--------|
| | | Q.P. | AV. | Q.P. | AV. | Q.P. | AV. | Q.P. | AV. |
| 0.153 | 0.30 | 49.48 | 29.57 | 49.78 | 29.87 | 65.82 | 55.82 | -16.04 | -25.95 |
| 0.156 | 0.30 | 48.74 | 31.45 | 49.04 | 31.75 | 65.66 | 55.66 | -16.62 | -23.91 |
| 0.692 | 0.22 | 40.38 | 36.07 | 40.60 | 36.29 | 56.00 | 46.00 | -15.40 | -9.71 |
| 1.269 | 0.14 | 36.24 | 31.31 | 36.38 | 31.45 | 56.00 | 46.00 | -19.62 | -14.55 |
| 1.438 | 0.15 | 37.80 | 32.91 | 37.95 | 33.06 | 56.00 | 46.00 | -18.05 | -12.94 |
| 20.473 | 0.39 | 25.58 | 19.26 | 25.97 | 19.65 | 60.00 | 50.00 | -34.03 | -30.35 |

Power Line Measured : Neutral

| Freq. (MHz) | Correct. Factor (dB) | Reading Value (dB μ V) | | Emission Level (dB μ V) | | Limit (dB μ V) | | Margin (dB) | |
|-------------|----------------------|----------------------------|-------|-----------------------------|-------|--------------------|-------|-------------|--------|
| | | Q.P. | AV. | Q.P. | AV. | Q.P. | AV. | Q.P. | AV. |
| 0.159 | 0.30 | 49.64 | 31.83 | 49.94 | 32.13 | 65.50 | 55.50 | -15.56 | -23.37 |
| 0.174 | 0.30 | 50.14 | 39.00 | 50.44 | 39.30 | 64.75 | 54.75 | -14.31 | -15.45 |
| 0.692 | 0.22 | 40.16 | 35.60 | 40.38 | 35.82 | 56.00 | 46.00 | -15.62 | -10.18 |
| 1.210 | 0.14 | 38.36 | 32.63 | 38.50 | 32.77 | 56.00 | 46.00 | -17.50 | -13.23 |
| 1.378 | 0.15 | 37.34 | 32.53 | 37.49 | 32.68 | 56.00 | 46.00 | -18.51 | -13.32 |
| 5.000 | 0.22 | 25.16 | 17.84 | 25.38 | 18.06 | 56.00 | 46.00 | -30.62 | -27.94 |

NOTE :

1. Measurement uncertainty is +/- 2dB
2. Emission level = Reading value + Correction factor
3. Correction Factor = Cable loss + Insertion loss of LISN
4. Margin value = Emission level - Limit
5. The emission of other frequencies was very low against the limit.
6. "-": The Quasi-peak reading value also meets average limit and measurement with the average detector is unnecessary.



TEST REPORT

4.2 RADIATED EMISSION TEST

4.2.1 LIMIT

FCC Part15, Subpart C Section 15.209 limit of radiated emission for frequency below1000MHz. The emissions from an intentional radiator shall not exceed the field strength levels specified in the following table:

| FREQUENCY (MHz) | DISTANCE (m) | FIELD STRENGTH (dB μ V/m) |
|-----------------|--------------|-------------------------------|
| 30 - 88 | 3 | 40.0 |
| 88 - 216 | 3 | 43.5 |
| 216 - 960 | 3 | 46.0 |
| Above 960 | 3 | 54.0 |

NOTE :

1. In the emission tables above , the tighter limit applies at the band edges.
2. Distance refers to the distance between measuring instrument, antenna, and the closest point of any part of the device or system.

FCC Part 15, Section15.35(b) limit of radiated emission for frequency above 1000 MHz

| FREQUENCY (MHz) | Class A (dBuV/m) (at 3m) | | Class B (dBuV/m) (at 3m) | |
|-----------------|--------------------------|---------|--------------------------|---------|
| | PEAK | AVERAGE | PEAK | AVERAGE |
| Above 1000 | 80.0 | 60.0 | 74.0 | 54.0 |



Spectrum Research & Testing Lab., Inc.
No. 101-10, Ling 8,
Shan-Tong Li, Chung-Li
City, Taoyuan, Taiwan

TEST REPORT

Reference No.: A08092401
Report No.: FCCA08092401
FCC ID: W3Q-WL850R
Page: 19 of 73
Date: Nov. 27, 2008

4.2.2 TEST EQUIPMENT

The following test equipment was used during the radiated emission test:

| EQUIPMENT/ FACILITIES | SPECIFICATIONS | MANUFACTURER | MODEL#/ SERIAL# | DUE DATE OF CAL. & CAL. CENTER |
|--------------------------|-------------------------|--------------------|-----------------------|-----------------------------------|
| EMI TEST RECEIVER | 9kHz TO 2.75 GHz | ROHDE & SCHWARZ | ESCS30/ 830245/012 | OCT. 2009 ETC |
| SPECTRUM ANALYZER | PK-40GHz | ROHDE & SCHWARZ | FSP40/ 100093 | SEP 2009 ETC |
| BI-LOG ANTENNA | 25 MHz TO 2 GHz | EMCO | 3142B/ 0005-1534 | NOV. 2008 ETC |
| PRE-AMPLIFIER | 1 GHz TO 26.5 GHz | HP | 8449B/ 3008A01995 | SEP. 2009 ETC |
| HORN ANTENNA | 1 GHz TO 18 GHz | EMCO | 3115/ 9602-4681 | JAN. 2009 ETC |
| OATS | 3 – 10 M MEASUREMENT | SRT | SRT-1 | NOV. 2008 SRT |
| COAXIAL CABLE | 25M | TIMES | J400/ #25M | AUG. 2009 ETC |
| FILTER | 2 LINE, 30A | FIL.COIL | FC-943/ 869 | NCR |

NOTE:

1. The calibration interval of the above test equipment is one year and the calibrations are traceable to NML/ROC and NIST/USA.
2. The Open Area Test Site (SRT-1) is registered by FCC with No. 90957 and VCCI with No. R-1081.
3. The Open Area Test Site (SRT-2) is registered by FCC with No. 98458 and VCCI with No. R-1168.

4.2.3 TEST SET-UP

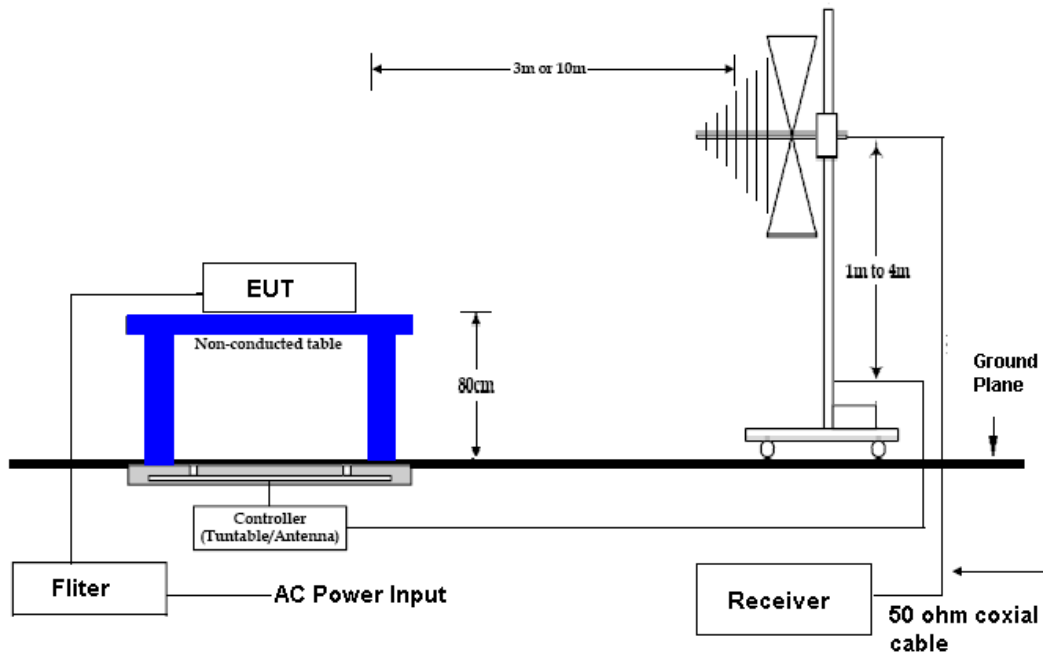

NOTE :

1. The EUT system was put on a wooden table with 0.8m heights above a ground plane.
2. For the actual test configuration, please refer to the photos of testing.

4.2.4 TEST PROCEDURE

The EUT was tested according to the requirement of ANSI C63.4:2003 and CISPR 22:2003. The measurements were made at an open area test site with 3 meter measurement distance under 1 GHz and with 3m distance above 1GHz. The frequency spectrum measured started from 30 MHz. Under 1 GHz, all readings were quasi-peak values with 120 kHz resolution bandwidth of the test receiver. Above 1 GHz, the measurements were made at an open area test site with 3 meter measurement distance and all readings were peak or average values with 1 MHz resolution bandwidth of the test receiver. The EUT system was operated in all typical methods by users. The cables connected to EUT and support units were moved to find the maximum emission levels for each frequency.

First, find the margin or higher points at least 6 points by software, then use manual to find the maximum data. The procedure is referred on the test procedure of SRT LAB.

4.2.5 EUT OPERATING CONDITION

Same as section 4.1.5 of this report.



TEST REPORT

4.2.6 TEST RESULT

| | | | |
|--------------------|---------------|--------------------|---------------|
| Temperature: | 24 °C | Humidity: | 68 %RH |
| Frequency Range: | 30 – 1000 MHz | Measured Distance: | 3m |
| Receiver Detector: | Q.P. | Tested Mode: | Link |
| Tested By: | Wayne Lin | Tested Date: | Nov. 12, 2008 |

Antenna Polarization : Horizontal

| Frequency (MHz) | Cable Loss (dB) | Antenna Factor (dB/m) | Reading Data (dBμV) | Emission Level (dBμV/m) | Limit (dBμV/m) | Margin (dB) | AZ(°) | EL(m) |
|-----------------|-----------------|-----------------------|---------------------|-------------------------|----------------|-------------|-------|-------|
| 73.5213 | 1.19 | 6.48 | 22.1 | 29.8 | 40.0 | -10.2 | 218 | 2.3 |
| 137.1402 | 1.74 | 11.54 | 15.9 | 29.2 | 43.5 | -14.3 | 141 | 1.9 |
| 166.2694 | 1.91 | 8.53 | 22.5 | 32.9 | 43.5 | -10.6 | 151 | 1.67 |
| 184.003 | 1.69 | 9.32 | 22.2 | 33.2 | 43.5 | -10.3 | 333 | 1.4 |
| 277.915 | 2.49 | 12.90 | 17.3 | 32.7 | 46.0 | -13.3 | 18 | 1.5 |
| 600.103 | 3.72 | 19.20 | 14.3 | 37.2 | 46.0 | -8.8 | 207 | 1.2 |

Antenna Polarization : Vertical

| Frequency (MHz) | Cable Loss (dB) | Antenna Factor (dB/m) | Reading Data (dBμV) | Emission Level (dBμV/m) | Limit (dBμV/m) | Margin (dB) | AZ(°) | EL(m) |
|-----------------|-----------------|-----------------------|---------------------|-------------------------|----------------|-------------|-------|-------|
| 81.1223 | 1.26 | 7.55 | 21.3 | 30.1 | 40.0 | -9.9 | 36 | 1 |
| 184.004 | 1.69 | 9.32 | 20 | 31.0 | 43.5 | -12.5 | 268 | 1.1 |
| 276.025 | 2.44 | 12.85 | 19.8 | 35.1 | 46.0 | -10.9 | 101 | 1 |
| 368.0256 | 3.23 | 15.53 | 17.1 | 35.9 | 46.0 | -10.1 | 223 | 1 |
| 458.0316 | 3.04 | 16.95 | 15.3 | 35.3 | 46.0 | -10.7 | 49 | 1.3 |
| 644.0051 | 4.65 | 20.08 | 12.1 | 36.8 | 46.0 | -9.2 | 355 | 1.2 |

NOTE :

1. Measurement uncertainty is +/- 3.7dB.
2. "": Measurement does not apply for this frequency.
3. Emission Level = Reading Value + Ant. Factor + Cable Loss.
4. The field strength of other emission frequencies were very low against the limit.



TEST REPORT

| | | | |
|--------------------|---------------|--------------------|---------------|
| Temperature: | 24 °C | Humidity: | 68 %RH |
| Frequency Range: | 30 – 1000 MHz | Measured Distance: | 3m |
| Receiver Detector: | Q.P. | Tested Mode: | Standby |
| Tested By: | Wayne Lin | Tested Date: | Nov. 12, 2008 |

Antenna Polarization : Horizontal

| Frequency (MHz) | Cable Loss (dB) | Antenna Factor (dB/m) | Reading Data (dBμV) | Emission Level (dBμV/m) | Limit (dBμV/m) | Margin (dB) | AZ(°) | EL(m) |
|-----------------|-----------------|-----------------------|---------------------|-------------------------|----------------|-------------|-------|-------|
| 40.5880 | 0.95 | 9.50 | 20.0 | 30.5 | 40.0 | -9.6 | 13.9 | 1.8 |
| 166.2693 | 1.91 | 8.53 | 23.2 | 33.6 | 43.5 | -9.9 | 204.8 | 1.6 |
| 265.3516 | 2.33 | 12.28 | 14.0 | 28.6 | 46.0 | -17.4 | 325.1 | 1.4 |
| 600.1020 | 3.72 | 19.20 | 15.9 | 38.8 | 46.0 | -7.2 | 91.4 | 1.61 |
| 800.2560 | 5.23 | 21.40 | 11.1 | 37.7 | 46.0 | -8.3 | 88.3 | 1.92 |
| 834.1136 | 4.77 | 22.35 | 10.0 | 37.1 | 46.0 | -8.9 | 173.2 | 1.2 |

Antenna Polarization : Vertical

| Frequency (MHz) | Cable Loss (dB) | Antenna Factor (dB/m) | Reading Data (dBμV) | Emission Level (dBμV/m) | Limit (dBμV/m) | Margin (dB) | AZ(°) | EL(m) |
|-----------------|-----------------|-----------------------|---------------------|-------------------------|----------------|-------------|-------|-------|
| 130.0214 | 1.48 | 9.75 | 20.9 | 32.1 | 43.5 | -11.4 | 55.9 | 1.2 |
| 170.7964 | 2.05 | 8.75 | 23.5 | 34.3 | 43.5 | -9.2 | 301.8 | 1.3 |
| 266.7513 | 2.29 | 12.33 | 16.7 | 31.3 | 46.0 | -14.7 | 43.5 | 1.5 |
| 533.2270 | 3.62 | 18.06 | 14.2 | 35.9 | 46.0 | -10.1 | 225.1 | 1 |
| 838.6420 | 4.71 | 22.46 | 10.1 | 37.3 | 46.0 | -8.7 | 53.1 | 1 |
| 938.0130 | 4.87 | 23.17 | 9.5 | 37.5 | 46.0 | -8.5 | 97.5 | 1.1 |

NOTE :

1. Measurement uncertainty is +/- 3.7dB.
2. "": Measurement does not apply for this frequency.
3. Emission Level = Reading Value + Ant. Factor + Cable Loss.
4. The field strength of other emission frequencies were very low against the limit.



TEST REPORT

| | | | |
|--------------------|---------------|--------------------|------------------|
| Temperature: | 24 °C | Humidity: | 68 %RH |
| Frequency Range: | 30 – 1000 MHz | Measured Distance: | 3m |
| Receiver Detector: | Q.P. | Tested Mode: | IEEE802.11g CH01 |
| Tested By: | Wayne Lin | Tested Date: | Nov. 12, 2008 |

Antenna Polarization : Horizontal

| Frequency (MHz) | Cable Loss (dB) | Antenna Factor (dB/m) | Reading Data (dBμV) | Emission Level (dBμV/m) | Limit (dBμV/m) | Margin (dB) | AZ(°) | EL(m) |
|-----------------|-----------------|-----------------------|---------------------|-------------------------|----------------|-------------|-------|-------|
| 186.5600 | 1.79 | 9.33 | 19.2 | 30.3 | 43.5 | -13.2 | 282 | 2.5 |
| 240.3200 | 2.10 | 11.08 | 20.2 | 33.4 | 46.0 | -12.6 | 183 | 2.4 |
| 226.8400 | 2.14 | 10.49 | 19.4 | 32.0 | 46.0 | -14.0 | 205 | 2.34 |
| 385.7900 | 3.17 | 15.89 | 13.2 | 32.3 | 46.0 | -13.7 | 315 | 2.2 |
| 576.8500 | 3.70 | 18.79 | 11.0 | 33.5 | 46.0 | -12.5 | 98 | 1.83 |
| 647.7100 | 4.72 | 20.14 | 9.2 | 34.1 | 43.5 | -13.2 | 224 | 1.76 |

Antenna Polarization : Vertical

| Frequency (MHz) | Cable Loss (dB) | Antenna Factor (dB/m) | Reading Data (dBμV) | Emission Level (dBμV/m) | Limit (dBμV/m) | Margin (dB) | AZ(°) | EL(m) |
|-----------------|-----------------|-----------------------|---------------------|-------------------------|----------------|-------------|-------|-------|
| 43.4200 | 0.96 | 8.36 | 21.8 | 31.1 | 40.0 | -8.9 | 156 | 1.23 |
| 368.0500 | 3.23 | 15.53 | 12.8 | 31.6 | 46.0 | -14.4 | 305 | 1.42 |
| 411.3600 | 3.08 | 16.34 | 11.6 | 31.0 | 46.0 | -15.0 | 174 | 1.58 |
| 499.7400 | 3.50 | 17.49 | 11.2 | 32.2 | 46.0 | -13.8 | 287 | 1.8 |
| 836.6500 | 4.74 | 22.41 | 9.8 | 36.9 | 46.0 | -9.1 | 58 | 2.1 |
| 945.3300 | 4.90 | 22.99 | 9.2 | 37.1 | 46.0 | -8.9 | 96 | 2.4 |

NOTE :

1. Measurement uncertainty is +/- 3.7dB.
2. "**": Measurement does not apply for this frequency.
3. Emission Level = Reading Value + Ant. Factor + Cable Loss.
4. The field strength of other emission frequencies were very low against the limit.



TEST REPORT

| | | | |
|--------------------|---------------|--------------------|------------------|
| Temperature: | 24 °C | Humidity: | 68 %RH |
| Frequency Range: | 30 – 1000 MHz | Measured Distance: | 3m |
| Receiver Detector: | Q.P. | Tested Mode: | IEEE802.11g CH06 |
| Tested By: | Wayne Lin | Tested Date: | Nov. 12, 2008 |

Antenna Polarization : Horizontal

| Frequency (MHz) | Cable Loss (dB) | Antenna Factor (dB/m) | Reading Data (dBμV) | Emission Level (dBμV/m) | Limit (dBμV/m) | Margin (dB) | AZ(°) | EL(m) |
|-----------------|-----------------|-----------------------|---------------------|-------------------------|----------------|-------------|-------|-------|
| 183.8700 | 1.63 | 9.32 | 22.3 | 33.2 | 43.5 | -10.3 | 242 | 2.5 |
| 201.6000 | 2.13 | 9.44 | 20.3 | 31.9 | 43.5 | -11.6 | 175 | 1.96 |
| 322.5400 | 2.76 | 14.56 | 12.8 | 30.1 | 46.0 | -15.9 | 35 | 1.78 |
| 351.8900 | 3.29 | 15.17 | 14.4 | 32.9 | 46.0 | -13.1 | 48 | 1.56 |
| 803.0300 | 5.19 | 21.48 | 9.7 | 36.4 | 46.0 | -9.6 | 168 | 1.45 |
| 928.7500 | 4.82 | 23.44 | 8.8 | 37.1 | 46.0 | -8.9 | 54 | 1.33 |

Antenna Polarization : Vertical

| Frequency (MHz) | Cable Loss (dB) | Antenna Factor (dB/m) | Reading Data (dBμV) | Emission Level (dBμV/m) | Limit (dBμV/m) | Margin (dB) | AZ(°) | EL(m) |
|-----------------|-----------------|-----------------------|---------------------|-------------------------|----------------|-------------|-------|-------|
| 191.8500 | 2.02 | 9.36 | 24.3 | 35.7 | 43.5 | -7.8 | 68 | 1.1 |
| 402.2600 | 3.11 | 16.23 | 17.6 | 36.9 | 46.0 | -9.1 | 274 | 1.3 |
| 502.3200 | 3.52 | 17.53 | 12.5 | 33.6 | 46.0 | -12.4 | 156 | 1.45 |
| 662.2400 | 4.59 | 20.44 | 9.2 | 34.2 | 46.0 | -11.8 | 36 | 1.65 |
| 866.0600 | 4.60 | 23.25 | 8.7 | 36.5 | 46.0 | -9.5 | 328 | 1.68 |
| 953.3800 | 4.94 | 22.77 | 7.6 | 35.3 | 46.0 | -10.7 | 45 | 1.7 |

NOTE :

1. Measurement uncertainty is +/- 3.7dB.
2. "": Measurement does not apply for this frequency.
3. Emission Level = Reading Value + Ant. Factor + Cable Loss.
4. The field strength of other emission frequencies were very low against the limit.



TEST REPORT

| | | | |
|--------------------|---------------|--------------------|------------------|
| Temperature: | 24 °C | Humidity: | 68 %RH |
| Frequency Range: | 30 – 1000 MHz | Measured Distance: | 3m |
| Receiver Detector: | Q.P. | Tested Mode: | IEEE802.11g CH11 |
| Tested By: | Wayne Lin | Tested Date: | Nov. 12, 2008 |

Antenna Polarization : Horizontal

| Frequency (MHz) | Cable Loss (dB) | Antenna Factor (dB/m) | Reading Data (dBμV) | Emission Level (dBμV/m) | Limit (dBμV/m) | Margin (dB) | AZ(°) | EL(m) |
|-----------------|-----------------|-----------------------|---------------------|-------------------------|----------------|-------------|-------|-------|
| 167.5800 | 1.95 | 8.59 | 22.5 | 33.0 | 43.5 | -10.5 | 256 | 2.5 |
| 184.2500 | 1.69 | 9.32 | 18.9 | 29.9 | 43.5 | -13.6 | 62 | 2.14 |
| 337.0800 | 3.04 | 14.88 | 13.2 | 31.1 | 46.0 | -14.9 | 98 | 2.3 |
| 502.1400 | 3.52 | 17.53 | 10.7 | 31.8 | 46.0 | -14.2 | 184 | 1.46 |
| 579.8100 | 3.70 | 18.84 | 11.8 | 34.3 | 46.0 | -11.7 | 236 | 1.64 |
| 647.2900 | 4.72 | 20.14 | 8.2 | 33.1 | 46.0 | -12.9 | 38 | 1.7 |

Antenna Polarization : Vertical

| Frequency (MHz) | Cable Loss (dB) | Antenna Factor (dB/m) | Reading Data (dBμV) | Emission Level (dBμV/m) | Limit (dBμV/m) | Margin (dB) | AZ(°) | EL(m) |
|-----------------|-----------------|-----------------------|---------------------|-------------------------|----------------|-------------|-------|-------|
| 49.3200 | 0.98 | 6.08 | 24.1 | 31.2 | 40.0 | -8.8 | 85 | 1.3 |
| 227.6800 | 2.12 | 10.53 | 21.3 | 34.0 | 46.0 | -12.0 | 264 | 1.5 |
| 407.0200 | 3.10 | 16.29 | 16.3 | 35.7 | 46.0 | -10.3 | 205 | 1.65 |
| 502.1400 | 3.52 | 17.53 | 12.8 | 33.9 | 46.0 | -12.1 | 63 | 1.71 |
| 866.0200 | 4.60 | 23.25 | 8.8 | 36.6 | 46.0 | -9.4 | 175 | 1.83 |
| 955.2800 | 4.95 | 22.72 | 7.4 | 35.1 | 46.0 | -10.9 | 36 | 1.9 |

NOTE :

1. Measurement uncertainty is +/- 3.7dB.
2. "": Measurement does not apply for this frequency.
3. Emission Level = Reading Value + Ant. Factor + Cable Loss.
4. The field strength of other emission frequencies were very low against the limit.



TEST REPORT

| | | | |
|--------------------|---------------|--------------------|------------------|
| Temperature: | 24 °C | Humidity: | 68 %RH |
| Frequency Range: | 30 – 1000 MHz | Measured Distance: | 3m |
| Receiver Detector: | Q.P. | Tested Mode: | IEEE802.11b CH01 |
| Tested By: | Wayne Lin | Tested Date: | Nov. 12, 2008 |

Antenna Polarization : Horizontal

| Frequency (MHz) | Cable Loss (dB) | Antenna Factor (dB/m) | Reading Data (dBμV) | Emission Level (dBμV/m) | Limit (dBμV/m) | Margin (dB) | AZ(°) | EL(m) |
|-----------------|-----------------|-----------------------|---------------------|-------------------------|----------------|-------------|-------|-------|
| 203.2500 | 2.08 | 9.53 | 23.6 | 35.2 | 43.5 | -8.3 | 247 | 2.3 |
| 338.7800 | 3.06 | 14.90 | 14.3 | 32.3 | 46.0 | -13.7 | 175 | 1.92 |
| 356.7400 | 3.27 | 15.28 | 18.4 | 36.9 | 46.0 | -9.1 | 303 | 1.58 |
| 647.5700 | 4.72 | 20.14 | 10.2 | 35.1 | 46.0 | -10.9 | 180 | 1.36 |
| 802.7800 | 5.20 | 21.46 | 9.1 | 35.8 | 46.0 | -10.2 | 48 | 1.74 |
| 926.1000 | 4.81 | 23.50 | 8.4 | 36.7 | 46.0 | -9.3 | 254 | 1.23 |

Antenna Polarization : Vertical

| Frequency (MHz) | Cable Loss (dB) | Antenna Factor (dB/m) | Reading Data (dBμV) | Emission Level (dBμV/m) | Limit (dBμV/m) | Margin (dB) | AZ(°) | EL(m) |
|-----------------|-----------------|-----------------------|---------------------|-------------------------|----------------|-------------|-------|-------|
| 43.2500 | 0.96 | 8.36 | 24.3 | 33.6 | 40.0 | -6.4 | 102 | 1.2 |
| 196.7100 | 2.09 | 9.38 | 22.8 | 34.3 | 43.5 | -9.2 | 248 | 1.23 |
| 404.6900 | 3.11 | 16.25 | 12.5 | 31.9 | 46.0 | -14.1 | 304 | 1.42 |
| 499.3600 | 3.50 | 17.49 | 9.8 | 30.8 | 46.0 | -15.2 | 214 | 1.84 |
| 832.0300 | 4.79 | 22.30 | 7.5 | 34.6 | 46.0 | -11.4 | 84 | 2 |
| 950.4200 | 4.92 | 22.85 | 7.6 | 35.4 | 46.0 | -10.6 | 174 | 2.1 |

NOTE :

1. Measurement uncertainty is +/-3.7dB.
2. "": Measurement does not apply for this frequency.
3. Emission Level = Reading Value + Ant. Factor + Cable Loss.
4. The field strength of other emission frequencies were very low against the limit.



TEST REPORT

| | | | |
|--------------------|---------------|--------------------|------------------|
| Temperature: | 24 °C | Humidity: | 68 %RH |
| Frequency Range: | 30 – 1000 MHz | Measured Distance: | 3m |
| Receiver Detector: | Q.P. | Tested Mode: | IEEE802.11b CH06 |
| Tested By: | Wayne Lin | Tested Date: | Nov. 12, 2008 |

Antenna Polarization : Horizontal

| Frequency (MHz) | Cable Loss (dB) | Antenna Factor (dB/m) | Reading Data (dBμV) | Emission Level (dBμV/m) | Limit (dBμV/m) | Margin (dB) | AZ(°) | EL(m) |
|-----------------|-----------------|-----------------------|---------------------|-------------------------|----------------|-------------|-------|-------|
| 167.6500 | 1.95 | 8.59 | 22.4 | 32.9 | 43.5 | -10.6 | 254 | 2.3 |
| 201.5300 | 2.13 | 9.44 | 18.7 | 30.3 | 43.5 | -13.2 | 184 | 1.98 |
| 339.0600 | 3.08 | 14.92 | 13.0 | 31.0 | 46.0 | -15.0 | 165 | 1.74 |
| 579.6400 | 3.70 | 18.84 | 11.7 | 34.2 | 46.0 | -11.8 | 184 | 1.65 |
| 647.8000 | 4.72 | 20.14 | 10.6 | 35.5 | 46.0 | -10.5 | 281 | 1.5 |
| 926.0600 | 4.81 | 23.50 | 10.5 | 38.8 | 46.0 | -7.2 | 215 | 1.18 |

Antenna Polarization : Vertical

| Frequency (MHz) | Cable Loss (dB) | Antenna Factor (dB/m) | Reading Data (dBμV) | Emission Level (dBμV/m) | Limit (dBμV/m) | Margin (dB) | AZ(°) | EL(m) |
|-----------------|-----------------|-----------------------|---------------------|-------------------------|----------------|-------------|-------|-------|
| 46.3200 | 0.97 | 7.22 | 23.4 | 31.6 | 40.0 | -8.4 | 54 | 1.1 |
| 196.4700 | 2.09 | 9.38 | 21.3 | 32.8 | 43.5 | -10.7 | 253 | 1 |
| 502.3200 | 3.52 | 17.53 | 14.3 | 35.4 | 46.0 | -10.6 | 210 | 1.3 |
| 662.1200 | 4.59 | 20.44 | 8.4 | 33.4 | 46.0 | -12.6 | 124 | 1.5 |
| 867.6200 | 4.60 | 23.28 | 7.3 | 35.2 | 46.0 | -10.8 | 87 | 1.68 |
| 948.3200 | 4.91 | 22.90 | 7.2 | 35.0 | 46.0 | -11.0 | 63 | 1.8 |

NOTE :

1. Measurement uncertainty is +/- 3.7dB.
2. "": Measurement does not apply for this frequency.
3. Emission Level = Reading Value + Ant. Factor + Cable Loss.
4. The field strength of other emission frequencies were very low against the limit.



TEST REPORT

| | | | |
|--------------------|---------------|--------------------|------------------|
| Temperature: | 24 °C | Humidity: | 68 %RH |
| Frequency Range: | 30 – 1000 MHz | Measured Distance: | 3m |
| Receiver Detector: | Q.P. | Tested Mode: | IEEE802.11b CH11 |
| Tested By: | Wayne Lin | Tested Date: | Nov. 12, 2008 |

Antenna Polarization : Horizontal

| Frequency (MHz) | Cable Loss (dB) | Antenna Factor (dB/m) | Reading Data (dBμV) | Emission Level (dBμV/m) | Limit (dBμV/m) | Margin (dB) | AZ(°) | EL(m) |
|-----------------|-----------------|-----------------------|---------------------|-------------------------|----------------|-------------|-------|-------|
| 274.3600 | 2.35 | 12.75 | 18.4 | 33.5 | 46.0 | -12.5 | 247 | 2.1 |
| 324.2500 | 2.80 | 14.60 | 14.6 | 32.0 | 46.0 | -14.0 | 56 | 1.92 |
| 570.1800 | 3.69 | 18.69 | 12.7 | 35.1 | 46.0 | -10.9 | 196 | 1.61 |
| 647.6800 | 4.72 | 20.14 | 10.8 | 35.7 | 46.0 | -10.3 | 36 | 1.45 |
| 895.0200 | 4.69 | 24.06 | 7.5 | 36.2 | 46.0 | -9.8 | 74 | 1.5 |
| 926.2100 | 4.81 | 23.50 | 7.0 | 35.3 | 46.0 | -10.7 | 204 | 1.18 |

Antenna Polarization: Vertical

| Frequency (MHz) | Cable Loss (dB) | Antenna Factor (dB/m) | Reading Data (dBμV) | Emission Level (dBμV/m) | Limit (dBμV/m) | Margin (dB) | AZ(°) | EL(m) |
|-----------------|-----------------|-----------------------|---------------------|-------------------------|----------------|-------------|-------|-------|
| 167.2500 | 1.95 | 8.59 | 21.2 | 31.7 | 43.5 | -11.8 | 215 | 1.1 |
| 400.2700 | 3.12 | 16.20 | 16.3 | 35.6 | 46.0 | -10.4 | 278 | 1.2 |
| 501.8900 | 3.51 | 17.52 | 11.0 | 32.0 | 46.0 | -14.0 | 170 | 1.4 |
| 516.3800 | 3.56 | 17.77 | 10.2 | 31.5 | 46.0 | -14.5 | 78 | 1.5 |
| 833.9800 | 4.78 | 22.32 | 7.2 | 34.3 | 46.0 | -11.7 | 307 | 1.65 |
| 904.7400 | 4.72 | 24.09 | 7.0 | 35.8 | 46.0 | -10.2 | 147 | 1.89 |

NOTE :

1. Measurement uncertainty is +/- 3.7dB.
2. "": Measurement does not apply for this frequency.
3. Emission Level = Reading Value + Ant. Factor + Cable Loss.
4. The field strength of other emission frequencies were very low against the limit.



TEST REPORT

| | | | |
|--------------------|---------------|--------------------|----------------|
| Temperature: | 24 °C | Humidity: | 68 %RH |
| Frequency Range: | 1 – 25 GHz | Measured Distance: | 3m |
| Receiver Detector: | PK. or AV. | Tested Mode: | IEEE 802.11g |
| Tested By: | Wayne Lin | Tested Channel: | CH 1 : 2412MHz |
| Tested Date: | Nov. 12, 2008 | Modulation Type: | OFDM |

Antenna Polarization : Horizontal

| Frequency (MHz) | Correct Factor (dB) | Ant. Factor (dB/m) | Reading Data (dB μ V) | | Emission Level (dB μ V/m) | | Limit (dB μ V/m) | | Margin (dB) | | AZ (°) | EL (m) |
|-----------------|---------------------|--------------------|---------------------------|------|-------------------------------|------|----------------------|------|-------------|------|--------|--------|
| | | | PK. | AV. | PK. | AV. | PK. | AV. | PK. | AV. | | |
| 2412.00 | -32.18 | 28.56 | 90.3 | 82.4 | 86.7 | 78.8 | 74.0 | 54.0 | NA | NA | 325 | 1.54 |
| 4824.00 | -30.41 | 33.66 | 50.3 | 42.4 | 53.5 | 45.6 | 74.0 | 54.0 | -20.5 | -8.4 | 145 | 1.61 |
| 7248.00 | -29.01 | 36.30 | 41.3 | * | 48.6 | * | 74.0 | 54.0 | -25.4 | * | 54 | 1.43 |
| 1205.32 | -33.86 | 24.65 | 41.0 | * | 31.8 | * | 74.0 | 54.0 | -42.2 | * | 306 | 1.65 |
| 1290.65 | -33.77 | 24.84 | 40.1 | * | 31.2 | * | 74.0 | 54.0 | -42.8 | * | 143 | 1.42 |
| 1958.27 | -32.55 | 27.04 | 40.0 | * | 34.5 | * | 74.0 | 54.0 | -39.5 | * | 156 | 1.5 |

Antenna Polarization : Vertical

| Frequency (MHz) | Correct Factor (dB) | Ant. Factor (dB/m) | Reading Data (dB μ V) | | Emission Level (dB μ V/m) | | Limit (dB μ V/m) | | Margin (dB) | | AZ (°) | EL (m) |
|-----------------|---------------------|--------------------|---------------------------|------|-------------------------------|------|----------------------|------|-------------|------|--------|--------|
| | | | PK. | AV. | PK. | AV. | PK. | AV. | PK. | AV. | | |
| 2412.00 | -32.18 | 28.02 | 89.5 | 81.6 | 85.3 | 77.4 | 74.0 | 54.0 | NA | NA | 215 | 1.20 |
| 4824.00 | -30.41 | 33.66 | 50.3 | 43.8 | 53.5 | 47.0 | 74.0 | 54.0 | -20.5 | -7.0 | 184 | 1.34 |
| 9648.00 | -28.65 | 37.86 | 40.3 | * | 49.5 | * | 74.0 | 54.0 | -24.5 | * | 65 | 1.42 |
| 1102.87 | -34.74 | 24.42 | 42.3 | * | 32.0 | * | 74.0 | 54.0 | -42.0 | * | 173 | 1.56 |
| 1302.86 | -33.75 | 24.86 | 41.1 | * | 32.2 | * | 74.0 | 54.0 | -41.8 | * | 347 | 1.52 |
| 1582.94 | -32.97 | 25.61 | 40.1 | * | 32.7 | * | 74.0 | 54.0 | -41.3 | * | 68 | 1.65 |

NOTE :

1. Measurement uncertainty is +/- 3.7dB.
2. "**": The Peak reading value also meets average limit and measurement with the average detector is unnecessary.
3. Emission Level = Reading Value + Ant. Factor + Correct Factor (incl.:Cable Loss and Pre-Amplifier Gain)
4. The field strength of other emission frequencies were very low against the limit.
5. (F):The field strength of fundamental frequency.



TEST REPORT

| | | | |
|--------------------|---------------|--------------------|----------------|
| Temperature: | 24 °C | Humidity: | 68 %RH |
| Frequency Range: | 1 – 25 GHz | Measured Distance: | 3m |
| Receiver Detector: | PK. or AV. | Tested Mode: | IEEE 802.11g |
| Tested By: | Wayne Lin | Tested Channel: | CH 6 : 2437MHz |
| Tested Date: | Nov. 12, 2008 | Modulation Type: | OFDM |

Antenna Polarization : Horizontal

| Frequency (MHz) | Correct Factor (dB) | Ant. Factor (dB/m) | Reading Data (dB μ V) | | Emission Level (dB μ V/m) | | Limit (dB μ V/m) | | Margin (dB) | | AZ (°) | EL (m) |
|-----------------|---------------------|--------------------|---------------------------|------|-------------------------------|------|----------------------|------|-------------|------|--------|--------|
| | | | PK. | AV. | PK. | AV. | PK. | AV. | PK. | AV. | | |
| 2437.00 | -32.22 | 28.61 | 90.3 | 83.2 | 86.7 | 79.6 | 74.0 | 54.0 | NA | NA | 201 | 1.80 |
| 4874.00 | -30.28 | 33.70 | 50.3 | 41.2 | 53.7 | 44.6 | 74.0 | 54.0 | -20.3 | -9.4 | 251 | 1.75 |
| 7311.00 | -29.07 | 36.35 | 40.3 | * | 47.6 | * | 74.0 | 54.0 | -26.4 | * | 36 | 1.45 |
| 1207.90 | -33.85 | 24.66 | 40.2 | * | 31.0 | * | 74.0 | 54.0 | -43.0 | * | 78 | 1.32 |
| 1253.20 | -33.68 | 24.76 | 41.3 | * | 32.4 | * | 74.0 | 54.0 | -41.6 | * | 314 | 1.21 |
| 1302.98 | -33.75 | 24.86 | 40.1 | * | 31.2 | * | 74.0 | 54.0 | -42.8 | * | 284 | 1.20 |

Antenna Polarization : Vertical

| Frequency (MHz) | Correct Factor (dB) | Ant. Factor (dB/m) | Reading Data (dB μ V) | | Emission Level (dB μ V/m) | | Limit (dB μ V/m) | | Margin (dB) | | AZ (°) | EL (m) |
|-----------------|---------------------|--------------------|---------------------------|------|-------------------------------|------|----------------------|------|-------------|------|--------|--------|
| | | | PK. | AV. | PK. | AV. | PK. | AV. | PK. | AV. | | |
| 2437.00 | -32.22 | 28.07 | 89.7 | 82.6 | 85.6 | 78.5 | 74.0 | 54.0 | NA | NA | 56 | 1.10 |
| 4874.00 | -30.28 | 33.70 | 50.2 | 43.9 | 53.6 | 47.3 | 74.0 | 54.0 | -20.4 | -6.7 | 312 | 1.23 |
| 7311.00 | -29.07 | 36.35 | 40.2 | * | 47.5 | * | 74.0 | 54.0 | -26.5 | * | 175 | 1.45 |
| 1103.20 | -34.74 | 24.43 | 42.3 | * | 32.0 | * | 74.0 | 54.0 | -42.0 | * | 250 | 1.50 |
| 1205.00 | -33.86 | 24.65 | 43.8 | * | 34.6 | * | 74.0 | 54.0 | -39.4 | * | 52 | 1.47 |
| 1253.10 | -33.68 | 24.76 | 41.0 | * | 32.1 | * | 74.0 | 54.0 | -41.9 | * | 290 | 1.32 |

NOTE :

1. Measurement uncertainty is +/- 3.7dB.
2. "**": The Peak reading value also meets average limit and measurement with the average detector is unnecessary.
3. Emission Level = Reading Value + Ant. Factor + Correct Factor (incl.:Cable Loss and Pre-Amplifier Gain)
4. The field strength of other emission frequencies were very low against the limit.
5. (F):The field strength of fundamental frequency.



TEST REPORT

| | | | |
|--------------------|---------------|--------------------|-----------------|
| Temperature: | 24 °C | Humidity: | 68 %RH |
| Frequency Range: | 1 – 25 GHz | Measured Distance: | 3m |
| Receiver Detector: | PK. or AV. | Tested Mode: | IEEE 802.11g |
| Tested By: | Wayne Lin | Tested Channel: | CH 11 : 2462MHz |
| Tested Date: | Nov. 12, 2008 | Modulation Type: | OFDM |

Antenna Polarization : Horizontal

| Frequency (MHz) | Correct Factor (dB) | Ant. Factor (dB/m) | Reading Data (dB μ V) | | Emission Level (dB μ V/m) | | Limit (dB μ V/m) | | Margin (dB) | | AZ (°) | EL (m) |
|-----------------|---------------------|--------------------|---------------------------|------|-------------------------------|------|----------------------|------|-------------|-------|--------|--------|
| | | | PK. | AV. | PK. | AV. | PK. | AV. | PK. | AV. | | |
| 2462.00 | -32.22 | 28.69 | 90.2 | 81.3 | 86.7 | 77.8 | 74.0 | 54.0 | NA | NA | 189 | 1.75 |
| 4924.00 | -30.23 | 33.74 | 50.6 | 42.8 | 54.1 | 46.3 | 74.0 | 54.0 | -19.9 | -7.7 | 165 | 1.60 |
| 7386.00 | -28.94 | 36.41 | 41.8 | * | 49.3 | * | 74.0 | 54.0 | -24.7 | * | 256 | 1.54 |
| 1103.23 | -34.74 | 24.43 | 42.5 | * | 32.2 | * | 74.0 | 54.0 | -41.8 | * | 98 | 1.44 |
| 1205.40 | -33.86 | 24.65 | 45.1 | 41.3 | 35.9 | 32.1 | 74.0 | 54.0 | -38.1 | -21.9 | 325 | 1.27 |
| 1305.84 | -33.69 | 24.87 | 40.1 | * | 31.3 | * | 74.0 | 54.0 | -42.7 | * | 270 | 1.15 |

Antenna Polarization : Vertical

| Frequency (MHz) | Correct Factor (dB) | Ant. Factor (dB/m) | Reading Data (dB μ V) | | Emission Level (dB μ V/m) | | Limit (dB μ V/m) | | Margin (dB) | | AZ (°) | EL (m) |
|-----------------|---------------------|--------------------|---------------------------|------|-------------------------------|------|----------------------|------|-------------|-------|--------|--------|
| | | | PK. | AV. | PK. | AV. | PK. | AV. | PK. | AV. | | |
| 2462.00 | -32.22 | 28.12 | 90.2 | 84.3 | 86.1 | 80.2 | 74.0 | 54.0 | NA | NA | 254 | 1.10 |
| 4924.00 | -30.23 | 33.74 | 50.6 | 42.8 | 54.1 | 46.3 | 74.0 | 54.0 | -19.9 | -7.7 | 145 | 1.21 |
| 7386.00 | -28.94 | 36.41 | 40.2 | * | 47.7 | * | 74.0 | 54.0 | -26.3 | * | 63 | 1.34 |
| 1152.78 | -34.55 | 24.53 | 44.8 | 40.2 | 34.8 | 30.2 | 74.0 | 54.0 | -39.2 | -23.8 | 304 | 1.45 |
| 1205.41 | -33.86 | 24.65 | 41.0 | * | 31.8 | * | 74.0 | 54.0 | -42.2 | * | 75 | 1.65 |
| 1305.28 | -33.69 | 24.87 | 40.8 | * | 32.0 | * | 74.0 | 54.0 | -42.0 | * | 84 | 1.98 |

NOTE :

1. Measurement uncertainty is +/- 3.7dB.
2. "*": The Peak reading value also meets average limit and measurement with the average detector is unnecessary.
3. Emission Level = Reading Value + Ant. Factor + Correct Factor (incl.:Cable Loss and Pre-Amplifier Gain)
4. The field strength of other emission frequencies were very low against the limit.
5. (F):The field strength of fundamental frequency.



TEST REPORT

| | | | |
|--------------------|---------------|--------------------|----------------|
| Temperature: | 24 °C | Humidity: | 68 %RH |
| Frequency Range: | 1 – 25 GHz | Measured Distance: | 3m |
| Receiver Detector: | PK. or AV. | Tested Mode: | IEEE 802.11b |
| Tested By: | Wayne Lin | Tested Channel: | CH 1 : 2412MHz |
| Tested Date: | Nov. 12, 2008 | Modulation Type: | CCK |

Antenna Polarization : Horizontal

| Frequency (MHz) | Correct Factor (dB) | Ant. Factor (dB/m) | Reading Data (dB μ V) | | Emission Level (dB μ V/m) | | Limit (dB μ V/m) | | Margin (dB) | | AZ (°) | EL (m) |
|-----------------|---------------------|--------------------|---------------------------|------|-------------------------------|------|----------------------|------|-------------|------|--------|--------|
| | | | PK. | AV. | PK. | AV. | PK. | AV. | PK. | AV. | | |
| 2412.00 | -32.18 | 28.56 | 90.3 | 82.4 | 86.7 | 78.8 | 74.0 | 54.0 | NA | NA | 212 | 1.52 |
| 4824.00 | -30.41 | 33.66 | 52.1 | 44.2 | 55.3 | 47.4 | 74.0 | 54.0 | -18.7 | -6.6 | 145 | 1.47 |
| 7236.00 | -28.98 | 36.29 | 42.3 | * | 49.6 | * | 74.0 | 54.0 | -24.4 | * | 54 | 1.32 |
| 1204.89 | -33.86 | 24.65 | 41.3 | * | 32.1 | * | 74.0 | 54.0 | -41.9 | * | 85 | 1.54 |
| 1355.23 | -32.68 | 24.98 | 43.2 | * | 35.5 | * | 74.0 | 54.0 | -38.5 | * | 104 | 1.52 |
| 1609.70 | -32.89 | 25.71 | 40.1 | * | 32.9 | * | 74.0 | 54.0 | -41.1 | * | 214 | 1.63 |

Antenna Polarization : Vertical

| Frequency (MHz) | Correct Factor (dB) | Ant. Factor (dB/m) | Reading Data (dB μ V) | | Emission Level (dB μ V/m) | | Limit (dB μ V/m) | | Margin (dB) | | AZ (°) | EL (m) |
|-----------------|---------------------|--------------------|---------------------------|------|-------------------------------|------|----------------------|------|-------------|------|--------|--------|
| | | | PK. | AV. | PK. | AV. | PK. | AV. | PK. | AV. | | |
| 2412.00 | -32.18 | 28.02 | 90.1 | 83.5 | 85.9 | 79.3 | 74.0 | 54.0 | NA | NA | 147 | 1.10 |
| 4824.00 | -30.41 | 33.66 | 50.3 | 42.8 | 53.5 | 46.0 | 74.0 | 54.0 | -20.5 | -8.0 | 154 | 1.39 |
| 9648.00 | -28.65 | 37.86 | 42.3 | * | 51.5 | * | 74.0 | 54.0 | -22.5 | * | 62 | 1.54 |
| 1204.80 | -33.86 | 24.65 | 42.8 | * | 33.6 | * | 74.0 | 54.0 | -40.4 | * | 186 | 1.38 |
| 1399.87 | -31.72 | 25.08 | 40.1 | * | 33.5 | * | 74.0 | 54.0 | -40.5 | * | 85 | 1.62 |
| 2412.00 | -32.18 | 28.02 | 41.3 | * | 34.1 | * | 74.0 | 54.0 | -39.9 | * | 265 | 1.24 |

NOTE :

1. Measurement uncertainty is +/- 3.7dB.
2. "**": The Peak reading value also meets average limit and measurement with the average detector is unnecessary.
3. Emission Level = Reading Value + Ant. Factor + Correct Factor (incl.: Cable Loss and Pre-Amplifier Gain)
4. The field strength of other emission frequencies were very low against the limit.
5. (F): The field strength of fundamental frequency.



TEST REPORT

| | | | |
|--------------------|---------------|--------------------|----------------|
| Temperature: | 24 °C | Humidity: | 68 %RH |
| Frequency Range: | 1 – 25 GHz | Measured Distance: | 3m |
| Receiver Detector: | PK. or AV. | Tested Mode: | IEEE 802.11b |
| Tested By: | Wayne Lin | Tested Channel: | CH 6 : 2437MHz |
| Tested Date: | Nov. 12, 2008 | Modulation Type: | CCK |

Antenna Polarization : Horizontal

| Frequency (MHz) | Correct Factor (dB) | Ant. Factor (dB/m) | Reading Data (dB μ V) | | Emission Level (dB μ V/m) | | Limit (dB μ V/m) | | Margin (dB) | | AZ (°) | EL (m) |
|-----------------|---------------------|--------------------|---------------------------|------|-------------------------------|------|----------------------|------|-------------|------|--------|--------|
| | | | PK. | AV. | PK. | AV. | PK. | AV. | PK. | AV. | | |
| 2437.00 | -32.22 | 28.61 | 89.0 | 84.3 | 85.4 | 80.7 | 74.0 | 54.0 | NA | NA | 204 | 1.75 |
| 4874.00 | -30.28 | 33.70 | 50.3 | 44.1 | 53.7 | 47.5 | 74.0 | 54.0 | -20.3 | -6.5 | 145 | 1.63 |
| 7311.00 | -29.07 | 36.35 | 40.3 | * | 47.6 | * | 74.0 | 54.0 | -26.4 | * | 65 | 1.54 |
| 1204.87 | -33.86 | 24.65 | 41.2 | * | 32.0 | * | 74.0 | 54.0 | -42.0 | * | 67 | 1.35 |
| 1355.20 | -32.68 | 24.98 | 47.3 | * | 39.6 | * | 74.0 | 54.0 | -34.4 | * | 324 | 1.30 |
| 1610.23 | -32.89 | 25.72 | 40.0 | * | 32.8 | * | 74.0 | 54.0 | -41.2 | * | 271 | 1.20 |

Antenna Polarization : Vertical

| Frequency (MHz) | Correct Factor (dB) | Ant. Factor (dB/m) | Reading Data (dB μ V) | | Emission Level (dB μ V/m) | | Limit (dB μ V/m) | | Margin (dB) | | AZ (°) | EL (m) |
|-----------------|---------------------|--------------------|---------------------------|------|-------------------------------|------|----------------------|------|-------------|------|--------|--------|
| | | | PK. | AV. | PK. | AV. | PK. | AV. | PK. | AV. | | |
| 2437.00 | -32.22 | 28.07 | 90.1 | 83.3 | 86.0 | 79.2 | 74.0 | 54.0 | NA | NA | 282 | 1.10 |
| 4874.00 | -30.28 | 33.70 | 51.2 | 44.3 | 54.6 | 47.7 | 74.0 | 54.0 | -19.4 | -6.3 | 154 | 1.20 |
| 7311.00 | -29.07 | 36.35 | 40.8 | * | 48.1 | * | 74.0 | 54.0 | -25.9 | * | 173 | 1.42 |
| 1205.10 | -33.86 | 24.65 | 42.4 | * | 33.2 | * | 74.0 | 54.0 | -40.8 | * | 65 | 1.48 |
| 1400.20 | -31.70 | 25.08 | 40.1 | * | 33.5 | * | 74.0 | 54.0 | -40.5 | * | 56 | 1.25 |
| 1610.30 | -32.89 | 25.72 | 41.3 | * | 34.1 | * | 74.0 | 54.0 | -39.9 | * | 295 | 1.48 |

NOTE :

1. Measurement uncertainty is +/- 3.7dB.
2. "": The Peak reading value also meets average limit and measurement with the average detector is unnecessary.
3. Emission Level = Reading Value + Ant. Factor + Correct Factor (incl.: Cable Loss and Pre-Amplifier Gain)
4. The field strength of other emission frequencies were very low against the limit.
5. (F): The field strength of fundamental frequency.



TEST REPORT

| | | | |
|--------------------|---------------|--------------------|-----------------|
| Temperature: | 24 °C | Humidity: | 68 %RH |
| Frequency Range: | 1 – 25 GHz | Measured Distance: | 3m |
| Receiver Detector: | PK. or AV. | Tested Mode: | IEEE 802.11b |
| Tested By: | Wayne Lin | Tested Channel: | CH 11 : 2462MHz |
| Tested Date: | Nov. 12, 2008 | Modulation Type: | CCK |

Antenna Polarization : Horizontal

| Frequency (MHz) | Correct Factor (dB) | Ant. Factor (dB/m) | Reading Data (dB μ V) | | Emission Level (dB μ V/m) | | Limit (dB μ V/m) | | Margin (dB) | | AZ (°) | EL (m) |
|-----------------|---------------------|--------------------|---------------------------|------|-------------------------------|------|----------------------|------|-------------|------|--------|--------|
| | | | PK. | AV. | PK. | AV. | PK. | AV. | PK. | AV. | | |
| 2462.00 | -32.22 | 28.69 | 90.2 | 81.6 | 86.7 | 78.1 | 74.0 | 54.0 | NA | NA | 57 | 1.75 |
| 4924.00 | -30.23 | 33.74 | 50.6 | 42.8 | 54.1 | 46.3 | 74.0 | 54.0 | -19.9 | -7.7 | 170 | 1.65 |
| 7386.00 | -28.94 | 36.41 | 40.2 | * | 47.7 | * | 74.0 | 54.0 | -26.3 | * | 308 | 1.56 |
| 1208.40 | -33.85 | 24.66 | 40.0 | * | 30.8 | * | 74.0 | 54.0 | -43.2 | * | 204 | 1.48 |
| 1403.20 | -31.58 | 25.09 | 41.3 | * | 34.8 | * | 74.0 | 54.0 | -39.2 | * | 157 | 1.26 |
| 1642.80 | -32.76 | 25.84 | 40.1 | * | 33.2 | * | 74.0 | 54.0 | -40.8 | * | 140 | 1.20 |

Antenna Polarization : Vertical

| Frequency (MHz) | Correct Factor (dB) | Ant. Factor (dB/m) | Reading Data (dB μ V) | | Emission Level (dB μ V/m) | | Limit (dB μ V/m) | | Margin (dB) | | AZ (°) | EL (m) |
|-----------------|---------------------|--------------------|---------------------------|------|-------------------------------|------|----------------------|------|-------------|------|--------|--------|
| | | | PK. | AV. | PK. | AV. | PK. | AV. | PK. | AV. | | |
| 2462.00 | -32.22 | 28.12 | 89.4 | 82.6 | 85.3 | 78.5 | 74.0 | 54.0 | NA | NA | 56 | 1.10 |
| 4924.00 | -30.23 | 33.74 | 50.1 | 42.6 | 53.6 | 46.1 | 74.0 | 54.0 | -20.4 | -7.9 | 178 | 1.21 |
| 7386.00 | -28.94 | 36.41 | 40.5 | * | 48.0 | * | 74.0 | 54.0 | -26.0 | * | 130 | 1.39 |
| 1275.65 | -33.73 | 24.81 | 42.8 | * | 33.9 | * | 74.0 | 54.0 | -40.1 | * | 264 | 1.45 |
| 1643.30 | -32.76 | 25.84 | 40.2 | * | 33.3 | * | 74.0 | 54.0 | -40.7 | * | 48 | 1.54 |
| 1868.20 | -32.91 | 26.70 | 40.0 | * | 33.8 | * | 74.0 | 54.0 | -40.2 | * | 102 | 1.84 |

NOTE :

1. Measurement uncertainty is +/- 3.7dB.
2. "**": The Peak reading value also meets average limit and measurement with the average detector is unnecessary.
3. Emission Level = Reading Value + Ant. Factor + Correct Factor (incl.:Cable Loss and Pre-Amplifier Gain)
4. The field strength of other emission frequencies were very low against the limit.
5. (F):The field strength of fundamental frequency.



4.3 6dB BANDWIDTH TEST

4.3.1 LIMIT

FCC Part15, Subpart C Section 15.247 (a)(2).

The minimum 6 dB bandwidth shall be at least 500kHz.

4.3.2 TEST EQUIPMENT

The following test equipment was used during the test:

| EQUIPMENT/ FACILITIES | SPECIFICATIONS | MANUFACTURER | MODEL#/ SERIAL# | DUE DATE OF CAL. & CAL. CENTER |
|--------------------------|----------------|--------------------|--------------------|-----------------------------------|
| SPECTRUM | 9kHz-40GHz | ROHDE & SCHWARZ | FSP40/ 100093 | SEP. 2009 ETC |

NOTE: The calibration interval of the above test equipment is one year and the calibrations are traceable to NML/ROC and NIST/USA.

4.3.3 TEST SET-UP

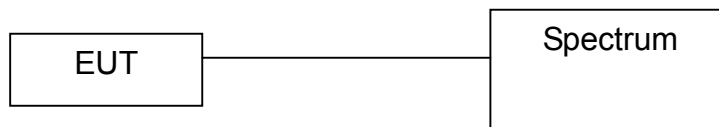

The EUT was connected to a spectrum through a 50Ω RF cable.

4.3.4 TEST PROCEDURE

The EUT was operated in hopping mode or any specific channel.
 Printed out the test result from the spectrum by hard copy function.

4.3.5 EUT OPERATING CONDITION

Same as section 4.1.5 of this report.



4.3.6 TEST RESULT

| | | | |
|--------------------|---------------|------------------|--------------|
| Temperature: | 22°C | Humidity: | 69%RH |
| Spectrum Detector: | PK. | Tested Mode: | IEEE 802.11g |
| Tested By: | Wayne Lin | Modulation Type: | OFDM |
| Tested Date: | Nov. 19, 2008 | | |

| CHANNEL NUMBER | CHANNEL FREQUENCY (MHz) | 6dB DOWN BW (MHz) |
|----------------|-------------------------|-------------------|
| 1 | 2412 | 16.32 |
| 6 | 2437 | 16.44 |
| 11 | 2462 | 16.32 |

CH1:

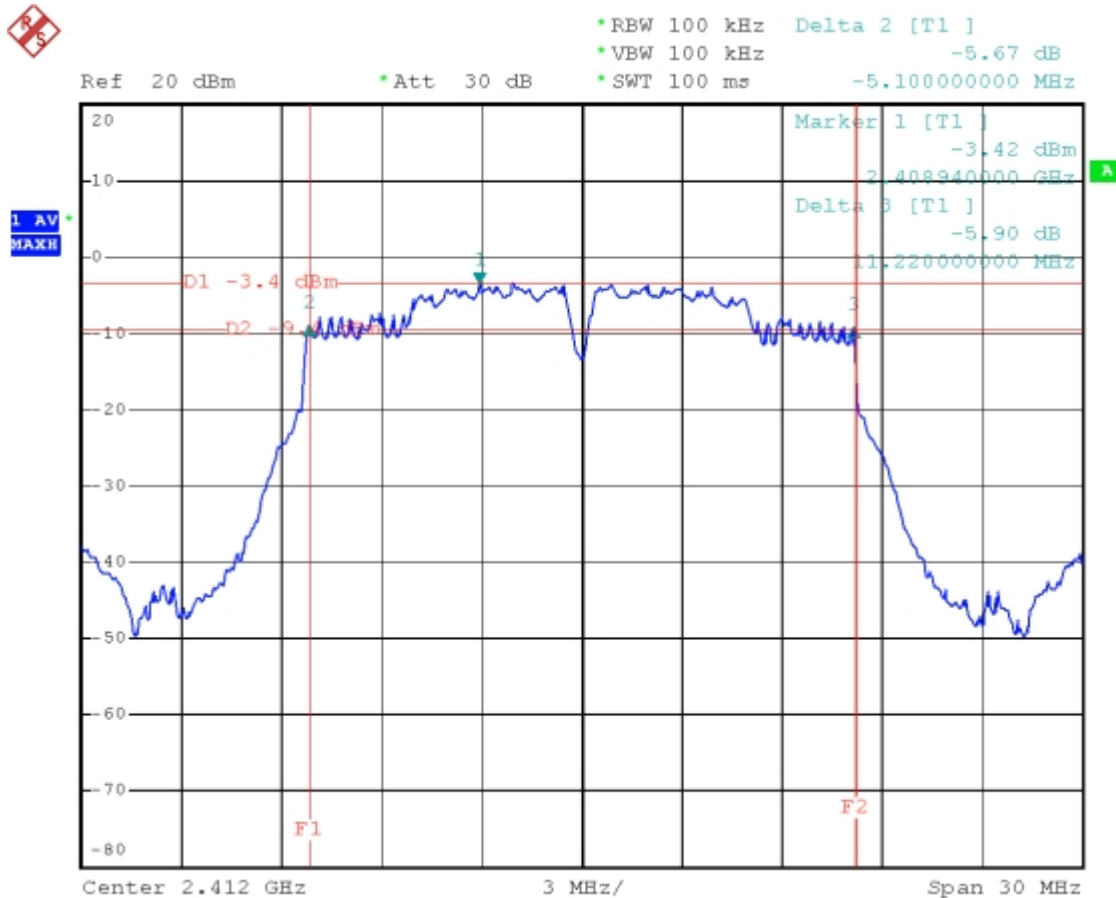



CH 6:

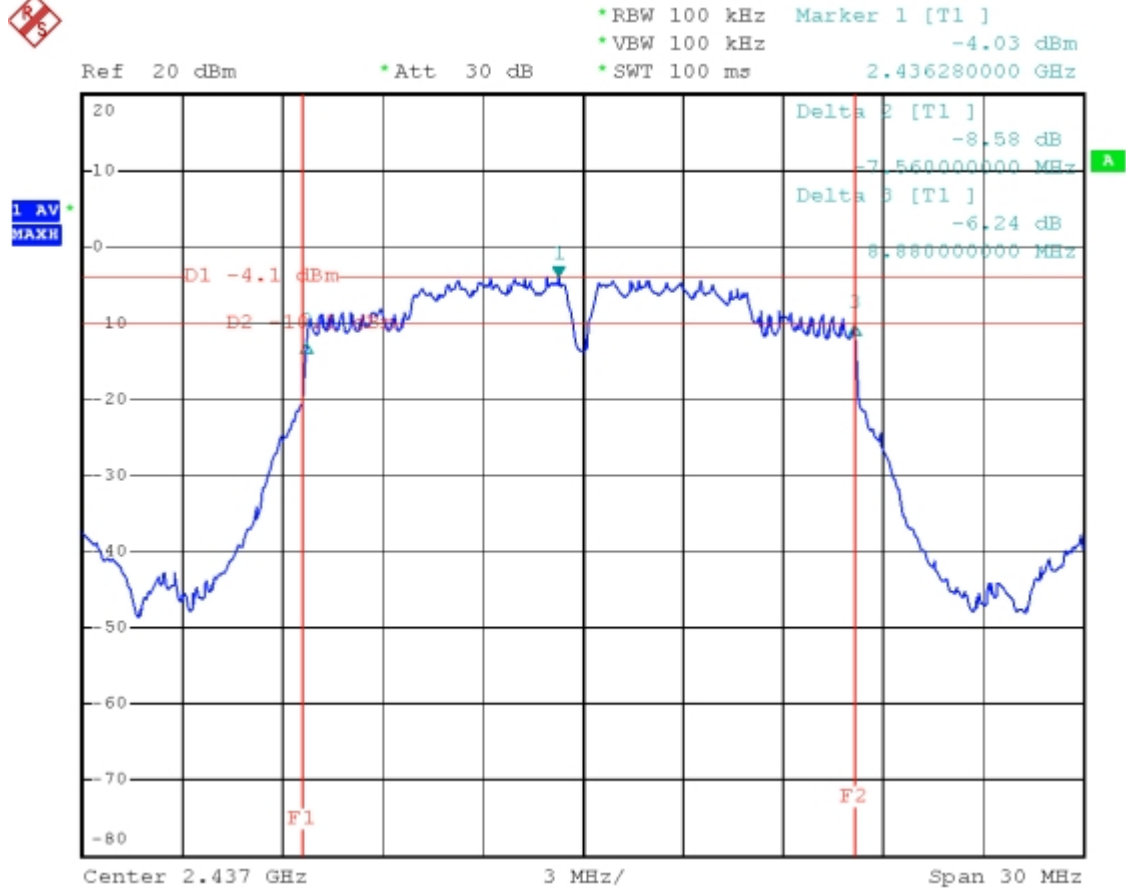



CH 11:

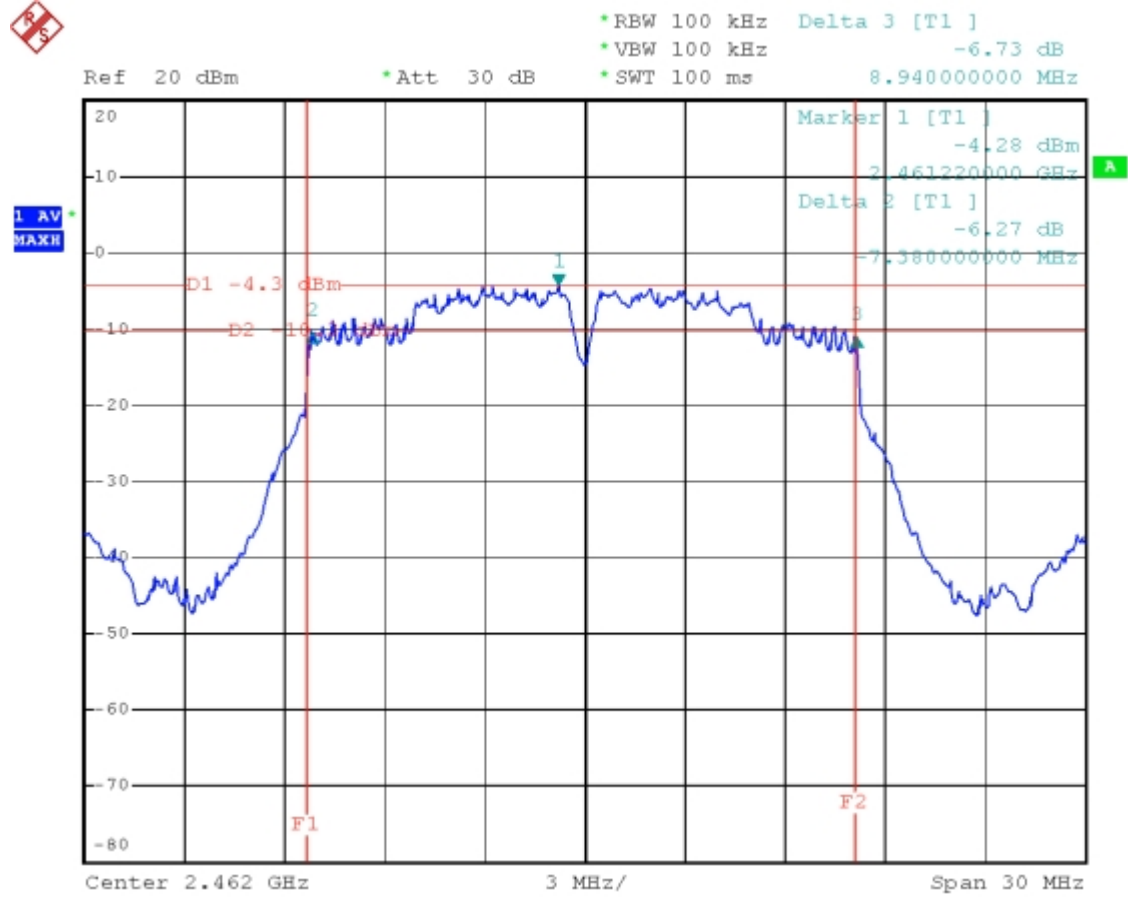



Spectrum Research & Testing Lab., Inc.
 No. 101-10, Ling 8,
 Shan-Tong Li, Chung-Li
 City, Taoyuan, Taiwan

TEST REPORT

Reference No.: A08092401
 Report No.: FCCA08092401
 FCC ID: W3Q-WL850R
 Page: 39 of 73
 Date: Nov. 27, 2008

| | | | |
|--------------------|----------------------|------------------|---------------------|
| Temperature: | <u>22°C</u> | Humidity: | <u>69%RH</u> |
| Spectrum Detector: | <u>PK.</u> | Tested Mode: | <u>IEEE 802.11b</u> |
| Tested By: | <u>Wayne Lin</u> | Modulation Type: | <u>CCK</u> |
| Tested Date: | <u>Nov. 19, 2008</u> | | |

| CHANNEL NUMBER | CHANNEL FREQUENCY (MHz) | 6dB DOWN BW (MHz) |
|----------------|-------------------------|-------------------|
| 1 | 2412 | 11.04 |
| 6 | 2437 | 12.12 |
| 11 | 2462 | 12.18 |

CH1:

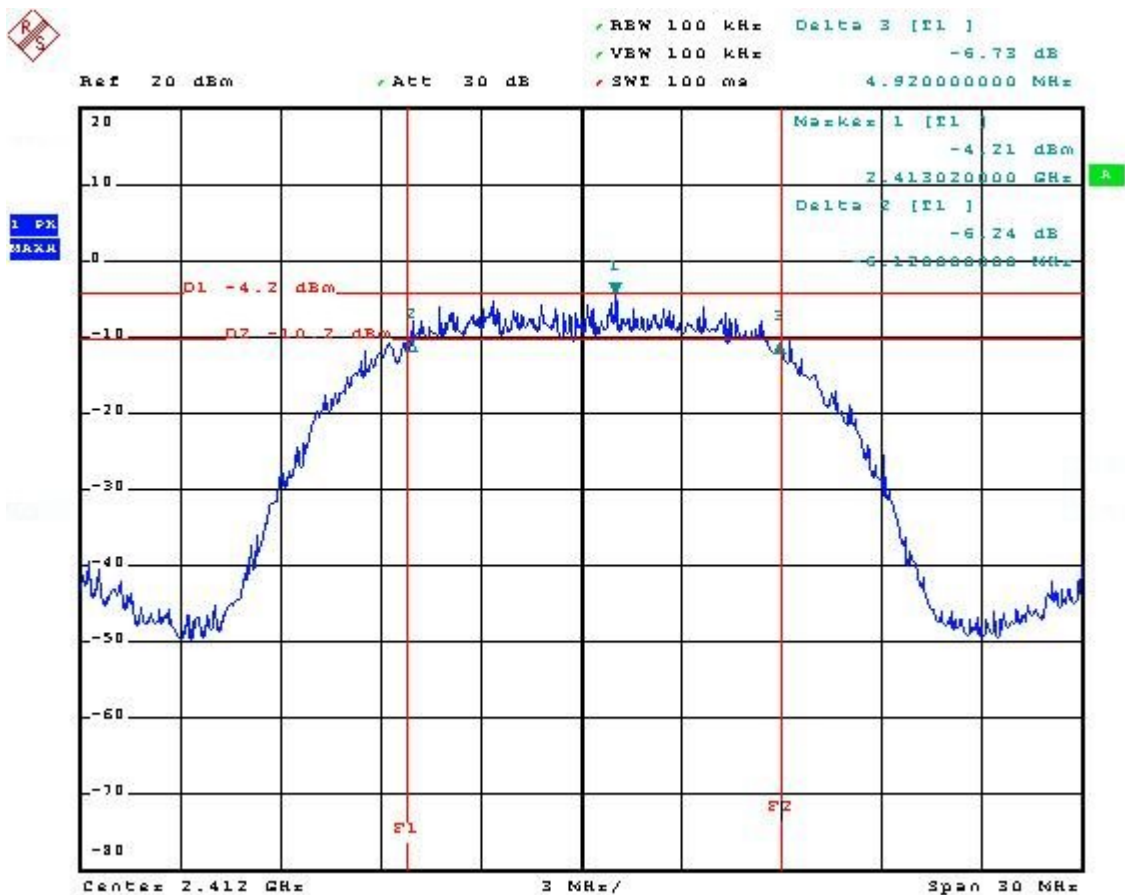



TEST REPORT

CH6

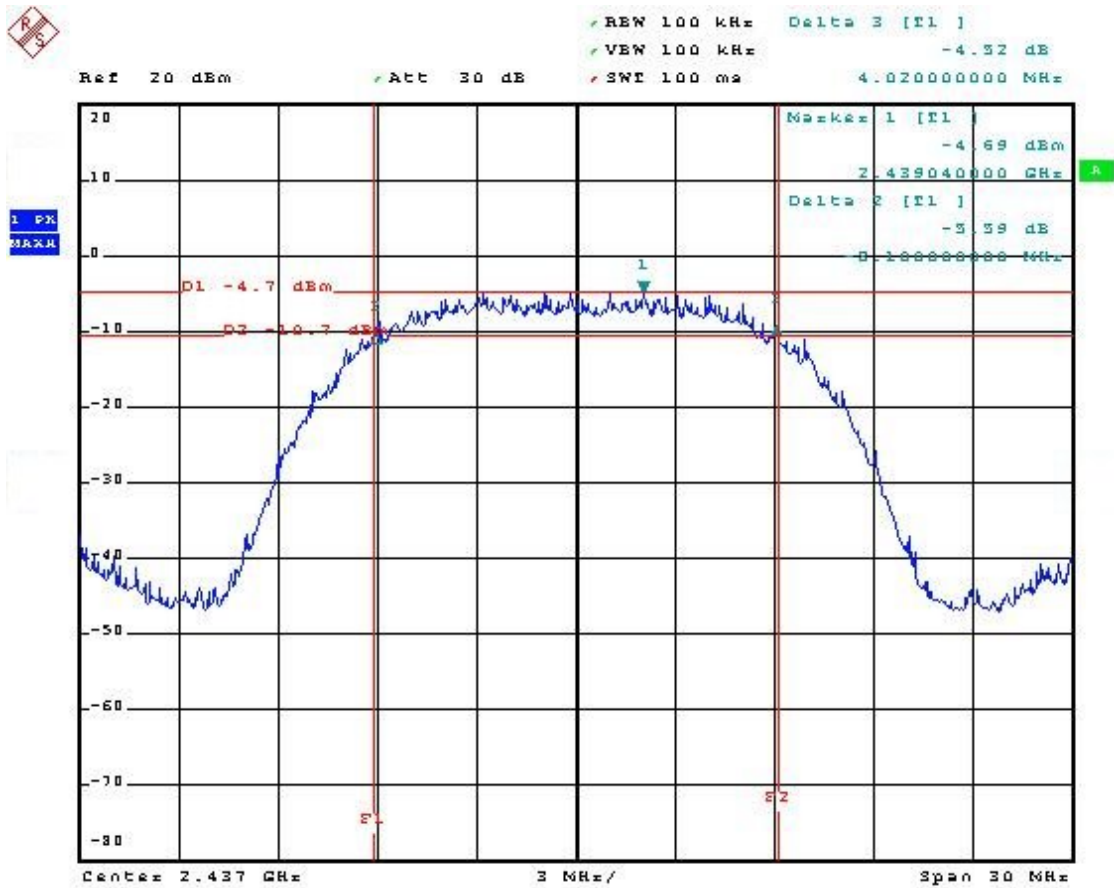



TEST REPORT

CH11

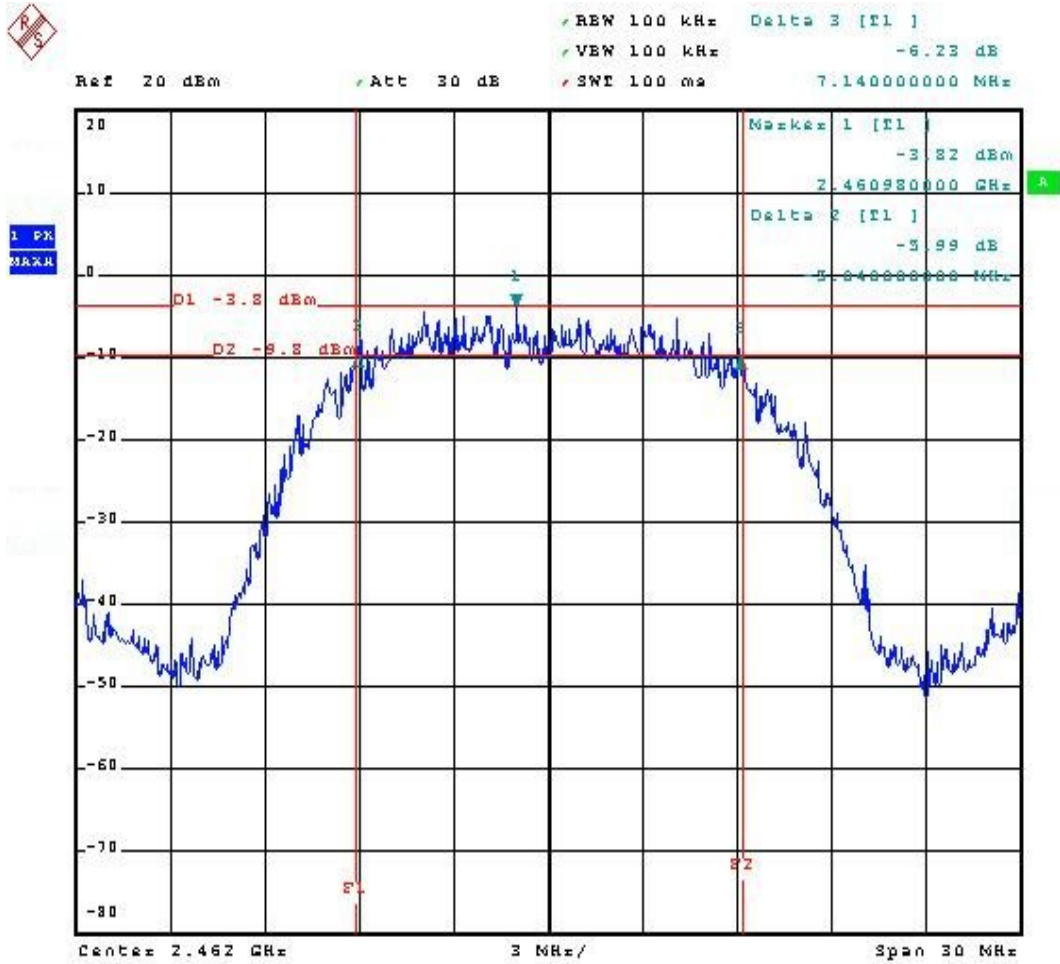



Spectrum Research & Testing Lab., Inc.
 No. 101-10, Ling 8,
 Shan-Tong Li, Chung-Li
 City, Taoyuan, Taiwan

TEST REPORT

Reference No.: A08092401
 Report No.: FCCA08092401
 FCC ID: W3Q-WL850R
 Page: 42 of 73
 Date: Nov. 27, 2008

4.4 PEAK POWER TEST

4.4.1 LIMIT

FCC Part15, Subpart C Section 15.247.

| Frequency Range (MHz) | Limit(w) | | | | |
|-----------------------|-----------------------------|----------|--------------|--------------|----------|
| | Quantity of Hopping Channel | 50 | 25 | 15 | 75 |
| 902-928 | | 1(30dBm) | 0.125(21dBm) | NA | NA |
| 2400-2483.5 | | NA | NA | 0.125(21dBm) | 1(30dBm) |
| 5725-5850 | | NA | NA | NA | 1(30dBm) |

4.4.2 TEST EQUIPMENT

The following test equipment was used during the test:

| EQUIPMENT/ FACILITIES | SPECIFICATIONS | MANUFACTURER | MODEL#/ SERIAL# | DUE DATE OF CAL. & CAL. CENTER |
|-----------------------|-----------------|-----------------|-----------------|--------------------------------|
| SPECTRUM | 9kHz-40GHz | ROHDE & SCHWARZ | FSP40/ 100093 | SEP. 2009 ETC |
| POWER METER | N/A | BOONTON | 4232A/ 29001 | MAY 2009 ETC |
| POWER SENSOR | DC-8GHz 50 Ω | BOONTON | 51011EMC/ 31181 | JUN. 2009 ETC |

NOTE: The calibration interval of the above test equipment is one year and the calibrations are traceable to NML/ROC and NIST/USA.



4.4.3 TEST SET-UP

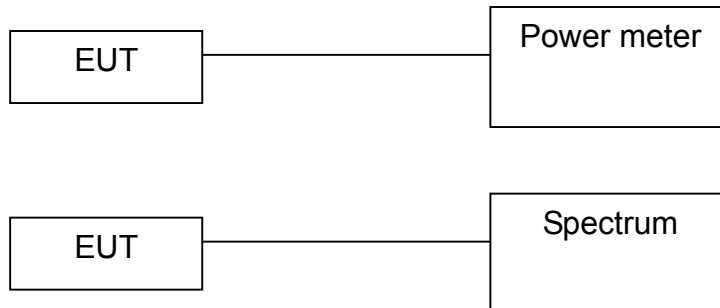

The EUT was connected to a spectrum through a 50Ω RF cable.

4.4.4 TEST PROCEDURE

The EUT was operating in hopping mode or could control its channel.
Printed out the test result from the spectrum by hard copy function.
Recorded the read value of the power meter.

4.4.5 EUT OPERATING CONDITION

Same as section 4.1.5 of this report.



4.4.6 TEST RESULT

| | | | |
|--------------------|---------------|------------------|--------------|
| Temperature: | 22°C | Humidity: | 69%RH |
| Spectrum Detector: | PK. | Tested Mode: | IEEE 802.11g |
| Tested By: | Wayne Lin | Modulation Type: | OFDM |
| Tested Date: | Mar. 27, 2008 | | |

| Channel Number | Channel Frequency (MHz) | Peak Output Power (dBm) | Peak Power Limit (dBm) |
|----------------|-------------------------|-------------------------|------------------------|
| 1 | 2411.6000 | 10.47 | 30 |
| 6 | 2437.0000 | 9.62 | 30 |
| 11 | 2462.0820 | 8.87 | 30 |

CH1:

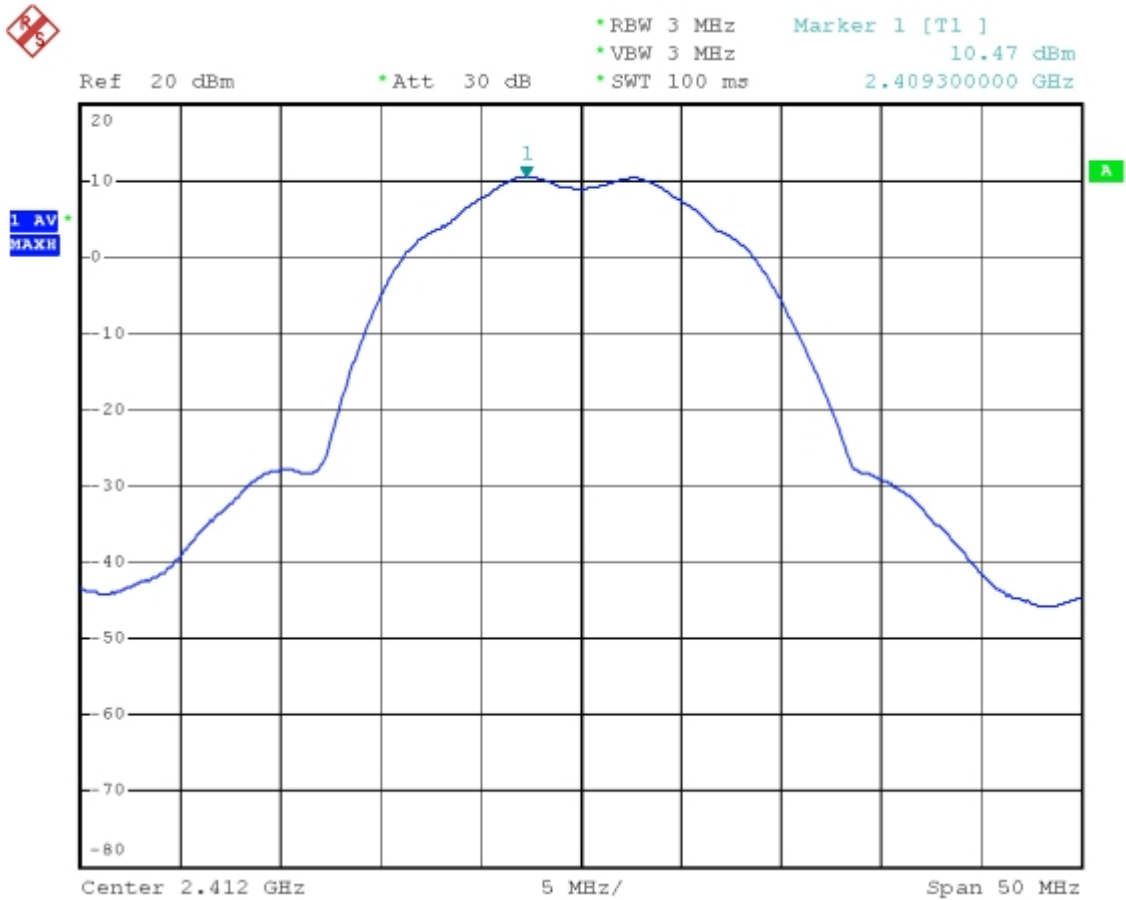



CH6

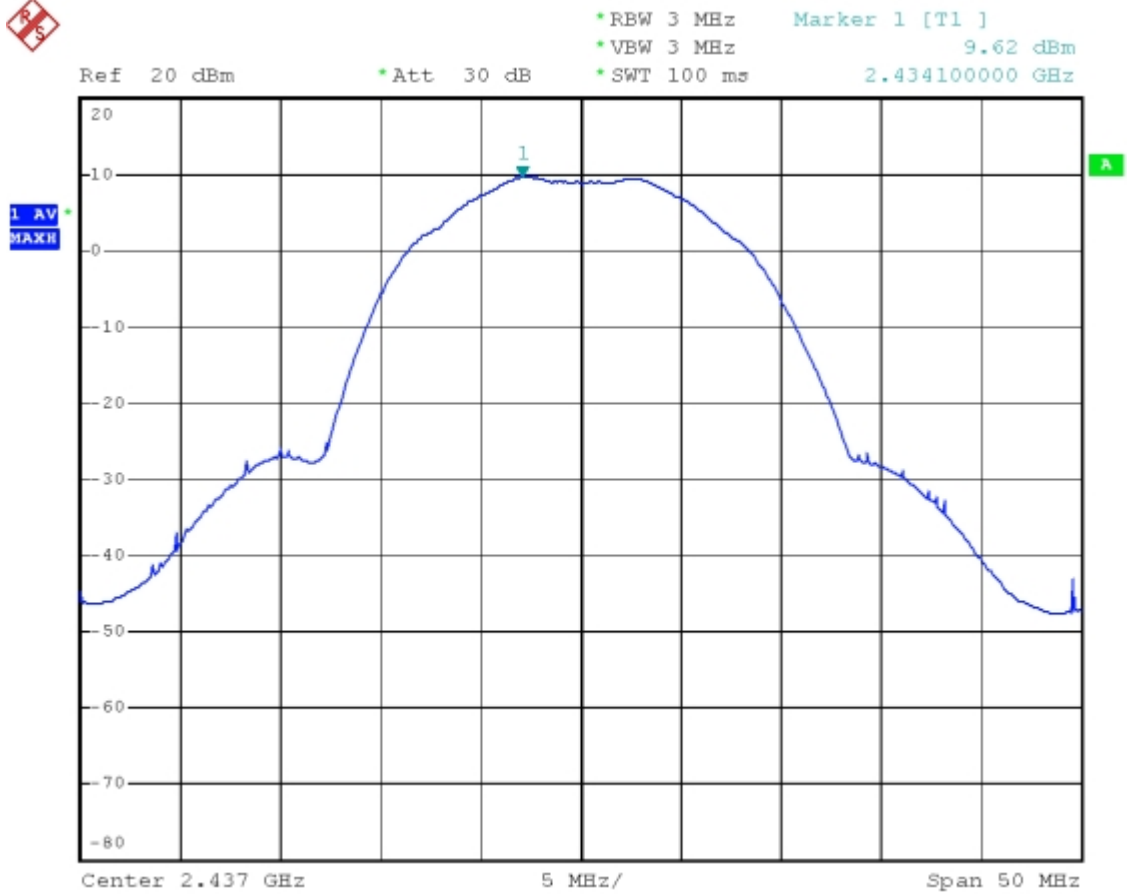



CH11

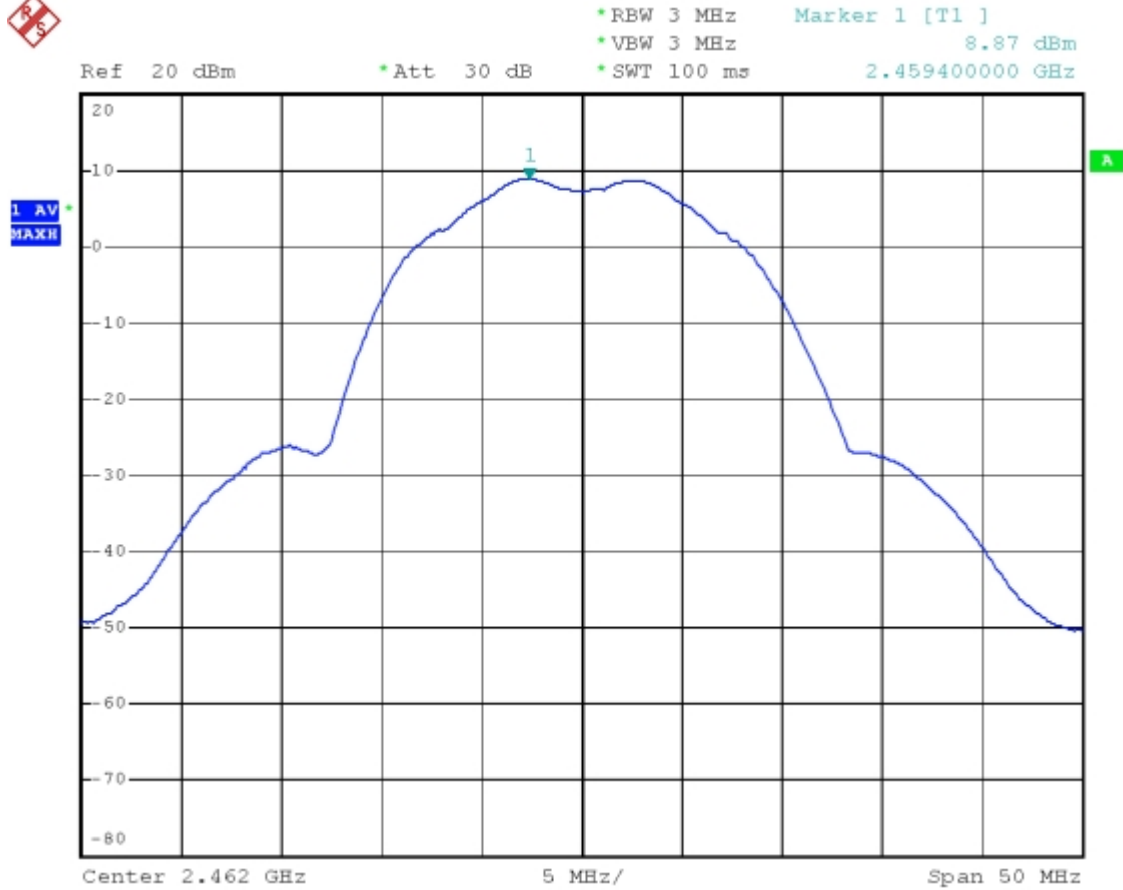



Spectrum Research & Testing Lab., Inc.
No. 101-10, Ling 8,
Shan-Tong Li, Chung-Li
City, Taoyuan, Taiwan

TEST REPORT

Reference No.: A08092401
Report No.: FCCA08092401
FCC ID: W3Q-WL850R
Page: 47 of 73
Date: Nov. 27, 2008

| | | | |
|--------------------|----------------------|------------------|---------------------|
| Temperature: | <u>22°C</u> | Humidity: | <u>69%RH</u> |
| Spectrum Detector: | <u>PK.</u> | Tested Mode: | <u>IEEE 802.11b</u> |
| Tested By: | <u>Wayne Lin</u> | Modulation Type: | <u>CCK</u> |
| Tested Date: | <u>Nov. 19, 2008</u> | | |

| Channel Number | Channel Frequency (MHz) | Peak Output Power (dBm) | Peak Power Limit (dBm) |
|----------------|-------------------------|-------------------------|------------------------|
| 1 | 2412.0000 | 10.22 | 30 |
| 6 | 2437.0000 | 9.28 | 30 |
| 11 | 2462.1000 | 9.40 | 30 |

CH1:

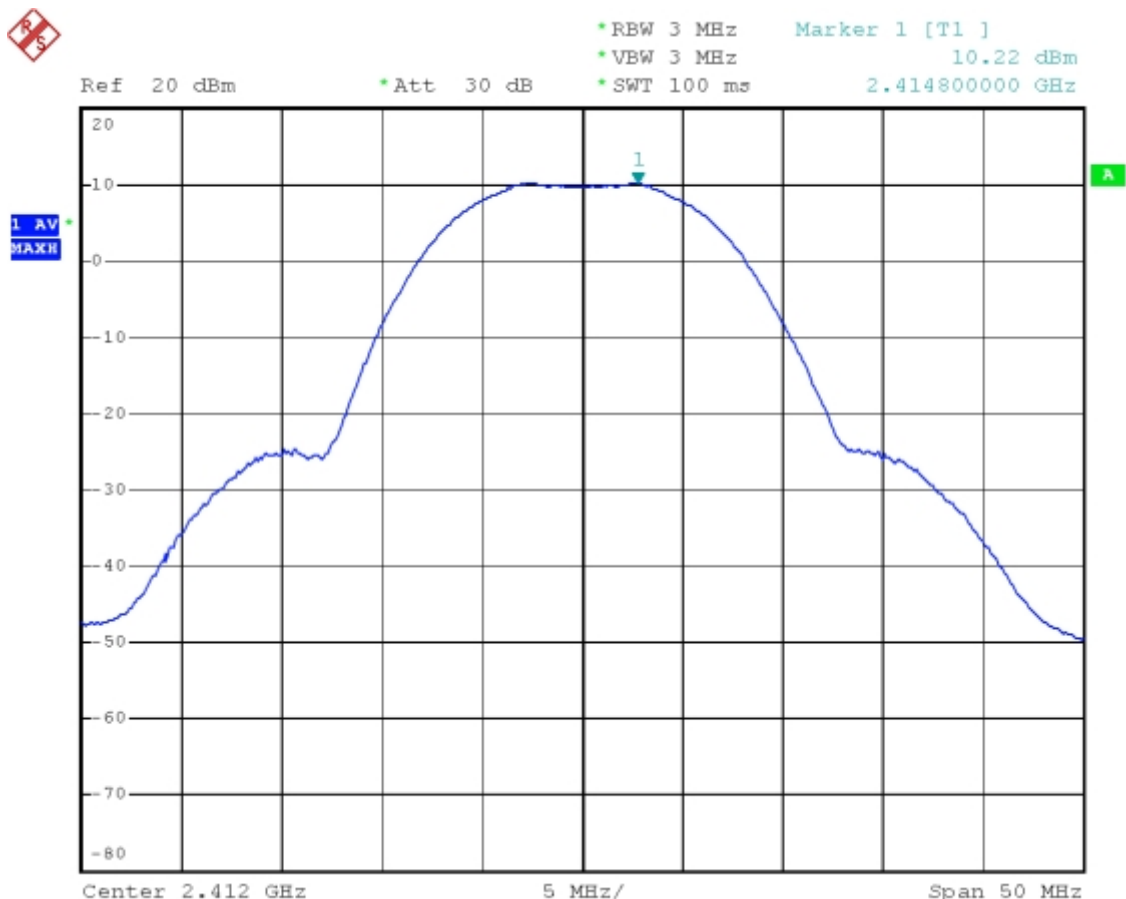



TEST REPORT

CH6

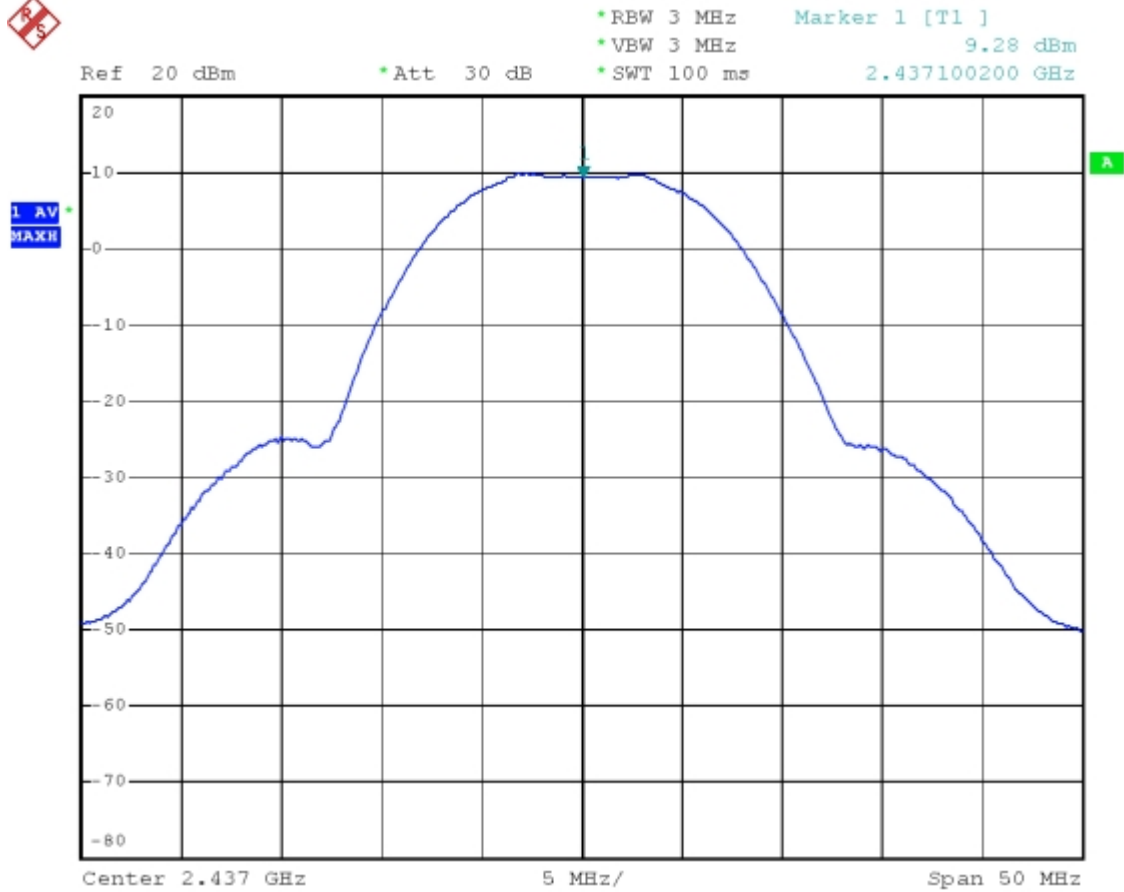



TEST REPORT

CH11

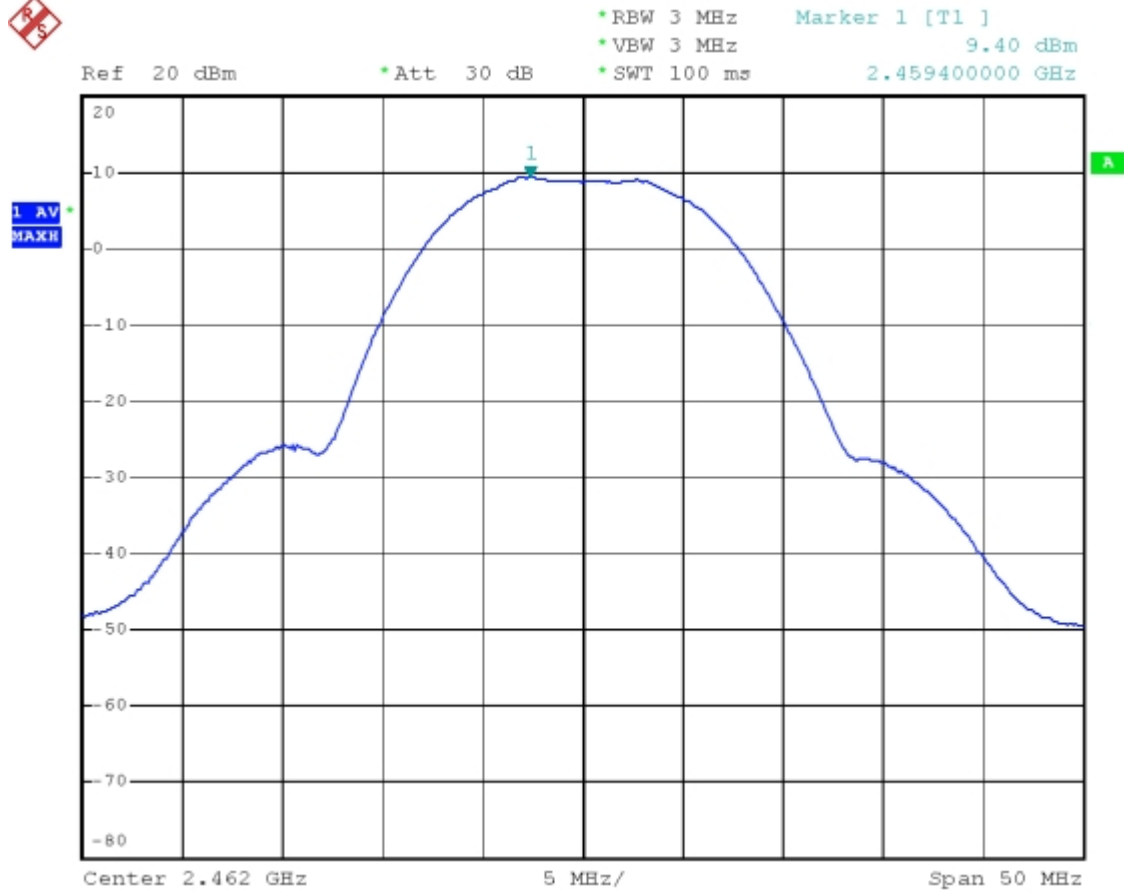



4.5 BAND EDGE TEST

4.5.1 LIMIT

Bluetooth: FCC Part15, Subpart C Section 15.249 (c), Emission radiated outside of the specified frequency bands, except for harmonics, shall attenuated by at least 50 dB below the level of the fundamental or to the general radiated emission limits in Section 15.209, whichever is the lesser attenuation.

| Operating Frequency Range (MHz) | Limit (dB μ V/m) | |
|---------------------------------|----------------------|---------|
| | Peak | Average |
| 902-928 | 74 | 54 |
| 2400-2483.5 | | |
| 5725-5850 | | |

Wi-Fi: FCC Part15, Subpart C Section 15.247. In any 100 kHz bandwidth outside the frequency band in which the spread spectrum intentional radiator is operating, the radio frequency power that is produced by the intentional radiator shall be at least 20 dB below that in the 100 kHz bandwidth within the band that contains the highest level of the desired power, based on either an RF conducted or a radiated measurement.

Attenuation below the general limits specified in Section 15.209(a) is not required. In addition, radiated emissions which fall in the restricted bands, as defined in Section 15.205(a), must also comply with the radiated emission limits specified in Section 15.209(a) (see Section 15.205(c)).

| OPERATING FREQUENCY RANGE (MHz) | SPURIOUS EMISSION FREQUENCY (MHz) | LIMIT | |
|---------------------------------|-----------------------------------|------------------------------------|------------------------|
| | | Peak power ration to emission(dBc) | Emission level(dBuV/m) |
| 902 - 928 | <902 | >20 | NA |
| | >928 | >20 | NA |
| | 960-1240 | NA | 54 |
| 2400 - 2483.5 | <2400 | >20 | NA |
| | >2483.5-2500 | NA | 54 |
| 5725 - 5850 | <5350-5460 | NA | 54 |
| | <5725 | >20 | NA |
| | >5850 | >20 | NA |



Spectrum Research & Testing Lab., Inc.
No. 101-10, Ling 8,
Shan-Tong Li, Chung-Li
City, Taoyuan, Taiwan

TEST REPORT

Reference No.: A08092401
Report No.: FCCA08092401
FCC ID: W3Q-WL850R
Page: 51 of 73
Date: Nov. 27, 2008

4.5.2 TEST EQUIPMENT

The following test equipment was used during the test:

| EQUIPMENT/ FACILITIES | SPECIFICATIONS | MANUFACTURER | MODEL#/ SERIAL# | DUE DATE OF CAL. & CAL. CENTER |
|--------------------------|---------------------------|--------------------|-----------------------|-----------------------------------|
| SPECTRUM | 9kHz-40GHz | ROHDE & SCHWARZ | FSP40/ 100093 | SEP. 2009 ETC |
| EMI TEST RECEIVER | 9 kHz TO 2750 MHz | ROHDE & SCHWARZ | ESCS30/ 830245/012 | OCT. 2009 ETC |
| SPECTRUM | 9KHz-26.5GHz | HP | 8953E/ 3710A03220 | MAY 2009 ETC |
| PRE-AMPLIFIER | 1GHz-26.5GHz Gain:30dB | HP | 8449B/ 3008A01019 | NOV. 2009 ETC |
| BI-LOG ANTENNA | 25 MHz TO 2 GHz | EMCO | 3142/ 9701-1124 | FEB. 2009 SRT |
| HORN ANTENNA | 1GHz to 18GHz | EMCO | 3115/ 9602-4681 | DEC. 2008 ETC |
| OATS | 3 - 10 M measurement | SRT | SRT-1 | APR. 2009 SRT |

NOTE: The calibration interval of the above test equipment is one year and the calibrations are traceable to NML/ROC and NIST/USA.



4.5.3 TEST SET-UP

FOR RF CONDUCTED TEST (dBc)

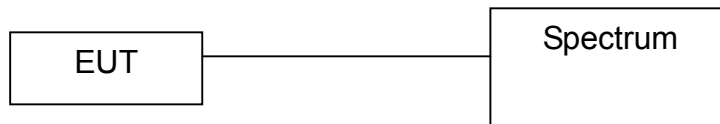

The EUT was connected to a spectrum through a 50Ω RF cable.

FOR RADIATED EMISSION TEST

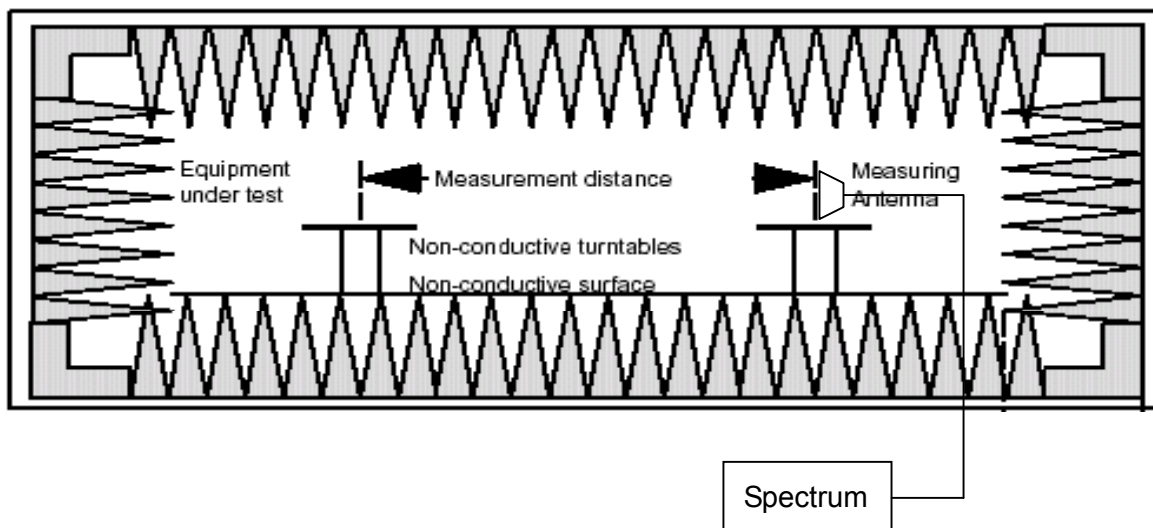

NOTE :

3. The EUT system was put on a wooden table with 0.8m heights above a ground plane.
4. For the actual test configuration, please refer to the photos of testing.



4.5.4 TEST PROCEDURE

1. The EUT was operating in hopping mode or could be controlled its channel.
Printed out the test result from the spectrum by hard copy function.
2. The EUT was tested according to the requirement of ANSI C63.4 and CISPR 22.
The measurements were made at an open area test site with 10 meter measurement distance under 1 GHz and with 3m distance above 1GHz. The frequency spectrum measured started from 30 MHz. Under 1 GHz. All readings were quasi-peak values with 120 kHz resolution bandwidth of the test receiver. Above 1 GHz, the measurements were made at an open area test site with 3 meter measurement distance and all readings were peak and average values with 1 MHz resolution bandwidth of the test receiver. The EUT system was operated in all typical methods by users. The cables connected to EUT and support units were moved to find the maximum emission levels for each frequency.

4.5.5 EUT OPERATING CONDITION

Same as section 4.1.5 of this report.



TEST REPORT

4.5.6 TEST RESULT

| | | | |
|--------------------|----------------------|------------------|---------------------|
| Temperature: | <u>22°C</u> | Humidity: | <u>69%RH</u> |
| Spectrum Detector: | <u>PK. & AV.</u> | Tested Mode: | <u>IEEE 802.11g</u> |
| Tested By: | <u>Wayne Lin</u> | Modulation Type: | <u>OFDM</u> |
| Tested Date: | <u>Nov. 19, 2008</u> | | |

1. Conducted test

| Frequency (MHz) | PEAK POWER OUTPUT (dBm) | Emission read Value (dBm) | Result of Band edge (dBc) | Band edge LIMIT (dBc) |
|-----------------|-------------------------|---------------------------|---------------------------|-----------------------|
| <2400 | -3.47 | -45.91 | 42.44 | >20dBc |
| >2483.5 | -4.45 | -54.42 | 49.97 | >20dBc |

2. Radiated emission test

| Frequency (MHz) | Antenna polarization (H/V) | Reading (dBuV) | | Emission (dBuV/m) | | Band edge Limit (dBuV/m) | |
|-----------------|----------------------------|----------------|------|-------------------|------|--------------------------|------|
| | | PK | AV | PK | AV | PK | AV |
| <2400 | V | 64.7 | 45.5 | 60.5 | 41.3 | 74.0 | 54.0 |
| >2483.5 | V | 62.2 | 44.4 | 58.2 | 40.4 | 74.0 | 54.0 |



CH1

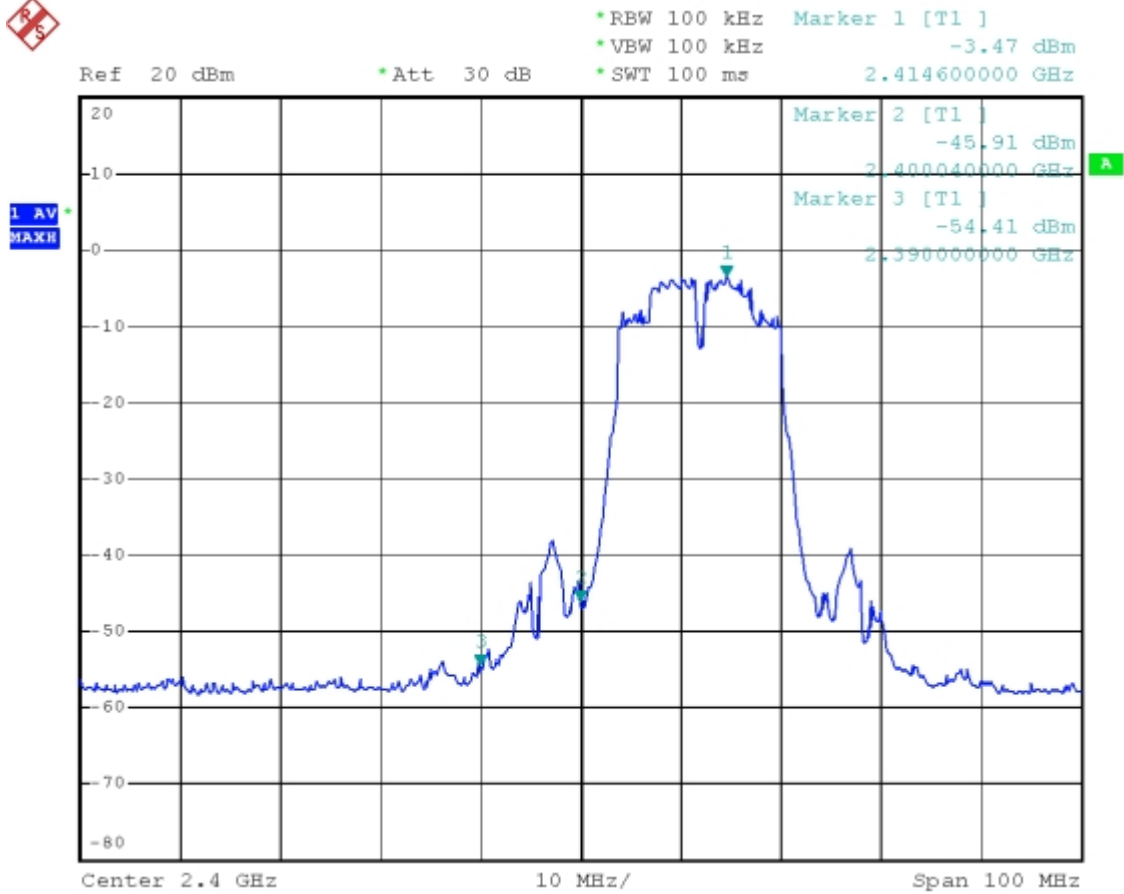



CH11

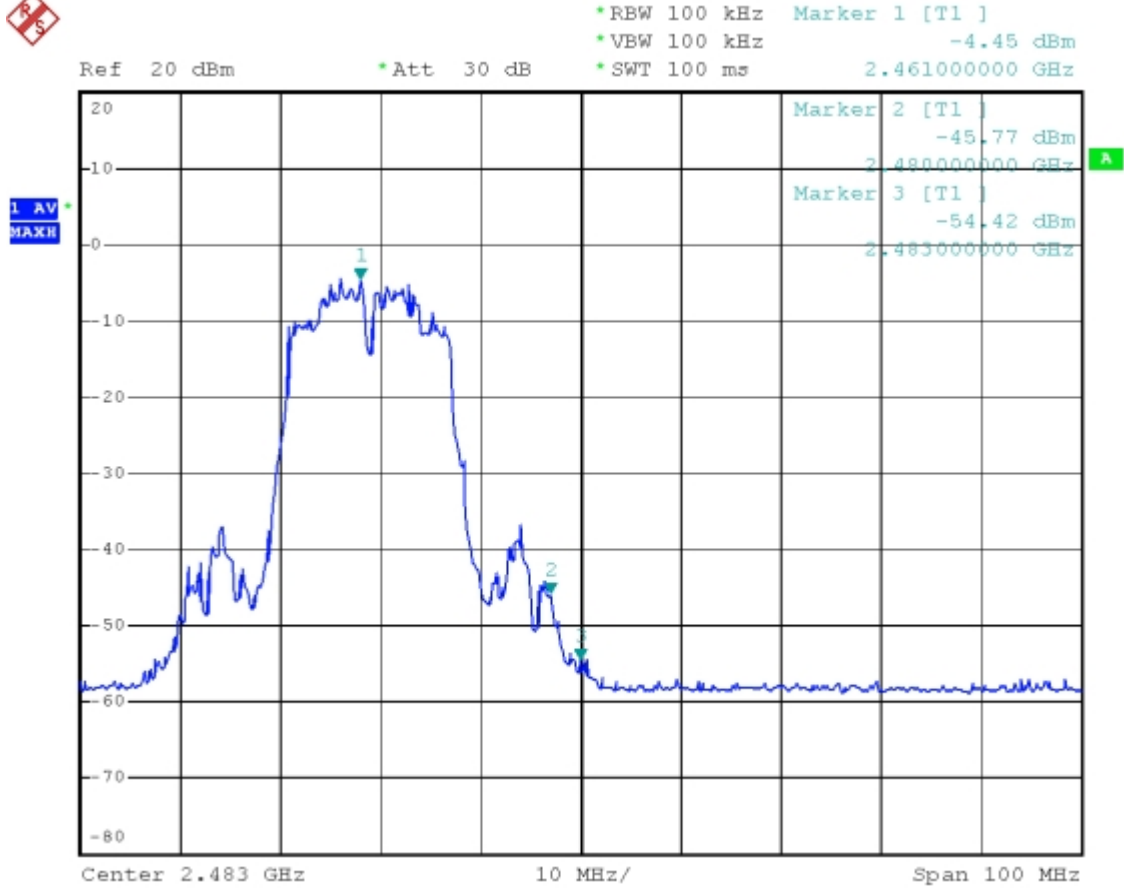



Spectrum Research & Testing Lab., Inc.
 No. 101-10, Ling 8,
 Shan-Tong Li, Chung-Li
 City, Taoyuan, Taiwan

TEST REPORT

Reference No.: A08092401
 Report No.: FCCA08092401
 FCC ID: W3Q-WL850R
 Page: 57 of 73
 Date: Nov. 27, 2008

| | | | |
|--------------------|----------------------|------------------|---------------------|
| Temperature: | <u>22°C</u> | Humidity: | <u>69%RH</u> |
| Spectrum Detector: | <u>PK. & AV.</u> | Tested Mode: | <u>IEEE 802.11b</u> |
| Tested By: | <u>Wayne Lin</u> | Modulation Type: | <u>CCK</u> |
| Tested Date: | <u>Nov. 19, 2008</u> | | |

1. Conducted test

| Frequency (MHz) | PEAK POWER OUTPUT (dBm) | Emission read Value(dBm) | Result of Band edge (dBc) | Band edge LIMIT (dBc) |
|-----------------|-------------------------|--------------------------|---------------------------|-----------------------|
| <2400 | -2.58 | -43.33 | 40.75 | >20dBc |
| >2483.5 | -3.25 | -54.23 | 50.98 | >20dBc |

2. Radiated emission test

| Frequency (MHz) | Antenna polarization (H/V) | Reading (dBuV) | | Emission (dBuV/m) | | Band edge Limit (dBuV/m) | |
|-----------------|----------------------------|----------------|------|-------------------|------|--------------------------|------|
| | | PK | AV | PK | AV | PK | AV |
| <2400 | V | 63.5 | 45.6 | 59.3 | 41.4 | 74.0 | 54.0 |
| >2483.5 | V | 66.1 | 46.9 | 62.1 | 42.9 | 74.0 | 54.0 |



TEST REPORT

CH1

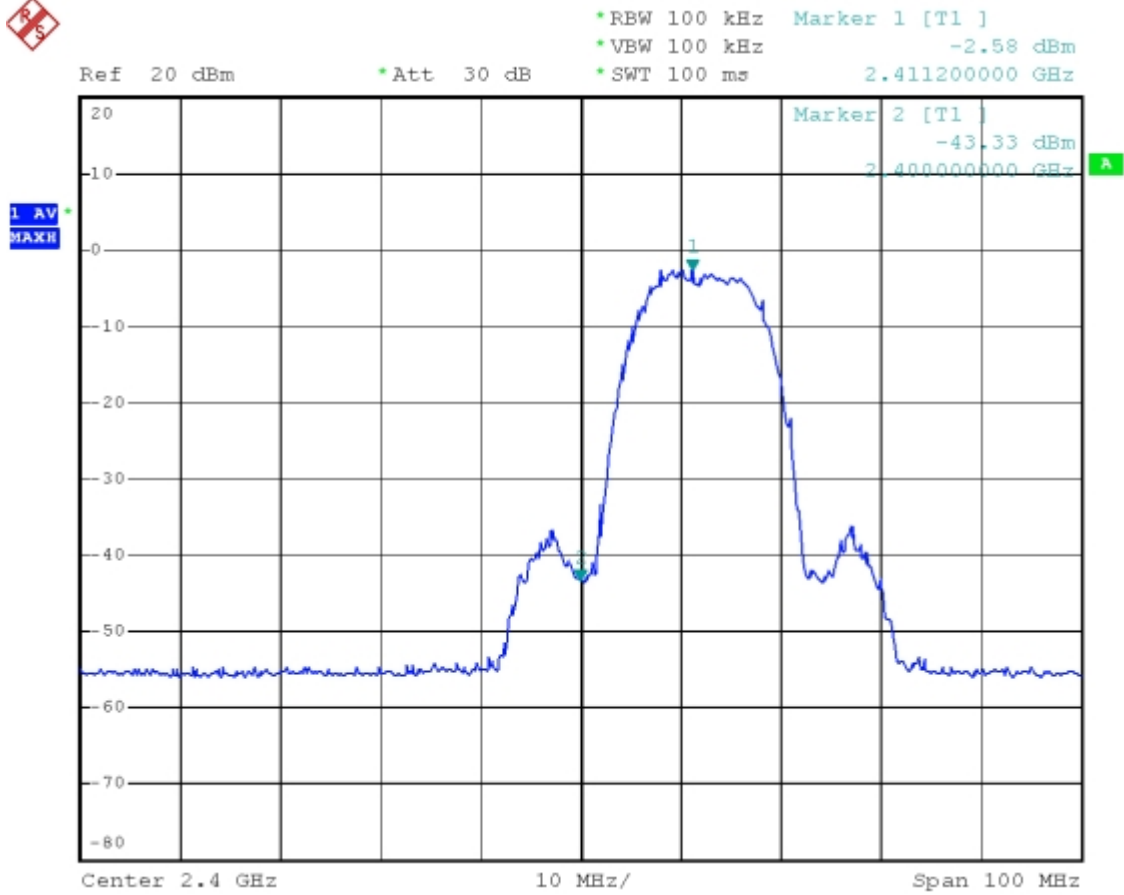



CH11

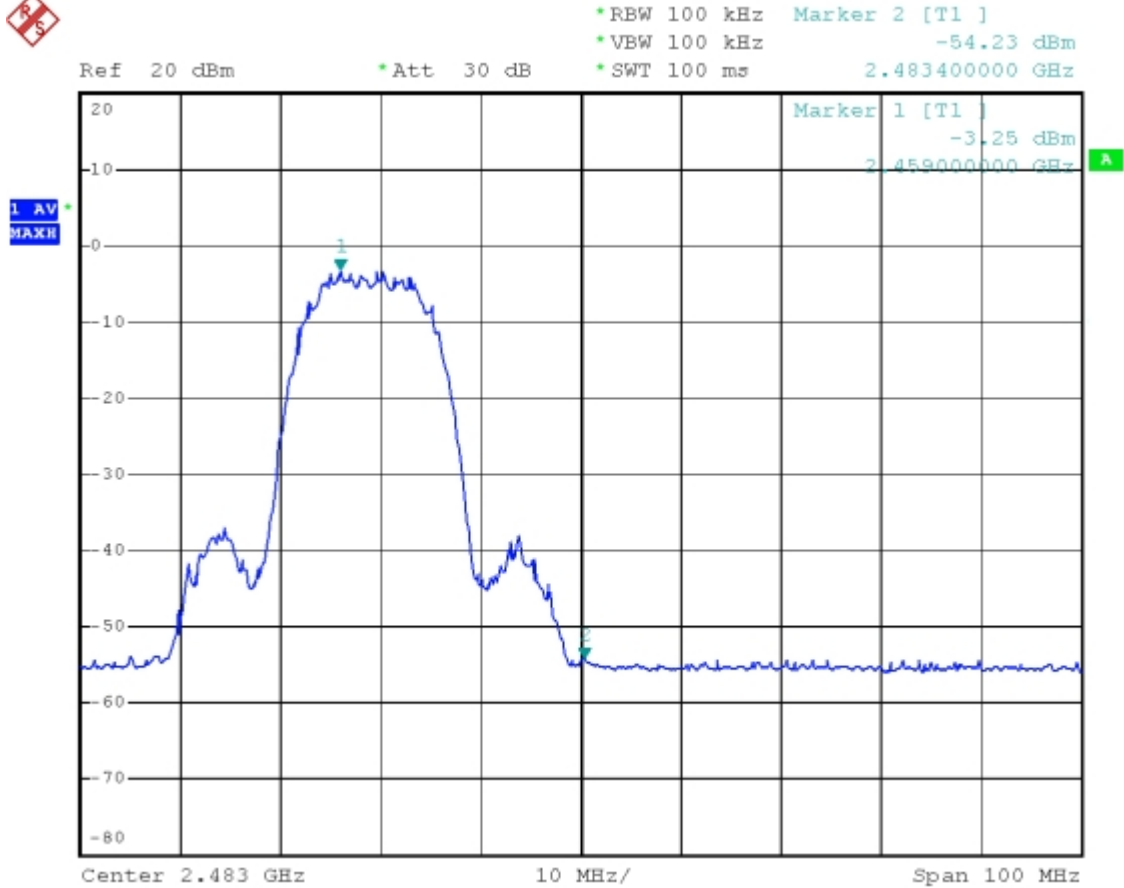



4.6 POWER DENSITY TEST

4.6.1 LIMIT

FCC Part15, Subpart C Section 15.247

| FREQUENCY RANGE (MHz) | Limit(dBm/kHz) |
|-----------------------|----------------|
| 902-928 | 8dBm/3kHz |
| 2400-2483.5 | |
| 5725-5850 | |

4.6.2 TEST EQUIPMENT

The following test equipment was used during the radiated emission test:

| EQUIPMENT/FACILITIES | SPECIFICATIONS | MANUFACTURER | MODEL#/SERIAL# | DUE DATE OF CAL. & CAL. CENTER |
|----------------------|----------------|-----------------|------------------|--------------------------------|
| SPECTRUM | 9kHz-40GHz | ROHDE & SCHWARZ | FSP40/ 100093 | SEP. 2009 ETC |

NOTE: The calibration interval of the above test equipment is one year and the calibrations are traceable to NML/ROC and NIST/USA.

4.6.3 TEST SET-UP

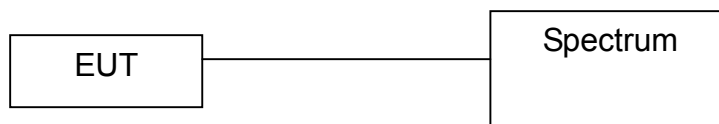

The EUT was connected to a spectrum through a 50Ω RF cable.

4.6.4 TEST PROCEDURE

The EUT was operating in transmitter mode and could be controlled its channel. Printed out the test result from the spectrum by hard copy function.

4.6.5 EUT OPERATING CONDITION

Same as section 4.1.5 of this report.



Spectrum Research & Testing Lab., Inc.
 No. 101-10, Ling 8,
 Shan-Tong Li, Chung-Li
 City, Taoyuan, Taiwan

TEST REPORT

Reference No.: A08092401
 Report No.: FCCA08092401
 FCC ID: W3Q-WL850R
 Page: 61 of 73
 Date: Nov. 27, 2008

4.6.6 TEST RESULT

| | | | |
|--------------------|---------------|------------------|--------------|
| Temperature: | 22°C | Humidity: | 69%RH |
| Spectrum Detector: | PK. | Tested Mode: | IEEE 802.11g |
| Tested By: | Wayne Lin | Modulation Type: | OFDM |
| Tested Date: | Nov. 19, 2008 | | |

| CHANNEL NUMBER | CHANNEL FREQUENCY (MHz) | RF POWER LEVEL IN 3kHz BW (dBm/3kHz) | MAXIMUM LIMIT (dBm/3kHz) |
|----------------|-------------------------|--------------------------------------|--------------------------|
| 1 | 2412.0000 | -28.19 | 8 |
| 6 | 2437.0000 | -29.66 | 8 |
| 11 | 2462.0000 | -28.70 | 8 |

CH 1:

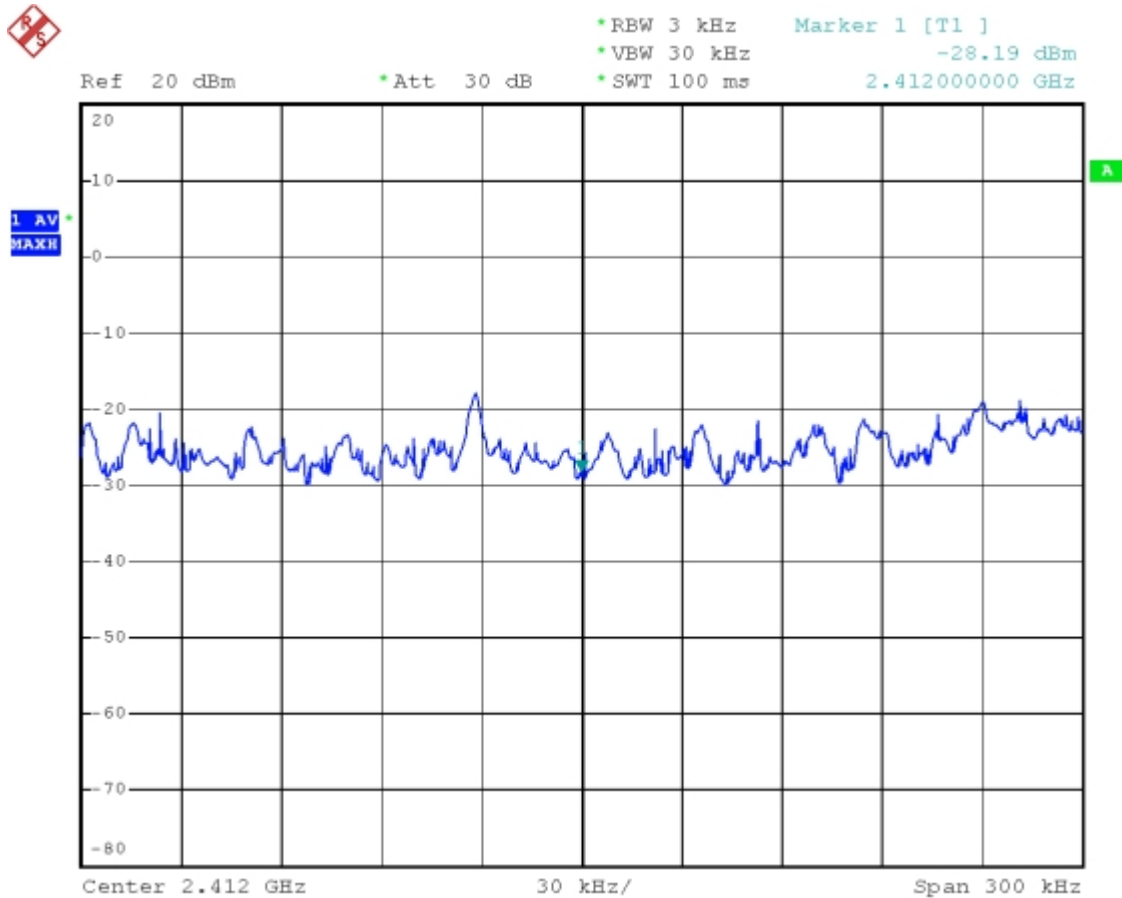



TEST REPORT

CH 6:

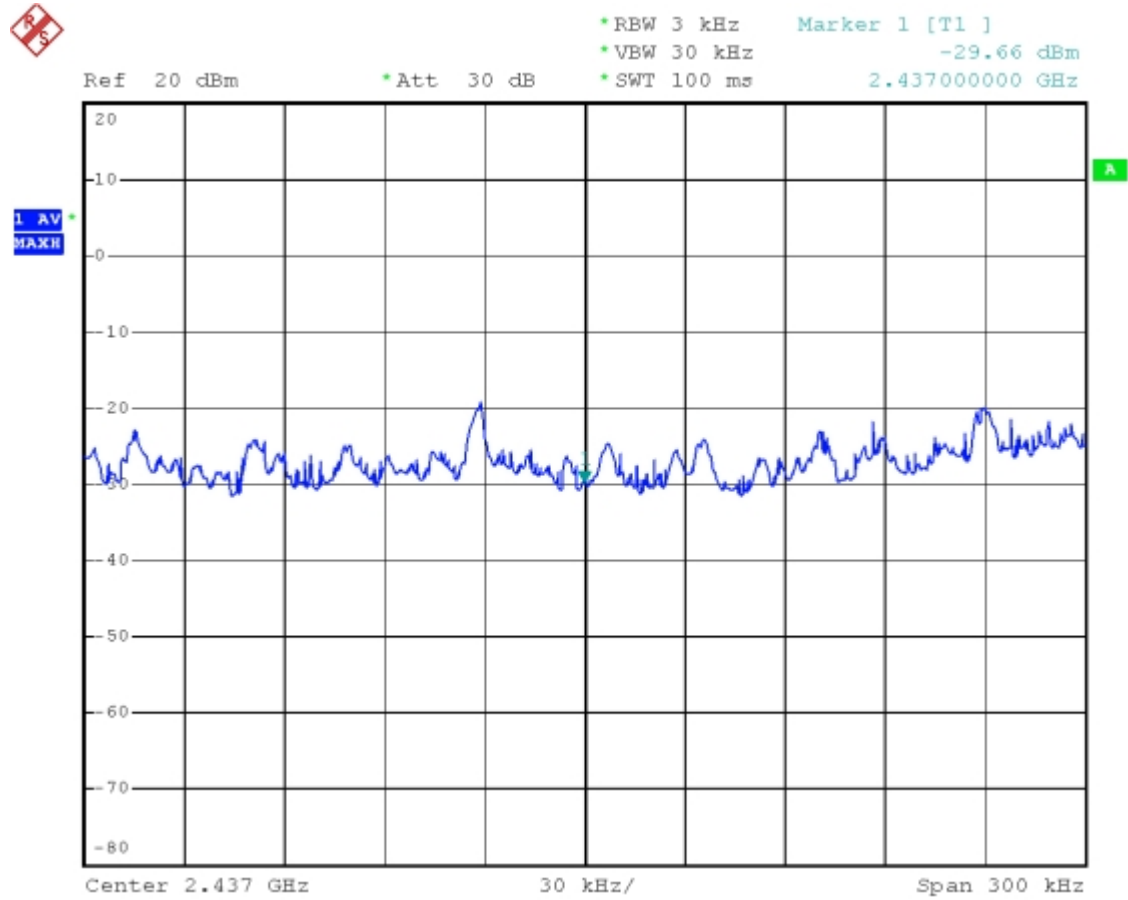



Spectrum Research & Testing Lab., Inc.
No. 101-10, Ling 8,
Shan-Tong Li, Chung-Li
City, Taoyuan, Taiwan

TEST REPORT

Reference No.: A08092401
Report No.: FCCA08092401
FCC ID: W3Q-WL850R
Page: 63 of 73
Date: Nov. 27, 2008

CH 11:

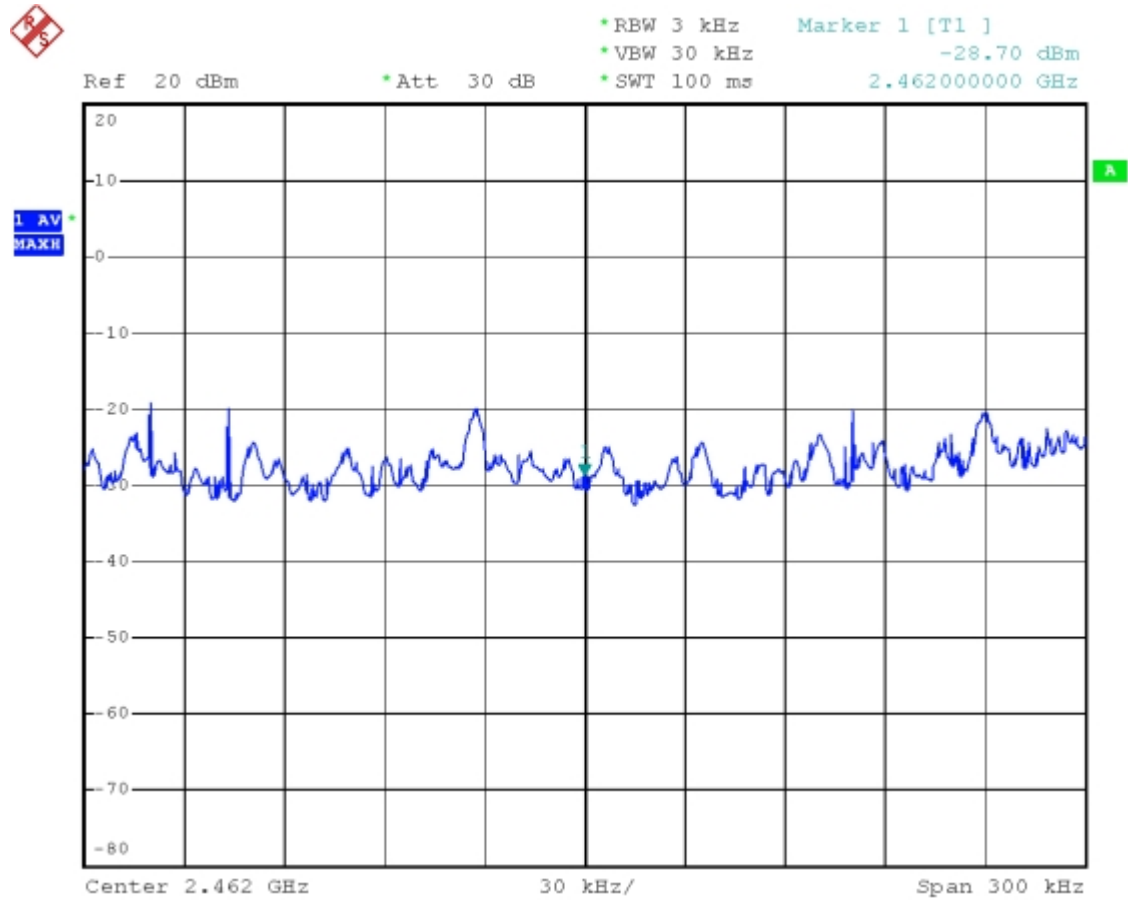



Spectrum Research & Testing Lab., Inc.
 No. 101-10, Ling 8,
 Shan-Tong Li, Chung-Li
 City, Taoyuan, Taiwan

TEST REPORT

Reference No.: A08092401
 Report No.: FCCA08092401
 FCC ID: W3Q-WL850R
 Page: 64 of 73
 Date: Nov. 27, 2008

| | | | |
|--------------------|----------------------|------------------|---------------------|
| Temperature: | <u>22°C</u> | Humidity: | <u>69%RH</u> |
| Spectrum Detector: | <u>PK.</u> | Tested Mode: | <u>IEEE 802.11b</u> |
| Tested By: | <u>Wayne Lin</u> | Modulation Type: | <u>CCK</u> |
| Tested Date: | <u>Nov. 19, 2008</u> | | |

| CHANNEL NUMBER | CHANNEL FREQUENCY (MHz) | RF POWER LEVEL IN 3kHz BW (dBm/3kHz) | MAXIMUM LIMIT (dBm/3kHz) |
|----------------|-------------------------|--------------------------------------|--------------------------|
| 1 | 2412.0000 | -10.87 | 8 |
| 6 | 2437.0000 | -11.07 | 8 |
| 11 | 2462.0000 | -13.67 | 8 |

CH 1:

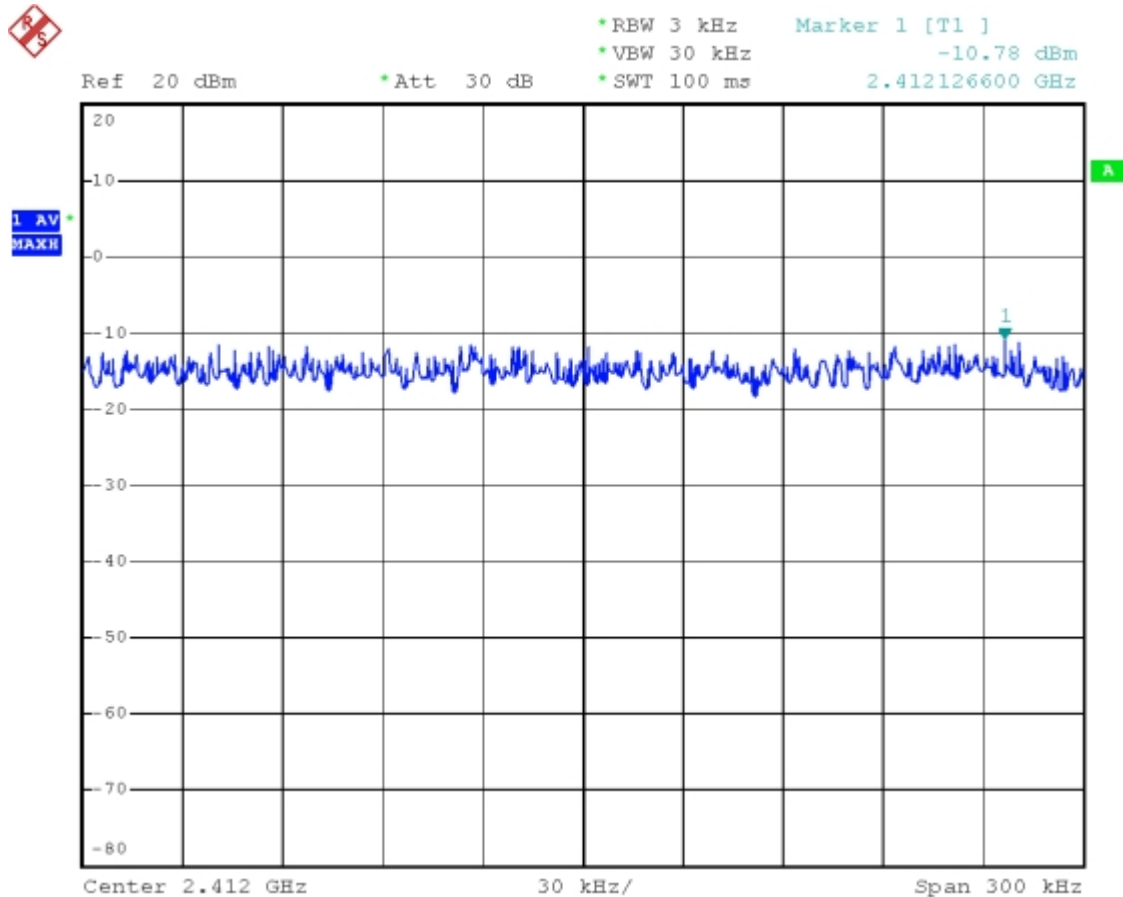



Spectrum Research & Testing Lab., Inc.
No. 101-10, Ling 8,
Shan-Tong Li, Chung-Li
City, Taoyuan, Taiwan

TEST REPORT

Reference No.: A08092401
Report No.: FCCA08092401
FCC ID: W3Q-WL850R
Page: 65 of 73
Date: Nov. 27, 2008

CH 6:

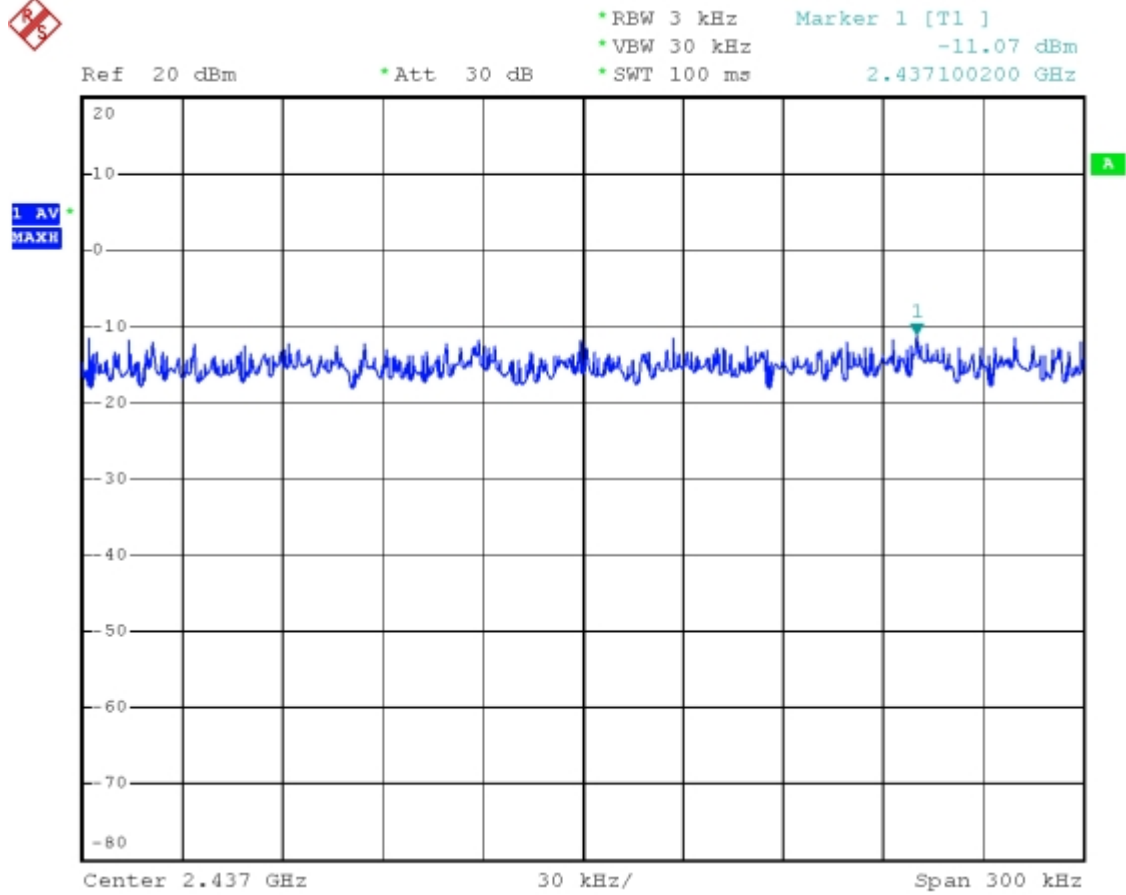



TEST REPORT

CH 11:

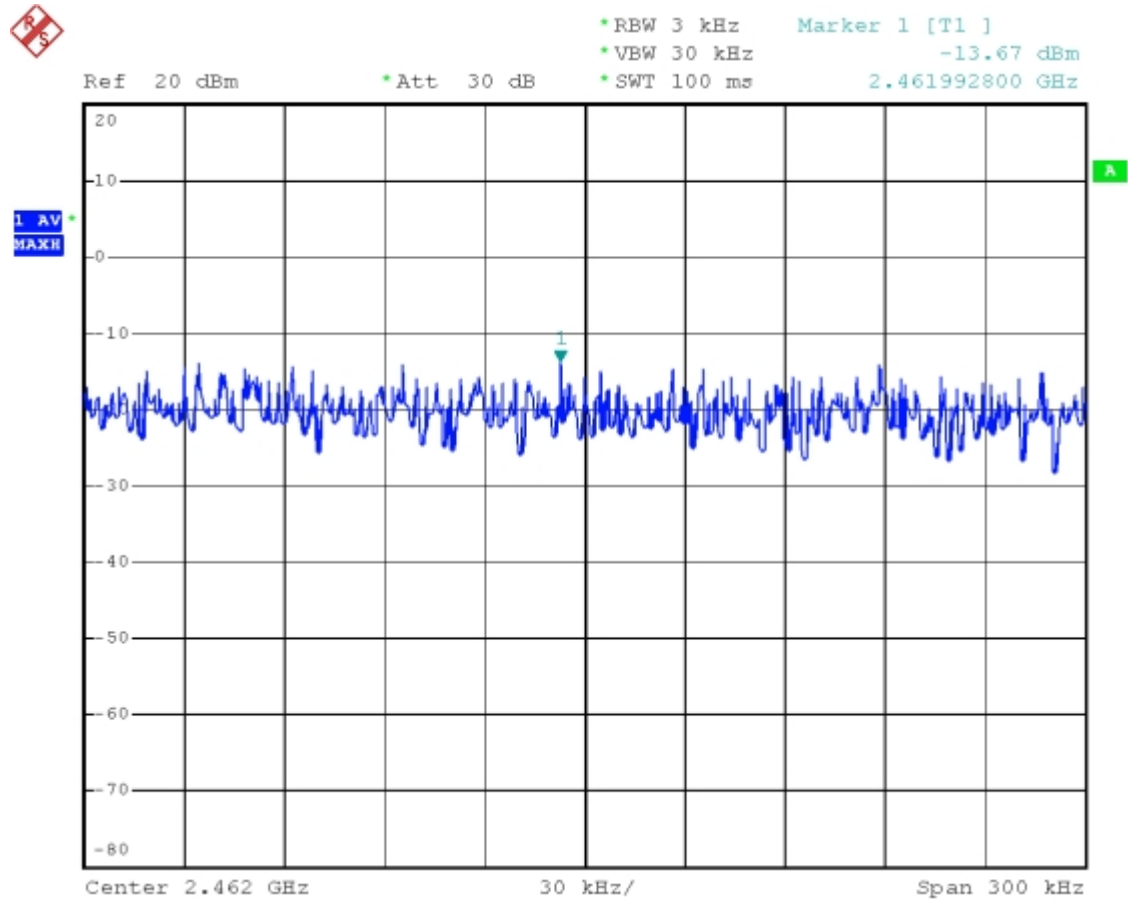



5. Antenna application

5.1 Antenna requirement

The EUT's antenna is met the requirement of FCC part15C section15.203 and 15.204.

FCC part15C section15.247 requirement:

Systems operating in the 2400-2483.5 MHz band that are used exclusively for fixed, point-to-point operations may employ transmitting antennas with directional gain greater than 6 dBi provided the maximum peak output power of the intentional radiator is reduced by 1 dB for every 3 dB that the directional gain of the antenna exceeds 6 dBi.

5.2 Result

The EUT's antenna used a 2.4G PIFA antenna. Gain of antenna types is 2.0 dBi that meet the requirement.



Spectrum Research & Testing Lab., Inc.
No. 101-10, Ling 8,
Shan-Tong Li, Chung-Li
City, Taoyuan, Taiwan

TEST REPORT

Reference No.: A08092401
Report No.: FCCA08092401
FCC ID: W3Q-WL850R
Page: 73 of 73
Date: Nov. 27, 2008

7. TERMS OF ABBREVIATION

| | |
|----------|--|
| AV. | Average detection |
| AZ(°) | Turn table azimuth |
| Correct. | Correction |
| EL(m) | Antenna height (meter) |
| EUT | Equipment Under Test |
| Horiz. | Horizontal direction |
| LISN | Line Impedance Stabilization Network |
| NSA | Normalized Site Attenuation |
| Q.P. | Quasi-peak detection |
| SRT Lab | Spectrum Research & Testing Laboratory, Inc. |
| Vert. | Vertical direction |