

ELECTROMAGNETIC EMISSIONS COMPLIANCE REPORT



Applicant: FUJIFILM Corporation
7-3, Akasaka 9-Chome, Minato-ku, Tokyo 107-0052 Japan

Manufacturer: FUJIFILM Corporation
7-3, Akasaka 9-Chome, Minato-ku, Tokyo 107-0052 Japan

Product Name: FILE TRANSMITTER

Brand Name: FUJIFILM

Model No.: FF210004

Model Difference: N/A

Report Number: ER/2022/20002

FCC ID W2Z-02000006

IC: 7736B-02000006

Date of EUT Received: Feb. 07, 2022

Date of Test: Apr. 01, 2022~Apr. 20, 2022

Issue Date: Jun. 08, 2022

Approved By _____

Jim Chang

We hereby certify that:

The above equipment was tested by SGS Taiwan Ltd. Central RF Lab The test data, data evaluation, test procedures, and equipment configurations shown in this report were made in accordance with the procedures given in ANSI C63.10:2013 and the energy emitted by the sample EUT comply with FCC rule part §15.407, ISED RSS-247.

The results of this report relate only to the sample identified in this report.

Unless otherwise stated the results shown in this test report refer only to the sample(s) tested and such sample(s) are retained for 90 days only.

除非另有說明，此報告結果僅對測試之樣品負責，同時此樣品僅保留90天。本報告未經本公司書面許可，不可部份複製。

This document is issued by the Company subject to its General Conditions of Service printed overleaf, available on request or accessible at <http://www.sgs.com.tw/Terms-and-Conditions> and for electronic format documents, subject to Terms and Conditions for Electronic Documents at <http://www.sgs.com.tw/Terms-and-Conditions>. Attention is drawn to the limitation of liability, indemnification and jurisdiction issues defined therein. Any holder of this document is advised that information contained hereon reflects the Company's findings at the time of its intervention only and within the limits of Client's instructions, if any. The Company's sole responsibility is to its Client and this document does not exonerate parties to a transaction from exercising all their rights and obligations under the transaction documents. This document cannot be reproduced except in full, without prior written approval of the Company. Any unauthorized alteration, forgery or falsification of the content or appearance of this document is unlawful and offenders may be prosecuted to the fullest extent of the law.

Revision History

Report Number	Revision	Description	Issue Date	Revised By	Remark
ER/2022/20002	00	Original.	Jun. 08, 2022	Yi-Shan Tsai	

Note:

- 1、The remark "*" indicates modification of the report upon requests from certification body.

Unless otherwise stated the results shown in this test report refer only to the sample(s) tested and such sample(s) are retained for 90 days only.

除非另有說明，此報告結果僅對測試之樣品負責，同時此樣品僅保留90天。本報告未經本公司書面許可，不可部份複製。

This document is issued by the Company subject to its General Conditions of Service printed overleaf, available on request or accessible at <http://www.sgs.com.tw/Terms-and-Conditions> and for electronic format documents, subject to Terms and Conditions for Electronic Documents at <http://www.sgs.com.tw/Terms-and-Conditions>. Attention is drawn to the limitation of liability, indemnification and jurisdiction issues defined therein. Any holder of this document is advised that information contained hereon reflects the Company's findings at the time of its intervention only and within the limits of Client's instructions, if any. The Company's sole responsibility is to its Client and this document does not exonerate parties to a transaction from exercising all their rights and obligations under the transaction documents. This document cannot be reproduced except in full, without prior written approval of the Company. Any unauthorized alteration, forgery or falsification of the content or appearance of this document is unlawful and offenders may be prosecuted to the fullest extent of the law.

Contents

1	GENERAL INFORMATION	4
2	SYSTEM TEST CONFIGURATION	8
3	SUMMARY OF TEST RESULT	11
4	DESCRIPTION OF TEST MODES	12
5	MEASUREMENT UNCERTAINTY	15
6	MEASUREMENT EQUIPMENT USED	16
7	CONDUCTED EMISSION TEST	18
8	EMISSION BANDWIDTH MEASUREMENT	22
9	MAXIMUM CONDUCTED OUTPUT POWER MEASUREMENT	53
10	MAXIMUM POWER SPECTRAL DENSITY	73
11	UNDESIRABLE RADIATED EMISSION MEASUREMENT	88
12	TRANSMISSION IN THE ABSENCE OF DATA.....	184
13	ANTENNA REQUIREMENT.....	185

Unless otherwise stated the results shown in this test report refer only to the sample(s) tested and such sample(s) are retained for 90 days only.
 除非另有說明，此報告結果僅對測試之樣品負責，同時此樣品僅保留90天。本報告未經本公司書面許可，不可部份複製。

This document is issued by the Company subject to its General Conditions of Service printed overleaf, available on request or accessible at <http://www.sgs.com.tw/Terms-and-Conditions> and for electronic format documents, subject to Terms and Conditions for Electronic Documents at <http://www.sgs.com.tw/Terms-and-Conditions>. Attention is drawn to the limitation of liability, indemnification and jurisdiction issues defined therein. Any holder of this document is advised that information contained hereon reflects the Company's findings at the time of its intervention only and within the limits of Client's instructions, if any. The Company's sole responsibility is to its Client and this document does not exonerate parties to a transaction from exercising all their rights and obligations under the transaction documents. This document cannot be reproduced except in full, without prior written approval of the Company. Any unauthorized alteration, forgery or falsification of the content or appearance of this document is unlawful and offenders may be prosecuted to the fullest extent of the law.

1 GENERAL INFORMATION

1.1 Product Description

Product Name:	FILE TRANSMITTER
Brand Name:	FUJIFILM
Model No.:	FF210004
Model Difference:	N/A
Hardware Version:	N/A
Firmware Version:	N/A
EUT Series No.:	FT000034 (Conducted) FT000033 (Conduction & Radiated)
Power Supply:	Battery 7.2Vdc
	Model No.: NP-W235, Supplier: FUJIFILM Corporation
Test Software (Name/Version)	Rlogin / 2.23.9

1.2 Modulation & Data Rate

Modulation type:	64QAM, 16QAM, QPSK, BPSK for OFDM
	256QAM for OFDM in 802.11ac
Transition Rate:	802.11 a: 6 - 54 Mbps
	802.11 n_20MHz: up to - 144.4 Mbps
	802.11 n_40MHz: up to - 300 Mbps
	802.11 ac_20MHz: up to - 173.4 Mbps
	802.11 ac_40MHz: up to - 400 Mbps
	802.11 ac_80MHz: up to - 866.6 Mbps

Unless otherwise stated the results shown in this test report refer only to the sample(s) tested and such sample(s) are retained for 90 days only.

除非另有說明，此報告結果僅對測試之樣品負責，同時此樣品僅保留90天。本報告未經本公司書面許可，不可部份複製。

This document is issued by the Company subject to its General Conditions of Service printed overleaf, available on request or accessible at <http://www.sgs.com.tw/Terms-and-Conditions> and for electronic format documents, subject to Terms and Conditions for Electronic Documents at <http://www.sgs.com.tw/Terms-and-Conditions>. Attention is drawn to the limitation of liability, indemnification and jurisdiction issues defined therein. Any holder of this document is advised that information contained hereon reflects the Company's findings at the time of its intervention only and within the limits of Client's instructions, if any. The Company's sole responsibility is to its Client and this document does not exonerate parties to a transaction from exercising all their rights and obligations under the transaction documents. This document cannot be reproduced except in full, without prior written approval of the Company. Any unauthorized alteration, forgery or falsification of the content or appearance of this document is unlawful and offenders may be prosecuted to the fullest extent of the law.

1.3 Antenna Designation

Antenna Type	ANT0 / ANT1	Freq. (MHz)	Peak Antenna Gain (dBi)	Directional Gain (dBi)
Patern	ANT0	5150~5250	4.60	7.66
		5250~5350	6.30	8.68
		5725~5850	3.10	7.39
	ANT1	5150~5250	4.70	7.66
		5250~5350	5.00	8.68
		5725~5850	5.50	7.39

Note:

1. Pre-scanned was done on the above antennas, measurements were demonstrated by using the antenna with the highest gain as the worst case scenarios.
2. Antenna information is provided by the applicant.

Unless otherwise stated the results shown in this test report refer only to the sample(s) tested and such sample(s) are retained for 90 days only.

除非另有說明，此報告結果僅對測試之樣品負責，同時此樣品僅保留90天。本報告未經本公司書面許可，不可部份複製。
 This document is issued by the Company subject to its General Conditions of Service printed overleaf, available on request or accessible at <http://www.sgs.com.tw/Terms-and-Conditions> and for electronic format documents, subject to Terms and Conditions for Electronic Documents at <http://www.sgs.com.tw/Terms-and-Conditions>. Attention is drawn to the limitation of liability, indemnification and jurisdiction issues defined therein. Any holder of this document is advised that information contained hereon reflects the Company's findings at the time of its intervention only and within the limits of Client's instructions, if any. The Company's sole responsibility is to its Client and this document does not exonerate parties to a transaction from exercising all their rights and obligations under the transaction documents. This document cannot be reproduced except in full, without prior written approval of the Company. Any unauthorized alteration, forgery or falsification of the content or appearance of this document is unlawful and offenders may be prosecuted to the fullest extent of the law.

1.4 FCC

Wi-Fi	Frequency Range	Channels	Rated Power(Avg) (dBm) (Worst Case)	Modulation Technology
a/ n_HT/ ac_VHT 20M	5180~5240	4	10.31 dBm	OFDM
	5260~5320	4	10.32 dBm	OFDM
	5745-5825	5	6.41 dBm	OFDM
n_HT/ ac_VHT 40M	5190~5230	2	10.48 dBm	OFDM
	5270~5310	2	10.34 dBm	OFDM
	5755-5795	2	6.23 dBm	OFDM
ac_VHT 80M	5210	1	10.87 dBm	OFDM
	5290	1	10.76 dBm	OFDM
	5775	1	7.58 dBm	OFDM

1.5 ISED

Wi-Fi	Frequency Range	Channels	EIRP/Avg	Rated Power(EIRP/Avg) (dBm) (Worst Case)	Modulation Technology
a/ n_HT/ ac_VHT 20M	5180~5240	4	EIRP	17.97 dBm	OFDM
	5260~5320	4	Avg	10.32 dBm	OFDM
	5745-5825	5	Avg	6.41 dBm	OFDM
n_HT/ ac_VHT 40M	5190~5230	2	EIRP	18.14 dBm	OFDM
	5270~5310	2	Avg	10.34 dBm	OFDM
	5755-5795	2	Avg	6.23 dBm	OFDM
ac_VHT 80M	5210	1	EIRP	18.53 dBm	OFDM
	5290	1	Avg	10.76 dBm	OFDM
	5775	1	Avg	7.58 dBm	OFDM

Unless otherwise stated the results shown in this test report refer only to the sample(s) tested and such sample(s) are retained for 90 days only.

除非另有說明，此報告結果僅對測試之樣品負責，同時此樣品僅保留90天。本報告未經本公司書面許可，不可部份複製。

This document is issued by the Company subject to its General Conditions of Service printed overleaf, available on request or accessible at <http://www.sgs.com.tw/Terms-and-Conditions> and for electronic format documents, subject to Terms and Conditions for Electronic Documents at <http://www.sgs.com.tw/Terms-and-Conditions>. Attention is drawn to the limitation of liability, indemnification and jurisdiction issues defined therein. Any holder of this document is advised that information contained hereon reflects the Company's findings at the time of its intervention only and within the limits of Client's instructions, if any. The Company's sole responsibility is to its Client and this document does not exonerate parties to a transaction from exercising all their rights and obligations under the transaction documents. This document cannot be reproduced except in full, without prior written approval of the Company. Any unauthorized alteration, forgery or falsification of the content or appearance of this document is unlawful and offenders may be prosecuted to the fullest extent of the law.

1.6 Test Methodology of Applied Standards

FCC Part 15, Subpart E §15.407
 FCC KDB 789033 D02 General UNII Test Procedures New Rules v02r01
 FCC KDB 662911 D01 Multiple Transmitter Output v02r01
 RSS-247 issue 2 Feb. 2017
 RSS-Gen, Issue 5 (Amendment 2, February 2021)
 ANSI C63.10:2013

1.7 Test Facility

Laboratory	Test Site Address	Test Site Name	FCC Designation number	IC CAB identifier
SGS Taiwan Ltd. Central RF Lab. (TAF code 3702)	No.134, Wu Kung Road, New Taipei Industrial Park, Wuku District, New Taipei City, Taiwan.	SAC 1	TW0027	TW3702
		SAC 3		
		Conduction 1		
		Conducted 1		
		Conducted 2		
		Conducted 3		
		Conducted 4		
		Conducted 5		
	Conducted 6			
	No.2, Keji 1st Rd., Guishan District, Taoyuan City, Taiwan 333	Conduction C	TW0028	
		SAC C		
		SAC D		
		SAC G		
		Conducted A		
		Conducted B		
		Conducted C		
		Conducted D		
		Conducted E		
		Conducted F		
Conducted G				

Note: Test site name is remarked on the equipment list in each section of this report as an indication where measurements occurred in specific test site and address.

1.8 Special Accessories

There are no special accessories used while test was conducted.

1.9 Equipment Modifications

There was no modification incorporated into the EUT.

Unless otherwise stated the results shown in this test report refer only to the sample(s) tested and such sample(s) are retained for 90 days only.
 除非另有說明，此報告結果僅對測試之樣品負責，同時此樣品僅保留90天。本報告未經本公司書面許可，不可部份複製。

This document is issued by the Company subject to its General Conditions of Service printed overleaf, available on request or accessible at <http://www.sgs.com.tw/Terms-and-Conditions> and for electronic format documents, subject to Terms and Conditions for Electronic Documents at <http://www.sgs.com.tw/Terms-and-Conditions>. Attention is drawn to the limitation of liability, indemnification and jurisdiction issues defined therein. Any holder of this document is advised that information contained hereon reflects the Company's findings at the time of its intervention only and within the limits of Client's instructions, if any. The Company's sole responsibility is to its Client and this document does not exonerate parties to a transaction from exercising all their rights and obligations under the transaction documents. This document cannot be reproduced except in full, without prior written approval of the Company. Any unauthorized alteration, forgery or falsification of the content or appearance of this document is unlawful and offenders may be prosecuted to the fullest extent of the law.

2 SYSTEM TEST CONFIGURATION

2.1 EUT Configuration

The EUT configuration for testing is installed on RF field strength measurement to meet the Commissions requirement and operating in a manner which intends to maximize its emission characteristics in a continuous normal application.

2.2 EUT Exercise

An engineering test mode (software/firmware) that applicant provided was utilized to manipulate the EUT into transmit, selection of the test channel, and modulation scheme.

2.3 Test Procedure

2.3.1 Conducted Emissions

The EUT is placed on a table which is 0.8 m above ground plane. Conducted emissions from the EUT measured in the frequency range between 0.15 MHz and 30MHz. The CISPR Quasi-Peak and Average detector mode is employed. The two LISNs provide 50uH/50 ohm of coupling impedance for the measuring instrument. Both lines of the power mains connected to the EUT were checked for maximum conducted interference.

2.3.2 Conducted Test (RF)

The active antenna port of the unlicensed wireless device is connected to the spectrum analyzer with attenuator to protect the instrumentation. If a second antenna port is available, it is tested at one operating frequency, with other port(s) appropriately terminated, to verify it has similar output characteristics as the fully tested port.

2.3.3 Radiated Emissions

The EUT is placed on a turn table. For emissions testing at or below 1 GHz, the table height shall be 0.8 m above the reference ground plane. For emission measurements above 1 GHz, the table height shall be 1.5 m. The turn table shall rotate 360 degrees to determine the position of maximum emission level. EUT is set 3m away from the receiving antenna which varied from 1m to 4m to find out the highest emission. And also, each emission was to be maximized by changing the polarization of receiving antenna both horizontal and vertical. In order to find out the max. emission, the relative positions of this transmitter (EUT) was rotated through three orthogonal axes and measurement procedures for electric field radiated emissions above 1 GHz the EUT measurement is to be made "while keeping the antenna in the 'cone of radiation' from that area and pointed at the area both in azimuth and elevation, with polarization oriented for maximum response." is still within the 3dB illumination BW of the measurement antenna.

Unless otherwise stated the results shown in this test report refer only to the sample(s) tested and such sample(s) are retained for 90 days only.

除非另有說明，此報告結果僅對測試之樣品負責，同時此樣品僅保留90天。本報告未經本公司書面許可，不可部份複製。

This document is issued by the Company subject to its General Conditions of Service printed overleaf, available on request or accessible at <http://www.sgs.com.tw/Terms-and-Conditions> and for electronic format documents, subject to Terms and Conditions for Electronic Documents at <http://www.sgs.com.tw/Terms-and-Conditions>. Attention is drawn to the limitation of liability, indemnification and jurisdiction issues defined therein. Any holder of this document is advised that information contained hereon reflects the Company's findings at the time of its intervention only and within the limits of Client's instructions, if any. The Company's sole responsibility is to its Client and this document does not exonerate parties to a transaction from exercising all their rights and obligations under the transaction documents. This document cannot be reproduced except in full, without prior written approval of the Company. Any unauthorized alteration, forgery or falsification of the content or appearance of this document is unlawful and offenders may be prosecuted to the fullest extent of the law.

2.4 Measurement Results Explanation Example

2.4.1 Radiated Emission Test Sites For Measurements From 9 kHz To 30 MHz

Radiated emission below 30MHz is measured in a 9m*6m*6m semi-anechoic chamber, the measurements correspond to those obtained at an open-field test site.

There is a comparison data of both open-field test site and semi-Anechoic chamber, and the result came out very similar.

2.4.2 For all conducted test items:

The offset level is set in the spectrum analyzer to compensate the RF cable loss and attenuation factor between EUT conducted port and spectrum analyzer. With the offset compensation, the spectrum analyzer reading level is exactly EUT RF output level.

Unless otherwise stated the results shown in this test report refer only to the sample(s) tested and such sample(s) are retained for 90 days only.

除非另有說明，此報告結果僅對測試之樣品負責，同時此樣品僅保留90天。本報告未經本公司書面許可，不可部份複製。

This document is issued by the Company subject to its General Conditions of Service printed overleaf, available on request or accessible at <http://www.sgs.com.tw/Terms-and-Conditions> and for electronic format documents, subject to Terms and Conditions for Electronic Documents at <http://www.sgs.com.tw/Terms-and-Conditions>. Attention is drawn to the limitation of liability, indemnification and jurisdiction issues defined therein. Any holder of this document is advised that information contained hereon reflects the Company's findings at the time of its intervention only and within the limits of Client's instructions, if any. The Company's sole responsibility is to its Client and this document does not exonerate parties to a transaction from exercising all their rights and obligations under the transaction documents. This document cannot be reproduced except in full, without prior written approval of the Company. Any unauthorized alteration, forgery or falsification of the content or appearance of this document is unlawful and offenders may be prosecuted to the fullest extent of the law.

2.5 Test Configuration

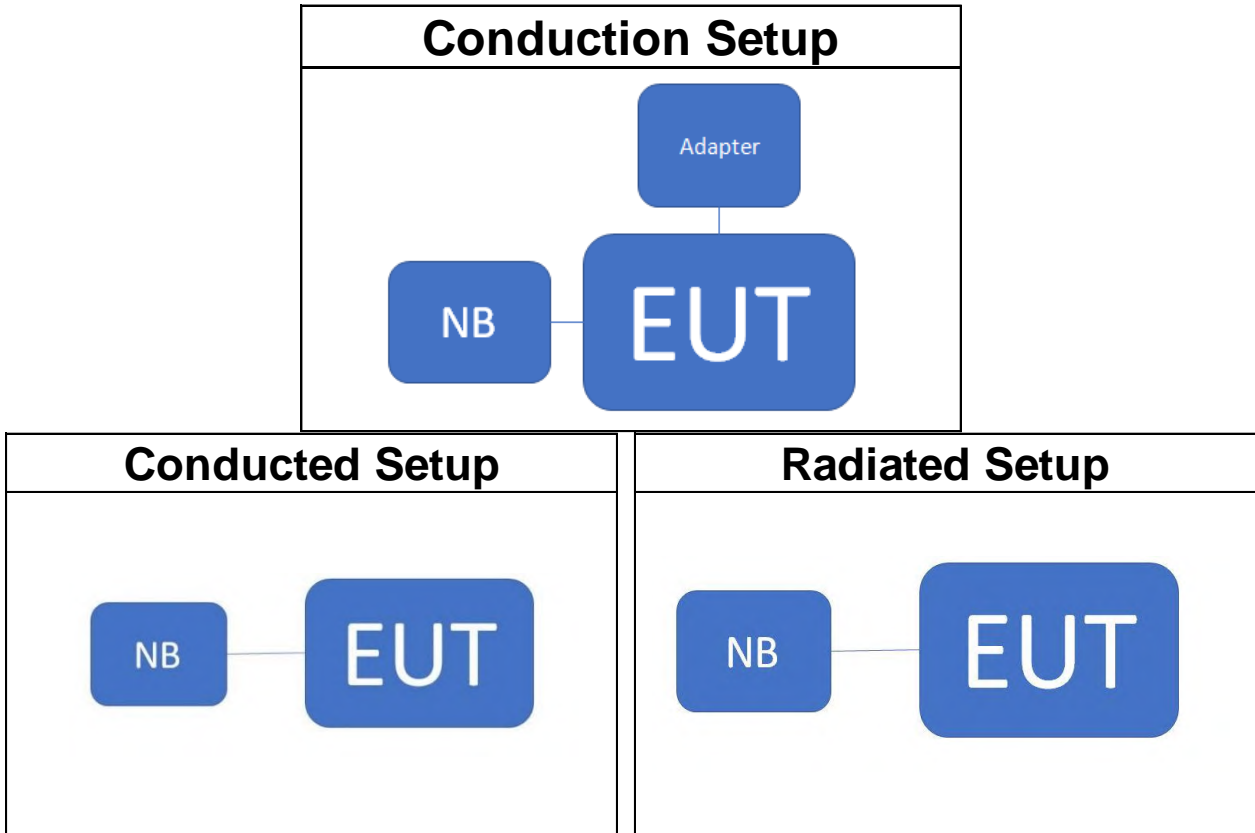

2.6 Control Unit(s)

AC Power-Line Conducted Emission Test Site: Conduction 1					
EQUIPMENT TYPE	MFR	MODEL NUMBER	SERIAL NUMBER	LAST CAL.	CAL DUE.
Test Software	Audix	e3	Ver. 9.210322	N.C.R	N.C.R
LAN Cable	HOSIWELL	CAT5	N/A	N/A	N/A
Notebook	Lenovo	L430	R9-WGNK5	N/A	N/A
Conducted Emission Test Site: Conducted 3					
EQUIPMENT TYPE	MFR	MODEL NUMBER	SERIAL NUMBER	LAST CAL.	CAL DUE.
Test Software	SGS	Radio Test Software	Ver. 21	N.C.R	N.C.R
Notebook	Lenovo	L430	R9-WGNK5	N/A	N/A
LAN Cable	HOSIWELL	CAT5	N/A	N/A	N/A
Radiated Emission Test Site: SAC 1					
EQUIPMENT TYPE	MFR	MODEL NUMBER	SERIAL NUMBER	LAST CAL.	CAL DUE.
Test Software	Audix	e3	Ver. 9.210322	N.C.R	N.C.R
LAN Cable	HOSIWELL	CAT5	N/A	N/A	N/A
Notebook	Lenovo	L430	R9-WGNK5	N/A	N/A

Unless otherwise stated the results shown in this test report refer only to the sample(s) tested and such sample(s) are retained for 90 days only.

除非另有說明，此報告結果僅對測試之樣品負責，同時此樣品僅保留90天。本報告未經本公司書面許可，不可部份複製。

This document is issued by the Company subject to its General Conditions of Service printed overleaf, available on request or accessible at <http://www.sgs.com.tw/Terms-and-Conditions> and for electronic format documents, subject to Terms and Conditions for Electronic Documents at <http://www.sgs.com.tw/Terms-and-Conditions>. Attention is drawn to the limitation of liability, indemnification and jurisdiction issues defined therein. Any holder of this document is advised that information contained hereon reflects the Company's findings at the time of its intervention only and within the limits of Client's instructions, if any. The Company's sole responsibility is to its Client and this document does not exonerate parties to a transaction from exercising all their rights and obligations under the transaction documents. This document cannot be reproduced except in full, without prior written approval of the Company. Any unauthorized alteration, forgery or falsification of the content or appearance of this document is unlawful and offenders may be prosecuted to the fullest extent of the law.

3 SUMMARY OF TEST RESULT

FCC Rules	ISED Rules	Description Of Test	Result
§15.207	RSS-Gen §8.8	AC Power Line Conducted Emission	Compliant
§15.407(e)	RSS-Gen §6.7 RSS-247 §6.2.4.1	Emission Bandwidth	Compliant
§15.407(a)	RSS-247 §6.2.1~ 4 (1)	Maximum Conducted Output Power	Compliant
§15.407(a)	RSS-247 §6.2.1~ 4 (1)	Power Spectral Density	Compliant
§15.205 §15.209 §15.407(b)	RSS-247 §6.2.1~ 4 (2)	Undesirable Radiated Emissions	Compliant
§15.407(c)	RSS-247 §6.4	Transmission in case of Absence of Information	Compliant
§15.203	N/A	Antenna Requirement	Compliant

Unless otherwise stated the results shown in this test report refer only to the sample(s) tested and such sample(s) are retained for 90 days only.

除非另有說明，此報告結果僅對測試之樣品負責，同時此樣品僅保留90天。本報告未經本公司書面許可，不可部份複製。

This document is issued by the Company subject to its General Conditions of Service printed overleaf, available on request or accessible at <http://www.sgs.com.tw/Terms-and-Conditions> and for electronic format documents, subject to Terms and Conditions for Electronic Documents at <http://www.sgs.com.tw/Terms-and-Conditions>. Attention is drawn to the limitation of liability, indemnification and jurisdiction issues defined therein. Any holder of this document is advised that information contained hereon reflects the Company's findings at the time of its intervention only and within the limits of Client's instructions, if any. The Company's sole responsibility is to its Client and this document does not exonerate parties to a transaction from exercising all their rights and obligations under the transaction documents. This document cannot be reproduced except in full, without prior written approval of the Company. Any unauthorized alteration, forgery or falsification of the content or appearance of this document is unlawful and offenders may be prosecuted to the fullest extent of the law.

4 DESCRIPTION OF TEST MODES

4.1 Operating Frequencies

Operated band in 5150 MHz ~5250 MHz:

20 M	
CH	Freq (MHz)
36	5180
40	5200
44	5220
48	5240

40 M	
CH	Freq (MHz)
38	5190
46	5230

80 M	
CH	Freq (MHz)
42	5210

Operated band in 5250 MHz ~5350 MHz:

20 M	
CH	Freq (MHz)
52	5260
56	5280
60	5300
64	5320

40 M	
CH	Freq (MHz)
54	5270
62	5310

80 M	
CH	Freq (MHz)
58	5290

Operated band in 5725 MHz ~5850 MHz:

20 M	
CH	Freq (MHz)
149	5745
153	5765
157	5785
161	5805
165	5825

40 M	
CH	Freq (MHz)
151	5755
159	5795

80 M	
CH	Freq (MHz)
155	5775

Unless otherwise stated the results shown in this test report refer only to the sample(s) tested and such sample(s) are retained for 90 days only.

除非另有說明，此報告結果僅對測試之樣品負責，同時此樣品僅保留90天。本報告未經本公司書面許可，不可部份複製。

This document is issued by the Company subject to its General Conditions of Service printed overleaf, available on request or accessible at <http://www.sgs.com.tw/Terms-and-Conditions> and for electronic format documents, subject to Terms and Conditions for Electronic Documents at <http://www.sgs.com.tw/Terms-and-Conditions>. Attention is drawn to the limitation of liability, indemnification and jurisdiction issues defined therein. Any holder of this document is advised that information contained hereon reflects the Company's findings at the time of its intervention only and within the limits of Client's instructions, if any. The Company's sole responsibility is to its Client and this document does not exonerate parties to a transaction from exercising all their rights and obligations under the transaction documents. This document cannot be reproduced except in full, without prior written approval of the Company. Any unauthorized alteration, forgery or falsification of the content or appearance of this document is unlawful and offenders may be prosecuted to the fullest extent of the law.

4.2 The Worst Test Modes and Channel Details

1. The EUT has been tested under operating condition.
2. Test program used to control the EUT for staying in continuous transmitting mode is programmed.
3. Investigation has been done on all the possible configurations for searching the worst case. The given UE is pre-scanned among below modes.

Modulation		Transmission Chain						Single Transmission Spatial	Multiple Transmission Spatial			
v	802.11 a	v	Ch0	v	Ch1		Ch2		Ch3	1TX	v	2TX
v	802.11 n	v	Ch0	v	Ch1		Ch2		Ch3	SISO	v	MIMO
v	802.11 ac	v	Ch0	v	Ch1		Ch2		Ch3	SISO	v	MIMO
	802.11 ax		Ch0		Ch1		Ch2		Ch3	SISO		MIMO

4. Therefore, below summary is the modes of test configuration that yield the highest reading and generate the highest emission chosen to carry out the relevantly mandatory test items.

RADIATED EMISSION TEST (BELOW 1 GHz)						
MODE	FREQUENCY BAND (MHz)	AVAILABLE CHANNEL	TESTED CHANNEL	MODULATION	DATA RATE (Mbps)	ANTENNA PORT
802.11a	5180~5240	36 to 48	44	OFDM	6	2TX
	5260~5320	52 to 64	60			
	5745~5825	149 to 165	157			
RADIATED EMISSION TEST (ABOVE 1 GHz)						
MODE	FREQUENCY BAND (MHz)	AVAILABLE CHANNEL	TESTED CHANNEL	MODULATION	DATA RATE (Mbps)	ANTENNA PORT
802.11a	5180~5240	36 to 48	36,44,48	OFDM	6	2TX
	5260~5320	52 to 64	52,60,64			
	5745~5825	149 to 165	149,157,165			
802.11n_HT20	5180~5240	36 to 48	36,44,48	OFDM	MCS8	MIMO
	5260~5320	52 to 64	52,60,64			
	5745~5825	149 to 165	149,157,165			
802.11n_HT40	5190~5230	38 to 46	38,46	OFDM	MCS8	MIMO
	5270~5310	54 to 62	54,62			
	5755~5795	151 to 159	151,159			
802.11ac_VHT80	5210	42	42	OFDM	MCS0	MIMO
	5290	58	58			
	5775	155	155			

Unless otherwise stated the results shown in this test report refer only to the sample(s) tested and such sample(s) are retained for 90 days only.

除非另有說明，此報告結果僅對測試之樣品負責，同時此樣品僅保留90天。本報告未經本公司書面許可，不可部份複製。

This document is issued by the Company subject to its General Conditions of Service printed overleaf, available on request or accessible at <http://www.sgs.com.tw/Terms-and-Conditions> and for electronic format documents, subject to Terms and Conditions for Electronic Documents at <http://www.sgs.com.tw/Terms-and-Conditions>. Attention is drawn to the limitation of liability, indemnification and jurisdiction issues defined therein. Any holder of this document is advised that information contained hereon reflects the Company's findings at the time of its intervention only and within the limits of Client's instructions, if any. The Company's sole responsibility is to its Client and this document does not exonerate parties to a transaction from exercising all their rights and obligations under the transaction documents. This document cannot be reproduced except in full, without prior written approval of the Company. Any unauthorized alteration, forgery or falsification of the content or appearance of this document is unlawful and offenders may be prosecuted to the fullest extent of the law.

CONDUCTED TEST						
MODE	FREQUENCY BAND (MHz)	AVAILABLE CHANNEL	TESTED CHANNEL	MODULATION	DATA RATE (Mbps)	ANTENNA PORT
802.11a	5180~5240	36 to 48	36,44,48	OFDM	6	2TX
	5260~5320	52 to 64	52,60,64			
	5745~5825	149 to 165	149,157,165			
802.11n_HT20	5180~5240	36 to 48	36,44,48	OFDM	MCS8	MIMO
	5260~5320	52 to 64	52,60,64			
	5745~5825	149 to 165	149,157,165			
802.11n_HT40	5190~5230	38 to 46	38,46	OFDM	MCS8	MIMO
	5270~5310	54 to 62	54,62			
	5755~5795	151 to 159	151,159			
802.11ac_VHT80	5210	42	42	OFDM	MCS0	MIMO
	5290	58	58			
	5775	155	155			

Note:

The field strength of radiated emission was measured as the EUT positioned in different orthogonal planes (E1/E2/H) based on actual usage of the EUT to pre-scan the emissions for determining the worst case scenario.

Unless otherwise stated the results shown in this test report refer only to the sample(s) tested and such sample(s) are retained for 90 days only.

除非另有說明，此報告結果僅對測試之樣品負責，同時此樣品僅保留90天。本報告未經本公司書面許可，不可部份複製。

This document is issued by the Company subject to its General Conditions of Service printed overleaf, available on request or accessible at <http://www.sgs.com.tw/Terms-and-Conditions> and for electronic format documents, subject to Terms and Conditions for Electronic Documents at <http://www.sgs.com.tw/Terms-and-Conditions>. Attention is drawn to the limitation of liability, indemnification and jurisdiction issues defined therein. Any holder of this document is advised that information contained hereon reflects the Company's findings at the time of its intervention only and within the limits of Client's instructions, if any. The Company's sole responsibility is to its Client and this document does not exonerate parties to a transaction from exercising all their rights and obligations under the transaction documents. This document cannot be reproduced except in full, without prior written approval of the Company. Any unauthorized alteration, forgery or falsification of the content or appearance of this document is unlawful and offenders may be prosecuted to the fullest extent of the law.

5 MEASUREMENT UNCERTAINTY

Test Items	Uncertainty
AC Power Line Conducted Emission	+/- 2.34 dB
Output Power measurement	+/- 1 dB
Emission Bandwidth	+/- 1.53 Hz
Undesignable radiated emission measurement	+/- 1.68 dB
Peak Power Density	+/- 1.62 dB
Temperature	+/- 0.4 °C
Humidity	+/- 3.5 %
DC / AC Power Source	+/- 1 %

Radiated Spurious Emission Measurement Uncertainty			
Polarization: Vertical	+/-	2.57 dB	9kHz~30MHz
	+/-	4.85 dB	30MHz - 1000MHz
	+/-	4.45 dB	1GHz - 18GHz
	+/-	4.24 dB	18GHz - 40GHz
Polarization: Horizontal	+/-	2.57 dB	9kHz~30MHz
	+/-	4.37 dB	30MHz - 1000MHz
	+/-	4.45 dB	1GHz - 18GHz
	+/-	4.24 dB	18GHz - 40GHz

Note:

1. This uncertainty represents an expanded uncertainty expressed at approximately the 95% confidence level using a coverage factor of k=2.
2. The conformity assessment statement in this report is based solely on the test results, measurement uncertainty is excluded.

Unless otherwise stated the results shown in this test report refer only to the sample(s) tested and such sample(s) are retained for 90 days only.

除非另有說明，此報告結果僅對測試之樣品負責，同時此樣品僅保留90天。本報告未經本公司書面許可，不可部份複製。

This document is issued by the Company subject to its General Conditions of Service printed overleaf, available on request or accessible at <http://www.sgs.com.tw/Terms-and-Conditions> and for electronic format documents, subject to Terms and Conditions for Electronic Documents at <http://www.sgs.com.tw/Terms-and-Conditions>. Attention is drawn to the limitation of liability, indemnification and jurisdiction issues defined therein. Any holder of this document is advised that information contained hereon reflects the Company's findings at the time of its intervention only and within the limits of Client's instructions, if any. The Company's sole responsibility is to its Client and this document does not exonerate parties to a transaction from exercising all their rights and obligations under the transaction documents. This document cannot be reproduced except in full, without prior written approval of the Company. Any unauthorized alteration, forgery or falsification of the content or appearance of this document is unlawful and offenders may be prosecuted to the fullest extent of the law.

6 MEASUREMENT EQUIPMENT USED

6.1 Emission from AC power line

AC Power-Line Conducted Emission Test Site: Conduction 1					
EQUIPMENT TYPE	MFR	MODEL NUMBER	SERIAL NUMBER	LAST CAL.	CAL DUE.
LISN	SCHWARZBECK	NSLK 8127	1040	08/10/2021	08/09/2022
Coaxial Cables	N/A	Coaxial Cable	161207	12/07/2021	12/06/2022
EMI Test Receiver	R&S	ESCI 7	100759	08/26/2021	08/25/2022

6.2 Conducted Measurement

Conducted Emission Test Site: Conducted 3					
EQUIPMENT TYPE	MFR	MODEL NUMBER	SERIAL NUMBER	LAST CAL.	CAL DUE.
PXA Spectrum Analyzer	Agilent	N9030A	MY53120760	04/27/2021	04/26/2022
Power Meter	Anritsu	ML2496A	2132007	11/12/2021	11/11/2022
Power Sensor	Anritsu	MA2411B	1911391	09/21/2021	09/20/2022
Power Sensor	Anritsu	MA2411B	1911392	09/21/2021	09/20/2022
Attenuator	Mini-Circuit	BW-S10W2+	4	12/14/2021	12/13/2022
DC Block	Mini-Circuits	BLK-18-S+	1	12/14/2021	12/13/2022

Unless otherwise stated the results shown in this test report refer only to the sample(s) tested and such sample(s) are retained for 90 days only.

除非另有說明，此報告結果僅對測試之樣品負責，同時此樣品僅保留90天。本報告未經本公司書面許可，不可部份複製。

This document is issued by the Company subject to its General Conditions of Service printed overleaf, available on request or accessible at <http://www.sgs.com.tw/Terms-and-Conditions> and for electronic format documents, subject to Terms and Conditions for Electronic Documents at <http://www.sgs.com.tw/Terms-and-Conditions>. Attention is drawn to the limitation of liability, indemnification and jurisdiction issues defined therein. Any holder of this document is advised that information contained hereon reflects the Company's findings at the time of its intervention only and within the limits of Client's instructions, if any. The Company's sole responsibility is to its Client and this document does not exonerate parties to a transaction from exercising all their rights and obligations under the transaction documents. This document cannot be reproduced except in full, without prior written approval of the Company. Any unauthorized alteration, forgery or falsification of the content or appearance of this document is unlawful and offenders may be prosecuted to the fullest extent of the law.

6.3 Radiated Measurement

Radiated Emission Test Site: SAC 1					
EQUIPMENT TYPE	MFR	MODEL NUMBER	SERIAL NUMBER	LAST CAL.	CAL DUE.
Horn Antenna	SCHWARZBECK	BBHA9120D	D803	12/20/2021	12/19/2022
Bi-log Antenna	TESEO	CBL 6112D	35242 & AT-N0555	01/03/2022	01/02/2023
Horn Antenna	SCHWARZBECK	BBHA9170	184	12/16/2021	12/15/2022
Loop Antenna	ETS.LINDGREN	6502	148045	09/29/2021	09/28/2022
Site Cal	SGS	SAC I chamber	N/A	01/01/2022	12/31/2022
EXA Spectrum Analyzer	Agilent	N9010A	MY50420195	05/12/2021	05/11/2022
EMI Test Receiver	R&S	ESCI 7	100759	08/26/2021	08/25/2022
Pre-Amplifier	EMC Instruments	EMC184045B	980135	10/27/2021	10/26/2022
Pre-Amplifier	HP	8449B	3008A01973	12/16/2021	12/15/2022
Pre-Amplifier	HP	8447D	2944A09469	12/16/2021	12/15/2022
Attenuator	Mini-Circuit	BW-S10W2+	4	12/14/2021	12/13/2022
Bandreject Filter 5725-5875	Micro-Tronics	BRM50705	1	12/14/2021	12/13/2022
7GHz High Pass Filter	WI	WHKX10-6090-80SS	3	12/14/2021	12/13/2022
Coaxial Cable	Huber Suhner	succoflex 102	MY2622/2	12/16/2021	12/15/2022
Coaxial Cable	Huber Suhner	succoflex 104A	800086/4a	12/16/2021	12/15/2022
Coaxial Cable	Huber Suhner	EMC 104-SM-SM-2000	160123	12/16/2021	12/15/2022
Coaxial Cable	Huber Suhner	SUCOFLEX 102	MY2630/2	12/16/2021	12/15/2022
Coaxial Cable	Huber Suhner	SUCOFLEX 102	MY22962/2	12/16/2021	12/15/2022

Unless otherwise stated the results shown in this test report refer only to the sample(s) tested and such sample(s) are retained for 90 days only.

除非另有說明，此報告結果僅對測試之樣品負責，同時此樣品僅保留90天。本報告未經本公司書面許可，不可部份複製。

This document is issued by the Company subject to its General Conditions of Service printed overleaf, available on request or accessible at <http://www.sgs.com.tw/Terms-and-Conditions> and for electronic format documents, subject to Terms and Conditions for Electronic Documents at <http://www.sgs.com.tw/Terms-and-Conditions>. Attention is drawn to the limitation of liability, indemnification and jurisdiction issues defined therein. Any holder of this document is advised that information contained hereon reflects the Company's findings at the time of its intervention only and within the limits of Client's instructions, if any. The Company's sole responsibility is to its Client and this document does not exonerate parties to a transaction from exercising all their rights and obligations under the transaction documents. This document cannot be reproduced except in full, without prior written approval of the Company. Any unauthorized alteration, forgery or falsification of the content or appearance of this document is unlawful and offenders may be prosecuted to the fullest extent of the law.

7 CONDUCTED EMISSION TEST

7.1 Standard Applicable

Frequency range within 150 kHz to 30 MHz shall not exceed the Limit table as below.

Frequency range MHz	Limits (dBuV)	
	Quasi-peak	Average
0.15 to 0.50	66 to 56	56 to 46
0.50 to 5	56	46
5 to 30	60	50

Note

- The lower limit shall apply at the transition frequencies
- The limit decreases linearly with the logarithm of the frequency in the range 0.15 MHz to 0.50 MHz.

7.2 EUT Setup

- The conducted emission tests were performed in the test site, using the setup in accordance with the ANSI C63.10:2013.
- The AC/DC Power adaptor of EUT was plug-in LISN. The rear of the EUT and peripherals were placed flushed with the rear of the tabletop.
- The LISN was connected with 120Vac/60Hz power source.

7.3 Test SET-UP

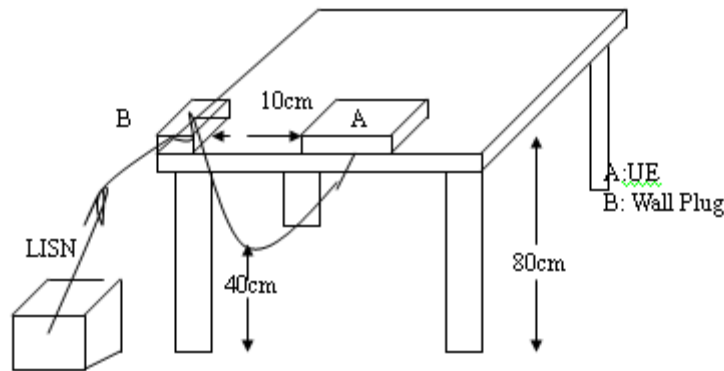

7.4 Measurement Procedure

- The EUT was placed on a table which is 0.8m above ground plane.
- Maximum procedure was performed on the six highest emissions to ensure EUT compliance.
- Repeat above procedures until all phases of power being supplied by given UE are completed.

Unless otherwise stated the results shown in this test report refer only to the sample(s) tested and such sample(s) are retained for 90 days only.

除非另有說明，此報告結果僅對測試之樣品負責，同時此樣品僅保留90天。本報告未經本公司書面許可，不可部份複製。

This document is issued by the Company subject to its General Conditions of Service printed overleaf, available on request or accessible at <http://www.sgs.com.tw/Terms-and-Conditions> and for electronic format documents, subject to Terms and Conditions for Electronic Documents at <http://www.sgs.com.tw/Terms-and-Conditions>. Attention is drawn to the limitation of liability, indemnification and jurisdiction issues defined therein. Any holder of this document is advised that information contained hereon reflects the Company's findings at the time of its intervention only and within the limits of Client's instructions, if any. The Company's sole responsibility is to its Client and this document does not exonerate parties to a transaction from exercising all their rights and obligations under the transaction documents. This document cannot be reproduced except in full, without prior written approval of the Company. Any unauthorized alteration, forgery or falsification of the content or appearance of this document is unlawful and offenders may be prosecuted to the fullest extent of the law.

7.5 Measurement Result

Note: Refer to next page for measurement data and plots.

Note2: The * reveals the worst-case results that closet to the limit.

Unless otherwise stated the results shown in this test report refer only to the sample(s) tested and such sample(s) are retained for 90 days only.

除非另有說明，此報告結果僅對測試之樣品負責，同時此樣品僅保留90天。本報告未經本公司書面許可，不可部份複製。

This document is issued by the Company subject to its General Conditions of Service printed overleaf, available on request or accessible at <http://www.sgs.com.tw/Terms-and-Conditions> and for electronic format documents, subject to Terms and Conditions for Electronic Documents at <http://www.sgs.com.tw/Terms-and-Conditions>. Attention is drawn to the limitation of liability, indemnification and jurisdiction issues defined therein. Any holder of this document is advised that information contained hereon reflects the Company's findings at the time of its intervention only and within the limits of Client's instructions, if any. The Company's sole responsibility is to its Client and this document does not exonerate parties to a transaction from exercising all their rights and obligations under the transaction documents. This document cannot be reproduced except in full, without prior written approval of the Company. Any unauthorized alteration, forgery or falsification of the content or appearance of this document is unlawful and offenders may be prosecuted to the fullest extent of the law.

AC POWER LINE CONDUCTED EMISSION TEST DATA

Report Number :ER/2022/20002
 Test Mode :WIFI 5G
 Power :120V/60Hz
 Probe :L
 Note: :

Test Site :Conduction 1
 Test Date :2022-04-20
 Temp./Humi. :23.7/64
 Engineer :GN Lin

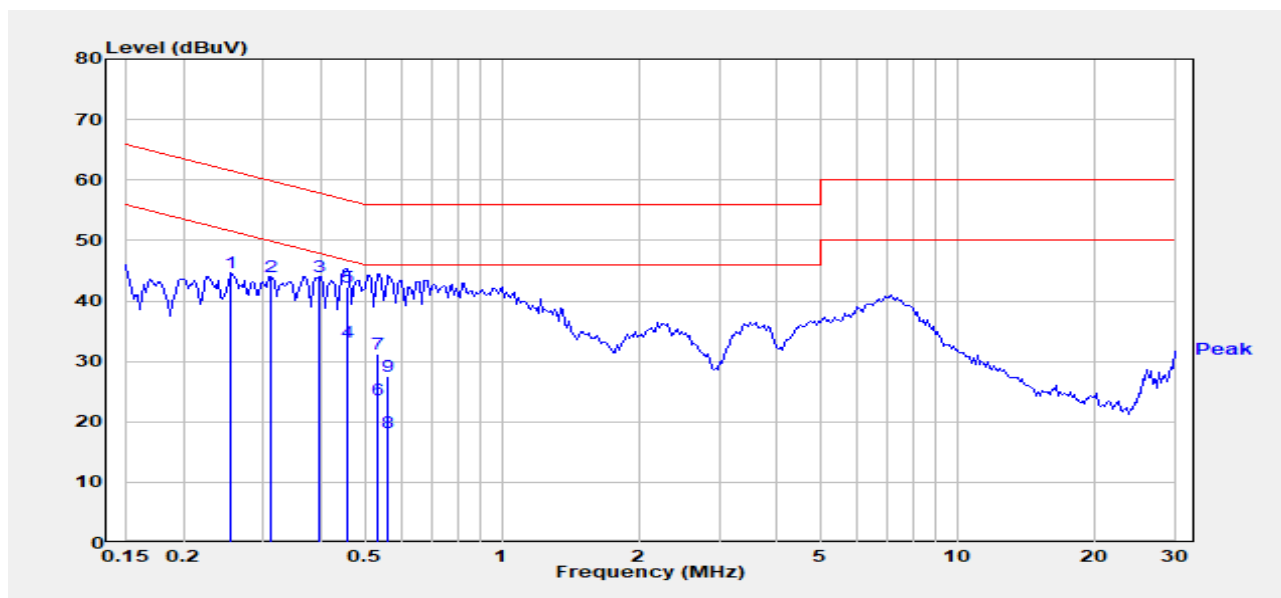

Freq. MHz	Detector Mode PK/QP/AV	Spectrum Reading Level dBμV	Factor dB	Actual FS dBμV	Limit dBμV	Margin dB
0.255	Peak	42.45	2.12	44.57	61.60	-17.03
0.312	Peak	41.95	2.12	44.07	59.93	-15.85
0.398	Peak	41.99	2.12	44.11	57.90	-13.79
0.456	Average	30.95	2.12	33.07	46.76	-13.69
0.456	QP	40.23	2.12	42.35	56.76	-14.41
0.535	Average	21.53	2.12	23.65	46.00	-22.35
0.535	QP	29.15	2.12	31.27	56.00	-24.73
0.564	Average	16.17	2.12	18.29	46.00	-27.71
0.564	QP	25.43	2.12	27.55	56.00	-28.45

Unless otherwise stated the results shown in this test report refer only to the sample(s) tested and such sample(s) are retained for 90 days only.

除非另有說明，此報告結果僅對測試之樣品負責，同時此樣品僅保留90天。本報告未經本公司書面許可，不可部份複製。

This document is issued by the Company subject to its General Conditions of Service printed overleaf, available on request or accessible at <http://www.sgs.com.tw/Terms-and-Conditions> and for electronic format documents, subject to Terms and Conditions for Electronic Documents at <http://www.sgs.com.tw/Terms-and-Conditions>. Attention is drawn to the limitation of liability, indemnification and jurisdiction issues defined therein. Any holder of this document is advised that information contained hereon reflects the Company's findings at the time of its intervention only and within the limits of Client's instructions, if any. The Company's sole responsibility is to its Client and this document does not exonerate parties to a transaction from exercising all their rights and obligations under the transaction documents. This document cannot be reproduced except in full, without prior written approval of the Company. Any unauthorized alteration, forgery or falsification of the content or appearance of this document is unlawful and offenders may be prosecuted to the fullest extent of the law.

Report Number :ER/2022/20002

Test Site :Conduction 1

Test Mode :WIFI 5G

Test Date :2022-04-20

Power :120V/60Hz

Temp./Humi. :23.7/64

Probe :N

Engineer :GN Lin

Note: :

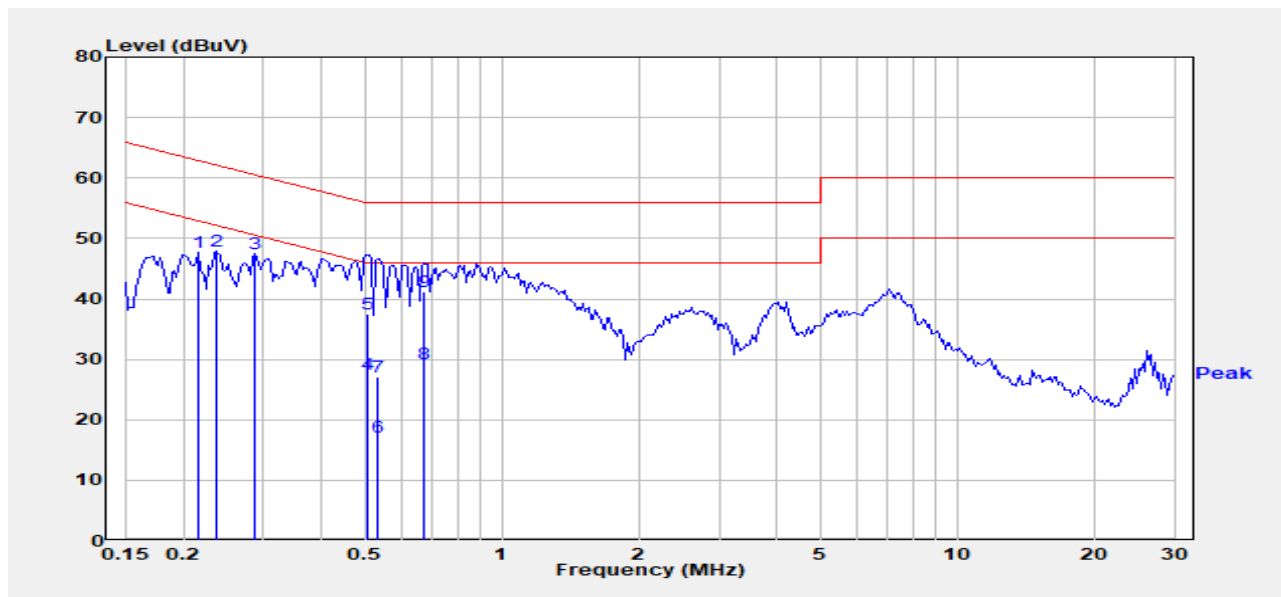

Freq. MHz	Detector Mode PK/QP/AV	Spectrum Reading Level dBμV	Factor dB	Actual FS dBμV	Limit dBμV	Margin dB
0.215	Peak	45.48	2.28	47.76	63.01	-15.25
0.237	Peak	45.59	2.26	47.85	62.22	-14.37
0.286	Peak	45.19	2.21	47.39	60.63	-13.24
0.507	Average	25.47	2.12	27.59	46.00	-18.41
0.507	QP	35.32	2.12	37.44	56.00	-18.56
0.535	Average	15.04	2.12	17.16	46.00	-28.84
0.535	QP	24.93	2.12	27.05	56.00	-28.95
0.675	Average	27.25	2.13	29.38	46.00	-16.62
0.675	QP	38.96	2.13	41.09	56.00	-14.91

Unless otherwise stated the results shown in this test report refer only to the sample(s) tested and such sample(s) are retained for 90 days only.

除非另有說明，此報告結果僅對測試之樣品負責，同時此樣品僅保留90天。本報告未經本公司書面許可，不可部份複製。

This document is issued by the Company subject to its General Conditions of Service printed overleaf, available on request or accessible at <http://www.sgs.com.tw/Terms-and-Conditions> and for electronic format documents, subject to Terms and Conditions for Electronic Documents at <http://www.sgs.com.tw/Terms-and-Conditions>. Attention is drawn to the limitation of liability, indemnification and jurisdiction issues defined therein. Any holder of this document is advised that information contained hereon reflects the Company's findings at the time of its intervention only and within the limits of Client's instructions, if any. The Company's sole responsibility is to its Client and this document does not exonerate parties to a transaction from exercising all their rights and obligations under the transaction documents. This document cannot be reproduced except in full, without prior written approval of the Company. Any unauthorized alteration, forgery or falsification of the content or appearance of this document is unlawful and offenders may be prosecuted to the fullest extent of the law.

8 EMISSION BANDWIDTH MEASUREMENT

8.1 Standard Applicable

There is no limit bandwidth for U-NII-1, U-NII-2-A and U-NII-2-C.
 The minimum of 6dB Bandwidth measurement is 0.5 MHz for U-NII-3

8.2 Test Setup

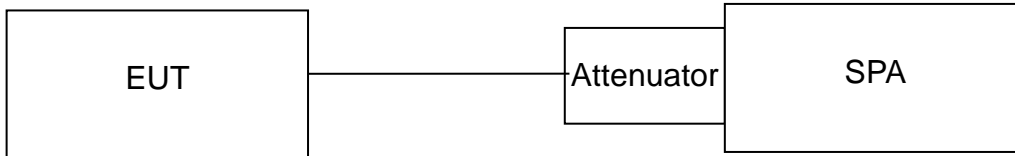

Unless otherwise stated the results shown in this test report refer only to the sample(s) tested and such sample(s) are retained for 90 days only.

除非另有說明，此報告結果僅對測試之樣品負責，同時此樣品僅保留90天。本報告未經本公司書面許可，不可部份複製。

This document is issued by the Company subject to its General Conditions of Service printed overleaf, available on request or accessible at <http://www.sgs.com.tw/Terms-and-Conditions> and for electronic format documents, subject to Terms and Conditions for Electronic Documents at <http://www.sgs.com.tw/Terms-and-Conditions>. Attention is drawn to the limitation of liability, indemnification and jurisdiction issues defined therein. Any holder of this document is advised that information contained hereon reflects the Company's findings at the time of its intervention only and within the limits of Client's instructions, if any. The Company's sole responsibility is to its Client and this document does not exonerate parties to a transaction from exercising all their rights and obligations under the transaction documents. This document cannot be reproduced except in full, without prior written approval of the Company. Any unauthorized alteration, forgery or falsification of the content or appearance of this document is unlawful and offenders may be prosecuted to the fullest extent of the law.

8.3 Measurement Procedure

1. Place the EUT on the table and set it in transmitting mode.
2. The testing follows FCC KDB 789033 D02 General UNII Test Procedures New Rules.
3. Remove the antenna from the EUT and then connect a low loss RF cable from the Antenna port to the spectrum analyzer.
 - 3.a. 26dB Band width Measurement: Set the spectrum analyzer as 1% of emission BW
Sweep=auto,
Detector = Peak,
Trace Mode = Max Hold,
Manually readjust RBW until the RBW/EBW ratio is 1% based on EBW as observed on the result of pre-sequence measurement.
 - 3.b. Mark the peak frequency and -26dB (upper and lower) frequency.
4. Repeat the procedures as list above until all test default channels (low, middle, and high) are completed.
5. Minimum Emission Bandwidth for the band 5.725-5.850GHz.
 - a. Set the spectrum analyzer as
RBW = 100 kHz,
VBW = 3*RBW,
Span = large enough to capture all products of the modulation process,
Detector=Peak,
Sweep=auto
 - b. Mark the peak frequency and -6dB (upper and lower) frequency.
6. For 99% Bandwidth: Set the spectrum analyzer as
RBW = 1%,
VBW = 3*RBW,
Span = large enough to capture all products of the modulation process,
Detector=Sample,
Sweep=auto.
7. Turn on the 99% bandwidth function, max reading.
8. Repeat above procedures until all frequency of interest measured was complete.

Unless otherwise stated the results shown in this test report refer only to the sample(s) tested and such sample(s) are retained for 90 days only.
除非另有說明，此報告結果僅對測試之樣品負責，同時此樣品僅保留90天。本報告未經本公司書面許可，不可部份複製。

This document is issued by the Company subject to its General Conditions of Service printed overleaf, available on request or accessible at <http://www.sgs.com.tw/Terms-and-Conditions> and for electronic format documents, subject to Terms and Conditions for Electronic Documents at <http://www.sgs.com.tw/Terms-and-Conditions>. Attention is drawn to the limitation of liability, indemnification and jurisdiction issues defined therein. Any holder of this document is advised that information contained hereon reflects the Company's findings at the time of its intervention only and within the limits of Client's instructions, if any. The Company's sole responsibility is to its Client and this document does not exonerate parties to a transaction from exercising all their rights and obligations under the transaction documents. This document cannot be reproduced except in full, without prior written approval of the Company. Any unauthorized alteration, forgery or falsification of the content or appearance of this document is unlawful and offenders may be prosecuted to the fullest extent of the law.

8.4 Measurement Result

8.4.1 FCC Occupied Bandwidth

802.11a_Ch0

Freq. (MHz)	26dB BW (MHz)	10 Log (B) (dB)
5180	19.50	12.900
5220	18.70	12.720
5240	18.86	12.760
5260	18.05	12.560
5300	18.83	12.750
5320	18.65	12.710

802.11a_Ch0

Freq. (MHz)	6dB BW (MHz)	10 Log (B) (dB)
5745	15.07	11.780
5785	14.49	11.610
5825	13.82	11.410

802.11a_Ch0

Freq. (MHz)	Measured Freq. (MHz)	Limit (MHz)
5240	5248.07	< 5250
5745	5736.83	> 5725

Unless otherwise stated the results shown in this test report refer only to the sample(s) tested and such sample(s) are retained for 90 days only.

除非另有說明，此報告結果僅對測試之樣品負責，同時此樣品僅保留90天。本報告未經本公司書面許可，不可部份複製。

This document is issued by the Company subject to its General Conditions of Service printed overleaf, available on request or accessible at <http://www.sgs.com.tw/Terms-and-Conditions> and for electronic format documents, subject to Terms and Conditions for Electronic Documents at <http://www.sgs.com.tw/Terms-and-Conditions>. Attention is drawn to the limitation of liability, indemnification and jurisdiction issues defined therein. Any holder of this document is advised that information contained hereon reflects the Company's findings at the time of its intervention only and within the limits of Client's instructions, if any. The Company's sole responsibility is to its Client and this document does not exonerate parties to a transaction from exercising all their rights and obligations under the transaction documents. This document cannot be reproduced except in full, without prior written approval of the Company. Any unauthorized alteration, forgery or falsification of the content or appearance of this document is unlawful and offenders may be prosecuted to the fullest extent of the law.

802.11a_Ch1

Freq. (MHz)	26dB BW (MHz)	10 Log (B) (dB)
5180	18.90	12.760
5220	18.73	12.730
5240	18.78	12.740
5260	18.73	12.730
5300	18.71	12.720
5320	18.63	12.700

802.11a_Ch1

Freq. (MHz)	6dB BW (MHz)	10 Log (B) (dB)
5745	15.05	11.780
5785	15.03	11.770
5825	15.12	11.800

802.11a_Ch1

Freq. (MHz)	Measured Freq. (MHz)	Limit (MHz)
5240	5248.08	< 5250
5745	5736.83	> 5725

Unless otherwise stated the results shown in this test report refer only to the sample(s) tested and such sample(s) are retained for 90 days only.

除非另有說明，此報告結果僅對測試之樣品負責，同時此樣品僅保留90天。本報告未經本公司書面許可，不可部份複製。

This document is issued by the Company subject to its General Conditions of Service printed overleaf, available on request or accessible at <http://www.sgs.com.tw/Terms-and-Conditions> and for electronic format documents, subject to Terms and Conditions for Electronic Documents at <http://www.sgs.com.tw/Terms-and-Conditions>. Attention is drawn to the limitation of liability, indemnification and jurisdiction issues defined therein. Any holder of this document is advised that information contained hereon reflects the Company's findings at the time of its intervention only and within the limits of Client's instructions, if any. The Company's sole responsibility is to its Client and this document does not exonerate parties to a transaction from exercising all their rights and obligations under the transaction documents. This document cannot be reproduced except in full, without prior written approval of the Company. Any unauthorized alteration, forgery or falsification of the content or appearance of this document is unlawful and offenders may be prosecuted to the fullest extent of the law.

802.11n_HT20_Ch0

Freq. (MHz)	26dB BW (MHz)	10 Log (B) (dB)
5180	19.42	12.880
5220	19.47	12.890
5240	19.34	12.860
5260	19.60	12.920
5300	19.54	12.910
5320	19.39	12.880

802.11n_HT20_Ch0

Freq. (MHz)	6dB BW (MHz)	10 Log (B) (dB)
5745	13.47	11.290
5785	14.22	11.530
5825	15.31	11.850

802.11n_HT20_Ch0

Freq. (MHz)	Measured Freq. (MHz)	Limit (MHz)
5240	5248.66	< 5250
5745	5736.26	> 5725

Unless otherwise stated the results shown in this test report refer only to the sample(s) tested and such sample(s) are retained for 90 days only.

除非另有說明，此報告結果僅對測試之樣品負責，同時此樣品僅保留90天。本報告未經本公司書面許可，不可部份複製。

This document is issued by the Company subject to its General Conditions of Service printed overleaf, available on request or accessible at <http://www.sgs.com.tw/Terms-and-Conditions> and for electronic format documents, subject to Terms and Conditions for Electronic Documents at <http://www.sgs.com.tw/Terms-and-Conditions>. Attention is drawn to the limitation of liability, indemnification and jurisdiction issues defined therein. Any holder of this document is advised that information contained hereon reflects the Company's findings at the time of its intervention only and within the limits of Client's instructions, if any. The Company's sole responsibility is to its Client and this document does not exonerate parties to a transaction from exercising all their rights and obligations under the transaction documents. This document cannot be reproduced except in full, without prior written approval of the Company. Any unauthorized alteration, forgery or falsification of the content or appearance of this document is unlawful and offenders may be prosecuted to the fullest extent of the law.

802.11n_HT20_Ch1

Freq. (MHz)	26dB BW (MHz)	10 Log (B) (dB)
5180	19.45	12.890
5220	19.34	12.860
5240	19.37	12.870
5260	19.37	12.870
5300	19.30	12.860
5320	19.52	12.900

802.11n_HT20_Ch1

Freq. (MHz)	6dB BW (MHz)	10 Log (B) (dB)
5745	14.48	11.610
5785	13.81	11.400
5825	15.67	11.950

802.11n_HT20_Ch1

Freq. (MHz)	Measured Freq. (MHz)	Limit (MHz)
5240	5248.67	< 5250
5745	5736.24	> 5725

Unless otherwise stated the results shown in this test report refer only to the sample(s) tested and such sample(s) are retained for 90 days only.

除非另有說明，此報告結果僅對測試之樣品負責，同時此樣品僅保留90天。本報告未經本公司書面許可，不可部份複製。

This document is issued by the Company subject to its General Conditions of Service printed overleaf, available on request or accessible at <http://www.sgs.com.tw/Terms-and-Conditions> and for electronic format documents, subject to Terms and Conditions for Electronic Documents at <http://www.sgs.com.tw/Terms-and-Conditions>. Attention is drawn to the limitation of liability, indemnification and jurisdiction issues defined therein. Any holder of this document is advised that information contained hereon reflects the Company's findings at the time of its intervention only and within the limits of Client's instructions, if any. The Company's sole responsibility is to its Client and this document does not exonerate parties to a transaction from exercising all their rights and obligations under the transaction documents. This document cannot be reproduced except in full, without prior written approval of the Company. Any unauthorized alteration, forgery or falsification of the content or appearance of this document is unlawful and offenders may be prosecuted to the fullest extent of the law.

802.11n_HT40_Ch0

Freq. (MHz)	26dB BW (MHz)	10 Log (B) (dB)
5190	39.96	16.020
5230	39.42	15.960
5270	39.92	16.010
5310	39.05	15.920

802.11n_HT40_Ch0

Freq. (MHz)	6dB BW (MHz)	10 Log (B) (dB)
5755	33.86	15.300
5795	33.89	15.300

802.11n_HT40_Ch0

Freq. (MHz)	Measured Freq. (MHz)	Limit (MHz)
5230	5247.76	< 5250
5755	5737.12	> 5725

Unless otherwise stated the results shown in this test report refer only to the sample(s) tested and such sample(s) are retained for 90 days only.

除非另有說明，此報告結果僅對測試之樣品負責，同時此樣品僅保留90天。本報告未經本公司書面許可，不可部份複製。

This document is issued by the Company subject to its General Conditions of Service printed overleaf, available on request or accessible at <http://www.sgs.com.tw/Terms-and-Conditions> and for electronic format documents, subject to Terms and Conditions for Electronic Documents at <http://www.sgs.com.tw/Terms-and-Conditions>. Attention is drawn to the limitation of liability, indemnification and jurisdiction issues defined therein. Any holder of this document is advised that information contained hereon reflects the Company's findings at the time of its intervention only and within the limits of Client's instructions, if any. The Company's sole responsibility is to its Client and this document does not exonerate parties to a transaction from exercising all their rights and obligations under the transaction documents. This document cannot be reproduced except in full, without prior written approval of the Company. Any unauthorized alteration, forgery or falsification of the content or appearance of this document is unlawful and offenders may be prosecuted to the fullest extent of the law.

802.11n_HT40_Ch1

Freq. (MHz)	26dB BW (MHz)	10 Log (B) (dB)
5190	39.20	15.930
5230	38.82	15.890
5270	39.37	15.950
5310	39.32	15.950

802.11n_HT40_Ch1

Freq. (MHz)	6dB BW (MHz)	10 Log (B) (dB)
5755	35.10	15.450
5795	33.92	15.300

802.11n_HT40_Ch1

Freq. (MHz)	Measured Freq. (MHz)	Limit (MHz)
5230	5247.78	< 5250
5755	5737.09	> 5725

Unless otherwise stated the results shown in this test report refer only to the sample(s) tested and such sample(s) are retained for 90 days only.

除非另有說明，此報告結果僅對測試之樣品負責，同時此樣品僅保留90天。本報告未經本公司書面許可，不可部份複製。

This document is issued by the Company subject to its General Conditions of Service printed overleaf, available on request or accessible at <http://www.sgs.com.tw/Terms-and-Conditions> and for electronic format documents, subject to Terms and Conditions for Electronic Documents at <http://www.sgs.com.tw/Terms-and-Conditions>. Attention is drawn to the limitation of liability, indemnification and jurisdiction issues defined therein. Any holder of this document is advised that information contained hereon reflects the Company's findings at the time of its intervention only and within the limits of Client's instructions, if any. The Company's sole responsibility is to its Client and this document does not exonerate parties to a transaction from exercising all their rights and obligations under the transaction documents. This document cannot be reproduced except in full, without prior written approval of the Company. Any unauthorized alteration, forgery or falsification of the content or appearance of this document is unlawful and offenders may be prosecuted to the fullest extent of the law.

802.11ac_VHT80_Ch0

Freq. (MHz)	26dB BW (MHz)	10 Log (B) (dB)
5210	81.88	19.130
5290	82.14	19.150

802.11ac_VHT80_Ch0

Freq. (MHz)	6dB BW (MHz)	10 Log (B) (dB)
5775	75.17	18.760

802.11ac_VHT80_Ch0

Freq. (MHz)	Measured Freq. (MHz)	Limit (MHz)
5210	5247.24	< 5250
5775	5737.47	> 5725

802.11ac_VHT80_Ch1

Freq. (MHz)	26dB BW (MHz)	10 Log (B) (dB)
5210	80.55	19.060
5290	80.88	19.080

802.11ac_VHT80_Ch1

Freq. (MHz)	6dB BW (MHz)	10 Log (B) (dB)
5775	75.15	18.760

802.11ac_VHT80_Ch1

Freq. (MHz)	Measured Freq. (MHz)	Limit (MHz)
5210	5247.13	< 5250
5775	5737.46	> 5725

Unless otherwise stated the results shown in this test report refer only to the sample(s) tested and such sample(s) are retained for 90 days only.

除非另有說明，此報告結果僅對測試之樣品負責，同時此樣品僅保留90天。本報告未經本公司書面許可，不可部份複製。

This document is issued by the Company subject to its General Conditions of Service printed overleaf, available on request or accessible at <http://www.sgs.com.tw/Terms-and-Conditions> and for electronic format documents, subject to Terms and Conditions for Electronic Documents at <http://www.sgs.com.tw/Terms-and-Conditions>. Attention is drawn to the limitation of liability, indemnification and jurisdiction issues defined therein. Any holder of this document is advised that information contained hereon reflects the Company's findings at the time of its intervention only and within the limits of Client's instructions, if any. The Company's sole responsibility is to its Client and this document does not exonerate parties to a transaction from exercising all their rights and obligations under the transaction documents. This document cannot be reproduced except in full, without prior written approval of the Company. Any unauthorized alteration, forgery or falsification of the content or appearance of this document is unlawful and offenders may be prosecuted to the fullest extent of the law.

802.11a_20MHz_Chain0_5180MHz

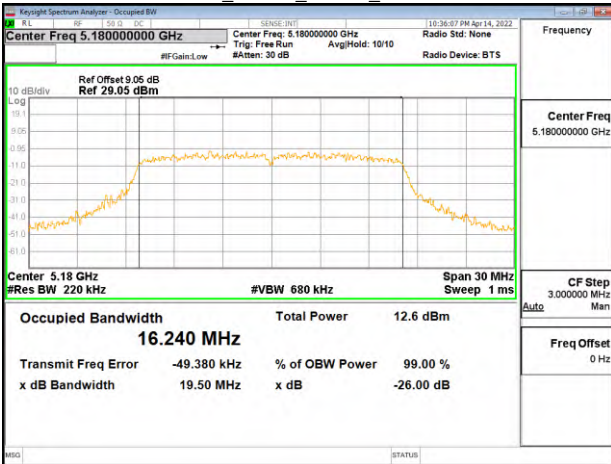

802.11a_20MHz_Chain0_5260MHz

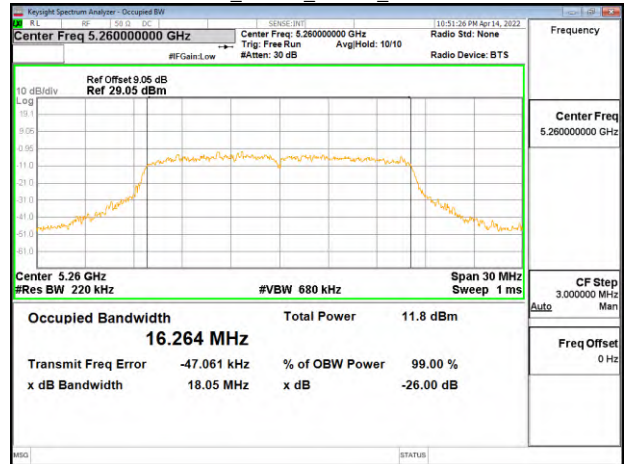

802.11a_20MHz_Chain0_5220MHz

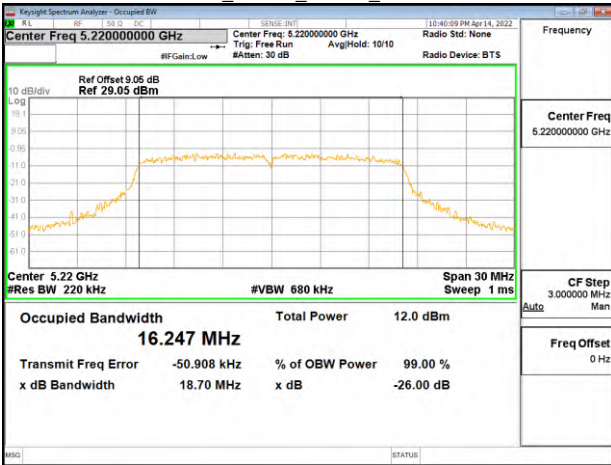

802.11a_20MHz_Chain0_5300MHz

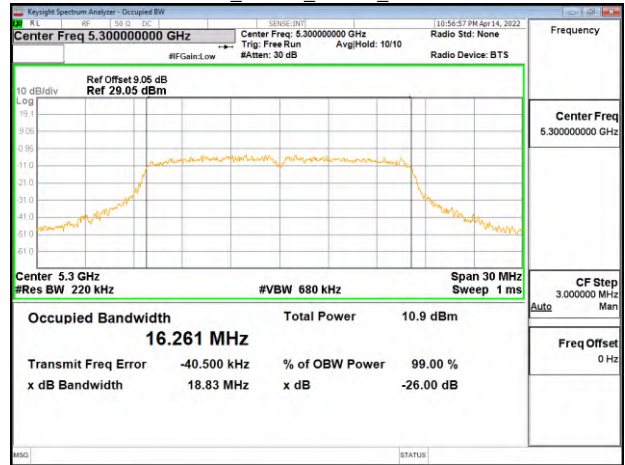

802.11a_20MHz_Chain0_5240MHz

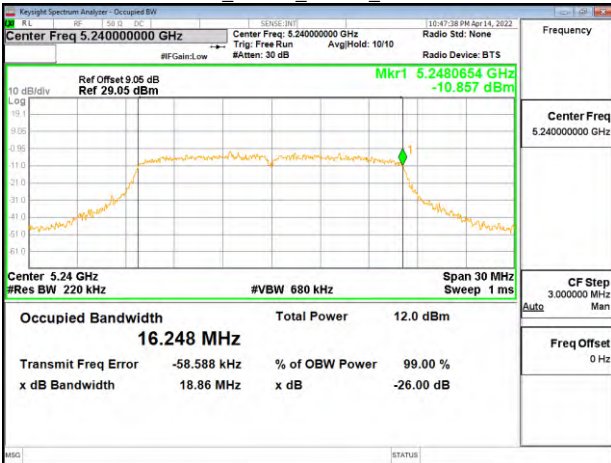

802.11a_20MHz_Chain0_5320MHz

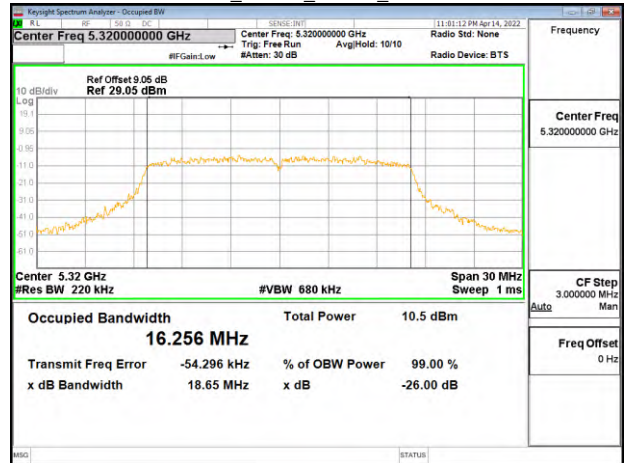

Unless otherwise stated the results shown in this test report refer only to the sample(s) tested and such sample(s) are retained for 90 days only.

除非另有說明，此報告結果僅對測試之樣品負責，同時此樣品僅保留90天。本報告未經本公司書面許可，不可部份複製。

This document is issued by the Company subject to its General Conditions of Service printed overleaf, available on request or accessible at <http://www.sgs.com.tw/Terms-and-Conditions> and for electronic format documents, subject to Terms and Conditions for Electronic Documents at <http://www.sgs.com.tw/Terms-and-Conditions>. Attention is drawn to the limitation of liability, indemnification and jurisdiction issues defined therein. Any holder of this document is advised that information contained hereon reflects the Company's findings at the time of its intervention only and within the limits of Client's instructions, if any. The Company's sole responsibility is to its Client and this document does not exonerate parties to a transaction from exercising all their rights and obligations under the transaction documents. This document cannot be reproduced except in full, without prior written approval of the Company. Any unauthorized alteration, forgery or falsification of the content or appearance of this document is unlawful and offenders may be prosecuted to the fullest extent of the law.

802.11a_20MHz_Chain0_5745MHz

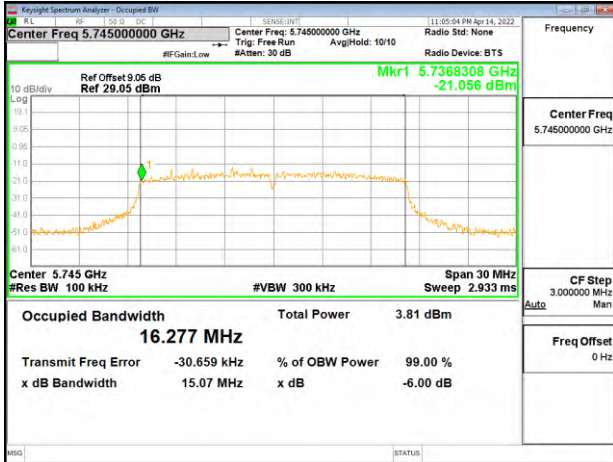

802.11a_20MHz_Chain1_5180MHz

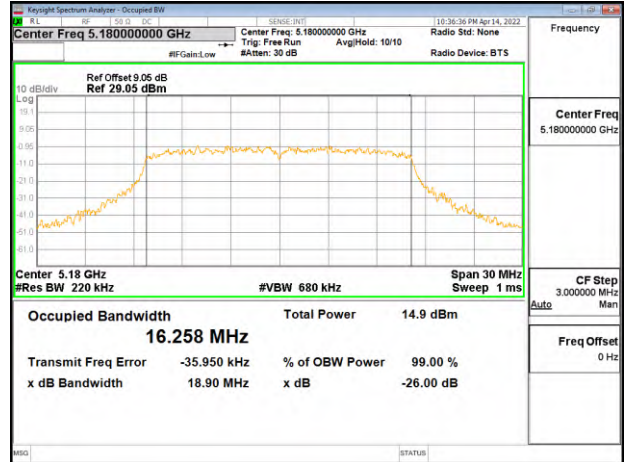

802.11a_20MHz_Chain0_5785MHz

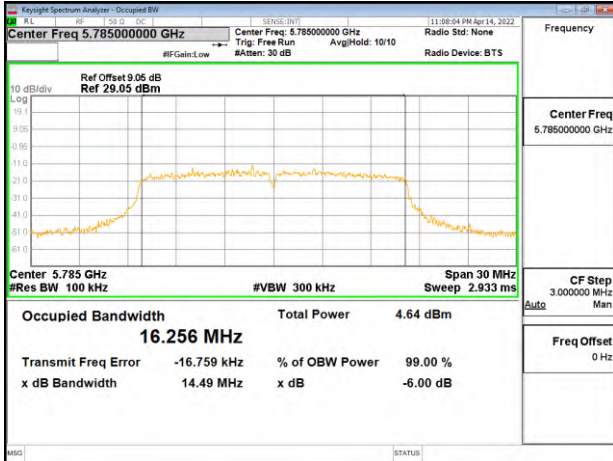

802.11a_20MHz_Chain1_5220MHz

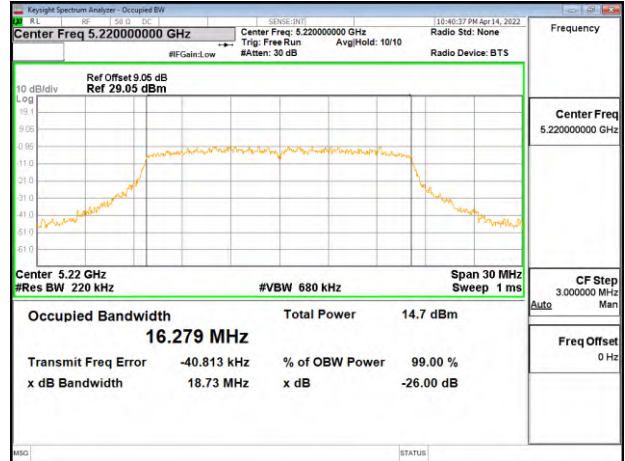

802.11a_20MHz_Chain0_5825MHz

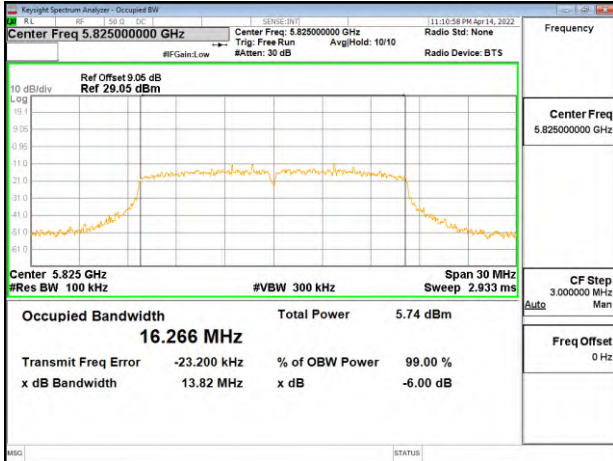

802.11a_20MHz_Chain1_5240MHz

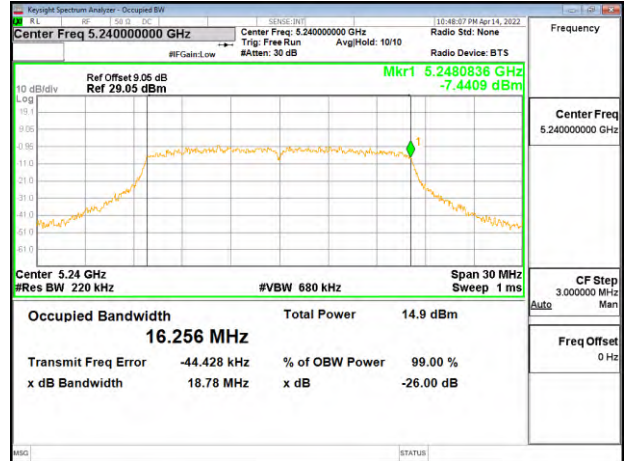

Unless otherwise stated the results shown in this test report refer only to the sample(s) tested and such sample(s) are retained for 90 days only.

除非另有說明，此報告結果僅對測試之樣品負責，同時此樣品僅保留90天。本報告未經本公司書面許可，不可部份複製。

This document is issued by the subject to its General Conditions of Service printed overleaf, available on request or accessible at <http://www.sgs.com.tw/Terms-and-Conditions> and for electronic format documents, subject to Terms and Conditions for Electronic Documents at <http://www.sgs.com.tw/Terms-and-Conditions>. Attention is drawn to the limitation of liability, indemnification and jurisdiction issues defined therein. Any holder of this document is advised that information contained herein reflects the Company's findings at the time of its intervention only and within the limits of Client's instructions, if any. The Company's sole responsibility is to its Client and this document does not exonerate parties to a transaction from exercising all their rights and obligations under the transaction documents. This document cannot be reproduced except in full, without prior written approval of the Company. Any unauthorized alteration, forgery or falsification of the content or appearance of this document is unlawful and offenders may be prosecuted to the fullest extent of the law.

802.11a_20MHz_Chain1_5260MHz

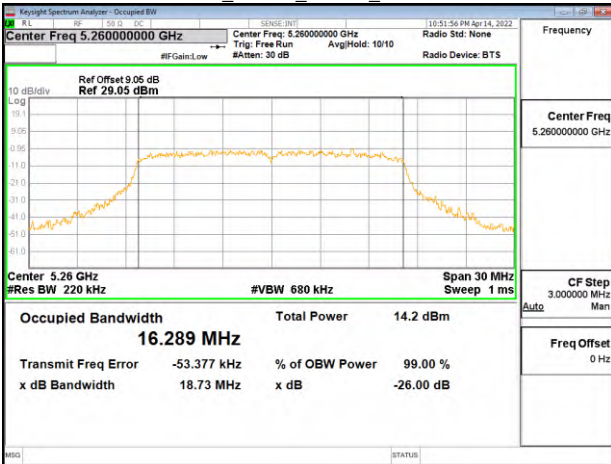

802.11a_20MHz_Chain1_5745MHz

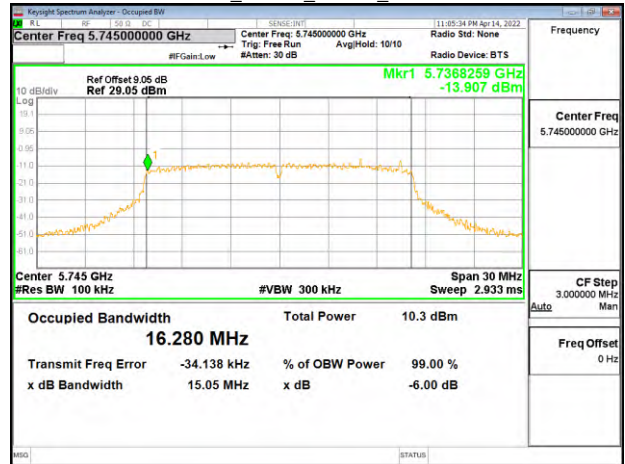

802.11a_20MHz_Chain1_5300MHz

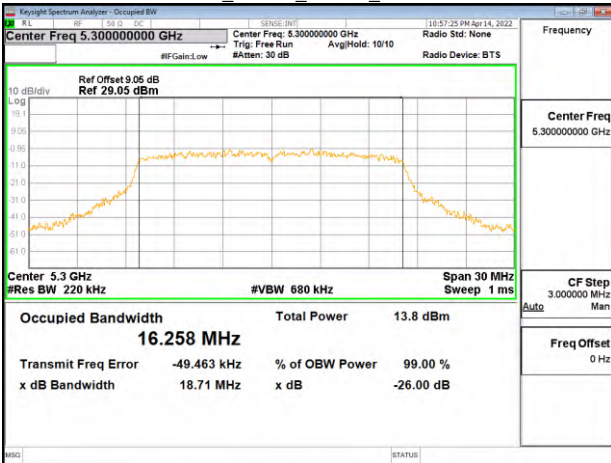

802.11a_20MHz_Chain1_5785MHz

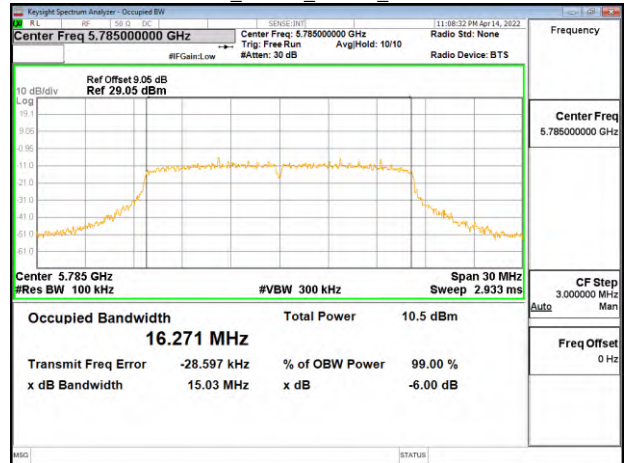

802.11a_20MHz_Chain1_5320MHz

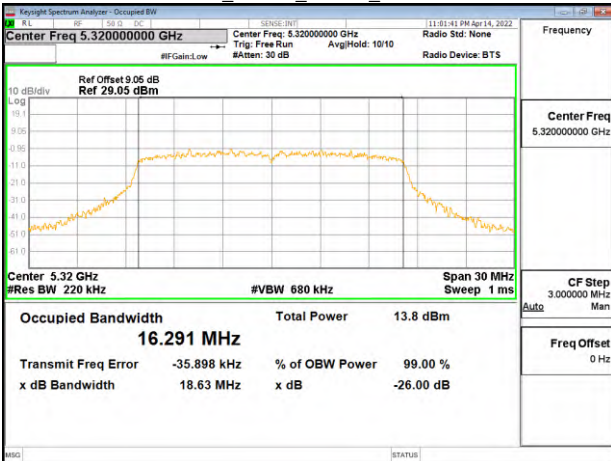

802.11a_20MHz_Chain1_5825MHz

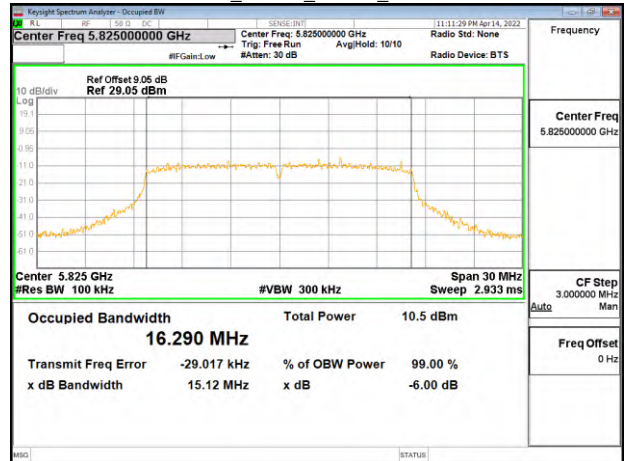

Unless otherwise stated the results shown in this test report refer only to the sample(s) tested and such sample(s) are retained for 90 days only.

除非另有說明，此報告結果僅對測試之樣品負責，同時此樣品僅保留90天。本報告未經本公司書面許可，不可部份複製。

This document is issued by the Company subject to its General Conditions of Service printed overleaf, available on request or accessible at <http://www.sgs.com.tw/Terms-and-Conditions> and for electronic format documents, subject to Terms and Conditions for Electronic Documents at <http://www.sgs.com.tw/Terms-and-Conditions>. Attention is drawn to the limitation of liability, indemnification and jurisdiction issues defined therein. Any holder of this document is advised that information contained hereon reflects the Company's findings at the time of its intervention only and within the limits of Client's instructions, if any. The Company's sole responsibility is to its Client and this document does not exonerate parties to a transaction from exercising all their rights and obligations under the transaction documents. This document cannot be reproduced except in full, without prior written approval of the Company. Any unauthorized alteration, forgery or falsification of the content or appearance of this document is unlawful and offenders may be prosecuted to the fullest extent of the law.

802.11n_20MHz_Chain0_5180MHz

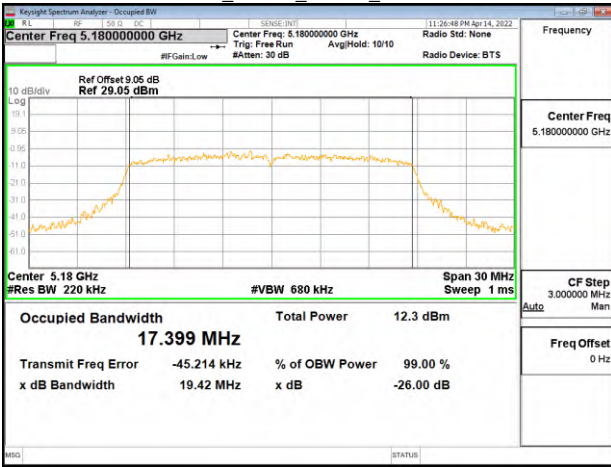

802.11n_20MHz_Chain0_5260MHz

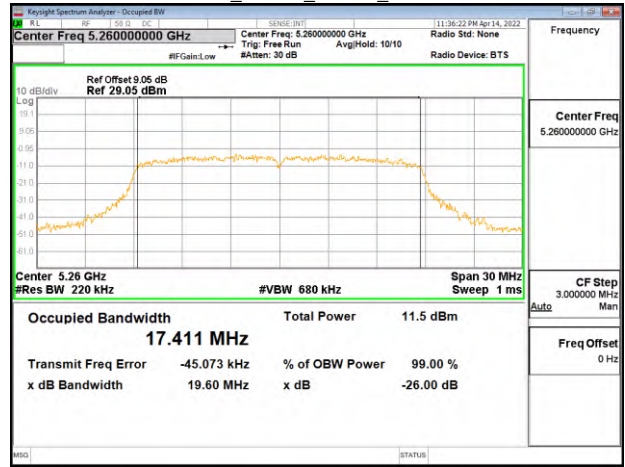

802.11n_20MHz_Chain0_5220MHz

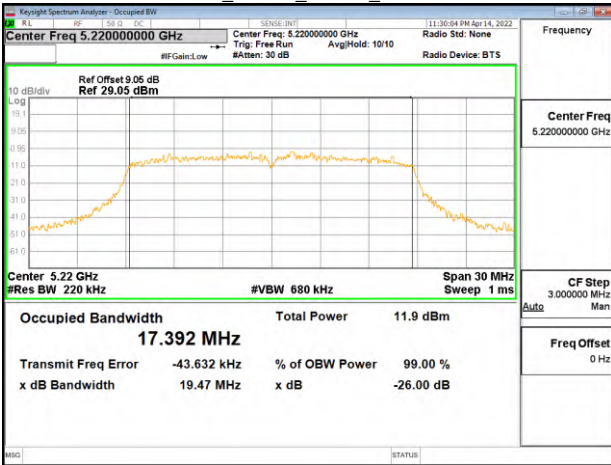

802.11n_20MHz_Chain0_5300MHz

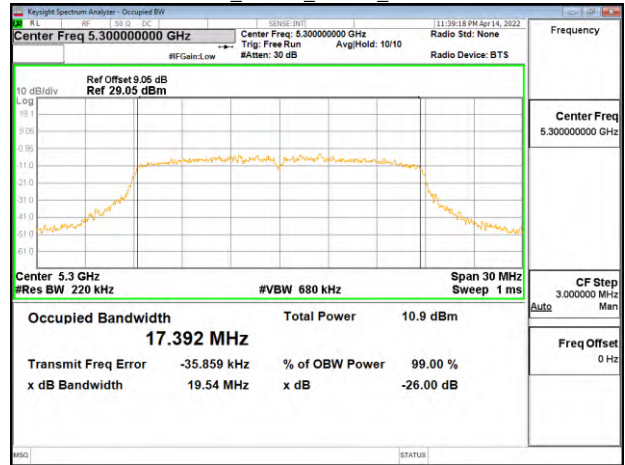

802.11n_20MHz_Chain0_5240MHz

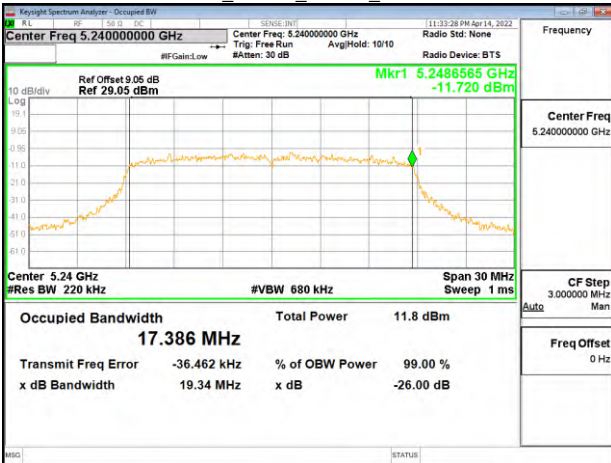

802.11n_20MHz_Chain0_5320MHz

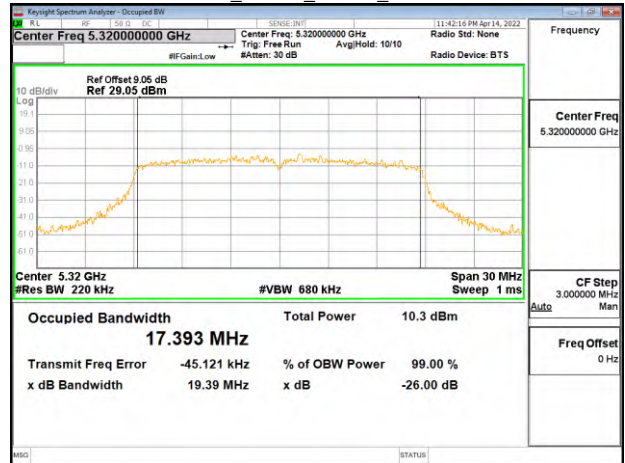

Unless otherwise stated the results shown in this test report refer only to the sample(s) tested and such sample(s) are retained for 90 days only.

除非另有說明，此報告結果僅對測試之樣品負責，同時此樣品僅保留90天。本報告未經本公司書面許可，不可部份複製。

This document is issued by the Company subject to its General Conditions of Service printed overleaf, available on request or accessible at <http://www.sgs.com.tw/Terms-and-Conditions> and for electronic format documents, subject to Terms and Conditions for Electronic Documents at <http://www.sgs.com.tw/Terms-and-Conditions>. Attention is drawn to the limitation of liability, indemnification and jurisdiction issues defined therein. Any holder of this document is advised that information contained hereon reflects the Company's findings at the time of its intervention only and within the limits of Client's instructions, if any. The Company's sole responsibility is to its Client and this document does not exonerate parties to a transaction from exercising all their rights and obligations under the transaction documents. This document cannot be reproduced except in full, without prior written approval of the Company. Any unauthorized alteration, forgery or falsification of the content or appearance of this document is unlawful and offenders may be prosecuted to the fullest extent of the law.

802.11n_20MHz_Chain0_5745MHz

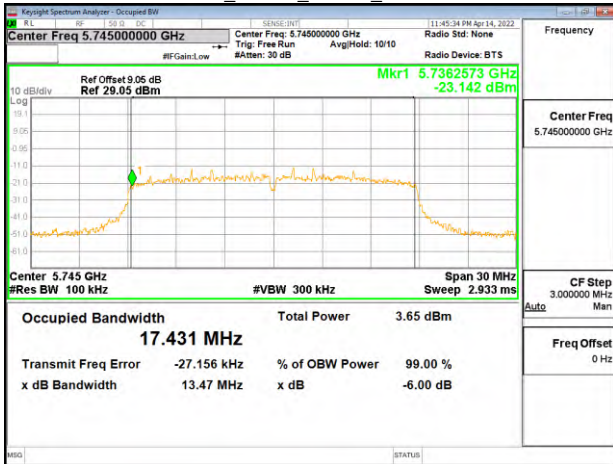

802.11n_20MHz_Chain1_5180MHz

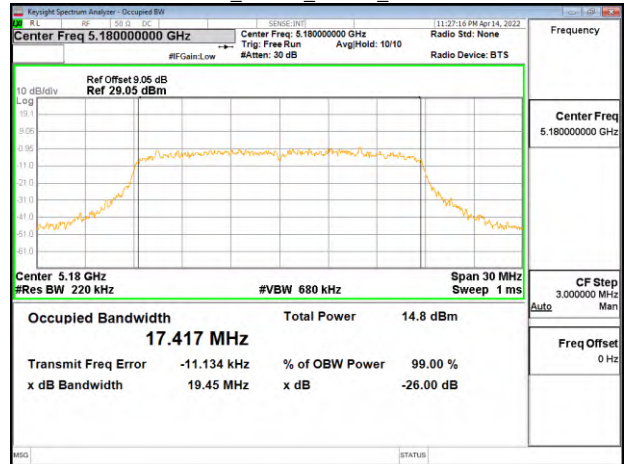

802.11n_20MHz_Chain0_5785MHz

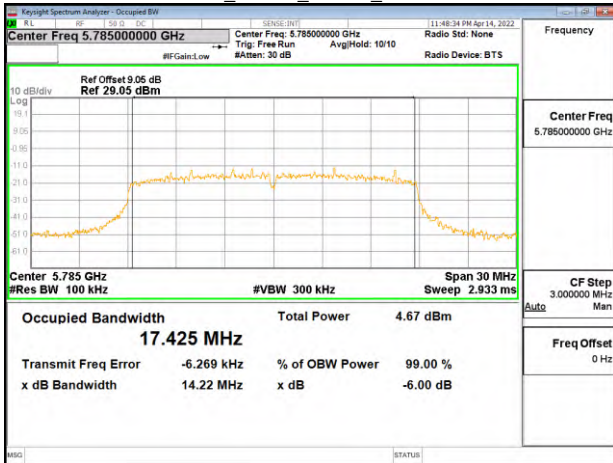

802.11n_20MHz_Chain1_5220MHz

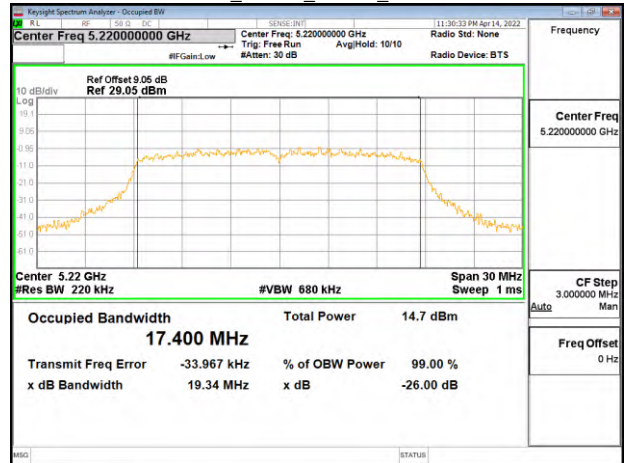

802.11n_20MHz_Chain0_5825MHz

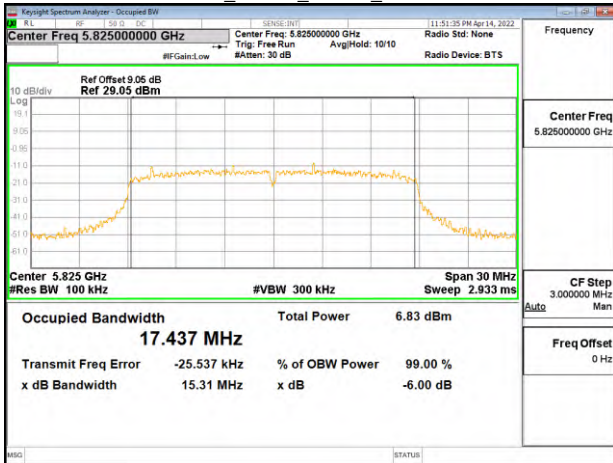

802.11n_20MHz_Chain1_5240MHz

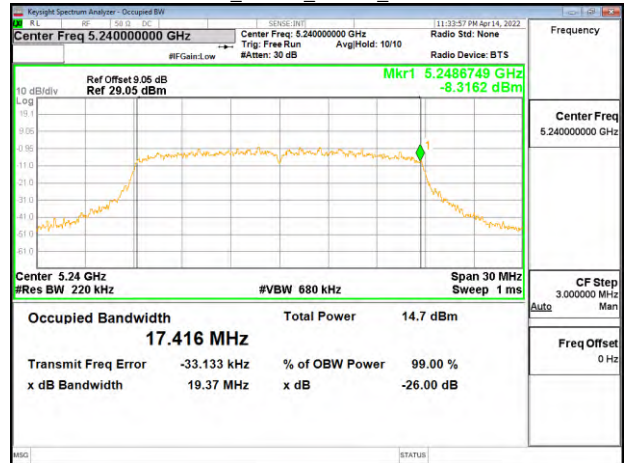

Unless otherwise stated the results shown in this test report refer only to the sample(s) tested and such sample(s) are retained for 90 days only.

除非另有說明，此報告結果僅對測試之樣品負責，同時此樣品僅保留90天。本報告未經本公司書面許可，不可部份複製。

This document is issued by the Company subject to its General Conditions of Service printed overleaf, available on request or accessible at <http://www.sgs.com.tw/Terms-and-Conditions> and for electronic format documents, subject to Terms and Conditions for Electronic Documents at <http://www.sgs.com.tw/Terms-and-Conditions>. Attention is drawn to the limitation of liability, indemnification and jurisdiction issues defined therein. Any holder of this document is advised that information contained herein reflects the Company's findings at the time of its intervention only and within the limits of Client's instructions, if any. The Company's sole responsibility is to its Client and this document does not exonerate parties to a transaction from exercising all their rights and obligations under the transaction documents. This document cannot be reproduced except in full, without prior written approval of the Company. Any unauthorized alteration, forgery or falsification of the content or appearance of this document is unlawful and offenders may be prosecuted to the fullest extent of the law.

802.11n_20MHz_Chain1_5260MHz

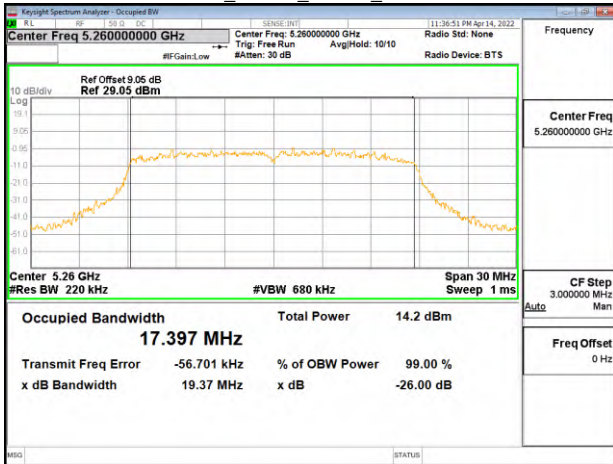

802.11n_20MHz_Chain1_5745MHz

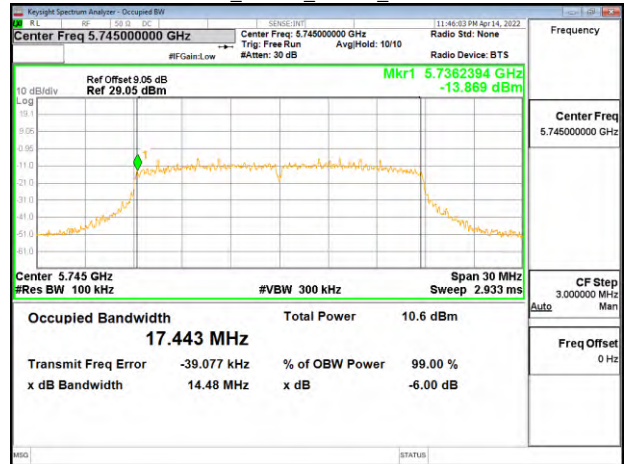

802.11n_20MHz_Chain1_5300MHz

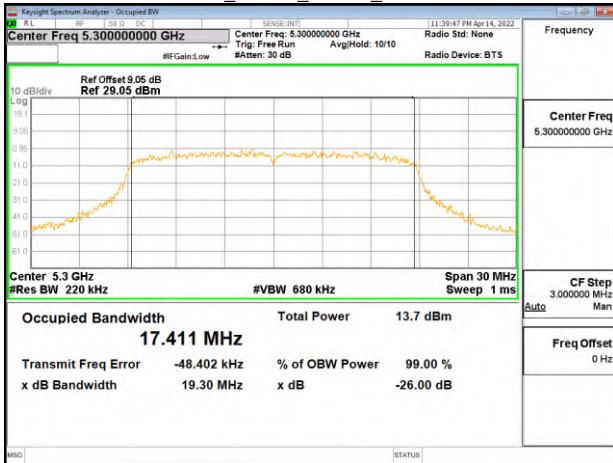

802.11n_20MHz_Chain1_5785MHz

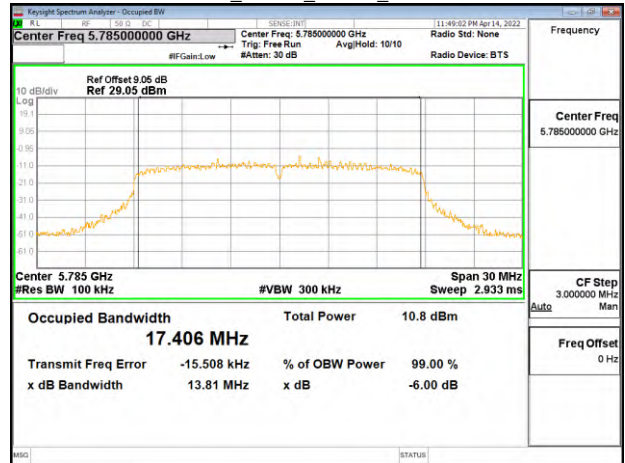

802.11n_20MHz_Chain1_5320MHz

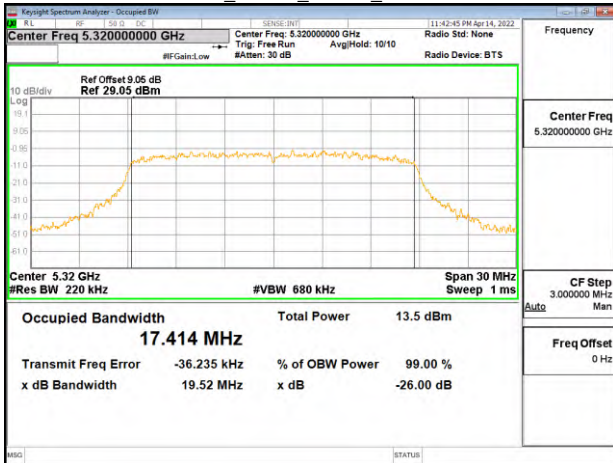

802.11n_20MHz_Chain1_5825MHz

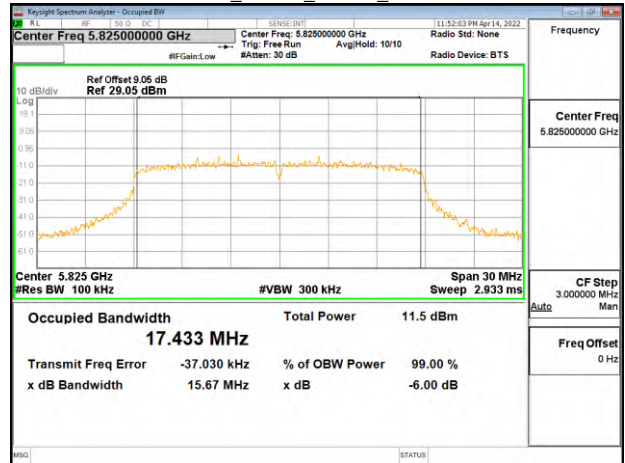

Unless otherwise stated the results shown in this test report refer only to the sample(s) tested and such sample(s) are retained for 90 days only.

除非另有說明，此報告結果僅對測試之樣品負責，同時此樣品僅保留90天。本報告未經本公司書面許可，不可部份複製。

This document is issued by the Company subject to its General Conditions of Service printed overleaf, available on request or accessible at <http://www.sgs.com.tw/Terms-and-Conditions> and for electronic format documents, subject to Terms and Conditions for Electronic Documents at <http://www.sgs.com.tw/Terms-and-Conditions>. Attention is drawn to the limitation of liability, indemnification and jurisdiction issues defined therein. Any holder of this document is advised that information contained hereon reflects the Company's findings at the time of its intervention only and within the limits of Client's instructions, if any. The Company's sole responsibility is to its Client and this document does not exonerate parties to a transaction from exercising all their rights and obligations under the transaction documents. This document cannot be reproduced except in full, without prior written approval of the Company. Any unauthorized alteration, forgery or falsification of the content or appearance of this document is unlawful and offenders may be prosecuted to the fullest extent of the law.

802.11n_40MHz_Chain0_5190MHz

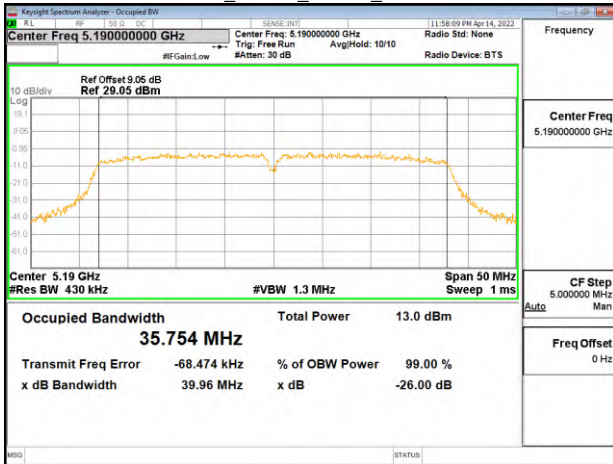

802.11n_40MHz_Chain0_5310MHz

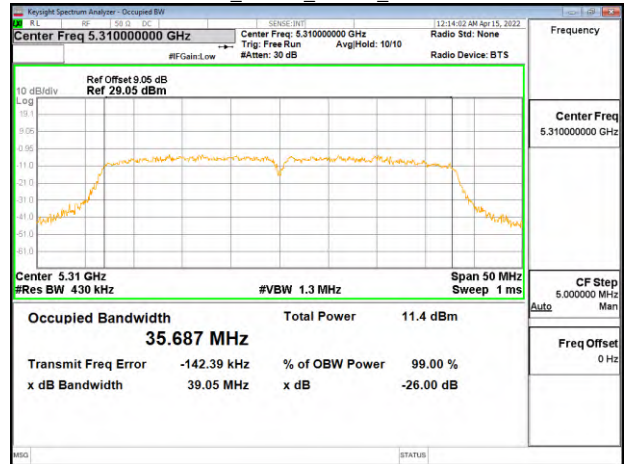

802.11n_40MHz_Chain0_5230MHz

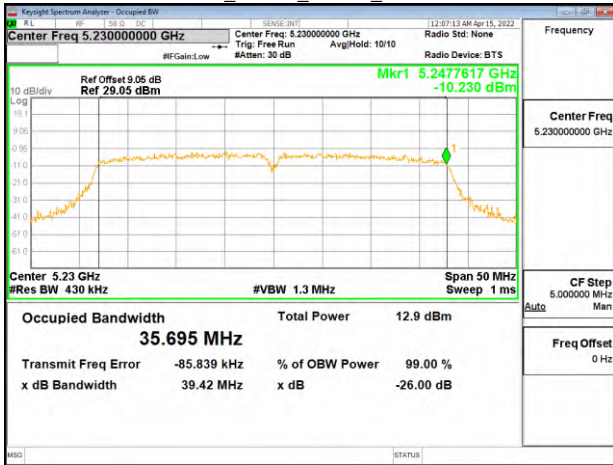

802.11n_40MHz_Chain0_5755MHz

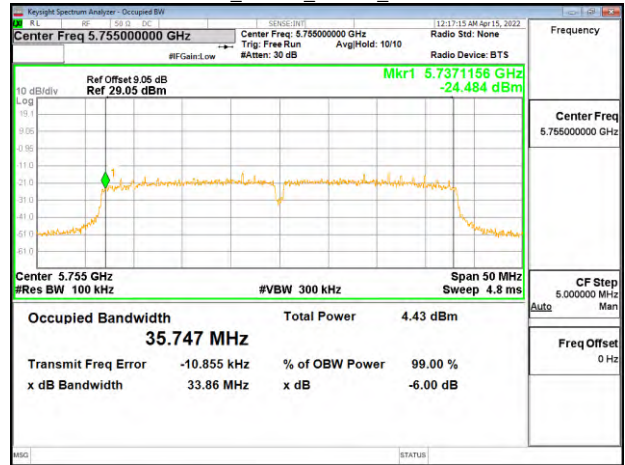

802.11n_40MHz_Chain0_5270MHz

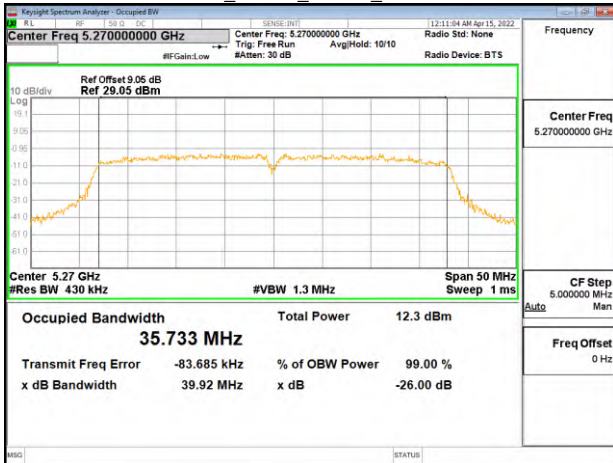

802.11n_40MHz_Chain0_5795MHz

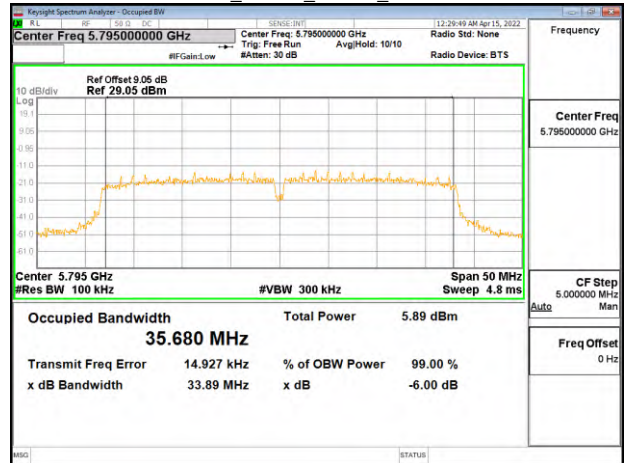

Unless otherwise stated the results shown in this test report refer only to the sample(s) tested and such sample(s) are retained for 90 days only.

除非另有說明，此報告結果僅對測試之樣品負責，同時此樣品僅保留90天。本報告未經本公司書面許可，不可部份複製。

This document is issued by the Company subject to its General Conditions of Service printed overleaf, available on request or accessible at <http://www.sgs.com.tw/Terms-and-Conditions> and for electronic format documents, subject to Terms and Conditions for Electronic Documents at <http://www.sgs.com.tw/Terms-and-Conditions>. Attention is drawn to the limitation of liability, indemnification and jurisdiction issues defined therein. Any holder of this document is advised that information contained hereon reflects the Company's findings at the time of its intervention only and within the limits of Client's instructions, if any. The Company's sole responsibility is to its Client and this document does not exonerate parties to a transaction from exercising all their rights and obligations under the transaction documents. This document cannot be reproduced except in full, without prior written approval of the Company. Any unauthorized alteration, forgery or falsification of the content or appearance of this document is unlawful and offenders may be prosecuted to the fullest extent of the law.

802.11n_40MHz_Chain1_5190MHz

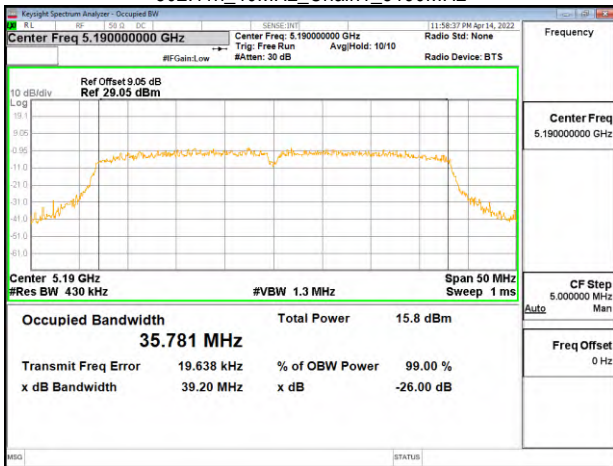

802.11n_40MHz_Chain1_5310MHz

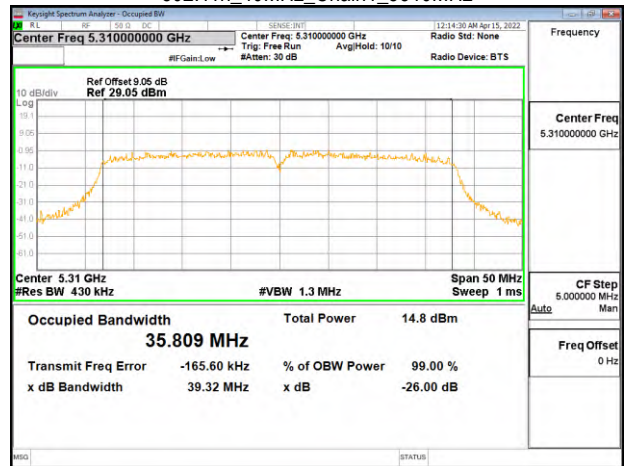

802.11n_40MHz_Chain1_5230MHz

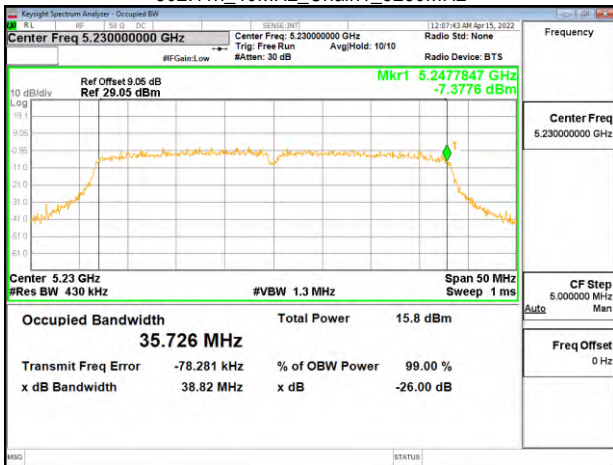

802.11n_40MHz_Chain1_5755MHz

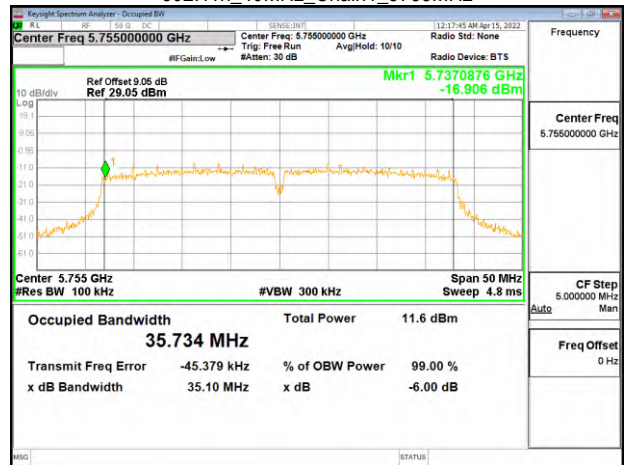

802.11n_40MHz_Chain1_5270MHz

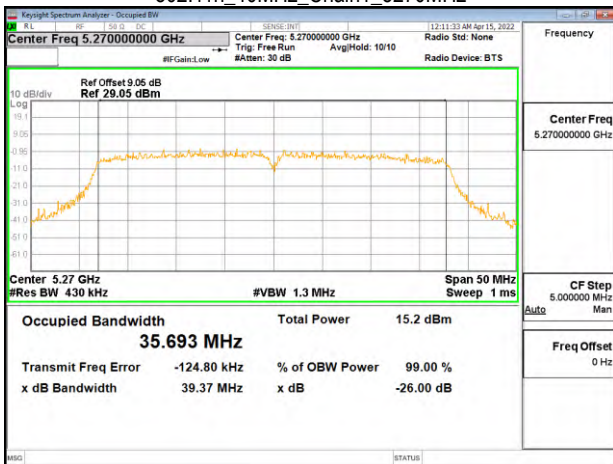

802.11n_40MHz_Chain1_5795MHz

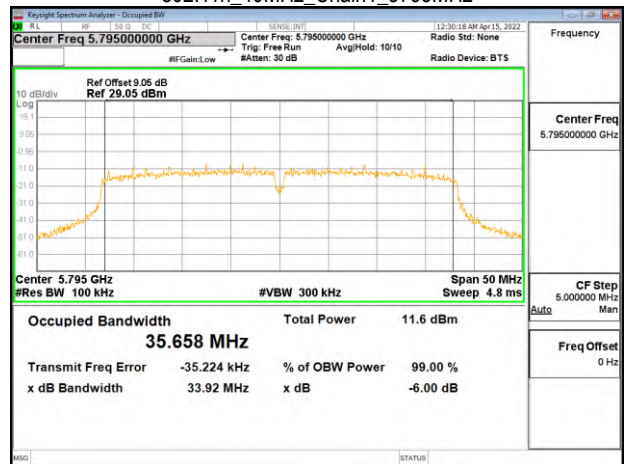

Unless otherwise stated the results shown in this test report refer only to the sample(s) tested and such sample(s) are retained for 90 days only.

除非另有說明，此報告結果僅對測試之樣品負責，同時此樣品僅保留90天。本報告未經本公司書面許可，不可部份複製。

This document is issued by the Company subject to its General Conditions of Service printed overleaf, available on request or accessible at <http://www.sgs.com.tw/Terms-and-Conditions> and for electronic format documents, subject to Terms and Conditions for Electronic Documents at <http://www.sgs.com.tw/Terms-and-Conditions>. Attention is drawn to the limitation of liability, indemnification and jurisdiction issues defined therein. Any holder of this document is advised that information contained hereon reflects the Company's findings at the time of its intervention only and within the limits of Client's instructions, if any. The Company's sole responsibility is to its Client and this document does not exonerate parties to a transaction from exercising all their rights and obligations under the transaction documents. This document cannot be reproduced except in full, without prior written approval of the Company. Any unauthorized alteration, forgery or falsification of the content or appearance of this document is unlawful and offenders may be prosecuted to the fullest extent of the law.

802.11ac_80MHz_Chain0_5210MHz

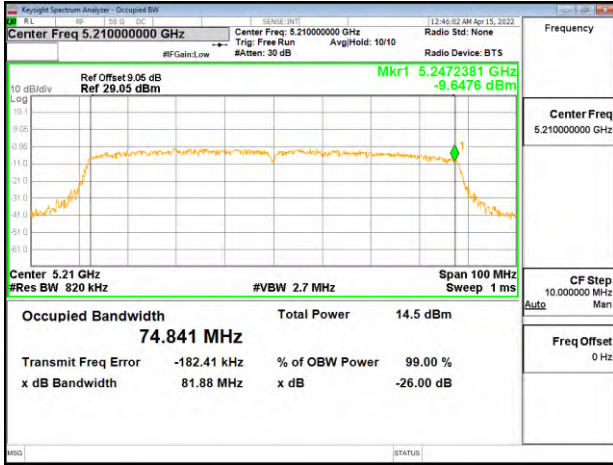

802.11ac_80MHz_Chain1_5210MHz

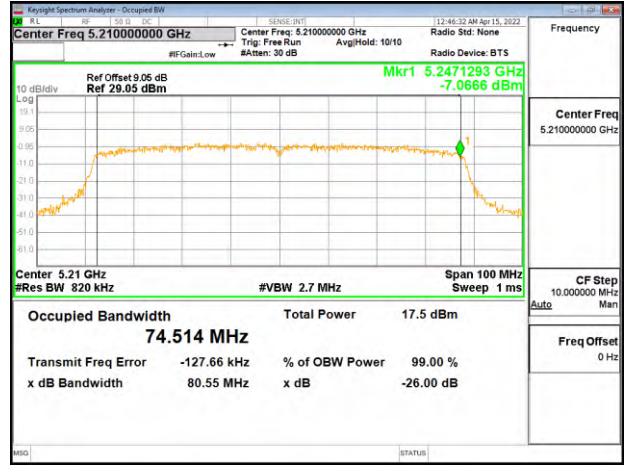

802.11ac_80MHz_Chain0_5290MHz

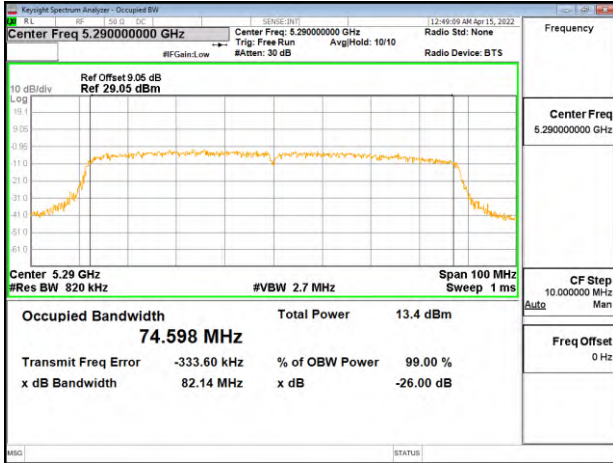

802.11ac_80MHz_Chain1_5290MHz

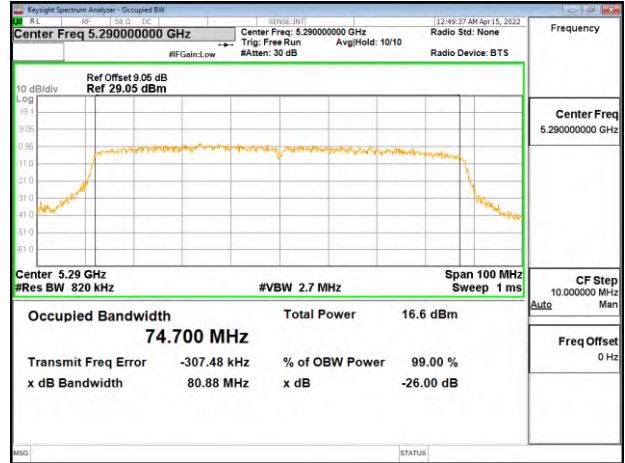

802.11ac_80MHz_Chain0_5775MHz

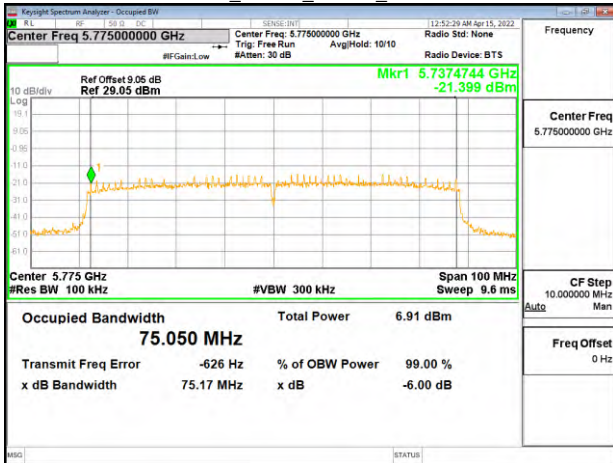

802.11ac_80MHz_Chain1_5775MHz

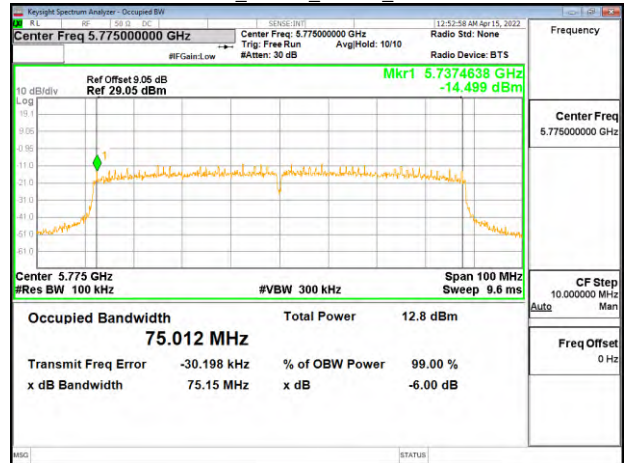

Unless otherwise stated the results shown in this test report refer only to the sample(s) tested and such sample(s) are retained for 90 days only.

除非另有說明，此報告結果僅對測試之樣品負責，同時此樣品僅保留90天。本報告未經本公司書面許可，不可部份複製。

This document is issued by the Company subject to its General Conditions of Service printed overleaf, available on request or accessible at <http://www.sgs.com.tw/Terms-and-Conditions> and for electronic format documents, subject to Terms and Conditions for Electronic Documents at <http://www.sgs.com.tw/Terms-and-Conditions>. Attention is drawn to the limitation of liability, indemnification and jurisdiction issues defined therein. Any holder of this document is advised that information contained hereon reflects the Company's findings at the time of its intervention only and within the limits of Client's instructions, if any. The Company's sole responsibility is to its Client and this document does not exonerate parties to a transaction from exercising all their rights and obligations under the transaction documents. This document cannot be reproduced except in full, without prior written approval of the Company. Any unauthorized alteration, forgery or falsification of the content or appearance of this document is unlawful and offenders may be prosecuted to the fullest extent of the law.

8.4.2 ISED Occupied Bandwidth

802.11a_Ch0

Frequency (MHz)	99% BW (MHz)	10 Log (B) (dB)
5180	16.259	12.110
5220	16.262	12.110
5240	16.240	12.110
5260	16.256	12.110
5300	16.247	12.110
5320	16.261	12.110

802.11a_Ch0

Frequency (MHz)	99% BW (MHz)	6dB BW (MHz)
5745	16.243	15.960
5785	16.252	15.450
5825	16.256	15.880

802.11a_Ch1

Frequency (MHz)	99% BW (MHz)	10 Log (B) (dB)
5180	16.273	12.110
5220	16.264	12.110
5240	16.279	12.120
5260	16.269	12.110
5300	16.264	12.110
5320	16.261	12.110

802.11a_Ch1

Frequency (MHz)	99% BW (MHz)	6dB BW (MHz)
5745	16.276	15.520
5785	16.269	16.080
5825	16.273	16.100

Unless otherwise stated the results shown in this test report refer only to the sample(s) tested and such sample(s) are retained for 90 days only.

除非另有說明，此報告結果僅對測試之樣品負責，同時此樣品僅保留90天。本報告未經本公司書面許可，不可部份複製。

This document is issued by the Company subject to its General Conditions of Service printed overleaf, available on request or accessible at <http://www.sgs.com.tw/Terms-and-Conditions> and for electronic format documents, subject to Terms and Conditions for Electronic Documents at <http://www.sgs.com.tw/Terms-and-Conditions>. Attention is drawn to the limitation of liability, indemnification and jurisdiction issues defined therein. Any holder of this document is advised that information contained hereon reflects the Company's findings at the time of its intervention only and within the limits of Client's instructions, if any. The Company's sole responsibility is to its Client and this document does not exonerate parties to a transaction from exercising all their rights and obligations under the transaction documents. This document cannot be reproduced except in full, without prior written approval of the Company. Any unauthorized alteration, forgery or falsification of the content or appearance of this document is unlawful and offenders may be prosecuted to the fullest extent of the law.

802.11n_HT20_Ch0

Frequency (MHz)	99% BW (MHz)	10 Log (B) (dB)
5180	17.389	12.400
5220	17.413	12.410
5240	17.407	12.410
5260	17.385	12.400
5300	17.383	12.400
5320	17.375	12.400

802.11n_HT20_Ch0

Frequency (MHz)	99% BW (MHz)	6dB BW (MHz)
5745	17.425	16.030
5785	17.413	15.250
5825	17.394	16.600

802.11n_HT20_Ch1

Frequency (MHz)	99% BW (MHz)	10 Log (B) (dB)
5180	17.428	12.410
5220	17.414	12.410
5240	17.412	12.410
5260	17.400	12.410
5300	17.412	12.410
5320	17.389	12.400

802.11n_HT20_Ch1

Frequency (MHz)	99% BW (MHz)	6dB BW (MHz)
5745	17.419	16.420
5785	17.411	16.300
5825	17.408	16.360

Unless otherwise stated the results shown in this test report refer only to the sample(s) tested and such sample(s) are retained for 90 days only.

除非另有說明，此報告結果僅對測試之樣品負責，同時此樣品僅保留90天。本報告未經本公司書面許可，不可部份複製。

This document is issued by the Company subject to its General Conditions of Service printed overleaf, available on request or accessible at <http://www.sgs.com.tw/Terms-and-Conditions> and for electronic format documents, subject to Terms and Conditions for Electronic Documents at <http://www.sgs.com.tw/Terms-and-Conditions>. Attention is drawn to the limitation of liability, indemnification and jurisdiction issues defined therein. Any holder of this document is advised that information contained hereon reflects the Company's findings at the time of its intervention only and within the limits of Client's instructions, if any. The Company's sole responsibility is to its Client and this document does not exonerate parties to a transaction from exercising all their rights and obligations under the transaction documents. This document cannot be reproduced except in full, without prior written approval of the Company. Any unauthorized alteration, forgery or falsification of the content or appearance of this document is unlawful and offenders may be prosecuted to the fullest extent of the law.

802.11n_HT40_Ch0

Frequency (MHz)	99% BW (MHz)	10 Log (B) (dB)
5190	35.675	15.520
5230	35.708	15.530
5270	35.742	15.530
5310	35.692	15.530

802.11n_HT40_Ch0

Frequency (MHz)	99% BW (MHz)	6dB BW (MHz)
5755	35.757	35.150
5795	35.787	35.290

802.11n_HT40_Ch1

Frequency (MHz)	99% BW (MHz)	10 Log (B) (dB)
5190	35.794	15.540
5230	35.681	15.520
5270	35.748	15.530
5310	35.812	15.540

802.11n_HT40_Ch1

Frequency (MHz)	99% BW (MHz)	6dB BW (MHz)
5755	35.738	33.030
5795	35.743	35.390

802.11ac_VHT80_Ch0

Frequency (MHz)	99% BW (MHz)	10 Log (B) (dB)
5210	74.811	18.740
5290	74.738	18.740

802.11ac_VHT80_Ch0

Frequency (MHz)	99% BW (MHz)	6dB BW (MHz)
5775	75.062	73.390

Unless otherwise stated the results shown in this test report refer only to the sample(s) tested and such sample(s) are retained for 90 days only.

除非另有說明，此報告結果僅對測試之樣品負責，同時此樣品僅保留90天。本報告未經本公司書面許可，不可部份複製。

This document is issued by the Company subject to its General Conditions of Service printed overleaf, available on request or accessible at <http://www.sgs.com.tw/Terms-and-Conditions> and for electronic format documents, subject to Terms and Conditions for Electronic Documents at <http://www.sgs.com.tw/Terms-and-Conditions>. Attention is drawn to the limitation of liability, indemnification and jurisdiction issues defined therein. Any holder of this document is advised that information contained hereon reflects the Company's findings at the time of its intervention only and within the limits of Client's instructions, if any. The Company's sole responsibility is to its Client and this document does not exonerate parties to a transaction from exercising all their rights and obligations under the transaction documents. This document cannot be reproduced except in full, without prior written approval of the Company. Any unauthorized alteration, forgery or falsification of the content or appearance of this document is unlawful and offenders may be prosecuted to the fullest extent of the law.

802.11ac_VHT80_Ch1

Frequency (MHz)	99% BW (MHz)	10 Log (B) (dB)
5210	74.816	18.740
5290	74.766	18.740

802.11ac_VHT80_Ch1

Frequency (MHz)	99% BW (MHz)	6dB BW (MHz)
5775	75.097	74.220

Unless otherwise stated the results shown in this test report refer only to the sample(s) tested and such sample(s) are retained for 90 days only.

除非另有說明，此報告結果僅對測試之樣品負責，同時此樣品僅保留90天。本報告未經本公司書面許可，不可部份複製。

This document is issued by the Company subject to its General Conditions of Service printed overleaf, available on request or accessible at <http://www.sgs.com.tw/Terms-and-Conditions> and for electronic format documents, subject to Terms and Conditions for Electronic Documents at <http://www.sgs.com.tw/Terms-and-Conditions>. Attention is drawn to the limitation of liability, indemnification and jurisdiction issues defined therein. Any holder of this document is advised that information contained hereon reflects the Company's findings at the time of its intervention only and within the limits of Client's instructions, if any. The Company's sole responsibility is to its Client and this document does not exonerate parties to a transaction from exercising all their rights and obligations under the transaction documents. This document cannot be reproduced except in full, without prior written approval of the Company. Any unauthorized alteration, forgery or falsification of the content or appearance of this document is unlawful and offenders may be prosecuted to the fullest extent of the law.

802.11a_20MHz_Chain0_5180MHz

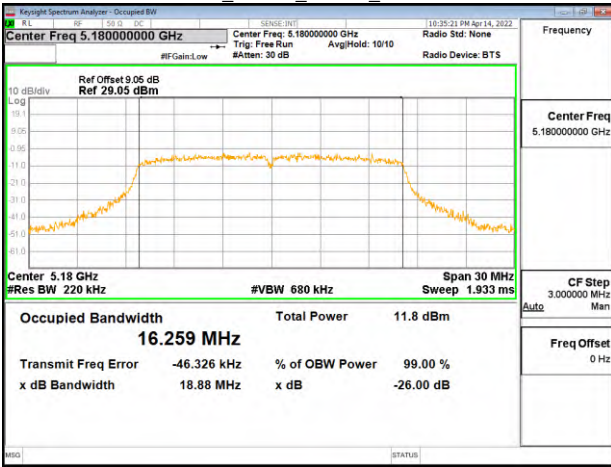

802.11a_20MHz_Chain0_5260MHz

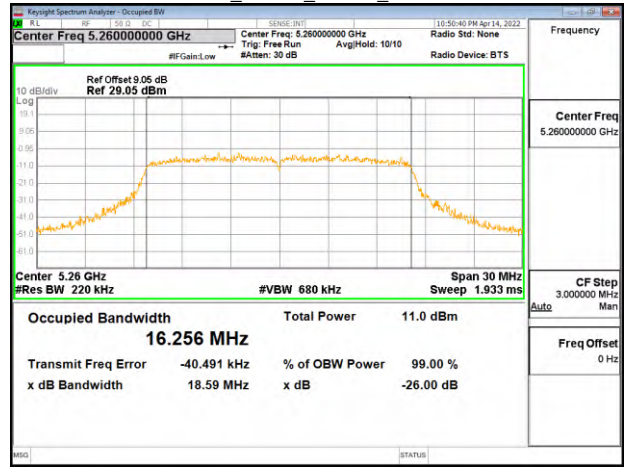

802.11a_20MHz_Chain0_5220MHz

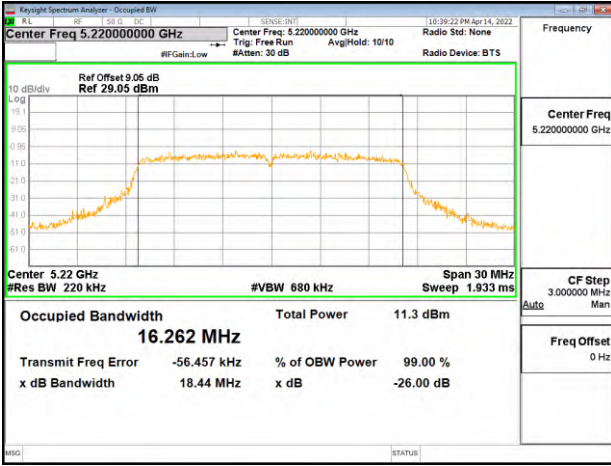

802.11a_20MHz_Chain0_5300MHz

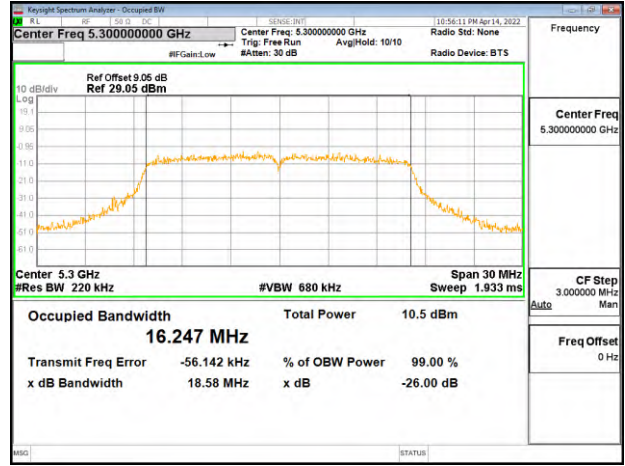

802.11a_20MHz_Chain0_5240MHz

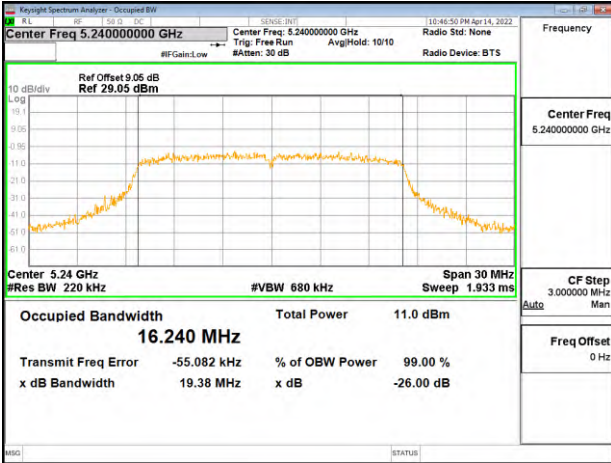

802.11a_20MHz_Chain0_5320MHz

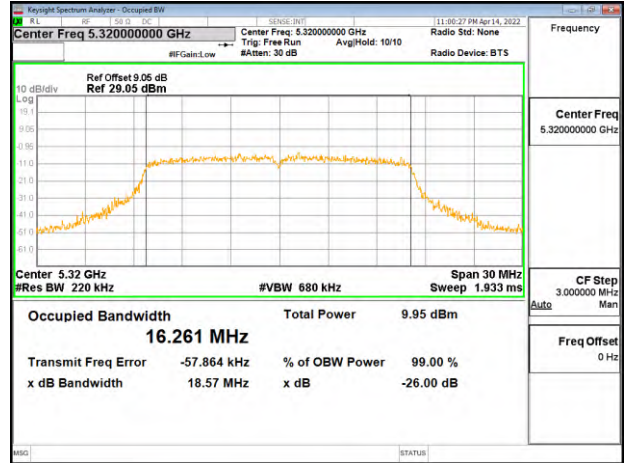

Unless otherwise stated the results shown in this test report refer only to the sample(s) tested and such sample(s) are retained for 90 days only.

除非另有說明，此報告結果僅對測試之樣品負責，同時此樣品僅保留90天。本報告未經本公司書面許可，不可部份複製。

This document is issued by the Company subject to its General Conditions of Service printed overleaf, available on request or accessible at <http://www.sgs.com.tw/Terms-and-Conditions> and for electronic format documents, subject to Terms and Conditions for Electronic Documents at <http://www.sgs.com.tw/Terms-and-Conditions>. Attention is drawn to the limitation of liability, indemnification and jurisdiction issues defined therein. Any holder of this document is advised that information contained hereon reflects the Company's findings at the time of its intervention only and within the limits of Client's instructions, if any. The Company's sole responsibility is to its Client and this document does not exonerate parties to a transaction from exercising all their rights and obligations under the transaction documents. This document cannot be reproduced except in full, without prior written approval of the Company. Any unauthorized alteration, forgery or falsification of the content or appearance of this document is unlawful and offenders may be prosecuted to the fullest extent of the law.

802.11a_20MHz_Chain0_5745MHz

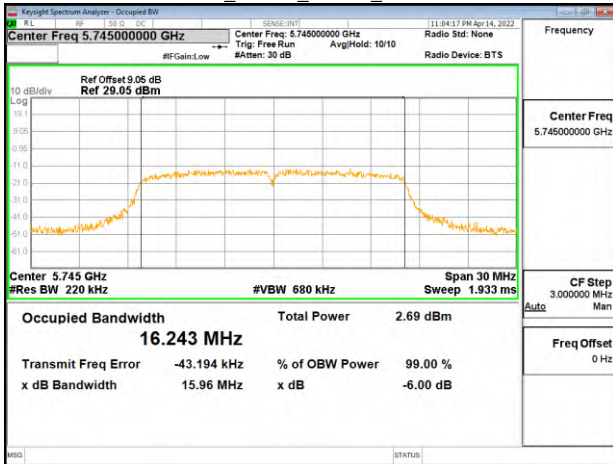

802.11a_20MHz_Chain1_5180MHz

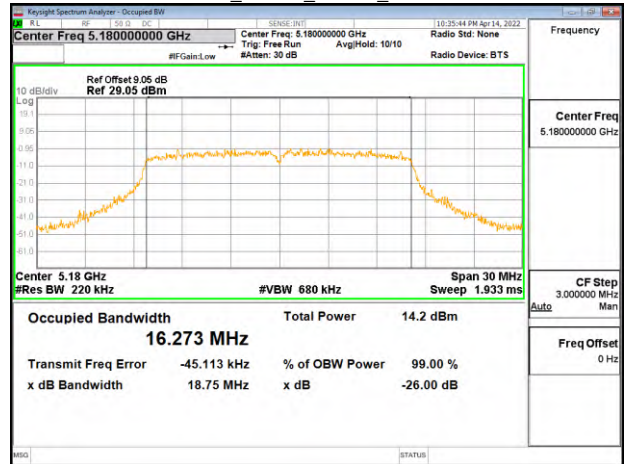

802.11a_20MHz_Chain0_5785MHz

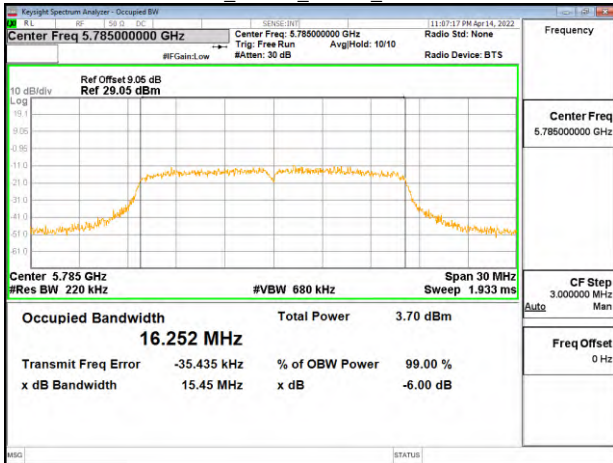

802.11a_20MHz_Chain1_5220MHz

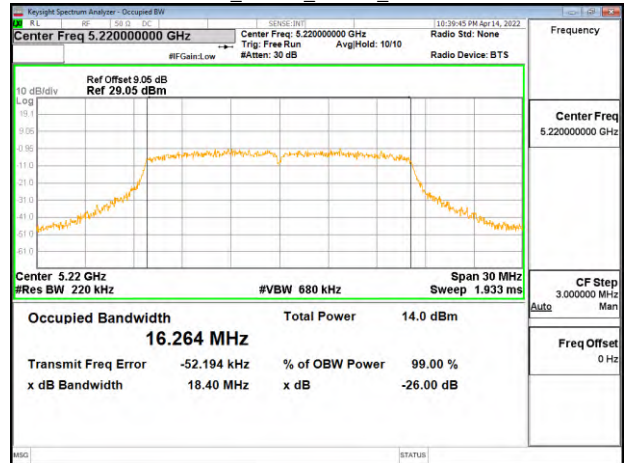

802.11a_20MHz_Chain0_5825MHz

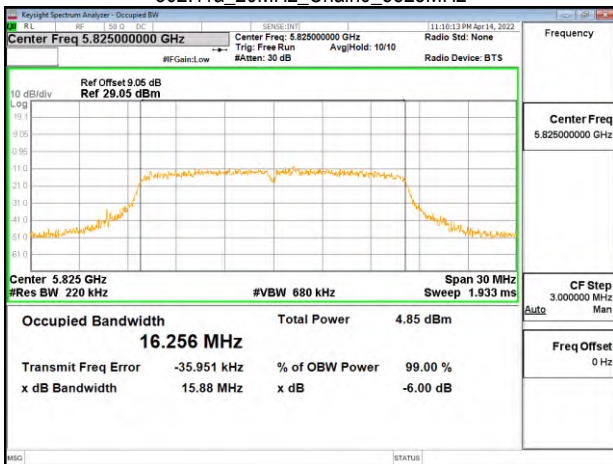

802.11a_20MHz_Chain1_5240MHz

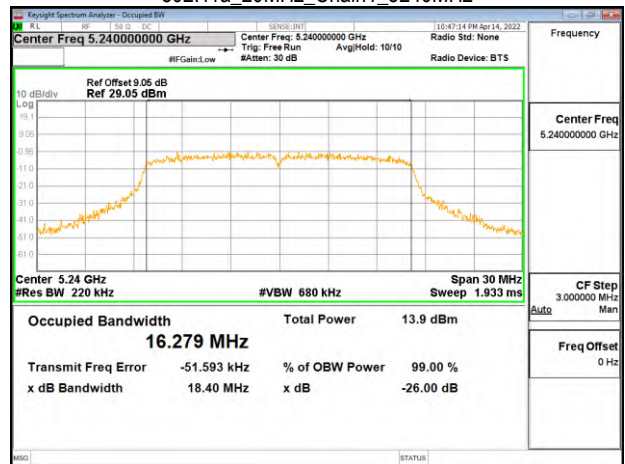

Unless otherwise stated the results shown in this test report refer only to the sample(s) tested and such sample(s) are retained for 90 days only.

除非另有說明，此報告結果僅對測試之樣品負責，同時此樣品僅保留90天。本報告未經本公司書面許可，不可部份複製。

This document is issued by the Company subject to its General Conditions of Service printed overleaf, available on request or accessible at <http://www.sgs.com.tw/Terms-and-Conditions> and for electronic format documents, subject to Terms and Conditions for Electronic Documents at <http://www.sgs.com.tw/Terms-and-Conditions>. Attention is drawn to the limitation of liability, indemnification and jurisdiction issues defined therein. Any holder of this document is advised that information contained herein reflects the Company's findings at the time of its intervention only and within the limits of Client's instructions, if any. The Company's sole responsibility is to its Client and this document does not exonerate parties to a transaction from exercising all their rights and obligations under the transaction documents. This document cannot be reproduced except in full, without prior written approval of the Company. Any unauthorized alteration, forgery or falsification of the content or appearance of this document is unlawful and offenders may be prosecuted to the fullest extent of the law.

802.11a_20MHz_Chain1_5260MHz

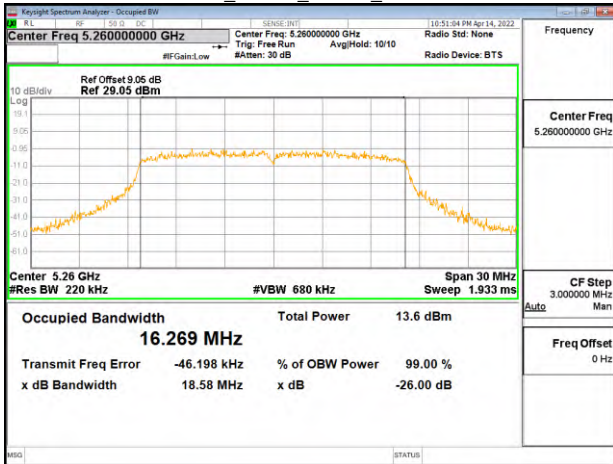

802.11a_20MHz_Chain1_5745MHz

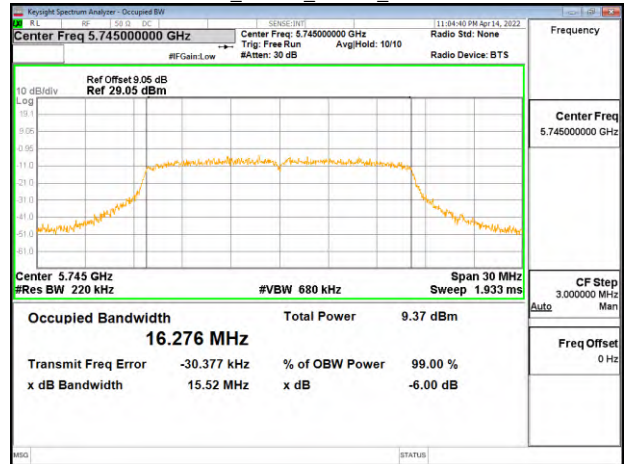

802.11a_20MHz_Chain1_5300MHz

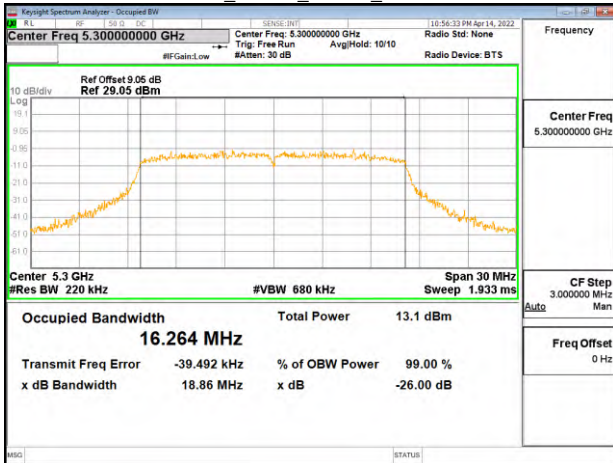

802.11a_20MHz_Chain1_5785MHz

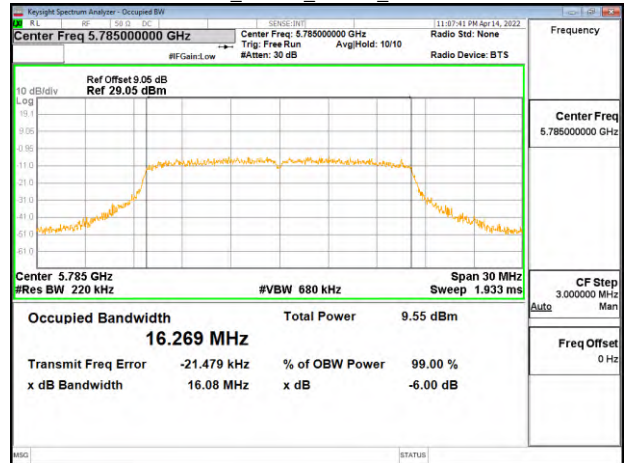

802.11a_20MHz_Chain1_5320MHz

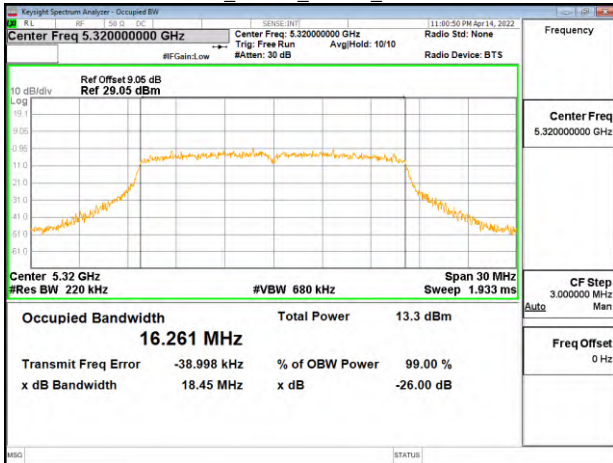

802.11a_20MHz_Chain1_5825MHz

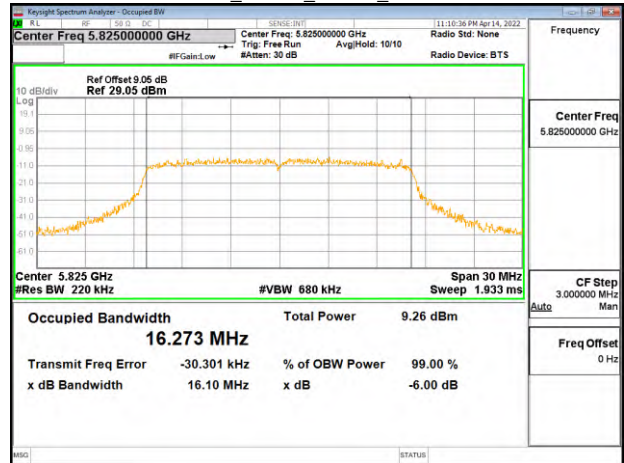

Unless otherwise stated the results shown in this test report refer only to the sample(s) tested and such sample(s) are retained for 90 days only.

除非另有說明，此報告結果僅對測試之樣品負責，同時此樣品僅保留90天。本報告未經本公司書面許可，不可部份複製。

This document is issued by the Company subject to its General Conditions of Service printed overleaf, available on request or accessible at <http://www.sgs.com.tw/Terms-and-Conditions> and for electronic format documents, subject to Terms and Conditions for Electronic Documents at <http://www.sgs.com.tw/Terms-and-Conditions>. Attention is drawn to the limitation of liability, indemnification and jurisdiction issues defined therein. Any holder of this document is advised that information contained hereon reflects the Company's findings at the time of its intervention only and within the limits of Client's instructions, if any. The Company's sole responsibility is to its Client and this document does not exonerate parties to a transaction from exercising all their rights and obligations under the transaction documents. This document cannot be reproduced except in full, without prior written approval of the Company. Any unauthorized alteration, forgery or falsification of the content or appearance of this document is unlawful and offenders may be prosecuted to the fullest extent of the law.

802.11n_20MHz_Chain0_5180MHz

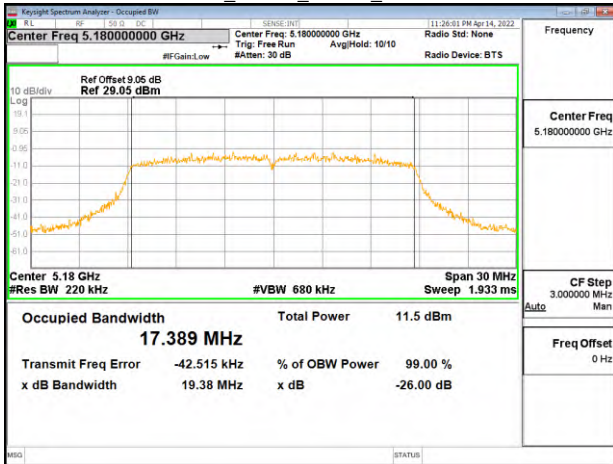

802.11n_20MHz_Chain0_5260MHz

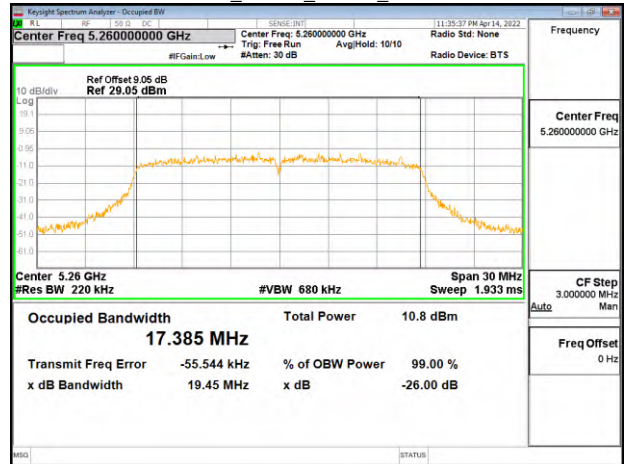

802.11n_20MHz_Chain0_5220MHz

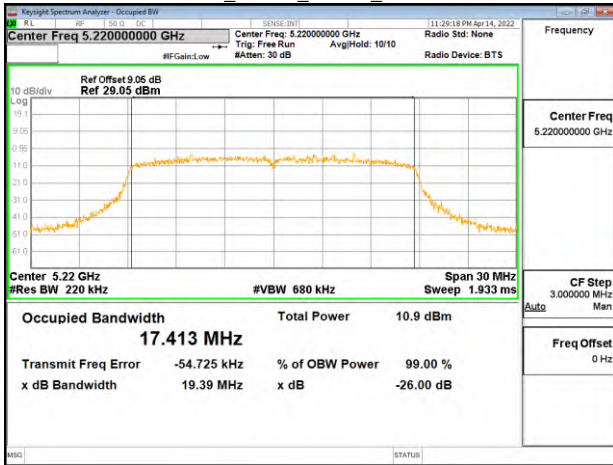

802.11n_20MHz_Chain0_5300MHz

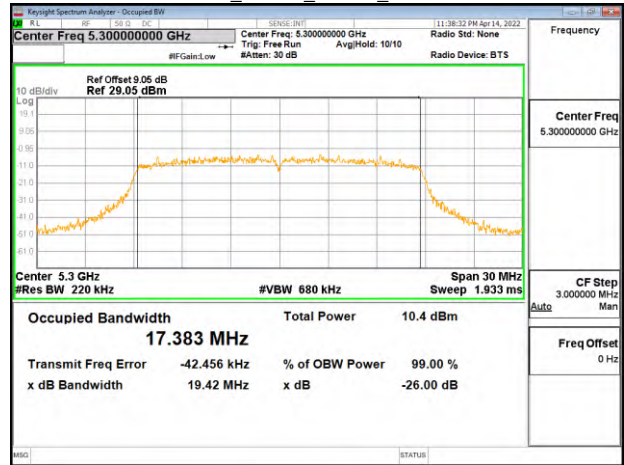

802.11n_20MHz_Chain0_5240MHz

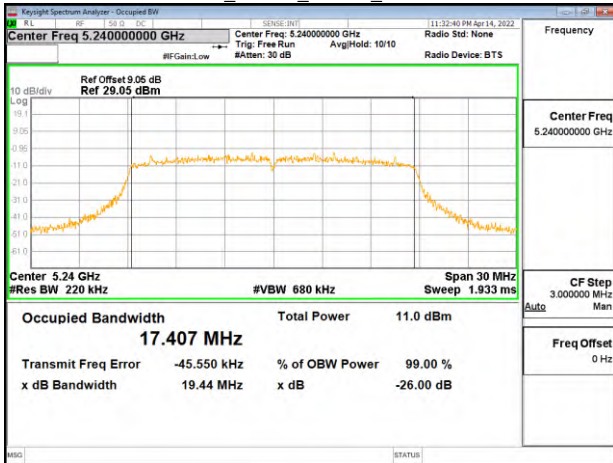

802.11n_20MHz_Chain0_5320MHz

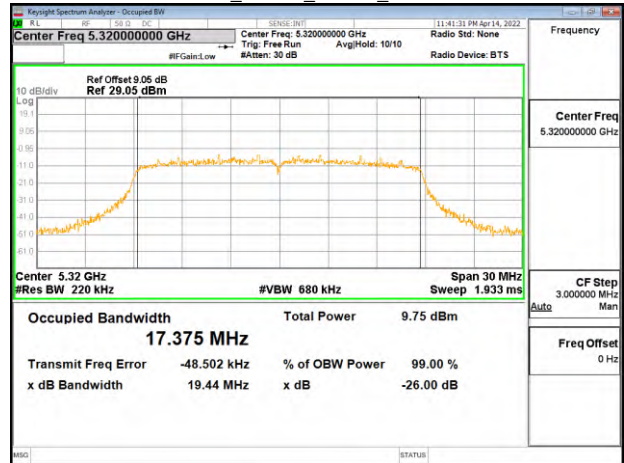

Unless otherwise stated the results shown in this test report refer only to the sample(s) tested and such sample(s) are retained for 90 days only.

除非另有說明，此報告結果僅對測試之樣品負責，同時此樣品僅保留90天。本報告未經本公司書面許可，不可部份複製。

This document is issued by the Company subject to its General Conditions of Service printed overleaf, available on request or accessible at <http://www.sgs.com.tw/Terms-and-Conditions> and for electronic format documents, subject to Terms and Conditions for Electronic Documents at <http://www.sgs.com.tw/Terms-and-Conditions>. Attention is drawn to the limitation of liability, indemnification and jurisdiction issues defined therein. Any holder of this document is advised that information contained hereon reflects the Company's findings at the time of its intervention only and within the limits of Client's instructions, if any. The Company's sole responsibility is to its Client and this document does not exonerate parties to a transaction from exercising all their rights and obligations under the transaction documents. This document cannot be reproduced except in full, without prior written approval of the Company. Any unauthorized alteration, forgery or falsification of the content or appearance of this document is unlawful and offenders may be prosecuted to the fullest extent of the law.

802.11n_20MHz_Chain0_5745MHz

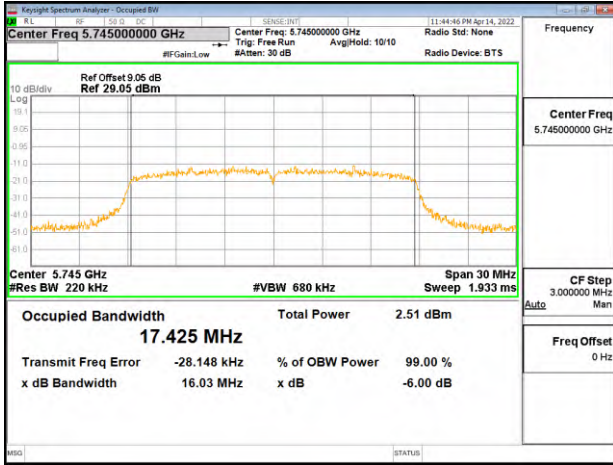

802.11n_20MHz_Chain1_5180MHz

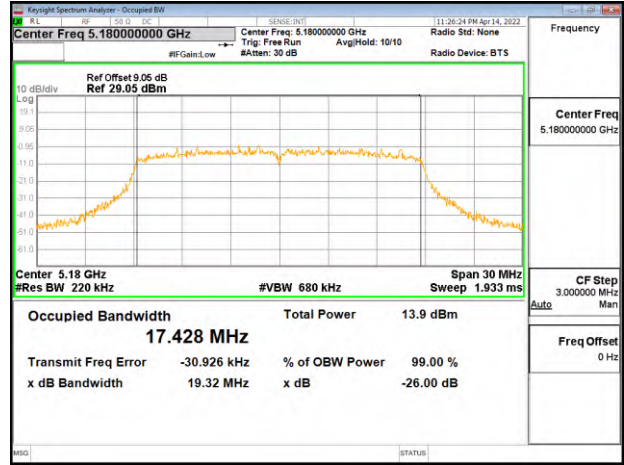

802.11n_20MHz_Chain0_5785MHz

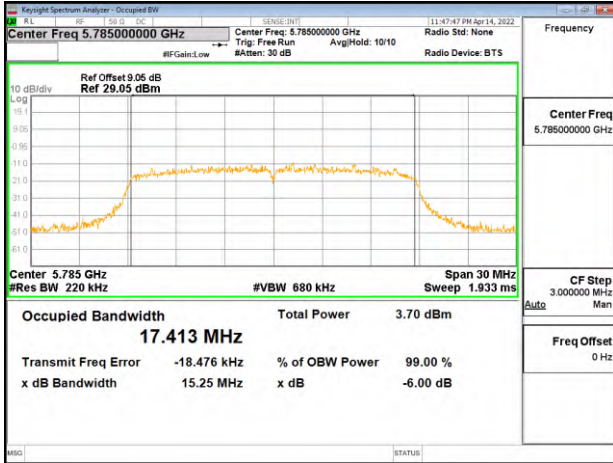

802.11n_20MHz_Chain1_5220MHz

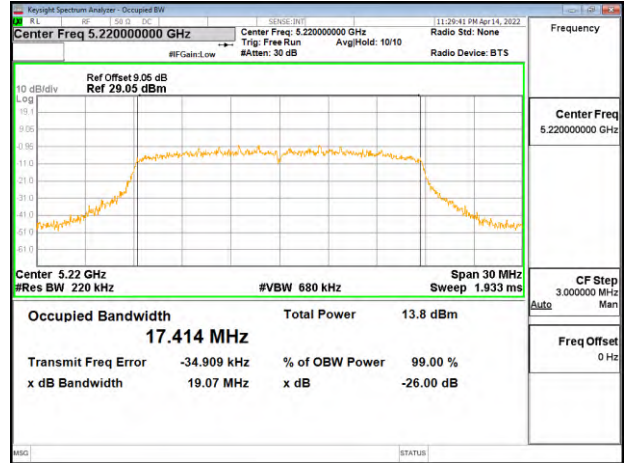

802.11n_20MHz_Chain0_5825MHz

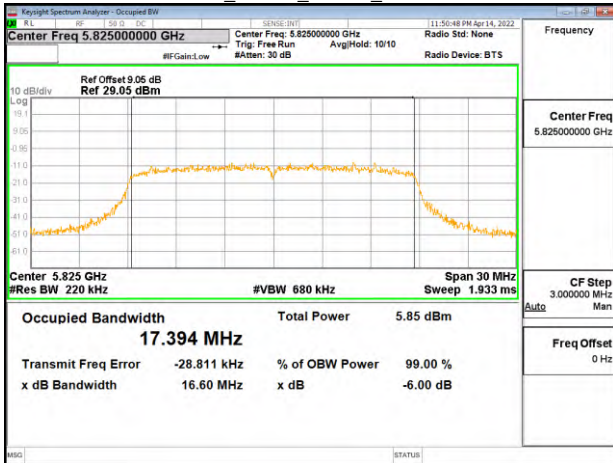

802.11n_20MHz_Chain1_5240MHz

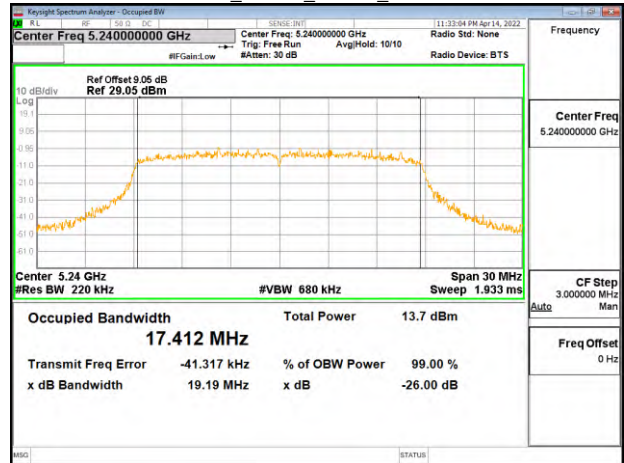

Unless otherwise stated the results shown in this test report refer only to the sample(s) tested and such sample(s) are retained for 90 days only.

除非另有說明，此報告結果僅對測試之樣品負責，同時此樣品僅保留90天。本報告未經本公司書面許可，不可部份複製。

This document is issued by the Company subject to its General Conditions of Service printed overleaf, available on request or accessible at <http://www.sgs.com.tw/Terms-and-Conditions> and for electronic format documents, subject to Terms and Conditions for Electronic Documents at <http://www.sgs.com.tw/Terms-and-Conditions>. Attention is drawn to the limitation of liability, indemnification and jurisdiction issues defined therein. Any holder of this document is advised that information contained hereon reflects the Company's findings at the time of its intervention only and within the limits of Client's instructions, if any. The Company's sole responsibility is to its Client and this document does not exonerate parties to a transaction from exercising all their rights and obligations under the transaction documents. This document cannot be reproduced except in full, without prior written approval of the Company. Any unauthorized alteration, forgery or falsification of the content or appearance of this document is unlawful and offenders may be prosecuted to the fullest extent of the law.

802.11n_20MHz_Chain1_5260MHz

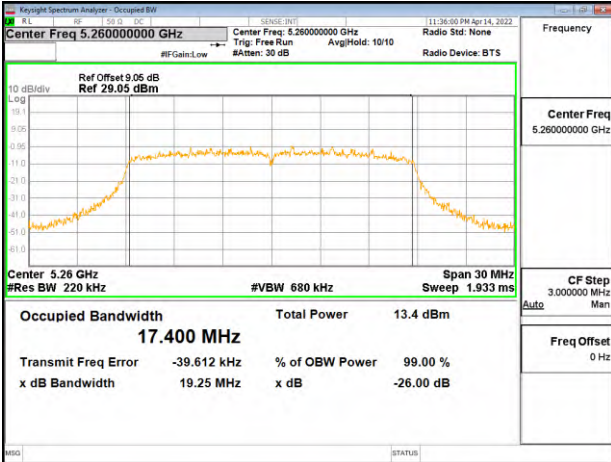

802.11n_20MHz_Chain1_5745MHz

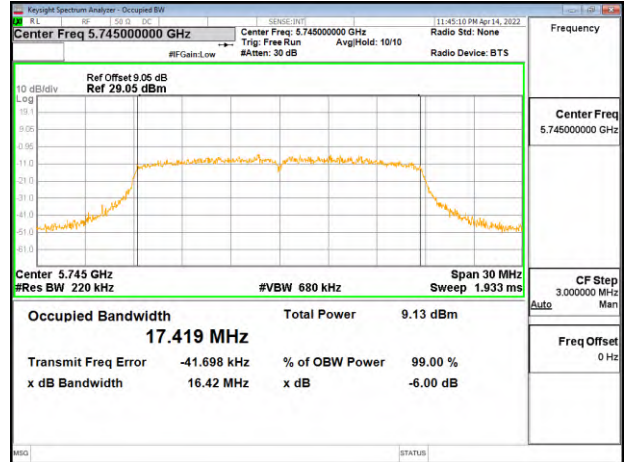

802.11n_20MHz_Chain1_5300MHz

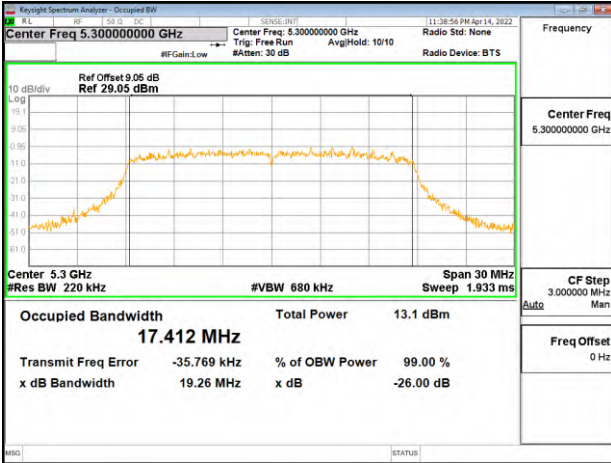

802.11n_20MHz_Chain1_5785MHz

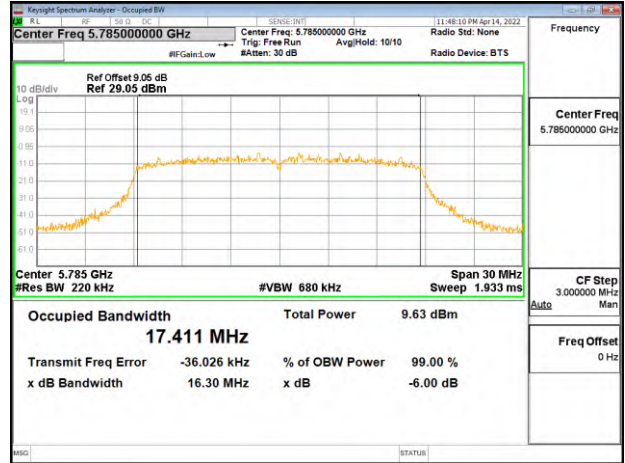

802.11n_20MHz_Chain1_5320MHz

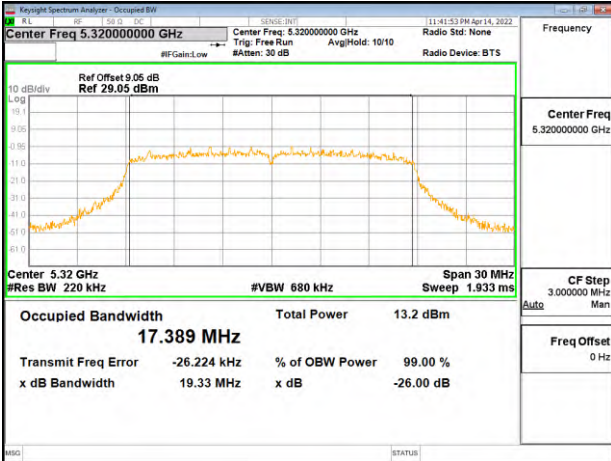

802.11n_20MHz_Chain1_5825MHz

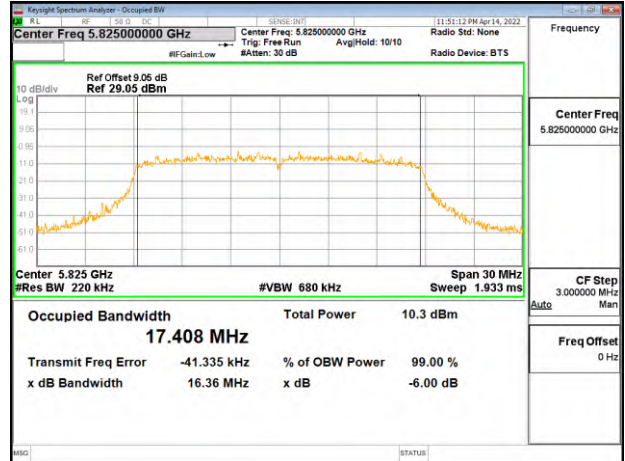

Unless otherwise stated the results shown in this test report refer only to the sample(s) tested and such sample(s) are retained for 90 days only.

除非另有說明，此報告結果僅對測試之樣品負責，同時此樣品僅保留90天。本報告未經本公司書面許可，不可部份複製。

This document is issued by the Company subject to its General Conditions of Service printed overleaf, available on request or accessible at <http://www.sgs.com.tw/Terms-and-Conditions> and for electronic format documents, subject to Terms and Conditions for Electronic Documents at <http://www.sgs.com.tw/Terms-and-Conditions>. Attention is drawn to the limitation of liability, indemnification and jurisdiction issues defined therein. Any holder of this document is advised that information contained hereon reflects the Company's findings at the time of its intervention only and within the limits of Client's instructions, if any. The Company's sole responsibility is to its Client and this document does not exonerate parties to a transaction from exercising all their rights and obligations under the transaction documents. This document cannot be reproduced except in full, without prior written approval of the Company. Any unauthorized alteration, forgery or falsification of the content or appearance of this document is unlawful and offenders may be prosecuted to the fullest extent of the law.

802.11n_40MHz_Chain0_5190MHz

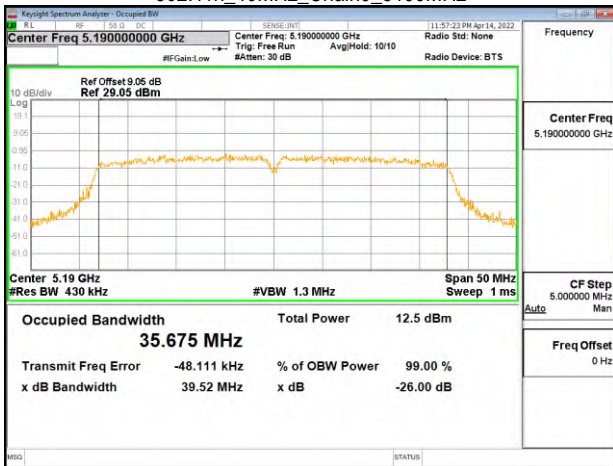

802.11n_40MHz_Chain0_5310MHz

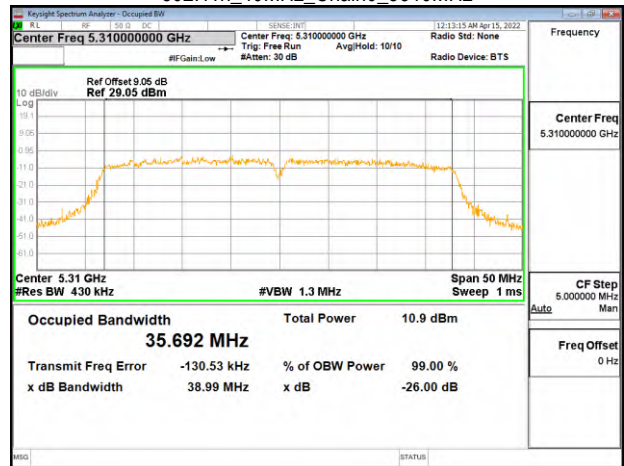

802.11n_40MHz_Chain0_5230MHz

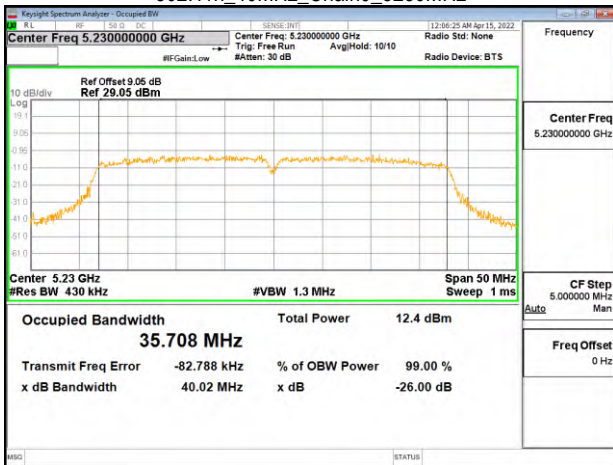

802.11n_40MHz_Chain0_5755MHz

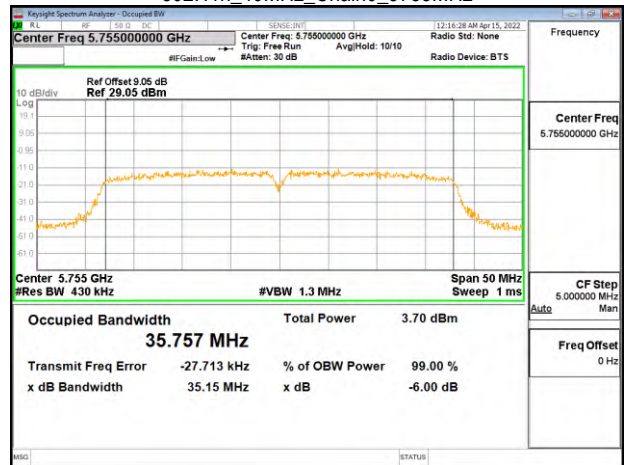

802.11n_40MHz_Chain0_5270MHz

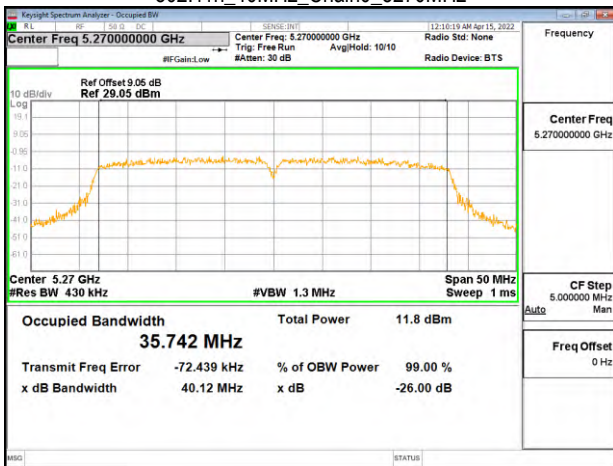

802.11n_40MHz_Chain0_5795MHz

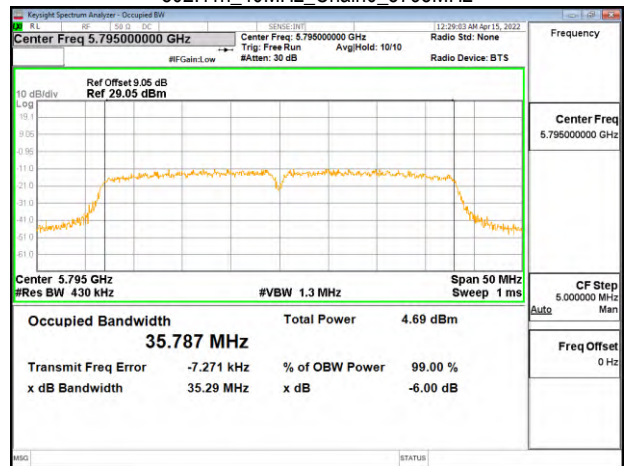

Unless otherwise stated the results shown in this test report refer only to the sample(s) tested and such sample(s) are retained for 90 days only.

除非另有說明，此報告結果僅對測試之樣品負責，同時此樣品僅保留90天。本報告未經本公司書面許可，不可部份複製。

This document is issued by the Company subject to its General Conditions of Service printed overleaf, available on request or accessible at <http://www.sgs.com.tw/Terms-and-Conditions> and for electronic format documents, subject to Terms and Conditions for Electronic Documents at <http://www.sgs.com.tw/Terms-and-Conditions>. Attention is drawn to the limitation of liability, indemnification and jurisdiction issues defined therein. Any holder of this document is advised that information contained herein reflects the Company's findings at the time of its intervention only and within the limits of Client's instructions, if any. The Company's sole responsibility is to its Client and this document does not exonerate parties to a transaction from exercising all their rights and obligations under the transaction documents. This document cannot be reproduced except in full, without prior written approval of the Company. Any unauthorized alteration, forgery or falsification of the content or appearance of this document is unlawful and offenders may be prosecuted to the fullest extent of the law.

802.11n_40MHz_Chain1_5190MHz

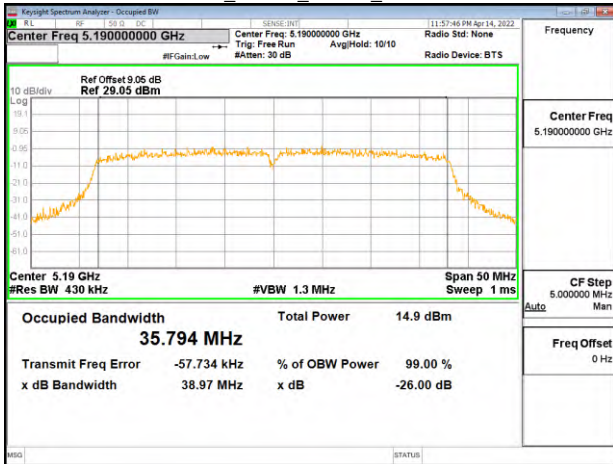

802.11n_40MHz_Chain1_5310MHz

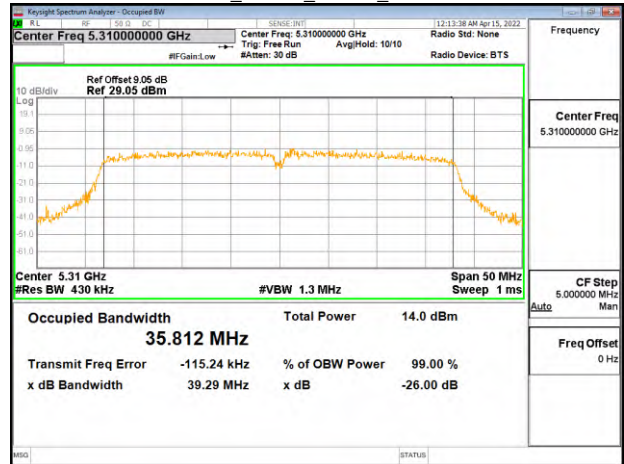

802.11n_40MHz_Chain1_5230MHz

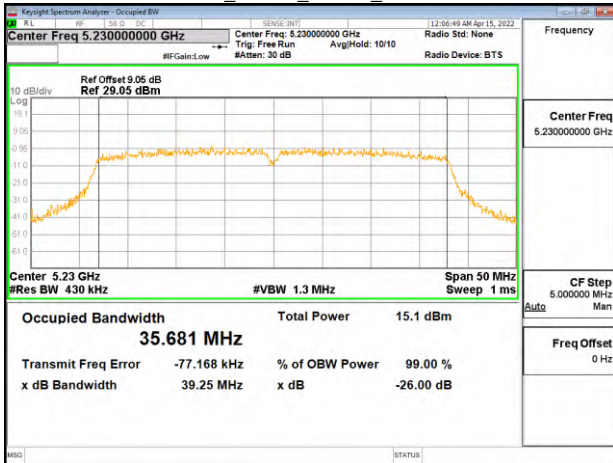

802.11n_40MHz_Chain1_5755MHz

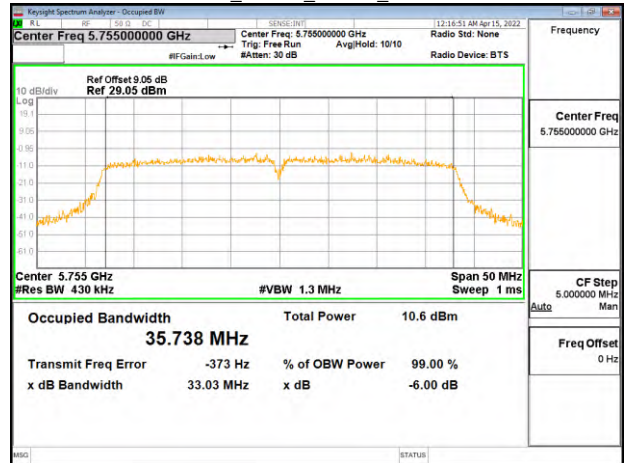

802.11n_40MHz_Chain1_5270MHz

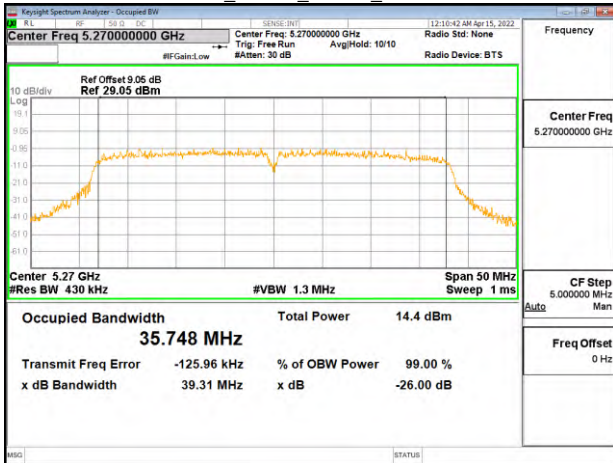

802.11n_40MHz_Chain1_5795MHz

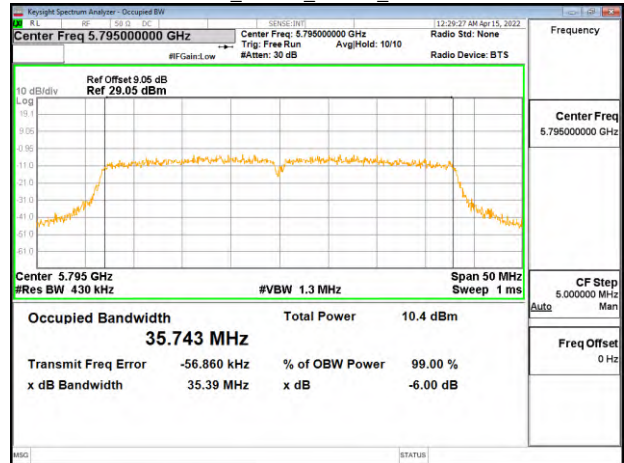

Unless otherwise stated the results shown in this test report refer only to the sample(s) tested and such sample(s) are retained for 90 days only.

除非另有說明，此報告結果僅對測試之樣品負責，同時此樣品僅保留90天。本報告未經本公司書面許可，不可部份複製。

This document is issued by the Company subject to its General Conditions of Service printed overleaf, available on request or accessible at <http://www.sgs.com.tw/Terms-and-Conditions> and for electronic format documents, subject to Terms and Conditions for Electronic Documents at <http://www.sgs.com.tw/Terms-and-Conditions>. Attention is drawn to the limitation of liability, indemnification and jurisdiction issues defined therein. Any holder of this document is advised that information contained hereon reflects the Company's findings at the time of its intervention only and within the limits of Client's instructions, if any. The Company's sole responsibility is to its Client and this document does not exonerate parties to a transaction from exercising all their rights and obligations under the transaction documents. This document cannot be reproduced except in full, without prior written approval of the Company. Any unauthorized alteration, forgery or falsification of the content or appearance of this document is unlawful and offenders may be prosecuted to the fullest extent of the law.

802.11ac_80MHz_Chain0_5210MHz

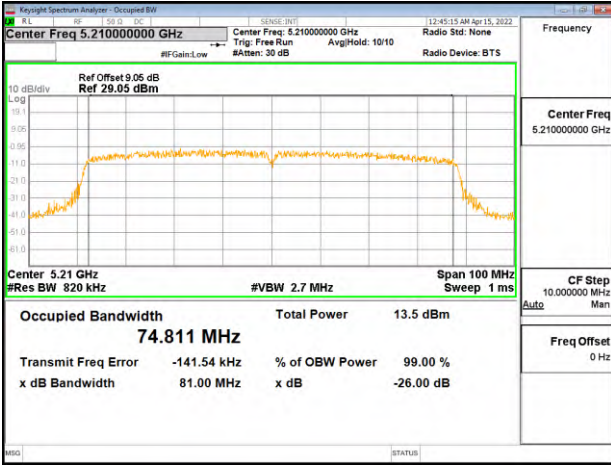

802.11ac_80MHz_Chain1_5210MHz

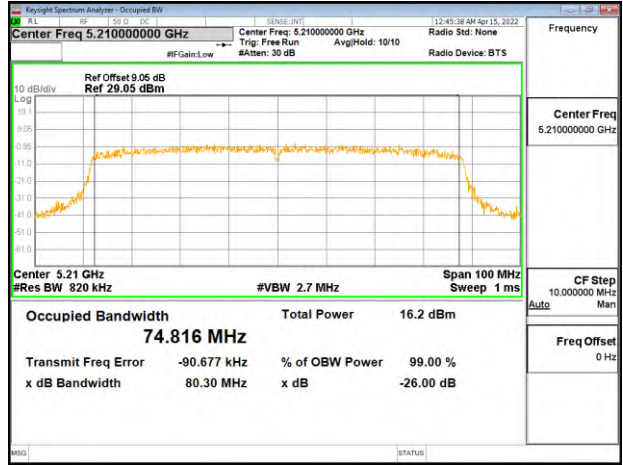

802.11ac_80MHz_Chain0_5290MHz

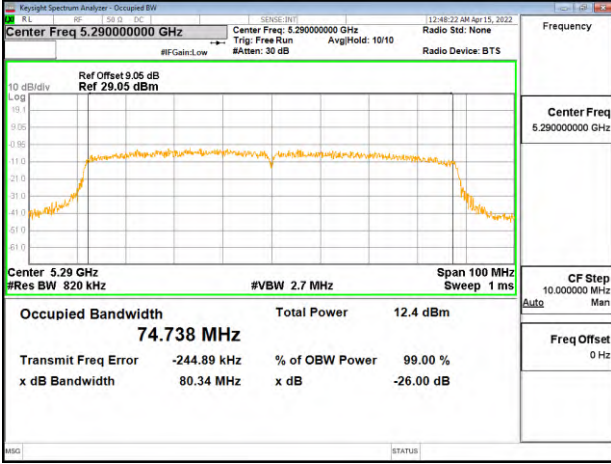

802.11ac_80MHz_Chain1_5290MHz

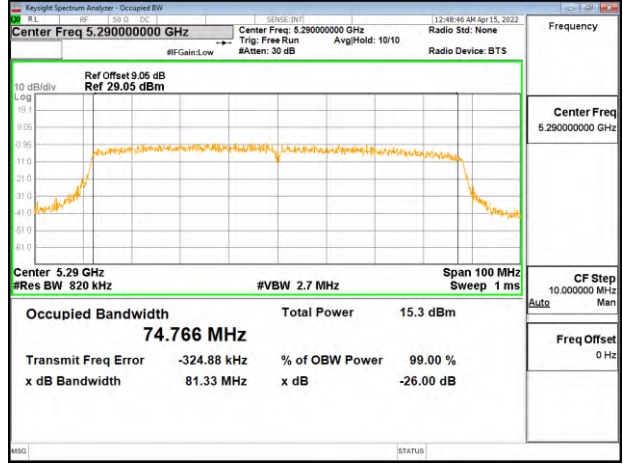

802.11ac_80MHz_Chain0_5775MHz

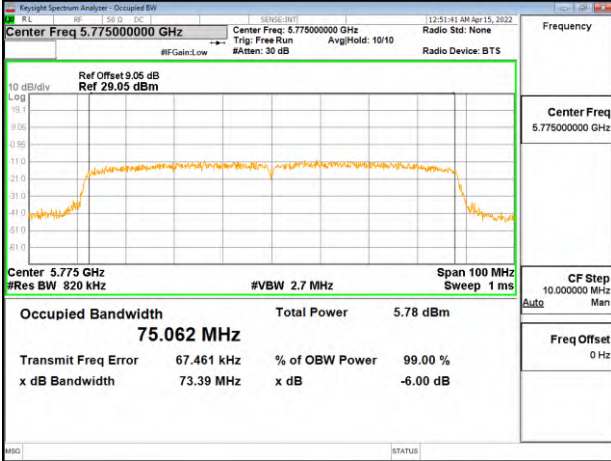

802.11ac_80MHz_Chain1_5775MHz

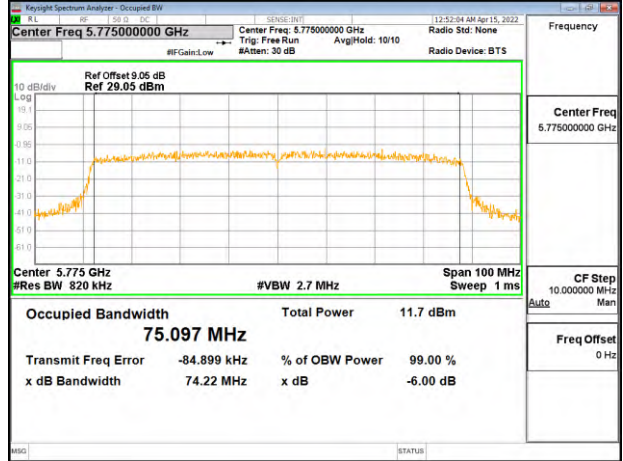

Unless otherwise stated the results shown in this test report refer only to the sample(s) tested and such sample(s) are retained for 90 days only.

除非另有說明，此報告結果僅對測試之樣品負責，同時此樣品僅保留90天。本報告未經本公司書面許可，不可部份複製。

This document is issued by the Company subject to its General Conditions of Service printed overleaf, available on request or accessible at <http://www.sgs.com.tw/Terms-and-Conditions> and for electronic format documents, subject to Terms and Conditions for Electronic Documents at <http://www.sgs.com.tw/Terms-and-Conditions>. Attention is drawn to the limitation of liability, indemnification and jurisdiction issues defined therein. Any holder of this document is advised that information contained hereon reflects the Company's findings at the time of its intervention only and within the limits of Client's instructions, if any. The Company's sole responsibility is to its Client and this document does not exonerate parties to a transaction from exercising all their rights and obligations under the transaction documents. This document cannot be reproduced except in full, without prior written approval of the Company. Any unauthorized alteration, forgery or falsification of the content or appearance of this document is unlawful and offenders may be prosecuted to the fullest extent of the law.

9 MAXIMUM CONDUCTED OUTPUT POWER MEASUREMENT

9.1 Standard Applicable

9.1.1 Duty Cycle

Pre-analysis Check: While conducting average power measurement, duty cycle of each mode shall be checked to ensure its duty cycle in order to compensate for the loss due to insufficient ratio of duty cycle.

All duty cycle is pre-scanned, and result as obtained below shows only the most representative ones where duty cycle is conducted as the given transmission with given virtual operation that expresses the percentage.

9.1.2 Output Power

Band	EUT CATEGORY		e-CRF Title 47 §15.407			
			Conducted Output Power	EIRP	TPC	Antenna Directional Gain Requirements
U-NII-1		Fixed point-to-point	1 Watt(30dBm)	Not required	Not required	23dBi
		Out door AP	1 Watt(30dBm)	Elevation angle above 30 degrees 125mW (21dBm)	Not required	6dBi
		Indoor AP	1 Watt(30dBm)	Not required	Not required	6dBi
	V	Other	250mW(23.98dBm)	Not required	Not required	6dBi
U-NII-2A	V	Other	250mW(23.98dBm) or 11dBm+10 log B	Not required	When EIRP >500mW At least 6dB below EIRP 1W (30dBm)	6dBi
U-NII-2C		Other	250mW(23.98dBm) or 11dBm+10 log B	Not required		6dBi
U-NII-3	V	Other	1 Watt(30dBm)	Not required	Not required	6dBi
		Fixed point-to-point	1 Watt(30dBm)	Not required	Not required	Not required
U-NII-4		Indoor AP (a channel spans 5725~5850 and 5850~5895MHz)	Not required	36dBm	Not required	Not required
		indoor client (a channel spans 5725~5850 and 5850~5895MHz)	Not required	30dBm	Not required	Not required
		subordinate device	Not required	36dBm	Not required	Not required

1. If transmitting antennas of directional gain greater than the antenna requirements column, the Maximum transmit power shall be reduced by the amount in dB that the direction-al gain of the antenna.

2. For the 10 log B, B is the 26 dB emission bandwidth.

Unless otherwise stated the results shown in this test report refer only to the sample(s) tested and such sample(s) are retained for 90 days only.

除非另有說明，此報告結果僅對測試之樣品負責，同時此樣品僅保留90天。本報告未經本公司書面許可，不可部份複製。

This document is issued by the Company subject to its General Conditions of Service printed overleaf, available on request or accessible at <http://www.sgs.com.tw/Terms-and-Conditions> and for electronic format documents, subject to Terms and Conditions for Electronic Documents at <http://www.sgs.com.tw/Terms-and-Conditions>. Attention is drawn to the limitation of liability, indemnification and jurisdiction issues defined therein. Any holder of this document is advised that information contained hereon reflects the Company's findings at the time of its intervention only and within the limits of Client's instructions, if any. The Company's sole responsibility is to its Client and this document does not exonerate parties to a transaction from exercising all their rights and obligations under the transaction documents. This document cannot be reproduced except in full, without prior written approval of the Company. Any unauthorized alteration, forgery or falsification of the content or appearance of this document is unlawful and offenders may be prosecuted to the fullest extent of the law.

FREQUENCY BAND (MHz)	EUT CATEGORY		RSS-247 §6.2.1~6.2.4		
			EIRP	Conducted Output Power	TPC
5150~5250		OEM devices installed in vehicles	30 mW or $1.76 + 10 \log_{10} B$	N/A	At least 3dB below 30mW EIRP
	V	Other device	200 mW or $10 + 10 \log_{10} B$ dBm	N/A	N/A
5250~5350		OEM devices installed in vehicles	30 mW or $1.76 + 10 \log_{10} B$	N/A	At least 3dB below 30mW EIRP
	V	Other device	1.0 W or $17 + 10 \log_{10} B$ dBm	250 mW or $11 + 10 \log_{10} B$	EIRP >500mW, at least 6dB below 1W EIRP
		Outdoor Fixed with EIRP>200mW	-13 dBW/MHz for $0^\circ \leq \theta < 8^\circ$ $-13 - 0.716 (\theta - 8)$ dBW/MHz for $8^\circ \leq \theta < 40^\circ$ $-35.9 - 1.22 (\theta - 40)$ dBW/MHz for $40^\circ \leq \theta \leq 45^\circ$ -42 dBW/MHz for $\theta > 45^\circ$	N/A	EIRP >500mW, at least 6dB below 1W EIRP
5470-5600 and 5650-5725		All	1.0 W or $17 + 10 \log_{10} B$ dBm	250 mW or $11 + 10 \log_{10} B$	EIRP >500mW, at least 6dB below 1W EIRP
5725~5850	V	All	N/A	1 W	N/A

- 1 For equipment operating in the band 5725-5850 MHz, If transmitting antennas of directional gain greater than 6 dBi are used, the Maximum transmit power shall be reduced by the amount in dB that the directional gain of the antenna exceeds 6 dBi.
2. For the $10 \log B$, B is the 99% emission bandwidth.

Unless otherwise stated the results shown in this test report refer only to the sample(s) tested and such sample(s) are retained for 90 days only.

除非另有說明，此報告結果僅對測試之樣品負責，同時此樣品僅保留90天。本報告未經本公司書面許可，不可部份複製。

This document is issued by the Company subject to its General Conditions of Service printed overleaf, available on request or accessible at <http://www.sgs.com.tw/Terms-and-Conditions> and for electronic format documents, subject to Terms and Conditions for Electronic Documents at <http://www.sgs.com.tw/Terms-and-Conditions>. Attention is drawn to the limitation of liability, indemnification and jurisdiction issues defined therein. Any holder of this document is advised that information contained hereon reflects the Company's findings at the time of its intervention only and within the limits of Client's instructions, if any. The Company's sole responsibility is to its Client and this document does not exonerate parties to a transaction from exercising all their rights and obligations under the transaction documents. This document cannot be reproduced except in full, without prior written approval of the Company. Any unauthorized alteration, forgery or falsification of the content or appearance of this document is unlawful and offenders may be prosecuted to the fullest extent of the law.

9.2 Test Setup

9.2.1 Duty Cycle

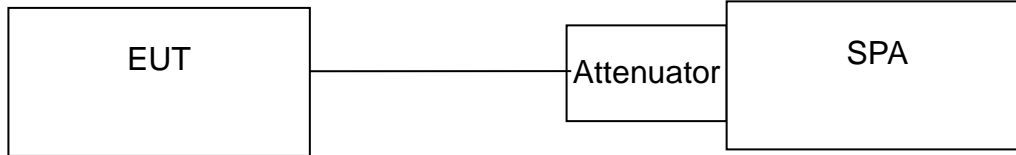

9.2.2 Output Power

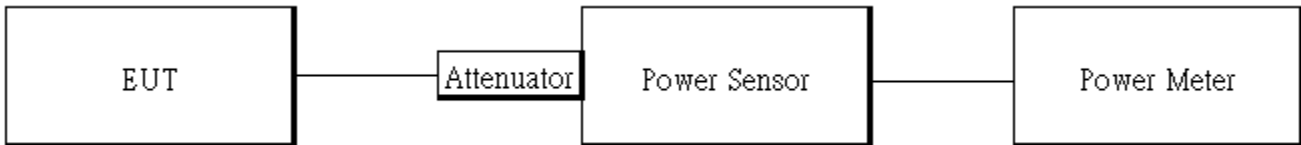

9.3 Measurement Procedure

9.3.1 Duty Cycle Measurements

1. Set span = Zero
2. RBW = 8MHz
3. VBW = 8MHz,
4. Detector = Peak

9.3.2 Output Power Measurements

1. Place the EUT on the table and set it in transmitting mode.
2. The testing follows FCC KDB 789033 D02 General UNII Test Procedures New Rules .
3. Remove the antenna from the EUT and then connect a low loss RF cable from the antenna port to the power meter
4. Power Meter is used as the auxiliary test equipment to conduct the output power measurement.
5. Record the max. reading and add $10 \log(1/\text{duty cycle})$.
6. Repeat above procedures until all frequency (low, middle, and high channel) measured were complete.
7. MIMO mode: offset is set with “measure and add $10 \log(N)$ ” to measurement for MIMO mode. Offset = cable loss + $10 \log(N)$, where N is number of transmitting antenna, cable loss is specified below.

Unless otherwise stated the results shown in this test report refer only to the sample(s) tested and such sample(s) are retained for 90 days only.
 除非另有說明，此報告結果僅對測試之樣品負責，同時此樣品僅保留90天。本報告未經本公司書面許可，不可部份複製。

This document is issued by the Company subject to its General Conditions of Service printed overleaf, available on request or accessible at <http://www.sgs.com.tw/Terms-and-Conditions> and for electronic format documents, subject to Terms and Conditions for Electronic Documents at <http://www.sgs.com.tw/Terms-and-Conditions>. Attention is drawn to the limitation of liability, indemnification and jurisdiction issues defined therein. Any holder of this document is advised that information contained hereon reflects the Company's findings at the time of its intervention only and within the limits of Client's instructions, if any. The Company's sole responsibility is to its Client and this document does not exonerate parties to a transaction from exercising all their rights and obligations under the transaction documents. This document cannot be reproduced except in full, without prior written approval of the Company. Any unauthorized alteration, forgery or falsification of the content or appearance of this document is unlawful and offenders may be prosecuted to the fullest extent of the law.

Note:

As per section F. 2). e). (ii) of FCC KDB 662911 D01

If antenna gains are not equal and each transmit antenna is driven by only one spatial stream, directional gain may be calculated by either of the following formulas.

$$DirectionalGain = 10 \cdot \log \left[\frac{\sum_{j=1}^{N_{SS}} \left\{ \sum_{k=1}^{N_{ANT}} g_{j,k} \right\}^2}{N_{ANT}} \right]$$

where

Each antenna is driven by no more than one spatial stream;

NSS = the number of independent spatial streams of data;

NANT = the total number of antennas

$g_{j,k}$ = / 20 10Gk if the kth antenna is being fed by spatial stream j, or zero if it is not;

G_k is the gain in dBi of the kth antenna.

The antenna gain is greater than 6 dBi in MIMO mode, therefore the the power density limit attenuation has been applied in the test results.

Cable Loss Offset (dB)
9.05

9.4 Duty Cycle Measurement Result

Mode	Duty Cycle (%) =Ton / (Ton+Toff)	Duty Factor (dB) =10*log (1/Duty Cycle)	1/T (kHz)	VBW setting (kHz)
802.11a	95.12	0.22	0.48	1.00
802.11n_20	91.88	0.37	0.52	1.00
802.11ac_20	92.71	0.33	0.52	1.00
802.11n_40	89.94	0.46	1.05	2.00
802.11ac_40	89.98	0.46	1.05	2.00
802.11ac_80	81.40	0.89	2.16	3.00

Unless otherwise stated the results shown in this test report refer only to the sample(s) tested and such sample(s) are retained for 90 days only.

除非另有說明，此報告結果僅對測試之樣品負責，同時此樣品僅保留90天。本報告未經本公司書面許可，不可部份複製。

This document is issued by the Company subject to its General Conditions of Service printed overleaf, available on request or accessible at <http://www.sgs.com.tw/Terms-and-Conditions> and for electronic format documents, subject to Terms and Conditions for Electronic Documents at <http://www.sgs.com.tw/Terms-and-Conditions>. Attention is drawn to the limitation of liability, indemnification and jurisdiction issues defined therein. Any holder of this document is advised that information contained hereon reflects the Company's findings at the time of its intervention only and within the limits of Client's instructions, if any. The Company's sole responsibility is to its Client and this document does not exonerate parties to a transaction from exercising all their rights and obligations under the transaction documents. This document cannot be reproduced except in full, without prior written approval of the Company. Any unauthorized alteration, forgery or falsification of the content or appearance of this document is unlawful and offenders may be prosecuted to the fullest extent of the law.

802.11a_20MHz_Chain0_5180MHz

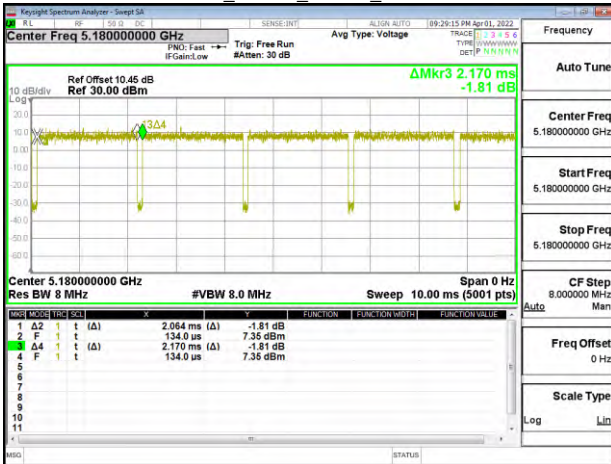

802.11ac_20MHz_Chain0_5180MHz



802.11n_20MHz_Chain0_5180MHz



802.11ac_40MHz_Chain0_5190MHz

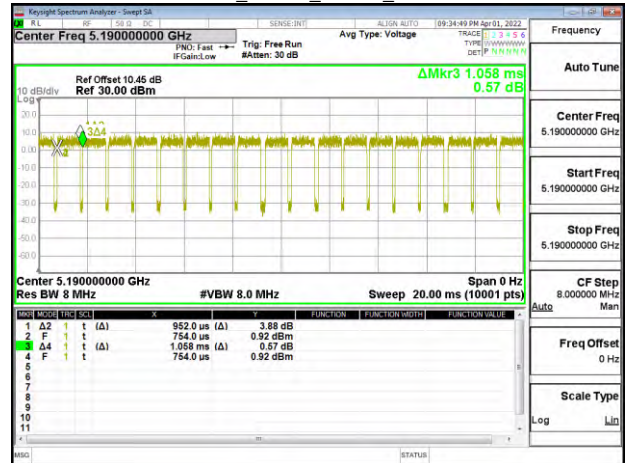

802.11n_40MHz_Chain0_5190MHz



802.11ac_80MHz_Chain0_5210MHz



Unless otherwise stated the results shown in this test report refer only to the sample(s) tested and such sample(s) are retained for 90 days only.

除非另有說明，此報告結果僅對測試之樣品負責，同時此樣品僅保留90天。本報告未經本公司書面許可，不可部份複製。

This document is issued by the Company subject to its General Conditions of Service printed overleaf, available on request or accessible at <http://www.sgs.com.tw/Terms-and-Conditions> and for electronic format documents, subject to Terms and Conditions for Electronic Documents at <http://www.sgs.com.tw/Terms-and-Conditions>. Attention is drawn to the limitation of liability, indemnification and jurisdiction issues defined therein. Any holder of this document is advised that information contained hereon reflects the Company's findings at the time of its intervention only and within the limits of Client's instructions, if any. The Company's sole responsibility is to its Client and this document does not exonerate parties to a transaction from exercising all their rights and obligations under the transaction documents. This document cannot be reproduced except in full, without prior written approval of the Company. Any unauthorized alteration, forgery or falsification of the content or appearance of this document is unlawful and offenders may be prosecuted to the fullest extent of the law.

9.5 Output Power Measurement Result

9.5.1 FCC Output power

802.11a_Ch0

CH	Frequency (MHz)	Data Rate	Power set	TOTAL POWER (dBm)	TOTAL POWER (mW)	REQUIRED LIMIT (dBm)	RESULT
36	5180	6	10	5.15	3.271	23.98	PASS
44	5220	6	10	5.06	3.204	23.98	PASS
48	5240	6	10	5.10	3.234	23.98	PASS
52	5260	6	10	4.90	3.088	23.56	PASS
60	5300	6	11	5.20	3.309	23.68	PASS
64	5320	6	11	4.85	3.053	23.68	PASS
149	5745	6	13	3.92	2.464	30	PASS
157	5785	6	12	3.75	2.370	30	PASS
165	5825	6	12	4.00	2.510	30	PASS

802.11a_Ch1

CH	Frequency (MHz)	Data Rate	Power set	TOTAL POWER (dBm)	TOTAL POWER (mW)	REQUIRED LIMIT (dBm)	RESULT
36	5180	6	11	8.25	6.679	23.98	PASS
44	5220	6	11	7.93	6.205	23.98	PASS
48	5240	6	10	7.88	6.134	23.98	PASS
52	5260	6	10	7.90	6.162	23.73	PASS
60	5300	6	10	8.04	6.364	23.72	PASS
64	5320	6	10	8.00	6.306	23.7	PASS
149	5745	6	8	4.96	3.131	30	PASS
157	5785	6	8	4.97	3.139	30	PASS
165	5825	6	8	4.91	3.095	30	PASS

802.11a_2TX

CH	Frequency (MHz)	Data Rate	Power set	Avg. POWER (dBm)		TOTAL POWER (dBm)	TOTAL POWER (mW)	REQUIRED LIMIT (dBm)	RESULT
				Ch0	Ch1				
36	5180	6	11	5.19	8.27	10.23	10.544	22.32	PASS
44	5220	6	11	5.16	8.23	10.19	10.447	22.32	PASS
48	5240	6	11	5.2	8.21	10.19	10.447	22.32	PASS
52	5260	6	11	5.18	8.26	10.22	10.520	21.3	PASS
60	5300	6	11	5.06	8.19	10.13	10.304	21.3	PASS
64	5320	6	11	4.65	8.22	10.02	10.046	21.3	PASS
149	5745	6	8	-1.19	4.93	6.10	4.074	28.61	PASS
157	5785	6	8	-0.6	4.95	6.23	4.198	28.61	PASS
165	5825	6	8	-0.2	4.94	6.32	4.285	28.61	PASS

Unless otherwise stated the results shown in this test report refer only to the sample(s) tested and such sample(s) are retained for 90 days only.

除非另有說明，此報告結果僅對測試之樣品負責，同時此樣品僅保留90天。本報告未經本公司書面許可，不可部份複製。

This document is issued by the Company subject to its General Conditions of Service printed overleaf, available on request or accessible at <http://www.sgs.com.tw/Terms-and-Conditions> and for electronic format documents, subject to Terms and Conditions for Electronic Documents at <http://www.sgs.com.tw/Terms-and-Conditions>. Attention is drawn to the limitation of liability, indemnification and jurisdiction issues defined therein. Any holder of this document is advised that information contained hereon reflects the Company's findings at the time of its intervention only and within the limits of Client's instructions, if any. The Company's sole responsibility is to its Client and this document does not exonerate parties to a transaction from exercising all their rights and obligations under the transaction documents. This document cannot be reproduced except in full, without prior written approval of the Company. Any unauthorized alteration, forgery or falsification of the content or appearance of this document is unlawful and offenders may be prosecuted to the fullest extent of the law.

802.11n_HT20_Ch0

CH	Frequency (MHz)	Data Rate	Power set	TOTAL POWER (dBm)	TOTAL POWER (mW)	REQUIRED LIMIT (dBm)	RESULT
36	5180	MCS0	10	5.17	3.287	23.98	PASS
44	5220	MCS0	10	5.01	3.168	23.98	PASS
48	5240	MCS0	10	4.99	3.153	23.98	PASS
52	5260	MCS0	10	4.89	3.082	23.68	PASS
60	5300	MCS0	11	4.99	3.153	23.68	PASS
64	5320	MCS0	11	4.66	2.923	23.68	PASS
149	5745	MCS0	13	3.93	2.470	30	PASS
157	5785	MCS0	12	3.66	2.322	30	PASS
165	5825	MCS0	12	3.92	2.465	30	PASS

802.11n_HT20_Ch1

CH	Frequency (MHz)	Data Rate	Power set	TOTAL POWER (dBm)	TOTAL POWER (mW)	REQUIRED LIMIT (dBm)	RESULT
36	5180	MCS0	11	8.24	6.665	23.98	PASS
44	5220	MCS0	11	7.90	6.163	23.98	PASS
48	5240	MCS0	10	7.84	6.078	23.98	PASS
52	5260	MCS0	10	7.81	6.036	23.87	PASS
60	5300	MCS0	10	7.98	6.277	23.87	PASS
64	5320	MCS0	10	7.92	6.191	23.86	PASS
149	5745	MCS0	8	4.88	3.075	30	PASS
157	5785	MCS0	8	4.91	3.096	30	PASS
165	5825	MCS0	8	4.92	3.103	30	PASS

802.11n_HT20_MIMO

CH	Frequency (MHz)	Data Rate	Power set	Avg. POWER (dBm)		TOTAL POWER (dBm)	TOTAL POWER (mW)	REQUIRED LIMIT (dBm)	RESULT
				Ch0	Ch1				
36	5180	MCS8	11	5.16	8.09	10.25	10.593	22.32	PASS
44	5220	MCS8	11	5.2	8.03	10.22	10.520	22.32	PASS
48	5240	MCS8	11	5.17	8.18	10.31	10.740	22.32	PASS
52	5260	MCS8	11	5.01	8.27	10.32	10.765	21.3	PASS
60	5300	MCS8	11	4.66	8.25	10.19	10.447	21.3	PASS
64	5320	MCS8	11	4.67	8.23	10.18	10.423	21.3	PASS
149	5745	MCS8	8	-1.64	4.72	5.99	3.972	28.61	PASS
157	5785	MCS8	8	-0.95	4.7	6.11	4.083	28.61	PASS
165	5825	MCS8	9	-0.41	4.93	6.41	4.375	28.61	PASS

Unless otherwise stated the results shown in this test report refer only to the sample(s) tested and such sample(s) are retained for 90 days only.

除非另有說明，此報告結果僅對測試之樣品負責，同時此樣品僅保留90天。本報告未經本公司書面許可，不可部份複製。

This document is issued by the Company subject to its General Conditions of Service printed overleaf, available on request or accessible at <http://www.sgs.com.tw/Terms-and-Conditions> and for electronic format documents, subject to Terms and Conditions for Electronic Documents at <http://www.sgs.com.tw/Terms-and-Conditions>. Attention is drawn to the limitation of liability, indemnification and jurisdiction issues defined therein. Any holder of this document is advised that information contained hereon reflects the Company's findings at the time of its intervention only and within the limits of Client's instructions, if any. The Company's sole responsibility is to its Client and this document does not exonerate parties to a transaction from exercising all their rights and obligations under the transaction documents. This document cannot be reproduced except in full, without prior written approval of the Company. Any unauthorized alteration, forgery or falsification of the content or appearance of this document is unlawful and offenders may be prosecuted to the fullest extent of the law.