

APPENDIX 1: Photographs of test setup

Appendix 1-1: Photograph of EUT and antenna position

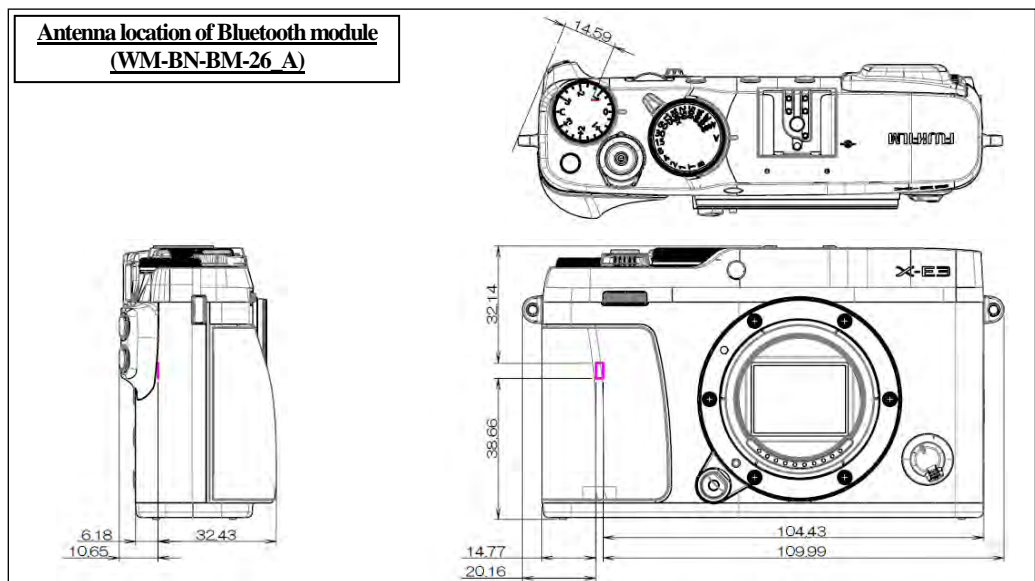

Appendix 1-2: EUT and support equipment

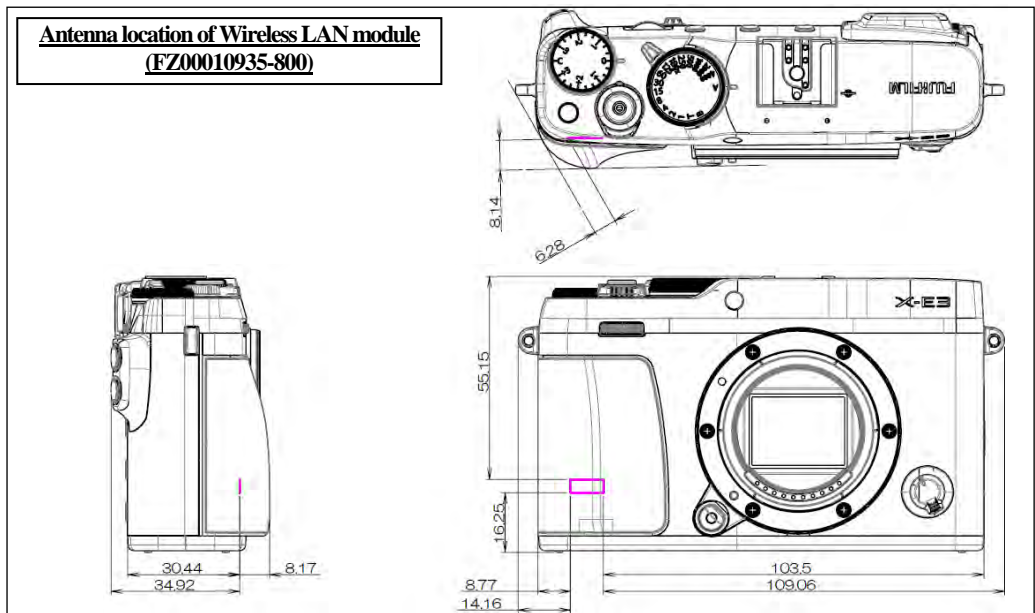
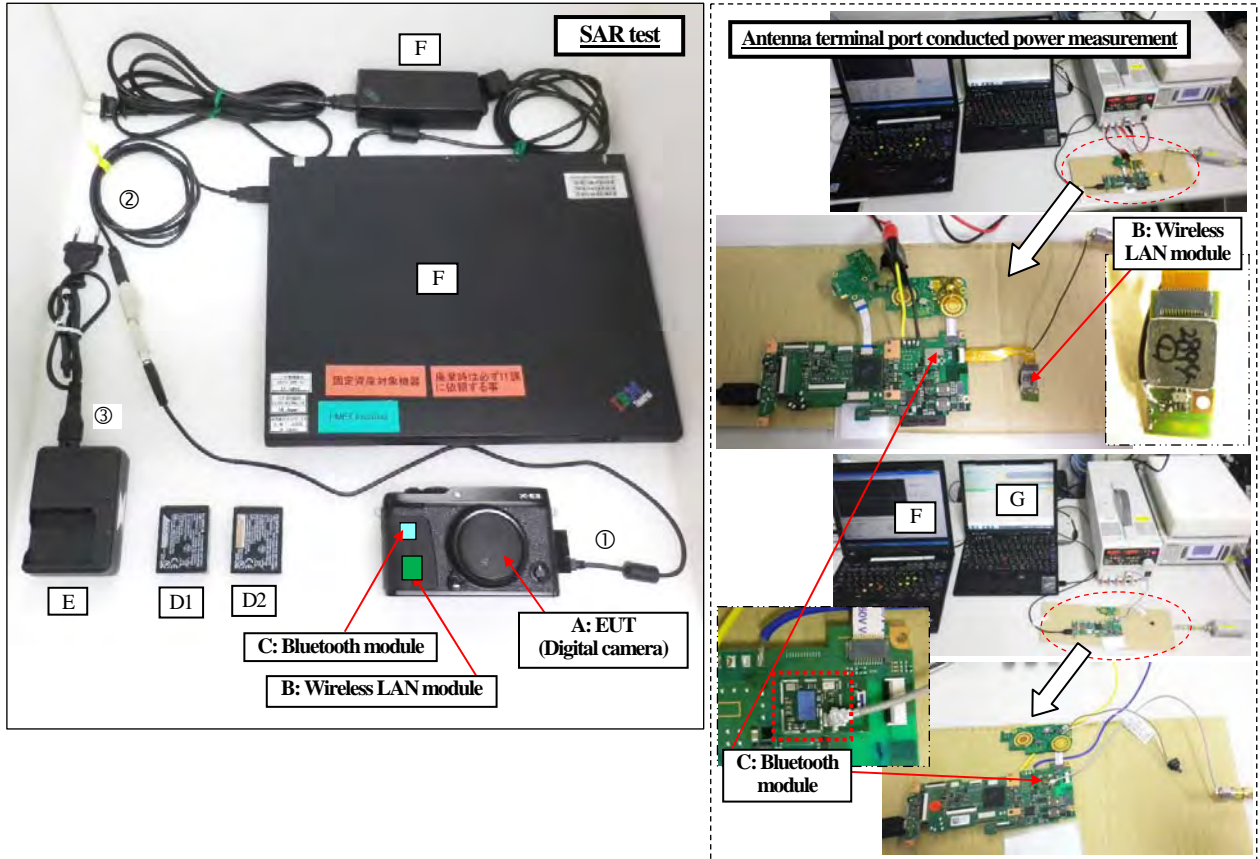

Description of EUT and Support Equipment

No.	Item	Model number	Serial number	Manufacturer	Remark
A	Digital Camera	FF170001	P1000006	Fujifilm Corporation	EUT.
B	Wireless LAN Module	FZ00010935-800	sar01	Fujifilm Corporation	*. Device in an EUT.
C	Bluetooth Module	WM-BN-BM-26_A	sar01	Universal Global Scientific Industrial Co., Ltd.	*. Device in an EUT.
D1	Lithium Ion Battery (DC 7.2V, typ.1260 mAh, 8.7 Wh)	NP-W126	01	Fujifilm Corporation	*. Accessory of EUT. Battery ID: #1.
D2			02		*. Accessory of EUT. Battery ID: #2.
E	Battery Charger	BC-W126	01	Fujifilm Corporation	Support equipment.
F	Laptop PC (UL#KSPC-03)	ThinkPad T42 (Type 2373-L32)	L3-NHT3R_05/07	Lenovo	Support equipment.
	AC Adaptor	08K8208	11S08K8208Z1Z9MA5668XB	Lenovo	DC cable: 1.8m, Unshielded. AC cable: 2m, Unshielded.
H	Laptop PC (UL#SRE-121)	7666-77J	LV-B8PZ8 08/05	Lenovo	Support equipment.
	AC Adaptor	92P1213	11S92P1213Z1ZDDZ92C2B0	Lenovo	DC cable: 1.8m, Unshielded. AC cable: 1m, Unshielded.

List of cables used













No.	Name	Length (m)	Shield
①	USB cable (*. Accessory of digital camera)	0.55	Shielded
②	USB extension cable	1.4	Shielded

No.	Name	Length (m)	Shield
③	AC cable (For item #E)	0.8	Unshielded

Appendix 1-3: Photograph of test setup

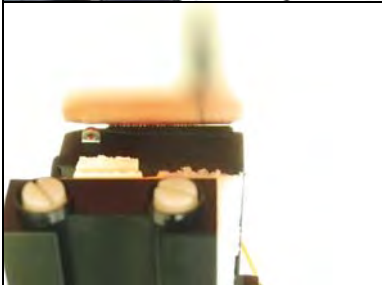
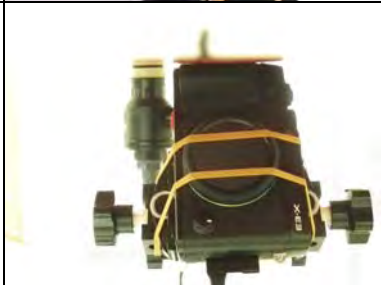
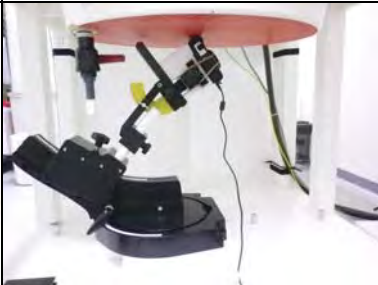
Position	Setup photographs		
Front-right (Touch)			
Front-right (*Repeat) (Touch)			
Front-right (*No device holder) (Touch)			

Appendix 1-3: Photograph of test setup (cont'd)

Position	Setup photographs		
Front (Touch)			
Front-lens (Touch)			
Right-front (Touch)			
			
Rear (Touch)			
Bottom (Touch)	