

APPENDIX 1: Photographs of test setup

Appendix 1-1: Photograph of EUT and antenna position

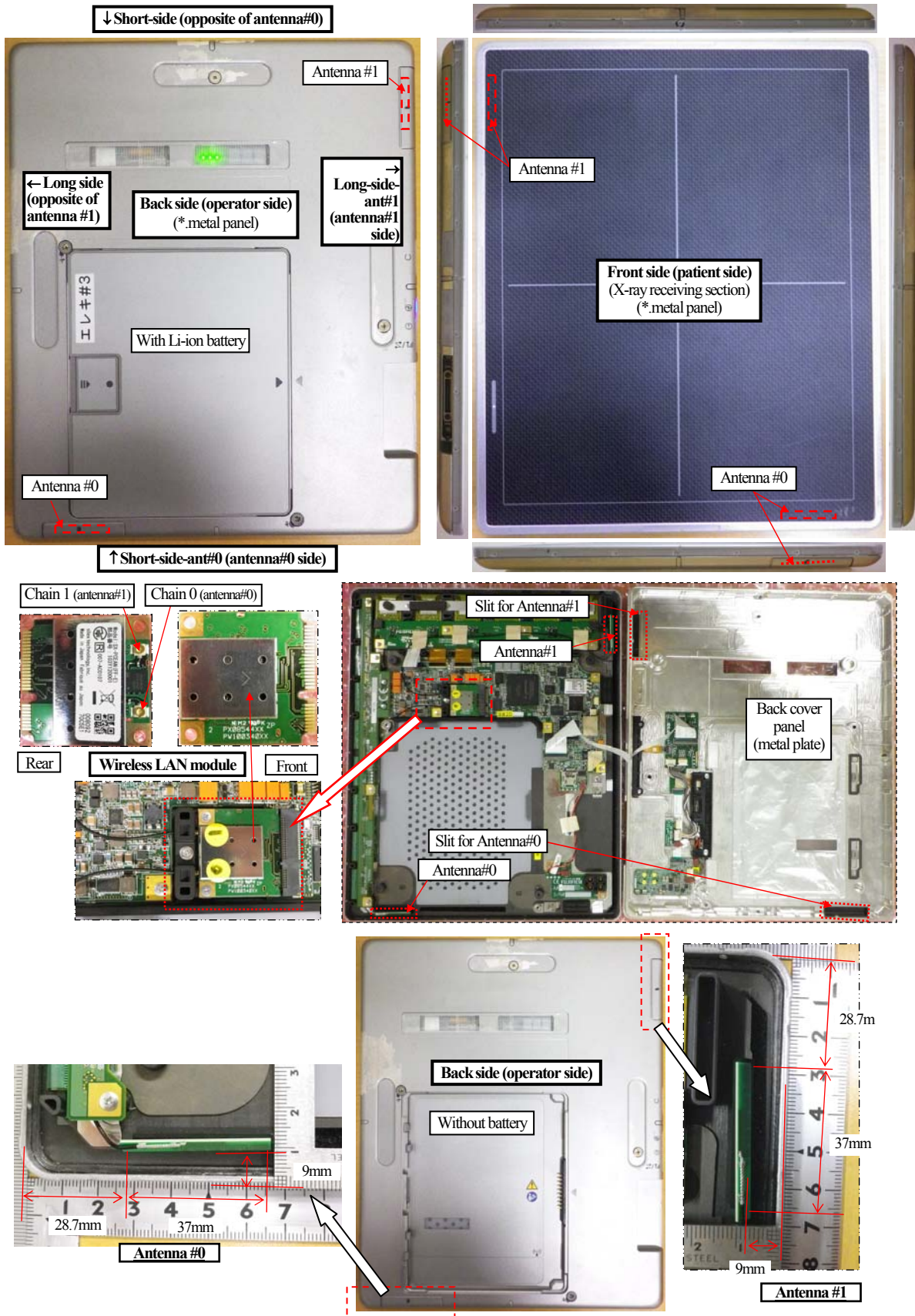

UL Japan, Inc.

Shonan EMC Lab.

1-22-3 Megumigaoka, Hiratsuka-shi, Kanagawa-ken, 259-1220 JAPAN
Telephone: +81 463 50 6400 / Facsimile: +81 463 50 6401

Appendix 1-2: Antenna position

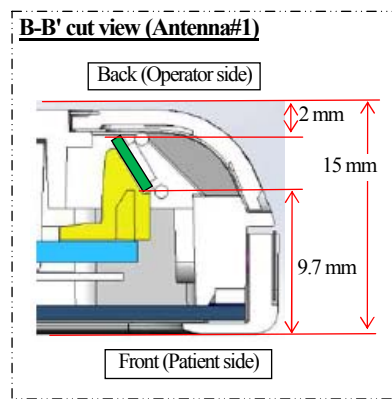
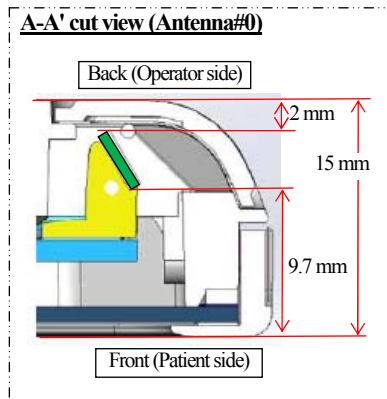
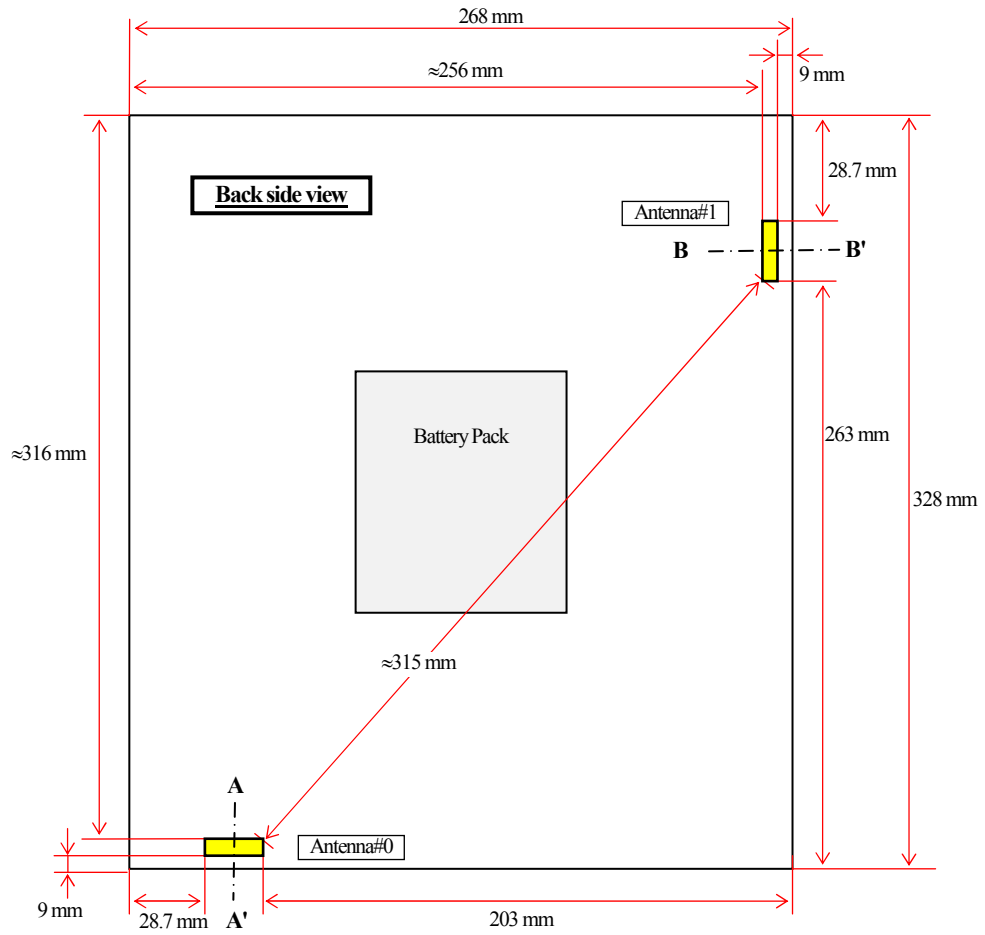

Appendix 1-3: EUT and support equipment

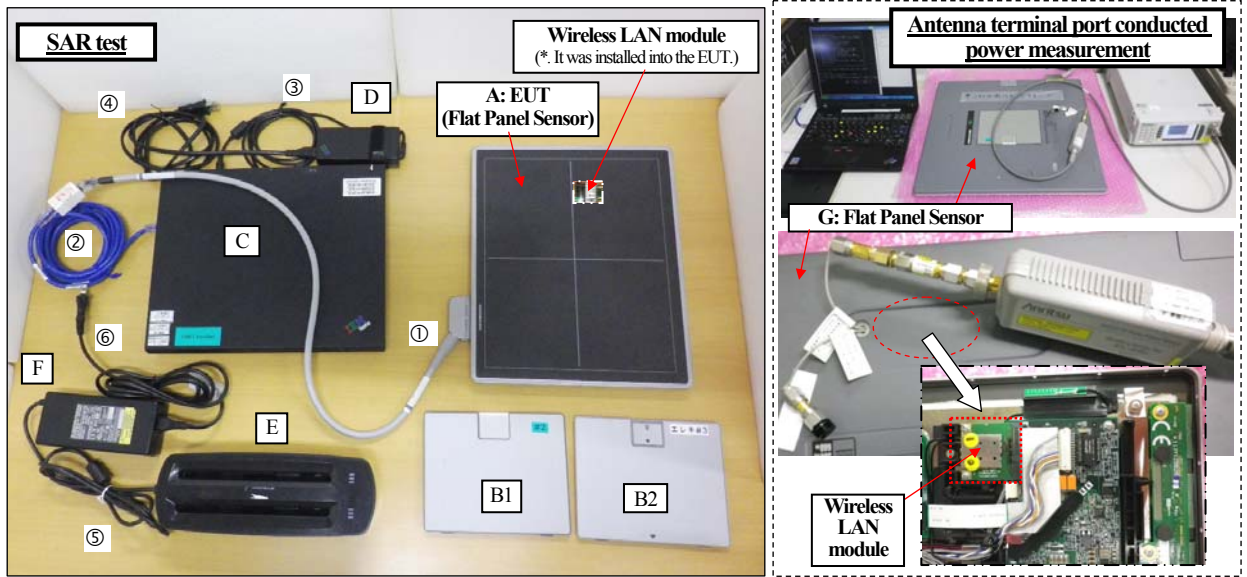

Description of EUT and Support Equipment















No.	Item	Model number	Serial number	Manufacturer	Remark
A	Flat Panel Sensor	RIC 24C	#001	FUJIFILM Corporation	EUT.
(With the following wireless LAN module.)					
-	Wireless LAN module	SX-PCEAN(FF-E)	00809270C5E1	Silix Technology, Inc.	
B1	Battery Pack (DC 7.4 V, 3200 mAh, 24 Wh (Li-ion))	BJ-LF20001AA	#2	Panasonic Automotive & Industrial Systems Company	Support equipment.
B2			#3		
C	Laptop PC (#KSPC-03)	ThinkPad T42 (Type 2373-L32)	L3-NHT3R_05/07	lenovo	Support equipment.
D	AC Adaptor	08K8208	11S08K8208Z1Z9MA5668XB	lenovo	Support equipment.
E	Battery Charger	FP2560A	No.24	Futaba Electric	Support equipment.
F	AC Adaptor	RC120G-16D	D004528F	Telecommunication Co., Ltd.	Support equipment.
* The following equipment was used for the antenna terminal port conducted power measurement.					
G	Flat Panel Sensor	RIC 43G	#001	FUJIFILM Corporation	Support equipment.

List of cables used

No.	Name	Length (m)	Shield
①	LAN interface cable	0.8	Shielded
②	LAN cable (CAT6)	3	Unshielded
③	DC cable (AC adaptor)	1.8	Unshielded

No.	Name	Length (m)	Shield
④	AC cable (AC adaptor)	2	Unshielded
⑤	DC cable (AC adaptor)	1.4	Unshielded
⑥	AC cable (AC adaptor)	1.9	Unshielded

Appendix 1-4: Photograph of SAR test setup

Position	Setup photographs		
Front (Patient side) (antenna #0 side) (Touch)			
			
Short-side -ant#0 (antenna#0 side) (Touch)			
			
			<p><i>(no photograph)</i></p>

Appendix 1-4: Photograph of SAR test setup (cont'd)

Position	Setup photographs		
Front (Patient side) (antenna #1 side) (Touch)			
Long-side -ant#1 (antenna#1 side) (Touch)			