



RADIO TEST REPORT

Test Report No.: 11285933S-C-R1

Applicant : FUJIFILM Corporation
Type of Equipment : Flat Panel Sensor
Model No. : RIC 24C
* The test was performed with the built-in Wireless LAN Module: SX-PCEAN (FF-E).
FCC ID : W2Z-01000007
Test regulation : FCC Part 15 Subpart E: 2017 (DFS test only)
Test Result : Complied

1. This test report shall not be reproduced in full or partial, without the written approval of UL Japan, Inc.
2. The results in this report apply only to the sample tested.
3. This sample tested is in compliance with the limits of the above regulation.
4. The test results in this test report are traceable to the national or international standards.
5. This test report must not be used by the customer to claim product certification, approval, or endorsement by any agency of the Federal Government.
6. The opinions and the interpretations to the result of the description in this report are outside scopes where Japan has been accredited.
7. This test report covers Radio technical requirements. It does not cover administrative issues such as Manual or non-Radio test related Requirements. (if applicable)
8. This report is a revised version of 11285933S-C. 11285933S-C is replaced with this report.

Date of test : September 22, 2014

Representative test engineer:

J. Arai

Tatsuya Arai
Engineer
Consumer Technology Division

Approved by :

T. Imamura

Toyokazu Imamura
Leader
Consumer Technology Division



- The testing in which "Non-accreditation" is displayed is outside the accreditation scopes in UL Japan.
 There is no testing item of "Non-accreditation".

UL Japan, Inc.
Shonan EMC Lab.

1-22-3 Megumigaoka, Hiratsuka-shi, Kanagawa-ken, 259-1220 JAPAN
Telephone: +81 463 50 6400
Facsimile: +81 463 50 6401

CONTENTS	PAGE
SECTION 1: Customer information	4
SECTION 2: Equipment under test (E.U.T.)	4
SECTION 3: Scope of Report	6
SECTION 4: Test specification, procedures & results	6
SECTION 5: Operation of E.U.T. during testing.....	11
SECTION 6: In-Service Monitoring for Channel Move Time, Channel Closing Transmission Time	17
SECTION 7: In-Service Monitoring for Non-Occupancy Period	20
APPENDIX 1: Data of DFS test.....	22
APPENDIX 2: Test instruments	23
APPENDIX 3: Photographs of test setup.....	24

UL Japan, Inc.

Shonan EMC Lab.

1-22-3 Megumigaoka, Hiratsuka-shi, Kanagawa-ken, 259-1220 JAPAN

Telephone: +81 463 50 6400

Facsimile: +81 463 50 6401

SECTION 1: Customer information

Company Name : FUJIFILM Corporation
Address : 9-7-3 Akasaka, Minato-ku, Tokyo 107-0052 Japan
Telephone Number : +81-3-6271-1654
Facsimile Number : +81-3-6271-1189
Contact Person : Takao Ozaki

SECTION 2: Equipment under test (E.U.T.)

2.1 Identification of E.U.T.

Type of Equipment : Flat Panel Sensor
Model No. : RIC 24C
Serial No. : Refer to Section 4, Clause 4.2
Rating : DC 8 V
Receipt Date of Sample : September 9, 2014
Country of Mass-production : Taiwan
Condition of EUT : Engineering prototype
(Not for sale. This sample is equivalent to mass-production items.)
Modification of EUT : No Modification by the test lab.

UL Japan, Inc. Shonan EMC Lab.

1-22-3 Megumigaoka, Hiratsuka-shi, Kanagawa-ken, 259-1220 JAPAN
Telephone: +81 463 50 6400
Facsimile: +81 463 50 6401

2.2 Product description

Model: RIC 24C (referred to as the EUT in this report) is a Flat Panel Sensor.

During the test, the built-in radio module: SX-PCEAN(FF-E) was connected with the test system for the evaluation.

General Specification

Clock frequency(ies) in the system : 40 MHz

Radio Specification (Wireless LAN module, antenna)

Equipment type	Transceiver						
Model	SX-PCEAN(FF-E)						
Frequency band	2.4GHz band		5GHz band				
			-	U-NII-1 (W52)	U-NII-2A (W53)	U-NII-2C (W56)	U-NII-3 (W58)
Frequency of operation (MHz) (*.ch.: channel)	11b.g, n-20	2412-2462 (*.ch.1-11)	11a, n-20	5180-5240 (*.ch.36-48)	5260-5320 (*.ch.52-64)	5500-5580/5650-5700 (*.ch.100-116/132-140)	5745-5825 (*.ch.149-165)
	11n-40	2422-2452 (*.ch.3-9)	11n-40	5190-5230 (*.ch.38-46)	5270-5310 (*.ch.54-62)	5510,5550,5670 (*.ch.102,110,134)	5755, 5795 (*.ch.151,159)
Channel spacing (MHz)	5 (11b.g,n-20,n-40)		20 (11b.g,n-20) / 40 (11n-40)				
Bandwidth (MHz)	20 (11b.g,n-20) / 40 (11n-40)		20 (11b.g,n-20) / 40 (11n-40)				
Type of modulation	DSSS: DBPSK, DQPSK, CCK (11b), OFDM: BPSK, QPSK, 16QAM, 64QAM (11g,a,n-20,n-40)						
Transmit power (typical, maximum channel and data rate) and tolerance (as manufacture variation) (dBm) (*.ch.: channel)	11b	13.5 ±2.5 (*.ch.1-11, 1-11Mbps)	11a:	12.5±2.5 (*.ch.36-48, 6-54Mbps)	12.5±2.5 (*.ch.52-64, 6-54Mbps)	15.0±2.5 (*.ch.100-116/132-140, 6-48Mbps)	15.0±2.5 (*.ch.149-165, 6-48Mbps)
	11g	17.0 ±2.5 (*.ch.2, 6-36Mbps)					
	11n-20	14.5 ±2.5 (*.ch.2, MCS0-4/8-12)	11n-20	11.0±2.5 (*.ch.36-48, MCS0-6/8-14)	11.0±2.5 (*.ch.52-64, MCS0-6/8-14)	13.5±2.5 (*.ch.100-116/132-140, MCS0-4/8-12)	13.5±2.5 (*.ch.149-165, MCS0-4/8-12)
	11n-40	13.5 ±2.5 (*.ch.4, MCS0-4/8-12)	11n-40	11.0±2.5 (*.ch.46, MCS0-7/8-15)	11.0±2.5 (*.ch.54, MCS0-7/8-15)	11.0±2.5 (*.ch.102,110,134, MCS0-5/8-13)	11.0±2.5 (*.ch.151,159, MCS0-5/8-13)
* The value in a table shows the maximum power conditions of typical on each antenna. * 3dBm is added to MIMO power. * Refer to clause 2.3 for more detail. Refer to clause 2.4 for the maximum output power which may possible. * The measured Tx output power (conducted) refers to section 6 in this report.							
Power supply	DC 3.3V (*. DC3.3V is supplied from the main unit via constant voltage circuit.)						
Antenna	antenna #0 (Bottom, short-side-ant#0)			antenna #1 (Side, long-side-ant#1)			
Antenna quantity	2 pcs. (*. Separation distance between the antenna #0 and the antenna #1: approx.315 mm) 11b,g,a: One selected Tx antenna operation. 11n-20,n-40: One selected Tx antenna operation (MCS0~7) / Two Tx antenna operation (MCS8-13)						
Antenna model	113Y120216 (cable length: 300 mm)			113Y120216 (cable length: 300 mm)			
Antenna type / connector type	Monopole antenna / Connector; PCB side: U.FL, Antenna side: soldered						
Antenna gain (max.peak) (*.including cable loss)	-7.3 dBi (2.4GHz), -2.3 dBi (5GHz) (*.installed into the platform)			-6.5 dBi (2.4GHz), -0.3 dBi (5GHz) (*.installed into the platform)			

UL Japan, Inc. Shonan EMC Lab.

1-22-3 Megumigaoka, Hiratsuka-shi, Kanagawa-ken, 259-1220 JAPAN

Telephone: +81 463 50 6400

Facsimile: +81 463 50 6401

SECTION 3: Scope of Report

This report only covers DFS requirement, as specified by the following referenced procedures.

SECTION 4: Test specification, procedures & results

4.1 Test Specification

Test Specification : FCC Part 15 Subpart E
FCC Part 15 final revised on June 14, 2017 and effective July 14, 2017

Title : FCC 47CFR Part15 Radio Frequency Device
Subpart E Unlicensed National Information Infrastructure Devices
Section 15.407 General technical requirements

* All the revisions made after testing date do not affect the test specification applied to the EUT.

Test Specification : KDB905462 D02 UNII DFS Compliance Procedures New Rules v01r02 *1)
Title : COMPLIANCE MEASUREMENT PROCEDURES FOR UNLICENSED-
NATIONAL INFORMATION INFRASTRUCTURE DEVICES OPERATING IN
THE 5250-5350MHz AND 5470-5725MHz BANDS INCORPORATING
DYNAMIC FREQUENCY SELECTION

Test Specification : KDB905462 D03 Client Without DFS New Rules v01r02
Title : U-NII CLIENT DEVICES WITHOUT RADAR DETECTION CAPABILITY

*1) Although KDB 905462 D02 v01r02 was applied for the testing,
the latest version KDB 905462 D02 v02 is applicable.
The revision does not affect the test specification applied to the EUT.

FCC Part 15.31 (e)

The RF transmitter is constantly supplied voltage through the regulator regardless of input voltage. Therefore, the EUT complies with the requirement.

FCC Part 15.203

It is impossible for end users to replace the antenna, because the antenna is mounted inside of the product. Therefore, the EUT complies with the requirement.

4.2 Procedures and results

Table 1: Applicability of DFS Requirements

Requirement	Operating Mode	Test Procedures & Limits	Deviation	Results
	Client without Radar Detection			
U-NII Detection Bandwidth	Not required	KDB905462 D02 UNII DFS Compliance Procedures New Rules v01r02	N/A	N/A
Initial Channel Availability Check Time	Not required	FCC15.407 (h)	N/A	N/A
		KDB905462 D02 UNII DFS Compliance Procedures New Rules v01r02		
		RSS-247 6.3		
Radar Burst at the Beginning of the Channel Availability Check Time	Not required	FCC15.407 (h)	N/A	N/A
		KDB905462 D02 UNII DFS Compliance Procedures New Rules v01r02		
		RSS-247 6.3		
Radar Burst at the End of the Channel Availability Check Time	Not required	FCC15.407 (h)	N/A	N/A
		KDB905462 D02 UNII DFS Compliance Procedures New Rules v01r02		
		RSS-247 6.3		
In-Service Monitoring for Channel Move Time, Channel Closing Transmission Time	Yes	FCC15.407 (h)	N/A	Complied
		KDB905462 D02 UNII DFS Compliance Procedures New Rules v01r02		
		RSS-247 6.3		
In-Service Monitoring for Non-Occupancy period	Yes *	FCC15.407 (h)	N/A	Complied
		KDB905462 D02 UNII DFS Compliance Procedures New Rules v01r02		
		RSS-247 6.3		
Statistical Performance Check	Not required	FCC15.407 (h)	N/A	N/A
		KDB905462 D02 UNII DFS Compliance Procedures New Rules v01r02		

Note: UL Japan, Inc.'s EMI Work Procedures No. 13-EM-W0422.

*Although this test was not required in FCC, KDB 905462 D02, it was performed as additional test.

The test procedures and specifications in this report have not changed in FCC Part 15 Subpart E. Therefore, the test data obtained are still adequate to demonstrate compliance with current applicable FCC regulation. The EUT does not have hardware and / or software change since 2014.

UL Japan, Inc. Shonan EMC Lab.

1-22-3 Megumigaoka, Hiratsuka-shi, Kanagawa-ken, 259-1220 JAPAN
Telephone: +81 463 50 6400
Facsimile: +81 463 50 6401

Table 2 DFS Detection Thresholds for Master Devices and Client Devices With Radar Detection

Maximum Transmit Power	Value (See Notes 1,2, and 3)
≥ 200 milliwatt	-64 dBm
< 200 milliwatt and power spectral density < 10dBm/MHz	-62 dBm
< 200 milliwatt that do not meet the power spectral density requirement	-64 dBm
<p>Note 1: This is the level at the input of the receiver assuming a 0 dBi receive antenna. Note 2: Throughout these test procedures an additional 1 dB has been added to the amplitude of the test transmission waveforms to account for variations in measurement equipment. This will ensure that the test signal is at or above the detection threshold level to trigger a DFS response. Note 3: EIRP is based on the highest antenna gain. For MIMO devices refer to KDB Publication 662911 D01.</p>	

Table 3 DFS Response Requirement Values

Parameter	Value
Non-occupancy period	Minimum 30 minutes
Channel Availability Check Time	60 seconds
Channel Move Time	10 seconds See Note 1
Channel Closing Transmission Time	200 milliseconds + an aggregate of 60 milliseconds over remaining 10 second period. See Notes 1 and 2
U-NII Detection Bandwidth	Minimum 100 % of the U-NII 99 % transmission power bandwidth See Note 3
<p>Note 1: Channel Move Time and the Channel Closing Transmission Time should be performed with Radar Type 0. The measurement timing begins at the end of the Radar Type 0 burst. Note 2: The Channel Closing Transmission Time is comprised of 200 milliseconds starting at the beginning of the Channel Move Time plus any additional intermittent control signals required to facilitate a Channel move (an aggregate of 60 milliseconds) during the remainder of the 10 second period. The aggregate duration of control signal will not count quiet periods in between transmissions. Note 3: During the U-NII Detection Bandwidth detection test, radar type 0 should be used. For each frequency step the minimum percentage of detection is 90 percent. Measurements are performed with no data traffic.</p>	

Table 4 Short Pulse Radar Test Waveform

Radar Type	Pulse Width (μsec)	PRI (μsec)	Number of Pulses	Minimum Percentage of Successful Detection	Minimum Number of Trials
0	1	1428	18	See Note 1	See Note 1
1	1	Test A: 15 unique PRI values randomly selected from the list of 23 PRI values in Table 5a	Roundup $\{(1/360) * (19 * 10^6 / \text{PRI}_{\mu\text{sec}})\}$	60 %	30
		Test B: 15 unique PRI values randomly selected within the range of 518-3066 μsec, with a minimum increment of 1 μsec, excluding PRI values selected in Test A			
2	1-5	150-230	23-29	60 %	30
3	6-10	200-500	16-18	60 %	30
4	11-20	200-500	12-16	60 %	30
Aggregate (Rader Types 1-4)				80 %	120
Note 1: Short Pulse Radar Type 0 should be used for the detection bandwidth test, channel move time, and channel closing time tests.					

Table 5 Long Pulse Radar Test Waveform

Radar Type	Pulse Width (μsec)	Chip Width (MHz)	PRI (μsec)	Number of Pulses per Burst	Number of Burst	Minimum Percentage of Successful Detection	Minimum Number of Trials
5	50-100	5 - 20	1000-2000	1-3	8-20	80 %	30

Table 6 Frequency Hopping Radar Test Waveform

Radar Type	Pulse Width (μsec)	PRI (μsec)	Pulse per Hop (kHz)	Hopping Rate (kHz)	Hopping Sequence Length (msec)	Minimum Percentage of Successful Detection	Minimum Number of Trials
6	1	333	9	0.333	300	70 %	30

UL Japan, Inc.
Shonan EMC Lab.

1-22-3 Megumigaoka, Hiratsuka-shi, Kanagawa-ken, 259-1220 JAPAN
Telephone: +81 463 50 6400
Facsimile: +81 463 50 6401

4.3 Test Location

UL Japan, Inc. Shonan EMC Lab.
1-22-3, Megumigaoka, Hiratsuka-shi, Kanagawa-ken 259-1220 JAPAN
Telephone number : +81 463 50 6400
Facsimile number : +81 463 50 6401

	IC Registration No.	Width x Depth x Height (m)	Size of reference ground plane (m) / horizontal conducting plane	Maximum measurement distance
<input type="checkbox"/> No.1 Semi-anechoic chamber	2973D-1	20.6 x 11.3 x 7.65	20.6 x 11.3	10 m
<input type="checkbox"/> No.2 Semi-anechoic chamber	2973D-2	20.6 x 11.3 x 7.65	20.6 x 11.3	10 m
<input type="checkbox"/> No.3 Semi-anechoic chamber	2973D-3	12.7 x 7.7 x 5.35	12.7 x 7.7	5 m
<input type="checkbox"/> No.4 Semi-anechoic chamber	-	8.1 x 5.1 x 3.55	8.1 x 5.1	-
<input type="checkbox"/> No.1 Shielded room	-	6.8 x 4.1 x 2.7	6.8 x 4.1	-
<input type="checkbox"/> No.2 Shielded room	-	6.8 x 4.1 x 2.7	6.8 x 4.1	-
<input type="checkbox"/> No.3 Shielded room	-	6.3 x 4.7 x 2.7	6.3 x 4.7	-
<input type="checkbox"/> No.4 Shielded room	-	4.4 x 4.7 x 2.7	4.4 x 4.7	-
<input checked="" type="checkbox"/> No.5 Shielded room	-	7.8 x 6.4 x 2.7	7.8 x 6.4	-
<input type="checkbox"/> No.6 Shielded room	-	7.8 x 6.4 x 2.7	7.8 x 6.4	-
<input type="checkbox"/> No.1 Measurement room	-	2.55 x 4.1 x 2.5	-	-

4.4 Uncertainty

The following uncertainties have been calculated to provide a confidence level of 95 % using a coverage factor $k=2$.

Time Measurement uncertainty for this test was: (\pm) 0.012 %

4.5 Test set up, Data of DFS test, and Test instruments

Refer to APPENDIX.

SECTION 5: Operation of E.U.T. during testing

5.1 Operating Modes

The EUT, which is a Client Device without Radar detection capability, operates over the 5260-5320MHz and 5500-5700MHz.

WLAN traffic is generated by the software to ping from the Master to the Client. That software has random ping intervals. (Channel loading was over 17 %)

Software name & version: ExPing Version 1.33

The EUT utilizes the 802.11a and 802.11n architecture, with a nominal channel bandwidth.

The EUT had used IEEE 802.11n-40 (widest mode) .

The FCC ID for the Master Device used with EUT for DFS testing is LDK102073.

The rated output power of the Master unit is >200mW(23dBm). Therefore the required interference threshold level is –64 dBm. After correction for antenna gain and procedural adjustments, the required conducted threshold at the antenna port is $-64 + 1 + 3.5 = -59.5$ dBm (threshold level + additional 1dB + antenna gain).

It is impossible for users to change DFS control, because the DFS function is written on the firmware and users cannot access it.

5.2 Configuration and peripherals

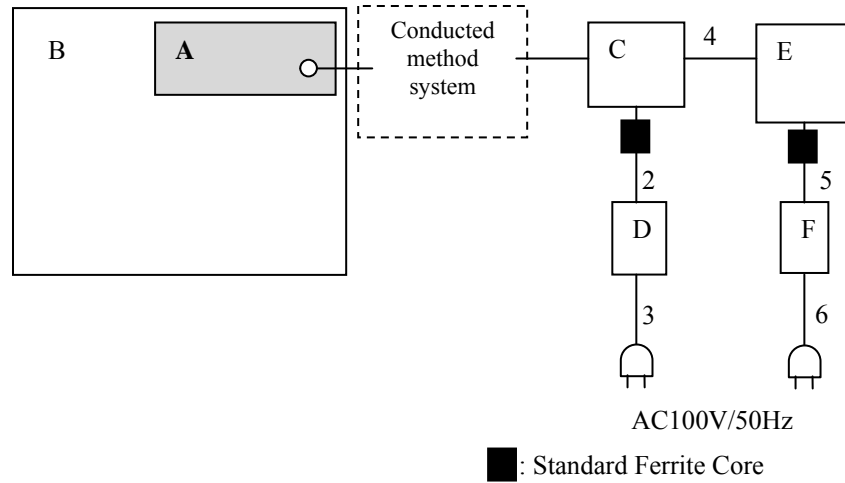

Description of EUT and Support equipment

No.	Item	Model number	Serial number	Manufacturer	Remarks
A	Wireless LAN Module	SX-PCEAN(FF-E)	00809261B110	Silex	EUT *2)
B	Flat Panel Sensor	DR-ID 613SE *1)	E321154	Fujifilm	-
C	Wireless LAN access point (Master Device)	AIR-API262N-A-K9	FTX1619E5EZ	Cisco Systems	FCC ID: LDK102073
D	AC Adapter	EADP-18MB	DAB1528MANP	Cisco Systems	-
E	Notebook Computer	DELL Vostro V1510	29090510205	Dell	-
F	AC Adaptor	LA65NS1-00	71615-93B-385D	Dell	-

*1) It was used to operate the Wireless LAN module.

*2) Built-in radio module of the Flat Panel Sensor RIC 24C is SX-PCEAN(FF-E).

List of cables used

No.	Cable Name	Length (m)	Shield	
			Cable	Connector
2	Access Point DC Power	1.8	Unshielded	Unshielded
3	Access Point AC Power	2.0	Unshielded	Unshielded
4	LAN	3.0	Unshielded	Unshielded
5	DELL PC DC Power	1.8	Unshielded	Unshielded
6	DELL PC AC Power	0.7	Unshielded	Unshielded

UL Japan, Inc. Shonan EMC Lab.

1-22-3 Megumigaoka, Hiratsuka-shi, Kanagawa-ken, 259-1220 JAPAN

Telephone: +81 463 50 6400

Facsimile: +81 463 50 6401

5.3 Test and Measurement System

SYSTEM OVERVIEW

The measurement system is based on a conducted test method.

The software selects waveform parameters from within the bounds of the signal type on a random basis using uniform distribution. The short pulse types 2, 3, and 4, the long pulse type 5, and the frequency hopping type 6 parameters are randomized at run-time.

The signal monitoring equipment consists of a spectrum analyzer with the capacity to display 8001 bins on the horizontal axis. A time-domain resolution of 2 msec/bin is achievable with a 16 second sweep time, meeting the 10 seconds short pulse reporting criteria. The aggregate ON time is calculated by multiplying the number of bins above a threshold during a particular observation period by the dwell time per bin, with the analyzer set to peak detection. A time-domain resolution of 3 msec/bin is achievable with a 24 second sweep time, meeting the 22 second long pulse reporting criteria and allowing a minimum of 10 seconds after the end of the long pulse waveform.

FREQUENCY HOPPING RADAR WAVEFORM GENERATING SUBSYSTEM

The first 100 frequencies are selected out of the hopping sequence of the randomized 475 hop frequencies. Only a *Burst* that has the frequency falling within the receiver bandwidth of the tested U-NII device is selected among those frequencies. (Frequency-domain simulation). The radar waveform generated at the start time of the selected *Burst* (Time-domain simulation) is download to the Signal Generator. If all of the randomly selected 100 frequencies do not fall within the receiver bandwidth of the U-NII device, the radar waveform is not used for the test.

CONDUCTED METHODS SYSTEM BLOCK DIAGRAM

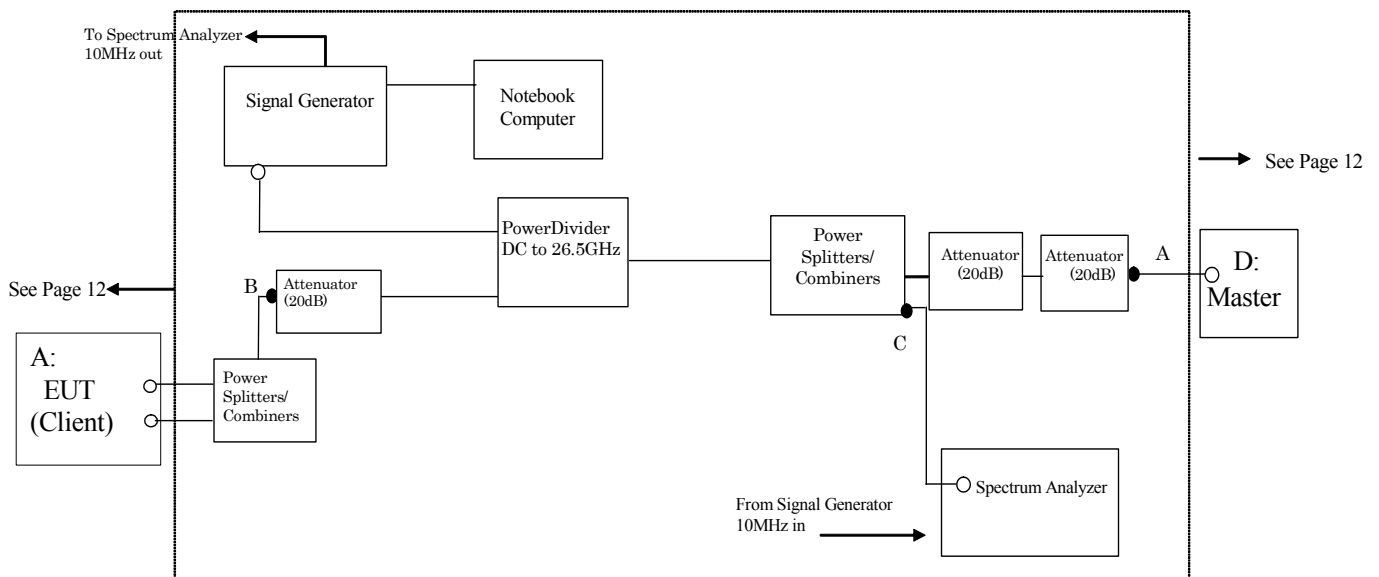

MEASUREMENT SYSTEM FREQUENCY REFERENCE

Lock the signal generator and the spectrum analyzer to the same reference sources as follows: Connect the 10MHz OUT on the signal generator to the 10MHz IN on the spectrum analyzer and set the spectrum analyzer 10MHz In to On.

UL Japan, Inc.
Shonan EMC Lab.

1-22-3 Megumigaoka, Hiratsuka-shi, Kanagawa-ken, 259-1220 JAPAN
Telephone: +81 463 50 6400
Facsimile: +81 463 50 6401

SYSTEM CALIBRATION

Step 1: Set the system as shown in Figure 3 of FCC, KDB 905462 Section 7.2.2.

Step 2: Adjust each attenuator to fulfill the following three conditions:

- WLAN can be communicated, and
- Rader detection threshold level is bigger than Client Device traffic level on the spectrum analyzer, and
- Master Device traffic level is not displayed on the spectrum analyzer.

Step 3: Terminate 50 ohm at B and C points, and connect the spectrum analyzer to the point A.
(See the figure on page 13)

At the point A, adjust the signal generator and spectrum analyzer to the center frequency of the channel to be measured. Download the applicable radar waveforms to the signal generator. Select the radar waveform, trigger a burst manually and measure the amplitude on the spectrum analyzer. Readjust the amplitude of the signal generator as required so that the peak level of the waveform is at a displayed level equal to the required or desired interference detection threshold. Separate signal generator amplitude settings are determined as required for each radar type.

Step 4: Without changing any of the instrument settings, restore the system setting to Step 2 and adjust the Reference Level Offset of the spectrum analyzer to the level at Step 3.

By taking the above steps 1 to 4, the spectrum analyzer displays the level of the signal generator as received at the antenna ports of the Master Device.

See Clause 5.4 for Plots of Noise, Rader Waveforms, and WLAN signals.

5.4 Plots of Noise, Rader Waveforms, and WLAN signals

Plots of System Noise Floor (for 11n-40, 5310 MHz)

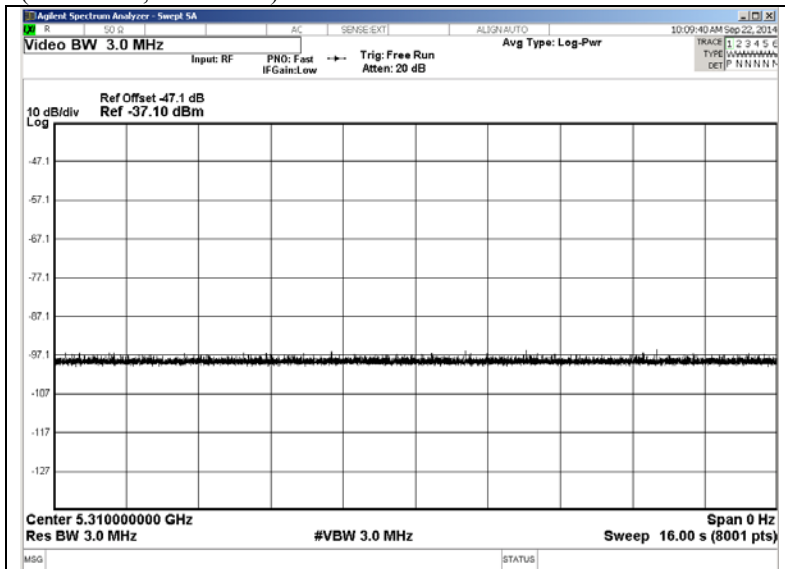

It was confirmed that the EUT did not transmit before having received appropriate control signals from a Master Device.

UL Japan, Inc. Shonan EMC Lab.

1-22-3 Megumigaoka, Hiratsuka-shi, Kanagawa-ken, 259-1220 JAPAN
Telephone: +81 463 50 6400
Facsimile: +81 463 50 6401

Plots of Radar Waveforms

(for 11n-40, 5310 MHz)

Rader Type 0

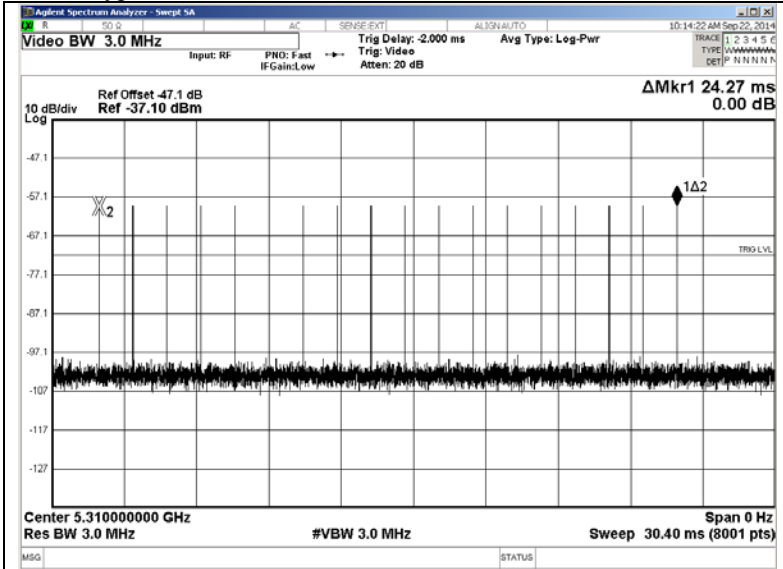

(for 11n-40, 5310 MHz)

Rader Type 5

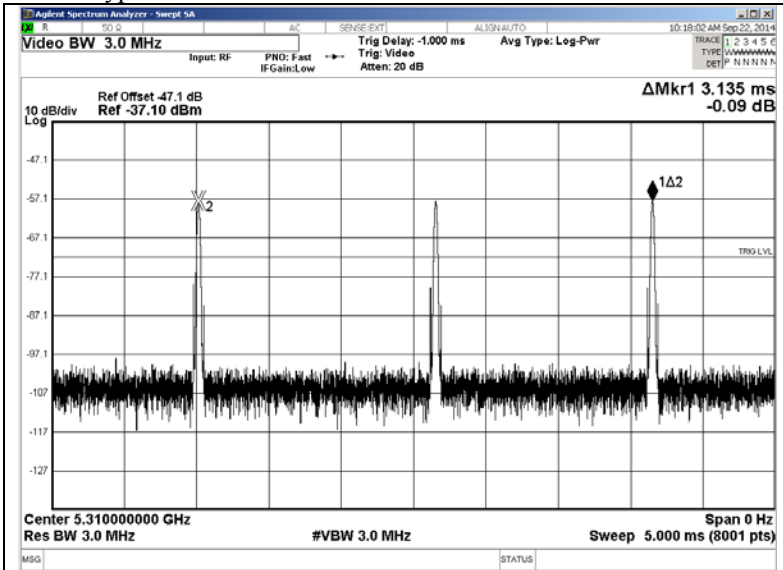

(for 11n-40, 5310 MHz)

Plots of WLAN Traffic (traffic about 30 %)

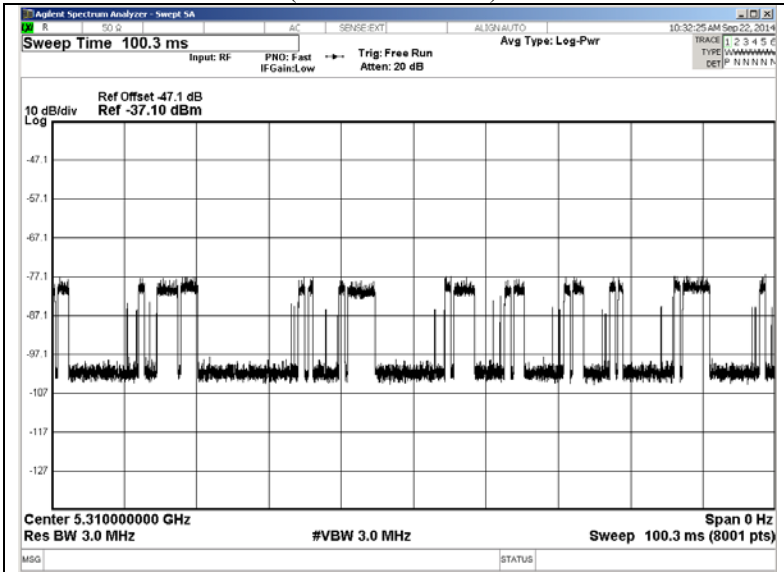

UL Japan, Inc.
Shonan EMC Lab.

1-22-3 Megumigaoka, Hiratsuka-shi, Kanagawa-ken, 259-1220 JAPAN

Telephone: +81 463 50 6400

Facsimile: +81 463 50 6401

SECTION 6: In-Service Monitoring for Channel Move Time, Channel Closing Transmission Time

6.1 Operating environment

Test place : No.5 Shielded Room
Temperature : 26 deg.C
Humidity : 43 %RH

6.2 Test Procedure

Transfer files from the Master Device to the Client Device on the tested channel during the entire period of the test. The Radar Waveform generator sends a Burst of pulses for one of the Short Pulse Radar Types 0-4 at levels defined , on the Operating Channel. An additional 1 dB is added to the radar test signal to ensure it is at or above the DFS Detection Threshold, accounting for equipment variations/errors.

Observe the transmissions of the EUT at the end of the radar Burst on the Operating Channel for duration greater than 10 seconds.

6.3 Test data

(for 11n-40, 5310 MHz)

Test Item	Unit	Measurement Time	Limit	Results
Channel Move Time *1)	[s]	1.790	10.000	Pass
Channel Closing Transmission Time *2)	[ms]	20	60	Pass

*1) Channel Move Time is calculated as follows:

$$(\text{Channel Move Time}) = (\text{End of Transmission}) - (\text{End of Burst}) = 2.976 - 1.186$$

*2) Channel Closing Transmission Time is calculated from (End of Burst + 200 [ms]) to (End of Burst + 10 [s])

$$(\text{Channel Closing Transmission Time}) = (\text{Number of analyzer bins showing transmission}) * (\text{dwell time per bin}) \\ = 10 \times 2 \text{ [ms]}$$

(for 11n-40, 5310 MHz)

Radar Type 0

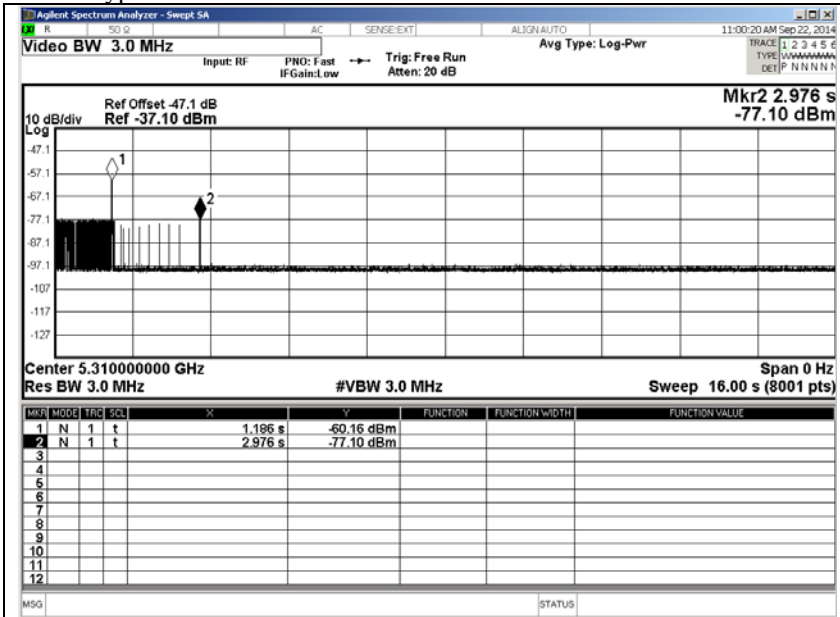

Marker 1: - End of Burst : 1.186 s
Marker 2: - End of Transmission : 2.976 s

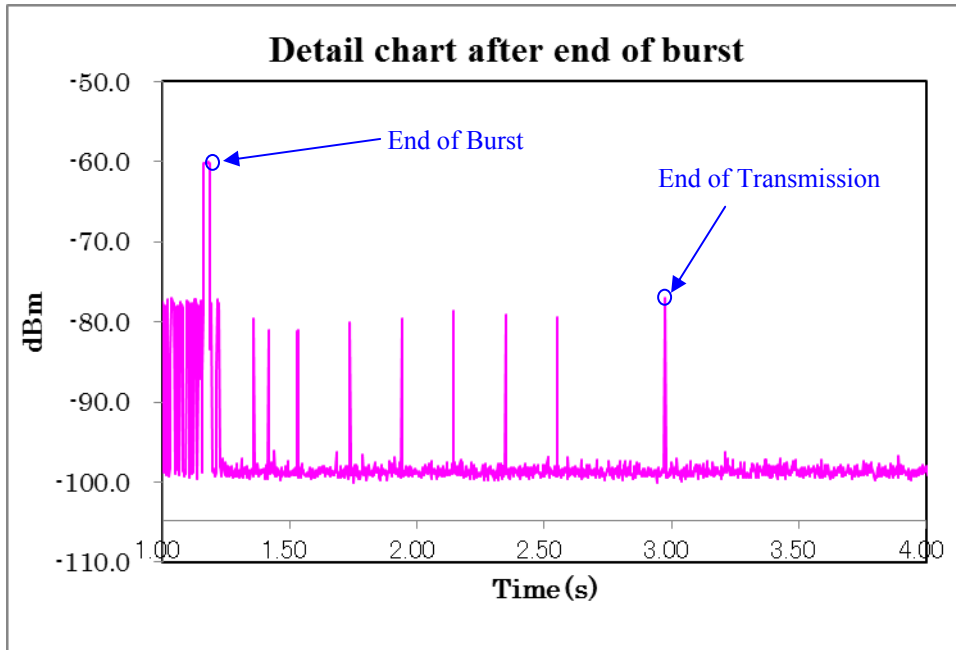

UL Japan, Inc.
Shonan EMC Lab.

1-22-3 Megumigaoka, Hiratsuka-shi, Kanagawa-ken, 259-1220 JAPAN
Telephone: +81 463 50 6400
Facsimile: +81 463 50 6401

(for 11n-40, 5310 MHz)

Radar Type 5

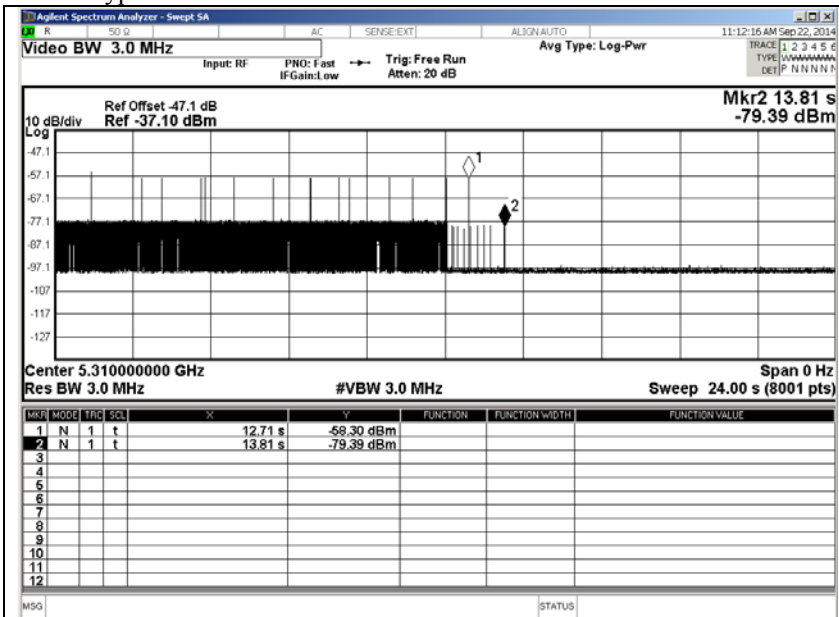

Marker 1 : End of Burst : 12710 ms
Marker 2 : End of Transmission : 13810 ms

6.4 Test result

Test result: Pass

Date : September 22, 2014

Test engineer : Tatsuya Arai

SECTION 7: In-Service Monitoring for Non-Occupancy Period

7.1 Operating environment

Test place : No.5 Shielded Room
Temperature : 26 deg.C
Humidity : 43 %RH

7.2 Test Procedure

The following two tests are performed:

- 1). Transfer files from the Master Device to the Client Device on the tested channel during the entire period of the test. The Radar Waveform generator sends a Burst of pulses for one of the Radar Types 0-6 at levels defined on the Operating Channel. An additional 1 dB is added to the radar test signal to ensure it is at or above the DFS Detection Threshold, accounting for equipment variations/errors. Observe the transmissions of the EUT after the Channel Move Time on the Operating Channel for duration greater than 30 minutes.
- 2). Transfer files from the Master Device to the Client Device on the tested channel during the entire period of the test. Observe the transmissions of the EUT on the Operating Channel for duration greater than 30 minutes after the Master Device is shut off.

7.3 Test data

(for 11n-40, 5310 MHz)

1).Radar Type 0

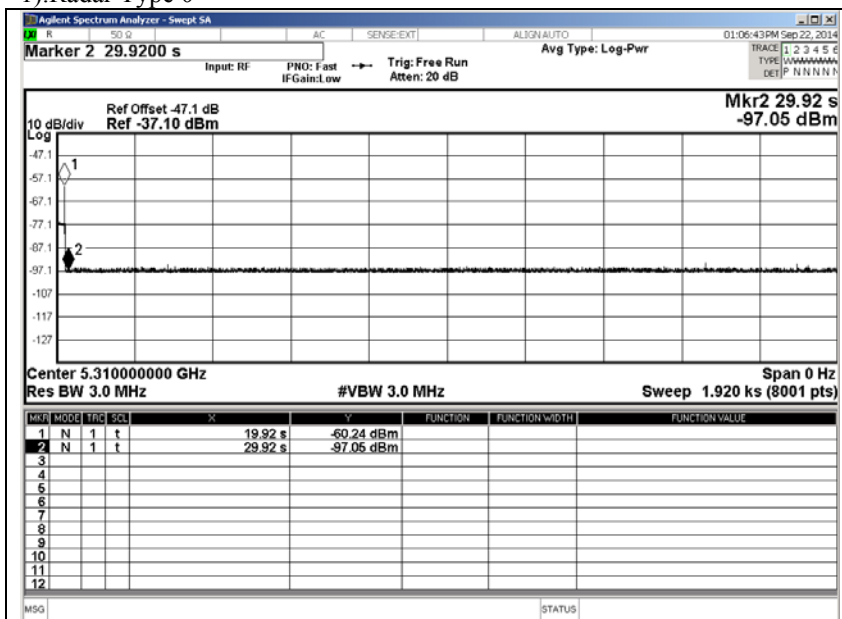

Marker 1 : End of Burst : 19.92 s
Marker 2 : End of Burst +10 s : 29.92 s

UL Japan, Inc.
Shonan EMC Lab.

1-22-3 Megumigaoka, Hiratsuka-shi, Kanagawa-ken, 259-1220 JAPAN
Telephone: +81 463 50 6400
Facsimile: +81 463 50 6401

2).Master is shut off
(for 11n-40, 5310 MHz)

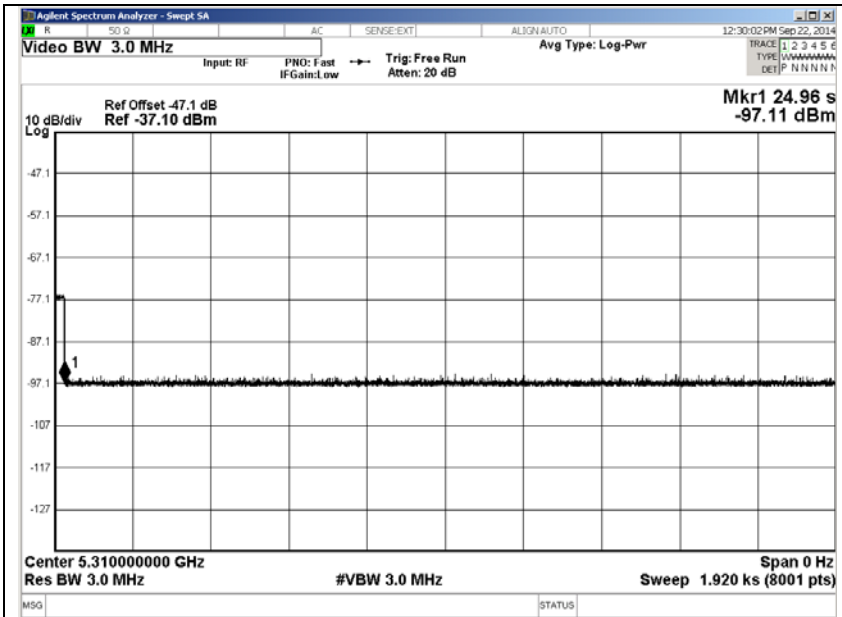

Marker 1 : End of transmission : 24.96 s

7.4 Test result

Test result: Pass

Date : September 22, 2014

Test engineer : Tatsuya Arai

APPENDIX 1: Data of DFS test

Parameter Data for Radar Type 5

Trial Number	Burst	Number of Pulses	Pulse Width (usec)	Chirp Width (MHz)	Pulse 1-to-2 Spacing (usec)	Pulse 2-to-3 Spacing (usec)	Starting Location Within Interval (usec)
1	1	1	52	8			64
1	2	2	94	7	1535		680793
1	3	3	67	8	1851	1146	452538
1	4	1	50	18			791967
1	5	3	82	14	1511	1064	61930
1	6	2	98	12	1125		95345
1	7	1	76	6			434356
1	8	1	64	16			720311
1	9	1	79	13			728383
1	10	1	61	15			194181
1	11	3	73	16	1638	1497	569650
1	12	2	95	11	1811		434312
1	13	2	50	19	1491		613325
1	14	3	58	13	1254	1098	431579

APPENDIX 2: Test instruments

EMI Test Equipment

Control No.	Instrument	Manufacturer	Model No	Serial No	Test Item	Calibration Date * Interval(month)
SSG-01	Signal Generator	Agilent	E4438C	MY47271584	DFS	2014/03/03 * 12
SSA-01	Spectrum Analyzer	Agilent	N9010A-526	MY48031482	DFS	2014/04/07 * 12
SCC-G14	Coaxial Cable	Suhner	SUCOFLEX 102	31600/2	DFS	2014/03/13 * 12
SCC-G32	Coaxial Cable	Junkosha	MWX241-02000KM SKMS	OCT-09-13-00 5	DFS	2013/10/21 * 12
SCC-G28	Coaxial Cable	Junkosha	MWX241-01000KM SKMS	SEP-20-12-002	DFS	2014/09/16 * 12
SCC-G24	Coaxial Cable	Suhner	141PE	-	DFS	2014/07/10 * 12
SCC-G25	Coaxial Cable	Suhner	141PE	-	DFS	2014/07/10 * 12
SCC-G26	Coaxial Cable	Suhner	141PE	-	DFS	2014/07/10 * 12
SPD-01	Power Divider	Agilent	11636B	56998	DFS	2014/04/22 * 12
SPSC-02	Power Splitters/Combiners	Mini-Circuits	ZFSC-2-10G+	-	DFS	2014/04/22 * 12
SPSC-03	Power Splitters/Combiners	Mini-Circuits	ZFSC-2-10G+	-	DFS	2014/04/22 * 12
SPSC-04	Power Splitters/Combiners	Mini-Circuits	ZN4PD1-63-S+	-	DFS	2014/07/31 * 12
SAT20-03	Attenuator	Agilent	8493C-020	74891	DFS	2014/03/13 * 12
SAT20-06	Attenuator	Weinschel Corp.	54A-20	31506	DFS	2014/04/22 * 12
SAT20-07	Attenuator	Weinschel Corp.	54A-20	31484	DFS	2014/04/22 * 12
STM-G3	Terminator	Weinschel	M1459A	U6569	DFS	2014/07/10 * 12
SOS-09	Humidity Indicator	A&D	AD-5681	4061484	DFS	2014/03/07 * 12

The expiration date of the calibration is the end of the expired month.

As for some calibrations performed after the tested dates, those test equipment have been controlled by means of an unbroken chains of calibrations.

All equipment is calibrated with valid calibrations. Each measurement data is traceable to the national or international standards.

Test Item:

DFS: Dynamic Frequency Selection

UL Japan, Inc.
Shonan EMC Lab.

1-22-3 Megumigaoka, Hiratsuka-shi, Kanagawa-ken, 259-1220 JAPAN

Telephone: +81 463 50 6400

Facsimile: +81 463 50 6401