

FUJIFILM

DIGITAL RADIOGRAPHY

FUJIFILM DR

FDR D-EVO
(DR-ID 600)

Operation Manual

11th Edition : April 2012

For Safe Operation

**System
Configuration
(Product Overview)**

Basic Operation

Troubleshooting

**Daily Inspection and
Maintenance**

Appendix

**Maintenance and
Inspection**

This Operation Manual describes details on how to operate the FDR D-EVO and cautions to be observed when operating it. Please read the Operation Manual thoroughly before actually operating the FDR D-EVO along with "DR-ID 300CL Operation Manual" and other manuals for the related products.

After reading this manual, store it nearby the FDR D-EVO so that you can see it whenever necessary.

FUJIFILM Corporation

Introduction

The Wired/Wireless FDR D-EVO (DR-ID 600) flat panel detector system is intended to capture for display radiographic images of human anatomy. It is intended for use in general projection radiographic applications wherever conventional film/screen or CR systems may be used. The FDR D-EVO (DR-ID 600) is not intended for mammography, fluoroscopy, tomography, and angiography applications.

This Operation Manual includes descriptions of matters necessary when using the FDR D-EVO, such as the equipment overview, operation procedures and precautions to observe, as well as daily inspections and maintenance.

Accompanying documents were originally drafted in the English language.

Installation may only be conducted by authorized service personal.



CAUTIONS

1. No part or all of this manual may be reproduced in any form without prior permission.
2. The information contained in this manual may be subject to change without prior notice.
3. FUJIFILM Corporation shall not be liable for malfunctions and damages resulting from installation, relocation, remodeling, maintenance, and repair performed by other than dealers specified by FUJIFILM Corporation.
4. FUJIFILM Corporation shall not be liable for malfunctions and damages of FUJIFILM Corporation products due to products of other manufacturers not supplied by FUJIFILM Corporation.
5. FUJIFILM Corporation shall not be liable for malfunctions and damages resulting from remodeling, maintenance, and repair using repair parts other than those specified by FUJIFILM Corporation.
6. FUJIFILM Corporation shall not be liable for malfunctions and damages resulting from negligence of precautions and operating methods contained in this manual.
7. FUJIFILM Corporation shall not be liable for malfunctions and damages resulting from use under environment conditions outside the range of using conditions for this product such as power supply, installation environment, etc. contained in this manual.
8. FUJIFILM Corporation shall not be liable for malfunctions and damages resulting from natural disasters such as fires, earthquakes, floods, lightning, etc.

This system is classified as a medical device under EC Directive 93/42/EEC.

Caution : Rx Only in the United States (Federal law restricts this device to sale by or on the order of a physician.)

Open-Source Software Used in This Product

This product uses third party's software that is made available as open source software or free software.

For information on open source software used in this product, please see the attached CD. Source codes for certain type of open source software used in this product are available at delivery cost. If you would like to receive such source codes, please contact FUJIFILM dealer or the service representatives at the agency from which you purchased this product. (Please be noted that any inquiries concerning the contents of source codes should be directed to original licensors of open source software.)

Note : FUJIFILM has successfully performed verification and validation testing on all third party software and has confirmed its suitability to be used in this system.

Trademarks

All company names and product names described in this manual are the trademarks or registered trademarks of FUJIFILM Corporation or their respective holders.

Windows is the registered trademark of US Microsoft Corporation in the U.S.A. and other countries.

Copyright © 2010-2012 FUJIFILM Corporation. All rights reserved.

FDR D-EVO System Operation Manuals

For the U.S.

For other countries

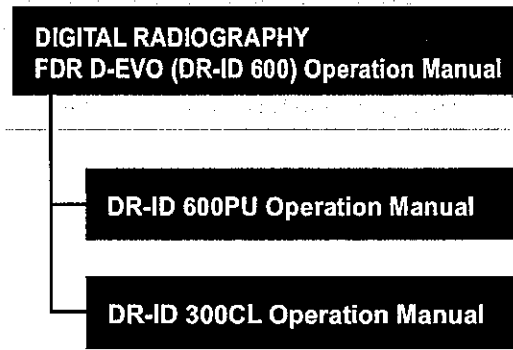
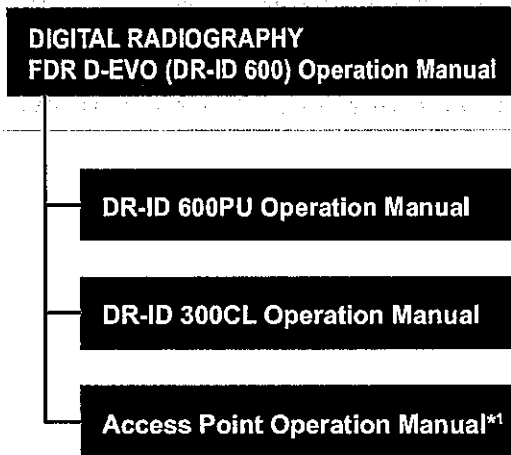

*1 See the operation manual for the designated access point.

- ① See "DR-ID 300CL Operation Manual" along with the manuals for the related products.
- ② The DR-ID 600MC runs on a commercially available personal computer. However, operations are not required to use the FDR D-EVO. For operations of a commercially available personal computer, see the operation manual provided by the manufacturer.

Manage and store all the Operation Manuals of the devices constituting the system together as a set.

For the U.S.

For other countries

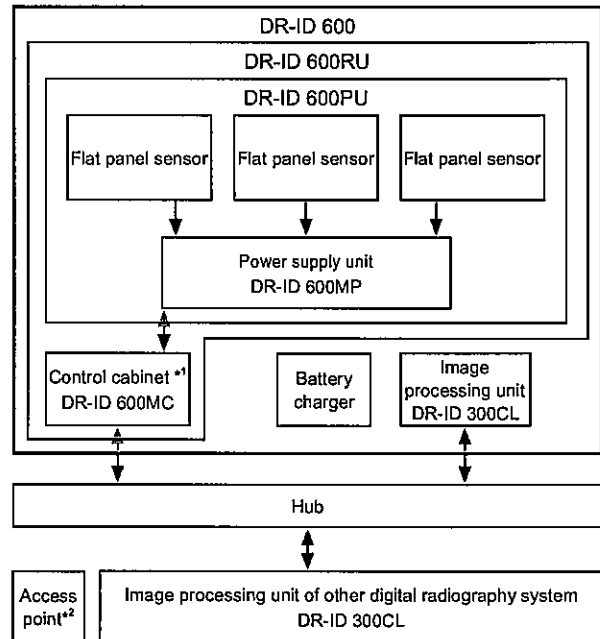
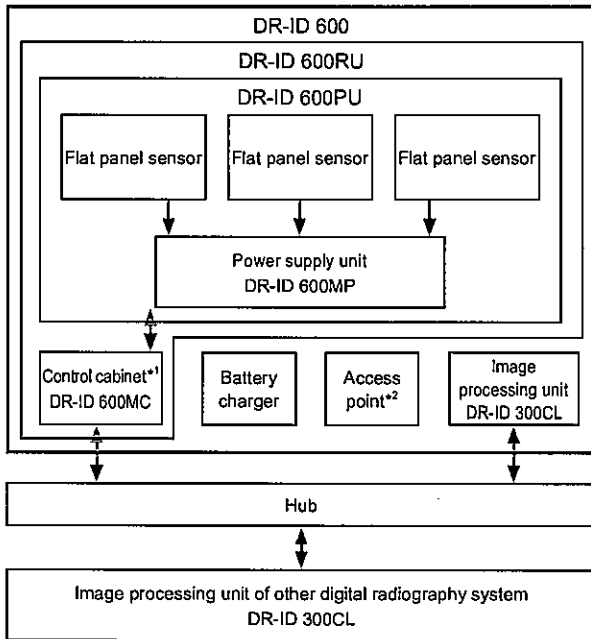

The configuration of the system varies depending on the country.

There are four types of flat panel sensors: DR-ID 601SE, DR-ID 602SE, DR-ID 611SE and DR-ID 613SE (wireless/wired communication mode) and DR-ID 600SE (wired communication mode). Although the contents of this manual are described by taking the example of DR-ID 601SE, the same can also be applied to other flat panel sensors. With regard to the description specific to a certain type of flat panel sensor, the product name is given in the description.

*1 Depending on the configuration, the control cabinet (DR-ID 600MC) may not be included in the system.

If not included, the control cabinet's software is installed on the image processing unit (DR-ID 300CL).

*2 With regard to the access point, consult our official dealer.

Contents at a Glance

Chapter 1 For Safe Operation
This chapter presents Warnings and Cautions we wish you to observe for safe operation of the FDR D-EVO.

Chapter 2 System Configuration (Product Overview)
This chapter gives the various unit names and describes their functions and features of the FDR D-EVO.

Chapter 3 Basic Operation
This chapter describes start-up, shut-down and other basic operations of the FDR D-EVO.

Chapter 4 Troubleshooting
This chapter describes how to troubleshoot in the event of an error on the FDR D-EVO, and provides explanations about a list of error messages each of which appears when an error occurs.

Chapter 5 Daily Inspection and Maintenance
This chapter describes daily care and maintenance we wish you to perform so that you can use the FDR D-EVO optimally.

Appendix
Appendix A Specifications
Appendix Z Precautions for Exposure
Appendix O Use of Optional Items

Maintenance and Inspection

Radio frequency (RF) compliance information

How to Read This Manual

Basic page layout

Please have a good grasp of the basic page configuration of this Operation Manual, as illustrated below, for you to use it more efficiently.

Section title

Shows the title of an operation procedure described in the section.

Lead

Describes information we wish you to know in advance of your operating the system or information that may help you to operate it.

The diagram illustrates a page from the manual with the following content and callouts:

- Section title:** 3.2 Starting Up and Shutting Down the System
- Lead:** This section explains how to start up and shut down the system. To start up the system, operations are required on the FDR D-EVO main unit and on the Console. To shut down the entire system, operations are required only on the Console.
- Section title:** 3.2.1 Starting Up the System
- Operation procedure:** A list of numbered steps:
 - 1 Press the ON side of the main switch of the power supply unit, if its power status LED is not lit.
 - 2 After confirming the following items, press the power switch for the Console to start the initialization process.
 - All cables should be connected properly.
 - No media should be inserted into the FDD.The control cabinet starts up automatically.
 - 3 Turn on the radiographic examination stand.
 - 4 The Patient Information Input Screen below appears following the opening screen on the Console monitor.
- Index:** Patient Information Input Screen
- Displayed screen:** A screenshot of the Patient Information Input Screen, which is currently blank.
- CAUTIONS:** Three caution boxes with warning symbols and text:
 - CAUTION: If the power status LED of the power supply unit does not come on after turning on the Console, turn on the control cabinet.
 - CAUTION: Do not press the ON side of the main switch of the power supply unit while pressing the optional remote switch. Otherwise, the settings may be initialized, and the system may be disabled.
 - CAUTION: An error occurs if the system is started up immediately after shutdown. To restart the system, make sure that the power status LED of the power supply unit is off, and then press the power switch for the Console.
 - CAUTION: Do not connect/disconnect the connector while the mark is displayed in the connected devices status after the system startup. Otherwise, the system does not start up normally, resulting in an error.
- Page number:** 3-7

Marks

Information items to be observed when you are operating this system and the supplementary remarks are described in this manual with the respective marks.

For the safe system operation, be sure to observe Warning/Caution.



WARNING

Indicates hazardous situations that may lead to serious injuries or even death if the precaution is not or cannot be followed.



CAUTIONS

Indicates hazardous situations that may lead to mild or moderate injury or physical damages if the caution is not or cannot be followed.



Indicates procedures requiring special attention, instructions that must be followed, supplementary explanations, etc.



HINT

Shows an item helpful for further effective system operation.



Shows a more detailed operation method or an item that describes additional information.

Expressions

Messages appear on the display panel and the buttons are shown as below.

- **Buttons (example)**

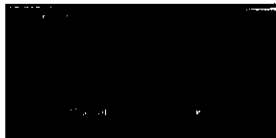

Select **OK**

The button to operate is shown.

Contents

Introduction.....	iii
FDR D-EVO System Operation Manuals	iv
Contents at a Glance.....	v
How to Read This Manual	vi

Chapter 1 For Safe Operation

1.1	Precautions Before Operating This Equipment.....	1-1
1.2	Precautions to be Observed When Using the Electric Medical Equipment.....	1-2
1.3	Safety	1-3
1.4	Electromagnetic Compatibility (EMC).....	1-10
1.4.1	DR-ID 600PU.....	1-10
1.4.2	DR-ID 600MC and DR-ID 300CL.....	1-15
1.5	Precautions in Using the FDR D-EVO.....	1-18
1.5.1	Handling.....	1-18
1.5.2	Before Exposure	1-19
1.5.3	During Exposure	1-20
1.5.4	During Cleaning	1-20
1.5.5	Storage	1-20
1.5.6	Precautions Related to the Load Applied to the Flat Panel Sensor.....	1-21
1.6	Locations of Labels and Signs	1-22
1.6.1	Locations of Labels.....	1-22
1.6.2	DR-ID 600.....	1-23
1.6.3	DR-ID 600PU.....	1-24
1.6.4	Safety and Other Symbols.....	1-26
1.7	Installation Conditions	1-27
1.7.1	Installation Space When Setting the Control Cabinet in the X-ray Room.....	1-27

Chapter 2 System Configuration (Product Overview)

2.1	FDR D-EVO.....	2-1
2.1.1	System Configuration	2-1
2.1.2	Features of the FDR D-EVO.....	2-2
2.2	Unit Names and the Functions.....	2-3
2.2.1	DR-ID 600.....	2-3
2.3	Console Display Configuration.....	2-5
2.4	Routine Operation Diagram.....	2-6
2.5	Wireless Specifications	2-7

Chapter 3 Basic Operation

3.1	Preparing the Flat Panel Sensor	3-1
3.1.1	Type of Flat Panel Sensor	3-1
3.1.2	Number of the Connectable Flat Panel Sensors	3-1
3.1.3	Connecting/Disconnecting the Flat Panel Sensor (DR-ID 601SE, DR-ID 602SE, DR-ID 611SE and DR-ID 613SE) Connector.....	3-2
3.1.4	Connecting/Disconnecting the Sensor Cable Relay Connector for the Flat Panel Sensor (DR-ID 600SE).....	3-3
3.1.5	Inserting/Removing the Flat Panel Sensor into/ from the Radiographic Examination Stand.....	3-4
3.1.6	Changing the Direction of the Flat Panel Sensor Connector.....	3-5

3.1.7	Charging the Battery Pack (Optional) for the Flat Panel Sensor (DR-ID 601SE, DR-ID 602SE, DR-ID 611SE and DR-ID 613SE)	3-6
3.1.8	Installing/Removing the Battery Pack (Optional) for the Flat Panel Sensor (DR-ID 601SE, DR-ID 602SE, DR-ID 611SE and DR-ID 613SE)	3-7
3.2	Starting Up and Shutting Down the System	3-8
3.2.1	Starting Up the System	3-8
3.2.2	Shutting Down the System	3-9
3.3	Routine Operations	3-10
Step 1	Entering the Patient Information	3-11
Step 2	Selecting the Anatomical Region and Exposure/Study Menu	3-12
Step 3	X-ray Exposure	3-14
[1]	Positioning the patient	3-14
[2]	X-ray exposure/Image displaying	3-15
[3]	Sleep mode	3-15

Chapter 4 Troubleshooting

4.1	When a Message Appears on the Console	4-1
[1]	If a warning dialog box appears	4-1
[2]	If a communication error occurs between the Console and the connected DR system	4-1
[3]	If Wireless Communication is Interrupted When Using the Flat Panel Sensor (DR-ID 601SE, DR-ID 602SE, DR-ID 611SE and DR-ID 613SE)	4-2
[4]	If an error occurs on the Console	4-2
[5]	If an error occurs on an output destination device	4-3
[6]	If the dialog box containing the error message numbered 13048 appears	4-3
4.2	How to Cope with an Error	4-4
[1]	When the system hangs up	4-4
[2]	When the Console is turned off due to an electrical outage	4-4
[3]	If a hard disk of the Console is damaged	4-5
[4]	If a white image is displayed after an exposure	4-5
[5]	Precautions for operation when the device status is "Initializing" or "Changing FPD" in the Console's "Output Device Status window"	4-5
[6]	If wireless communication with the flat panel sensor (DR-ID 601SE, DR-ID 602SE, DR-ID 611SE and DR-ID 613SE) is not possible	4-5
[7]	If wireless communication is interrupted when using the flat panel sensor (DR-ID 601SE, DR-ID 602SE, DR-ID 611SE and DR-ID 613SE)	4-5

Chapter 5 Daily Inspection and Maintenance

5.1	Daily User Inspection and Maintenance	5-1
5.1.1	Daily Inspection (DR-ID 600)	5-1
5.1.2	Periodical Inspection	5-2

Appendix A Specifications

A.1	Specifications	A-1
A.1.1	Processing Capacity (DR-ID 600)	A-1
A.1.2	Image Output (DR-ID 600)	A-1
A.1.3	Reduced Equivalent (DR-ID 600)	A-3
A.1.4	Power Supply Conditions	A-3
A.1.5	Environmental Conditions	A-3
A.2	External View and Weight	A-4
A.2.1	DR-ID 600	A-4

Appendix Z Precautions for Exposure

Z.1	Precautions for Exposure in AUTO MODE	Z-1
Z.1.1	Radiation Field	Z-1
Z.1.2	Depiction of the Cervical Region	Z-2

Z.1.3	Depiction of the HIP JOINT AXL – 2 Menu	Z-2
Z.1.4	EDR Image Data Analysis	Z-3
Z.2	Precautions for Exposure in SEMI-AUTO MODE	Z-4
Z.3	Precautions for Exposure in SEMI-X MODE	Z-5
Z.4	Precautions for Exposure in FIX MODE	Z-6
Z.5	Precautions for the Automatic X-ray Detection Function.....	Z-7
Z.5.1	Precautions for Making an Exposure.....	Z-7
Z.5.2	Precautions Related to the X-ray Exposure Time.....	Z-7
Z.6	Other Precautions	Z-8
Z.6.1	Precautions for Exposure of a Subject in Relatively Large Contrast	Z-8
Z.6.2	Precautions for DR System	Z-8
Z.6.3	Precautions for Assuring the Radiation Field.....	Z-8
Z.6.4	Images Output When the X-ray Shot Switch is Operated Incorrectly	Z-8
Z.6.5	Precautions for Urgent Use	Z-9
Z.6.6	Precautions Related to Continuous Operation	Z-9
Z.6.7	Precautions Related to Grid.....	Z-9
Z.6.8	Precautions for Connecting the DR-ID 320	Z-9
Z.6.9	Precautions during Calibration.....	Z-9
Z.6.10	Precautions for Exposing the Flat Panel Sensor to X-ray.....	Z-9

Appendix O Use of Optional Items

O.1	Optional Items	O-1
O.2	Using the Remote Switch	O-2
O.2.1	Remote Switch.....	O-2
O.2.2	Relay Cable	O-2
O.3	Using the SE Storage Case	O-3
O.4	Using the DAP Connector Cable.....	O-5
O.5	Using the Retaining Bracket for MP	O-6
O.6	Cradle.....	O-7

Maintenance and Inspection

Radio frequency (RF) compliance information

Compliance with Part 15 of FCC Rules and RSS-Gen of IC Rules

Compliance with 1999/5/EC

Compliance with Infocomm Development Authority of Singapore (Singapore)

Compliance with Telecommunications Regulatory Authority (UAE)

Compliance with NTC technical requirement (Thailand)

Radio Law Certification Labels

Rating Labels

Chapter 1 For Safe Operation

1.1 Precautions Before Operating This Equipment

Before using this equipment, please read "Precautions Before Operating This Equipment" carefully so that you can operate it correctly.

Whenever you operate this equipment, be sure to observe those precautions. Failure to do so may cause you to subject to injuries or property damage to occur.

The institution where the equipment is installed is responsible for its use and maintenance.
In addition, this equipment should not be used by persons other than doctors or suitably trained staff.

This system is classified as a medical device under EC Directive 93/42/EEC.
This equipment has been designed on the assumption that the patient would not come into direct contact with it or for operation by appropriately trained operator.

Process waste correctly, as stipulated by local law or any regulations that apply.

Part of the components contains harmful substances which may pollute the ambient environment if disposed carelessly. For details on product disposal, contact a FUJIFILM dealer.

1.2 Precautions to be Observed When Using the Electric Medical Equipment

We ask that you observe these usage precautions and use the equipment correctly.

1. This equipment should be used only by people who have the proper skills.
2. Observe the following precautions when installing the equipment.
 - 2-1. Install the equipment where water will not splash it.
 - 2-2. Install the equipment where it will not be adversely affected by air pressure, temperature, humidity, ventilation, sunlight, dust or the presence of salt, sulfur or like substances in the atmosphere.
 - 2-3. Make sure the equipment will remain in stable condition on a level surface and not be subjected to vibration or shock.
 - 2-4. Do not install the equipment in places where chemicals are stored or gases emitted.
 - 2-5. Make sure that the power frequency, voltage and power consumption are appropriate.
 - 2-6. Connect the ground wire correctly.
3. Observe the following precautions before beginning to use the device.
 - 3-1. Confirm that the ground wire has been completely connected.
 - 3-2. Make sure that all cords have been connected properly and safely.
 - 3-3. Be aware that correct diagnosis can be hindered and danger can result from using different pieces of equipment together.
 - 3-4. Make sure that the battery and power supply are installed properly.
4. Observe the following precautions when using the equipment.
 - 4-1. Make sure not to exceed the time and dose required for diagnosis.
 - 4-2. Always monitor the patient and the equipment for abnormalities.
 - 4-3. Take an appropriate action, such as stopping the equipment after ensuring the patient's safety, if any abnormalities are found in his/her health or in the equipment.
5. Observe the following precautions after using the equipment.
 - 5-1. Using the established procedure, then turn the power off.
 - 5-2. When unplugging cords, do not pull on the body of the cord itself or apply unnecessary force.
 - 5-3. Observe the following precautions when storing the equipment.
 - I Store the equipment where water will not splash it.
 - II Store the equipment where it will not be adversely affected by air pressure, temperature, humidity, ventilation, sunlight, dust or the presence of salt, sulfur or like substances in the atmosphere.
 - III Make sure the equipment will remain in stable condition on a level surface and not be subjected to vibration or shock.
 - IV Do not store the equipment in places where chemicals are stored or gases emitted.
 - 5-4. After using the accessories, recollect them and put them back in order.
 - 5-5. Make sure to clean the equipment for the next use.
6. If there is trouble with the equipment, do not attempt to fix it randomly. Instead, do what is indicated and entrust repairs to a professional.
7. Do not remodel the equipment.
8. Maintenance and Inspection
 - 8-1. Make inspect the equipment and parts periodically.
 - 8-2. If the equipment has not been used for a long time, make sure that it operates normally and safely prior to using it again.
9. Other Items
 - 9-1. When subjecting patients (particularly infants and pregnant women) to radiation, make sure not to exceed the necessary time and dose. Also, ensure that radiation is contained within the exposure plane of the flat panel sensor.
 - 9-2. Follow the Operation Manual and operate the equipment correctly.

1.3 Safety

Before using the FDR D-EVO, read this section thoroughly to ensure that you use the product properly.

Electric Shock Warnings and Cautions



WARNING

The power supply to the FDR D-EVO is AC100 to 240V.

To avoid electric shocks, users should always take the following precautions:

- Never open any covers of the equipment.
- Install the equipment in a location where it will not be exposed to water.
- Check that the equipment is securely earthed.
- Check that all of the cords and cables are completely and securely connected.
- Keep the image processing unit and the control cabinet out of reach of patients.



WARNING

Do not touch the patient's body while touching the control cabinet. Otherwise, the patient may receive an electric shock.



WARNING

Do not use a multiple tap connector or extension cable for powering the devices constituting the system. Otherwise, fire or electric shock may occur due to the electrical load exceeding the allowable limit.



WARNING

Observe the following precautions when using the cables.

- Turn off each unit before connecting/disconnecting the cable.
Do not touch the plug and connector with wet hands. Otherwise, electric shock may result, causing death or severe injury.
- Hold the plug or connector when removing the cable.
Pulling the cable or carrying by holding it may damage the cable, causing fire or electric shock.
- Do not damage or remodel the cable.
Do not place a heavy object on the cable or lay it under the flat panel sensor. Do not step on, pull, forcibly bend, or bundle the cable. Otherwise, fire or electric shock may result.
- Do not use the flat panel sensor for the radiographic examination stand if its cable becomes overloaded. Otherwise, the cable may be damaged, causing fire or electric shock.



WARNING

Do not turn on the system with dew condensation on the flat panel sensor. Otherwise, fire or electric shock may result.



WARNING

Do not use the equipment in a location where metal particles could come into the equipment. This may cause an electric shock.



WARNING

Do not disassemble or remodel the equipment. Otherwise, fire or electric shock may result. Keep away from the parts inside the product, which may cause electric shock. If you touch them accidentally, death or severe injury may result.



WARNING

Do not hit or drop the equipment or subject it to severe shock. Otherwise, the equipment may be damaged. If the damaged equipment is used, fire or electric shock may result.



WARNING

Before using the flat panel sensor (DR-ID 601SE, DR-ID 602SE, DR-ID 611SE and DR-ID 613SE), make sure that the battery cover or battery pack is attached. If not attached, an electric shock may result.



WARNING

Make sure to use the optional parts and accessories recommended by us. Failure to use the optional parts and accessories recommended by us may result in damage to the equipment and/or electric shock and injury.



CAUTIONS

As the cables of the equipment are long, be careful not to entangle the cables during use. Also, be careful not to trip over the cables. Falls could result in injury.



CAUTIONS

Follow the specified procedure when turning off the equipment. Otherwise, the flat panel sensor could be damaged by thermal shock.



CAUTIONS

Do not store magnetic media near the DR system and control cabinet. Otherwise, magnetism generated by the equipment may cause the data to be lost.



CAUTIONS

Keep the equipment away from patient's body fluids, chemicals, water, etc. Otherwise, it may become damaged, causing fire or electric shock. If necessary, protect the flat panel sensor by covering it with a disposable bag.

Explosion Warnings



WARNING

Because this equipment is not explosion-proof, do not use combustible and explosive gases near the equipment.



WARNING

Flammable gasses may stay in the room after disinfection. Ventilate the room well before powering on the system following disinfection.

Warnings for Abnormalities



WARNING

If any of the following occurs, immediately turn off the power of each unit, unplug the power cable from the outlet, and then contact a FUJIFILM dealer.

- When smoke, strange odor, or abnormal sound is present.
- When a foreign object (such as a metal object) or liquid enters the product.
- When the equipment is dropped or hit and is damaged.

Installation Precautions



CAUTIONS

Do not install the system in a location with the following conditions.

- Where the temperature changes sharply.
- Close to heat sources such as a heater.
- Where the system may be exposed to water due to water leakage or ingress.
- Where corrosive gas may be generated.
- Where there is excessive dust.
- Where the system is subject to frequent or excessive vibration/shock.
- Where the system is exposed to direct sunlight.
- Where there is no ventilator.



CAUTIONS

For veterinary or mobile applications, contact a FUJIFILM dealer.



CAUTIONS

Use the system indoor in wireless communication mode. For details, contact a FUJIFILM dealer.



CAUTIONS

Do not place any object in a place where removal of the power cable is prevented.

Connection Instructions



WARNING

Make sure that the devices to be connected to the equipment are authorized for connection.



WARNING

Connect the DR-ID 600PU only to the designated control cabinet (DR-ID 600MC). When the DR-ID 600PU is connected to X-ray equipment, make sure that the equipment complies with IEC 60601-1.

Precautions on External Network Connection



CAUTIONS

When a setting of the network to which the equipment is connected has been changed, check that the change does not affect the system operation and take measures if necessary.

The setting change may include the following:

- Change of connection destination
- Addition of devices
- Removal of devices
- Update of devices
- Upgrade of devices

System Isolation Instructions



WARNING

To ensure complete system isolation, never install any unauthorized accessories or other such items. When it is necessary to install authorized accessories or optional items, contact a FUJIFILM dealer.



WARNING

Keep equipment other than those used for patients out of their reach to ensure appropriate system isolation.



WARNING

Do not move the Console from where it is installed.



WARNING

In normal use, have a patient take a proper positioning for exposure. The operator should operate the system in a place where safety from radiation is ensured. The operator should also make sure before exposure that no one but the patient is in the exposure area and the operating area of the system.

Software Precautions



CAUTIONS

Do not install additional software to the system. Do not uninstall any of the software preinstalled in the system.

The system is preinstalled with the appropriate software. If other software is installed or if the existing software is uninstalled, various operational errors may result.

Disinfection Instructions



WARNING

Confirm that the respiratory density of disinfectant including solvent is under legal regulation. Certain disinfectants may damage health. When using a disinfectant, follow instructions supplied by the manufacturers.



WARNING

Do not use the following disinfectants or sterilizers at the time of disinfection. Quality, performance and safety of the equipment cannot be assured.

- Chloric disinfectant which is strongly corrosive to metals and rubber parts.
- Disinfectant whose uses on metals, plastics, and coating are forbidden according to the instructions supplied with the disinfectant.
- Formalin gas and disinfectant sprays that may get inside the equipment.
- Ultraviolet sterilizers

Disinfectant ethanol is recommended for disinfection. Carefully read the instructions and cautions supplied with the disinfectant before use.

For details on the disinfectant, contact a FUJIFILM dealer or the service representatives at the agency from which you purchased the disinfectant.



CAUTIONS

Clean the sensor unit of the flat panel sensor with ethanol for disinfection, etc. for each patient to prevent infection.

Precautions for Charging the Battery



CAUTIONS

Observe the following precautions when charging the battery pack (optional) using the battery charger (optional).

- Do not use the battery pack (125N100050) or battery charger in combination with any battery pack or battery charger (including the AC adapter) other than those recommended by FUJIFILM Corporation.
- Do not disassemble or convert the battery pack or battery charger.
- If the battery pack or battery charger becomes faulty, consult our official dealer.
- Do not cover the holes in the battery charger with foreign matter.
- Avoid the accumulation of dust on the battery charger.
- Insert the battery pack into the battery charger securely.
- If the insertion direction or position of the battery pack is incorrect, the battery is not charged properly.
- When inserting the battery pack, prevent foreign matter from getting into the battery charger.
- While charging the battery, do not allow the battery pack or battery charger get wet or dusty.
- Do not step on the AC adapter of the battery charger. Also, be careful not to trip over the power cable.
- Do not subject the battery and battery charger to severe shock (by dropping them, etc.).
- Do not place the battery charger within the reach of patients.
- Do not charge the battery pack near fire or under strong sunshine. If the built-in protection mechanisms are activated by a high temperature, the battery pack cannot be charged. Also, if the built-in protection mechanisms are damaged, the battery pack may be charged with extremely high current and voltage, and abnormal chemical reactions may occur inside the battery pack, causing it to overheat, emit smoke, explode or ignite.
- To charge the battery pack, be sure to use the designated battery charger and to observe the charging conditions specified by FUJIFILM Corporation. If the battery pack is charged in other conditions (temperature or voltage/current higher than specified, remodeled battery charger, etc.), the battery pack may be overcharged or charged with extremely high current, and abnormal chemical reactions may occur inside the battery pack, causing it to overheat, emit smoke, explode or ignite.
- Immediately stop charging the battery pack, if charging is not completed within the specified time. Otherwise, the battery pack may overheat, emit smoke, explode or ignite.
- Do not use the flat panel sensor near the AC adapter.
- Do not use the broken battery charger.

Battery Pack (Optional) Precautions



CAUTIONS

Observe the following precautions when using the battery pack (optional).

- The battery pack (125N100050) is exclusively for the flat panel sensor (DR-ID 601SE, DR-ID 602SE, DR-ID 611SE and DR-ID 613SE). Do not use them in other combinations.
- Charge the battery pack only with the designated battery charger. If the battery pack is charged under the charging conditions (voltage, current and charging method) different from those specified by FUJIFILM Corporation, the battery pack may emit smoke, ignite, explode or leak fluid.
- When storing the battery pack for a long period, charge the battery fully, remove it from the flat panel sensor and then store it in a cool and dark place. Recharge the stored battery every six months or every year. Otherwise a decrease in battery capacity or other problems may result.
- Do not leave the removed battery pack in the car or other places exposed to high temperature. If the battery pack is used or stored in a place where it is exposed to high temperature, the battery pack may emit smoke, ignite, explode or leak fluid.
- Use or store the battery pack only in the environmental conditions specified by FUJIFILM Corporation. If the battery pack is used or stored in a place where it is exposed to high temperature, the battery pack may emit smoke, ignite, explode or leak fluid.
- When disposing of the battery pack, consult our official dealer.
- Do not disassemble or remodel the battery pack. The battery pack is equipped with built-in safety and protection mechanisms. If they are damaged, the battery pack may overheat, emit smoke, explode or ignite.
- Do not connect the positive (+) and negative (-) terminals with a wire or any metal object. Do not carry or store the battery pack together with metal objects such as necklaces or hairpins. Otherwise, the battery pack may short-circuit and overcurrent may flow, causing the battery pack to overheat, emit smoke, explode or ignite. Metal objects such as necklaces or hairpins may also become hot.
- Do not throw the battery pack into fire or expose it to excessive heat. Otherwise, its insulator may melt, its gas release vent or safety mechanisms may be damaged, and/or its electrolyte may catch fire, causing the battery pack to overheat, emit smoke, explode or ignite.
- Do not use or leave the battery pack in a place where it is exposed to high temperature (80°C or higher), such as fire or a heater. If the resin separator is damaged due to heat, the battery pack may short-circuit, causing it to overheat, emit smoke, explode or ignite.
- Do not immerse the battery pack in water or seawater, and do not allow it to become wet. If the built-in protection mechanisms are damaged, the battery pack may overheat, emit smoke, explode or ignite.
- Do not pierce the battery pack with a nail, hit it with a hammer, or step on it. Otherwise, the battery pack may be damaged or deformed and short-circuit, causing it to overheat, emit smoke, explode or ignite.
- Do not subject the battery pack to strong impact or throw it. If the built-in protection mechanisms are damaged, the battery pack may be charged with extremely high current and voltage, and abnormal chemical reactions may occur inside the battery pack, causing it to overheat, emit smoke, explode or ignite.
- Do not use an apparently damaged or deformed battery pack. Otherwise, the battery pack may overheat, emit smoke, explode or ignite.
- Do not solder the battery pack directly. Otherwise, its insulator may melt, or its gas release vent or safety mechanisms may be damaged, causing the battery pack to overheat, emit smoke, explode or ignite.
- Do not reverse the positive (+) and negative (-) terminals. Otherwise, the battery pack may be reverse-charged during charging. As a result, abnormal chemical reactions may occur inside the battery pack, or extremely high current may flow during discharging, causing it to overheat, emit smoke, explode or ignite.
- The battery pack has a predetermined polarity. If you cannot connect the battery pack to the battery charger or other equipment, do not connect the battery pack forcefully. Make sure that the terminals are correctly oriented. If the battery pack is connected in reverse, it will be reverse-charged, and abnormal chemical reactions may occur inside the battery pack, causing it to overheat, emit smoke, explode or ignite.

- Do not connect the battery pack to an electrical outlet or cigarette lighter socket in a car. Overcurrent may flow to the battery pack due to high voltage applied, causing the battery pack to overheat, emit smoke, explode or ignite.
- Do not use the battery pack for equipment other than those specified. Otherwise, the guaranteed performance will be reduced and/or the service life will be shortened. Depending on the equipment to which the battery pack is connected, extremely high current may flow, causing the battery pack to be damaged, overheat, emit smoke, explode or ignite.
- If the electrolyte leaked from the battery pack enters the eyes, do not rub them. Wash the eyes immediately with clean water such as tap water, and consult a doctor. Otherwise, eye injury may result.
- Do not use the battery pack in combination with a primary battery such as a dry battery or other battery of a different capacity, type and/or brand. Otherwise, the battery pack may be overcharged during charging, and abnormal chemical reactions may occur inside the battery pack, causing it to overheat, emit smoke, explode or ignite.
- Keep the equipment or battery pack out of the reach of small children to prevent them from accidentally swallowing the battery pack. If swallowed, consult a doctor immediately.
- Do not put the battery pack in a microwave oven or high-pressure container. Otherwise, the battery pack may be rapidly heated or damaged, causing it to overheat, emit smoke, explode or ignite.
- If the battery pack leaks or emits an unusual odor, remove it from fire immediately. Otherwise, the leaked electrolyte may catch fire, causing the battery pack to overheat, emit smoke, explode or ignite.
- If you notice an unusual odor, heat, discoloration, deformation or any other abnormality during use, charging or storage, remove the battery pack from the equipment or battery charger, and stop using it. Otherwise, the battery pack may overheat, emit smoke, explode or ignite.
- Do not use the battery pack exposed to a strong magnetic field of an MRI system, etc.
- Do not use the battery pack immersed in liquid.

Other Warnings and Cautions



WARNING

No modification of this equipment is allowed.



CAUTIONS

Install the system in accordance with what is provided by IEC60601-1-1. Contact a FUJIFILM dealer for installation and relocation (except the flat panel sensor) of the system.



CAUTIONS

Do not hit or drop the equipment. Otherwise, injury or damage to images, etc. may result.



CAUTIONS

Be sure to inspect the system periodically.
To assure optimum performance of the equipment, it is necessary to systematically perform maintenance and inspection. For information on maintenance and inspection, contact a FUJIFILM dealer.

Contraindications and Prohibitions

No contraindications present.

1.4 Electromagnetic Compatibility (EMC)



Essential performance

- (1) DR-ID 600SE/DR-ID 601SE/DR-ID 602SE/DR-ID 611SE/DR-ID 613SE obtains images.
- (2) DR-ID 600MC stores images.
- (3) DR-ID 600MC corrects images.
- (4) Image transfer in order from DR-ID 600SE/DR-ID 601SE/DR-ID 602SE/DR-ID 611SE/DR-ID 613SE, DR-ID 600MP, DR-ID 600MC, to DR-ID 300CL
- (5) DR-ID 300CL stores and displays images after correction.
- (6) It shall fulfill and maintain the safety requirement of the standards.



DR-ID 600 is consists of following components and conforms to IEC 60601-1-2+A1 as a result of each component conforms to following standards.

- DR-ID 600PU ----- IEC60601-1-2
- DR-ID 600MC ----- CISPR 22 /CISPR 24
- DR-ID 300CL ----- CISPR 22 /CISPR 24
- Access point (DAP-2553) ----- EMI : CE, FCC, IC (It is equivalent to CISPR 22.)

1.4.1 DR-ID 600PU

DR-ID 600PU consists of DR-ID 600MP and DR-ID 600SE/DR-ID 601SE/DR-ID 602SE/DR-ID 611SE/DR-ID 613SE.

This equipment has been tested and found to comply with the limits for medical devices to the IEC 60601-1-2:2001+A1:2004 (EN60601-1-2:2001+A1:2006), Medical Device Directive 93/42/EEC. These limits are designed to provide reasonable protection against harmful interference in a typical medical installation.

This equipment generates, uses and can radiate radio frequency energy and, if not installed and used in accordance with the instructions, may cause harmful interference to other devices in the vicinity.

However, there is no guarantee that interference will not occur in a particular installation.

If this equipment does cause harmful interference to other devices, which can be determined by tuning the equipment off and on, the user is encouraged to try to correct the interference by one or more of the following measures:

- Reorient or relocate the receiving device.
- Increase the separation between the equipment.
- Connect the equipment into an outlet on a circuit different from that to which the other device(s) are connected.

If the problem cannot be solved with the above measures, stop using this equipment and consult the manufacturer or our official dealer for help.



WARNING

- Do not place devices generating electromagnetic wave near this equipment.
- If a device(s) other than those specified is connected, predetermined EMC performance cannot be guaranteed.

Further information for IEC 60601-1-2 (EN60601-1-2)

1. Medical electrical equipment needs special precautions regarding EMC and needs to be installed and put into service according to the EMC information provided in the accompanying documents.
2. Portable and mobile RF communications equipment can affect medical electrical equipment.
3. Information regarding the cable affecting EMC is as follows.

Name	Connected Device	Maximum Length	General Specification
Network Cable	Between the DR-ID 600PU and the DR-ID 600MC	30m (98.4 ft)	Cat5e or more, UTP type and straight cable
	Between the DR-ID 600MC and the DR-ID 300CL	100m (328.1 ft)	
Power Cable	DR-ID 600PU	3m (9.8 ft)	Use a hospital grade power cable. (for North America)
			A non-hospital grade power cable can be used. (for other countries)

4. The use of accessories, transducers and cables other than those specified, with the exception of transducers and cables sold by FUJIFILM Corporation as replacement parts for internal components, may result in increased emissions or decreased immunity of the DR-ID 600PU.
5. The DR-ID 600PU should not be used adjacent to or stacked with other equipment.
If adjacent or stacked use is necessary, the DR-ID 600PU should be observed to verify normal operation in the configuration in which it will be used.
6. Basic performance of the equipment and the system
After image data are acquired from the DR-ID 600PU, data correction is performed by the control cabinet (DR-ID 600MC), and the image is saved in and displayed on the image processing unit (DR-ID 300CL).
7. Test items (Tables 1 to 4)

Table 1

Guidance and manufacturer's declaration - electromagnetic emissions			
The DR-ID 600PU is intended for use in the electromagnetic environment specified below. The customer or the user of the DR-ID 600PU should assure that it is used in such an environment.			
Emissions test	Compliance		Electromagnetic environment - guidance
RF emissions CISPR 11	Group 1		The DR-ID 600PU uses RF energy only for their internal function. Therefore, their RF emissions are very low and are not likely to cause any interference in nearby electronic equipment.
RF emissions CISPR 11	Class A		The DR-ID 600PU is suitable for use in all establishments other than domestic and those directly connected to the public low-voltage power supply network that supplies buildings used for domestic purposes.
Harmonic emissions IEC61000-3-2	Complies	DR-ID 600PU: Class A	
Voltage fluctuations/ flicker emissions IEC61000-3-3	Complies		

Table 2

Guidance and manufacturer's declaration - electromagnetic immunity			
The DR-ID 600PU is intended for use in the electromagnetic environment specified below. The customer or the user of the DR-ID 600PU should assure that it is used in such an environment.			
Immunity test	IEC 60601-1-2 test level	Compliance level	Electromagnetic environment - guidance
Electrostatic discharge (ESD) IEC61000-4-2	±6kV contact ±8kV air	±6kV contact ±8kV air	Floors should be wood, concrete or ceramic tile. If floors are covered with synthetic material, the relative humidity should be at least 30%.
Electrical fast transient/burst IEC61000-4-4	±2kV for power supply lines ±1kV for input/output lines	±2kV for power supply lines ±1kV for input/output lines	Mains power quality should be that of a typical commercial or hospital environment.
Surge IEC61000-4-5	±1kV differential mode ±2kV common mode	±1kV differential mode ±2kV common mode	Mains power quality should be that of a typical commercial or hospital environment.
Voltage dips, short interruptions and voltage variations on power supply input lines IEC61000-4-11	<5% U_T (>95% dip in U_T) for 0.5 cycle 40% U_T (60% dip in U_T) for 5 cycles 70% U_T (30% dip in U_T) for 25 cycles <5% U_T (>95% dip in U_T) for 5 s	<5% U_T (>95% dip in U_T) for 0.5 cycle 40% U_T (60% dip in U_T) for 5 cycles 70% U_T (30% dip in U_T) for 25 cycles <5% U_T (>95% dip in U_T) for 5 s	Mains power quality should be that of a typical commercial or hospital environment. If the user of the DR-ID 600PU requires continued operation during power mains interruptions, it is recommended that the DR-ID 600PU be powered from an uninterruptible power supply or a battery.
Power frequency (50/60Hz) magnetic field IEC61000-4-8	3 A/m	3 A/m	Power frequency magnetic fields should be at levels characteristic of a typical location in a typical commercial or hospital environment.
NOTE: U_T is the a.c. mains voltage prior to application of the test level.			

Table 3

Guidance and manufacturer's declaration - electromagnetic immunity			
The DR-ID 600PU is intended for use in the electromagnetic environment specified below. The customer or the user of the DR-ID 600PU should assure that it is used in such an environment.			
Immunity test	IEC 60601-1-2 test level	Compliance level	Electromagnetic environment - guidance
Conducted RF IEC61000-4-6	3 Vrms 150 kHz to 80 MHz	3 Vrms	Portable and mobile RF communications equipment should be used no closer to any part of the DR-ID 600PU, including cables, than the recommended separation distance calculated from the equation applicable to the frequency of the transmitter. Recommended separation distance $d = 1.2\sqrt{P}$ $d = 1.2\sqrt{P}$ 80 MHz to 800 MHz $d = 2.3\sqrt{P}$ 800 MHz to 2.5 GHz where P is the maximum output power rating of the transmitter in watts (W) according to the transmitter manufacturer and d is the recommended separation distance in metres (m). Field strengths from fixed RF transmitters, as determined by an electromagnetic site survey, ^a should be less than the compliance level in each frequency range. ^b Interference may occur in the vicinity of equipment marked with the following symbol: 
Radiated RF IEC61000-4-3	3 V/m 80 MHz to 2.5 GHz	3 V/m	
NOTE 1: At 80 MHz and 800 MHz, the higher frequency range applies. NOTE 2: These guidelines may not apply in all situations. Electromagnetic propagation is affected by absorption and reflection from structures, objects and people.			
a Field strength from fixed transmitters, such as base stations for radio (cellular/cordless) telephones and land mobile radios, amateur radio, AM and FM radio broadcast and TV broadcast cannot be predicted theoretically with accuracy. To assess the electromagnetic environment due to fixed RF transmitters, an electromagnetic site survey should be considered. If the measured field strength in the location in which the DR-ID 600PU is used exceeds the applicable RF compliance, the DR-ID 600PU should be observed to verify normal operation. If abnormal performance is observed, additional measures may be necessary, such as reorienting or relocating the DR-ID 600PU.			
b Over the frequency range 150 kHz to 80 MHz, field strength should be less than 3 V/m.			

Table 4

Recommended separation distances between Portable and mobile RF communications equipment and the DR-ID 600PU			
<p>The DR-ID 600PU is intended for use in the electromagnetic environment in which radiated RF disturbances are controlled.</p> <p>The customer or the user of the DR-ID 600PU can help prevent electromagnetic interference by maintaining a minimum distance between portable and mobile RF communications equipment (transmitters) and the DR-ID 600PU as recommended below, according to the maximum output power of the communications equipment.</p>			
Rated maximum output power of transmitter W	Separation distance according to frequency of transmitter m		
	150 kHz to 80 MHz $d = 1.2\sqrt{P}$	80 MHz to 800 MHz $d = 1.2\sqrt{P}$	800 MHz to 2.5 GHz $d = 2.3\sqrt{P}$
0.01	0.12	0.12	0.23
0.1	0.38	0.38	0.73
1	1.2	1.2	2.3
10	3.8	3.8	7.3
100	12	12	23
<p>For transmitters rated at a maximum output power not listed above, the recommended separation distance d in metres (m) can be estimated using the equation applicable to the frequency of the transmitter, where P is the maximum output power rating of the transmitter in watts (W) according to the transmitter manufacturer.</p>			
<p>NOTE 1: At 80 MHz and 800 MHz, the separation distance for the higher frequency range applies.</p> <p>NOTE 2: These guidelines may not apply in all situations. Electromagnetic propagation is affected by absorption and reflection from structures, objects and people.</p>			

1.4.2 DR-ID 600MC and DR-ID 300CL

This equipment has been tested and found to comply with the international standard for medical devices below, according to the requirement of the IEC 60601-1-2:2001+A1:2004/EN 60601-1-2:2001+A1:2006.

EMC Standard : CISPR 22/EN 55022
CISPR 24/EN 55024
EN61000-3-2/IEC61000-3-2
EN61000-3-3/IEC61000-3-3

This does not guarantee that there is no harmful electromagnetic interference under any installation environment.

This equipment can generate, use and radiate radio frequency energy. If the equipment is not installed and used in accordance with the instructions, or if peripheral devices that are not complied with the EMC standard, harmful interference may be generated under a particular environment causing malfunction of the equipment and other devices.

If this equipment causes harmful interference to other devices, or if this equipment is affected by interference from other devices, the user is encouraged to try to correct the interference by one or more of the following measures:

- Reorient or relocate the receiving device.
- Increase the separation between the equipment.
- Connect the equipment into an outlet on a circuit different from that to which the other device(s) are connected.

If the problem cannot be solved with the above measures, stop using this equipment and consult the manufacturer or our official dealer for help.



WARNING

Do not place devices generating electromagnetic wave near this equipment.

Further information for CISPR 22 / EN55022 and CISPR 24 / EN55024

1. Medical electrical equipment needs special precautions regarding EMC and needs to be installed and put into service according to the EMC information provided in the accompanying documents.
2. Portable and mobile RF communications equipment can affect medical electrical equipment.
3. Information regarding the cable affecting EMC is as follows.

Name	Connected Device	Maximum Length	General Specification
Network Cable	Between the DR-ID 600PU and the DR-ID 600MC	30m (98.4 ft)	Cat5e or more, UTP type and straight cable
	Between the DR-ID 600MC and the DR-ID 300CL	100m (328.1 ft)	
Power Cable	DR-ID 600MC and DR-ID 300CL	Depends on the cable length of a personal computer.	

4. The use of accessories, transducers and cables other than those specified, with the exception of transducers and cables sold by FUJIFILM Corporation as replacement parts for internal components, may result in increased emissions or decreased immunity of the DR-ID 600MC and the DR-ID 300CL.
5. The DR-ID 600MC and the DR-ID 300CL should not be used adjacent to or stacked with other equipment.
If adjacent or stacked use is necessary, the DR-ID 600MC and the DR-ID 300CL should be observed to verify normal operation in the configuration in which it will be used.
6. Basic performance of the equipment and the system
After image data are acquired from the DR-ID 600PU, data correction is performed by the control cabinet (DR-ID 600MC), and the image is saved in and displayed on the image processing unit (DR-ID 300CL).
7. Test items (Tables 1 to 3)

Table 1

Guidance and manufacturer's declaration - electromagnetic emissions	
The DR-ID 600MC and the DR-ID 300CL are intended for use in the electromagnetic environment specified below. The customer or the user of the DR-ID 600MC and the DR-ID 300CL should assure that they are used in such an environment.	
Emissions test	Compliance
Noise terminal voltage CISPR 22 EN55022	Class A
Electric field noise strength CISPR 22 EN55022	Class A
Harmonic emissions EN61000-3-2 IEC61000-3-2	Class D
Voltage fluctuations/flicker emissions EN61000-3-3 IEC61000-3-3	Complies

Table 2

Guidance and manufacturer's declaration - electromagnetic immunity		
The DR-ID 600MC and the DR-ID 300CL are intended for use in the electromagnetic environment specified below. The customer or the user of the DR-ID 600MC and the DR-ID 300CL should assure that they are used in such an environment.		
Immunity test	EN/IEC test	Compliance level
Electrostatic discharge (ESD) EN61000-4-2 IEC61000-4-2	±4kV contact ±8kV air	±4kV contact ±8kV air
Electrical fast transient/burst EN61000-4-4 IEC61000-4-4	±1kV for power supply lines ±0.5kV for input/output lines	±1kV for power supply lines ±0.5kV for input/output lines
Surge EN61000-4-5 IEC61000-4-5	±1.0kV differential mode ±2.0kV common mode	±1.0kV differential mode ±2.0kV common mode
Voltage dips, short interruptions and voltage variations on power supply input lines EN61000-4-11 IEC61000-4-11	<5% U_T (>95% dip in U_T) for 0.5 cycle 70% U_T (30% dip in U_T) for 25 cycles <5% U_T (>95% dip in U_T) for 250 cycles	<5% U_T (>95% dip in U_T) for 0.5 cycle 70% U_T (30% dip in U_T) for 25 cycles <5% U_T (>95% dip in U_T) for 250 cycles
Power frequency (50/60Hz) magnetic field EN61000-4-8 IEC61000-4-8	1 A/m	1 A/m
NOTE: U_T is the a.c. mains voltage prior to application of the test level.		

Table 3

Guidance and manufacturer's declaration - electromagnetic immunity		
The DR-ID 600MC and the DR-ID 300CL are intended for use in the electromagnetic environment specified below. The customer or the user of the DR-ID 600MC and the DR-ID 300CL should assure that they are used in such an environment.		
Immunity test	EN/IEC test	Compliance level
Conducted RF EN61000-4-6 IEC61000-4-6	3 Vrms 150 kHz to 80 MHz	3 Vrms
Radiated RF EN61000-4-3 IEC61000-4-3	3 V/m 80 MHz to 1 GHz	3 V/m

1.5 Precautions in Using the FDR D-EVO

This section describes the precautions in using the FDR D-EVO.

1.5.1 Handling

Handle the flat panel sensor carefully since it is manufactured with precision.

If the flat panel sensor or the SE cable connector is hit or dropped or is subject to severe shock, it may be damaged. If the front and rear of the flat panel sensor are subject to impact by a projection, it may be damaged.

DR-ID 600SE is equipped with a shock sensor that detects a severe impact. For details, see "■ DR-ID 600PU" (page 2-3).



CAUTIONS

If the shock sensor lights red, contact a FUJIFILM dealer.

Do not pull the cable of the flat panel sensor (wired communication mode).

Also, do not pull the flat panel sensor with something caught by the cable.

Make sure that the cable is not trapped under the wheels of a stretcher or wheelchair.

Otherwise, the cable will be damaged, causing electric shock or fire.

When carrying the flat panel sensor (wired communication mode), do not drag the sensor cable relay connector on the floor or ground. Make also sure that no one or object comes into contact with the flat panel sensor. It is recommended to hold the connector when carrying the flat panel sensor.

Unless these cautions are observed, the flat panel sensor may be caught by an object, personal injury may result, or properties or the connector may be damaged.

Do not hold the flat panel sensor in one hand when carrying it. Hold it in both the hands or under the arm.

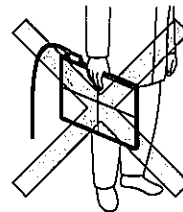
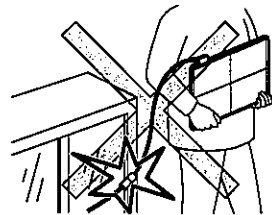
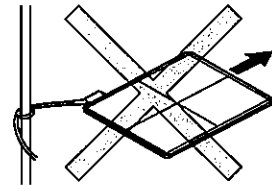
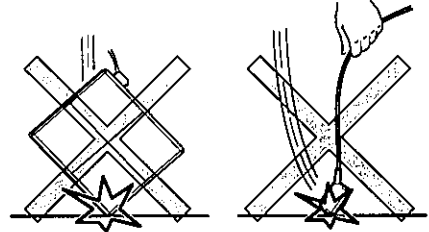

If any of the screw caps on the flat panel sensor comes off, attach a spare cap. Otherwise, artifacts may appear in the image due to static electricity.

To ensure optimal image quality, it is recommended that you do not use the flat panel sensor near devices (motor, transformer, switching supply, etc.) that generate electromagnetic noise.

To ensure optimal image quality, it is recommended that you do not place the cables (power cable, communication cable, etc.) of the equipment near devices (motor, transformer, switching supply, etc.) that generate electromagnetic noise and their cables.

Make sure that no liquid enters the flat panel sensor from around the battery section. Otherwise, the flat panel sensor may be damaged.

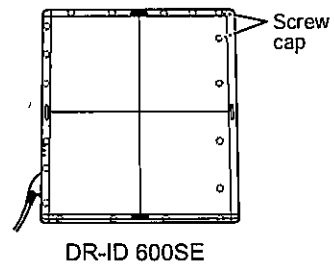
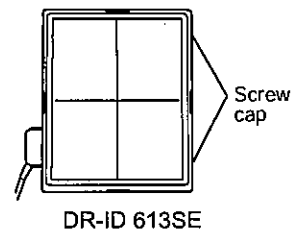
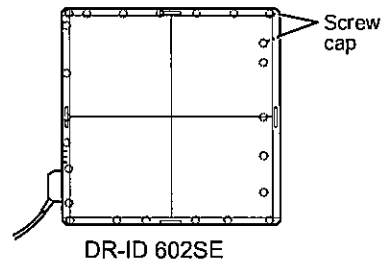
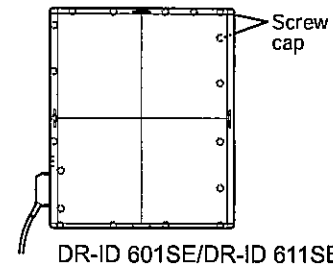

Do not use a multiple tap connector or extension cable for powering the devices constituting the system.

Up to three flat panel sensors can be connected. If you intend to use four or more flat panel sensors, only the first three that were connected to the Console can be used. For this reason, when four or more flat panel sensors are registered, be careful not to use a wrong one, as you may confuse which flat panel sensor is connected.

Make also sure, before making an exposure, that the color label on the flat panel sensor to be used matches the color of the panel icon selected on the Console.

Be sure to disconnect the wired connection of the panel in the first room prior to connecting and imaging the patient with the same panel in the second room to avoid mis-identification of the patient.

Do not place the cable terminal on the floor, as doing so may cause infection.
Also, clean the cable and the terminal periodically.

Do not insert the flat panel sensor into a CR reader unit.

1.5.2 Before Exposure

The use of an air-conditioner may dramatically changes the temperature of the room where the system is installed. This may cause dew condensation on the system, resulting in quality problems. When an air-conditioner is used, change the temperature gradually to avoid temperature variation in order not to cause dew condensation.

If an exposure is made with the front and rear of the flat panel sensor facing the other way round, re-exposure and electric parts may be damaged.

Do not use the flat panel sensor, which is communicating with the power supply unit in wired communication mode, for the radiographic examination stand equipped with an automatic loading function.

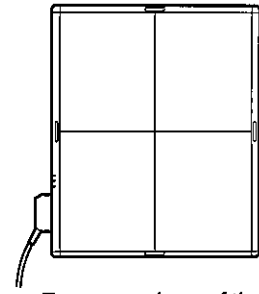

Exposure plane of the flat panel sensor

1.5.3 During Exposure

Before making an exposure, make sure that exposure conditions most appropriate for this system are set.

Do not apply an excessive force to the exposure plane. The sensor inside the flat panel sensor may be damaged, and it may not be possible to make an exposure properly.

<Load restriction>

Entire surface load : DR-ID 600SE : 125kg (275.6 lb)
 DR-ID 601SE, DR-ID 602SE and DR-ID 611SE : 150kg (330.8 lb)
 DR-ID 613SE : 310kg (683.6 lb)

Local load : DR-ID 600SE : 40kg (88.2 lb) / \varnothing 40mm (1.6in.)
 DR-ID 601SE, DR-ID 602SE and DR-ID 611SE : 100kg (220.5 lb) / \varnothing 40mm (1.6in.)
 DR-ID 613SE : 160kg (352.8 lb) / \varnothing 40mm (1.6in.)

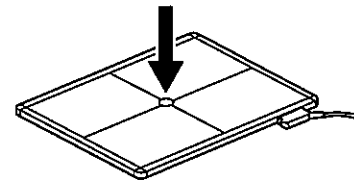
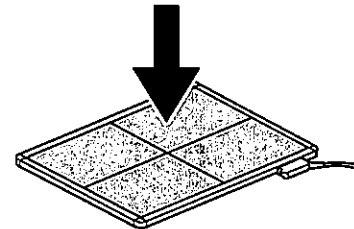

Use the flat panel sensor on a flat floor or platform. When an excessive force is applied to the unit when it is tilted, the sensor inside the flat panel sensor may be damaged.

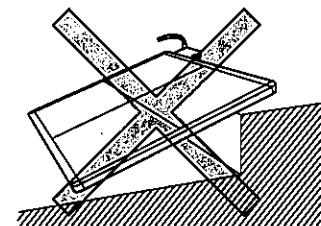

1.5.4 During Cleaning

To clean the outer surfaces, use commercially available ethanol papers for disinfection or a cleaning cloth tightly wrung out of ethanol (or diluted neutral detergent).



CAUTIONS

- Do not use an excessive amount of ethanol (or neutral detergent), as doing so may allow the liquid to enter from the gap on the outer surfaces, resulting in the damage to the flat panel sensor, or cause the labels to come off.
- Do not use a solvent such as thinner or benzene, as it corrodes the outer surfaces.

1.5.5 Storage

When the flat panel sensor is not in use, store the device in a place where it does not fall or drop.

1.5.6 Precautions Related to the Load Applied to the Flat Panel Sensor

If excessive load is applied to the flat panel sensor, use it on a flat floor or platform. When making an exposure for the patient in a wheelchair or adjustable bed or on a stretcher, the flat panel sensor may be deformed (deflection by some millimeters).

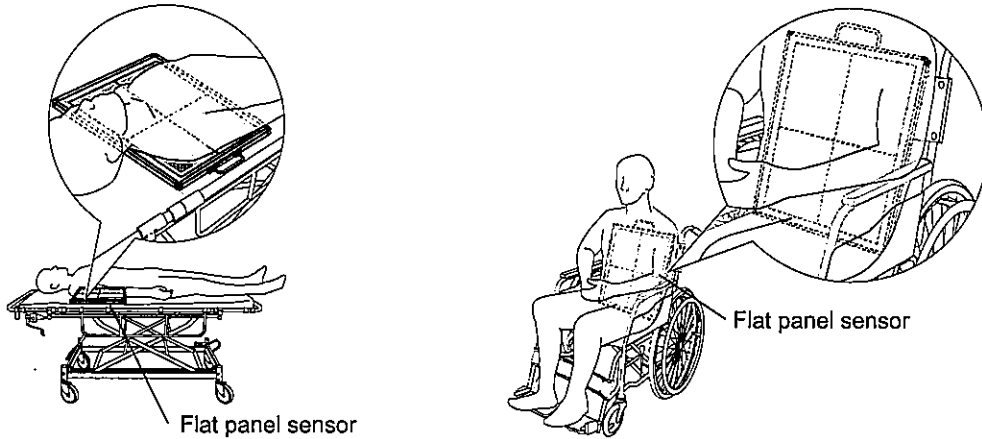

If DR-ID 600SE is used in such an exposure, insert the flat panel sensor into the cassette holder (optional).

Even when the cassette holder is used, however, avoid using the flat panel sensor if the applied load is expected to exceed the limit (local load: 100kg (220.5 lb) / \varnothing 40mm (1.6in.), entire surface load: 150kg (330.8 lb)).

In case that the flat panel sensor is deformed, make sure that X-ray images are not adversely affected before continuing the use of the flat panel sensor.

The precautions below must also be observed when making an exposure.

- Do not have the patient stand on the flat panel sensor.
- Do not place the hard devices such as spine board on the flat panel sensor.

Excessive load is applied locally and the flat panel sensor may be damaged.

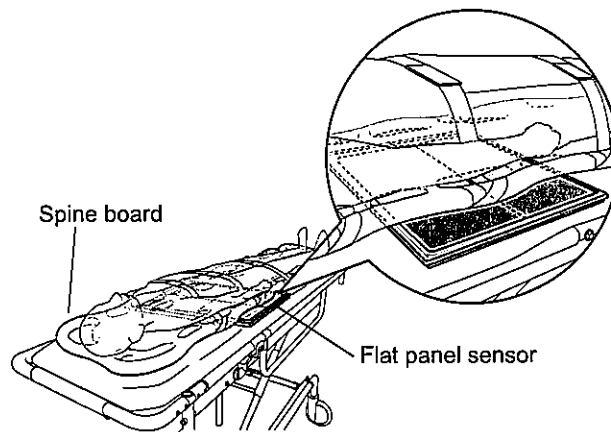

Even when the flat panel sensor is used on a flat floor or platform, it may be damaged if the applied load exceeds the limit.

1.6 Locations of Labels and Signs

Locations of labels and signs affixed to the FDR D-EVO, and the relevant safety signs are shown below.

1.6.1 Locations of Labels

Flat panel sensor (DR-ID 601SE)

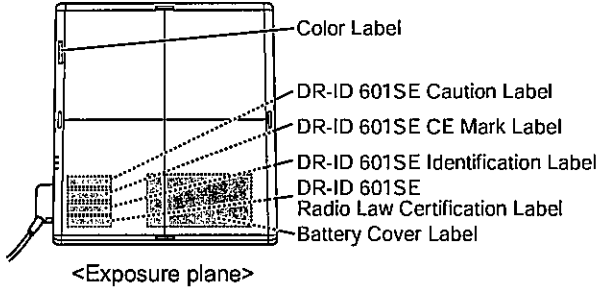

Flat panel sensor (DR-ID 602SE)

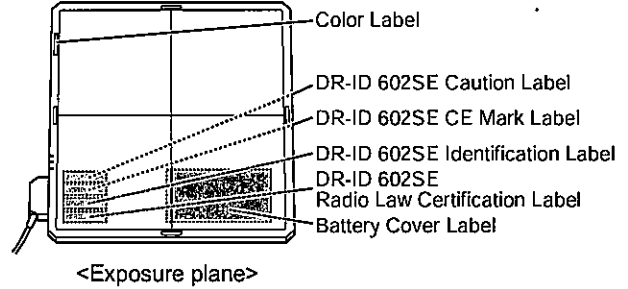

Flat panel sensor (DR-ID 611SE)

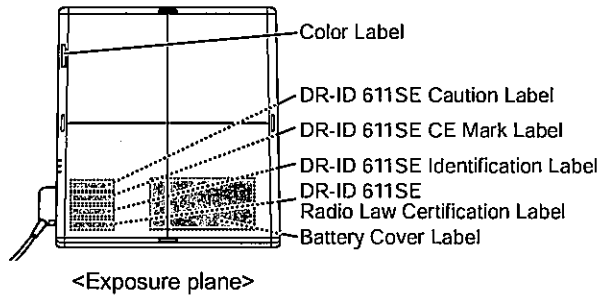

Flat panel sensor (DR-ID 613SE)

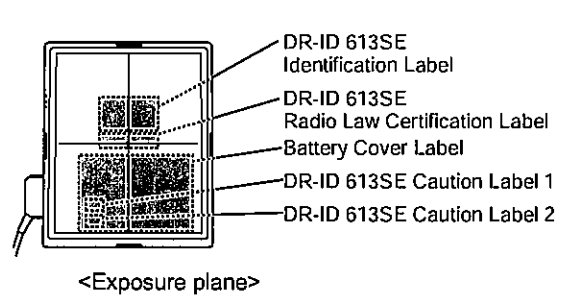

Flat panel sensor (DR-ID 600SE)

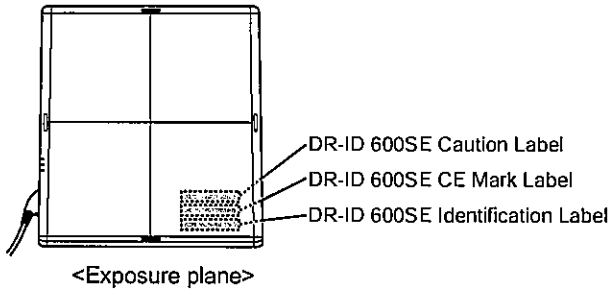

Control cabinet (DR-ID 600MC)

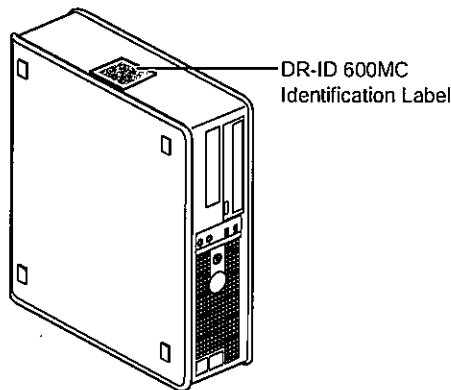

If the control cabinet is not included in the system, the DR-ID 600MC identification label is placed on the CD case of the software which has the same functions as the control cabinet.

Power supply unit (DR-ID 600MP)

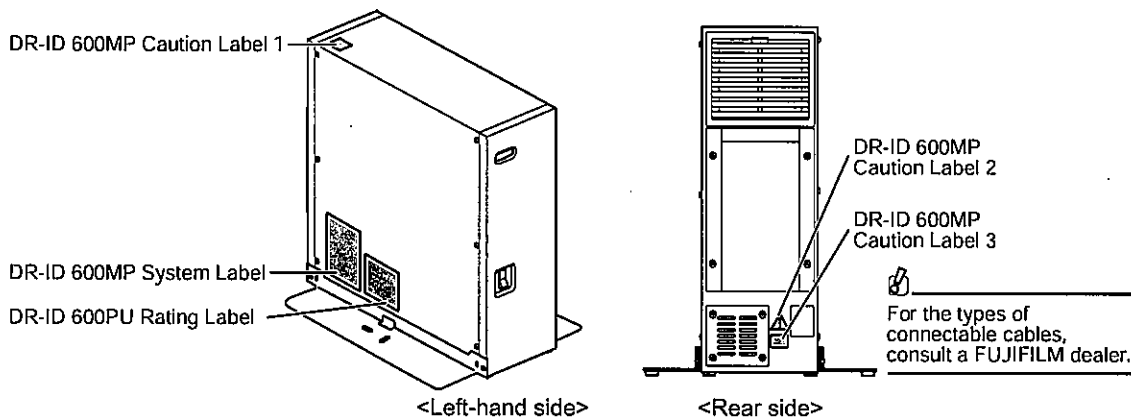

Battery charger (optional)

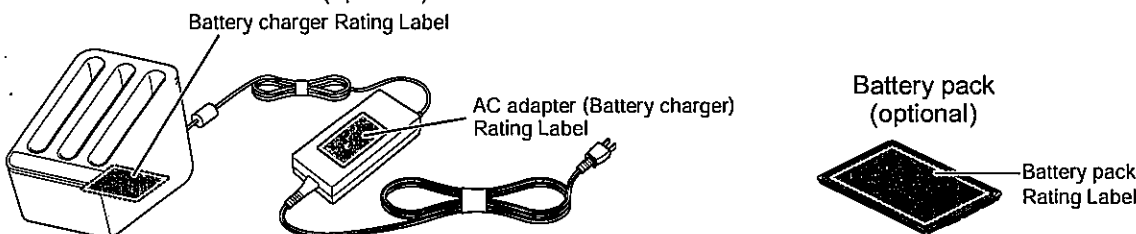

1.6.2 DR-ID 600

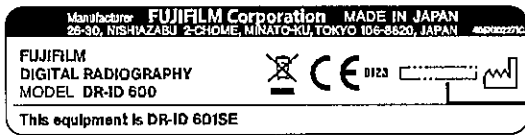

Sample year of manufacture

DR-ID 601SE CE Mark Label



Sample year of manufacture

DR-ID 602SE CE Mark Label

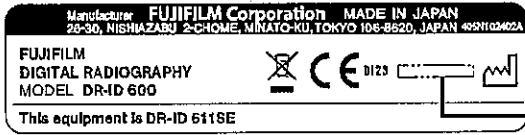

Sample year of manufacture

DR-ID 611SE CE Mark Label

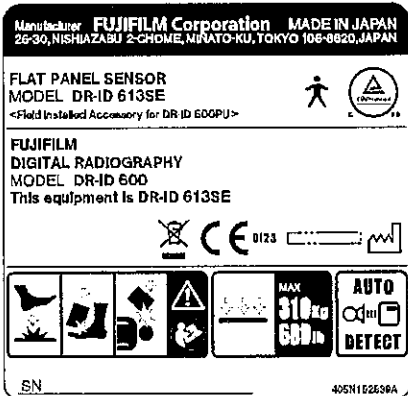

DR-ID 613SE Identification Label



Sample year of manufacture

DR-ID 600SE CE Mark Label

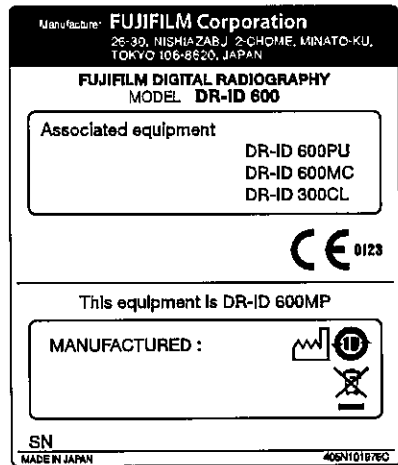

DR-ID 600MP System Label

Manufacturer: **FUJIFILM Corporation**
 25-30, NISHIAZABU 2-CHOME, MINATO-KU,
 TOKYO 106-8620, JAPAN

FUJIFILM DIGITAL RADIOGRAPHY
MODEL DR-ID 600

CE 0123

This equipment is DR-ID 600MC

MANUFACTURED: 2010

SN
 MADE IN JAPAN 40EN1019609

DR-ID 600MC Identification Label

この電池パックは、充電器で充電してください。
 この電池パックは、充電器で充電してください。
 Do not use with anything other than the specified adapter.
 Do not use with anything other than the specified adapter.
 Specified battery pack: FUJIFILM Corporation 125N100050
 (1.1V 2400mAh 27Ah)

Battery Cover Label

Li-Ion Battery charger FUJIFILM

MODEL 125N100052

INPUT 15V = 4.3A

OUTPUT 12.3V = 1.7A x3ch

Do not disassemble or modify.
 Do not use with anything other than the specified adapter.
 Specified battery pack: FUJIFILM Corporation 125N100050
 (1.1V 2400mAh 27Ah)

FUJIFILM Corporation
 Parts No. 125Y100056
 MADE IN JAPAN

Battery Charger Rating Label

FUJIFILM Corporation
 MADE IN JAPAN

MODEL 125N100050

Li-Ion バッテリー Li-Ion Battery

定格電圧 3.7 V 3.7 V
 定格容量 2400 mAh 2400 mAh

1. 充電器で充電してください。
 2. 充電器以外の充電器は使用しないでください。
 3. 充電器の取扱説明書を読んでください。
 4. 充電器の電源プラグは必ず接地してください。
 5. 充電器の電源プラグは必ず接地してください。
 6. 充電器の電源プラグは必ず接地してください。
 7. 充電器の電源プラグは必ず接地してください。
 8. 充電器の電源プラグは必ず接地してください。
 9. 充電器の電源プラグは必ず接地してください。
 10. 充電器の電源プラグは必ず接地してください。

1. Do not use with anything other than the specified adapter.
 2. Do not use with anything other than the specified adapter.
 3. Do not use with anything other than the specified adapter.
 4. Do not use with anything other than the specified adapter.
 5. Do not use with anything other than the specified adapter.
 6. Do not use with anything other than the specified adapter.
 7. Do not use with anything other than the specified adapter.
 8. Do not use with anything other than the specified adapter.
 9. Do not use with anything other than the specified adapter.
 10. Do not use with anything other than the specified adapter.

Li-Ion 00

Battery Pack Rating Label

FUJIFILM Corporation
 MADE IN JAPAN

MODEL 125N100050

Li-Ion バッテリー Li-Ion Battery

定格電圧 3.7 V 3.7 V
 定格容量 2400 mAh 2400 mAh

1. 充電器で充電してください。
 2. 充電器以外の充電器は使用しないでください。
 3. 充電器の取扱説明書を読んでください。
 4. 充電器の電源プラグは必ず接地してください。
 5. 充電器の電源プラグは必ず接地してください。
 6. 充電器の電源プラグは必ず接地してください。
 7. 充電器の電源プラグは必ず接地してください。
 8. 充電器の電源プラグは必ず接地してください。
 9. 充電器の電源プラグは必ず接地してください。
 10. 充電器の電源プラグは必ず接地してください。

1. Do not use with anything other than the specified adapter.
 2. Do not use with anything other than the specified adapter.
 3. Do not use with anything other than the specified adapter.
 4. Do not use with anything other than the specified adapter.
 5. Do not use with anything other than the specified adapter.
 6. Do not use with anything other than the specified adapter.
 7. Do not use with anything other than the specified adapter.
 8. Do not use with anything other than the specified adapter.
 9. Do not use with anything other than the specified adapter.
 10. Do not use with anything other than the specified adapter.

Li-Ion 00

AC ADAPTER FUJIFILM
125Y100057

MODEL RC120G-16D

INPUT 100-240V ~ 1.5A
 50-60Hz

OUTPUT 16V = 6.5A

EFFICIENCY LEVEL V

CAUTION: FOR INDOOR USE ONLY.
 DO NOT SHORTCIRCUIT OUTPUT TERMINALS.
 注意: 室内専用
 出力プラグショートさせないで下さい。
 DANGER: DO NOT OPEN DANGEROUS VOLTAGES INSIDE.
 危険: 内部に高電圧が蓄積する危険があります。開かないで下さい。

FUJIFILM Corporation

AC Adapter (Battery Charger) Rating Label

D-Link

Model: OAP-2553

1.1A 1.1A
 12V 12V

PN: JAP2553JJP_A10
 HW Ver.: A1 FW Ver.: 1.05
 SN: P4KW1A1000005
 MAC ID: 1CAFF71047A7

2.4DS/OF4

Complies With
 DA Standards
 09100149

Access Point Rating Label*

D-Link

Model No.: AF1805-A

INPUT: 100-120V ~ 0.4A, 50-60Hz LF

OUTPUT: +5.0V = 2.5A

CAUTION: RISK OF ELECTRIC SHOCK DO NOT OPEN

LISTED TO UL 1310 I.T.E. POWER SUPPLY

Manufactured by
 JUMTEC TECHNOLOGY CO., LTD.
 Made in China P.R.

AC Adapter (Access Point) Rating Label*

* The access point model is subject to change.

1.6.3 DR-ID 600PU

Manufacturer: **FUJIFILM Corporation** MADE IN JAPAN
 25-30, NISHIAZABU 2-CHOME, MINATO-KU, TOKYO 106-8620, JAPAN 40EN102270

FLAT PANEL SENSOR
MODEL DR-ID 601SE
 <Field Installed Accessory for DR-ID 600PU>

SN

DR-ID 601SE Identification Label

Manufacturer: **FUJIFILM Corporation** MADE IN JAPAN
 25-30, NISHIAZABU 2-CHOME, MINATO-KU, TOKYO 106-8620, JAPAN 40EN102401

FLAT PANEL SENSOR
MODEL DR-ID 602SE
 <Field Installed Accessory for DR-ID 600PU>

SN

DR-ID 602SE Identification Label



DR-ID 611SE Identification Label

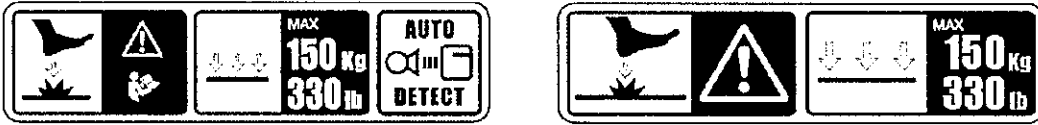

DR-ID 601SE/DR-ID 602SE/DR-ID 611SE Caution Label



DR-ID 600SE Identification Label

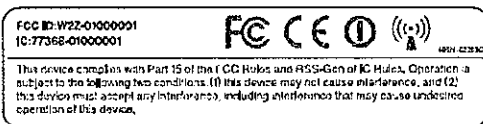

DR-ID 601SE/DR-ID 602SE/DR-ID 611SE Radio Law Certification Label

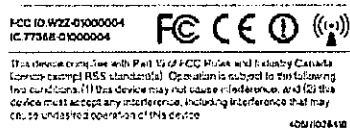

DR-ID 613SE Radio Law Certification Label



DR-ID 600SE Caution Label

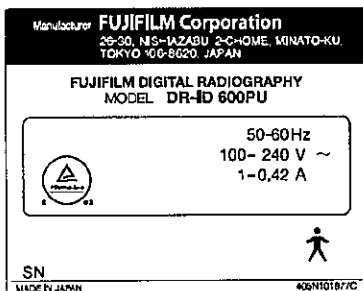

DR-ID 600PU Rating Label



DR-ID 600MP Caution Label 1





















DR-ID 600MP Caution Label 2 /
DR-ID 613SE Caution Label 1



DR-ID 600MP Caution Label 3 /
DR-ID 613SE Caution Label 2

1.6.4 Safety and Other Symbols

The following safety symbols are used in the labels or on its body.

Symbol	Description
	This symbol indicates compliance of the equipment with Directive 93/42/EEC.
	Caution (See "1.6.1 Locations of Labels" (page 1-22).)
	OFF (To indicate disconnection from the mains, at least for mains switches or their positions, and all those cases where safety is involved.)
	ON (To indicate connection to the mains, at least for mains switches or their positions, and all those cases where safety is involved.)
	Protective earth (ground)
	Alternating current
	This symbol indicates that the equipment is a Type B Applied Part.
	Ready (To indicate the machine is ready for operation.)
	Electric energy
	General mandatory action sign
	Stand-by
	<p>This symbol indicates that this product is not to be disposed of with your household waste, according to the WEEE Directive (2002/96/EC) and your national law. This product should be handed over to a designated collection point.</p> <p>Improper handling of this type of waste could have a possible negative impact on the environment and human health due to potentially hazardous substances that are generally associated with EEE.</p> <p>At the same time, your cooperation in the correct disposal of this product will contribute to the effective usage of natural resources.</p> <p>For more information about waste, please contact FUJIFILM dealers.</p>
	Year of manufacture
	Environmentally Friendly Use Period (EFUP)
	Caution for local load (See "1.5.3 During Exposure" (page 1-20).)
	Entire surface load
	This symbol indicates that the flat panel sensor supports the automatic X-ray detection function.
	No Stepping on Surface
	Refer to Instruction Manual/Booklet

1.7 Installation Conditions

1.7.1 Installation Space When Setting the Control Cabinet in the X-ray Room

In case that the control cabinet is installed in the X-ray room, ensure a certain distance between the control cabinet and the upright-type or bed-type radiographic examination stand. See the figure below for reference.

For the products that can be installed in patient environment, see "2.1.1 System Configuration" (page 2-1).

CAUTIONS

Do not install the power supply unit, control cabinet, image processing unit, Battery charger (optional) and Access point in an area of the X-ray room, where the user can easily trip over. Falls could result in injury.

■ Upright type

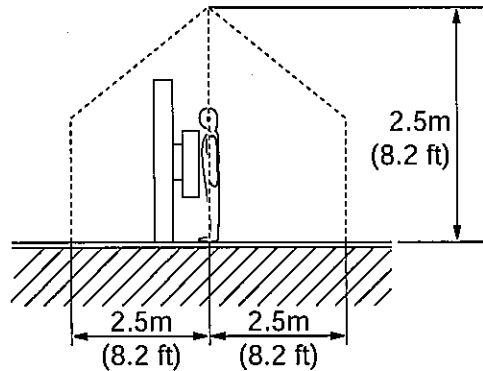
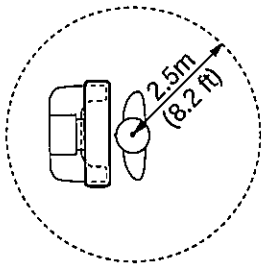

■ Bed type

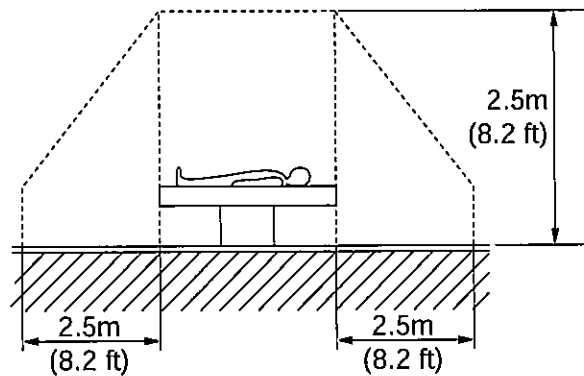
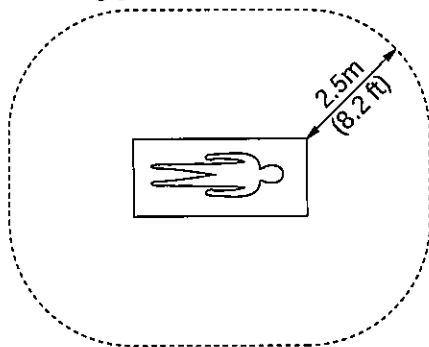



For Safe Operation

Chapter 2 System Configuration (Product Overview)

2.1 FDR D-EVO

2.1.1 System Configuration

For the U.S.

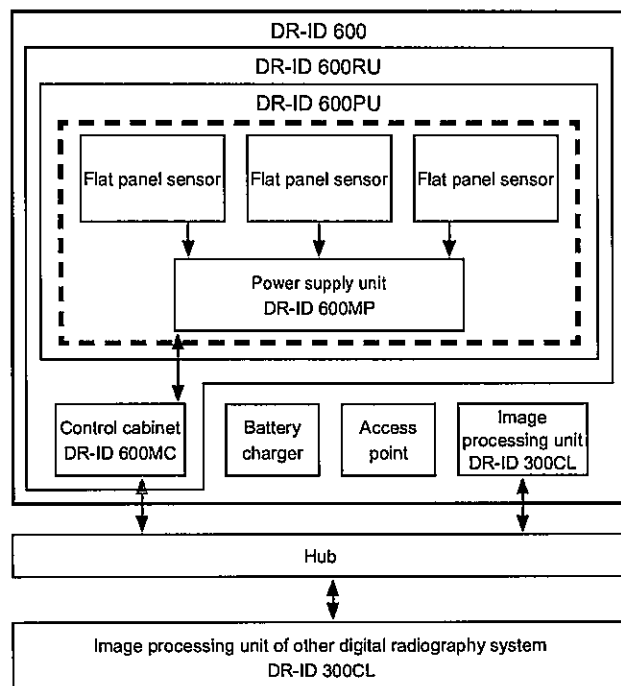

For other countries

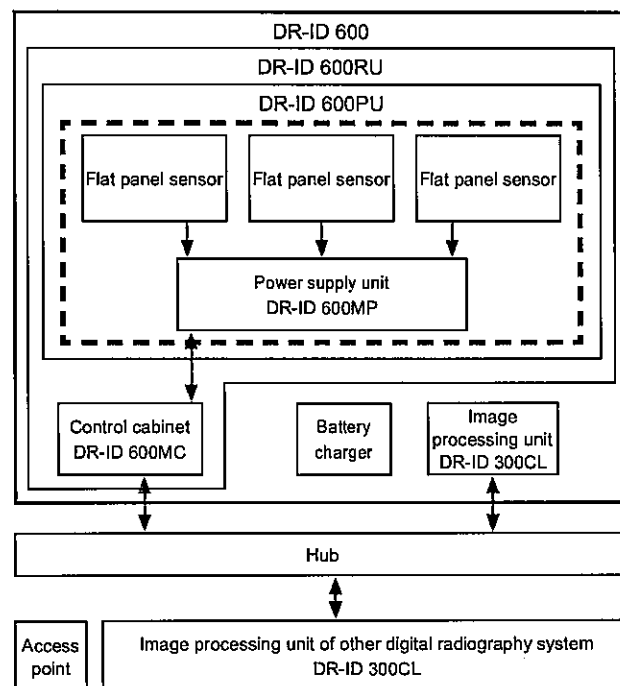

- The products in  can be installed in patient environment.
- The FDR D-EVO consists of the DR-ID 600RU and the image processing unit DR-ID 300CL.
- An access point is used only in wireless communication mode.
- * The configuration of the system varies depending on the country.
- One to three flat panel sensors can be connected to one power supply unit. If you connect all three flat panel sensors in wired communication mode or use them with three different techniques, two power supply units are required.
- Depending on the configuration, the control cabinet (DR-ID 600MC) may not be included in the system. If not included, the control cabinet's software is installed on the image processing unit (DR-ID 300CL).

2.1.2 Features of the FDR D-EVO

This section describes the main features of the FDR D-EVO.

- 1 The external dimensions and the weight of the flat panel sensor are the same as those of the conventional cassette used for general exposure. Due to this feature, the flat panel sensor can be inserted into the radiographic examination stand that has been used, allowing the user to avoid cassette replacement.
- 2 The flat panel sensor can be connected/disconnected with the relay connector of the connection cable. This allows the user to carry the flat panel sensor and insert/remove it into/from the upright-type or bed-type radiographic examination stand more easily.
- 3 The light weight and the thin and round design increase the operability of the flat panel sensor, making it possible to place it under a lying patient.
- 4 An image can be displayed on the Console in as fast as approximately 1 second after X-ray exposure processing is completed. (However, the required time varies depending on the mode setting.)
- 5 Owing to the highly sensitive flat panel sensor, X-ray exposure dose can be reduced accordingly.
- 6 Due to the effects of digital image processing, the system produces X-ray images that have a high diagnostic value and are easy to observe.
- 7 The system has a wide latitude for incident X-rays so that a large amount of X-ray diagnostic information is obtained.
- 8 As the system has a wide latitude and an automatic sensitivity adjustment function, its X-ray images are not affected by small changes in X-ray exposure conditions. Therefore, consistent image density is obtained for all images.
- 9 Image processing parameters are automatically selected through an anatomical region selection system from the Console.
- 10 Multi-objective Frequency Processing (MFP), a newly introduced image processing function, not only improves the image quality also achieves high-speed image processing.
- 11 A DICOM-conformed open network can be supported by connecting the Console.
- 12 With the flat panel sensor (DR-ID 601SE, DR-ID 602SE, DR-ID 611SE and DR-ID 613SE), wireless communication mode or wired communication mode can be selected. In wireless communication mode, exposures can be performed without connecting the cable.
- 13 The SmartSwitch is built in the flat panel sensor with the following logo.
With the SmartSwitch technology, operations for making an exposure start when the flat panel sensor detects X-rays. For this reason, it is not necessary to connect a cable to the flat panel sensor.



2.2 Unit Names and the Functions

Unit names and the functions of the FDR D-EVO are described below.

2.2.1 DR-ID 600

■ DR-ID 600PU

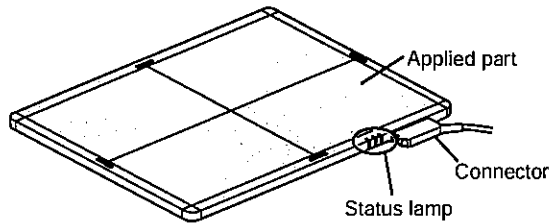

Flat panel sensor
(DR-ID 601SE, DR-ID 602SE and DR-ID 611SE)
* Exposure plane is shown in this figure.

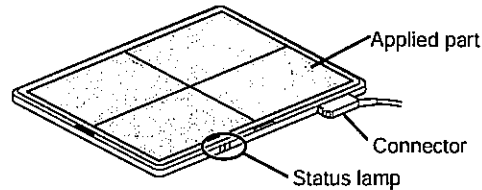

Flat panel sensor (DR-ID 613SE)
* Exposure plane is shown in this figure.

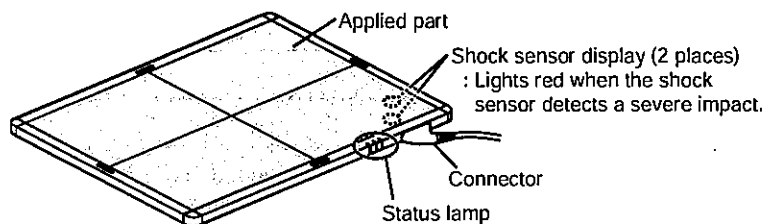

Flat panel sensor (DR-ID 600SE)
* Exposure plane is shown in this figure.

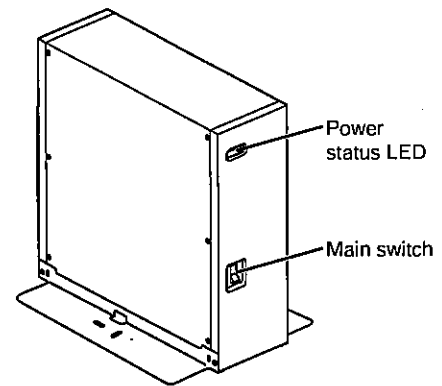

Power supply unit (DR-ID 600MP)

Name	Description																																	
Flat panel sensor	The DR-ID 600SE, DR-ID 601SE and DR-ID 602SE incorporate a GOS indirect panel. The DR-ID 611SE and DR-ID 613SE incorporate a CsI indirect panel. There are four types of flat panel sensors: DR-ID 601SE, DR-ID 602SE, DR-ID 611SE and DR-ID 613SE (wireless/wired communication mode) and DR-ID 600SE (wired communication mode).																																	
Status lamp	Indicates the equipment status by LEDs.																																	
	<table border="1"> <tr> <td rowspan="3">READY (Green)</td> <td>On</td> <td colspan="2">Exposure possible</td> </tr> <tr> <td>Blinks for 1.0 second.</td> <td colspan="2">During exposure sequence</td> </tr> <tr> <td>Off</td> <td colspan="2">Ready</td> </tr> <tr> <td rowspan="4">POWER (Green) (In wireless communication mode, the status of the battery pack is indicated. In wired communication mode, the power status is indicated.)</td> <td>On</td> <td>Wireless</td> <td>Wired</td> </tr> <tr> <td></td> <td>OK (Power ON)</td> <td>Power ON</td> </tr> <tr> <td>Blinks for 1.0 second.</td> <td>Less than 10 min</td> <td>-</td> </tr> <tr> <td>Off</td> <td>Empty (Power OFF)</td> <td>Power OFF</td> </tr> <tr> <td rowspan="3">ERROR (Orange)</td> <td>On</td> <td colspan="2">Communication not possible.</td> </tr> <tr> <td>Blinks for 1.0 second.</td> <td colspan="2">Error occurred</td> </tr> <tr> <td>Off</td> <td colspan="2">Normal</td> </tr> </table>	READY (Green)	On	Exposure possible		Blinks for 1.0 second.	During exposure sequence		Off	Ready		POWER (Green) (In wireless communication mode, the status of the battery pack is indicated. In wired communication mode, the power status is indicated.)	On	Wireless	Wired		OK (Power ON)	Power ON	Blinks for 1.0 second.	Less than 10 min	-	Off	Empty (Power OFF)	Power OFF	ERROR (Orange)	On	Communication not possible.		Blinks for 1.0 second.	Error occurred		Off	Normal	
	READY (Green)		On	Exposure possible																														
			Blinks for 1.0 second.	During exposure sequence																														
		Off	Ready																															
	POWER (Green) (In wireless communication mode, the status of the battery pack is indicated. In wired communication mode, the power status is indicated.)	On	Wireless	Wired																														
			OK (Power ON)	Power ON																														
		Blinks for 1.0 second.	Less than 10 min	-																														
		Off	Empty (Power OFF)	Power OFF																														
	ERROR (Orange)	On	Communication not possible.																															
Blinks for 1.0 second.		Error occurred																																
Off		Normal																																
* All LEDs are off when the equipment is off.																																		
Power supply unit (DR-ID 600MP)	Supplies the power to the flat panel sensor and connects the flat panel sensor and the control cabinet.																																	
Main switch	Supplies the power to the flat panel sensor and the inside of the power supply unit.																																	
Remote switch (optional)	Turns on/off the power to the flat panel sensor.																																	
Power status LED	Displays ON/OFF of the power supply unit.																																	

■ DR-ID 600MC

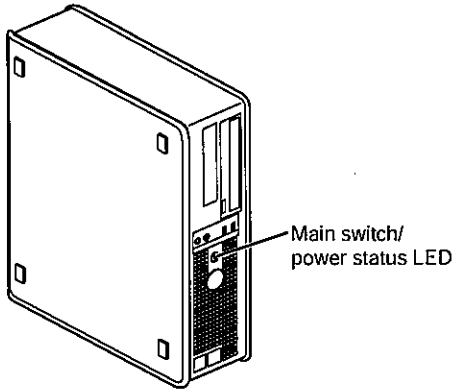

Control cabinet (DR-ID 600MC)

Name	Description
Control cabinet (DR-ID 600MC)	A personal computer used for controlling the flat panel sensor and performing image processing.
Main switch	Supplies the power to the control cabinet.
Power status LED	Displays ON/OFF of the control cabinet.



Depending on the configuration, the control cabinet (DR-ID 600MC) may not be included in the system. If not included, the control cabinet's software is installed on the image processing unit (DR-ID 300CL).

■ Battery charger (Optional)

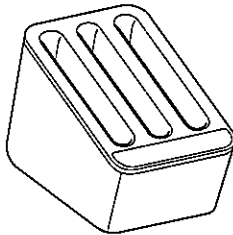

Battery charger

Name	Description
Battery charger	Charges the battery pack (optional) for the flat panel sensor (DR-ID 601SE, DR-ID 602SE, DR-ID 611SE and DR-ID 613SE). Three packs can be charged at the same time.
Charge status indicator LED	Indicates charge status.

■ Access point

- Product compliant with IEC60950, UL60950, PSE or JIS
- Compliant with IEEE802.11n [W52] (in the 5.2GHz band) /36, 40, 44, 48ch
- WLAN interface: 1000BASE-T/100BASE-TX (minimum requirements)
- LAN interface: 1000BASE-T/100BASE-TX (minimum requirements)
- Available OS: Linux
- Compliant with UL
- Compliant with FCC part15

■ DR-ID 300CL

● For the unit names and functions of the DR-ID 300CL, see the "DR-ID 300CL Operation Manual".

2.3 Console Display Configuration

When the self-initialization process ends, the Patient Information Input Screen will appear on the Console display.

For details, see "DR-ID 300CL Operation Manual".

■ Patient Information Input Screen

Patient information input field
Input patient information.

Tool button

Operates the Patient Information Database function to input patient information.

Reserves a study.
The reserved study is added to the "Waiting Study list".

Clears patient information (except for technologist).

Screen keyboard
Used to input characters in the patient information input field.

Reserves a study.

Terminates patient information input, and proceeds to exposure menu selection.

Connected devices status
Connected devices status display field.
Displays the status of connected devices.

■ Study Screen

Patient information display field
Displays patient information.

Image display field
The read image appears.

Shot Ready (exposure ready status indicator)
Exposure (image reading) can be performed when the indicator is lit green.
Exposure (image reading) cannot be performed when the indicator is not lit.

Technologist display field
Displays the name of logged-in technologist (user).

Exposure menu list
This list shows exposure menus selected on the "Exposure Menu Selection screen".

Selected exposure menu number display field

Exposure unit display field
The Tube, Technique, and Imaging panels can be uniquely arranged and displayed.

FDR D-EVO Operation Manual 897N101473K

2.4 Routine Operation Diagram

The system configuration and the routine operation diagram for the FDR D-EVO is as follows.

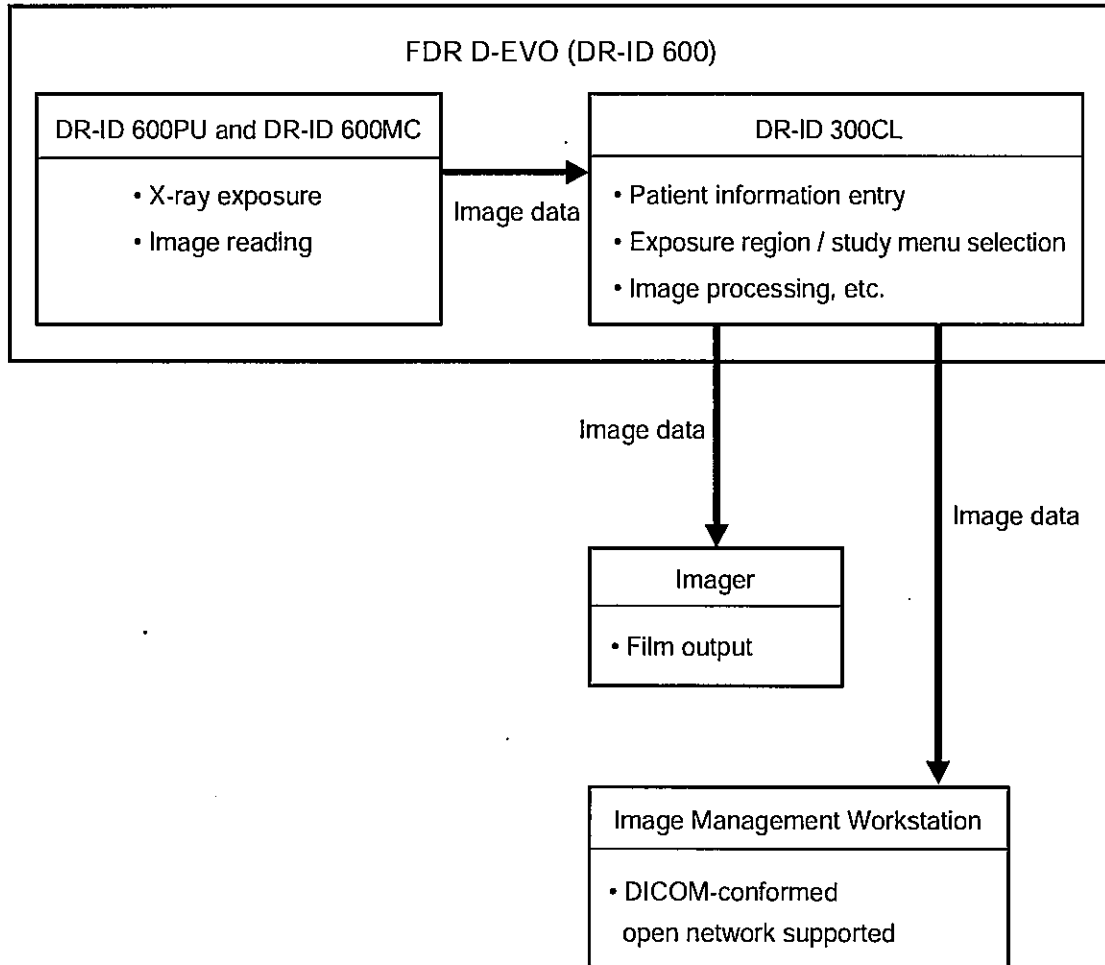

2.5 Wireless Specifications

- 1 Technical Specification : IEEE802.11.n (protocol) , W52 (frequency)
- 2 Intended environment : Room size of 10m x 10m x 3m (32.8 ft x 32.8 ft x 9.8 ft) (height) or less (general X-ray room)
(The electric shield does not exist excluding the installation stand or bed.)
- 3 Installation : DR-ID 601SE/DR-ID 602SE/DR-ID 611SE/DR-ID 613SE and Access Point must be installed in the same room.
Do not place Access Point within the reach of patients.
Do not Place more than one Access point in the same room.
Do not place devices generating electromagnetic wave (CT,MRI, diathermy, RFID etc.) near this equipment.
Do not use any other wireless devices such as cellular/smart phones, portable phones, microwave ovens, WAPs, etc.within 2m (6.6 ft) of the wireless D-EVO system.
Do not change the position of the access point once installed.
Do not cover the Flat Panel Detector (DR-ID 601SE/DR-ID 602SE/DR-ID 611SE/DR-ID 613SE) with a shield such as a metallic plate as this will interfere with a wireless communication.
- 4 Information being transmitted :
X-ray Control Signal (Prep-SW, Shot-SW)
System Control Signal, (Img_req_CMD, etc..)
Image Data(Raw data Before Image processing)(Note: Patient Information is not transmitted by wireless interface.)
- 5 Wireless range : max. 10m (32.8 ft) from the Access point as tested. Actual range may vary.
- 6 Data transfer rate : 35Mbps
(This value is FUJIFILM measuring result of wireless module, and actual data rate may vary.)
- 7 Transfer Power : MAX 12.26dBm (According to FCC part15 test report)
- 8 Modulation : OFDM (Provided by IEEE802.11.n standard)
"RADIO TEST" is executed to this product according to FCC part15 subpart E: 2010 standard, and "EMC TEST" is executed according to IEC60601-1-2 standard.
All the test items are passed.
- 9 Wireless Data Security : Wireless D-EVO system (DR-ID600 with DR-ID 601SE/DR-ID 602SE/DR-ID 611SE/DR-ID 613SE) will be utilizing the IEEE standard 802.11.n at the 5.2GHz frequency, which will allow us a maximum wireless signal rate of up to 35Mbps. The Wireless Access Point (WAP) has a feature that limits the maximum number of users per Access Point to ensure data integrity. Further the WAP has MAC Address Filtering (unique IP address) and Wireless LAN Segmentation to ensure handshaking with only the registered wireless D-EVO Flat Panel Detectors (DR-ID 601SE/DR-ID 602SE/DR-ID 611SE/DR-ID 613SE).
In addition to the MAC address filtering, the wireless communication between DR-ID 601SE/DR-ID 602SE/DR-ID 611SE/DR-ID 613SE (Flat Panel Detector) and the wireless access point is secured by WPA2-PSK encryption with AES (Advanced Encryption Standard). Data security feature will be enabled during installation by a FUJIFILM field service engineer. No patient information is transmitted between DR-ID 601SE/DR-ID 602SE/DR-ID 611SE/DR-ID 613SE (Flat Panel Detector) and Wireless Access Point.

10 Handshaking/Pairing : The Wireless Access Point and DR-ID 601SE/DR-ID 602SE/ DR-ID 611SE/DR-ID 613SE (Flat Panel Detector) will be paired during installation by a FUJIFILM field service engineer to ensure one-to-one wireless connection. FUJIFILM field service engineer will measure the wireless transmission speed during installation to find the best position of the wireless access point and the wireless D-EVO system.

11 Frequency Tolerance : ± 20 ppm

Quality of Service (QoS) For DR-ID 601SE / DR-ID 602SE / DR-ID 611SE

Item	Standard		Unit	Remarks
Form of electric wave	Spectrum diffusion		-	
Center frequency	HT20	5180-5240	MHz	36ch,40ch,44ch,48ch W52
	HT40	5190-5230	MHz	38ch,46ch W52
Channel interval	IEEE802.11.n	20(HT20) / 40(HT40)	MHz	
Transmission rate	IEEE802.11.n	11n HT20 : MCS 0-15 11n HT40 : MCS 0-15	-	
Modulation	OFDM (64QAM,16QAM,QPSK,BPSK)		-	
Output power	HT20 Max	11.9	dBm	
	HT20 Typ	10.0	dBm	
	HT20 Min	7.6	dBm	
	HT40 Max	12.3	dBm	
	HT40 Typ	10.0	dBm	
	HT40 Min	7.8	dBm	
Frequency Tolerance	-20 ~ +20		ppm	MAX
Reception sensitivity (PER (Packet Error Rate)<10%)	MCS0, 8	-82	dBm	HT20
	MCS1, 9	-79	dBm	
	MCS2, 10	-77	dBm	
	MCS3, 11	-74	dBm	
	MCS4, 12	-70	dBm	
	MCS5, 13	-66	dBm	
	MCS6, 14	-65	dBm	
	MCS7, 15	-64	dBm	HT40
	MCS0, 8	-79	dBm	
	MCS1, 9	-76	dBm	
	MCS2, 10	-74	dBm	
	MCS3, 11	-71	dBm	
	MCS4, 12	-67	dBm	
	MCS5, 13	-63	dBm	
MCS6, 14	-62	dBm		
MCS7, 15	-61	dBm		
Current consumption	TX5G	550 (Typ)	mA	Thruput test mode
	RX5G	450 (Typ)	mA	Thruput test mode

Quality of Service (QoS) For DR-ID 613SE

Item	Standard		Unit	Remarks
Form of electric wave	Spectrum diffusion		-	
Center frequency	HT20	5180~5240	MHz	36ch,40ch,44ch,48ch W52
	HT40	5190~5230	MHz	38ch,46ch W52
Channel interval	IEEE802.11.n	20(HT20) / 40(HT40)	MHz	
Transmission rate	IEEE802.11.n	11n HT20 : MCS 0-15 11n HT40 : MCS 0-15	-	
Modulation	OFDM (64QAM, 16QAM, QPSK, BPSK)		-	
Output power	HT20 Max	13.6	dBm	
	HT20 Typ	12.5	dBm	
	HT20 Min	10.2	dBm	
	HT40 Max	12.7	dBm	
	HT40 Typ	11.0	dBm	
	HT40 Min	9.5	dBm	
Frequency Tolerance	-20 ~ +20		ppm	MAX
Reception sensitivity (PER (Packet Error Rate)<10%)	MCS0, 8	-82	dBm	HT20
	MCS1, 9	-79	dBm	
	MCS2, 10	-77	dBm	
	MCS3, 11	-74	dBm	
	MCS4, 12	-70	dBm	
	MCS5, 13	-66	dBm	
	MCS6, 14	-65	dBm	
	MCS7, 15	-64	dBm	HT40
	MCS0, 8	-79	dBm	
	MCS1, 9	-76	dBm	
	MCS2, 10	-74	dBm	
	MCS3, 11	-71	dBm	
	MCS4, 12	-67	dBm	
	MCS5, 13	-63	dBm	
MCS6, 14	-62	dBm		
MCS7, 15	-61	dBm		
Current consumption	TX5G	550 (Typ)	mA	Thruput test mode
	RX5G	450 (Typ)	mA	Thruput test mode

Chapter 3 Basic Operation

3.1 Preparing the Flat Panel Sensor

This section describes how to prepare the flat panel sensor.

3.1.1 Type of Flat Panel Sensor

DR-ID 601SE, DR-ID 602SE, DR-ID 611SE and DR-ID 613SE :

Wireless communication mode or wired communication mode is available. When used in wireless communication mode, an access point*1, battery pack (optional) and battery charger (optional) are required.

*1 In the countries other than the U.S., an access point is not included as a component of the system. For details including installation, consult our official dealer.

- Product compliant with IEC60950, UL60950, PSE or JIS
- Compliant with IEEE802.11n [W52] (in the 5.2GHz band) /36, 40, 44, 48ch
- WLAN interface: 1000BASE-T/100BASE-TX (minimum requirements)
- LAN interface: 1000BASE-T/100BASE-TX (minimum requirements)
- Available OS: Linux
- Compliant with UL
- Compliant with FCC part15



CAUTIONS

Use only one access point. A communication error may occur if two units or more are used.

DR-ID 600SE : Wired communication mode

3.1.2 Number of the Connectable Flat Panel Sensors

To enable the flat panel sensor, its ID needs to be registered in advance by a FUJIFILM dealer.

Up to five flat panel sensors can be registered.

Up to three flat panel sensors*2 can be connected to the power supply unit at the same time.

*2 When three flat panel sensors are simultaneously used with the power supply unit and in wired communication mode, two power supply units are required.

(Connection example)

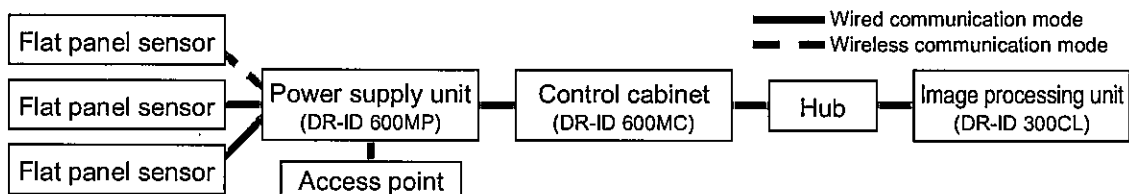

Depending on the configuration, the control cabinet (DR-ID 600MC) may not be included in the system. If not included, the control cabinet's software is installed on the image processing unit (DR-ID 300CL).

3.1.3 Connecting/Disconnecting the Flat Panel Sensor (DR-ID 601SE, DR-ID 602SE, DR-ID 611SE and DR-ID 613SE) Connector

When used in wireless communication mode, disconnect the connector.

1 Disconnect the connector.

Press the latches on both sides of the connector.

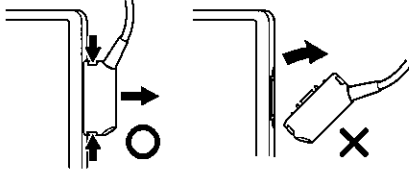

2 Connect the connector.

Press the connector into the insertion section.

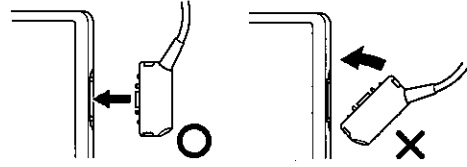

Make sure that the latches on both sides are properly engaged when connecting the connector. If the flat panel sensor is used with the connector inserted incompletely, the flat panel sensor may turn off.



Connect/Disconnect the connector straight to the flat panel sensor. If connected/disconnected at an angle, the connector may be damaged.

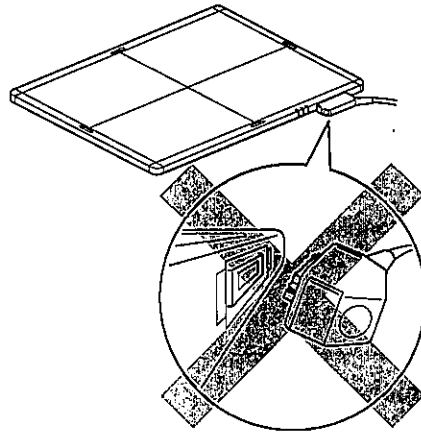

3.1.4 Connecting/Disconnecting the Sensor Cable Relay Connector for the Flat Panel Sensor (DR-ID 600SE)

Follow the procedure below to connect/disconnect the sensor cable relay connector.



- Do not connect the flat panel sensor to the power supply unit other than of the FDR D-EVO. Otherwise, the connector may be damaged.
- Do not connect the flat panel sensor unregistered to the system. Otherwise, the power to the flat panel sensor will be disconnected automatically. For details on the registration, contact a FUJIFILM dealer.
- When connecting/disconnecting the sensor cable relay connector, always hold the grip of the connector. The wire inside may be broken, if you connect/disconnect by holding the cable. If you turn the outer bushing of the grip, the cable lock becomes loose, causing a short-circuit of the cable.
- Do not drop the sensor cable relay connector when connecting/disconnecting it. Otherwise, personal injury may result, or properties or the connector may be damaged.
- Do not connect an 8.5m(27.9 ft)-long cable for the power supply unit and that for the flat panel sensor of the same length. If the total length of the connected cables exceeds 10m (32.8 ft), the flat panel sensor may malfunction.

1 Make sure that the READY lamp of the flat panel sensor is not blinking, and press the OFF side of the power supply unit. Alternatively, turn off the flat panel sensor by pressing the operation button on the optional remote switch, and make sure that the POWER lamp of the flat panel sensor turns off.

For the external view of the optional remote switch, see "O.2 Using the Remote Switch" (page O-2).



The remote switch can be simultaneously connected to both the upright type and the bed type. The relay connector can be connected/disconnected by turning off either of the remote switches.



You can proceed to the next step even if an error message appears after turning off the power supply unit.

2 To disconnect, hold the grips A and B of both the connectors, and then pull the grip A of the flat panel sensor to unlock.

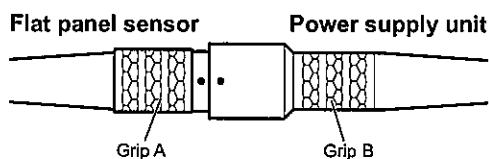

CAUTIONS

If you skip Step 1 and perform Step 2, a communication error occurs. In such a case, turn the power back on to the power supply unit. Note, however, that repeating this action may result in damage to the equipment.

3 To connect, align the positioning marks, and then push the connectors in.

Align the positioning mark on the connector of the power supply unit with that of the flat panel sensor, and then insert the connectors by slightly turning them.

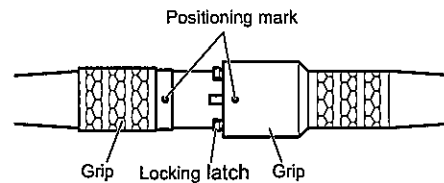

Push in until you feel a click.

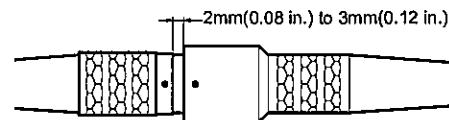

Push further in to the position shown in the figure in Step 2 until you feel a click again to lock them into place.

4 Press the ON side of the main switch of the power supply unit, or press the operation button on the optional remote switch.

3.1.5 Inserting/Removing the Flat Panel Sensor into/from the Radiographic Examination Stand

Follow the procedure below to insert/remove the flat panel sensor into/from the radiographic examination stand.

● For details, see the Operation Manual for the radiographic examination stand.

CAUTIONS

For the positioning at the time of inserting/removing the flat panel sensor, see the Operation Manual for the radiographic examination stand.

CAUTIONS

Be careful not to have your fingers caught when inserting/removing the flat panel sensor into/from the radiographic examination stand.



For the effective area of the flat panel sensor, see page A-5.

[1] Upright type

When inserting from the right-hand side

CAUTIONS

When inserting the flat panel sensor into the radiographic examination stand, direct the exposure plane toward the X-ray tube.

1 Pull out the tray.

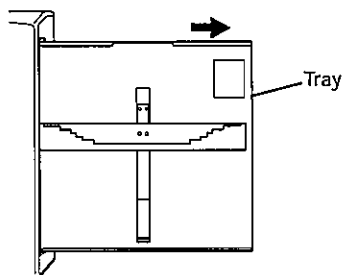

2 Insert the flat panel sensor into the cassette receive while the connector directed to the upper right, and then move it downwards.

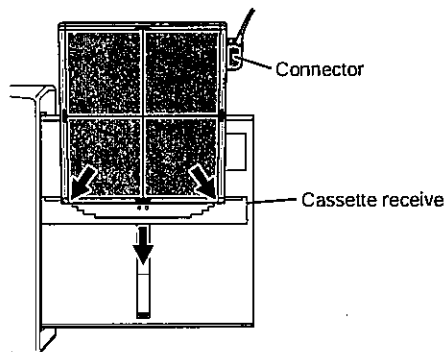

3 Set the flat panel sensor to the upper part of the tray.

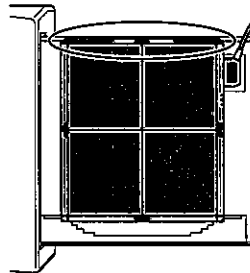

4 Push the tray back into place after setting the flat panel sensor.

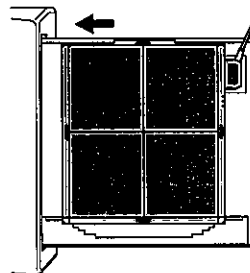

When inserting the flat panel sensor from the left-hand side, direct the connector to the lower left.

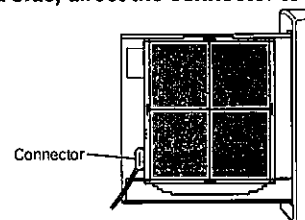

5 Remove the flat panel sensor after use.

Pull out the tray, push the cassette receive downwards, and then remove the flat panel sensor. Push the tray back into place.

[2] Bed type



CAUTIONS

When inserting the flat panel sensor to the radiographic examination stand, direct the exposure plane upwards.

- 1 Pull out the tray by using the handle.

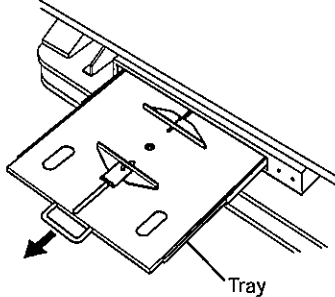

- 2 Pull the cassette stopper, and set the flat panel sensor so that its center mark is aligned with the center of the stopper.

Position the connector of the flat panel sensor as shown in the figure below.

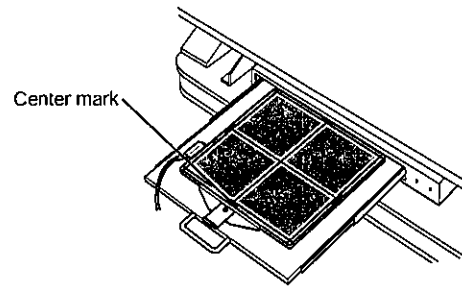
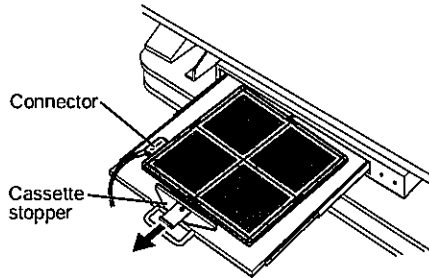

When setting the flat panel sensor horizontally, position the connector as shown in the figure below.

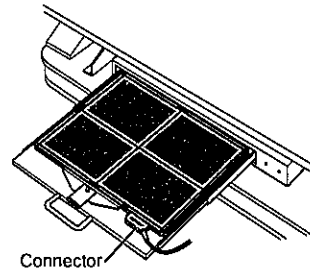

- 3 Push the tray back into place by using the handle after setting the flat panel sensor.

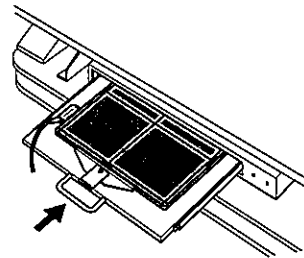

- 4 Remove the flat panel sensor after use.

Hold the handle and pull out the tray. Remove the flat panel sensor while pulling the cassette stopper, and then push the tray back into place.

3.1.6 Changing the Direction of the Flat Panel Sensor Connector

The direction of the connector of the flat panel sensor can be changed, depending on how it is inserted into the radiographic examination stand.

To change the direction, contact a FUJIFILM dealer.

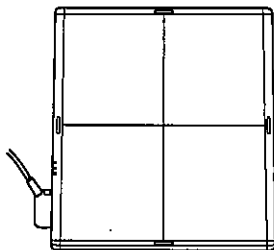

When shipped

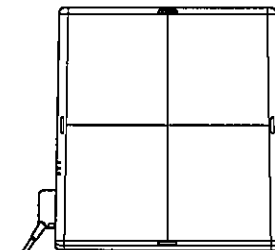

After changing the direction

3.1.7 Charging the Battery Pack (Optional) for the Flat Panel Sensor (DR-ID 601SE, DR-ID 602SE, DR-ID 611SE and DR-ID 613SE)

When used in wireless communication mode, charge the battery pack (optional) using the battery charger (optional).

CAUTIONS

Do not charge the battery pack other than those designated by FUJIFILM Corporation. If the battery pack is charged under the charging conditions (voltage, current and charging method) different from those specified by FUJIFILM Corporation, the battery pack may emit smoke, ignite, explode or leak fluid.

CAUTIONS

When setting the battery pack into the battery charger, make sure that the orientation of the battery pack is correct as shown in the figure in Step 1. If the battery pack is forcibly set in the wrong orientation, both the battery pack and the battery charger may be damaged and emit smoke, ignite, leak fluid or cause electric shock.



When a new battery pack is fully charged, it is possible to perform exposures for a maximum of approximately 750 images for DR-ID 601SE, approximately 500 images for DR-ID 602SE/DR-ID 611SE and approximately 700 images for DR-ID 613SE. However, the number varies depending on the usage conditions.



The capacity of the battery is displayed on the POWER status lamp and in the Console display.



When the remaining capacity of the battery pack becomes less than 10 minutes, a pop-up window appears on the Console, and exposures cannot be performed. If this happens, perform the following operations.

- Replace or charge the battery pack.
- Connect the connector to the flat panel sensor.



When the connector is connected to the flat panel sensor, exposures in wired communication mode and charging the battery pack can be performed.



Charge the battery pack using the battery charger.

In wireless communication mode, when the remaining capacity of the battery pack becomes insufficient, exposures are prohibited and the POWER status lamp blinks every one second. If the flat panel sensor is used in wireless communication mode for another 10 minutes or so, the battery pack is not charged even if the SE cable is connected. If this happens, remove the battery pack and charge it using the battery charger. When the battery pack is charged using the battery charger for about one minute, charging the battery pack by connecting the SE cable become available.

.....

1 Set the battery pack in the battery charger.

When the battery pack is set, a buzzer sound is generated and the charge status indicator LED lights. Three battery packs can be charged at the same time.

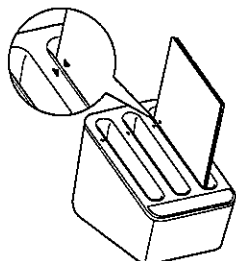

2 When battery charge is completed, remove the battery pack.

When battery charge is completed, the charge status indicator LED changes from blinking to lighting.

3.1.8 Installing/Removing the Battery Pack (Optional) for the Flat Panel Sensor (DR-ID 601SE, DR-ID 602SE, DR-ID 611SE and DR-ID 613SE)

Follow the procedure below to install/remove the battery pack (optional) for the flat panel sensor.



When installing/removing the battery pack, place the flat panel sensor on a flat place.

1 Remove the battery cover.

Place the flat panel sensor with the back side facing upward, and then simultaneously slide both the battery lock release latches outward to remove the battery cover.

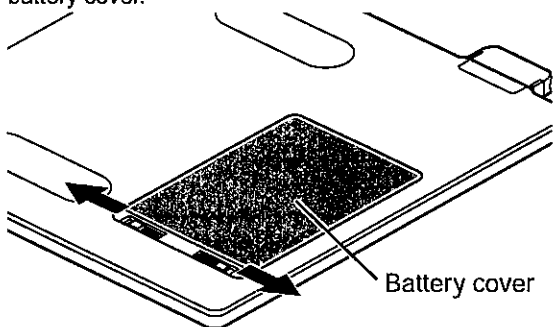

2 Install the battery pack.

Make sure that the battery lock release latches are released.

When the battery lock release latches are released

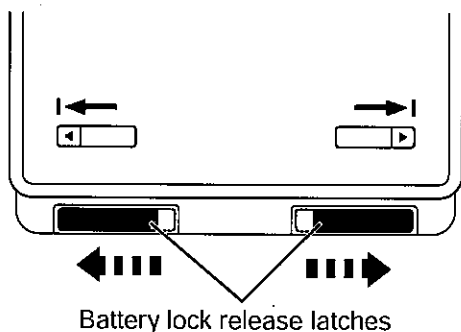

Slide the battery pack along the dent of the battery section of the flat panel sensor toward the connector terminal. Align the guide mark of the battery pack with that of the flat panel sensor, and push the battery pack in to install it.

Make sure that battery pack is securely installed.



Pushing the battery pack in with the guide marks misaligned may damage the connector terminal.



When the battery pack is installed, the power is automatically turned on.

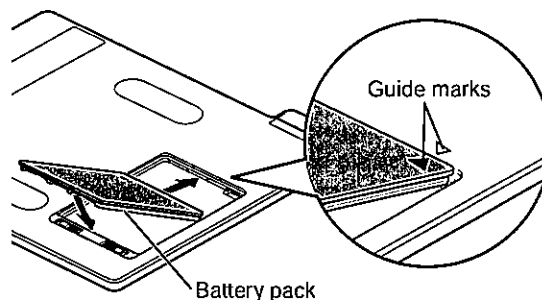

- To remove the battery pack, perform the same procedure as Step 1 (removing the battery cover).
- To install the battery cover, perform the same procedure as Step 2 (installing the battery pack).

3.2 Starting Up and Shutting Down the System

This section explains how to start up and shut down the system. To start up the system, operations are required on the FDR D-EVO main unit and on the Console.

To shut down the entire system, operations are required only on the Console.

3.2.1 Starting Up the System

1 Press the ON side of the main switch of the power supply unit, if its power status LED is not lit.

2 After confirming the following items, press the power switch for the Console to start the initialization process.

- All cables should be connected properly.
- No media should be inserted into the FDD.

If the control cabinet is included in the system, the control cabinet starts up automatically.

CAUTIONS

If the power status LED of the power supply unit does not come on after turning on the Console, turn on the control cabinet.

CAUTIONS

Do not press the ON side of the main switch of the power supply unit while pressing the optional remote switch. Otherwise, the settings may be initialized, and the system may be disabled.

3 Turn on the radiographic examination stand.

4 The Patient Information Input Screen below appears following the opening screen on the Console monitor.

Patient Information Input Screen

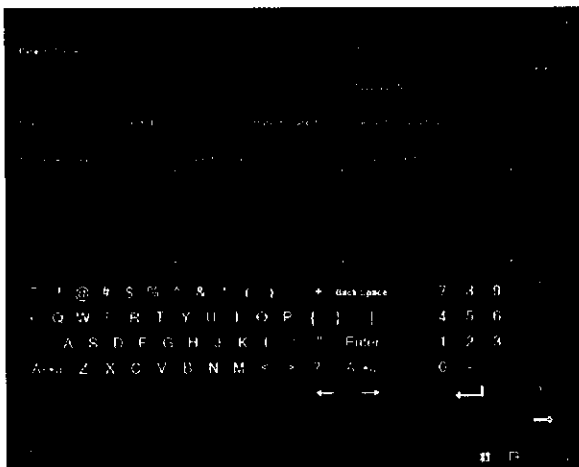

CAUTIONS

An error occurs if the system is started up immediately after shutdown. To restart the system including the control cabinet, make sure that the power status LED of the control cabinet is off, and then press the power switch for the Console.

CAUTIONS

Do not connect/disconnect the connector while the  mark is displayed in the connected devices status after the system startup. Otherwise, the system does not start up normally, resulting in an error.

3.2.2 Shutting Down the System

- 1 Confirm that the equipment is not running. Touch the **(1)** button at the upper right of the Console display, and then the **Shut Down** button from the displayed menu. Touch the **Yes** button in the displayed confirmation window.

The Console will shut down in a few minutes. If the control cabinet is included in the system, the control cabinet will also turn off automatically.

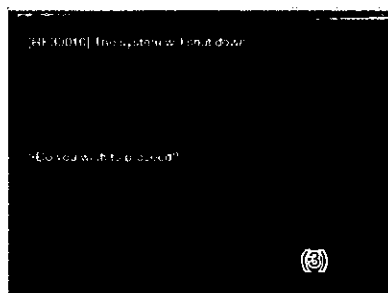
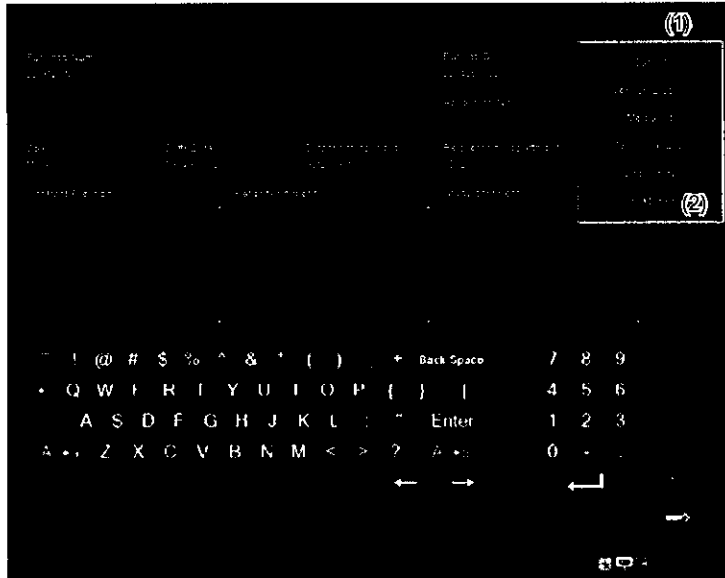

- 2 Turn off the display as necessary.
- 3 Turn off the radiographic examination stand.



Normally, it is not necessary to turn off the power supply unit.



CAUTIONS

If the control cabinet is included in the system, do not turn off the control cabinet with the main switch. Shutdown operation may not be performed normally.



CAUTIONS

When the system is shut down, image quality adjustment is performed for obtaining optimal diagnostic images.

Do not disconnect the connector until system shutdown when the flat panel sensor is used in wired communication mode.

Remove the battery pack after confirming system shutdown when the flat panel sensor is used in wireless communication mode.

3.3 Routine Operations

FDR D-EVO routine operations can be broadly divided into the following three steps.

Step 1 Entering the Patient Information  (See page 3-10.)



Step 2 Selecting the Anatomical Region and Exposure/Study Menu  (See page 3-11.)



Step 3 X-ray Exposure  (See page 3-13.)



Operations that are actually performed on the FDR D-EVO are only those described in " Step 3 X-ray Exposure". Other operations are performed on the Console.

 For details, see "DR-ID 300CL Operation Manual".



Step 1 Entering the Patient Information

1 The Patient Information Input Screen below is displayed on the Console display immediately after startup.

Enter patient information items appropriately, and then touch the  button.

 _____
 Not all the items of patient information need to be input.
 Input any one of the items in order to proceed to the next operation.

 _____
 When the optional card reader is provided, patient information can be input by reading from a magnetic card.

 _____
 Note the followings when the  mark appears in the connected devices status.
 • Do not subject the flat panel sensor to shock.
 • Do not deliver radiation.
 • Do not connect or disconnect the connector.

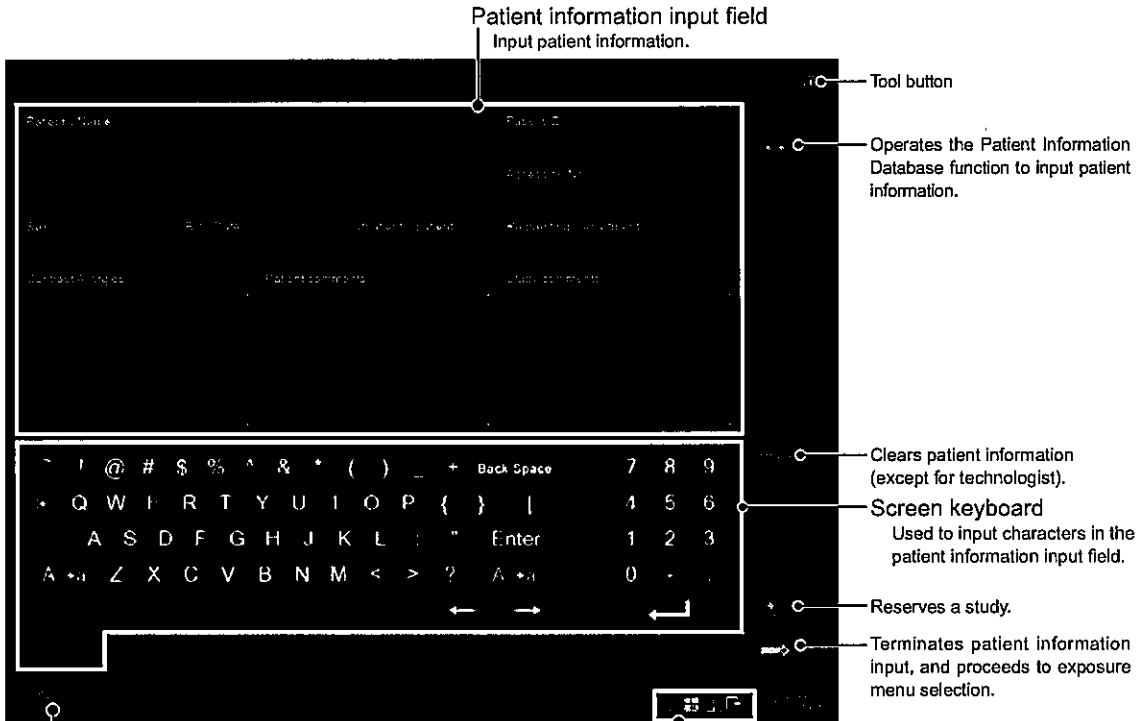

Patient information input field
Input patient information.

Tool button

Operates the Patient Information Database function to input patient information.

Clears patient information (except for technologist).

Screen keyboard
Used to input characters in the patient information input field.

Reserves a study.

Terminates patient information input, and proceeds to exposure menu selection.

Reserves a study. The reserved study is added to the "Waiting Study list".

Connected devices status
Connected devices status display field.
Displays the status of connected devices.

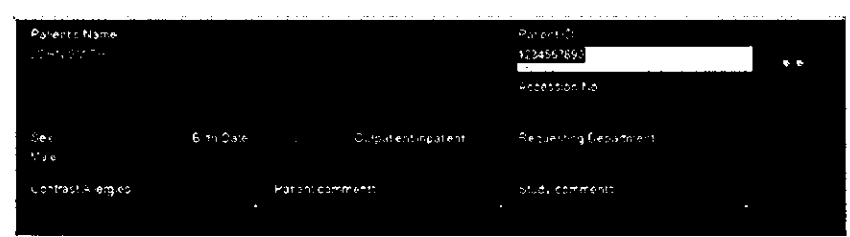

Patient information includes the following items.
 Patient's Name / Sex / Birth Date / Outpatient/Inpatient / Patient ID / Accession No. / Requesting Department / Contrast Allergies / Patient comments / Study comments

 **HINT** _____
 You can change patient information input items and their display order in the User Utility settings.

Step 2 Selecting the Anatomical Region and Exposure/Study Menu

1 The Exposure Menu Selection Screen is displayed.

Select an anatomical region from the display group list, and then select an exposure menu from the exposure menu list registered to the display group on the lower side. (More than one menu can be selected.)

The selected exposure menu(s) is displayed in the selected exposure menu list on the right side of the screen.

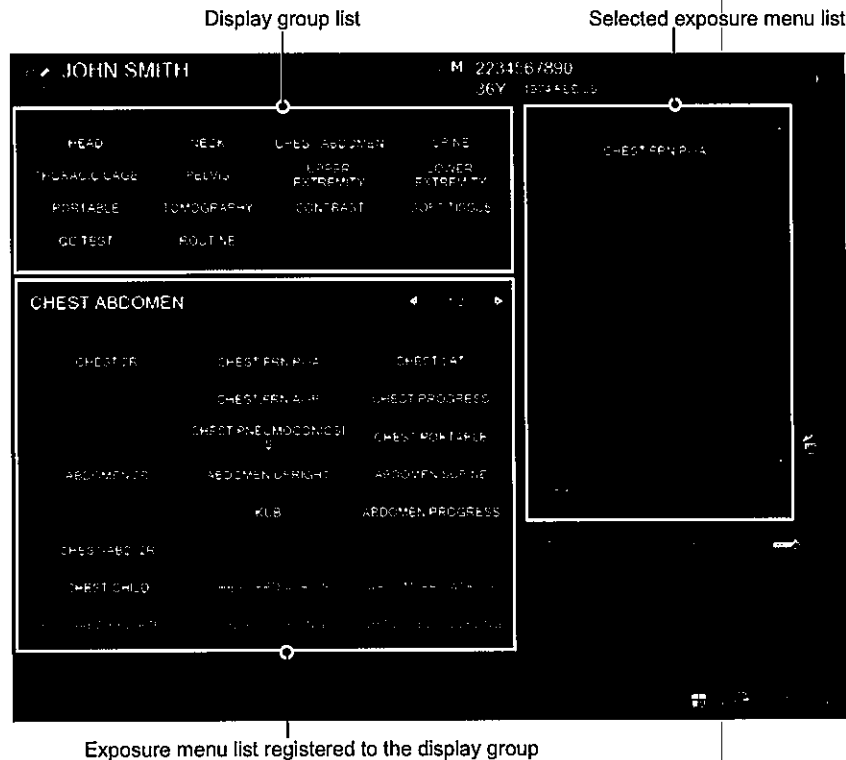

2 Touch after selecting exposure menu(s).

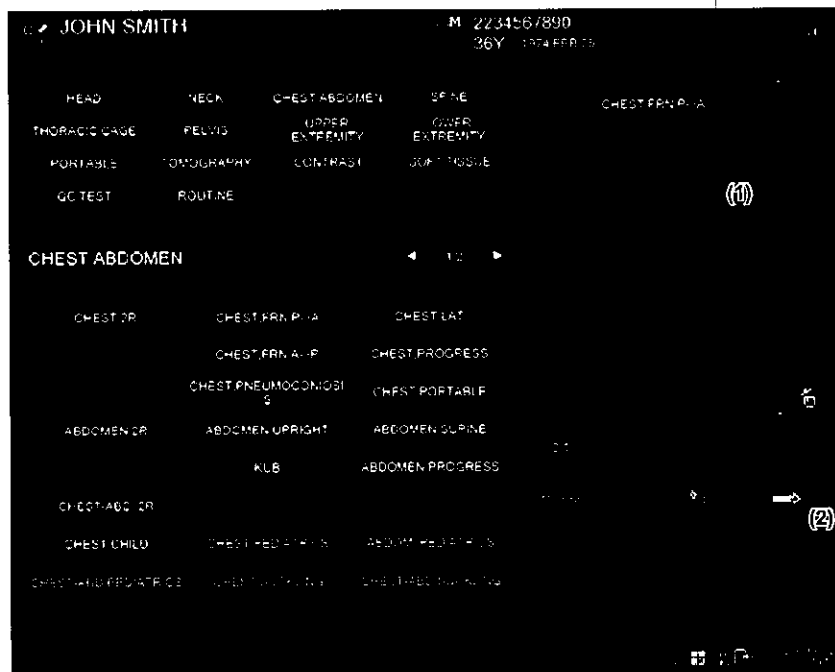

3 The Study Screen is then displayed.



Step 3 X-ray Exposure

When settings on the Console have been completed, you can perform an exposure.



CAUTIONS

- Make sure to identify a patient against the name or birth date and then have him (her) take a proper positioning for exposure.
- Make sure to confirm the exposure menu to be used and then have a patient take a proper positioning for exposure.
- When multiple panels are used, make sure that the READY status lamp on the flat panel sensor is lit in order to confirm that it is the correct one for the selected technique.
- Do not connect/disconnect the cable after starting exposure operations. Otherwise, it may not be possible to make an exposure or obtain a normal image.

[1] Positioning the patient

Position the patient.



CAUTIONS

Exercise due care so that an intravenous line or drain tube put to a patient does not hook into the equipment.



For the exposure position of the upright-type/bed-type radiographic examination stand, see its Operation Manual.

When making an exposure directly using the flat panel sensor, set the exposure position by reference to the effective area.

- For details on the effective area, see page A-5.

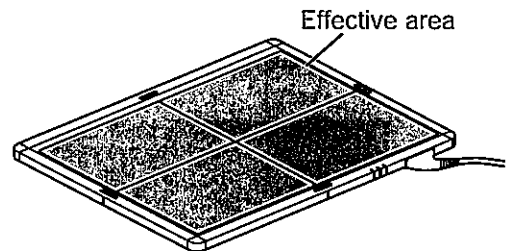

[2] X-ray exposure/Image displaying



Make an exposure after confirming that Shot Ready (exposure ready status indicator) is lit green in the connected devices status of the Console.

Exposed images are transferred to the Console.

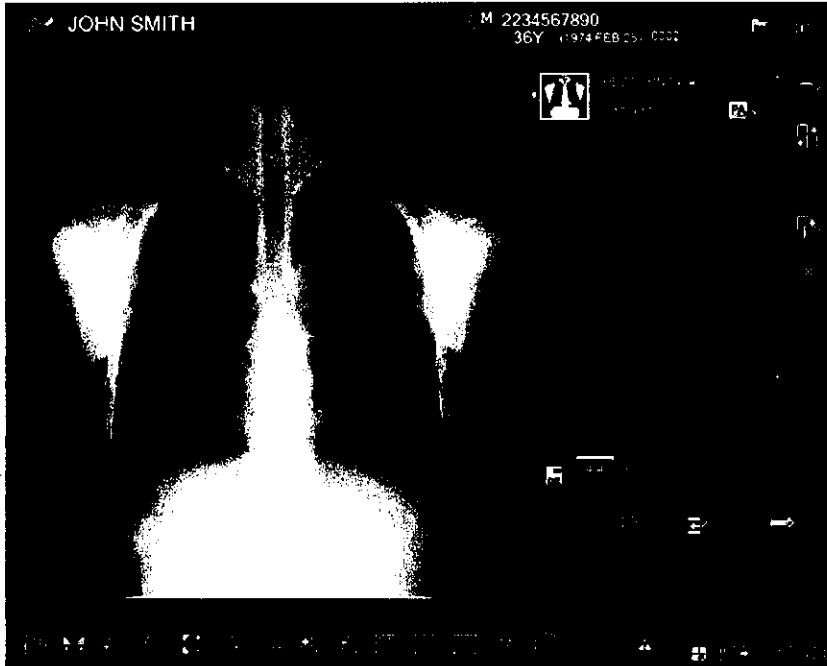

Touch the  button at the lower right to complete the study.

To prepare for exposures of the next patient, repeat **Step 1** through **Step 3**.



The registration of the next new patient should be processed after more than 2 seconds.

[3] Sleep mode

If a specified period of time has elapsed without registering an exposure menu when sleep mode is enabled, the flat panel sensor will enter sleep mode.

Once an exposure menu(s) is registered, sleep mode is disabled automatically.

Make sure that the READY status lamp is lit after registration.



When sleep mode is enabled, the flat panel sensor in wireless communication mode can go into hibernation. The operating time of the battery pack becomes longer, as the power consumption is reduced during hibernation. For details on the sleep mode setting, contact a FUJIFILM dealer.



Basic Operation

Chapter 4 Troubleshooting

4.1 When a Message Appears on the Console

This section describes the warning dialog box and error messages.

If an error which cannot be handled or the same error recurs frequently, contact a FUJIFILM dealer.

If an error of unknown cause occurs, do not continue the operation and contact a FUJIFILM dealer.

[1] If a warning dialog box appears

If a communication error or an unexpected error has occurred, a warning dialog box pops up on the screen. In such a case, after checking error details and closing the box, take appropriate action immediately. Be sure not to continue the operation of the Console without taking an appropriate action. If any operation is performed while a warning dialog box is displayed, another screen may be displayed, hiding the dialog box behind. In this case, press the [Enter] key to close the hidden box. If a warning dialog box containing an error code starting with "10" is displayed, take action as instructed in the dialog box, and select [OK]. Remove the battery pack from all the flat panel sensors. After making sure that the flat panel sensors are turned off, install the battery pack back in each flat panel sensor, and then restart the system.

[2] If a communication error occurs between the Console and the connected DR system

The error message box MD11001 is displayed not only when the Console starts up but also when a communication error occurs.

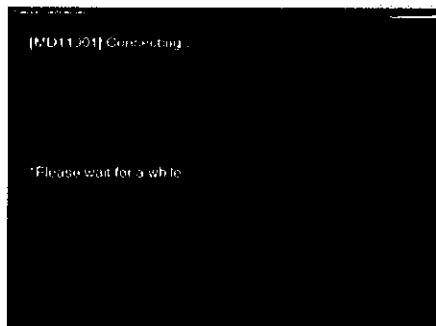

When the problem is not solved within a short time after the message box is displayed, perform the following procedure.

- 1** Select [OK] on the message box.
- 2** Check if the equipment connected with the Console is turned on.
If any equipment is turned off, turn it on and wait for a while.
- 3** If the problem is not solved, shut down the Console.
- 4** Make sure that the power status LED of the control cabinet is off, and then restart the Console.

This step is not required if the control cabinet is not included in the system.



If the power status LED of the control cabinet does not turn off even after approximately 10 minutes have passed following the shutdown of the Console, press and hold the main switch of the control cabinet.

When the Console is restarted and the same error message box is displayed, contact a FUJIFILM dealer.

[3] If Wireless Communication is Interrupted When Using the Flat Panel Sensor (DR-ID 601SE, DR-ID 602SE, DR-ID 611SE and DR-ID 613SE)

If wireless communication is interrupted, an error message prompting reconnection is displayed after 30 seconds. To acquire the image data again, select "Yes".

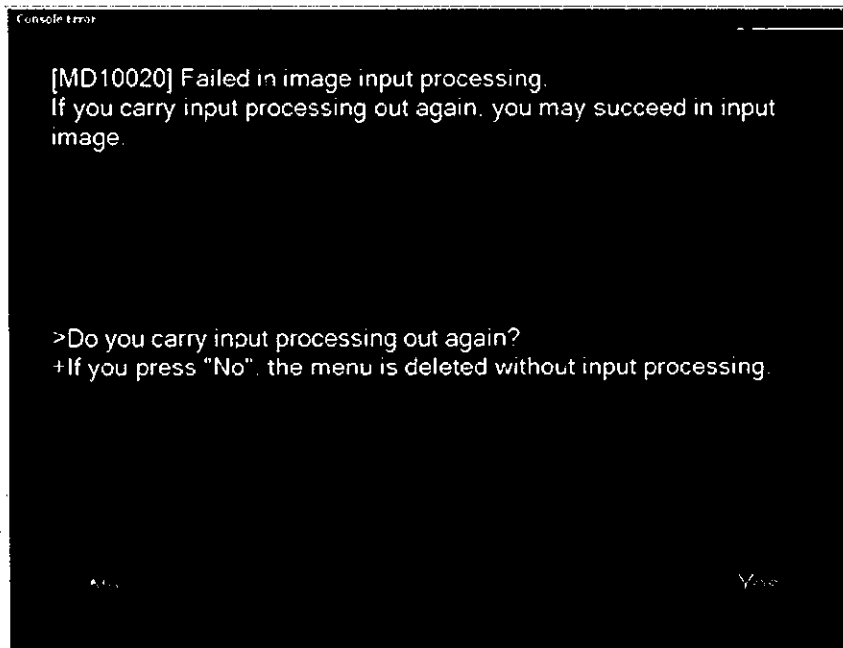

In case that the image data cannot be acquired even after selecting "Yes", connect the wired communication cable (if you have one) to the flat panel sensor, and then select "Yes".



When wireless communication is interrupted, the image data is maintained in the flat panel sensor (DR-ID 601SE, DR-ID 602SE, DR-ID 611SE and DR-ID 613SE) until transmission is completed or power supply of flat panel sensor is turned off, so image data will not be lost. If you select "No", the image data will be lost.

[4] If an error occurs on the Console

If an error occurs on the Console, an error message box is displayed on the screen. In such a case, check error details, and then take an appropriate action.

[5] If an error occurs on an output destination device

If an error occurs on an output destination device,  is displayed in the connected devices status. In such a case, operate as follows.

Select .

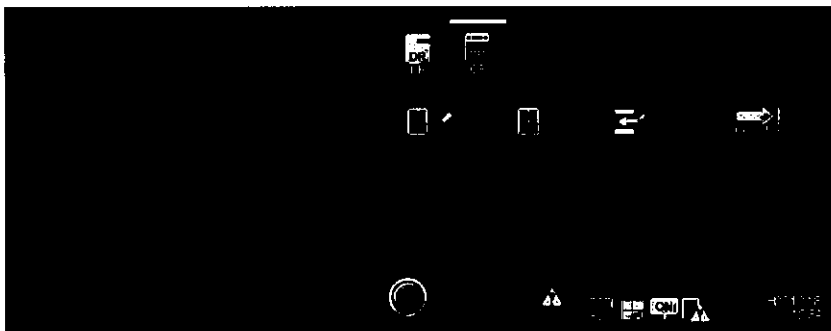

The "Output Device Status window" is displayed.

Select  after checking the connection status, and then take an appropriate action.

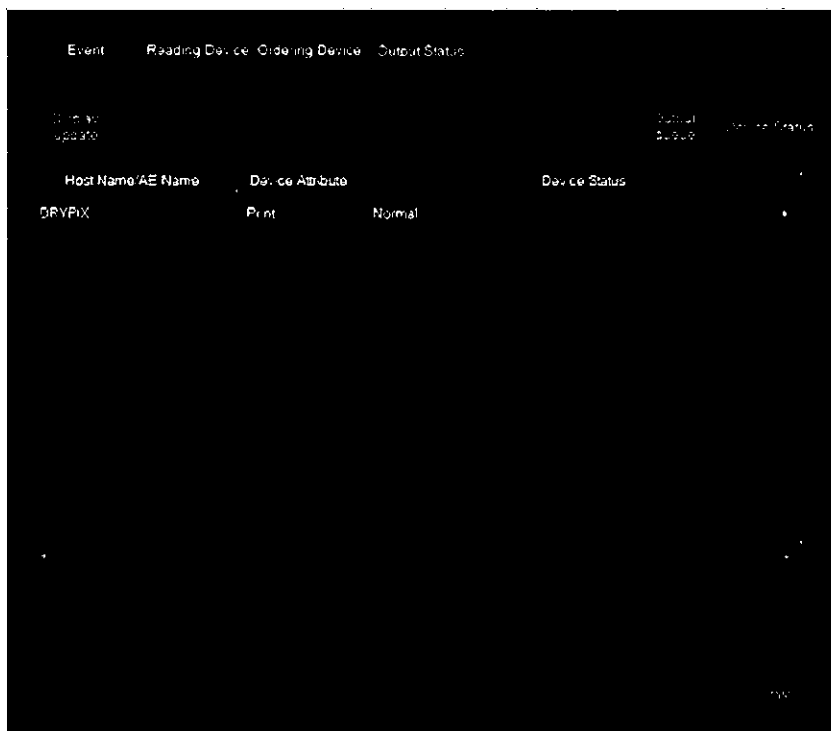

"Output Device Status window"

[6] If the dialog box containing the error message numbered 13048 appears

A severe shock may have been applied to the flat panel sensor. If the error message numbered 13048 appears, check if the flat panel sensor is damaged before continuing operation. Note that this error is recorded in the equipment.

4.2 How to Cope with an Error...

[1] When the system hangs up...

If an inappropriate processing is performed while this equipment is operating, the screen may freeze and the system may hang up (processing disabled). In that case, shut down the equipment forcibly according to the following procedure, and then restart it.



If the screen freezes and a hang-up occurs, remove the keyboard and mouse and reconnect them. If this operation does not solve the problem, restart the Console.

1 Press the [Ctrl] + [Alt] + [Del] keys simultaneously.

2 "Windows Security" is displayed.

Select [Start Task Manager].

3 "Windows Task Manager" is displayed.

Select "ProcessManagerMain.exe" in the list in the "Processes" tab, and then click [End Process].

4 The message box is displayed.

Click [End Process] to terminate the Console.

Depending on equipment status, an error message may not be displayed.

5 The desktop screen of the operating system is displayed.

Close the "Windows Task Manager window", and then select the [Start] button at the lower left of the screen. Select [Restart] from the displayed menu.



CAUTIONS

- Make sure to shut down the system following the above procedures in case of a hang-up of the Console. If the personal computer is turned off without shutdown, an error may occur on the computer.
- Note that forcible shutdown processing of the equipment is an emergency action. Do not use this action under normal situations.

6 If the control cabinet is included in the system, press and hold the main switch of the control cabinet to turn it off.

7 Press the OFF side of the main switch of the power supply unit.

[2] When the Console is turned off due to an electrical outage

When the Console is turned off due to an electrical outage, etc., take the following actions according to the condition when the power comes back on.

■ If the power comes back on soon after an electrical outage

Wait until the Console restarts.

When the Console has restarted, shut down the Console by following the normal procedure.

● For details of system shutdown, see the "DR-ID 300CL Operation Manual".

To restart the Console, follow the procedure for the system startup.

[3] If a hard disk of the Console is damaged

If one of the hard disks is damaged, a window indicating so will appear. In such a case, press the F1 key and contact our official dealer.

[4] If a white image is displayed after an exposure

If a white image is displayed, a LAN communication error may have occurred. Check if the LAN communication connectors are properly connected between the flat panel sensor and the power supply or and between the power supply unit and the control cabinet. Make an exposure again after confirmation.

[5] Precautions for operation when the device status is “Initializing” or “Changing FPD” in the Console’s “Output Device Status window”

When a flat panel sensor is added or replaced or when the battery of a flat panel sensor is replaced, “Initializing” or “Changing FPD” is displayed for all the flat panel sensors in the device status field of the Console’s “Output Device Status window”. While either of the status messages is displayed, you cannot make an exposure. Wait until the message disappears.



Even if “Initializing” or “Changing FPD” is displayed for all the flat panel sensors, only those which are added or replaced or those whose battery is replaced will be initialized.

[6] If wireless communication with the flat panel sensor (DR-ID 601SE, DR-ID 602SE, DR-ID 611SE and DR-ID 613SE) is not possible

If the flat panel sensor is not recognized in a wireless communication mode, use the cable to connect the system in wired communication mode.

[7] If wireless communication is interrupted when using the flat panel sensor (DR-ID 601SE, DR-ID 602SE, DR-ID 611SE and DR-ID 613SE)

- 1** If wireless communication is interrupted, an error message prompting reconnection is displayed after 30 seconds. Select “Yes” to reconnect.
- 2** If wireless connection is not established even after the selection is made, use the cable (wired connection) to transmit the image.
- 3** If wireless re-connection is not established, contact a FUJIFILM field service engineer.



When wireless communication is interrupted, the image data is maintained in the flat panel sensor (DR-ID 601SE, DR-ID 602SE, DR-ID 611SE and DR-ID 613SE) until transmission is completed or power supply of flat panel sensor is turned off, so image data will not be lost.



Troubleshooting

Chapter 5 Daily Inspection and Maintenance

5.1 Daily User Inspection and Maintenance

During maintenance and inspection, strictly observe precautions contained in "Chapter 1 For Safe Operation" in this manual for you to use the FDR D-EVO under best conditions.

5.1.1 Daily Inspection (DR-ID 600)

Inspection Before Use

- Make sure that the equipment starts up normally.
- Make sure that the equipment communicates with connected devices normally.
- Make sure that the time displayed is correct.
- ▶ See "3.2 Starting Up and Shutting Down the System" (page 3-7).

Inspection During Use

- Make sure that images are output normally.
- ▶ See "3.3 Routine Operations" (page 3-9).

Inspection After Use

- Make sure that the power turns off normally by shutting down the equipment.
- ▶ See "3.2 Starting Up and Shutting Down the System" (page 3-7).

Cleaning instructions

Use a neutral detergent or ethanol to clean the outer surfaces.



CAUTIONS

- Do not use a solvent such as thinner or benzene, as it corrodes the outer surfaces.
 - Make sure not to let water, detergent and ethanol get inside the equipment.
-

5.1.2 Periodical Inspection

Inspection Every Three Months

Using a vacuum cleaner, remove any dirt or dust accumulated in each unit of the equipment once every three months. Clean then with a slightly moistened soft cloth and wipe off any moisture with a dry cloth.

① See "2.2 Unit Names and the Functions" (page 2-3).

■ DR-ID 600

DR-ID 600PU

NO.	Unit	NO.	Unit	NO.	Unit
1	Flat panel sensor	2	Power supply unit	3	Power supply unit Air filter (1)
4	Remote switch (optional)				

Air filter

Clean the air filter on the rear of the power supply unit with a vacuum cleaner. Push down the lever at the top of the louver-and-filter assembly, and clean the air filter with a vacuum cleaner after detaching it from the assembly.

Remote switch (optional)

Clean the surface of the remote switch (optional) with a dry cloth, etc.



Be sure to turn off the equipment before cleaning the air filter or the remote switch (optional).

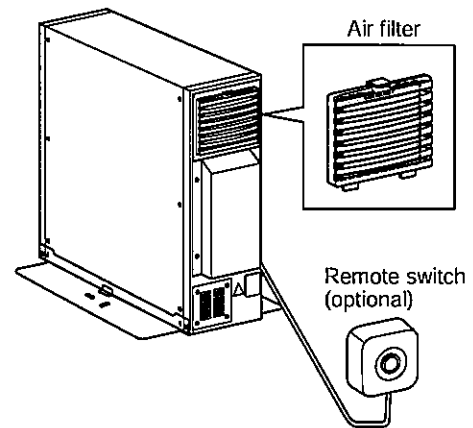

DR-ID 600MC

NO.	Unit	NO.	Unit
1	Control cabinet	2	Periphery of devices

Optional

NO.	Unit	NO.	Unit
1	Battery charger	2	Battery pack

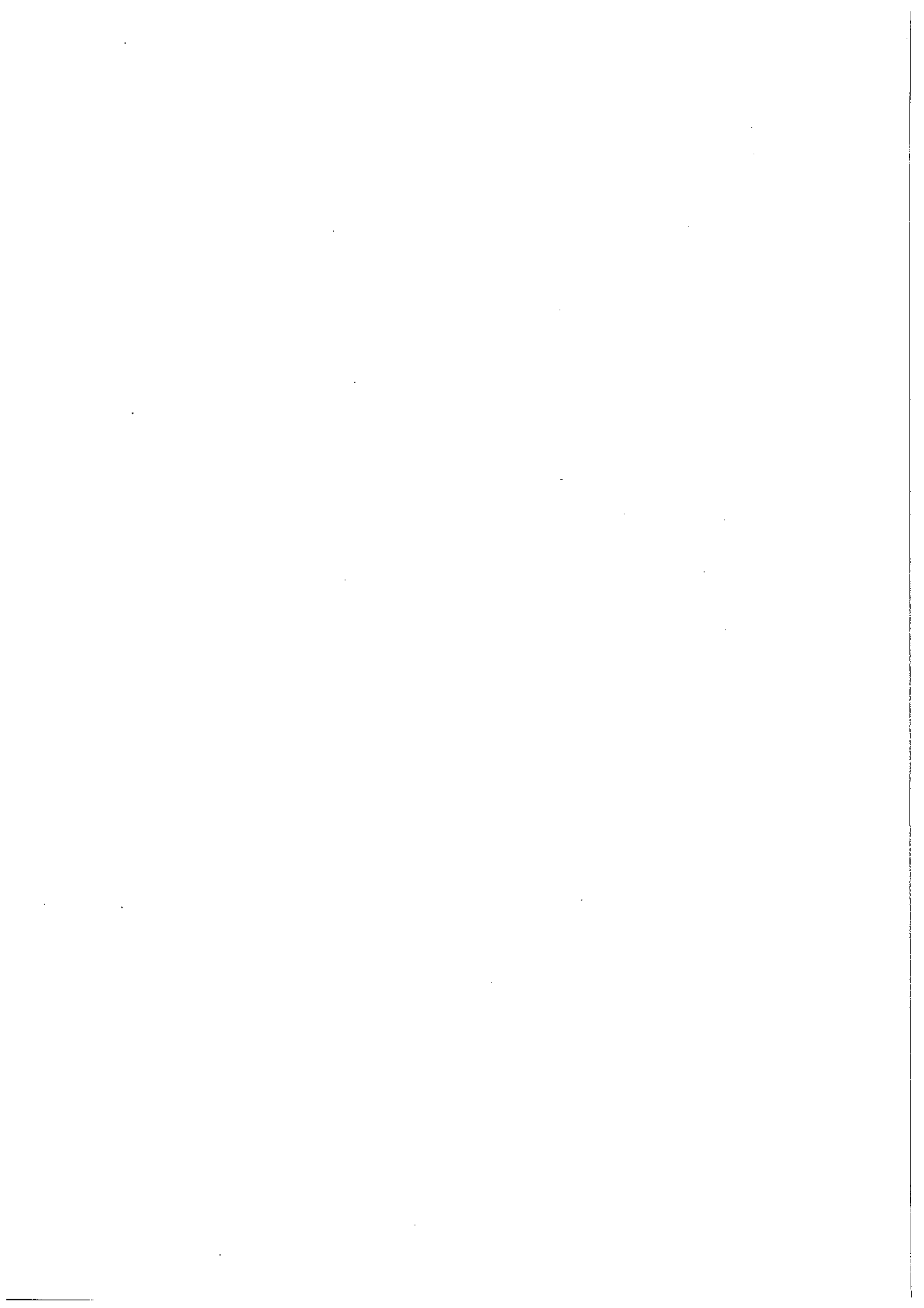

Appendix A Specifications

A.1 Specifications

Specifications of the FDR D-EVO are shown below.

A.1.1 Processing Capacity (DR-ID 600)

- Routine processing (when the two-image output format is used in standard mode)

(1) Exposure interval

The exposure interval of the FDR D-EVO is at least 8 seconds.

However, the interval varies depending on the region, the load to network communication, etc.

A.1.2 Image Output (DR-ID 600)

- Standard processing

(1) Film output

Connection to the Imager makes it possible to obtain hard copies at the image reduction ratios and in the formats below.

- For standard pixel-density images (DR-ID 600SE, DR-ID 601SE, DR-ID 611SE and DR-ID 613SE)

Output size	Reduction ratio	
	Two-image output	One-image output
14" × 17" (35 × 43cm)	61%	100%
14" × 14" (35 × 35cm)	61%	100%
10" × 12"	85%	100%
8" × 10"	100%	100%
18 × 43cm	100%	100%

- For standard pixel-density images (DR-ID 602SE)

Output size	Reduction ratio	
	Two-image output	One-image output
17" × 17" (43 × 43cm)	50%	82%
14" × 17" (35 × 43cm)	61%	100%
14" × 14" (35 × 35cm)	61%	100%
10" × 12"	85%	100%
8" × 10"	100%	100%
18 × 43cm	100%	100%

[Fig. A.1]

(a) 14" × 17"
one-image output

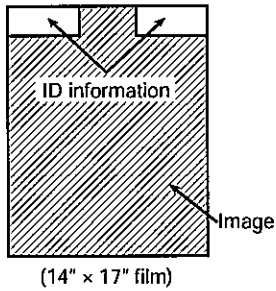

(b) 17" × 14"
one-image output

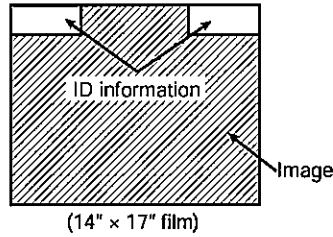

(c) 14" × 14"
one-image output

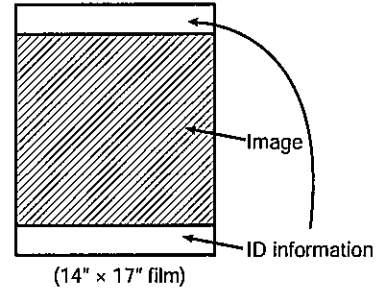

(d) 18 × 43cm
one-image output

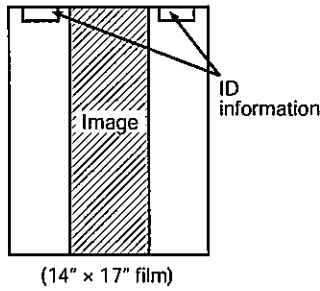

(e) 18 × 43cm
two-image output

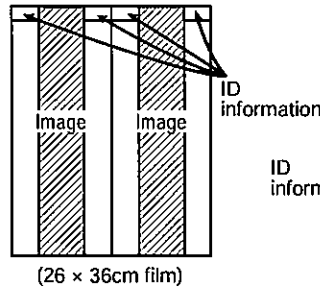

(f) 18 × 43cm
two-image output

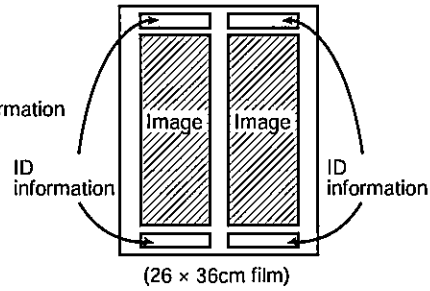

(g) Two-image output

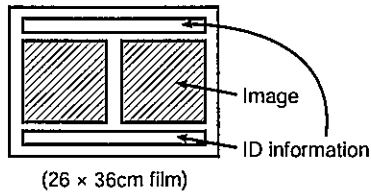

For one-image output using 17" × 14", 14" × 17", 14" × 14" or 18 × 43cm, images are output on 14" × 17" film. In other cases, images are output on 26 × 36cm film.



Depending on the printer connected or Console software version used, image outputs in the following formats are available.

- 100%-size output of 14" × 14" image on 14" × 14" film
- 100%-size output of 8" × 10" image on 8" × 10" film, as well as reduced image output on films of other sizes
- 100%-size output of 10" × 12" image on 10" × 12" film

A.1.3 Reduced Equivalent (DR-ID 600)

Peak reduced equivalent on the front panel of the flat panel sensor: 0.5 mmAl

A.1.4 Power Supply Conditions

■ DR-ID 600PU

Rated voltage: 100-240V \pm 10% ~

Input current : 1-0.42A

Frequency : 50-60Hz

■ DR-ID 600MC*

Rated voltage: 115/230V ~

Input current : 4.0/2.0A

Frequency : 50-60Hz

* Since the DR-ID 600MC is general-purpose electrical equipment, the electric rating above is an example.

A.1.5 Environmental Conditions

■ DR-ID 600PU

(1) Operating Conditions

Temperature : 15°C (15%RH) - 30°C (80%RH)

Humidity : 15%RH (15°C) - 80%RH (30°C) (no dew condensation)

Atmospheric pressure : 700hPa - 1060hPa

(2) Non-operating Conditions

(Environmental conditions under which power can be supplied)

Temperature : 5°C - 35°C (no dew condensation)

Humidity : 10%RH - 80%RH (no dew condensation)

Atmospheric pressure : 700hPa - 1060hPa

■ DR-ID 600MC

(1) Operating Conditions

Temperature : 10°C - 35°C

Humidity : 20%RH - 80%RH (no dew condensation)

Atmospheric pressure : 700hPa - 1060hPa

(2) Non-operating Conditions

(Environmental conditions under which power can be supplied)

Temperature : -40°C - 65°C

Humidity : 5%RH - 95%RH (no dew condensation)

Atmospheric pressure : 700hPa - 1060hPa

A.2 External View and Weight

The external view and weight of the FDR D-EVO are shown below.



Specifications, dimensions and weight are subject to change for improvement without prior notice.

A.2.1 DR-ID 600

■ DR-ID 600PU

	Width (mm(in.))	Depth (mm(in.))	Height (mm(in.))	Weight (kg(lb))
Flat panel sensor (DR-ID 600SE)	460(18.1)	384(15.1)	14(0.55)	2.8(6.2)
Flat panel sensor (DR-ID 601SE)	460(18.1)	384(15.1)	14.8(0.58)	3.3(7.2)*
Flat panel sensor (DR-ID 601SE (for wired communication only))	460(18.1)	384(15.1)	14.8(0.58)	3.2(7.1)
Flat panel sensor (DR-ID 602SE)	460(18.1)	460(18.1)	15.4(0.61)	4.0(8.8)*
Flat panel sensor (DR-ID 602SE (for wired communication only))	460(18.1)	460(18.1)	15.4(0.61)	3.9(8.6)
Flat panel sensor (DR-ID 611SE)	460(18.1)	384(15.1)	15.5(0.61)	3.6(7.9)*
Flat panel sensor (DR-ID 611SE (for wired communication only))	460(18.1)	384(15.1)	15.5(0.61)	3.4(7.5)
Flat panel sensor (DR-ID 613SE)	268(10.6)	328(12.9)	15.5(0.61)	2.3(5.1)*
Flat panel sensor (DR-ID 613SE (for wired communication only))	268(10.6)	328(12.9)	15.7(0.62)	2.2(4.9)
Power supply unit	120(4.7) (240(9.4))	350(13.8) (385(15.2))	350(13.8)	7.8(17.2)

* The weight of the battery pack is included.

Unit: mm(in.)

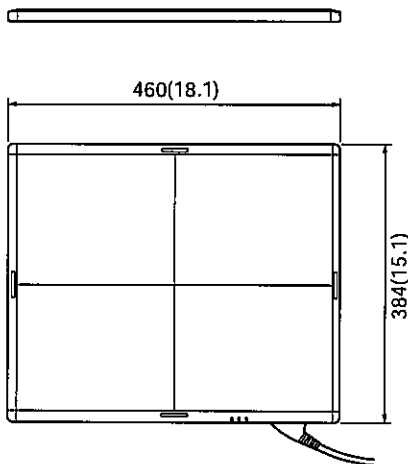

Flat panel sensor
(DR-ID 600SE)

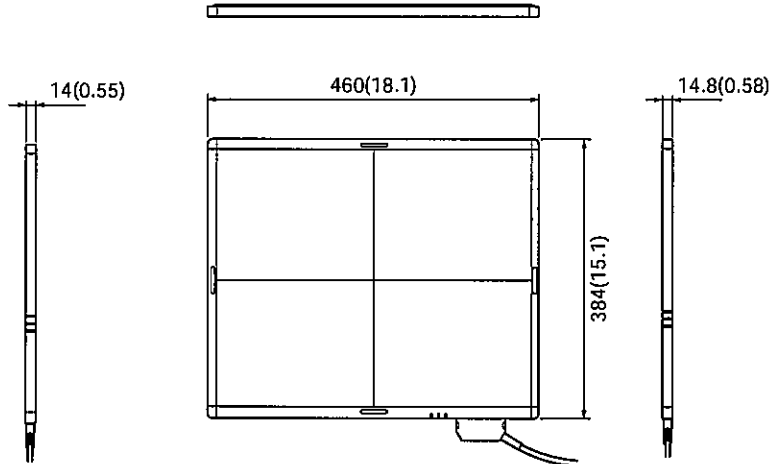

Flat panel sensor
(DR-ID 601SE)

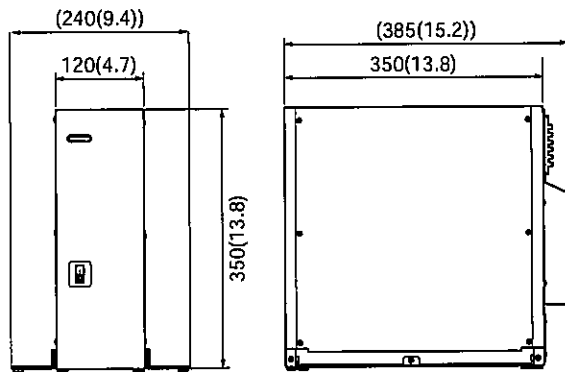
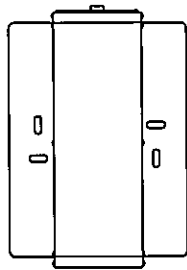
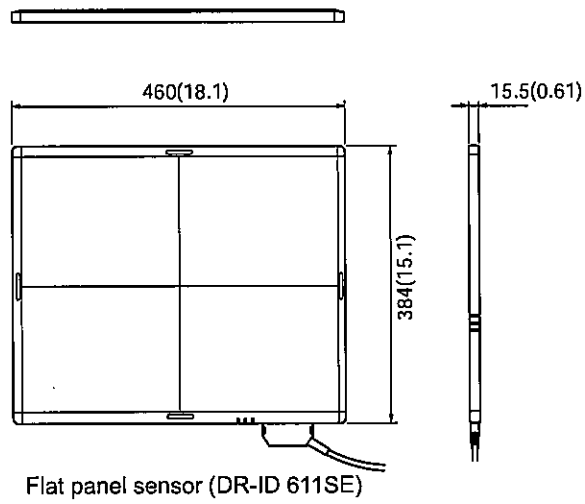
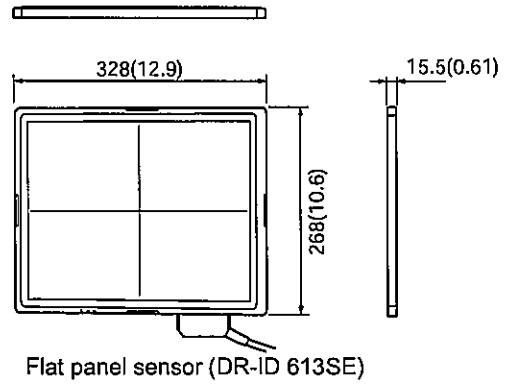
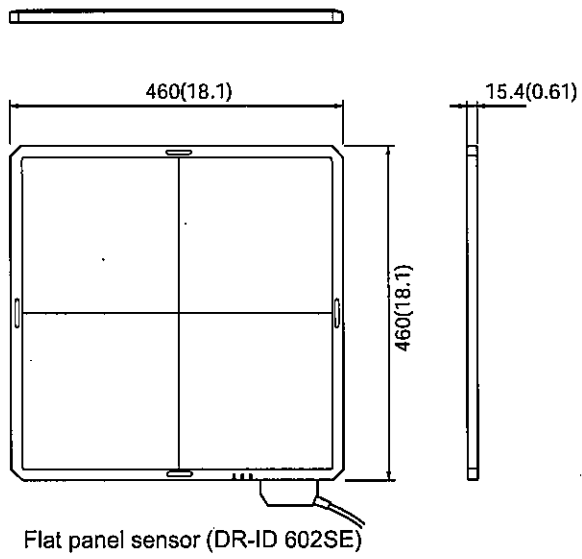

Power supply unit



The effective area of the flat panel sensor is as shown in the figure below

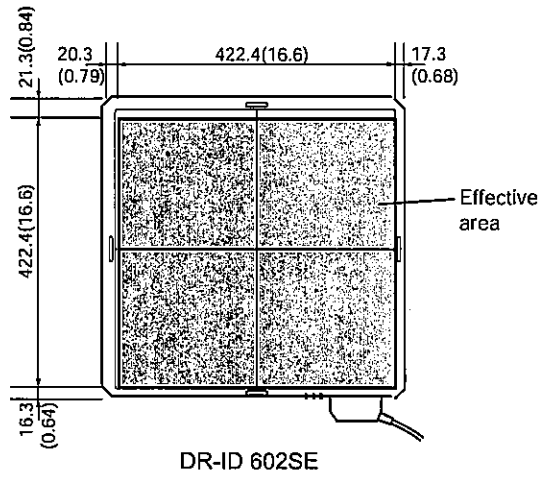
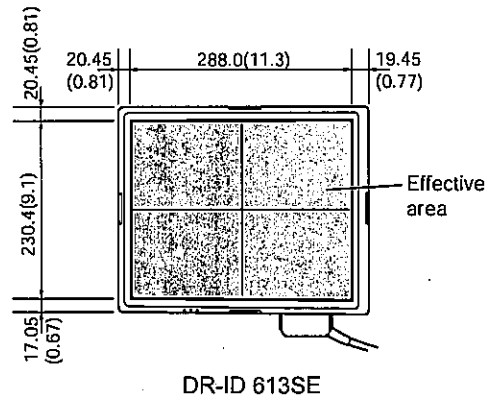
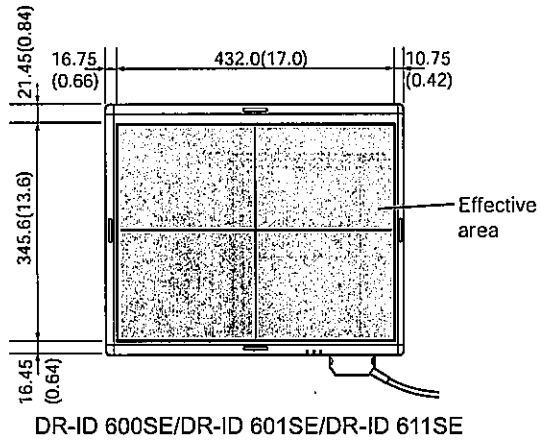

■ **DR-ID 600MC**

	Width (mm(in.))	Depth (mm(in.))	Height (mm(in.))	Weight (kg(lb))
Control cabinet	114(4.5)	353(13.9)	399(15.7)	8.3(18.3)

Unit: mm(in.)

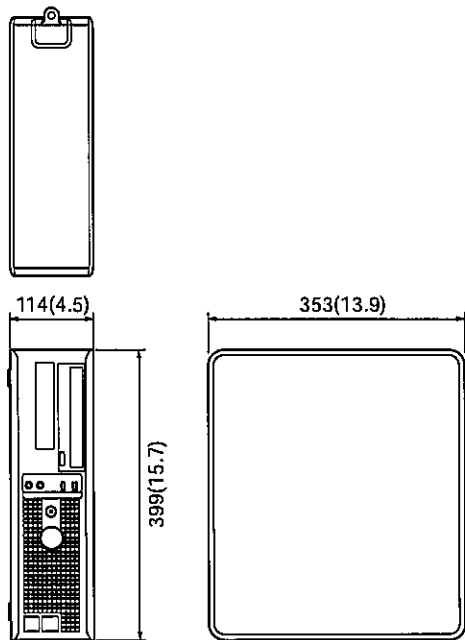

Control cabinet

■ **Battery charger**

	Width (mm(in.))	Depth (mm(in.))	Height (mm(in.))	Weight (kg(lb))
Battery charger	120(4.7)	220(8.7)	138(5.4)	1.3(2.9)

Unit: mm(in.)

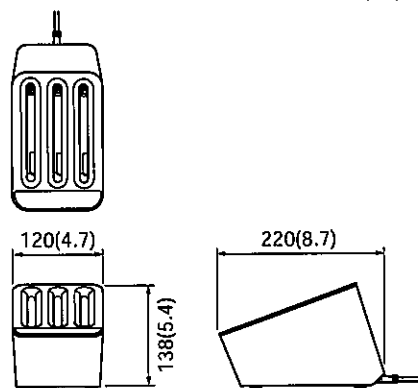

Battery charger

■ **DR-ID 300CL**

🔍 For the external view and weight of the DR-ID 300CL, see the "DR-ID 300CL Operation Manual".

Appendix Z Precautions for Exposure

Z.1 Precautions for Exposure in AUTO MODE

In AUTO MODE, stable image output can be obtained by means of the following.

- (1) Radiation field
- (2) EDR image data analysis
- (3) Detailed depiction of the cervical region

However, problems may arise due to differences in the multiple diaphragms or scattered rays of the X-ray equipment. For such problems, contact a FUJIFILM dealer and use other recording modes, such as SEMI-AUTO MODE or FIX MODE.

Z.1.1 Radiation Field

- 1 Do not set the radiation field extremely small. Be sure to subject one-third or more of the length of each side of the bucky of the DR system to X-ray exposure.
- 2 Make sure that none of the sides of the radiation field overlap with the contrast medium. Errors will result if they overlap.

Available for Each Anatomical Region/Method

	Plain	Contrast Medium	Tomography
Head	4	4	4
Neck	4	4	—
Chest	4	4 (1 for esophagus)	—
Abdomen	4	4 (1 for stomach and intestines)	—
Pelvis	4	4	—

3 Notes on PRIEF

- [PRIEF 4] Used, with some exceptions, for both plain and contrast medium exposure menus, from the head to the pelvis.
The diaphragm shape will be any convex polygon, including rectangles, circles, ellipses, tracks, etc.



- [PRIEF 1] Used with esophagus, stomach and intestines contrast medium menus.

Z.1.2 Depiction of the Cervical Region

- 1 The radiation field must not include the whole head. Be sure to secure transparent portions on both sides of the neck.

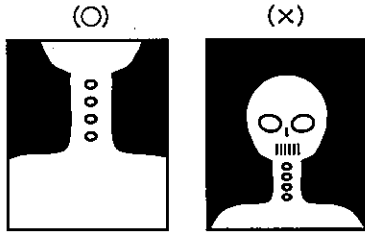

Use the "Head" menu to include the whole head in the radiation field.

- 2 For exposure of the pharynx or larynx, be sure that the neck comes to the center of the radiation field so that the frontal and lateral orientations can be recognized appropriately.

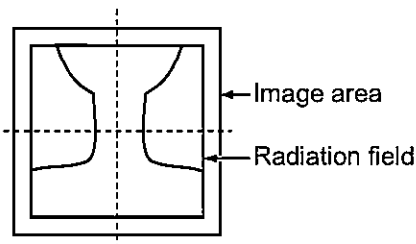

- 3 In pharynx and/or larynx exposure, do not use lead characters in the oblique line section.

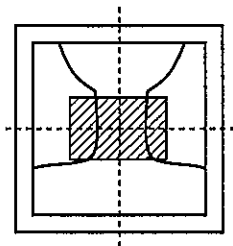

Z.1.3 Depiction of the HIP JOINT AXL – 2 Menu

- 1 Make sure to position the region of interest within the slanted-line area shown below. Do not collimate further inside.
- 2 Positioning should be done so that the condyle and the femur run along the longer edge. (Do not position them against the shorter edge.)

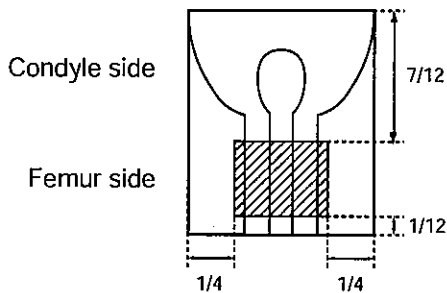

Z.1.4 EDR Image Data Analysis

- 1 Image unevenness due to grid misalignment, X-ray beam misalignment, or metal objects may cause EDR image data analysis problems resulting in unstable density on the image.
- 2 If the target includes such materials as gypsum, denture, etc., stable density may not be obtained, because such materials make it difficult to analyze EDR image data.
In such cases, use FIX MODE.
- 3 The EDR performs processing for the image area trimmed by the DR system.
When using lead characters or metals for measurement, place them inside the radiation field, and then make an exposure.
- 4 Precautions when using AUTO MODE.

Auto mode	Precautions
I	As this mode is available for extracting information on the skin, secure the positioning so that the direct X-rays are incident to an area other than the target.
II	No special precautions.
III	Be sure to use a Ba contrast medium.
IV	1 Be sure to secure the positioning so that the X-rays are incident to the area directly outside the target. 2 As the reading latitude is fixed, it is necessary to control the tube voltage according to the thickness of the target, as usual.
V	As the reading latitude is fixed, it is necessary to control the tube voltage according to the thickness of the target, as usual.
VI	No special precautions.
VII	No special precautions.

Z.2 Precautions for Exposure in SEMI-AUTO MODE

These precautions are common to Semi I, II, III and III(**).

- 1 Position the portion you need to display often in the center areas (10cm × 10cm(3.9 in. × 3.9 in.) (Semi I), 7cm × 7cm(2.8 in. × 2.8 in.) (Semi II), 5cm × 5cm(2.0 in. × 2.0 in.) (Semi III)) of the images trimmed by the DR system.

Position the portion you need to display often in each of the 5cm × 5cm(2.0 in. × 2.0 in.) center areas of the half-split images (both upper and lower halves and right and left halves) and quarter-split image trimmed by the DR system.

- 2 Never position anything other than the subject in the aforementioned areas. If anything other than the subject is positioned in such areas, the image density will become lower.

In addition, do not position any metals or artificial bones in such areas. The image density will become higher if such objects are positioned in these areas.

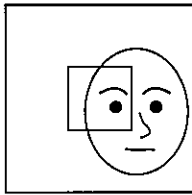

(x)

- 3 It is necessary to control tube voltage according to subject thickness, as usual. The following precautions should be observed for Semi IV.

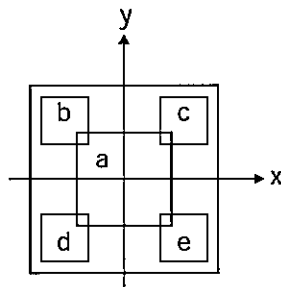

Area	Center Coordinate (x:y) cm(in.)	Size (cm(in.))
a	(0(0), 0(0))	10 × 10(3.9 × 3.9)
b	(-5(-2.0), 7(2.8))	6 × 6(2.4 × 2.4)
c	(5(2.0), 7(2.8))	6 × 6(2.4 × 2.4)
d	(-5(-2.0), -7(-2.8))	6 × 6(2.4 × 2.4)
e	(5(2.0), -7(-2.8))	6 × 6(2.4 × 2.4)

- (1) Do not position transparent portions (areas other than the subject) in the aforementioned five areas.

- (2) It is necessary to control tube voltage according to subject thickness, as usual.

- For details of the menus preset in SEMI-AUTO MODE, see the "DR-ID 300CL Operation Manual" and "DR-ID 300CL Reference Guide (Image Processing Parameters)".

Z.3 Precautions for Exposure in SEMI-X MODE

The user will select one of the nine areas of the image trimmed by the DR system, on which SEMI-AUTO MODE applies. (See the illustration below.)

The same precautions as for SEMI-AUTO MODE apply.

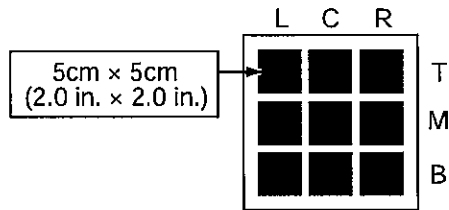

Z.4 Precautions for Exposure in FIX MODE

As reading conditions are fixed, exposure conditions must be controlled in the same way as for conventional X-ray exposure.

The reading conditions (sensitivity and latitude) have been preset according to the relevant menu in FIX MODE. Select the exposure conditions which correspond to that menu accordingly.

Z.5 Precautions for the Automatic X-ray Detection Function

Z.5.1 Precautions for Making an Exposure

- 1 When Shot Ready (exposure ready status indicator) in the connected devices status display field of the image processing unit is not lit green, the flat panel sensor cannot detect X-rays automatically. Even if the indicator is not lit green, radiation can be delivered but an image will not be output. Make sure that the indicator is lit green before making an exposure.
- 2 Check the tube current of the X-ray equipment in advance, and set exposure conditions based on the tube current by referring to the table below. If the conditions are not met, X-rays cannot be detected automatically and an image may not be acquired.

Tube current	Tube voltage	Exposure time	SID	Radiation field
More than 40 mA	Set the tube voltage according to the anatomical region and body thickness.	More than 5 ms	Set the SID according to the anatomical region.	Do not limit the radiation field to the bone region (*1) only.
More than 20 mA and less than 40 mA	Set the tube voltage to more than 50 kV according to the anatomical region and body thickness.		Set the SID to 100 cm (39.4 in.) or less and do not limit the radiation field to the bone region (*1) only. Alternatively, set the SID according to the anatomical region and include the directly exposed area (*2).	
More than 10 mA and less than 20 mA			100 cm (39.4 in.) or less	Include the directly exposed area (*2).
Less than 10 mA	The automatic X-ray detection function cannot be used.			

*1 When making an exposure, for example, for a finger or knee, set the radiation field to at least 6 cm × 10 cm (2.4 in. × 3.9 in.) for the former and at least 10 cm × 10 cm (3.9 in. × 3.9 in.) for the latter, so that the field is not limited to the bone region only.

*2 The areas of the flat panel sensor, which are directly exposed to X-rays that do not pass through the subject, must have a width of more than 3 cm (1.2 in.) from the subject.

- 3 As illustrated below, if the subject whose thinnest part is at least 40 cm (15.7 in.) in thickness covers the entire surface of the flat panel sensor, it cannot detect X-rays automatically and an image may not be acquired. In this case, make an exposure for the region including the directly exposed area.

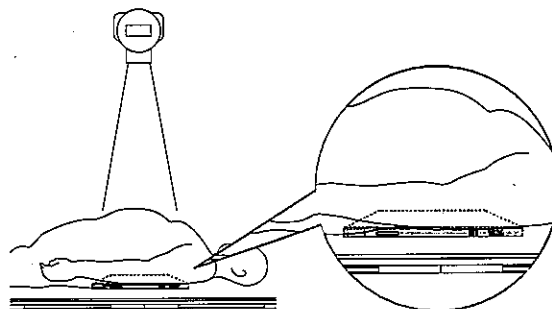

Figure of an exposure for the subject covering the entire surface of the flat panel sensor

- 4 When an exposure menu is registered and the system is ready for an exposure, the flat panel sensor enters X-ray detection mode. If an exposure is not made for a period of time while the exposure menu is registered, the operating time of the flat panel sensor's battery pack may be reduced to half. To avoid this, do not keep the system on standby, unless you make an exposure.

Z.5.2 Precautions Related to the X-ray Exposure Time

When delivering radiation, do not set the exposure time beyond the maximum limit specified for the flat panel sensor at the time of installation. Otherwise, vertical artifacts may appear in the image.

Z.6 Other Precautions

Z.6.1 Precautions for Exposure of a Subject in Relatively Large Contrast

- 1 Exposures using a contrast medium may cause artifacts around it.
- 2 When exposing a subject with any metal objects implanted, artifacts may appear around them.
- 3 For exposures with objects of large X-ray absorption, such as lead characters and metals for measurement, artifacts may appear around them. Place such objects outside a subject.

Z.6.2 Precautions for DR System

Generally, when performing a high sensitivity exposure shortly after an exposure that the flat panel sensor excessively receives direct X-ray, the output image may contain image lags of the previous exposure. This phenomenon rarely occurs and does not occur insofar as normal sensitivity exposures are performed.

Exposures at longer intervals can reduce occurrences of this phenomenon. Also observe precautions as follows.

- Continuous high sensitivity exposures to vertebral body part (chest/lumbar spine) should be performed at longer intervals than normal exposures.
- A high sensitivity exposure shortly after a high-dose exposure should be performed at sufficiently long interval.
- When performing high-dose exposures repeatedly, do not use collimation of the radiation field, lead characters or metals for measurement at the same position.

Z.6.3 Precautions for Assuring the Radiation Field



CAUTIONS

It is important to read the following before using the FDR D-EVO digital detector clinically.

The FDR D-EVO is a digital X-ray detector designed for use both within and outside of a standard radiographic bucky. Radiation field can be set up to 14" X 17" for the DR-ID 600SE/DR-ID 601SE/DR-ID 611SE, 17" X 17" for the DR-ID 602SE and 24 cm X 30 cm for the DR-ID 613SE. The DR-ID 600SE/DR-ID 601SE/DR-ID 602SE/DR-ID 611SE/DR-ID 613SE may be used in any situation where a film cassette may be used. The collimator will open up to 14" X 17" for the DR-ID 600SE/DR-ID 601SE/DR-ID 611SE, 17" X 17" for the DR-ID 602SE and 24 cm X 30 cm for the DR-ID 613SE, when the FDR D-EVO cassette is inserted in the bucky tray of X-ray systems with positive beam limitation (PBL).

Follow the X-ray system manufacturer's instructions to assure the indicated field size matches and does not exceed the actual radiation field size for the available range of SIDs.

Z.6.4 Images Output When the X-ray Shot Switch is Operated Incorrectly

In case that you press the X-ray shot switch only momentarily after selecting exposure menus, sufficient X-ray dose may not be achieved. The output image contains image lags of the previous exposure occasionally.

If this happens, select exposure menus again, and then make an exposure.

Z.6.5 Precautions for Urgent Use

When you start a study before completion of the calibration at the time of startup, the operation will be in Urgent Use Mode. At this time, "Urgent use is possible" appears in the "Output Device Status window" of the Console.

- There is no guarantee that the image taken in Urgent Use Mode can be used for diagnostic purposes. Vertical artifact could appear in the image, if the temperature difference is large from the previous shutdown of the system. Check the image quality before use.
- Move from the Study Screen to the Patient Information Input Screen immediately after exiting Urgent Use Mode, so that the calibration will start over automatically.

Z.6.6 Precautions Related to Continuous Operation

If you plan to continuously run the system for over 24 hours, perform post-operation check, and then restart the system.

Otherwise, calibration will not be performed normally, and image quality cannot be guaranteed as a result.

Z.6.7 Precautions Related to Grid

Depending on the type of the grid used, its stripes may appear in the image after making an exposure. To avoid such moire effects, sway the grid from side to side, or use the Grid Pattern Removal Processing Software in conjunction with the grid with 40 lines.

Z.6.8 Precautions for Connecting the DR-ID 320

When connecting the FDR D-EVO to the DR-ID 320 system, be sure to turn on the DR-ID 320RU.

Z.6.9 Precautions during Calibration

The flat panel sensor is under calibration while the READY status lamp is blinking or the message "Calibrating..." appears on the output device status window. Therefore, note the followings.

- Do not subject the flat panel sensor to shock.
- Do not deliver radiation.
- Do not connect or disconnect the connector.

Z.6.10 Precautions for Exposing the Flat Panel Sensor to X-ray

When you expose the flat panel sensor to X-ray in General at any other time except during radiography, artifacts could appear in the image. If artifacts appeared in the image due to X-ray irradiation, perform a test X-ray radiography after waiting for more than 2 minutes and then restart exposure after confirming that the artifacts disappear.



Appendix Z Precautions for Exposure

Appendix O Use of Optional Items

O.1 Optional Items

Name	Description
Remote switch	<p>A switch cable used for temporarily disconnecting the power to the flat panel sensor in order to connect/disconnect its connector while the system is in operation. Up to two remote switches can be connected. Using this switch reduces the time required for normal insertion/removal procedure. The switch is exclusively for DR-ID 600SE.</p> <p>➊ For the external view, see "O.2.1 Remote Switch" (page O-2).</p>
Relay cable	<p>A relay cable used for branching the cable for two remote switches, when each of them is attached to the upright-type and bed-type radiographic examination stands. The relay cable is exclusively for DR-ID 600SE.</p> <p>➊ For the external view, see "O.2.2 Relay Cable" (page O-2).</p>
SE storage case	<p>A case used for carrying and storing the flat panel sensor.</p> <p>➊ For the external view and precautions, see "O.3 Using the SE Storage Case" (page O-3).</p>
DAP connector cable	<p>A cable used for connecting a dose-area product (DAP) meter.</p> <p>➊ For the external view and precautions, see "O.4 Using the DAP Connector Cable" (page O-5).</p>
Retaining bracket for MP	<p>A set of an anchor and a fixture, which is used for securing the power supply unit to the floor.</p> <p>➊ For the external view, see "O.5 Using the Retaining bracket for MP" (page O-6).</p>
Connection cable for the flat panel sensor (power supply unit)	<p>A cable that connects the flat panel sensor and the power supply unit. This cable is used for adding the second and subsequent flat panel sensors, changing over the connection between the flat panel sensors, and other usages.</p>
Connection cable for X-ray equipment (9 cores)	<p>A signal cable that connects the power supply unit and the X-ray equipment (Xcon). Two types are available. Cable length: 5m(16.4 ft) and 15m(49.2 ft)</p>
Connection cable for X-ray equipment (3 cores)	<p>A signal cable for high current application, which connects the power supply unit and the X-ray equipment (Xcon). Two types are available. Cable length: 5m(16.4 ft) and 15m(49.2 ft)</p>
Communication cable for X-ray equipment and power supply unit (RS232C cable)	<p>A communication cable that connects the power supply unit and the X-ray equipment (Xcon). This cable is used for setting the tube voltage and mAs via communication. Four types are available. Cable length: 5m(16.4 ft), 9 pins Cable length: 15m(49.2 ft), 9 pins Cable length: 5m(16.4 ft), 25 pins Cable length: 15m(49.2 ft), 25 pins</p>
Relay unit for AC bucky	<p>A relay unit consisting of the relay and terminal block for the AC bucky. Four types are available: For 100V, 120V, 200V, and 220V</p>
Magnetic clamp for flat panel sensor cable	<p>A clamp for fixing the SE cable to the radiographic examination stand, etc.</p>
Cassette holder	<p>A cassette holder attached to the flat panel sensor for improving the load bearing capacity of the flat panel sensor when making an exposure directly with it.</p>
Battery pack	<p>A battery pack for the flat panel sensor.</p> <p>➊ For precautions, charging and installing/removing, see pages 1-7, 1-8, 3-5 and 3-6.</p>
Battery charger	<p>A battery charger for the battery pack.</p> <p>➊ For precautions, external view and charging, see pages 1-7, 2-4 and 3-5.</p>
Cradle	<p>A device used, when the flat panel sensor is moved to other X-ray room, to establish communication between the flat panel sensor and the power supply unit in the new location. The device is also used to keep the sensor upright when storing.</p> <p>➊ For the external view and precautions, see "O.6 Cradle" (page O-7).</p>

O.2 Using the Remote Switch

O.2.1 Remote Switch

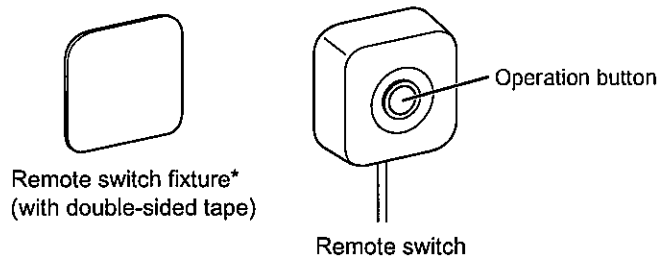

* This metal fixture is used when the remote switch cannot be attached to a wall, etc. with the magnet on the back. The remote switch fixture is attached to a wall, etc. with double-sided tape.

O.2.2 Relay Cable

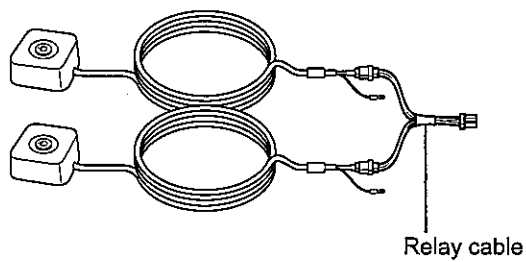

O.3 Using the SE Storage Case

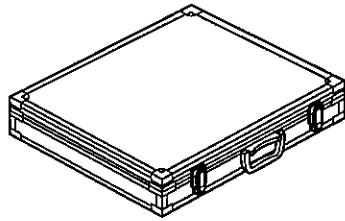

SE storage case for 35
(DR-ID 600SE/DR-ID 601SE/DR-ID 611SE)

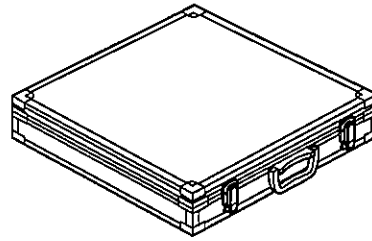

SE storage case for 43
(DR-ID 602SE)



CAUTIONS

- Do not store the SE storage case in a location with the following conditions.
 - Where the SE storage case is exposed to direct sunlight.
 - Where the temperature and humidity change dramatically.
 - Where there is excessive dust.
 - Where chemicals are stored.
 - Where the SE storage case may be exposed to water due to water leakage or ingress.
- Store the flat panel sensor and the cable properly in the SE storage case. Otherwise, they may be caught under the case lid and damaged.
- Do not connect the flat panel sensor to the connector while it is stored in the SE storage case.
- Do not store anything other than the flat panel sensor in the SE storage case.
- Carefully carry the SE storage case when the flat panel sensor is inside.
- The SE storage case and/or the flat panel sensor inside may be damaged if the case is subject to an impact.
- Do not open/close the SE storage case in a location where there is excessive dust or dirt.
- Do not put the SE storage case on an unstable place. If it falls or drops, personal injury may result.
- Be careful not to have your hand or an object caught when closing the SE storage case.

When storing the flat panel sensor in the SE storage case, place it with the exposure plane down. For details, see the illustrations below.

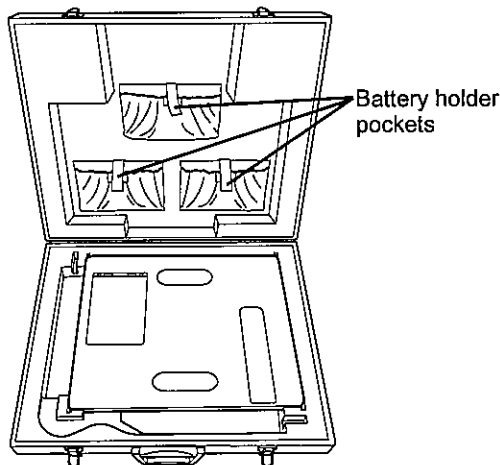

SE storage case for 35
(DR-ID 601SE/DR-ID 611SE)

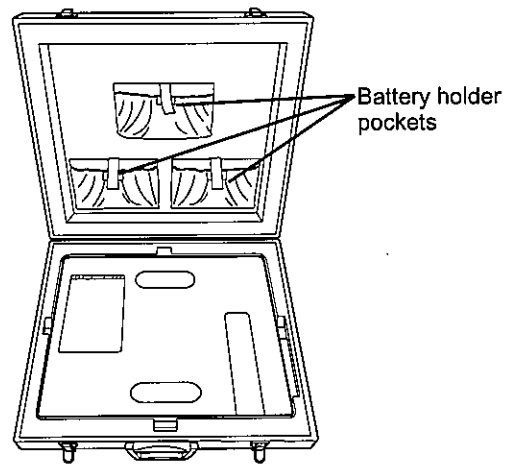

SE storage case for 43
(DR-ID 602SE)

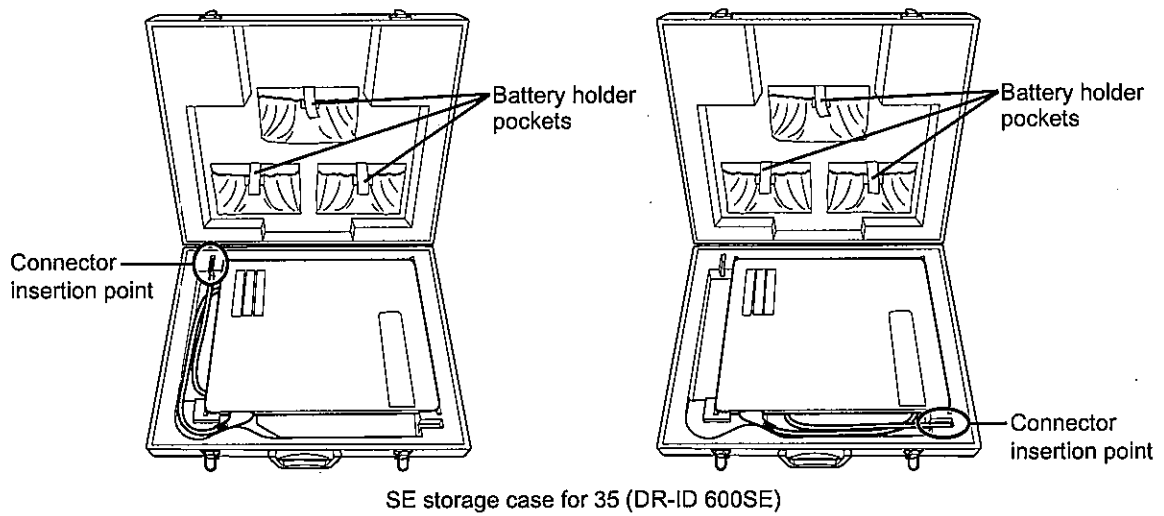

Note that the storage method varies depending on the direction of the flat panel sensor (DR-ID 600SE) cable. Set the flat panel sensor with attention to the cable direction, and insert the connector into the insertion point. Make sure that the cable is not placed under the flat panel sensor.



CAUTIONS

When the 8.5m(27.9 ft) SE cable (optional) is connected, the flat panel sensor (DR-ID 600SE) cannot be stored in the SE storage case.

O.4 Using the DAP Connector Cable

The DAP connector cable is used for connecting a dose-area product (DAP) meter*1 to the power supply unit.

This cable is connected to a dose-area product meter via an RS232C insulator*2.

To connect a DAP meter, contact a FUJIFILM dealer.

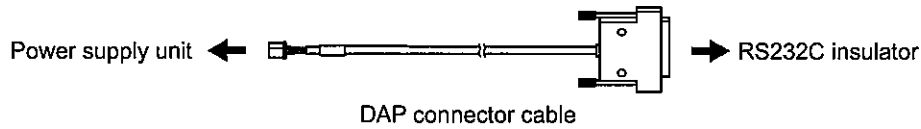

*1 A DAP meter of which FUJIFILM Corporation has confirmed the operational performance is VacuDAP Standard of VacuTec Meßtechnik GmbH.

*2 An RS232C insulator which FUJIFILM Corporation has experience in using is Model 88004 of Wiesemann & Theis GmbH.



- **Thoroughly read the operation manual of a DAP meter to use it correctly.**
- **Make sure that the initial value is "0" before starting measurements. If not, set it to "0" according to the operation manual for the DAP meter.**

O.5 Using the Retaining Bracket for MP

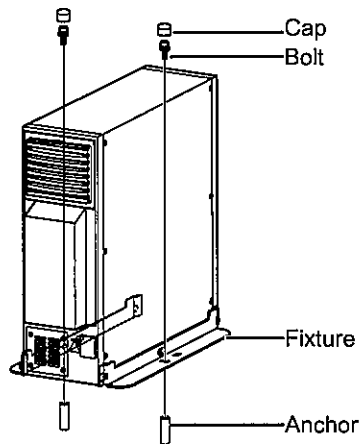

Contact a FUJIFILM dealer for installation of the Retaining bracket for MP.

O.6 Cradle

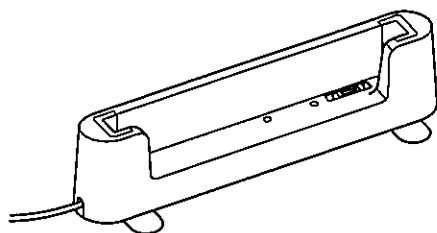

Cradle
(DR-ID 601SE/DR-ID 602SE/DR-ID 611SE)

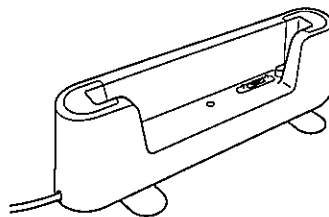

Cradle for 24
(DR-ID 613SE)



CAUTIONS

- Handle the Cradle carefully. Do not hit or drop the cassette holder or subject it to severe shock to avoid possible damage.
- If any damage such as cracking, chipping or peeling is found on the cassette holder, use it after repair. Otherwise, personal injury may result. Consult a FUJIFILM dealer for repair.
- If excessive force is applied to the Cradle, it may be damaged. Also, do not apply excessive force to the flat panel sensor inserted in the Cradle.
- When carrying the Cradle, if you accidentally drop it, your foot may be injured.
- Do not make an exposure when the flat panel sensor is inserted in the Cradle.

- 1** Remove the cover or connector of the flat panel sensor.

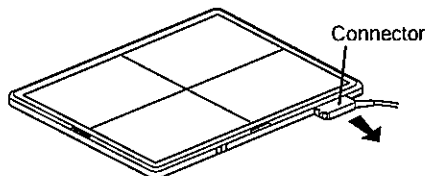

For connection and disconnection of the connector of the flat panel sensor, see "FUJIFILM DR FDR D-EVO (DR-ID 600) Operation Manual".

- 2** Insert the flat panel sensor.

Confirm the position of the connector, align the flat panel sensor with the cradle, and then slowly insert the sensor all the way along the guides at both sides.

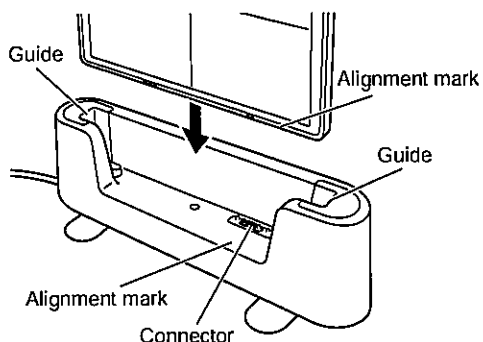

- 3** Check the status lamps of the flat panel sensor.

Make sure that the ERROR status lamp changes as follows after inserting the flat panel sensor into the Cradle.

	Before insertion	After insertion
Wireless communication possible	Not lit	Turns off after turning on for 1.0 second
Wireless communication not possible	Lit	Turns off

If the ERROR status lamp changes as above, communication between the flat panel sensor and the power supply unit is established normally.

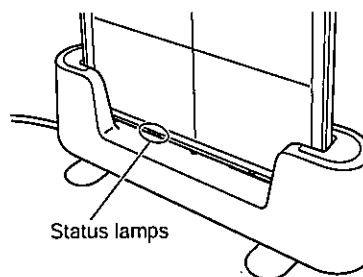

- 4** Remove the flat panel sensor.

When performing an exposure, remove the flat panel sensor from the cradle.

Maintenance and Inspection

1 Maintenance and Inspection Items Assigned to Specified Dealer

For periodical inspection of the equipment and necessary arrangements, consult our official dealer or local representative.

Periodical Maintenance

Make sure that the periodical maintenance and inspection assigned to our official dealer are performed as specified.

Maintenance and Inspection Items Assigned to Specified Dealer

Periodical Maintenance and Inspection Items	Period
Checking of the image	Every year
Checking of the operation record by referring to the error log	Every year
Checking of the internal units	Every 2 years
Checking of the S value	Every 6 months

Main Periodical Replacement Parts

Name of Periodical Replacement Parts	Period
Relay (optional)	Every 1.5 years (Number of exposures : 90,000)

* It is recommended that the battery pack (optional) be replaced once a year.
If the duration of use exceeds one year, the capacity of the battery pack will decrease.

The cycles of periodical maintenance and inspection and of parts replacement differ depending on the usage and the daily operation time.

For details, contact us directly or our official dealer.



Radio frequency (RF) compliance information

Compliance with Part 15 of FCC Rules and RSS-Gen of IC Rules

This device complies with Part 15 of FCC Rules and Industry Canada licence-exempt RSS standard(s). Operation is subject to the following two conditions.

(1) this device may not cause interference, and (2) this device must accept any interference, including interference that may cause undesired operation of this device.

Le présent appareil est conforme aux la partie 15 des règles de la FCC et CNR d'Industrie Canada applicables aux appareils radio exempts de licence. L'exploitation est autorisée aux deux conditions suivantes : (1) l'appareil ne doit pas produire de brouillage, et (2) l'utilisateur de l'appareil doit accepter tout brouillage radioélectrique subi, même si le brouillage est susceptible d'en compromettre le fonctionnement.

FCC WARNING

Changes or modifications not expressly approved by the party responsible for compliance could void the user's authority to operate the equipment.

The available scientific evidence does not show that any health problems are associated with using low power wireless devices.

There is no proof, however, that these low power wireless devices are absolutely safe. Low power Wireless devices emit low levels of radio frequency energy (RF) in the microwave range while being used. Whereas high levels of RF can produce health effects (by heating tissue), exposure of low-level RF that does not produce heating effects causes no known adverse health effects. Many studies of low-level RF exposures have not found any biological effects.

Some studies have suggested that some biological effects might occur, but such findings have not been confirmed by additional research. DR-ID 601SE/DR-ID 602SE/DR-ID 611SE/DR-ID 613SE has been tested and found to comply with FCC/IC radiation exposure limits set forth for an uncontrolled environment and meets the FCC radio frequency (RF) Exposure Guidelines in Supplement C to OET65 and RSS-102 of the IC radio frequency (RF) Exposure rules.

5.15-5.25GHz band is restricted to indoor operations only.

Compliance with FCC requirement 15.407^g Data transmission is always initiated by software, which is the passed down through the MAC, through the digital and analog baseband, and finally to the RF chip. Several special packets are initiated by the MAC. These are the only ways the digital baseband portion will turn on the RF transmitter, which it then turns off at the end of the packet. Therefore, the transmitter will be on only while one of the aforementioned packets is being transmitted.

In other words, this device automatically discontinues transmission in case of either absence of information to transmitter operational failure.

(This transmitter must not be co-located or operated in conjunction with any other antenna or transmitter.)

Les connaissances scientifiques dont nous disposons n'ont mis en évidence aucun problème de santé associé à l'usage des appareils sans fil à faible puissance. Nous ne sommes cependant pas en mesure de prouver que ces appareils sans fil à faible puissance sont entièrement sans danger. Les appareils sans fil à faible puissance émettent une énergie radioélectrique (RF) très faible dans le spectre des micro-ondes lorsqu'ils sont utilisés. Alors qu'une dose élevée de RF peut avoir des effets sur la santé (en chauffant les tissus), l'exposition à de faibles RF qui ne produisent pas de chaleur n'a pas de mauvais effets connus sur la santé. De nombreuses études ont été menées sur les expositions aux RF faibles et n'ont découvert aucun effet biologique. Certaines études ont suggéré qu'il pouvait y avoir certains effets biologiques, mais ces résultats n'ont pas été confirmés par des recherches supplémentaires.

DR-ID 601SE/DR-ID 602SE/DR-ID 611SE/DR-ID 613SE a été testé et jugé conforme aux limites d'exposition aux rayonnements énoncées pour un environnement non contrôlé et respecte les règles d'exposition aux fréquences radioélectriques (RF) CNR-102 de l'IC.

Compliance with 1999/5/EC

Manufacture's Name: FUJIFILM Corporation
 Manufacture's Address: 26-30, Nishiazabu 2-Chome, Minato-Ku, Tokyo 106-8620 JAPAN

declares that the product:

Product Name: D-EVO G35i, D-EVO G43i, and D-EVO plus C35i, and D-EVO plus C24i
 Model Number: DR-ID 601SE, DR-ID 602SE, DR-ID 611SE, and DR-ID 613SE

The product complies with the requirements of the R&TTE Directive 1999/5/EC.

The formal "Declaration of Conformity" can be obtained in the following-mentioned address.

Address: 798, Miyanodai, Kaisei-machi, Ashigarakami-gun, Kanagawa 258-8538 JAPAN

The shipment schedule country is as follows.

AT	BE	CH	CZ	DK
DE	ES	FI	FR	GB
GR	HU	IS	IT	LU
LV	NL	NO	PL	PT
SK	SE			



CS Česky [Czech]	FUJIFILM tímto prohlašuje, že tento DR-ID 601SE, DR-ID 602SE, DR-ID611SE, DR-ID 613SE je ve shodě se základními požadavky a dalšími příslušnými ustanoveními směrnice 1999/5/ES.
DA Dansk [Danish]	Undertegnede FUJIFILM erklærer herved, at følgende udstyr DR-ID 601SE, DR-ID 602SE, DR-ID611SE, DR-ID 613SE overholder de væsentlige krav og øvrige relevante krav i direktiv 1999/5/EF.
DE Deutsch [German]	Hiermit erkläre FUJIFILM, dass sich das Gerät DR-ID 601SE, DR-ID 602SE, DR-ID611SE, DR-ID 613SE in Übereinstimmung mit den grundlegenden Anforderungen und den übrigen einschlägigen Bestimmungen der Richtlinie 1999/5/EG befindet.
EN English	Hereby, FUJIFILM, declares that this DR-ID 601SE, DR-ID 602SE, DR-ID611SE, DR-ID 613SE is in compliance with the essential requirements and other relevant provisions of Directive 1999/5/EC.
ES Español [Spanish]	Por medio de la presente FUJIFILM declara que el DR-ID 601SE, DR-ID 602SE, DR-ID611SE, DR-ID 613SE cumple con los requisitos esenciales y cualesquiera otras disposiciones aplicables o exigibles de la Directiva 1999/5/CE.
ET Eesti [Estonian]	Käesolevaga kinnitab FUJIFILM seadme DR-ID 601SE, DR-ID 602SE, DR-ID611SE, DR-ID 613SE vastavust direktiivi 1999/5/EÜ põhinõuetele ja nimetatud direktiivist tulenevatele teistele asjakohastele sätetele.
FI Suomi [Finish]	FUJIFILM vakuuttaa täten että DR-ID 601SE, DR-ID 602SE, DR-ID611SE, DR-ID 613SE tyyppinen laite on direktiivin 1999/5/EY oleellisten vaatimusten ja sitä koskevien direktiivin muiden ehtojen mukainen.
FR Français [French]	Par la présente FUJIFILM déclare que l'appareil DR-ID 601SE, DR-ID 602SE, DR-ID611SE, DR-ID 613SE est conforme aux exigences essentielles et aux autres dispositions pertinentes de la directive 1999/5/CE.

EL Ελληνική [Greek]	ΜΕ ΤΗΝ ΠΑΡΟΥΣΑ FUJIFILM ΔΗΛΩΝΕΙ ΟΤΙ DR-ID 601SE, DR-ID 602SE, DR-ID611SE, DR-ID 613SE ΣΥΜΜΟΡΦΩΝΕΤΑΙ ΠΡΟΣ ΤΙΣ ΟΥΣΙΩΔΕΙΣ ΑΠΑΙΤΗΣΕΙΣ ΚΑΙ ΤΙΣ ΛΟΙΠΕΣ ΣΧΕΤΙΚΕΣ ΔΙΑΤΑΞΕΙΣ ΤΗΣ ΟΔΗΓΙΑΣ 1999/5/ΕΚ.
HU Magyar [Hungarian]	Alulírott, FUJIFILM nyilatkozom, hogy a DR-ID 601SE, DR-ID 602SE, DR-ID611SE, DR-ID 613SE megfelel a vonatkozó alapvető követelményeknek és az 1999/5/EC irányelv egyéb előírásainak.
IS Íslenska [Icelandic]	Hér með lýsir FUJIFILM yfir því að DR-ID 601SE, DR-ID 602SE, DR-ID611SE, DR-ID 613SE er í samræmi við grunnkröfur og aðrar kröfur, sem gerðar eru í tilskípun 1999/5/EC
IT Italiano [Italian]	Con la presente FUJIFILM dichiara che questo DR-ID 601SE, DR-ID 602SE, DR-ID611SE, DR-ID 613SE è conforme ai requisiti essenziali ed alle altre disposizioni pertinenti stabilite dalla direttiva 1999/5/CE.
LV Latviski [Latvian]	Ar šo FUJIFILM deklarē, ka DR-ID 601SE, DR-ID 602SE, DR-ID611SE, DR-ID 613SE atbilst Direktīvas 1999/5/EK būtiskajām prasībām un citiem ar to saistītajiem noteikumiem.
LT Lietuvių [Lithuanian]	Šiuo FUJIFILM deklaruoja, kad šis DR-ID 601SE, DR-ID 602SE, DR-ID611SE, DR-ID 613SE atitinka esminius reikalavimus ir kitas 1999/5/EB Direktyvos nuostatas.
MT Malti [Maltese]	Hawnhekk, FUJIFILM, jiddikjara li dan DR-ID 601SE, DR-ID 602SE, DR-ID611SE, DR-ID 613SE jikkonforma mal-htigijiet essenzjali u ma provvedimenti oħrajn rilevanti li hemm fid-Direttiva 1999/5/EC.
NL Nederlands [Dutch]	Hierbij verklaart FUJIFILM dat het toestel DR-ID 601SE, DR-ID 602SE, DR-ID611SE, DR-ID 613SE in overeenstemming is met de essentiële eisen en de andere relevante bepalingen van richtlijn 1999/5/EG.
NO Norsk [Norwegian]	FUJIFILM erklærer herved at utstyret DR-ID 601SE, DR-ID 602SE, DR-ID611SE, DR-ID 613SE er i samsvar med de grunnleggende krav og øvrige relevante krav i direktiv 1999/5/EF.
PL Polski [Polish]	Niniejszym FUJIFILM oświadcza, że DR-ID 601SE, DR-ID 602SE, DR-ID611SE, DR-ID 613SE jest zgodny z zasadniczymi wymogami oraz pozostałymi stosownymi postanowieniami Dyrektywy 1999/5/EC
PT Português [Portuguese]	FUJIFILM declara que este DR-ID 601SE, DR-ID 602SE, DR-ID611SE, DR-ID 613SE está conforme com os requisitos essenciais e outras disposições da Directiva 1999/5/CE.
SK Slovensky [Slovak]	FUJIFILM týmto vyhlasuje, že DR-ID 601SE, DR-ID 602SE, DR-ID611SE, DR-ID 613SE spĺňa základné požiadavky a všetky príslušné ustanovenia Smernice 1999/5/ES.
SL Slovensko [Slovenian]	FUJIFILM izjavlja, da je ta DR-ID 601SE, DR-ID 602SE, DR-ID611SE, DR-ID 613SE v skladu z bistvenimi zahtevami in ostalimi relevantnimi določili direktive 1999/5/ES.
SV Svenska [Swedish]	Härmed intygar FUJIFILM. att denna DR-ID 601SE, DR-ID 602SE, DR-ID611SE, DR-ID 613SE står i överensstämmelse med de väsentliga egenskapskrav och övriga relevanta bestämmelser som framgår av direktiv 1999/5/EG.

Compliance with Infocomm Development Authority of Singapore (Singapore)

Complies with
IDA Standards
198305269N

Compliance with Telecommunications Regulatory Authority (UAE)

TRA
REGISTERED No: ER0072502/11
DEALER No: DA0072499/11

Compliance with NTC technical requirement (Thailand)

This telecommunication equipments (DR-ID 601SE, DR-ID 602SE, DR-ID 611SE and DR-ID 613SE) conforms to technical standard NTC TS 1012-2551.

Radio Law Certification Labels

Flat panel sensor (DR-ID 601SE)

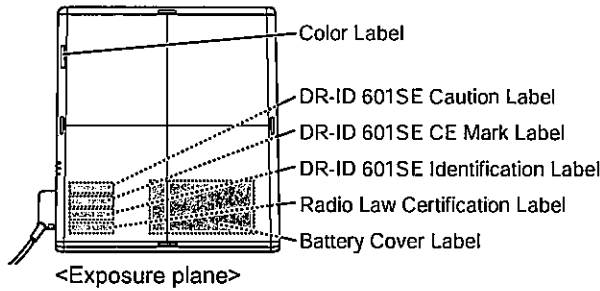

Australia and New Zealand

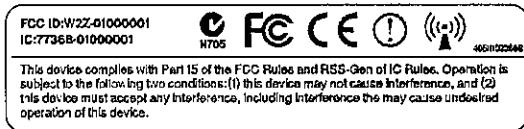

Radio Law certification Label (for Australia and New Zealand)

United Arab Emirates (UAE)

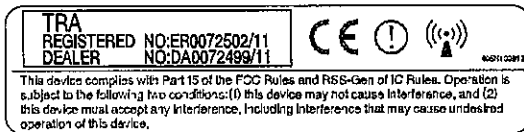

Radio Law certification Label (for United Arab Emirates)

Rating Labels

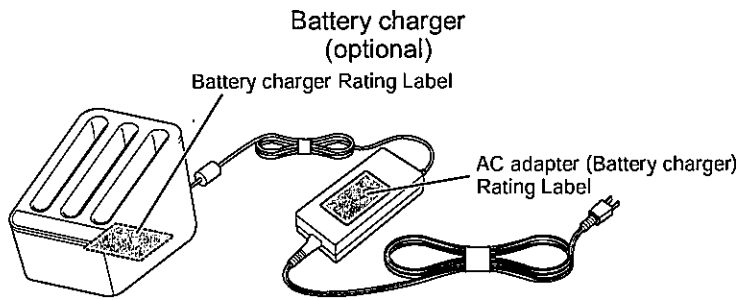

Australia and Mexico

Li-ion Battery charger
CARGADOR DE BATERIAS **FUJIFILM**

MODEL 125N100052
INPUT 16V 4.3A
OUTPUT 12.3V 1.7A x3ch

分解・改造をしないでください
Do not disassemble or modify.
指定のアダプタ以外は使用しないでください
Do not use with anything other than the specified adaptor.
指定の電池パック以外は充電できません
Specified battery pack : FUJIFILM Corporation 125N100050
(11.1V 2400mAh 27Wh)

PM3

EU only NOM NYCE LISTED US CE

FUJIFILM Corporation
Parts NO. 125Y100056
MADE IN JAPAN

Battery Charger Rating Label
(for Australia and Mexico)

AC ADAPTER FUJIFILM
ADAPTADOR DE ca/cc 125Y100052

MODEL RC120G-16D

INPUT 100-240V ~ 1.5A
50-60Hz
OUTPUT 16V 6.5A

CE N21832 NSW29328 NOM NYCE

E141433
UL US LISTED
FUTADA ELECTRIC
AC 100-240V 50/60Hz
2000mA
DC 16V 6.5A

EFFICIENCY LEVEL V

MADE IN JAPAN
SER. NO. F

FUJIFILM Corporation PM3

- ⚠ CAUTION : FOR INDOOR USE ONLY.
DO NOT SHORTCIRCUIT
OUTPUT TERMINALS.
- ⚡ 注意 : 屋内専用
出力プラグをショート
させないで下さい。
- ⚠ DANGER : DO NOT OPEN. DANGEROUS
VOLTAGES INSIDE.
危険 : 内部に高電圧部があり危険
です。開けないで下さい。

AC Adapter (Battery Charger) Rating
Label (for Australia and Mexico)



FUJIFILM



Manufacturer :

FUJIFILM Corporation

26-30, NISHIAZABU 2-CHOME, MINATO-KU, TOKYO 106-8620, JAPAN



0123



European Authorized Representative:

FUJIFILM Europe GmbH

Heesenstrasse 31, 40549 Duesseldorf, Germany

FUJIFILM MEDICAL SYSTEMS U.S.A., INC.

419 WEST AVENUE, STAMFORD CT 06902, U.S.A.