

## FCC Test Report

**Report No.:** RF181224C17-4

**FCC ID:** W23-JWW6051

**Test Model:** JWW6051

**Received Date:** Dec. 24, 2018

**Test Date:** Jan. 24, 2019 ~ Jan. 26, 2019

**Issued Date:** Feb. 23, 2019

**Applicant:** jjPlus Corporation

**Address:** 13F., No.120-3, Qiaohe Rd. Zhonghe Dist., New Taipei City 23584 Taiwan (R.O.C.)

**Issued By:** Bureau Veritas Consumer Products Services (H.K.) Ltd., Taoyuan Branch

**Lab Address:** No. 47-2, 14th Ling, Chia Pau Vil., Lin Kou Dist., New Taipei City, Taiwan ( R.O.C )

**Test Location (1):** No. 19, Hwa Ya 2nd Rd, Wen Hwa Tsuen, Kwei Shan Hsiang, Taoyuan Hsien 333, Taiwan, R.O.C.

**Test Location (2):** B2F., No.215, Sec. 3, Beixin Rd., Xindian Dist., New Taipei City 231, Taiwan, R.O.C

**FCC Registration /  
Designation Number:** 427177 / TW0011



This report is for your exclusive use. Any copying or replication of this report to or for any other person or entity, or use of our name or trademark, is permitted only with our prior written permission. This report sets forth our findings solely with respect to the test samples identified herein. The results set forth in this report are not indicative or representative of the quality or characteristics of the lot from which a test sample was taken or any similar or identical product unless specifically and expressly noted. Our report includes all of the tests requested by you and the results thereof based upon the information that you provided to us. You have 60 days from date of issuance of this report to notify us of any material error or omission caused by our negligence, provided, however, that such notice shall be in writing and shall specifically address the issue you wish to raise. A failure to raise such issue within the prescribed time shall constitute your unqualified acceptance of the completeness of this report, the tests conducted and the correctness of the report contents. Unless specific mention, the uncertainty of measurement has been explicitly taken into account to declare the compliance or non-compliance to the specification. The report must not be used by the client to claim product certification, approval, or endorsement by TAF or any government agencies.

## Table of Contents

<b>Release Control Record .....</b>	<b>4</b>
<b>1 Certificate of Conformity .....</b>	<b>5</b>
<b>2 Summary of Test Results .....</b>	<b>6</b>
2.1 Measurement Uncertainty .....	6
2.2 Modification Record.....	6
<b>3 General Information .....</b>	<b>7</b>
3.1 General Description of EUT .....	7
3.2 Description of Test Modes .....	9
3.2.1 Test Mode Applicability and Tested Channel Detail .....	11
3.3 Duty Cycle of Test Signal .....	13
3.4 Description of Support Units.....	14
3.4.1 Configuration of System under Test.....	14
3.5 General Description of Applied Standards .....	14
<b>4 Test Types and Results .....</b>	<b>15</b>
4.1 Radiated Emission and Bandedge Measurement .....	15
4.1.1 Limits of Radiated Emission and Bandedge Measurement .....	15
4.1.2 Limits of Unwanted Emission Out of the Restricted Bands .....	16
4.1.3 Test Instruments .....	17
4.1.4 Test Procedures.....	18
4.1.5 Deviation from Test Standard.....	19
4.1.6 Test Setup .....	19
4.1.7 EUT Operating Conditions .....	20
4.1.8 Test Results .....	21
4.2 Conducted Emission Measurement .....	65
4.2.1 Limits of Conducted Emission Measurement .....	65
4.2.2 Test Instruments .....	65
4.2.3 Test Procedures.....	66
4.2.4 Deviation from Test Standard.....	66
4.2.5 Test Setup .....	66
4.2.6 EUT Operating Conditions .....	66
4.2.7 Test Results .....	67
4.3 Transmit Power Measurement .....	69
4.3.1 Limits of Transmit Power Measurement .....	69
4.3.2 Test Setup .....	69
4.3.3 Test Instruments .....	70
4.3.4 Test Procedure .....	70
4.3.5 Deviation from Test Standard.....	70
4.3.6 EUT Operating Conditions .....	70
4.3.7 Test Results .....	71
4.4 Occupied Bandwidth Measurement .....	78
4.4.1 Test Setup .....	78
4.4.2 Test Instruments .....	78
4.4.3 Test Procedure .....	78
4.4.4 Test Results .....	79
4.5 Peak Power Spectral Density Measurement.....	82
4.5.1 Limits of Peak Power Spectral Density Measurement .....	82
4.5.2 Test Setup .....	82
4.5.3 Test Instruments .....	82
4.5.4 Test Procedures.....	82
4.5.5 Deviation from Test Standard.....	83
4.5.6 EUT Operating Conditions .....	83
4.5.7 Test Results .....	84
4.6 Frequency Stability .....	90

4.6.1	Limit of Frequency Stability Measurement .....	90
4.6.2	Test Setup .....	90
4.6.3	Test Instruments .....	90
4.6.4	Test Procedure .....	90
4.6.5	Deviation from Test Standard.....	90
4.6.6	EUT Operating Condition .....	90
4.6.7	Test Results .....	91
4.7	6 dB Bandwidth Measurement .....	92
4.7.1	Limits of 6 dB Bandwidth Measurement.....	92
4.7.2	Test Setup .....	92
4.7.3	Test Instruments .....	92
4.7.4	Test Procedure .....	92
4.7.5	Deviation from Test Standard.....	92
4.7.6	EUT Operating Condition .....	92
4.7.7	Test Results .....	93
<b>5</b>	<b>Pictures of Test Arrangements .....</b>	<b>95</b>
	<b>Annex A- Radiated Out of Band Emission (OOBE) Measurement (For U-NII-3 band) .....</b>	<b>96</b>
	<b>Appendix – Information of the Testing Laboratories .....</b>	<b>99</b>

### Release Control Record

Issue No.	Description	Date Issued
RF181224C17-4	Original Release	Feb. 23, 2019

## 1 Certificate of Conformity

**Product:** 11ac wave2/abgn 2T2R WIFI & BT4.2 M.2 Combo Module

**Brand:** jjPlus

**Test Model:** JWW6051

**Sample Status:** Identical Prototype

**Applicant:** jjPlus Corporation

**Test Date:** Jan. 24, 2019 ~ Jan. 26, 2019

**Standards:** 47 CFR FCC Part 15, Subpart E (Section 15.407)  
ANSI C63.10:2013

The above equipment has been tested by **Bureau Veritas Consumer Products Services (H.K.) Ltd., Taoyuan Branch**, and found compliance with the requirement of the above standards. The test record, data evaluation & Equipment Under Test (EUT) configurations represented herein are true and accurate accounts of the measurements of the sample's RF characteristics under the conditions specified in this report.

**Prepared by :**  , **Date:** Feb. 23, 2019  
Ivonne Wu / Supervisor

**Approved by :**  , **Date:** Feb. 23, 2019  
Dylan Chiou / Project Engineer

## 2 Summary of Test Results

47 CFR FCC Part 15, Subpart E (Section 15.407)			
FCC Clause	Test Item	Result	Remarks
15.407(b)(6)	AC Power Conducted Emissions	Pass	Meet the requirement of limit. Minimum passing margin is -16.37 dB at 0.41563 MHz.
15.407(b) (1/2/3/4(iii)/6)	Radiated Emissions & Band Edge Measurement	Pass	Meet the requirement of limit. Minimum passing margin is -1.03 dB at 5149.55 MHz.
15.407(a)(1/2/3)	Max Average Transmit Power	Pass	Meet the requirement of limit.
---	Occupied Bandwidth Measurement	-	Reference only
15.407(a)(1/2/3)	Peak Power Spectral Density	Pass	Meet the requirement of limit.
15.407(e)	6 dB Bandwidth	Pass	Meet the requirement of limit. (U-NII-3 Band only)
15.407(g)	Frequency Stability	Pass	Meet the requirement of limit.
15.203	Antenna Requirement	Pass	Antenna connector is U.FL not a standard connector.

Note:

- For U-NII-3 band compliance with rule part 15.407(b)(4)(i), the OOB test plots were recorded in Annex A.
- Determining compliance based on the results of the compliance measurement, not taking into account measurement instrumentation uncertainty.

### 2.1 Measurement Uncertainty

Where relevant, the following measurement uncertainty levels have been estimated for tests performed on the EUT as specified in CISPR 16-4-2:

Measurement	Frequency	Expanded Uncertainty (k=2) (±)
Conducted Emissions at mains ports	150 kHz ~ 30 MHz	2.44 dB
Radiated Emissions up to 1 GHz	30 MHz ~ 200 MHz	2.0153 dB
	200 MHz ~ 1000 MHz	2.0224 dB
Radiated Emissions above 1 GHz	1 GHz ~ 18 GHz	1.0121 dB
	18 GHz ~ 40 GHz	1.1508 dB

### 2.2 Modification Record

There were no modifications required for compliance.

### 3 General Information

#### 3.1 General Description of EUT

<b>Product</b>	11ac wave2/abgn 2T2R WIFI & BT4.2 M.2 Combo Module
<b>Brand</b>	jjPlus
<b>Test Model</b>	JWW6051
<b>Status of EUT</b>	Identical Prototype
<b>Power Supply Rating</b>	3.3 Vdc (hot equipment)
<b>Modulation Type</b>	256QAM, 64QAM, 16QAM, QPSK, BPSK
<b>Modulation Technology</b>	OFDM
<b>Transfer Rate</b>	802.11a: 54.0/ 48.0/ 36.0/ 24.0/ 18.0/ 12.0/ 9.0/ 6.0 Mbps 802.11n: up to 300.0 Mbps 802.11ac: up to 866.7 Mbps
<b>Operating Frequency</b>	5180 ~ 5240 MHz, 5260 ~ 5320 MHz, 5500 ~ 5720 MHz, 5745 ~ 5825 MHz
<b>Number of Channel</b>	5180 ~ 5240 MHz: 4 for 802.11a, 802.11n (HT20) 2 for 802.11n (HT40) 1 for 802.11ac (VHT80) 5260 ~ 5320 MHz: 4 for 802.11a, 802.11n (HT20) 2 for 802.11n (HT40) 1 for 802.11ac (VHT80) 5500 ~ 5720 MHz: 12 for 802.11a, 802.11n (HT20) 6 for 802.11n (HT40) 3 for 802.11ac (VHT80) 5745 ~ 5825 MHz: 5 for 802.11a, 802.11n (HT20) 2 for 802.11n (HT40) 1 for 802.11ac (VHT80)
<b>Output Power</b>	49.023 mW for 5180 ~ 5240 MHz 62.743 mW for 5260 ~ 5320 MHz 68.699 mW for 5500 ~ 5720 MHz 61.452 mW for 5745 ~ 5825 MHz
<b>Antenna Type</b>	Dipole antenna with 5 dBi gain
<b>Antenna Connector</b>	U.FL
<b>Accessory Device</b>	Refer to Note as below
<b>Data Cable Supplied</b>	Refer to Note as below

**Note:**

1. The EUT incorporates a MIMO function. Physically, the EUT provides two completed transmitters and two receivers.

Modulation Mode	Tx Function
802.11a	1TX
802.11n (HT20)	2TX
802.11n (HT40)	2TX
802.11ac (VHT20)	2TX
802.11ac (VHT40)	2TX
802.11ac (VHT80)	2TX

\* The modulation and bandwidth are similar for 802.11n mode for HT20 / HT40 and 802.11ac mode for VHT20 / VHT40, therefore investigated worst case to representative mode in test report. (Final test mode refer section 3.2.1)

2. The above EUT information is declared by manufacturer and for more detailed features description, please refers to the manufacturer's specifications or user's manual.



### 3.2 Description of Test Modes

#### For 5180 ~ 5240 MHz

4 channels are provided for 802.11a, 802.11n (HT20):

Channel	Frequency (MHz)	Channel	Frequency (MHz)
36	5180	44	5220
40	5200	48	5240

2 channels are provided for 802.11n (HT40):

Channel	Frequency (MHz)	Channel	Frequency (MHz)
38	5190	46	5230

1 channel is provided for 802.11ac (VHT80):

Channel	Frequency (MHz)
42	5210

#### For 5260 ~ 5320 MHz

4 channels are provided for 802.11a, 802.11n (HT20):

Channel	Frequency (MHz)	Channel	Frequency (MHz)
52	5260	60	5300
56	5280	64	5320

2 channels are provided for 802.11n (HT40):

Channel	Frequency (MHz)	Channel	Frequency (MHz)
54	5270	62	5310

1 channel is provided for 802.11ac (VHT80):

Channel	Frequency (MHz)
58	5290

**For 5500 ~ 5720 MHz**

12 channels are provided for 802.11a, 802.11n (HT20):

Channel	Frequency (MHz)	Channel	Frequency (MHz)
100	5500	124	5620
104	5520	128	5640
108	5540	132	5660
112	5560	136	5680
116	5580	140	5700
120	5600	144	5720

6 channels are provided for 802.11n (HT40):

Channel	Frequency (MHz)	Channel	Frequency (MHz)
102	5510	126	5630
110	5550	134	5670
118	5590	142	5710

3 channels are provided for 802.11ac (VHT80):

Channel	Frequency (MHz)	Channel	Frequency (MHz)
106	5530	138	5690
122	5610		

**For 5745 ~ 5825 MHz:**

5 channels are provided for 802.11a, 802.11n (HT20):

Channel	Frequency (MHz)	Channel	Frequency (MHz)
149	5745	161	5805
153	5765	165	5825
157	5785		

2 channels are provided for 802.11n (HT40):

Channel	Frequency (MHz)	Channel	Frequency (MHz)
151	5755	159	5795

1 channel is provided for 802.11ac (VHT80):

Channel	Frequency (MHz)
155	5775

### 3.2.1 Test Mode Applicability and Tested Channel Detail

EUT Configure Mode	Applicable To				Description
	RE $\geq$ 1G	RE $<$ 1G	PLC	APCM	
-	√	√	√	√	-

Where **RE $\geq$ 1G**: Radiated Emission above 1 GHz      **RE $<$ 1G**: Radiated Emission below 1 GHz  
**PLC**: Power Line Conducted Emission      **APCM**: Antenna Port Conducted Measurement

**Note:**

1. The EUT had been pre-tested on the positioned of each 3 axis. The worst case was found when positioned on **Z-plane**.
2. "-" means no effect.

#### **Radiated Emission Test (Above 1 GHz):**

- Pre-Scan has been conducted to determine the worst-case mode from all possible combinations between available modulations, data rates and antenna ports (if EUT with antenna diversity architecture).
- Following channel(s) was (were) selected for the final test as listed below.

EUT Configure Mode	Frequency Band (MHz)	Mode	Available Channel	Tested Channel	Modulation Technology	Modulation Type	Data Rate (Mbps)
-	5180-5240	802.11a	36 to 48	36, 40, 48	OFDM	BPSK	6.0
-		802.11n (HT20)	36 to 48	36, 40, 48	OFDM	BPSK	6.5
-		802.11n (HT40)	38 to 46	38, 46	OFDM	BPSK	13.5
-		802.11ac (VHT80)	42	42	OFDM	BPSK	29.3
-	5260-5320	802.11a	52 to 64	52, 60, 64	OFDM	BPSK	6.0
-		802.11n (HT20)	52 to 64	52, 60, 64	OFDM	BPSK	6.5
-		802.11n (HT40)	54 to 62	54, 62	OFDM	BPSK	13.5
-		802.11ac (VHT80)	58	58	OFDM	BPSK	29.3
-	5500-5720	802.11a	100 to 144	100, 116, 140, 144	OFDM	BPSK	6.0
-		802.11n (HT20)	100 to 144	100, 116, 140, 144	OFDM	BPSK	6.5
-		802.11n (HT40)	102 to 142	102, 110, 134, 142	OFDM	BPSK	13.5
-		802.11ac (VHT80)	106 to 138	106, 122, 138	OFDM	BPSK	29.3
-	5745-5825	802.11a	149 to 165	149, 157, 165	OFDM	BPSK	6.0
-		802.11n (HT20)	149 to 165	149, 157, 165	OFDM	BPSK	6.5
-		802.11n (HT40)	151 to 159	151, 159	OFDM	BPSK	13.5
-		802.11ac (VHT80)	155	155	OFDM	BPSK	29.3

#### **Radiated Emission Test (Below 1 GHz):**

- Pre-Scan has been conducted to determine the worst-case mode from all possible combinations between available modulations, data rates and antenna ports (if EUT with antenna diversity architecture).
- Following channel(s) was (were) selected for the final test as listed below.

EUT Configure Mode	Frequency Band (MHz)	Mode	Available Channel	Tested Channel	Modulation Technology	Modulation Type	Data Rate (Mbps)
-	5180-5240	802.11ac (VHT80)	42	42	OFDM	BPSK	29.3

**Power Line Conducted Emission Test:**

- Pre-Scan has been conducted to determine the worst-case mode from all possible combinations between available modulations, data rates and antenna ports (if EUT with antenna diversity architecture).
- Following channel(s) was (were) selected for the final test as listed below.

EUT Configure Mode	Frequency Band (MHz)	Mode	Available Channel	Tested Channel	Modulation Technology	Modulation Type	Data Rate (Mbps)
-	5180-5240	802.11ac (VHT80)	42	42	OFDM	BPSK	29.3

**Antenna Port Conducted Measurement:**

- This item includes all test value of each mode, but only includes spectrum plot of worst value of each mode.
- Pre-Scan has been conducted to determine the worst-case mode from all possible combinations between available modulations, data rates and antenna ports (if EUT with antenna diversity architecture).
- Following channel(s) was (were) selected for the final test as listed below.

EUT Configure Mode	Frequency Band (MHz)	Mode	Available Channel	Tested Channel	Modulation Technology	Modulation Type	Data Rate (Mbps)
-	5180-5240	802.11a	36 to 48	36, 40, 48	OFDM	BPSK	6.0
-		802.11n (HT20)	36 to 48	36, 40, 48	OFDM	BPSK	6.5
-		802.11n (HT40)	38 to 46	38, 46	OFDM	BPSK	13.5
-		802.11ac (VHT80)	42	42	OFDM	BPSK	29.3
-	5260-5320	802.11a	52 to 64	52, 60, 64	OFDM	BPSK	6.0
-		802.11n (HT20)	52 to 64	52, 60, 64	OFDM	BPSK	6.5
-		802.11n (HT40)	54 to 62	54, 62	OFDM	BPSK	13.5
-		802.11ac (VHT80)	58	58	OFDM	BPSK	29.3
-	5500-5720	802.11a	100 to 144	100, 116, 140, 144	OFDM	BPSK	6.0
-		802.11n (HT20)	100 to 144	100, 116, 140, 144	OFDM	BPSK	6.5
-		802.11n (HT40)	102 to 142	102, 110, 134, 142	OFDM	BPSK	13.5
-		802.11ac (VHT80)	106 to 138	106, 122, 138	OFDM	BPSK	29.3
-	5745-5825	802.11a	149 to 165	149, 157, 165	OFDM	BPSK	6.0
-		802.11n (HT20)	149 to 165	149, 157, 165	OFDM	BPSK	6.5
-		802.11n (HT40)	151 to 159	151, 159	OFDM	BPSK	13.5
-		802.11ac (VHT80)	155	155	OFDM	BPSK	29.3

**Test Condition:**

Applicable To	Environmental Conditions	Input Power	Tested by
RE≥1G	25 deg. C, 65 % RH	120 Vac, 60 Hz	Charles Hsiao
RE<1G	25 deg. C, 65 % RH	120 Vac, 60 Hz	Charles Hsiao
PLC	25 deg. C, 65 % RH	120 Vac, 60 Hz	Jisyong Wang
APCM	25 deg. C, 60 % RH	3.3 Vdc	Vincent Huang

### 3.3 Duty Cycle of Test Signal

#### MODULATION TYPE: BPSK

Duty cycle of test signal is < 98 %, duty factor is required.

**802.11a:** Duty cycle = 2.013/2.200 = 0.915, Duty factor =  $10 \cdot \log(1/0.915) = 0.39$

**802.11n (HT20):** Duty cycle = 1.875/2.050 = 0.915, Duty factor =  $10 \cdot \log(1/0.915) = 0.39$

**802.11n (HT40):** Duty cycle = 0.900/1.050 = 0.857, Duty factor =  $10 \cdot \log(1/0.857) = 0.67$

**802.11ac (VHT80):** Duty cycle = 463/613 = 0.755, Duty factor =  $10 \cdot \log(1/0.755) = 1.22$

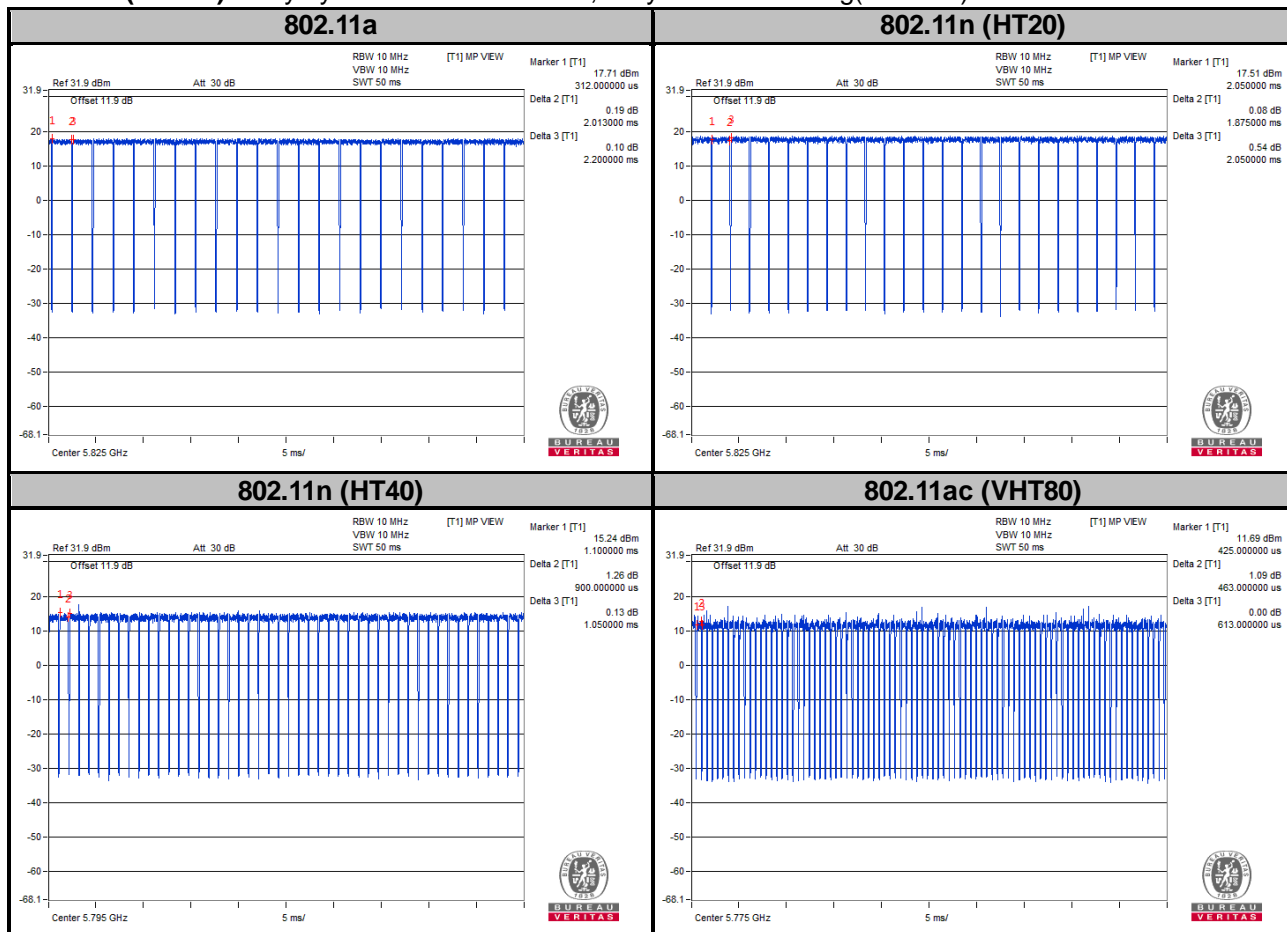

### 3.4 Description of Support Units

The EUT has been tested as an independent unit together with other necessary accessories or support units. The following support units or accessories were used to form a representative test configuration during the tests.

No.	Product	Brand	Model No.	Serial No.	FCC ID
1.	Notebook	DELL	E6420	D3T96R1	N/A

No.	Signal Cable Description Of The Above Support Units
1.	N/A

Note:

1. All power cords of the above support units are non-shielded (1.8m).

#### 3.4.1 Configuration of System under Test

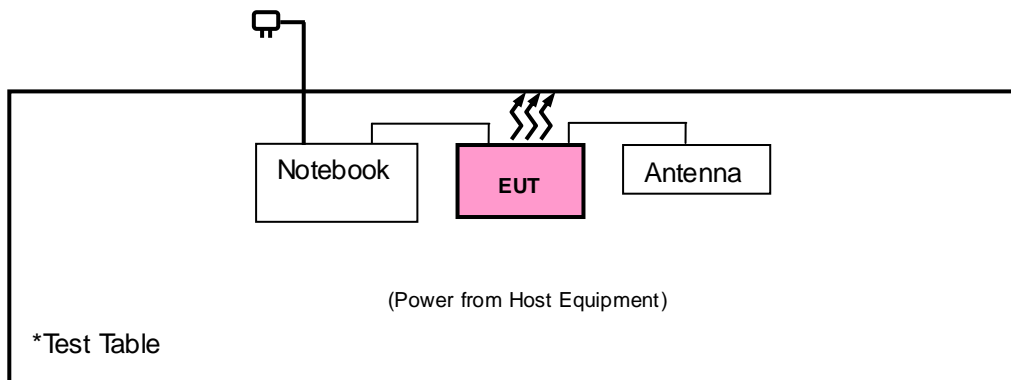

### 3.5 General Description of Applied Standards

The EUT is a RF Product. According to the specifications of the manufacturer, it must comply with the requirements of the following standards:

**FCC Part 15, Subpart E (15.407)**

**KDB 789033 D02 General UNII Test Procedures New Rules v02r01**

**KDB 662911 D01 Multiple Transmitter Output v02r01**

ANSI C63.10-2013

All test items have been performed and recorded as per the above standards.

## 4 Test Types and Results

### 4.1 Radiated Emission and Bandedge Measurement

#### 4.1.1 Limits of Radiated Emission and Bandedge Measurement

Radiated emissions which fall in the restricted bands must comply with the radiated emission limits specified as below table.

Frequencies (MHz)	Field Strength (microvolts/meter)	Measurement Distance (meters)
0.009 ~ 0.490	2400/F (kHz)	300
0.490 ~ 1.705	24000/F (kHz)	30
1.705 ~ 30.0	30	30
30 ~ 88	100	3
88 ~ 216	150	3
216 ~ 960	200	3
Above 960	500	3

**Note:**

1. The lower limit shall apply at the transition frequencies.
2. Emission level (dBuV/m) = 20 log Emission level (uV/m).
3. For frequencies above 1000 MHz, the field strength limits are based on average detector, however, the peak field strength of any emission shall not exceed the maximum permitted average limits, specified above by more than 20 dB under any condition of modulation.

#### 4.1.2 Limits of Unwanted Emission Out of the Restricted Bands

Applicable To		Limit	
789033 D02 General UNII Test Procedures New Rules v02r01		Field Strength at 3 m	
		PK: 74 (dBµV/m)	AV: 54 (dBµV/m)
Frequency Band	Applicable To	EIRP Limit	Equivalent Field Strength at 3 m
5150~5250 MHz	15.407(b)(1)	PK: -27 (dBm/MHz)	PK: 68.2 (dBµV/m)
5250~5350 MHz	15.407(b)(2)		
5470~5725 MHz	15.407(b)(3)		
5725~5850 MHz	15.407(b)(4)(i)	PK:-27 (dBm/MHz) <sup>*1</sup> PK:10 (dBm/MHz) <sup>*2</sup> PK:15.6 (dBm/MHz) <sup>*3</sup> PK:27 (dBm/MHz) <sup>*4</sup>	PK: 68.2 (dBµV/m) <sup>*1</sup> PK:105.2 (dBµV/m) <sup>*2</sup> PK: 110.8 (dBµV/m) <sup>*3</sup> PK:122.2 (dBµV/m) <sup>*4</sup>
	15.407(b)(4)(ii)	Emission limits in section 15.247(d)	

<sup>\*1</sup> beyond 75 MHz or more above of the band edge.

<sup>\*2</sup> below the band edge increasing linearly to 10 dBm/MHz at 25 MHz above.

<sup>\*3</sup> below the band edge increasing linearly to a level of 15.6 dBm/MHz at 5 MHz above.

<sup>\*4</sup> from 5 MHz above or below the band edge increasing linearly to a level of 27 dBm/MHz at the band edge.

**Note:**

The following formula is used to convert the equipment isotropic radiated power (eirp) to field strength:

$$E = \frac{1000000\sqrt{30P}}{3} \mu\text{V/m, where P is the eirp (Watts).$$



#### 4.1.3 Test Instruments

Description & Manufacturer	Model No.	Serial No.	Date of Calibration	Due Date of Calibration
Test Receiver Agilent Technologies	N9038A	MY52260177	Aug. 20, 2018	Aug. 19, 2019
Spectrum Analyzer ROHDE & SCHWARZ	FSV40	100980	Apr. 17, 2018	Apr. 16, 2019
HORN Antenna ETS-Lindgren	3117	00143293	Nov. 25, 2018	Nov. 24, 2019
BILOG Antenna SCHWARZBECK	VULB 9168	9168-616	Nov. 27, 2018	Nov. 26, 2019
HORN Antenna SCHWARZBECK	BBHA 9170	9170-480	Nov. 25, 2018	Nov. 24, 2019
Fixed Attenuator Mini-Circuits	MDCS18N-10	MDCS18N-10-01	Apr. 16, 2018	Apr. 15, 2019
Loop Antenna	EM-6879	269	Sep. 07, 2018	Sep. 06, 2019
Preamplifier Agilent	310N	187226	Jun. 19, 2018	Jun. 18, 2019
Preamplifier Agilent	83017A	MY39501357	Jun. 19, 2018	Jun. 18, 2019
Preamplifier EMCI	EMC 184045	980116	Oct. 12, 2018	Oct. 11, 2019
Power Meter Anritsu	ML2495A	1012010	Sep. 05, 2018	Sep. 04, 2019
Power Sensor Anritsu	MA2411B	1315050	Sep. 04, 2018	Sep. 03, 2019
RF signal cable ETS-LINDGREN	5D-FB	Cable-CH1-01(RFC -SMS-100-SMS-12 0+RFC-SMS-100-S MS-400)	Jun. 19, 2018	Jun. 18, 2019
RF signal cable ETS-LINDGREN	8D-FB	Cable-CH1-02(RFC -SMS-100-SMS-24)	Jun. 19, 2018	Jun. 18, 2019
Boresight Antenna Fixture	FBA-01	FBA-SIP01	NA	NA
Software BV ADT	E3 8.130425b	NA	NA	NA
Antenna Tower MF	NA	NA	NA	NA
Turn Table MF	NA	NA	NA	NA
Antenna Tower & Turn Table Controller MF	MF-7802	NA	NA	NA

- Note: 1. The calibration interval of the above test instruments is 12 / 24 months and the calibrations are traceable to NML/ROC and NIST/USA.
2. The test was performed in HsinTien Chamber 1.
3. The horn antenna and preamplifier (model: 83017A) are used only for the measurement of emission frequency above 1 GHz if tested.
4. The IC Site Registration No. is 7450I-1.

#### 4.1.4 Test Procedures

##### **For Radiated Emission below 30 MHz**

- a. The EUT was placed on the top of a rotating table 0.8 meters above the ground at a 3 meter chamber room. The table was rotated 360 degrees to determine the position of the highest radiation.
- b. The EUT was set 3 meters away from the interference-receiving antenna, which was mounted on the top of a variable-height antenna tower.
- c. Both Parallel, perpendicular, and ground-parallel orientations of the antenna are set to make the measurement.
- d. For each suspected emission, the EUT was arranged to its worst case and the rotatable table was turned from 0 degrees to 360 degrees to find the maximum reading.
- e. The test-receiver system was set to Quasi-Peak Detect Function and Specified Bandwidth with Maximum Hold Mode.

##### **Note:**

1. The resolution bandwidth and video bandwidth of test receiver/spectrum analyzer is 9 kHz at frequency below 30 MHz.

##### **For Radiated Emission above 30 MHz**

- a. The EUT was placed on the top of a rotating table 0.8 meters (for 30 MHz ~ 1 GHz) / 1.5 meters (for above 1 GHz) above the ground at 3 meter chamber room for test. The table was rotated 360 degrees to determine the position of the highest radiation.
- b. The EUT was set 3 meters away from the interference-receiving antenna, which was mounted on the top of a variable-height antenna tower.
- c. The height of antenna is varied from one meter to four meters above the ground to determine the maximum value of the field strength. Both horizontal and vertical polarizations of the antenna are set to make the measurement.
- d. For each suspected emission, the EUT was arranged to its worst case and then the antenna was tuned to heights from 1 meter to 4 meters and the rotatable table was turned from 0 degrees to 360 degrees to find the maximum reading.
- e. The test-receiver system was set to quasi-peak detect function and specified bandwidth with maximum hold mode when the test frequency is below 1 GHz.
- f. The test-receiver system was set to peak and average detected function and specified bandwidth with maximum hold mode when the test frequency is above 1 GHz. If the peak reading value also meets average limit, measurement with the average detector is unnecessary.

##### **Note:**

1. The resolution bandwidth and video bandwidth of test receiver/spectrum analyzer is 120 kHz for Quasi-peak detection (QP) at frequency below 1 GHz.
2. The resolution bandwidth of test receiver/spectrum analyzer is 1 MHz and the video bandwidth is 3 MHz for Peak detection (PK) at frequency above 1 GHz.
3. The resolution bandwidth of test receiver/spectrum analyzer is 1 MHz and the video bandwidth is  $\geq 1/T$  (Duty cycle < 98 %) or 10 Hz (Duty cycle  $\geq 98$  %) for Average detection (AV) at frequency above 1 GHz.  
(11a: RBW = 1 MHz, VBW = 1 kHz ; 11n (HT20): RBW = 1 MHz, VBW = 1 kHz ;  
11n (HT40): RBW = 1 MHz, VBW = 3 kHz ; 11ac (VHT80): RBW = 1 MHz, VBW = 3 kHz)
4. All modes of operation were investigated and the worst-case emissions are reported.

4.1.5 Deviation from Test Standard

No deviation.

4.1.6 Test Setup

<Radiated Emission below 30 MHz>

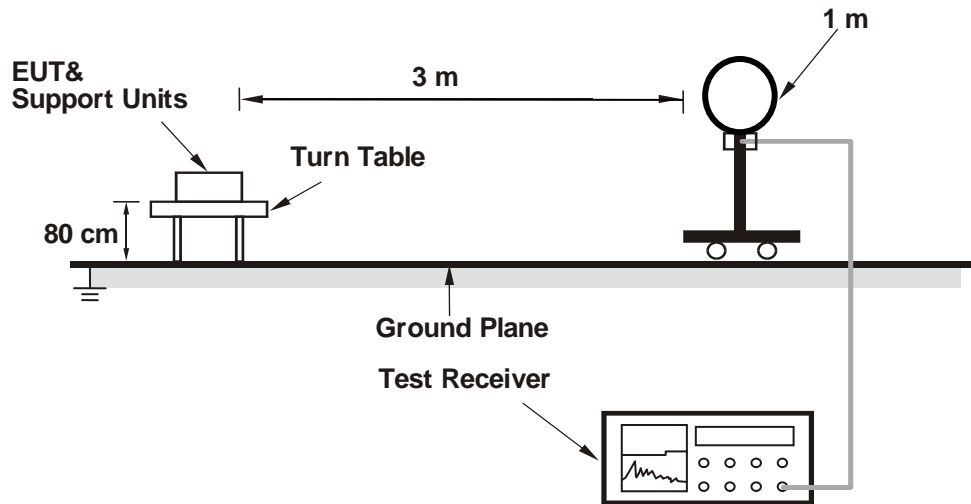

<Radiated Emission 30 MHz to 1 GHz>

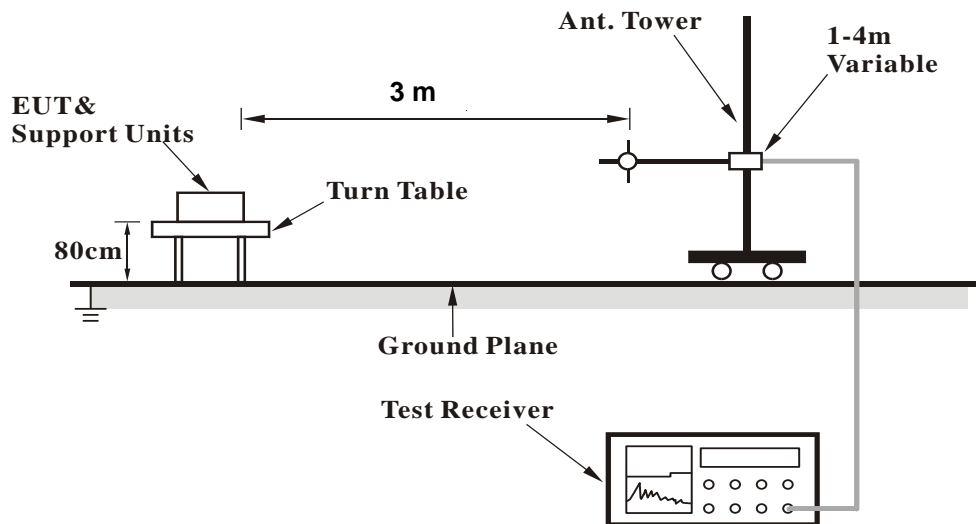

### <Radiated Emission above 1 GHz>

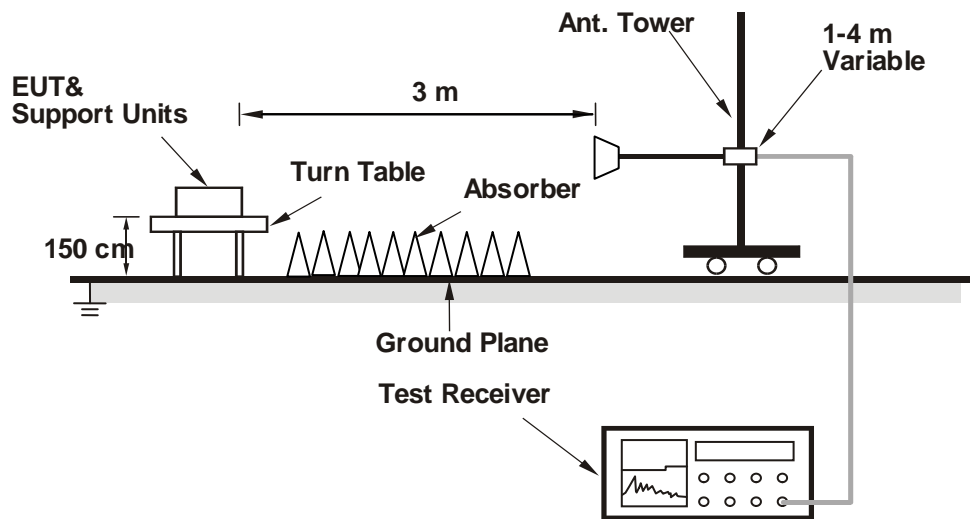

For the actual test configuration, please refer to the attached file (Test Setup Photo).

#### 4.1.7 EUT Operating Conditions

- Placed the EUT on a testing table.
- Use the software to control the EUT under transmission condition continuously at specific channel frequency.

4.1.8 Test Results  
 Above 1 GHz Data :  
 802.11a

EUT Test Condition		Measurement Detail	
Channel	Channel 36	Frequency Range	1 GHz ~ 40 GHz
Input Power	120 Vac, 60 Hz	Detector Function	Peak (PK) Average (AV)
Environmental Conditions	25 deg. C, 65 % RH	Tested By	Charles Hsiao

Antenna Polarity & Test Distance: Horizontal at 3 m										
Frequency (MHz)	Emission Level (dBuV/m)	Read Level (dBuV)	Limit (dBuV/m)	Margin (dB)	Antenna Factor (dB/m)	Cable Loss (dB)	Preamp Factor (dB)	Antenna Height (cm)	Table Angle (Degree)	Remark
5147.75	42.59	30.05	54	-11.41	34.12	8.13	29.71	100	133	Average
5147.75	53.75	41.21	74	-20.25	34.12	8.13	29.71	100	133	Peak
5180	86.57	73.98			34.15	8.16	29.72	100	133	Average
5180	93.78	81.19			34.15	8.16	29.72	100	133	Peak
*10360	57.03	39.76	68.2	-11.17	37.12	12.3	32.15	134	199	Peak

Antenna Polarity & Test Distance: Vertical at 3 m										
Frequency (MHz)	Emission Level (dBuV/m)	Read Level (dBuV)	Limit (dBuV/m)	Margin (dB)	Antenna Factor (dB/m)	Cable Loss (dB)	Preamp Factor (dB)	Antenna Height (cm)	Table Angle (Degree)	Remark
5148.5	48.42	35.88	54	-5.58	34.12	8.13	29.71	110	39	Average
5148.5	63.24	50.7	74	-10.76	34.12	8.13	29.71	110	39	Peak
5180	98.85	86.26			34.15	8.16	29.72	110	39	Average
5180	105.3	92.71			34.15	8.16	29.72	110	39	Peak
*10360	55.95	38.68	68.2	-12.25	37.12	12.3	32.15	115	54	Peak

Remarks:

- Emission Level = Read Level + Antenna Factor + Cable Loss - Preamp Factor  
 Margin value = Emission level – Limit value
- 5180 MHz: Fundamental Frequency
- \*: Out of Restricted Band
- The emission levels of other frequencies were very low against the limit

EUT Test Condition		Measurement Detail	
Channel	Channel 40	Frequency Range	1 GHz ~ 40 GHz
Input Power	120 Vac, 60 Hz	Detector Function	Peak (PK) Average (AV)
Environmental Conditions	25 deg. C, 65 % RH	Tested By	Charles Hsiao

Antenna Polarity & Test Distance: Horizontal at 3 m										
Frequency (MHz)	Emission Level (dBuV/m)	Read Level (dBuV)	Limit (dBuV/m)	Margin (dB)	Antenna Factor (dB/m)	Cable Loss (dB)	Preamp Factor (dB)	Antenna Height (cm)	Table Angle (Degree)	Remark
5124.2	42.24	29.74	54	-11.76	34.11	8.1	29.71	100	133	Average
5124.2	54.35	41.85	74	-19.65	34.11	8.1	29.71	100	133	Peak
5200	86.75	74.12			34.16	8.19	29.72	100	133	Average
5200	93.62	80.99			34.16	8.19	29.72	100	133	Peak
5440.86	42.47	29.39	54	-11.53	34.35	8.48	29.75	100	133	Average
5440.86	54.09	41.01	74	-19.91	34.35	8.48	29.75	100	133	Peak
*10400	56.16	38.85	68.2	-12.04	37.14	12.36	32.19	114	214	Peak
Antenna Polarity & Test Distance: Vertical at 3 m										
Frequency (MHz)	Emission Level (dBuV/m)	Read Level (dBuV)	Limit (dBuV/m)	Margin (dB)	Antenna Factor (dB/m)	Cable Loss (dB)	Preamp Factor (dB)	Antenna Height (cm)	Table Angle (Degree)	Remark
5148.65	44.39	31.85	54	-9.61	34.12	8.13	29.71	110	39	Average
5148.65	54.37	41.83	74	-19.63	34.12	8.13	29.71	110	39	Peak
5200	98.88	86.25			34.16	8.19	29.72	110	39	Average
5200	105.04	92.41			34.16	8.19	29.72	110	39	Peak
5457.36	42.58	29.47	54	-11.42	34.36	8.51	29.76	110	39	Average
5457.36	52.96	39.85	74	-21.04	34.36	8.51	29.76	110	39	Peak
*10400	56.83	39.52	68.2	-11.37	37.14	12.36	32.19	114	316	Peak

Remarks:

- Emission Level = Read Level + Antenna Factor + Cable Loss - Preamp Factor  
Margin value = Emission level – Limit value
- 5200 MHz: Fundamental Frequency
- \*: Out of Restricted Band
- The emission levels of other frequencies were very low against the limit

EUT Test Condition		Measurement Detail	
Channel	Channel 48	Frequency Range	1 GHz ~ 40 GHz
Input Power	120 Vac, 60 Hz	Detector Function	Peak (PK) Average (AV)
Environmental Conditions	25 deg. C, 65 % RH	Tested By	Charles Hsiao

Antenna Polarity & Test Distance: Horizontal at 3 m										
Frequency (MHz)	Emission Level (dBuV/m)	Read Level (dBuV)	Limit (dBuV/m)	Margin (dB)	Antenna Factor (dB/m)	Cable Loss (dB)	Preamp Factor (dB)	Antenna Height (cm)	Table Angle (Degree)	Remark
5240	86.55	73.82			34.19	8.26	29.72	100	133	Average
5240	93.04	80.31			34.19	8.26	29.72	100	133	Peak
5436.35	42.59	29.51	54	-11.41	34.35	8.48	29.75	100	133	Average
5436.35	52.94	39.86	74	-21.06	34.35	8.48	29.75	100	133	Peak
*10480	57.04	39.57	68.2	-11.16	37.19	12.53	32.25	180	25	Peak
Antenna Polarity & Test Distance: Vertical at 3 m										
Frequency (MHz)	Emission Level (dBuV/m)	Read Level (dBuV)	Limit (dBuV/m)	Margin (dB)	Antenna Factor (dB/m)	Cable Loss (dB)	Preamp Factor (dB)	Antenna Height (cm)	Table Angle (Degree)	Remark
5240	98.52	85.79			34.19	8.26	29.72	110	39	Average
5240	105.34	92.61			34.19	8.26	29.72	110	39	Peak
5434.59	42.49	29.41	54	-11.51	34.35	8.48	29.75	110	39	Average
5434.59	54.01	40.93	74	-19.99	34.35	8.48	29.75	110	39	Peak
*10480	57.07	39.6	68.2	-11.13	37.19	12.53	32.25	119	315	Peak

Remarks:

- Emission Level = Read Level + Antenna Factor + Cable Loss - Preamp Factor  
Margin value = Emission level – Limit value
- 5240 MHz: Fundamental Frequency
- \*: Out of Restricted Band
- The emission levels of other frequencies were very low against the limit

EUT Test Condition		Measurement Detail	
Channel	Channel 52	Frequency Range	1 GHz ~ 40 GHz
Input Power	120 Vac, 60 Hz	Detector Function	Peak (PK) Average (AV)
Environmental Conditions	25 deg. C, 65 % RH	Tested By	Charles Hsiao

Antenna Polarity & Test Distance: Horizontal at 3 m										
Frequency (MHz)	Emission Level (dBuV/m)	Read Level (dBuV)	Limit (dBuV/m)	Margin (dB)	Antenna Factor (dB/m)	Cable Loss (dB)	Preamp Factor (dB)	Antenna Height (cm)	Table Angle (Degree)	Remark
5125.25	42.29	29.79	54	-11.71	34.11	8.1	29.71	200	146	Average
5125.25	52.72	40.22	74	-21.28	34.11	8.1	29.71	200	146	Peak
5260	83.66	70.92			34.21	8.26	29.73	200	146	Average
5260	90.68	77.94			34.21	8.26	29.73	200	146	Peak
*10520	57.27	39.72	68.2	-10.93	37.21	12.61	32.27	159	111	Peak

Antenna Polarity & Test Distance: Vertical at 3 m										
Frequency (MHz)	Emission Level (dBuV/m)	Read Level (dBuV)	Limit (dBuV/m)	Margin (dB)	Antenna Factor (dB/m)	Cable Loss (dB)	Preamp Factor (dB)	Antenna Height (cm)	Table Angle (Degree)	Remark
5116.1	42.5	30.01	54	-11.5	34.09	8.1	29.7	112	65	Average
5116.1	52.79	40.3	74	-21.21	34.09	8.1	29.7	112	65	Peak
5260	96.67	83.93			34.21	8.26	29.73	112	65	Average
5260	103.34	90.6			34.21	8.26	29.73	112	65	Peak
*10520	56.51	38.96	68.2	-11.69	37.21	12.61	32.27	124	222	Peak

Remarks:

- Emission Level = Read Level + Antenna Factor + Cable Loss - Preamp Factor  
Margin value = Emission level – Limit value
- 5260 MHz: Fundamental Frequency
- \*: Out of Restricted Band
- The emission levels of other frequencies were very low against the limit



EUT Test Condition		Measurement Detail	
Channel	Channel 60	Frequency Range	1 GHz ~ 40 GHz
Input Power	120 Vac, 60 Hz	Detector Function	Peak (PK) Average (AV)
Environmental Conditions	25 deg. C, 65 % RH	Tested By	Charles Hsiao

Antenna Polarity & Test Distance: Horizontal at 3 m										
Frequency (MHz)	Emission Level (dBuV/m)	Read Level (dBuV)	Limit (dBuV/m)	Margin (dB)	Antenna Factor (dB/m)	Cable Loss (dB)	Preamp Factor (dB)	Antenna Height (cm)	Table Angle (Degree)	Remark
5124.95	42.22	29.72	54	-11.78	34.11	8.1	29.71	200	146	Average
5124.95	52.73	40.23	74	-21.27	34.11	8.1	29.71	200	146	Peak
5300	84.71	71.88			34.24	8.32	29.73	200	146	Average
5300	91.53	78.7			34.24	8.32	29.73	200	146	Peak
5439.65	42.59	29.51	54	-11.41	34.35	8.48	29.75	200	146	Average
5439.65	53.15	40.07	74	-20.85	34.35	8.48	29.75	200	146	Peak
10600	46.25	28.56	54	-7.75	37.28	12.67	32.26	159	326	Average
10600	57.25	39.56	74	-16.75	37.28	12.67	32.26	159	326	Peak

Antenna Polarity & Test Distance: Vertical at 3 m										
Frequency (MHz)	Emission Level (dBuV/m)	Read Level (dBuV)	Limit (dBuV/m)	Margin (dB)	Antenna Factor (dB/m)	Cable Loss (dB)	Preamp Factor (dB)	Antenna Height (cm)	Table Angle (Degree)	Remark
5127.5	42.3	29.8	54	-11.7	34.11	8.1	29.71	112	65	Average
5127.5	52.95	40.45	74	-21.05	34.11	8.1	29.71	112	65	Peak
5300	97.52	84.69			34.24	8.32	29.73	112	65	Average
5300	104.31	91.48			34.24	8.32	29.73	112	65	Peak
5350.11	43.18	30.26	54	-10.82	34.28	8.38	29.74	112	65	Average
5350.11	53.79	40.87	74	-20.21	34.28	8.38	29.74	112	65	Peak
10600	45.96	28.27	54	-8.04	37.28	12.67	32.26	126	245	Average
10600	56.8	39.11	74	-17.2	37.28	12.67	32.26	126	245	Peak

Remarks:

- Emission Level = Read Level + Antenna Factor + Cable Loss - Preamp Factor  
Margin value = Emission level – Limit value
- 5300 MHz: Fundamental Frequency
- The emission levels of other frequencies were very low against the limit

EUT Test Condition		Measurement Detail	
Channel	Channel 64	Frequency Range	1 GHz ~ 40 GHz
Input Power	120 Vac, 60 Hz	Detector Function	Peak (PK) Average (AV)
Environmental Conditions	25 deg. C, 65 % RH	Tested By	Charles Hsiao

Antenna Polarity & Test Distance: Horizontal at 3 m										
Frequency (MHz)	Emission Level (dBuV/m)	Read Level (dBuV)	Limit (dBuV/m)	Margin (dB)	Antenna Factor (dB/m)	Cable Loss (dB)	Preamp Factor (dB)	Antenna Height (cm)	Table Angle (Degree)	Remark
5320	84.25	71.38			34.25	8.35	29.73	200	146	Average
5320	91.78	78.91			34.25	8.35	29.73	200	146	Peak
5456.81	42.39	29.28	54	-11.61	34.36	8.51	29.76	200	146	Average
5456.81	54.08	40.97	74	-19.92	34.36	8.51	29.76	200	146	Peak
10640	46.02	28.26	54	-7.98	37.31	12.71	32.26	134	159	Average
10640	56.72	38.96	74	-17.28	37.31	12.71	32.26	134	159	Peak

Antenna Polarity & Test Distance: Vertical at 3 m										
Frequency (MHz)	Emission Level (dBuV/m)	Read Level (dBuV)	Limit (dBuV/m)	Margin (dB)	Antenna Factor (dB/m)	Cable Loss (dB)	Preamp Factor (dB)	Antenna Height (cm)	Table Angle (Degree)	Remark
5320	97.07	84.2			34.25	8.35	29.73	112	65	Average
5320	104.94	92.07			34.25	8.35	29.73	112	65	Peak
5350.11	44.02	31.1	54	-9.98	34.28	8.38	29.74	112	65	Average
5350.11	60.99	48.07	74	-13.01	34.28	8.38	29.74	112	65	Peak
10640	46	28.24	54	-8	37.31	12.71	32.26	127	344	Average
10640	57.38	39.62	74	-16.62	37.31	12.71	32.26	127	344	Peak

Remarks:

- Emission Level = Read Level + Antenna Factor + Cable Loss - Preamp Factor  
Margin value = Emission level – Limit value
- 5320 MHz: Fundamental Frequency
- The emission levels of other frequencies were very low against the limit

EUT Test Condition		Measurement Detail	
Channel	Channel 100	Frequency Range	1 GHz ~ 40 GHz
Input Power	120 Vac, 60 Hz	Detector Function	Peak (PK) Average (AV)
Environmental Conditions	25 deg. C, 65 % RH	Tested By	Charles Hsiao

Antenna Polarity & Test Distance: Horizontal at 3 m										
Frequency (MHz)	Emission Level (dBuV/m)	Read Level (dBuV)	Limit (dBuV/m)	Margin (dB)	Antenna Factor (dB/m)	Cable Loss (dB)	Preamp Factor (dB)	Antenna Height (cm)	Table Angle (Degree)	Remark
5459.76	42.79	29.68	54	-11.21	34.36	8.51	29.76	114	83	Average
5459.76	53.75	40.64	74	-20.25	34.36	8.51	29.76	114	83	Peak
*5470.64	53.31	40.19	68.2	-14.89	34.37	8.51	29.76	114	83	Peak
5500	88.79	75.58			34.4	8.57	29.76	114	83	Average
5500	95.57	82.36			34.4	8.57	29.76	114	83	Peak
11000	47.02	28.69	54	-6.98	37.6	12.96	32.23	124	148	Average
11000	57.89	39.56	74	-16.11	37.6	12.96	32.23	124	148	Peak

Antenna Polarity & Test Distance: Vertical at 3 m										
Frequency (MHz)	Emission Level (dBuV/m)	Read Level (dBuV)	Limit (dBuV/m)	Margin (dB)	Antenna Factor (dB/m)	Cable Loss (dB)	Preamp Factor (dB)	Antenna Height (cm)	Table Angle (Degree)	Remark
5458.8	44.88	31.77	54	-9.12	34.36	8.51	29.76	118	45	Average
5458.8	62.16	49.05	74	-11.84	34.36	8.51	29.76	118	45	Peak
*5470.64	67.19	54.07	68.2	-1.01	34.37	8.51	29.76	118	45	Peak
5500	99.36	86.15			34.4	8.57	29.76	118	45	Average
5500	106.26	93.05			34.4	8.57	29.76	118	45	Peak
11000	46.91	28.58	54	-7.09	37.6	12.96	32.23	129	346	Average
11000	58.19	39.86	74	-15.81	37.6	12.96	32.23	129	346	Peak

Remarks:

- Emission Level = Read Level + Antenna Factor + Cable Loss - Preamp Factor  
Margin value = Emission level – Limit value
- 5500 MHz: Fundamental Frequency
- \*: Out of Restricted Band
- The emission levels of other frequencies were very low against the limit

EUT Test Condition		Measurement Detail	
Channel	Channel 116	Frequency Range	1 GHz ~ 40 GHz
Input Power	120 Vac, 60 Hz	Detector Function	Peak (PK) Average (AV)
Environmental Conditions	25 deg. C, 65 % RH	Tested By	Charles Hsiao

Antenna Polarity & Test Distance: Horizontal at 3 m										
Frequency (MHz)	Emission Level (dBuV/m)	Read Level (dBuV)	Limit (dBuV/m)	Margin (dB)	Antenna Factor (dB/m)	Cable Loss (dB)	Preamp Factor (dB)	Antenna Height (cm)	Table Angle (Degree)	Remark
5443.6	42.36	29.28	54	-11.64	34.35	8.48	29.75	114	83	Average
5443.6	52.99	39.91	74	-21.01	34.35	8.48	29.75	114	83	Peak
*5470.8	51.22	38.07	68.2	-16.98	34.37	8.54	29.76	114	83	Peak
5580	87.14	73.88			34.47	8.6	29.81	114	83	Average
5580	94.72	81.46			34.47	8.6	29.81	114	83	Peak
*5724.76	52.95	39.54	68.2	-15.25	34.62	8.65	29.86	114	83	Peak
11160	46.76	28.41	54	-7.24	37.7	12.83	32.18	127	14	Average
11160	58.53	40.18	74	-15.47	37.7	12.83	32.18	127	14	Peak

Antenna Polarity & Test Distance: Vertical at 3 m										
Frequency (MHz)	Emission Level (dBuV/m)	Read Level (dBuV)	Limit (dBuV/m)	Margin (dB)	Antenna Factor (dB/m)	Cable Loss (dB)	Preamp Factor (dB)	Antenna Height (cm)	Table Angle (Degree)	Remark
5451.6	43.74	30.63	54	-10.26	34.36	8.51	29.76	118	45	Average
5451.6	53.8	40.69	74	-20.2	34.36	8.51	29.76	118	45	Peak
*5470.8	52.17	39.02	68.2	-16.03	34.37	8.54	29.76	118	45	Peak
5580	98.63	85.37			34.47	8.6	29.81	118	45	Average
5580	105.12	91.86			34.47	8.6	29.81	118	45	Peak
*5725.56	52.41	39	68.2	-15.79	34.62	8.65	29.86	118	45	Peak
11160	46.94	28.59	54	-7.06	37.7	12.83	32.18	149	77	Average
11160	58.1	39.75	74	-15.9	37.7	12.83	32.18	149	77	Peak

Remarks:

- Emission Level = Read Level + Antenna Factor + Cable Loss - Preamp Factor  
Margin value = Emission level – Limit value
- 5580 MHz: Fundamental Frequency
- \*: Out of Restricted Band
- The emission levels of other frequencies were very low against the limit

EUT Test Condition		Measurement Detail	
Channel	Channel 140	Frequency Range	1 GHz ~ 40 GHz
Input Power	120 Vac, 60 Hz	Detector Function	Peak (PK) Average (AV)
Environmental Conditions	25 deg. C, 65 % RH	Tested By	Charles Hsiao

Antenna Polarity & Test Distance: Horizontal at 3 m										
Frequency (MHz)	Emission Level (dBuV/m)	Read Level (dBuV)	Limit (dBuV/m)	Margin (dB)	Antenna Factor (dB/m)	Cable Loss (dB)	Preamp Factor (dB)	Antenna Height (cm)	Table Angle (Degree)	Remark
5700	88.52	75.14			34.59	8.64	29.85	114	83	Average
5700	95.3	81.92			34.59	8.64	29.85	114	83	Peak
*5724.36	52.46	39.05	68.2	-15.74	34.62	8.65	29.86	114	83	Peak
11400	46.99	28.57	54	-7.01	37.84	12.67	32.09	126	22	Average
11400	59.66	41.24	74	-14.34	37.84	12.67	32.09	126	22	Peak

Antenna Polarity & Test Distance: Vertical at 3 m										
Frequency (MHz)	Emission Level (dBuV/m)	Read Level (dBuV)	Limit (dBuV/m)	Margin (dB)	Antenna Factor (dB/m)	Cable Loss (dB)	Preamp Factor (dB)	Antenna Height (cm)	Table Angle (Degree)	Remark
5700	99.85	86.47			34.59	8.64	29.85	118	45	Average
5700	106.42	93.04			34.59	8.64	29.85	118	45	Peak
*5724.76	67	53.59	68.2	-1.2	34.62	8.65	29.86	118	45	Peak
11400	47.01	28.59	54	-6.99	37.84	12.67	32.09	125	184	Average
11400	58.18	39.76	74	-15.82	37.84	12.67	32.09	125	184	Peak

Remarks:

- Emission Level = Read Level + Antenna Factor + Cable Loss - Preamp Factor  
Margin value = Emission level – Limit value
- 5700 MHz: Fundamental Frequency
- \*: Out of Restricted Band
- The emission levels of other frequencies were very low against the limit

EUT Test Condition		Measurement Detail	
Channel	Channel 144	Frequency Range	1 GHz ~ 40 GHz
Input Power	120 Vac, 60 Hz	Detector Function	Peak (PK) Average (AV)
Environmental Conditions	25 deg. C, 65 % RH	Tested By	Charles Hsiao

Antenna Polarity & Test Distance: Horizontal at 3 m										
Frequency (MHz)	Emission Level (dBuV/m)	Read Level (dBuV)	Limit (dBuV/m)	Margin (dB)	Antenna Factor (dB/m)	Cable Loss (dB)	Preamp Factor (dB)	Antenna Height (cm)	Table Angle (Degree)	Remark
5446.96	42.4	29.28	54	-11.6	34.36	8.51	29.75	114	83	Average
5446.96	53.52	40.4	74	-20.48	34.36	8.51	29.75	114	83	Peak
*5468.88	51.49	38.37	68.2	-16.71	34.37	8.51	29.76	114	83	Peak
5720	87.44	74.03			34.62	8.65	29.86	114	83	Average
5720	94.06	80.65			34.62	8.65	29.86	114	83	Peak
11440	47.13	28.71	54	-6.87	37.86	12.65	32.09	124	1	Average
11440	58.75	40.33	74	-15.25	37.86	12.65	32.09	124	1	Peak

Antenna Polarity & Test Distance: Vertical at 3 m										
Frequency (MHz)	Emission Level (dBuV/m)	Read Level (dBuV)	Limit (dBuV/m)	Margin (dB)	Antenna Factor (dB/m)	Cable Loss (dB)	Preamp Factor (dB)	Antenna Height (cm)	Table Angle (Degree)	Remark
5457.84	42.49	29.38	54	-11.51	34.36	8.51	29.76	118	45	Average
5457.84	52.99	39.88	74	-21.01	34.36	8.51	29.76	118	45	Peak
*5470	52.34	39.22	68.2	-15.86	34.37	8.51	29.76	118	45	Peak
5720	98.5	85.09			34.62	8.65	29.86	118	45	Average
5720	105.64	92.23			34.62	8.65	29.86	118	45	Peak
11440	46.96	28.54	54	-7.04	37.86	12.65	32.09	152	328	Average
11440	57.82	39.4	74	-16.18	37.86	12.65	32.09	152	328	Peak

Remarks:

- Emission Level = Read Level + Antenna Factor + Cable Loss - Preamp Factor  
Margin value = Emission level – Limit value
- 5720 MHz: Fundamental Frequency
- \*: Out of Restricted Band
- The emission levels of other frequencies were very low against the limit

EUT Test Condition		Measurement Detail	
Channel	Channel 149	Frequency Range	1 GHz ~ 40 GHz
Input Power	120 Vac, 60 Hz	Detector Function	Peak (PK) Average (AV)
Environmental Conditions	25 deg. C, 65 % RH	Tested By	Charles Hsiao

### <Spurious Emission>

Antenna Polarity & Test Distance: Horizontal at 3 m										
Frequency (MHz)	Emission Level (dBuV/m)	Read Level (dBuV)	Limit (dBuV/m)	Margin (dB)	Antenna Factor (dB/m)	Cable Loss (dB)	Preamp Factor (dB)	Antenna Height (cm)	Table Angle (Degree)	Remark
5745	86.43	73.01			34.64	8.66	29.88	100	41	Average
5745	93.09	79.67			34.64	8.66	29.88	100	41	Peak
11490	46.98	28.54	54	-7.02	37.89	12.62	32.07	117	14	Average
11490	58.24	39.8	74	-15.76	37.89	12.62	32.07	117	14	Peak
Antenna Polarity & Test Distance: Vertical at 3 m										
Frequency (MHz)	Emission Level (dBuV/m)	Read Level (dBuV)	Limit (dBuV/m)	Margin (dB)	Antenna Factor (dB/m)	Cable Loss (dB)	Preamp Factor (dB)	Antenna Height (cm)	Table Angle (Degree)	Remark
5745	96.61	83.19			34.64	8.66	29.88	122	338	Average
5745	103.78	90.36			34.64	8.66	29.88	122	338	Peak
11490	47.07	28.63	54	-6.93	37.89	12.62	32.07	135	165	Average
11490	58.45	40.01	74	-15.55	37.89	12.62	32.07	135	165	Peak

### <Out of Band Emission (OOBE)>

Antenna Polarity & Test Distance: Horizontal at 3 m										
Frequency (MHz)	Emission Level (dBuV/m)	Read Level (dBuV)	Limit (dBuV/m)	Margin (dB)	Antenna Factor (dB/m)	Cable Loss (dB)	Preamp Factor (dB)	Antenna Height (cm)	Table Angle (Degree)	Remark
*5548.3	53.54	40.29	68.2	-14.66	34.45	8.58	29.78	100	41	Peak
5652.775	52.15	38.79	70.25	-18.1	34.56	8.63	29.83	100	41	Peak
5923.675	51.63	38.03	69.18	-17.55	34.83	8.73	29.96	100	41	Peak
*6001.375	53.21	39.54	68.2	-14.99	34.9	8.76	29.99	100	41	Peak
Antenna Polarity & Test Distance: Vertical at 3 m										
Frequency (MHz)	Emission Level (dBuV/m)	Read Level (dBuV)	Limit (dBuV/m)	Margin (dB)	Antenna Factor (dB/m)	Cable Loss (dB)	Preamp Factor (dB)	Antenna Height (cm)	Table Angle (Degree)	Remark
*5613.4	53.84	40.55	68.2	-14.36	34.5	8.61	29.82	122	338	Peak
5652.25	51.03	37.68	69.86	-18.83	34.56	8.62	29.83	122	338	Peak
5922.1	48.93	35.33	70.35	-21.42	34.83	8.73	29.96	122	338	Peak
*5955.175	53.7	40.08	68.2	-14.5	34.85	8.74	29.97	122	338	Peak

#### Remarks:

- Emission Level = Read Level + Antenna Factor + Cable Loss - Preamp Factor  
Margin value = Emission level – Limit value
- 5745 MHz: Fundamental Frequency
- \*: Out of Restricted Band
- The emission levels of other frequencies were very low against the limit

EUT Test Condition		Measurement Detail	
Channel	Channel 157	Frequency Range	1 GHz ~ 40 GHz
Input Power	120 Vac, 60 Hz	Detector Function	Peak (PK) Average (AV)
Environmental Conditions	25 deg. C, 65 % RH	Tested By	Charles Hsiao

<Spurious Emission>

Antenna Polarity & Test Distance: Horizontal at 3 m										
Frequency (MHz)	Emission Level (dBuV/m)	Read Level (dBuV)	Limit (dBuV/m)	Margin (dB)	Antenna Factor (dB/m)	Cable Loss (dB)	Preamp Factor (dB)	Antenna Height (cm)	Table Angle (Degree)	Remark
5785	86.26	72.8			34.68	8.68	29.9	100	41	Average
5785	93.52	80.06			34.68	8.68	29.9	100	41	Peak
11570	46.99	28.36	54	-7.01	38	12.68	32.05	134	31	Average
11570	59.12	40.49	74	-14.88	38	12.68	32.05	134	31	Peak
Antenna Polarity & Test Distance: Vertical at 3 m										
Frequency (MHz)	Emission Level (dBuV/m)	Read Level (dBuV)	Limit (dBuV/m)	Margin (dB)	Antenna Factor (dB/m)	Cable Loss (dB)	Preamp Factor (dB)	Antenna Height (cm)	Table Angle (Degree)	Remark
5785	96.33	82.87			34.68	8.68	29.9	122	338	Average
5785	103.14	89.68			34.68	8.68	29.9	122	338	Peak
11570	47.22	28.59	54	-6.78	38	12.68	32.05	125	302	Average
11570	57.95	39.32	74	-16.05	38	12.68	32.05	125	302	Peak

<Out of Band Emission (OOBE)>

Antenna Polarity & Test Distance: Horizontal at 3 m										
Frequency (MHz)	Emission Level (dBuV/m)	Read Level (dBuV)	Limit (dBuV/m)	Margin (dB)	Antenna Factor (dB/m)	Cable Loss (dB)	Preamp Factor (dB)	Antenna Height (cm)	Table Angle (Degree)	Remark
*5583.475	52.66	39.38	68.2	-15.54	34.49	8.6	29.81	100	41	Peak
5654.35	52.01	38.66	71.42	-19.41	34.56	8.63	29.84	100	41	Peak
5922.1	52.46	38.86	70.35	-17.89	34.83	8.73	29.96	100	41	Peak
*5939.95	53.19	39.57	68.2	-15.01	34.85	8.74	29.97	100	41	Peak
Antenna Polarity & Test Distance: Vertical at 3 m										
Frequency (MHz)	Emission Level (dBuV/m)	Read Level (dBuV)	Limit (dBuV/m)	Margin (dB)	Antenna Factor (dB/m)	Cable Loss (dB)	Preamp Factor (dB)	Antenna Height (cm)	Table Angle (Degree)	Remark
*5648.05	52.68	39.35	68.2	-15.52	34.54	8.62	29.83	122	338	Peak
5653.3	53.46	40.1	70.64	-17.18	34.56	8.63	29.83	122	338	Peak
5917.375	52.35	38.77	73.84	-21.49	34.81	8.73	29.96	122	338	Peak
*6008.725	53.2	39.51	68.2	-15	34.92	8.76	29.99	122	338	Peak

Remarks:

- Emission Level = Read Level + Antenna Factor + Cable Loss - Preamp Factor  
Margin value = Emission level – Limit value
- 5785 MHz: Fundamental Frequency
- \*: Out of Restricted Band
- The emission levels of other frequencies were very low against the limit



EUT Test Condition		Measurement Detail	
Channel	Channel 165	Frequency Range	1 GHz ~ 40 GHz
Input Power	120 Vac, 60 Hz	Detector Function	Peak (PK) Average (AV)
Environmental Conditions	25 deg. C, 65 % RH	Tested By	Charles Hsiao

<Spurious Emission>

Antenna Polarity & Test Distance: Horizontal at 3 m										
Frequency (MHz)	Emission Level (dBuV/m)	Read Level (dBuV)	Limit (dBuV/m)	Margin (dB)	Antenna Factor (dB/m)	Cable Loss (dB)	Preamp Factor (dB)	Antenna Height (cm)	Table Angle (Degree)	Remark
5825	86.58	73.07			34.73	8.69	29.91	100	41	Average
5825	93.68	80.17			34.73	8.69	29.91	100	41	Peak
11650	47.38	28.52	54	-6.62	38.09	12.8	32.03	157	317	Average
11650	57.56	38.7	74	-16.44	38.09	12.8	32.03	157	317	Peak
Antenna Polarity & Test Distance: Vertical at 3 m										
Frequency (MHz)	Emission Level (dBuV/m)	Read Level (dBuV)	Limit (dBuV/m)	Margin (dB)	Antenna Factor (dB/m)	Cable Loss (dB)	Preamp Factor (dB)	Antenna Height (cm)	Table Angle (Degree)	Remark
5825	96.33	82.82			34.73	8.69	29.91	122	338	Average
5825	103.17	89.66			34.73	8.69	29.91	122	338	Peak
11650	47.12	28.26	54	-6.88	38.09	12.8	32.03	113	225	Average
11650	57.7	38.84	74	-16.3	38.09	12.8	32.03	113	225	Peak

<Out of Band Emission (OOBE)>

Antenna Polarity & Test Distance: Horizontal at 3 m										
Frequency (MHz)	Emission Level (dBuV/m)	Read Level (dBuV)	Limit (dBuV/m)	Margin (dB)	Antenna Factor (dB/m)	Cable Loss (dB)	Preamp Factor (dB)	Antenna Height (cm)	Table Angle (Degree)	Remark
*5627.575	53.38	40.06	68.2	-14.82	34.52	8.62	29.82	100	41	Peak
5658.025	51.85	38.5	74.14	-22.29	34.56	8.63	29.84	100	41	Peak
5924.2	53.46	39.86	68.79	-15.33	34.83	8.73	29.96	100	41	Peak
*5992.45	53.42	39.75	68.2	-14.78	34.9	8.76	29.99	100	41	Peak
Antenna Polarity & Test Distance: Vertical at 3 m										
Frequency (MHz)	Emission Level (dBuV/m)	Read Level (dBuV)	Limit (dBuV/m)	Margin (dB)	Antenna Factor (dB/m)	Cable Loss (dB)	Preamp Factor (dB)	Antenna Height (cm)	Table Angle (Degree)	Remark
*5556.175	53.4	40.15	68.2	-14.8	34.45	8.59	29.79	122	338	Peak
5653.825	52.23	38.88	71.03	-18.8	34.56	8.63	29.84	122	338	Peak
5917.375	53.46	39.88	73.84	-20.38	34.81	8.73	29.96	122	338	Peak
*5959.375	54.52	40.88	68.2	-13.68	34.87	8.74	29.97	122	338	Peak

Remarks:

- Emission Level = Read Level + Antenna Factor + Cable Loss - Preamp Factor  
Margin value = Emission level – Limit value
- 5825 MHz: Fundamental Frequency
- \*: Out of Restricted Band
- The emission levels of other frequencies were very low against the limit

### 802.11n (HT20)

EUT Test Condition		Measurement Detail	
Channel	Channel 36	Frequency Range	1 GHz ~ 40 GHz
Input Power	120 Vac, 60 Hz	Detector Function	Peak (PK) Average (AV)
Environmental Conditions	25 deg. C, 65 % RH	Tested By	Charles Hsiao

#### Antenna Polarity & Test Distance: Horizontal at 3 m

Frequency (MHz)	Emission Level (dBuV/m)	Read Level (dBuV)	Limit (dBuV/m)	Margin (dB)	Antenna Factor (dB/m)	Cable Loss (dB)	Preamp Factor (dB)	Antenna Height (cm)	Table Angle (Degree)	Remark
5149.85	44.34	31.8	54	-9.66	34.12	8.13	29.71	101	110	Average
5149.85	59.04	46.5	74	-14.96	34.12	8.13	29.71	101	110	Peak
5180	91.74	79.15			34.15	8.16	29.72	101	110	Average
5180	98.24	85.65			34.15	8.16	29.72	101	110	Peak
*10360	56.06	38.79	68.2	-12.14	37.12	12.3	32.15	112	300	Peak

#### Antenna Polarity & Test Distance: Vertical at 3 m

Frequency (MHz)	Emission Level (dBuV/m)	Read Level (dBuV)	Limit (dBuV/m)	Margin (dB)	Antenna Factor (dB/m)	Cable Loss (dB)	Preamp Factor (dB)	Antenna Height (cm)	Table Angle (Degree)	Remark
5150	52.46	39.92	54	-1.54	34.12	8.13	29.71	100	68	Average
5150	70.01	57.47	74	-3.99	34.12	8.13	29.71	100	68	Peak
5180	103.35	90.76			34.15	8.16	29.72	106	68	Average
5180	110.21	97.62			34.15	8.16	29.72	106	68	Peak
*10360	59.16	41.89	68.2	-9.04	37.12	12.3	32.15	200	118	Peak

#### Remarks:

- Emission Level = Read Level + Antenna Factor + Cable Loss - Preamp Factor  
Margin value = Emission level – Limit value
- 5180 MHz: Fundamental Frequency
- \*: Out of Restricted Band
- The emission levels of other frequencies were very low against the limit

EUT Test Condition		Measurement Detail	
Channel	Channel 40	Frequency Range	1 GHz ~ 40 GHz
Input Power	120 Vac, 60 Hz	Detector Function	Peak (PK) Average (AV)
Environmental Conditions	25 deg. C, 65 % RH	Tested By	Charles Hsiao

Antenna Polarity & Test Distance: Horizontal at 3 m										
Frequency (MHz)	Emission Level (dBuV/m)	Read Level (dBuV)	Limit (dBuV/m)	Margin (dB)	Antenna Factor (dB/m)	Cable Loss (dB)	Preamp Factor (dB)	Antenna Height (cm)	Table Angle (Degree)	Remark
5148.95	42.52	29.98	54	-11.48	34.12	8.13	29.71	101	110	Average
5148.95	53.25	40.71	74	-20.75	34.12	8.13	29.71	101	110	Peak
5200	91.77	79.14			34.16	8.19	29.72	101	110	Average
5200	98.35	85.72			34.16	8.19	29.72	101	110	Peak
5437.56	42.47	29.39	54	-11.53	34.35	8.48	29.75	101	110	Average
5437.56	53.07	39.99	74	-20.93	34.35	8.48	29.75	101	110	Peak
*10400	57.31	40	68.2	-10.89	37.14	12.36	32.19	100	360	Peak
Antenna Polarity & Test Distance: Vertical at 3 m										
Frequency (MHz)	Emission Level (dBuV/m)	Read Level (dBuV)	Limit (dBuV/m)	Margin (dB)	Antenna Factor (dB/m)	Cable Loss (dB)	Preamp Factor (dB)	Antenna Height (cm)	Table Angle (Degree)	Remark
5149.55	45.14	32.6	54	-8.86	34.12	8.13	29.71	106	68	Average
5149.55	59.63	47.09	74	-14.37	34.12	8.13	29.71	106	68	Peak
5200	104.57	91.94			34.16	8.19	29.72	106	68	Average
5200	111.17	98.54			34.16	8.19	29.72	106	68	Peak
5446.03	42.59	29.47	54	-11.41	34.36	8.51	29.75	106	68	Average
5446.03	53.31	40.19	74	-20.69	34.36	8.51	29.75	106	68	Peak
*10400	61.14	43.83	68.2	-7.06	37.14	12.36	32.19	200	118	Peak

Remarks:

- Emission Level = Read Level + Antenna Factor + Cable Loss - Preamp Factor  
Margin value = Emission level – Limit value
- 5200 MHz: Fundamental Frequency
- \*: Out of Restricted Band
- The emission levels of other frequencies were very low against the limit

EUT Test Condition		Measurement Detail	
Channel	Channel 48	Frequency Range	1 GHz ~ 40 GHz
Input Power	120 Vac, 60 Hz	Detector Function	Peak (PK) Average (AV)
Environmental Conditions	25 deg. C, 65 % RH	Tested By	Charles Hsiao

Antenna Polarity & Test Distance: Horizontal at 3 m										
Frequency (MHz)	Emission Level (dBuV/m)	Read Level (dBuV)	Limit (dBuV/m)	Margin (dB)	Antenna Factor (dB/m)	Cable Loss (dB)	Preamp Factor (dB)	Antenna Height (cm)	Table Angle (Degree)	Remark
5240	91.55	78.82			34.19	8.26	29.72	101	110	Average
5240	98.24	85.51			34.19	8.26	29.72	101	110	Peak
5439.1	42.67	29.59	54	-11.33	34.35	8.48	29.75	101	110	Average
5439.1	53.12	40.04	74	-20.88	34.35	8.48	29.75	101	110	Peak
*10480	55.58	38.11	68.2	-12.62	37.19	12.53	32.25	119	325	Peak

Antenna Polarity & Test Distance: Vertical at 3 m										
Frequency (MHz)	Emission Level (dBuV/m)	Read Level (dBuV)	Limit (dBuV/m)	Margin (dB)	Antenna Factor (dB/m)	Cable Loss (dB)	Preamp Factor (dB)	Antenna Height (cm)	Table Angle (Degree)	Remark
5240	104.47	91.74			34.19	8.26	29.72	106	68	Average
5240	111.58	98.85			34.19	8.26	29.72	106	68	Peak
5370.46	42.71	29.75	54	-11.29	34.29	8.41	29.74	106	68	Average
5370.46	53.81	40.85	74	-20.19	34.29	8.41	29.74	106	68	Peak
*10480	57.43	39.96	68.2	-10.77	37.19	12.53	32.25	119	26	Peak

Remarks:

- Emission Level = Read Level + Antenna Factor + Cable Loss - Preamp Factor  
Margin value = Emission level – Limit value
- 5240 MHz: Fundamental Frequency
- \*: Out of Restricted Band
- The emission levels of other frequencies were very low against the limit

EUT Test Condition		Measurement Detail	
Channel	Channel 52	Frequency Range	1 GHz ~ 40 GHz
Input Power	120 Vac, 60 Hz	Detector Function	Peak (PK) Average (AV)
Environmental Conditions	25 deg. C, 65 % RH	Tested By	Charles Hsiao

Antenna Polarity & Test Distance: Horizontal at 3 m										
Frequency (MHz)	Emission Level (dBuV/m)	Read Level (dBuV)	Limit (dBuV/m)	Margin (dB)	Antenna Factor (dB/m)	Cable Loss (dB)	Preamp Factor (dB)	Antenna Height (cm)	Table Angle (Degree)	Remark
5105.9	42.16	29.7	54	-11.84	34.09	8.07	29.7	100	110	Average
5105.9	52.4	39.94	74	-21.6	34.09	8.07	29.7	100	110	Peak
5260	91.18	78.44			34.21	8.26	29.73	100	110	Average
5260	98.77	86.03			34.21	8.26	29.73	100	110	Peak
*10520	55.86	38.31	68.2	-12.34	37.21	12.61	32.27	105	144	Peak

Antenna Polarity & Test Distance: Vertical at 3 m										
Frequency (MHz)	Emission Level (dBuV/m)	Read Level (dBuV)	Limit (dBuV/m)	Margin (dB)	Antenna Factor (dB/m)	Cable Loss (dB)	Preamp Factor (dB)	Antenna Height (cm)	Table Angle (Degree)	Remark
5142.5	42.25	29.71	54	-11.75	34.12	8.13	29.71	112	59	Average
5142.5	53.53	40.99	74	-20.47	34.12	8.13	29.71	112	59	Peak
5260	103.17	90.43			34.21	8.26	29.73	112	59	Average
5260	110.38	97.64			34.21	8.26	29.73	112	59	Peak
*10520	56.73	39.18	68.2	-11.47	37.21	12.61	32.27	124	213	Peak

Remarks:

- Emission Level = Read Level + Antenna Factor + Cable Loss - Preamp Factor  
Margin value = Emission level – Limit value
- 5260 MHz: Fundamental Frequency
- \*: Out of Restricted Band
- The emission levels of other frequencies were very low against the limit

EUT Test Condition		Measurement Detail	
Channel	Channel 60	Frequency Range	1 GHz ~ 40 GHz
Input Power	120 Vac, 60 Hz	Detector Function	Peak (PK) Average (AV)
Environmental Conditions	25 deg. C, 65 % RH	Tested By	Charles Hsiao

Antenna Polarity & Test Distance: Horizontal at 3 m										
Frequency (MHz)	Emission Level (dBuV/m)	Read Level (dBuV)	Limit (dBuV/m)	Margin (dB)	Antenna Factor (dB/m)	Cable Loss (dB)	Preamp Factor (dB)	Antenna Height (cm)	Table Angle (Degree)	Remark
5125.7	41.96	29.46	54	-12.04	34.11	8.1	29.71	100	110	Average
5125.7	52.37	39.87	74	-21.63	34.11	8.1	29.71	100	110	Peak
5300	92.44	79.61			34.24	8.32	29.73	100	110	Average
5300	99.19	86.36			34.24	8.32	29.73	100	110	Peak
5447.02	42.29	29.17	54	-11.71	34.36	8.51	29.75	100	110	Average
5447.02	53.76	40.64	74	-20.24	34.36	8.51	29.75	100	110	Peak
10600	46.37	28.68	54	-7.63	37.28	12.67	32.26	124	4	Average
10600	56.34	38.65	74	-17.66	37.28	12.67	32.26	124	4	Peak

Antenna Polarity & Test Distance: Vertical at 3 m										
Frequency (MHz)	Emission Level (dBuV/m)	Read Level (dBuV)	Limit (dBuV/m)	Margin (dB)	Antenna Factor (dB/m)	Cable Loss (dB)	Preamp Factor (dB)	Antenna Height (cm)	Table Angle (Degree)	Remark
5149.55	42.3	29.76	54	-11.7	34.12	8.13	29.71	112	59	Average
5149.55	53.04	40.5	74	-20.96	34.12	8.13	29.71	112	59	Peak
5300	102.97	90.14			34.24	8.32	29.73	112	59	Average
5300	110.14	97.31			34.24	8.32	29.73	112	59	Peak
5350.11	44.09	31.17	54	-9.91	34.28	8.38	29.74	112	59	Average
5350.11	57	44.08	74	-17	34.28	8.38	29.74	112	59	Peak
10600	46.59	28.9	54	-7.41	37.28	12.67	32.26	125	119	Average
10600	56.36	38.67	74	-17.64	37.28	12.67	32.26	125	119	Peak

Remarks:

- Emission Level = Read Level + Antenna Factor + Cable Loss - Preamp Factor  
Margin value = Emission level – Limit value
- 5300 MHz: Fundamental Frequency
- The emission levels of other frequencies were very low against the limit

EUT Test Condition		Measurement Detail	
Channel	Channel 64	Frequency Range	1 GHz ~ 40 GHz
Input Power	120 Vac, 60 Hz	Detector Function	Peak (PK) Average (AV)
Environmental Conditions	25 deg. C, 65 % RH	Tested By	Charles Hsiao

Antenna Polarity & Test Distance: Horizontal at 3 m										
Frequency (MHz)	Emission Level (dBuV/m)	Read Level (dBuV)	Limit (dBuV/m)	Margin (dB)	Antenna Factor (dB/m)	Cable Loss (dB)	Preamp Factor (dB)	Antenna Height (cm)	Table Angle (Degree)	Remark
5320	92.23	79.36			34.25	8.35	29.73	100	110	Average
5320	99.24	86.37			34.25	8.35	29.73	100	110	Peak
5351.1	42.51	29.59	54	-11.49	34.28	8.38	29.74	100	110	Average
5351.1	53.73	40.81	74	-20.27	34.28	8.38	29.74	100	110	Peak
10640	46.3	28.54	54	-7.7	37.31	12.71	32.26	155	195	Average
10640	56.92	39.16	74	-17.08	37.31	12.71	32.26	155	195	Peak

Antenna Polarity & Test Distance: Vertical at 3 m										
Frequency (MHz)	Emission Level (dBuV/m)	Read Level (dBuV)	Limit (dBuV/m)	Margin (dB)	Antenna Factor (dB/m)	Cable Loss (dB)	Preamp Factor (dB)	Antenna Height (cm)	Table Angle (Degree)	Remark
5320	103.3	90.43			34.25	8.35	29.73	112	59	Average
5320	110.12	97.25			34.25	8.35	29.73	112	59	Peak
5350.22	49.27	36.35	54	-4.73	34.28	8.38	29.74	115	66	Average
5350.22	68.22	55.3	74	-5.78	34.28	8.38	29.74	115	66	Peak
10640	46.41	28.65	54	-7.59	37.31	12.71	32.26	114	310	Average
10640	57.71	39.95	74	-16.29	37.31	12.71	32.26	114	310	Peak

Remarks:

- Emission Level = Read Level + Antenna Factor + Cable Loss - Preamp Factor  
Margin value = Emission level – Limit value
- 5320 MHz: Fundamental Frequency
- The emission levels of other frequencies were very low against the limit

EUT Test Condition		Measurement Detail	
Channel	Channel 100	Frequency Range	1 GHz ~ 40 GHz
Input Power	120 Vac, 60 Hz	Detector Function	Peak (PK) Average (AV)
Environmental Conditions	25 deg. C, 65 % RH	Tested By	Charles Hsiao

Antenna Polarity & Test Distance: Horizontal at 3 m										
Frequency (MHz)	Emission Level (dBuV/m)	Read Level (dBuV)	Limit (dBuV/m)	Margin (dB)	Antenna Factor (dB/m)	Cable Loss (dB)	Preamp Factor (dB)	Antenna Height (cm)	Table Angle (Degree)	Remark
5459.76	42.79	29.68	54	-11.21	34.36	8.51	29.76	100	74	Average
5459.76	55.13	42.02	74	-18.87	34.36	8.51	29.76	100	74	Peak
*5468.88	59	45.88	68.2	-9.2	34.37	8.51	29.76	100	74	Peak
5500	91	77.79			34.4	8.57	29.76	100	74	Average
5500	98.05	84.84			34.4	8.57	29.76	100	74	Peak
11000	46.89	28.56	54	-7.11	37.6	12.96	32.23	187	77	Average
11000	56.93	38.6	74	-17.07	37.6	12.96	32.23	187	77	Peak
Antenna Polarity & Test Distance: Vertical at 3 m										
Frequency (MHz)	Emission Level (dBuV/m)	Read Level (dBuV)	Limit (dBuV/m)	Margin (dB)	Antenna Factor (dB/m)	Cable Loss (dB)	Preamp Factor (dB)	Antenna Height (cm)	Table Angle (Degree)	Remark
5459.92	46.69	33.58	54	-7.31	34.36	8.51	29.76	106	61	Average
5459.92	63.41	50.3	74	-10.59	34.36	8.51	29.76	106	61	Peak
*5469.36	66.91	53.79	68.2	-1.29	34.37	8.51	29.76	106	61	Peak
5500	102.74	89.53			34.4	8.57	29.76	132	61	Average
5500	109.01	95.8			34.4	8.57	29.76	132	61	Peak
11000	46.93	28.6	54	-7.07	37.6	12.96	32.23	135	285	Average
11000	57.49	39.16	74	-16.51	37.6	12.96	32.23	135	285	Peak

Remarks:

- Emission Level = Read Level + Antenna Factor + Cable Loss - Preamp Factor  
Margin value = Emission level – Limit value
- 5500 MHz: Fundamental Frequency
- \*: Out of Restricted Band
- The emission levels of other frequencies were very low against the limit



EUT Test Condition		Measurement Detail	
Channel	Channel 116	Frequency Range	1 GHz ~ 40 GHz
Input Power	120 Vac, 60 Hz	Detector Function	Peak (PK) Average (AV)
Environmental Conditions	25 deg. C, 65 % RH	Tested By	Charles Hsiao

Antenna Polarity & Test Distance: Horizontal at 3 m										
Frequency (MHz)	Emission Level (dBuV/m)	Read Level (dBuV)	Limit (dBuV/m)	Margin (dB)	Antenna Factor (dB/m)	Cable Loss (dB)	Preamp Factor (dB)	Antenna Height (cm)	Table Angle (Degree)	Remark
5452.4	42.39	29.28	54	-11.61	34.36	8.51	29.76	100	74	Average
5452.4	52.65	39.54	74	-21.35	34.36	8.51	29.76	100	74	Peak
*5469.04	51.82	38.7	68.2	-16.38	34.37	8.51	29.76	100	74	Peak
5580	91.75	78.49			34.47	8.6	29.81	100	74	Average
5580	99.01	85.75			34.47	8.6	29.81	100	74	Peak
*5725.8	52.09	38.68	68.2	-16.11	34.62	8.65	29.86	100	74	Peak
11160	47.24	28.89	54	-6.76	37.7	12.83	32.18	199	179	Average
11160	58.21	39.86	74	-15.79	37.7	12.83	32.18	199	179	Peak

Antenna Polarity & Test Distance: Vertical at 3 m										
Frequency (MHz)	Emission Level (dBuV/m)	Read Level (dBuV)	Limit (dBuV/m)	Margin (dB)	Antenna Factor (dB/m)	Cable Loss (dB)	Preamp Factor (dB)	Antenna Height (cm)	Table Angle (Degree)	Remark
5452.08	43.99	30.88	54	-10.01	34.36	8.51	29.76	132	61	Average
5452.08	53.19	40.08	74	-20.81	34.36	8.51	29.76	132	61	Peak
*5470.96	52.25	39.1	68.2	-15.95	34.37	8.54	29.76	132	61	Peak
5580	104.18	90.92			34.47	8.6	29.81	132	61	Average
5580	111.26	98			34.47	8.6	29.81	132	61	Peak
*5726.04	52.84	39.43	68.2	-15.36	34.62	8.65	29.86	132	61	Peak
11160	47.01	28.66	54	-6.99	37.7	12.83	32.18	125	347	Average
11160	58.19	39.84	74	-15.81	37.7	12.83	32.18	125	347	Peak

Remarks:

- Emission Level = Read Level + Antenna Factor + Cable Loss - Preamp Factor  
Margin value = Emission level – Limit value
- 5580 MHz: Fundamental Frequency
- \*: Out of Restricted Band
- The emission levels of other frequencies were very low against the limit

EUT Test Condition		Measurement Detail	
Channel	Channel 140	Frequency Range	1 GHz ~ 40 GHz
Input Power	120 Vac, 60 Hz	Detector Function	Peak (PK) Average (AV)
Environmental Conditions	25 deg. C, 65 % RH	Tested By	Charles Hsiao

Antenna Polarity & Test Distance: Horizontal at 3 m										
Frequency (MHz)	Emission Level (dBuV/m)	Read Level (dBuV)	Limit (dBuV/m)	Margin (dB)	Antenna Factor (dB/m)	Cable Loss (dB)	Preamp Factor (dB)	Antenna Height (cm)	Table Angle (Degree)	Remark
5700	89.85	76.47			34.59	8.64	29.85	100	74	Average
5700	96.27	82.89			34.59	8.64	29.85	100	74	Peak
*5725.64	58.26	44.85	68.2	-9.94	34.62	8.65	29.86	100	74	Peak
11400	47.08	28.66	54	-6.92	37.84	12.67	32.09	173	3	Average
11400	57.77	39.35	74	-16.23	37.84	12.67	32.09	173	3	Peak

Antenna Polarity & Test Distance: Vertical at 3 m										
Frequency (MHz)	Emission Level (dBuV/m)	Read Level (dBuV)	Limit (dBuV/m)	Margin (dB)	Antenna Factor (dB/m)	Cable Loss (dB)	Preamp Factor (dB)	Antenna Height (cm)	Table Angle (Degree)	Remark
5700	101.25	87.87			34.59	8.64	29.85	132	61	Average
5700	108.16	94.78			34.59	8.64	29.85	132	61	Peak
*5724.92	67.01	53.6	68.2	-1.19	34.62	8.65	29.86	132	61	Peak
11400	46.89	28.47	54	-7.11	37.84	12.67	32.09	126	320	Average
11400	57.34	38.92	74	-16.66	37.84	12.67	32.09	126	320	Peak

Remarks:

- Emission Level = Read Level + Antenna Factor + Cable Loss - Preamp Factor  
Margin value = Emission level – Limit value
- 5700 MHz: Fundamental Frequency
- \*: Out of Restricted Band
- The emission levels of other frequencies were very low against the limit

EUT Test Condition		Measurement Detail	
Channel	Channel 144	Frequency Range	1 GHz ~ 40 GHz
Input Power	120 Vac, 60 Hz	Detector Function	Peak (PK) Average (AV)
Environmental Conditions	25 deg. C, 65 % RH	Tested By	Charles Hsiao

Antenna Polarity & Test Distance: Horizontal at 3 m										
Frequency (MHz)	Emission Level (dBuV/m)	Read Level (dBuV)	Limit (dBuV/m)	Margin (dB)	Antenna Factor (dB/m)	Cable Loss (dB)	Preamp Factor (dB)	Antenna Height (cm)	Table Angle (Degree)	Remark
5457.68	42.51	29.4	54	-11.49	34.36	8.51	29.76	100	74	Average
5457.68	53.42	40.31	74	-20.58	34.36	8.51	29.76	100	74	Peak
5469.04	53.28	40.16	74	-20.72	34.37	8.51	29.76	100	74	Peak
5720	93.66	80.25			34.62	8.65	29.86	100	74	Average
5720	100.49	87.08			34.62	8.65	29.86	100	74	Peak
11440	47.08	28.66	54	-6.92	37.86	12.65	32.09	174	2	Average
11440	58.17	39.75	74	-15.83	37.86	12.65	32.09	174	2	Peak

Antenna Polarity & Test Distance: Vertical at 3 m										
Frequency (MHz)	Emission Level (dBuV/m)	Read Level (dBuV)	Limit (dBuV/m)	Margin (dB)	Antenna Factor (dB/m)	Cable Loss (dB)	Preamp Factor (dB)	Antenna Height (cm)	Table Angle (Degree)	Remark
5452.56	42.51	29.4	54	-11.49	34.36	8.51	29.76	132	61	Average
5452.56	53.13	40.02	74	-20.87	34.36	8.51	29.76	132	61	Peak
5469.36	51.66	38.54	74	-22.34	34.37	8.51	29.76	132	61	Peak
5720	105.58	92.17			34.62	8.65	29.86	132	61	Average
5720	112	98.59			34.62	8.65	29.86	132	61	Peak
11440	47	28.58	54	-7	37.86	12.65	32.09	105	116	Average
11440	56.55	38.13	74	-17.45	37.86	12.65	32.09	105	116	Peak

Remarks:

- Emission Level = Read Level + Antenna Factor + Cable Loss - Preamp Factor  
Margin value = Emission level – Limit value
- 5720 MHz: Fundamental Frequency
- The emission levels of other frequencies were very low against the limit

EUT Test Condition		Measurement Detail	
Channel	Channel 149	Frequency Range	1 GHz ~ 40 GHz
Input Power	120 Vac, 60 Hz	Detector Function	Peak (PK) Average (AV)
Environmental Conditions	25 deg. C, 65 % RH	Tested By	Charles Hsiao

<Spurious Emission>

Antenna Polarity & Test Distance: Horizontal at 3 m										
Frequency (MHz)	Emission Level (dBuV/m)	Read Level (dBuV)	Limit (dBuV/m)	Margin (dB)	Antenna Factor (dB/m)	Cable Loss (dB)	Preamp Factor (dB)	Antenna Height (cm)	Table Angle (Degree)	Remark
5745	93.66	80.24			34.64	8.66	29.88	227	119	Average
5745	100.58	87.16			34.64	8.66	29.88	227	119	Peak
11490	47.14	28.7	54	-6.86	37.89	12.62	32.07	157	90	Average
11490	57.9	39.46	74	-16.1	37.89	12.62	32.07	157	90	Peak
Antenna Polarity & Test Distance: Vertical at 3 m										
Frequency (MHz)	Emission Level (dBuV/m)	Read Level (dBuV)	Limit (dBuV/m)	Margin (dB)	Antenna Factor (dB/m)	Cable Loss (dB)	Preamp Factor (dB)	Antenna Height (cm)	Table Angle (Degree)	Remark
5745	102.58	89.16			34.64	8.66	29.88	126	62	Average
5745	109.95	96.53			34.64	8.66	29.88	126	62	Peak
11490	47.31	28.87	54	-6.69	37.89	12.62	32.07	118	326	Average
11490	58.54	40.1	74	-15.46	37.89	12.62	32.07	118	326	Peak

<Out of Band Emission (OOBE)>

Antenna Polarity & Test Distance: Horizontal at 3 m										
Frequency (MHz)	Emission Level (dBuV/m)	Read Level (dBuV)	Limit (dBuV/m)	Margin (dB)	Antenna Factor (dB/m)	Cable Loss (dB)	Preamp Factor (dB)	Antenna Height (cm)	Table Angle (Degree)	Remark
*5540.95	53.62	40.39	68.2	-14.58	34.43	8.58	29.78	227	119	Peak
5653.3	50.73	37.37	70.64	-19.91	34.56	8.63	29.83	227	119	Peak
5920	50.99	37.41	71.9	-20.91	34.81	8.73	29.96	227	119	Peak
*5963.05	53.03	39.4	68.2	-15.17	34.87	8.74	29.98	227	119	Peak
Antenna Polarity & Test Distance: Vertical at 3 m										
Frequency (MHz)	Emission Level (dBuV/m)	Read Level (dBuV)	Limit (dBuV/m)	Margin (dB)	Antenna Factor (dB/m)	Cable Loss (dB)	Preamp Factor (dB)	Antenna Height (cm)	Table Angle (Degree)	Remark
*5643.325	53.16	39.83	68.2	-15.04	34.54	8.62	29.83	126	62	Peak
5656.45	51.99	38.64	72.97	-20.98	34.56	8.63	29.84	126	62	Peak
5922.625	52.67	39.07	69.96	-17.29	34.83	8.73	29.96	126	62	Peak
*5967.775	53.35	39.71	68.2	-14.85	34.87	8.75	29.98	126	62	Peak

Remarks:

- Emission Level = Read Level + Antenna Factor + Cable Loss - Preamp Factor  
Margin value = Emission level – Limit value
- 5745 MHz: Fundamental Frequency
- \*: Out of Restricted Band
- The emission levels of other frequencies were very low against the limit

EUT Test Condition		Measurement Detail	
Channel	Channel 157	Frequency Range	1 GHz ~ 40 GHz
Input Power	120 Vac, 60 Hz	Detector Function	Peak (PK) Average (AV)
Environmental Conditions	25 deg. C, 65 % RH	Tested By	Charles Hsiao

<Spurious Emission>

Antenna Polarity & Test Distance: Horizontal at 3 m										
Frequency (MHz)	Emission Level (dBuV/m)	Read Level (dBuV)	Limit (dBuV/m)	Margin (dB)	Antenna Factor (dB/m)	Cable Loss (dB)	Preamp Factor (dB)	Antenna Height (cm)	Table Angle (Degree)	Remark
5785	93.55	80.09			34.68	8.68	29.9	227	119	Average
5785	100.47	87.01			34.68	8.68	29.9	227	119	Peak
11570	46.96	28.33	54	-7.04	38	12.68	32.05	124	13	Average
11570	58.2	39.57	74	-15.8	38	12.68	32.05	124	13	Peak
Antenna Polarity & Test Distance: Vertical at 3 m										
Frequency (MHz)	Emission Level (dBuV/m)	Read Level (dBuV)	Limit (dBuV/m)	Margin (dB)	Antenna Factor (dB/m)	Cable Loss (dB)	Preamp Factor (dB)	Antenna Height (cm)	Table Angle (Degree)	Remark
5785	102.22	88.76			34.68	8.68	29.9	126	62	Average
5785	109.6	96.14			34.68	8.68	29.9	126	62	Peak
11570	47.2	28.57	54	-6.8	38	12.68	32.05	140	111	Average
11570	58.66	40.03	74	-15.34	38	12.68	32.05	140	111	Peak

<Out of Band Emission (OOBE)>

Antenna Polarity & Test Distance: Horizontal at 3 m										
Frequency (MHz)	Emission Level (dBuV/m)	Read Level (dBuV)	Limit (dBuV/m)	Margin (dB)	Antenna Factor (dB/m)	Cable Loss (dB)	Preamp Factor (dB)	Antenna Height (cm)	Table Angle (Degree)	Remark
*5560.9	52.8	39.55	68.2	-15.4	34.45	8.59	29.79	227	119	Peak
5654.35	51.79	38.44	71.42	-19.63	34.56	8.63	29.84	227	119	Peak
5923.15	51.96	38.36	69.57	-17.61	34.83	8.73	29.96	227	119	Peak
*6024.475	53.55	39.86	68.2	-14.65	34.93	8.77	30.01	227	119	Peak
Antenna Polarity & Test Distance: Vertical at 3 m										
Frequency (MHz)	Emission Level (dBuV/m)	Read Level (dBuV)	Limit (dBuV/m)	Margin (dB)	Antenna Factor (dB/m)	Cable Loss (dB)	Preamp Factor (dB)	Antenna Height (cm)	Table Angle (Degree)	Remark
*5516.275	53.48	40.26	68.2	-14.72	34.42	8.57	29.77	126	62	Peak
5653.825	52.25	38.9	71.03	-18.78	34.56	8.63	29.84	126	62	Peak
5918.95	51.65	38.07	72.68	-21.03	34.81	8.73	29.96	126	62	Peak
*5958.325	52.32	38.68	68.2	-15.88	34.87	8.74	29.97	126	62	Peak

Remarks:

- Emission Level = Read Level + Antenna Factor + Cable Loss - Preamp Factor  
Margin value = Emission level – Limit value
- 5785 MHz: Fundamental Frequency
- \*: Out of Restricted Band
- The emission levels of other frequencies were very low against the limit

EUT Test Condition		Measurement Detail	
Channel	Channel 165	Frequency Range	1 GHz ~ 40 GHz
Input Power	120 Vac, 60 Hz	Detector Function	Peak (PK) Average (AV)
Environmental Conditions	25 deg. C, 65 % RH	Tested By	Charles Hsiao

### <Spurious Emission>

Antenna Polarity & Test Distance: Horizontal at 3 m										
Frequency (MHz)	Emission Level (dBuV/m)	Read Level (dBuV)	Limit (dBuV/m)	Margin (dB)	Antenna Factor (dB/m)	Cable Loss (dB)	Preamp Factor (dB)	Antenna Height (cm)	Table Angle (Degree)	Remark
5825	93.44	79.93			34.73	8.69	29.91	227	119	Average
5825	100.07	86.56			34.73	8.69	29.91	227	119	Peak
11650	47.32	28.46	54	-6.68	38.09	12.8	32.03	111	32	Average
11650	57.71	38.85	74	-16.29	38.09	12.8	32.03	111	32	Peak
Antenna Polarity & Test Distance: Vertical at 3 m										
Frequency (MHz)	Emission Level (dBuV/m)	Read Level (dBuV)	Limit (dBuV/m)	Margin (dB)	Antenna Factor (dB/m)	Cable Loss (dB)	Preamp Factor (dB)	Antenna Height (cm)	Table Angle (Degree)	Remark
5825	102.33	88.82			34.73	8.69	29.91	126	62	Average
5825	109.35	95.84			34.73	8.69	29.91	126	62	Peak
11650	47.43	28.57	54	-6.57	38.09	12.8	32.03	117	244	Average
11650	57.54	38.68	74	-16.46	38.09	12.8	32.03	117	244	Peak

### <Out of Band Emission (OOBE)>

Antenna Polarity & Test Distance: Horizontal at 3 m										
Frequency (MHz)	Emission Level (dBuV/m)	Read Level (dBuV)	Limit (dBuV/m)	Margin (dB)	Antenna Factor (dB/m)	Cable Loss (dB)	Preamp Factor (dB)	Antenna Height (cm)	Table Angle (Degree)	Remark
*5528.35	53.07	39.85	68.2	-15.13	34.42	8.58	29.78	227	119	Peak
5656.975	53.47	40.12	73.36	-19.89	34.56	8.63	29.84	227	119	Peak
5921.575	52	38.4	70.73	-18.73	34.83	8.73	29.96	227	119	Peak
*5965.675	52.95	39.31	68.2	-15.25	34.87	8.75	29.98	227	119	Peak
Antenna Polarity & Test Distance: Vertical at 3 m										
Frequency (MHz)	Emission Level (dBuV/m)	Read Level (dBuV)	Limit (dBuV/m)	Margin (dB)	Antenna Factor (dB/m)	Cable Loss (dB)	Preamp Factor (dB)	Antenna Height (cm)	Table Angle (Degree)	Remark
*5558.275	53.56	40.31	68.2	-14.64	34.45	8.59	29.79	126	62	Peak
5655.4	51.14	37.79	72.2	-21.06	34.56	8.63	29.84	126	62	Peak
5921.05	51.24	37.66	71.12	-19.88	34.81	8.73	29.96	126	62	Peak
*5947.825	52.94	39.32	68.2	-15.26	34.85	8.74	29.97	126	62	Peak

#### Remarks:

- Emission Level = Read Level + Antenna Factor + Cable Loss - Preamp Factor  
Margin value = Emission level – Limit value
- 5825 MHz: Fundamental Frequency
- \*: Out of Restricted Band
- The emission levels of other frequencies were very low against the limit

802.11n (HT40)

EUT Test Condition		Measurement Detail	
Channel	Channel 38	Frequency Range	1 GHz ~ 40 GHz
Input Power	120 Vac, 60 Hz	Detector Function	Peak (PK) Average (AV)
Environmental Conditions	25 deg. C, 65 % RH	Tested By	Charles Hsiao

**Antenna Polarity & Test Distance: Horizontal at 3 m**

Frequency (MHz)	Emission Level (dBuV/m)	Read Level (dBuV)	Limit (dBuV/m)	Margin (dB)	Antenna Factor (dB/m)	Cable Loss (dB)	Preamp Factor (dB)	Antenna Height (cm)	Table Angle (Degree)	Remark
5149.4	43.41	30.87	54	-10.59	34.12	8.13	29.71	101	113	Average
5149.4	56.4	43.86	74	-17.6	34.12	8.13	29.71	101	113	Peak
5190	85.89	73.27			34.15	8.19	29.72	101	110	Average
5190	93.11	80.49			34.15	8.19	29.72	101	110	Peak
5374.75	42.57	29.62	54	-11.43	34.29	8.41	29.75	101	110	Average
5374.75	53.08	40.13	74	-20.92	34.29	8.41	29.75	101	110	Peak
*10380	55.63	38.31	68.2	-12.57	37.13	12.36	32.17	113	32	Peak

**Antenna Polarity & Test Distance: Vertical at 3 m**

Frequency (MHz)	Emission Level (dBuV/m)	Read Level (dBuV)	Limit (dBuV/m)	Margin (dB)	Antenna Factor (dB/m)	Cable Loss (dB)	Preamp Factor (dB)	Antenna Height (cm)	Table Angle (Degree)	Remark
5149.85	52.34	39.8	54	-1.66	34.12	8.13	29.71	102	69	Average
5149.85	69.94	57.4	74	-4.06	34.12	8.13	29.71	102	69	Peak
5190	98.67	86.05			34.15	8.19	29.72	106	68	Average
5190	105.64	93.02			34.15	8.19	29.72	106	68	Peak
5391.36	42.34	29.37	54	-11.66	34.31	8.41	29.75	106	68	Average
5391.36	54.34	41.37	74	-19.66	34.31	8.41	29.75	106	68	Peak
*10380	55.94	38.62	68.2	-12.26	37.13	12.36	32.17	154	285	Peak

Remarks:

- Emission Level = Read Level + Antenna Factor + Cable Loss - Preamp Factor  
Margin value = Emission level – Limit value
- 5190 MHz: Fundamental Frequency
- \*: Out of Restricted Band
- The emission levels of other frequencies were very low against the limit

EUT Test Condition		Measurement Detail	
Channel	Channel 46	Frequency Range	1 GHz ~ 40 GHz
Input Power	120 Vac, 60 Hz	Detector Function	Peak (PK) Average (AV)
Environmental Conditions	25 deg. C, 65 % RH	Tested By	Charles Hsiao

Antenna Polarity & Test Distance: Horizontal at 3 m										
Frequency (MHz)	Emission Level (dBuV/m)	Read Level (dBuV)	Limit (dBuV/m)	Margin (dB)	Antenna Factor (dB/m)	Cable Loss (dB)	Preamp Factor (dB)	Antenna Height (cm)	Table Angle (Degree)	Remark
5148.5	42.16	29.62	54	-11.84	34.12	8.13	29.71	101	110	Average
5148.5	53.82	41.28	74	-20.18	34.12	8.13	29.71	101	110	Peak
5230	86.49	73.8			34.19	8.22	29.72	101	110	Average
5230	93.27	80.58			34.19	8.22	29.72	101	110	Peak
5359.24	42.54	29.62	54	-11.46	34.28	8.38	29.74	101	110	Average
5359.24	53.52	40.6	74	-20.48	34.28	8.38	29.74	101	110	Peak
*10460	55.09	37.62	68.2	-13.11	37.17	12.53	32.23	118	255	Peak
Antenna Polarity & Test Distance: Vertical at 3 m										
Frequency (MHz)	Emission Level (dBuV/m)	Read Level (dBuV)	Limit (dBuV/m)	Margin (dB)	Antenna Factor (dB/m)	Cable Loss (dB)	Preamp Factor (dB)	Antenna Height (cm)	Table Angle (Degree)	Remark
5149.55	43.15	30.61	54	-10.85	34.12	8.13	29.71	106	68	Average
5149.55	59.59	47.05	74	-14.41	34.12	8.13	29.71	106	68	Peak
5230	99.15	86.46			34.19	8.22	29.72	106	68	Average
5230	106.47	93.78			34.19	8.22	29.72	106	68	Peak
5363.53	42.48	29.55	54	-11.52	34.29	8.38	29.74	106	68	Average
5363.53	54.69	41.76	74	-19.31	34.29	8.38	29.74	106	68	Peak
*10460	57.23	39.76	68.2	-10.97	37.17	12.53	32.23	118	326	Peak

Remarks:

- Emission Level = Read Level + Antenna Factor + Cable Loss - Preamp Factor  
Margin value = Emission level – Limit value
- 5230 MHz: Fundamental Frequency
- \*: Out of Restricted Band
- The emission levels of other frequencies were very low against the limit



EUT Test Condition		Measurement Detail	
Channel	Channel 54	Frequency Range	1 GHz ~ 40 GHz
Input Power	120 Vac, 60 Hz	Detector Function	Peak (PK) Average (AV)
Environmental Conditions	25 deg. C, 65 % RH	Tested By	Charles Hsiao

Antenna Polarity & Test Distance: Horizontal at 3 m										
Frequency (MHz)	Emission Level (dBuV/m)	Read Level (dBuV)	Limit (dBuV/m)	Margin (dB)	Antenna Factor (dB/m)	Cable Loss (dB)	Preamp Factor (dB)	Antenna Height (cm)	Table Angle (Degree)	Remark
5110.85	42.12	29.63	54	-11.88	34.09	8.1	29.7	100	110	Average
5110.85	52.84	40.35	74	-21.16	34.09	8.1	29.7	100	110	Peak
5270	87.96	75.19			34.21	8.29	29.73	100	110	Average
5270	94.82	82.05			34.21	8.29	29.73	100	110	Peak
5424.36	42.38	29.32	54	-11.62	34.33	8.48	29.75	100	110	Average
5424.36	52.69	39.63	74	-21.31	34.33	8.48	29.75	100	110	Peak
*10540	56.14	38.55	68.2	-12.06	37.23	12.63	32.27	105	204	Peak

Antenna Polarity & Test Distance: Vertical at 3 m										
Frequency (MHz)	Emission Level (dBuV/m)	Read Level (dBuV)	Limit (dBuV/m)	Margin (dB)	Antenna Factor (dB/m)	Cable Loss (dB)	Preamp Factor (dB)	Antenna Height (cm)	Table Angle (Degree)	Remark
5126	42.39	29.89	54	-11.61	34.11	8.1	29.71	112	59	Average
5126	54.34	41.84	74	-19.66	34.11	8.1	29.71	112	59	Peak
5270	99.98	87.21			34.21	8.29	29.73	112	59	Average
5270	106.65	93.88			34.21	8.29	29.73	112	59	Peak
5351.21	43	30.08	54	-11	34.28	8.38	29.74	112	59	Average
5351.21	58.73	45.81	74	-15.27	34.28	8.38	29.74	112	59	Peak
*10540	55.72	38.13	68.2	-12.48	37.23	12.63	32.27	159	228	Peak

Remarks:

- Emission Level = Read Level + Antenna Factor + Cable Loss - Preamp Factor  
Margin value = Emission level – Limit value
- 5270 MHz: Fundamental Frequency
- \*: Out of Restricted Band
- The emission levels of other frequencies were very low against the limit

EUT Test Condition		Measurement Detail	
Channel	Channel 62	Frequency Range	1 GHz ~ 40 GHz
Input Power	120 Vac, 60 Hz	Detector Function	Peak (PK) Average (AV)
Environmental Conditions	25 deg. C, 65 % RH	Tested By	Charles Hsiao

Antenna Polarity & Test Distance: Horizontal at 3 m										
Frequency (MHz)	Emission Level (dBuV/m)	Read Level (dBuV)	Limit (dBuV/m)	Margin (dB)	Antenna Factor (dB/m)	Cable Loss (dB)	Preamp Factor (dB)	Antenna Height (cm)	Table Angle (Degree)	Remark
5096.45	42.1	29.65	54	-11.9	34.08	8.07	29.7	100	110	Average
5096.45	53.29	40.84	74	-20.71	34.08	8.07	29.7	100	110	Peak
5310	87.09	74.25			34.25	8.32	29.73	100	110	Average
5310	94.24	81.4			34.25	8.32	29.73	100	110	Peak
5355.06	42.45	29.53	54	-11.55	34.28	8.38	29.74	100	110	Average
5355.06	54.87	41.95	74	-19.13	34.28	8.38	29.74	100	110	Peak
10620	46.38	28.65	54	-7.62	37.3	12.69	32.26	135	255	Average
10620	55.85	38.12	74	-18.15	37.3	12.69	32.26	135	255	Peak

Antenna Polarity & Test Distance: Vertical at 3 m										
Frequency (MHz)	Emission Level (dBuV/m)	Read Level (dBuV)	Limit (dBuV/m)	Margin (dB)	Antenna Factor (dB/m)	Cable Loss (dB)	Preamp Factor (dB)	Antenna Height (cm)	Table Angle (Degree)	Remark
5113.25	42.34	29.85	54	-11.66	34.09	8.1	29.7	112	59	Average
5113.25	54.68	42.19	74	-19.32	34.09	8.1	29.7	112	59	Peak
5310	99.12	86.28			34.25	8.32	29.73	112	59	Average
5310	106.19	93.35			34.25	8.32	29.73	112	59	Peak
5350.11	50.52	37.6	54	-3.48	34.28	8.38	29.74	112	52	Average
5350.11	70.17	57.25	74	-3.83	34.28	8.38	29.74	112	52	Peak
10620	46.6	28.87	54	-7.4	37.3	12.69	32.26	158	47	Average
10620	56.83	39.1	74	-17.17	37.3	12.69	32.26	158	47	Peak

Remarks:

- Emission Level = Read Level + Antenna Factor + Cable Loss - Preamp Factor  
Margin value = Emission level – Limit value
- 5310 MHz: Fundamental Frequency
- The emission levels of other frequencies were very low against the limit

EUT Test Condition		Measurement Detail	
Channel	Channel 102	Frequency Range	1 GHz ~ 40 GHz
Input Power	120 Vac, 60 Hz	Detector Function	Peak (PK) Average (AV)
Environmental Conditions	25 deg. C, 65 % RH	Tested By	Charles Hsiao

Antenna Polarity & Test Distance: Horizontal at 3 m										
Frequency (MHz)	Emission Level (dBuV/m)	Read Level (dBuV)	Limit (dBuV/m)	Margin (dB)	Antenna Factor (dB/m)	Cable Loss (dB)	Preamp Factor (dB)	Antenna Height (cm)	Table Angle (Degree)	Remark
5456.4	42.81	29.7	54	-11.19	34.36	8.51	29.76	101	71	Average
5456.4	55.65	42.54	74	-18.35	34.36	8.51	29.76	101	71	Peak
*5470.64	57.71	44.59	68.2	-10.49	34.37	8.51	29.76	101	71	Peak
5510	85.85	72.65			34.4	8.57	29.77	100	74	Average
5510	92.75	79.55			34.4	8.57	29.77	100	74	Peak
*5724.2	52.61	39.2	68.2	-15.59	34.62	8.65	29.86	100	74	Peak
11020	47.23	28.9	54	-6.77	37.61	12.94	32.22	121	1	Average
11020	56.73	38.4	74	-17.27	37.61	12.94	32.22	121	1	Peak

Antenna Polarity & Test Distance: Vertical at 3 m										
Frequency (MHz)	Emission Level (dBuV/m)	Read Level (dBuV)	Limit (dBuV/m)	Margin (dB)	Antenna Factor (dB/m)	Cable Loss (dB)	Preamp Factor (dB)	Antenna Height (cm)	Table Angle (Degree)	Remark
5459.28	47.33	34.22	54	-6.67	34.36	8.51	29.76	108	56	Average
5459.28	62.59	49.48	74	-11.41	34.36	8.51	29.76	108	56	Peak
*5470.32	66.52	53.4	68.2	-1.68	34.37	8.51	29.76	108	56	Peak
5510	97.39	84.19			34.4	8.57	29.77	108	61	Average
5510	104.01	90.81			34.4	8.57	29.77	108	61	Peak
*5725.08	51.72	38.31	68.2	-16.48	34.62	8.65	29.86	108	61	Peak
11020	47.55	29.22	54	-6.45	37.61	12.94	32.22	127	255	Average
11020	57.45	39.12	74	-16.55	37.61	12.94	32.22	127	255	Peak

Remarks:

- Emission Level = Read Level + Antenna Factor + Cable Loss - Preamp Factor  
Margin value = Emission level – Limit value
- 5510 MHz: Fundamental Frequency
- \*: Out of Restricted Band
- The emission levels of other frequencies were very low against the limit

EUT Test Condition		Measurement Detail	
Channel	Channel 110	Frequency Range	1 GHz ~ 40 GHz
Input Power	120 Vac, 60 Hz	Detector Function	Peak (PK) Average (AV)
Environmental Conditions	25 deg. C, 65 % RH	Tested By	Charles Hsiao

Antenna Polarity & Test Distance: Horizontal at 3 m										
Frequency (MHz)	Emission Level (dBuV/m)	Read Level (dBuV)	Limit (dBuV/m)	Margin (dB)	Antenna Factor (dB/m)	Cable Loss (dB)	Preamp Factor (dB)	Antenna Height (cm)	Table Angle (Degree)	Remark
5459.28	42.41	29.3	54	-11.59	34.36	8.51	29.76	100	74	Average
5459.28	52.84	39.73	74	-21.16	34.36	8.51	29.76	100	74	Peak
*5469.2	52.64	39.52	68.2	-15.56	34.37	8.51	29.76	100	74	Peak
5550	89	75.74			34.45	8.59	29.78	100	74	Average
5550	96.06	82.8			34.45	8.59	29.78	100	74	Peak
*5725.88	51.4	37.99	68.2	-16.8	34.62	8.65	29.86	100	74	Peak
11100	47.22	28.87	54	-6.78	37.66	12.89	32.2	124	111	Average
11100	56.7	38.35	74	-17.3	37.66	12.89	32.2	124	111	Peak
Antenna Polarity & Test Distance: Vertical at 3 m										
Frequency (MHz)	Emission Level (dBuV/m)	Read Level (dBuV)	Limit (dBuV/m)	Margin (dB)	Antenna Factor (dB/m)	Cable Loss (dB)	Preamp Factor (dB)	Antenna Height (cm)	Table Angle (Degree)	Remark
5454	44.33	31.22	54	-9.67	34.36	8.51	29.76	136	55	Average
5454	60.48	47.37	74	-13.52	34.36	8.51	29.76	136	55	Peak
*5470.8	59.64	46.49	68.2	-8.56	34.37	8.54	29.76	136	55	Peak
5550	100.05	86.79			34.45	8.59	29.78	132	61	Average
5550	107.43	94.17			34.45	8.59	29.78	132	61	Peak
*5724.84	52.44	39.03	68.2	-15.76	34.62	8.65	29.86	132	61	Peak
11100	47.38	29.03	54	-6.62	37.66	12.89	32.2	135	299	Average
11100	56.49	38.14	74	-17.51	37.66	12.89	32.2	135	299	Peak

Remarks:

- Emission Level = Read Level + Antenna Factor + Cable Loss - Preamp Factor  
Margin value = Emission level – Limit value
- 5550 MHz: Fundamental Frequency
- \*: Out of Restricted Band
- The emission levels of other frequencies were very low against the limit

EUT Test Condition		Measurement Detail	
Channel	Channel 134	Frequency Range	1 GHz ~ 40 GHz
Input Power	120 Vac, 60 Hz	Detector Function	Peak (PK) Average (AV)
Environmental Conditions	25 deg. C, 65 % RH	Tested By	Charles Hsiao

Antenna Polarity & Test Distance: Horizontal at 3 m										
Frequency (MHz)	Emission Level (dBuV/m)	Read Level (dBuV)	Limit (dBuV/m)	Margin (dB)	Antenna Factor (dB/m)	Cable Loss (dB)	Preamp Factor (dB)	Antenna Height (cm)	Table Angle (Degree)	Remark
5450.64	42.75	29.64	54	-11.25	34.36	8.51	29.76	100	74	Average
5450.64	52.5	39.39	74	-21.5	34.36	8.51	29.76	100	74	Peak
*5470.8	51.32	38.17	68.2	-16.88	34.37	8.54	29.76	100	74	Peak
5670	89.57	76.21			34.57	8.63	29.84	100	74	Average
5670	96.56	83.2			34.57	8.63	29.84	100	74	Peak
*5724.36	53.35	39.94	68.2	-14.85	34.62	8.65	29.86	100	74	Peak
11340	46.99	28.6	54	-7.01	37.8	12.71	32.12	126	229	Average
11340	57.93	39.54	74	-16.07	37.8	12.71	32.12	126	229	Peak

Antenna Polarity & Test Distance: Vertical at 3 m										
Frequency (MHz)	Emission Level (dBuV/m)	Read Level (dBuV)	Limit (dBuV/m)	Margin (dB)	Antenna Factor (dB/m)	Cable Loss (dB)	Preamp Factor (dB)	Antenna Height (cm)	Table Angle (Degree)	Remark
5436.08	43.14	30.06	54	-10.86	34.35	8.48	29.75	132	61	Average
5436.08	59.14	46.06	74	-14.86	34.35	8.48	29.75	132	61	Peak
*5470.48	51.68	38.56	68.2	-16.52	34.37	8.51	29.76	132	61	Peak
5670	101.24	87.88			34.57	8.63	29.84	132	61	Average
5670	108.39	95.03			34.57	8.63	29.84	132	61	Peak
*5724.76	65.5	52.09	68.2	-2.7	34.62	8.65	29.86	132	61	Peak
11340	46.94	28.55	54	-7.06	37.8	12.71	32.12	119	255	Average
11340	57.93	39.54	74	-16.07	37.8	12.71	32.12	119	255	Peak

Remarks:

- Emission Level = Read Level + Antenna Factor + Cable Loss - Preamp Factor  
Margin value = Emission level – Limit value
- 5670 MHz: Fundamental Frequency
- \*: Out of Restricted Band
- The emission levels of other frequencies were very low against the limit

EUT Test Condition		Measurement Detail	
Channel	Channel 142	Frequency Range	1 GHz ~ 40 GHz
Input Power	120 Vac, 60 Hz	Detector Function	Peak (PK) Average (AV)
Environmental Conditions	25 deg. C, 65 % RH	Tested By	Charles Hsiao

Antenna Polarity & Test Distance: Horizontal at 3 m										
Frequency (MHz)	Emission Level (dBuV/m)	Read Level (dBuV)	Limit (dBuV/m)	Margin (dB)	Antenna Factor (dB/m)	Cable Loss (dB)	Preamp Factor (dB)	Antenna Height (cm)	Table Angle (Degree)	Remark
5438.64	42.46	29.38	54	-11.54	34.35	8.48	29.75	100	74	Average
5438.64	53.15	40.07	74	-20.85	34.35	8.48	29.75	100	74	Peak
5470	51.82	38.7	74	-22.18	34.37	8.51	29.76	100	74	Peak
5710	88.57	75.17			34.61	8.65	29.86	100	74	Average
5710	95.15	81.75			34.61	8.65	29.86	100	74	Peak
11420	46.99	28.58	54	-7.01	37.85	12.65	32.09	104	326	Average
11420	57.83	39.42	74	-16.17	37.85	12.65	32.09	104	326	Peak

Antenna Polarity & Test Distance: Vertical at 3 m										
Frequency (MHz)	Emission Level (dBuV/m)	Read Level (dBuV)	Limit (dBuV/m)	Margin (dB)	Antenna Factor (dB/m)	Cable Loss (dB)	Preamp Factor (dB)	Antenna Height (cm)	Table Angle (Degree)	Remark
5446.48	42.72	29.6	54	-11.28	34.36	8.51	29.75	132	61	Average
5446.48	57.61	44.49	74	-16.39	34.36	8.51	29.75	132	61	Peak
5469.36	56.12	43	74	-17.88	34.37	8.51	29.76	132	61	Peak
5710	100.55	87.15			34.61	8.65	29.86	132	61	Average
5710	107.85	94.45			34.61	8.65	29.86	132	61	Peak
11420	47.01	28.6	54	-6.99	37.85	12.65	32.09	118	205	Average
11420	58.34	39.93	74	-15.66	37.85	12.65	32.09	118	205	Peak

Remarks:

- Emission Level = Read Level + Antenna Factor + Cable Loss - Preamp Factor  
Margin value = Emission level – Limit value
- 5710 MHz: Fundamental Frequency
- The emission levels of other frequencies were very low against the limit

EUT Test Condition		Measurement Detail	
Channel	Channel 151	Frequency Range	1 GHz ~ 40 GHz
Input Power	120 Vac, 60 Hz	Detector Function	Peak (PK) Average (AV)
Environmental Conditions	25 deg. C, 65 % RH	Tested By	Charles Hsiao

<Spurious Emission>

Antenna Polarity & Test Distance: Horizontal at 3 m										
Frequency (MHz)	Emission Level (dBuV/m)	Read Level (dBuV)	Limit (dBuV/m)	Margin (dB)	Antenna Factor (dB/m)	Cable Loss (dB)	Preamp Factor (dB)	Antenna Height (cm)	Table Angle (Degree)	Remark
5755	88.55	75.11			34.66	8.66	29.88	227	119	Average
5755	95.03	81.59			34.66	8.66	29.88	227	119	Peak
11510	47.41	28.97	54	-6.59	37.9	12.6	32.06	124	204	Average
11510	57.26	38.82	74	-16.74	37.9	12.6	32.06	124	204	Peak

Antenna Polarity & Test Distance: Vertical at 3 m										
Frequency (MHz)	Emission Level (dBuV/m)	Read Level (dBuV)	Limit (dBuV/m)	Margin (dB)	Antenna Factor (dB/m)	Cable Loss (dB)	Preamp Factor (dB)	Antenna Height (cm)	Table Angle (Degree)	Remark
5755	97.44	84			34.66	8.66	29.88	126	62	Average
5755	104.9	91.46			34.66	8.66	29.88	126	62	Peak
11510	47.13	28.69	54	-6.87	37.9	12.6	32.06	157	228	Average
11510	57.87	39.43	74	-16.13	37.9	12.6	32.06	157	228	Peak

<Out of Band Emission (OOBE)>

Antenna Polarity & Test Distance: Horizontal at 3 m										
Frequency (MHz)	Emission Level (dBuV/m)	Read Level (dBuV)	Limit (dBuV/m)	Margin (dB)	Antenna Factor (dB/m)	Cable Loss (dB)	Preamp Factor (dB)	Antenna Height (cm)	Table Angle (Degree)	Remark
*5611.3	53.25	39.96	68.2	-14.95	34.5	8.61	29.82	227	119	Peak
5655.4	50.67	37.32	72.2	-21.53	34.56	8.63	29.84	227	119	Peak
5921.575	50.63	37.03	70.73	-20.1	34.83	8.73	29.96	227	119	Peak
*5934.7	52.65	39.06	68.2	-15.55	34.83	8.73	29.97	227	119	Peak

Antenna Polarity & Test Distance: Vertical at 3 m										
Frequency (MHz)	Emission Level (dBuV/m)	Read Level (dBuV)	Limit (dBuV/m)	Margin (dB)	Antenna Factor (dB/m)	Cable Loss (dB)	Preamp Factor (dB)	Antenna Height (cm)	Table Angle (Degree)	Remark
*5624.425	61.05	47.74	68.2	-7.15	34.52	8.61	29.82	126	62	Peak
5656.975	57.12	43.77	73.36	-16.24	34.56	8.63	29.84	126	62	Peak
5922.1	51.19	37.59	70.35	-19.16	34.83	8.73	29.96	126	62	Peak
*5933.65	54.77	41.17	68.2	-13.43	34.83	8.73	29.96	126	62	Peak

Remarks:

- Emission Level = Read Level + Antenna Factor + Cable Loss - Preamp Factor  
Margin value = Emission level – Limit value
- 5755 MHz: Fundamental Frequency
- \*: Out of Restricted Band
- The emission levels of other frequencies were very low against the limit

EUT Test Condition		Measurement Detail	
Channel	Channel 159	Frequency Range	1 GHz ~ 40 GHz
Input Power	120 Vac, 60 Hz	Detector Function	Peak (PK) Average (AV)
Environmental Conditions	25 deg. C, 65 % RH	Tested By	Charles Hsiao

<Spurious Emission>

Antenna Polarity & Test Distance: Horizontal at 3 m										
Frequency (MHz)	Emission Level (dBuV/m)	Read Level (dBuV)	Limit (dBuV/m)	Margin (dB)	Antenna Factor (dB/m)	Cable Loss (dB)	Preamp Factor (dB)	Antenna Height (cm)	Table Angle (Degree)	Remark
5795	89.85	76.38			34.69	8.68	29.9	227	119	Average
5795	96.52	83.05			34.69	8.68	29.9	227	119	Peak
11590	47.69	29	54	-6.31	38.02	12.72	32.05	125	205	Average
11590	57.69	39	74	-16.31	38.02	12.72	32.05	125	205	Peak
Antenna Polarity & Test Distance: Vertical at 3 m										
Frequency (MHz)	Emission Level (dBuV/m)	Read Level (dBuV)	Limit (dBuV/m)	Margin (dB)	Antenna Factor (dB/m)	Cable Loss (dB)	Preamp Factor (dB)	Antenna Height (cm)	Table Angle (Degree)	Remark
5795	98.56	85.09			34.69	8.68	29.9	126	62	Average
5795	105.78	92.31			34.69	8.68	29.9	126	62	Peak
11590	47.93	29.24	54	-6.07	38.02	12.72	32.05	138	322	Average
11590	57.49	38.8	74	-16.51	38.02	12.72	32.05	138	322	Peak

<Out of Band Emission (OOBE)>

Antenna Polarity & Test Distance: Horizontal at 3 m										
Frequency (MHz)	Emission Level (dBuV/m)	Read Level (dBuV)	Limit (dBuV/m)	Margin (dB)	Antenna Factor (dB/m)	Cable Loss (dB)	Preamp Factor (dB)	Antenna Height (cm)	Table Angle (Degree)	Remark
*5579.275	53.17	39.91	68.2	-15.03	34.47	8.6	29.81	227	119	Peak
5654.35	51.82	38.47	71.42	-19.6	34.56	8.63	29.84	227	119	Peak
5921.575	50.83	37.23	70.73	-19.9	34.83	8.73	29.96	227	119	Peak
*5985.1	52.42	38.77	68.2	-15.78	34.88	8.75	29.98	227	119	Peak
Antenna Polarity & Test Distance: Vertical at 3 m										
Frequency (MHz)	Emission Level (dBuV/m)	Read Level (dBuV)	Limit (dBuV/m)	Margin (dB)	Antenna Factor (dB/m)	Cable Loss (dB)	Preamp Factor (dB)	Antenna Height (cm)	Table Angle (Degree)	Remark
*5596.6	58.46	45.18	68.2	-9.74	34.49	8.6	29.81	126	62	Peak
5653.3	56.8	43.44	70.64	-13.84	34.56	8.63	29.83	126	62	Peak
5916.325	52.88	39.3	74.62	-21.74	34.81	8.73	29.96	126	62	Peak
*5958.85	53.03	39.39	68.2	-15.17	34.87	8.74	29.97	126	62	Peak

Remarks:

- Emission Level = Read Level + Antenna Factor + Cable Loss - Preamp Factor  
Margin value = Emission level – Limit value
- 5795 MHz: Fundamental Frequency
- \*: Out of Restricted Band
- The emission levels of other frequencies were very low against the limit



802.11ac (VHT80)

EUT Test Condition		Measurement Detail	
Channel	Channel 42	Frequency Range	1 GHz ~ 40 GHz
Input Power	120 Vac, 60 Hz	Detector Function	Peak (PK) Average (AV)
Environmental Conditions	25 deg. C, 65 % RH	Tested By	Charles Hsiao

**Antenna Polarity & Test Distance: Horizontal at 3 m**

Frequency (MHz)	Emission Level (dBuV/m)	Read Level (dBuV)	Limit (dBuV/m)	Margin (dB)	Antenna Factor (dB/m)	Cable Loss (dB)	Preamp Factor (dB)	Antenna Height (cm)	Table Angle (Degree)	Remark
5149.55	52.97	40.43	54	-1.03	34.12	8.13	29.71	104	72	Average
5149.55	62.61	50.07	74	-11.39	34.12	8.13	29.71	104	72	Peak
5210	92.51	79.87			34.17	8.19	29.72	104	68	Average
5210	100.33	87.69			34.17	8.19	29.72	104	68	Peak
5355.83	43.5	30.58	54	-10.5	34.28	8.38	29.74	104	68	Average
5355.83	53.29	40.37	74	-20.71	34.28	8.38	29.74	104	68	Peak
10420	55.41	38.03	74	-18.59	37.15	12.42	32.19	124	199	Peak

**Antenna Polarity & Test Distance: Vertical at 3 m**

Frequency (MHz)	Emission Level (dBuV/m)	Read Level (dBuV)	Limit (dBuV/m)	Margin (dB)	Antenna Factor (dB/m)	Cable Loss (dB)	Preamp Factor (dB)	Antenna Height (cm)	Table Angle (Degree)	Remark
5145.05	44.38	31.84	54	-9.62	34.12	8.13	29.71	100	110	Average
5145.05	54	41.46	74	-20	34.12	8.13	29.71	100	110	Peak
5210	79.74	67.1			34.17	8.19	29.72	100	110	Average
5210	87.03	74.39			34.17	8.19	29.72	100	110	Peak
5426.78	43	29.94	54	-11	34.33	8.48	29.75	100	110	Average
5426.78	53.37	40.31	74	-20.63	34.33	8.48	29.75	100	110	Peak
10420	56.01	38.63	74	-17.99	37.15	12.42	32.19	105	325	Peak

Remarks:

- Emission Level = Read Level + Antenna Factor + Cable Loss - Preamp Factor  
Margin value = Emission level – Limit value
- 5210 MHz: Fundamental Frequency
- The emission levels of other frequencies were very low against the limit

EUT Test Condition		Measurement Detail	
Channel	Channel 58	Frequency Range	1 GHz ~ 40 GHz
Input Power	120 Vac, 60 Hz	Detector Function	Peak (PK) Average (AV)
Environmental Conditions	25 deg. C, 65 % RH	Tested By	Charles Hsiao

Antenna Polarity & Test Distance: Horizontal at 3 m										
Frequency (MHz)	Emission Level (dBuV/m)	Read Level (dBuV)	Limit (dBuV/m)	Margin (dB)	Antenna Factor (dB/m)	Cable Loss (dB)	Preamp Factor (dB)	Antenna Height (cm)	Table Angle (Degree)	Remark
5149.25	43.06	30.52	54	-10.94	34.12	8.13	29.71	100	110	Average
5149.25	53.49	40.95	74	-20.51	34.12	8.13	29.71	100	110	Peak
5290	82.35	69.53			34.23	8.32	29.73	100	110	Average
5290	89.95	77.13			34.23	8.32	29.73	100	110	Peak
5438.22	43.2	30.12	54	-10.8	34.35	8.48	29.75	100	110	Average
5438.22	53.58	40.5	74	-20.42	34.35	8.48	29.75	100	110	Peak
*10580	56.47	38.81	68.2	-11.73	37.27	12.65	32.26	124	177	Peak

Antenna Polarity & Test Distance: Vertical at 3 m										
Frequency (MHz)	Emission Level (dBuV/m)	Read Level (dBuV)	Limit (dBuV/m)	Margin (dB)	Antenna Factor (dB/m)	Cable Loss (dB)	Preamp Factor (dB)	Antenna Height (cm)	Table Angle (Degree)	Remark
5146.1	43.99	31.45	54	-10.01	34.12	8.13	29.71	112	59	Average
5146.1	55.58	43.04	74	-18.42	34.12	8.13	29.71	112	59	Peak
5290	93.82	81			34.23	8.32	29.73	112	59	Average
5290	101.23	88.41			34.23	8.32	29.73	112	59	Peak
5350.11	52.34	39.42	54	-1.66	34.28	8.38	29.74	106	54	Average
5350.11	64.24	51.32	74	-9.76	34.28	8.38	29.74	106	54	Peak
*10580	57.25	39.59	68.2	-10.95	37.27	12.65	32.26	125	255	Peak

Remarks:

- Emission Level = Read Level + Antenna Factor + Cable Loss - Preamp Factor  
Margin value = Emission level – Limit value
- 5290 MHz: Fundamental Frequency
- \*: Out of Restricted Band
- The emission levels of other frequencies were very low against the limit

EUT Test Condition		Measurement Detail	
Channel	Channel 106	Frequency Range	1 GHz ~ 40 GHz
Input Power	120 Vac, 60 Hz	Detector Function	Peak (PK) Average (AV)
Environmental Conditions	25 deg. C, 65 % RH	Tested By	Charles Hsiao

Antenna Polarity & Test Distance: Horizontal at 3 m										
Frequency (MHz)	Emission Level (dBuV/m)	Read Level (dBuV)	Limit (dBuV/m)	Margin (dB)	Antenna Factor (dB/m)	Cable Loss (dB)	Preamp Factor (dB)	Antenna Height (cm)	Table Angle (Degree)	Remark
5459.92	44.17	31.06	54	-9.83	34.36	8.51	29.76	100	74	Average
5459.92	54.54	41.43	74	-19.46	34.36	8.51	29.76	100	74	Peak
*5468.88	55.03	41.91	68.2	-13.17	34.37	8.51	29.76	100	74	Peak
5530	81.66	68.44			34.42	8.58	29.78	100	74	Average
5530	89.16	75.94			34.42	8.58	29.78	100	74	Peak
*5724.92	52.65	39.24	68.2	-15.55	34.62	8.65	29.86	100	74	Peak
11060	47.44	29.09	54	-6.56	37.64	12.91	32.2	129	9	Average
11060	57.07	38.72	74	-16.93	37.64	12.91	32.2	129	9	Peak

Antenna Polarity & Test Distance: Vertical at 3 m										
Frequency (MHz)	Emission Level (dBuV/m)	Read Level (dBuV)	Limit (dBuV/m)	Margin (dB)	Antenna Factor (dB/m)	Cable Loss (dB)	Preamp Factor (dB)	Antenna Height (cm)	Table Angle (Degree)	Remark
5460.08	52.96	39.85	54	-1.04	34.36	8.51	29.76	108	65	Average
5460.08	65.04	51.93	74	-8.96	34.36	8.51	29.76	108	65	Peak
*5468.08	65.77	52.65	68.2	-2.43	34.37	8.51	29.76	108	65	Peak
5530	93.39	80.17			34.42	8.58	29.78	108	61	Average
5530	101.13	87.91			34.42	8.58	29.78	108	61	Peak
*5723.96	52.04	38.63	68.2	-16.16	34.62	8.65	29.86	108	61	Peak
11060	47.57	29.22	54	-6.43	37.64	12.91	32.2	167	299	Average
11060	56.92	38.57	74	-17.08	37.64	12.91	32.2	167	299	Peak

Remarks:

- Emission Level = Read Level + Antenna Factor + Cable Loss - Preamp Factor  
Margin value = Emission level – Limit value
- 5530 MHz: Fundamental Frequency
- \*: Out of Restricted Band
- The emission levels of other frequencies were very low against the limit

EUT Test Condition		Measurement Detail	
Channel	Channel 122	Frequency Range	1 GHz ~ 40 GHz
Input Power	120 Vac, 60 Hz	Detector Function	Peak (PK) Average (AV)
Environmental Conditions	25 deg. C, 65 % RH	Tested By	Charles Hsiao

Antenna Polarity & Test Distance: Horizontal at 3 m										
Frequency (MHz)	Emission Level (dBuV/m)	Read Level (dBuV)	Limit (dBuV/m)	Margin (dB)	Antenna Factor (dB/m)	Cable Loss (dB)	Preamp Factor (dB)	Antenna Height (cm)	Table Angle (Degree)	Remark
5421.36	43.2	30.14	54	-10.8	34.33	8.48	29.75	100	74	Average
5421.36	53.76	40.7	74	-20.24	34.33	8.48	29.75	100	74	Peak
*5470.16	53.79	40.67	68.2	-14.41	34.37	8.51	29.76	100	74	Peak
5610	86.59	73.3			34.5	8.61	29.82	100	74	Average
5610	93.46	80.17			34.5	8.61	29.82	100	74	Peak
*5725.08	53.7	40.29	68.2	-14.5	34.62	8.65	29.86	100	74	Peak
11220	46.84	28.46	54	-7.16	37.73	12.8	32.15	124	153	Average
11220	58.94	40.56	74	-15.06	37.73	12.8	32.15	124	153	Peak

Antenna Polarity & Test Distance: Vertical at 3 m										
Frequency (MHz)	Emission Level (dBuV/m)	Read Level (dBuV)	Limit (dBuV/m)	Margin (dB)	Antenna Factor (dB/m)	Cable Loss (dB)	Preamp Factor (dB)	Antenna Height (cm)	Table Angle (Degree)	Remark
5456.56	46.27	33.16	54	-7.73	34.36	8.51	29.76	132	61	Average
5456.56	58.8	45.69	74	-15.2	34.36	8.51	29.76	132	61	Peak
*5469.52	56.82	43.7	68.2	-11.38	34.37	8.51	29.76	132	61	Peak
5610	98.58	85.29			34.5	8.61	29.82	132	61	Average
5610	105.18	91.89			34.5	8.61	29.82	132	61	Peak
*5725.64	59.45	46.04	68.2	-8.75	34.62	8.65	29.86	132	61	Peak
11220	47.26	28.88	54	-6.74	37.73	12.8	32.15	199	187	Average
11220	58.06	39.68	74	-15.94	37.73	12.8	32.15	199	187	Peak

Remarks:

- Emission Level = Read Level + Antenna Factor + Cable Loss - Preamp Factor  
Margin value = Emission level – Limit value
- 5610 MHz: Fundamental Frequency
- \*: Out of Restricted Band
- The emission levels of other frequencies were very low against the limit

EUT Test Condition		Measurement Detail	
Channel	Channel 138	Frequency Range	1 GHz ~ 40 GHz
Input Power	120 Vac, 60 Hz	Detector Function	Peak (PK) Average (AV)
Environmental Conditions	25 deg. C, 65 % RH	Tested By	Charles Hsiao

Antenna Polarity & Test Distance: Horizontal at 3 m										
Frequency (MHz)	Emission Level (dBuV/m)	Read Level (dBuV)	Limit (dBuV/m)	Margin (dB)	Antenna Factor (dB/m)	Cable Loss (dB)	Preamp Factor (dB)	Antenna Height (cm)	Table Angle (Degree)	Remark
5453.68	42.41	29.3	54	-11.59	34.36	8.51	29.76	100	74	Average
5453.68	53.89	40.78	74	-20.11	34.36	8.51	29.76	100	74	Peak
5469.84	52.39	39.27	74	-21.61	34.37	8.51	29.76	100	74	Peak
5690	85.77	72.39			34.59	8.64	29.85	100	74	Average
5690	92.33	78.95			34.59	8.64	29.85	100	74	Peak
11380	47.62	29.2	54	-6.38	37.83	12.69	32.1	183	221	Average
11380	57.14	38.72	74	-16.86	37.83	12.69	32.1	183	221	Peak
Antenna Polarity & Test Distance: Vertical at 3 m										
Frequency (MHz)	Emission Level (dBuV/m)	Read Level (dBuV)	Limit (dBuV/m)	Margin (dB)	Antenna Factor (dB/m)	Cable Loss (dB)	Preamp Factor (dB)	Antenna Height (cm)	Table Angle (Degree)	Remark
5454.96	42.91	29.8	54	-11.09	34.36	8.51	29.76	132	61	Average
5454.96	59.47	46.36	74	-14.53	34.36	8.51	29.76	132	61	Peak
5468.08	55.08	41.96	74	-18.92	34.37	8.51	29.76	132	61	Peak
5690	97.44	84.06			34.59	8.64	29.85	132	61	Average
5690	104.11	90.73			34.59	8.64	29.85	132	61	Peak
11380	47.37	28.95	54	-6.63	37.83	12.69	32.1	163	33	Average
11380	57.11	38.69	74	-16.89	37.83	12.69	32.1	163	33	Peak

Remarks:

- Emission Level = Read Level + Antenna Factor + Cable Loss - Preamp Factor  
Margin value = Emission level – Limit value
- 5690 MHz: Fundamental Frequency
- The emission levels of other frequencies were very low against the limit

EUT Test Condition		Measurement Detail	
Channel	Channel 155	Frequency Range	1 GHz ~ 40 GHz
Input Power	120 Vac, 60 Hz	Detector Function	Peak (PK) Average (AV)
Environmental Conditions	25 deg. C, 65 % RH	Tested By	Charles Hsiao

### <Spurious Emission>

Antenna Polarity & Test Distance: Horizontal at 3 m										
Frequency (MHz)	Emission Level (dBuV/m)	Read Level (dBuV)	Limit (dBuV/m)	Margin (dB)	Antenna Factor (dB/m)	Cable Loss (dB)	Preamp Factor (dB)	Antenna Height (cm)	Table Angle (Degree)	Remark
5775	87.17	73.71			34.68	8.67	29.89	227	119	Average
5775	94.67	81.21			34.68	8.67	29.89	227	119	Peak
11550	48.1	29.5	54	-5.9	37.97	12.68	32.05	124	4	Average
11550	58.23	39.63	74	-15.77	37.97	12.68	32.05	124	4	Peak
Antenna Polarity & Test Distance: Vertical at 3 m										
Frequency (MHz)	Emission Level (dBuV/m)	Read Level (dBuV)	Limit (dBuV/m)	Margin (dB)	Antenna Factor (dB/m)	Cable Loss (dB)	Preamp Factor (dB)	Antenna Height (cm)	Table Angle (Degree)	Remark
5775	96.89	83.43			34.68	8.67	29.89	126	62	Average
5775	103.69	90.23			34.68	8.67	29.89	126	62	Peak
11550	48.25	29.65	54	-5.75	37.97	12.68	32.05	137	199	Average
11550	57.96	39.36	74	-16.04	37.97	12.68	32.05	137	199	Peak

### <Out of Band Emission (OOBE)>

Antenna Polarity & Test Distance: Horizontal at 3 m										
Frequency (MHz)	Emission Level (dBuV/m)	Read Level (dBuV)	Limit (dBuV/m)	Margin (dB)	Antenna Factor (dB/m)	Cable Loss (dB)	Preamp Factor (dB)	Antenna Height (cm)	Table Angle (Degree)	Remark
*5528.875	53.32	40.1	68.2	-14.88	34.42	8.58	29.78	227	119	Peak
5654.35	53.33	39.98	71.42	-18.09	34.56	8.63	29.84	227	119	Peak
5918.95	51.45	37.87	72.68	-21.23	34.81	8.73	29.96	227	119	Peak
*6012.4	53.05	39.38	68.2	-15.15	34.92	8.76	30.01	227	119	Peak
Antenna Polarity & Test Distance: Vertical at 3 m										
Frequency (MHz)	Emission Level (dBuV/m)	Read Level (dBuV)	Limit (dBuV/m)	Margin (dB)	Antenna Factor (dB/m)	Cable Loss (dB)	Preamp Factor (dB)	Antenna Height (cm)	Table Angle (Degree)	Remark
*5587.15	58.44	45.16	68.2	-9.76	34.49	8.6	29.81	126	62	Peak
5653.3	57.51	44.15	70.64	-13.13	34.56	8.63	29.83	126	62	Peak
5920.525	52.98	39.4	71.51	-18.53	34.81	8.73	29.96	126	62	Peak
*5946.775	55.46	41.84	68.2	-12.74	34.85	8.74	29.97	126	62	Peak

#### Remarks:

- Emission Level = Read Level + Antenna Factor + Cable Loss - Preamp Factor  
Margin value = Emission level – Limit value
- 5775 MHz: Fundamental Frequency
- \*: Out of Restricted Band
- The emission levels of other frequencies were very low against the limit

**9 kHz ~ 30 MHz Data:**

The amplitude of spurious emissions attenuated more than 20 dB below the permissible value is not required to be report.

**30 MHz ~ 1 GHz Worst-Case Data:**

**802.11ac (VHT80)**

EUT Test Condition		Measurement Detail	
Channel	Channel 42	Frequency Range	30 MHz ~ 1 GHz
Input Power	120 Vac, 60 Hz	Detector Function	Peak (PK) Quasi-peak (QP)
Environmental Conditions	25 deg. C, 65 % RH	Tested By	Charles Hsiao

**Horizontal**

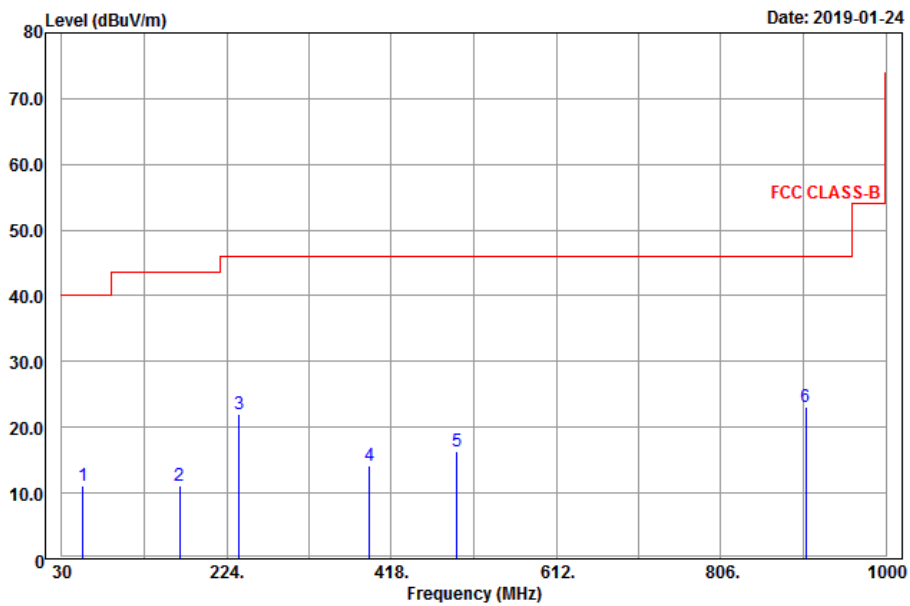

**Vertical**

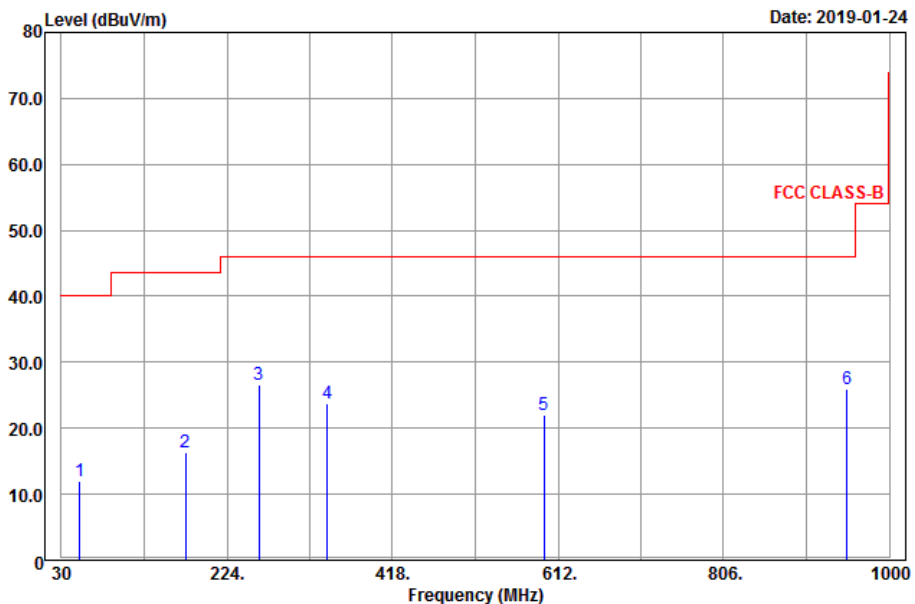

**Antenna Polarity & Test Distance: Horizontal at 3 m**

Frequency (MHz)	Emission Level (dBuV/m)	Read Level (dBuV)	Limit (dBuV/m)	Margin (dB)	Antenna Factor (dB/m)	Cable Loss (dB)	Preamp Factor (dB)	Antenna Height (cm)	Table Angle (Degree)	Remark
54.84	11.11	28.3	40	-28.89	14.14	0.9	32.23	122	195	Peak
169.05	11.05	32.71	43.5	-32.45	9.06	1.52	32.24	160	134	Peak
238.71	22.08	40.32	46	-23.92	12.05	1.85	32.14	177	124	Peak
392.4	14.17	29.18	46	-31.83	14.85	2.34	32.2	109	124	Peak
495.3	16.24	29.42	46	-29.76	16.29	2.63	32.1	127	144	Peak
906.2	23.15	29.57	46	-22.85	21.49	3.53	31.44	156	348	Peak

**Antenna Polarity & Test Distance: Vertical at 3 m**

Frequency (MHz)	Emission Level (dBuV/m)	Read Level (dBuV)	Limit (dBuV/m)	Margin (dB)	Antenna Factor (dB/m)	Cable Loss (dB)	Preamp Factor (dB)	Antenna Height (cm)	Table Angle (Degree)	Remark
51.33	12.02	28.89	40	-27.98	14.46	0.9	32.23	133	154	Peak
175.26	16.35	37.54	43.5	-27.15	9.44	1.61	32.24	187	49	Peak
261.66	26.7	44.35	46	-19.3	12.52	1.94	32.11	120	221	Peak
342	23.83	39.61	46	-22.17	14.11	2.19	32.08	165	244	Peak
595.4	21.95	33.41	46	-24.05	17.86	2.87	32.19	148	127	Peak
950.3	25.93	31.66	46	-20.07	21.75	3.62	31.1	190	315	Peak

Remarks:

- Emission Level = Read Level + Antenna Factor + Cable Loss - Preamp Factor  
Margin value = Emission level – Limit value
- The emission levels of other frequencies were very low against the limit



## 4.2 Conducted Emission Measurement

### 4.2.1 Limits of Conducted Emission Measurement

Frequency (MHz)	Conducted Limit (dBuV)	
	Quasi-Peak	Average
0.15 - 0.5	66 - 56	56 - 46
0.50 - 5.0	56	46
5.0 - 30.0	60	50

- Note: 1. The lower limit shall apply at the transition frequencies.  
 2. The limit decreases in line with the logarithm of the frequency in the range of 0.15 to 0.50 MHz.

### 4.2.2 Test Instruments

Description & Manufacturer	Model No.	Serial No.	Date of Calibration	Due Date of Calibration
Test Receiver ROHDE & SCHWARZ	ESCI	100613	Dec. 10, 2018	Dec. 09, 2019
RF signal cable Woken	5D-FB	Cable-cond1-01	Sep. 05, 2018	Sep. 04, 2019
LISN/AMN ROHDE & SCHWARZ (EUT)	ENV216	101826	Feb. 26, 2018	Feb. 25, 2019
LISN/AMN ROHDE & SCHWARZ (Peripheral)	ESH3-Z5	100311	Aug. 19, 2018	Aug. 18, 2019
Software ADT	BV ADT_Cond_ V7.3.7.4	NA	NA	NA

- Note: 1. The calibration interval of the above test instruments is 12 months and the calibrations are traceable to NML/ROC and NIST/USA.  
 2. The test was performed in HwaYa Shielded Room 1.  
 3. The VCCI Site Registration No. is C-2040.

#### 4.2.3 Test Procedures

- a. The EUT was placed 0.4 meters from the conducting wall of the shielded room with EUT being connected to the power mains through a line impedance stabilization network (LISN). Other support units were connected to the power mains through another LISN. The two LISNs provide 50 ohm/ 50uH of coupling impedance for the measuring instrument.
- b. Both lines of the power mains connected to the EUT were checked for maximum conducted interference.
- c. The frequency range from 150 kHz to 30 MHz was searched. Emission levels under (Limit -20 dB) was not recorded.

**Note:** All modes of operation were investigated and the worst-case emissions are reported.

#### 4.2.4 Deviation from Test Standard

No deviation.

#### 4.2.5 Test Setup

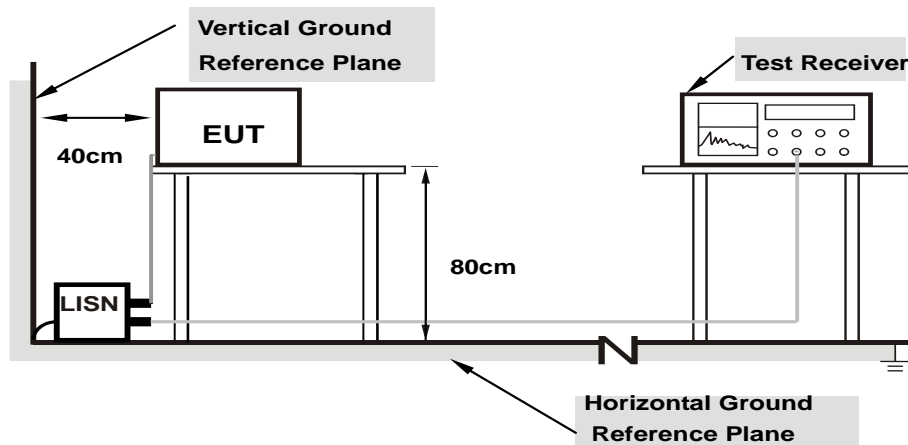

- Note:**
1. Support units were connected to second LISN.
  2. Both of LISNs (AMN) are 80 cm from EUT and at least 80 from other units and other metal planes

For the actual test configuration, please refer to the attached file (Test Setup Photo).

#### 4.2.6 EUT Operating Conditions

- a. Placed the EUT on a testing table.
- b. Use the software to control the EUT under transmission condition continuously at specific channel frequency.

#### 4.2.7 Test Results

Frequency Range	150kHz ~ 30MHz	Detector Function & Resolution Bandwidth	Quasi-Peak (QP) / Average (AV), 9kHz
Input Power	120Vac, 60Hz	Environmental Conditions	25°C, 65%RH
Tested by	Jisyong Wang	Test Date	2019/2/16

Phase Of Power : Line (L)										
No	Frequency (MHz)	Correction Factor (dB)	Reading Value (dBuV)		Emission Level (dBuV)		Limit (dBuV)		Margin (dB)	
			Q.P.	AV.	Q.P.	AV.	Q.P.	AV.	Q.P.	AV.
1	0.16953	9.67	27.87	10.74	37.54	20.41	64.98	54.98	-27.44	-34.57
2	0.44297	9.66	29.71	5.54	39.37	15.20	57.01	47.01	-17.64	-31.81
3	1.46094	9.66	22.28	5.20	31.94	14.86	56.00	46.00	-24.06	-31.14
4	1.65234	9.67	23.80	5.25	33.47	14.92	56.00	46.00	-22.53	-31.08
5	8.72266	9.82	19.56	5.08	29.38	14.90	60.00	50.00	-30.62	-35.10
6	25.87109	9.92	19.08	5.60	29.00	15.52	60.00	50.00	-31.00	-34.48

Remarks:

1. Q.P. and AV. are abbreviations of quasi-peak and average individually.
2. The emission levels of other frequencies were very low against the limit.
3. Margin value = Emission level – Limit value
4. Correction factor = Insertion loss + Cable loss
5. Emission Level = Correction Factor + Reading Value

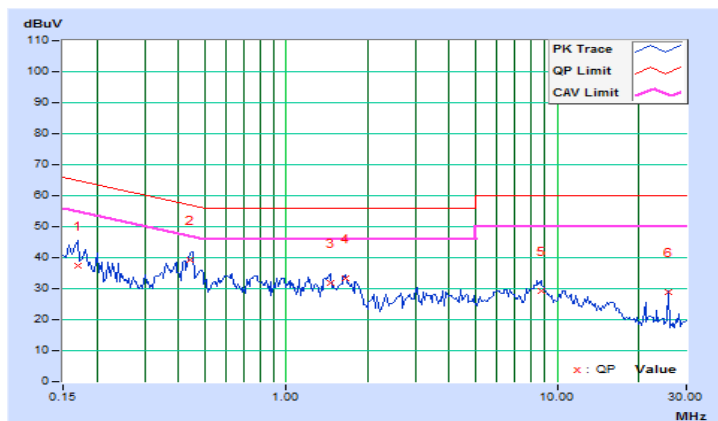

Frequency Range	150kHz ~ 30MHz	Detector Function & Resolution Bandwidth	Quasi-Peak (QP) / Average (AV), 9kHz
Input Power	120Vac, 60Hz	Environmental Conditions	25°C, 65%RH
Tested by	Jisyong Wang	Test Date	2019/2/16

Phase Of Power : Neutral (N)										
No	Frequency (MHz)	Correction Factor (dB)	Reading Value (dBuV)		Emission Level (dBuV)		Limit (dBuV)		Margin (dB)	
			Q.P.	AV.	Q.P.	AV.	Q.P.	AV.	Q.P.	AV.
1	0.16172	9.68	30.53	5.89	40.21	15.57	65.38	55.38	-25.17	-39.81
2	0.19687	9.67	28.88	5.98	38.55	15.65	63.74	53.74	-25.19	-38.09
3	0.41563	9.67	31.50	7.63	41.17	17.30	57.54	47.54	-16.37	-30.24
4	1.67578	9.67	27.06	11.28	36.73	20.95	56.00	46.00	-19.27	-25.05
5	6.43359	9.78	17.86	5.56	27.64	15.34	60.00	50.00	-32.36	-34.66
6	25.87109	10.03	19.24	4.74	29.27	14.77	60.00	50.00	-30.73	-35.23

Remarks:

1. Q.P. and AV. are abbreviations of quasi-peak and average individually.
2. The emission levels of other frequencies were very low against the limit.
3. Margin value = Emission level – Limit value
4. Correction factor = Insertion loss + Cable loss
5. Emission Level = Correction Factor + Reading Value

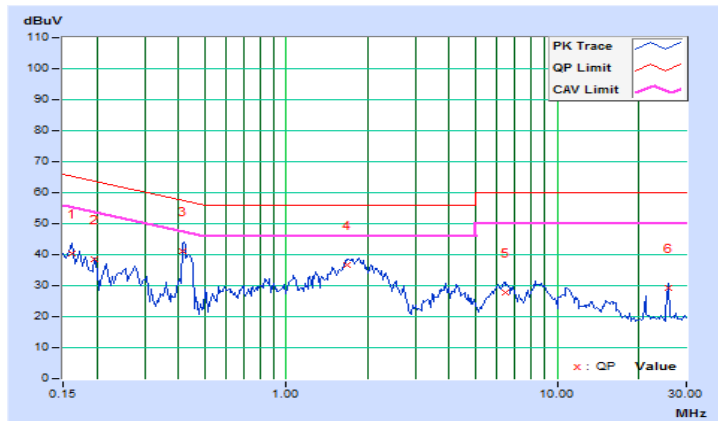

### 4.3 Transmit Power Measurement

#### 4.3.1 Limits of Transmit Power Measurement

Operation Band	EUT Category		Limit
U-NII-1		Outdoor Access Point	1 Watt (30 dBm) (Max. e.i.r.p $\leq$ 125 mW (21 dBm) at any elevation angle above 30 degrees as measured from the horizon)
		Fixed point-to-point Access Point	1 Watt (30 dBm)
		Indoor Access Point	1 Watt (30 dBm)
	√	Mobile and Portable client device	250 mW (24 dBm)
U-NII-2A		√	250 mW (24 dBm) or 11 dBm + 10 log B*
U-NII-2C		√	250 mW (24 dBm) or 11 dBm + 10 log B*
U-NII-3		√	1 Watt (30 dBm)

\*B is the 26 dB emission bandwidth in megahertz

Per KDB 662911 Method of conducted output power measurement on IEEE 802.11 devices,

Array Gain = 0 dB (i.e., no array gain) for  $N_{ANT} \leq 4$ ;

Array Gain = 0 dB (i.e., no array gain) for channel widths  $\geq 40$  MHz for any  $N_{ANT}$ ;

Array Gain =  $5 \log(N_{ANT}/N_{SS})$  dB or 3 dB, whichever is less for 20 MHz channel widths with  $N_{ANT} \geq 5$ .

For power measurements on all other devices: Array Gain =  $10 \log(N_{ANT}/N_{SS})$  dB.

#### 4.3.2 Test Setup

##### <Power Output Measurement>

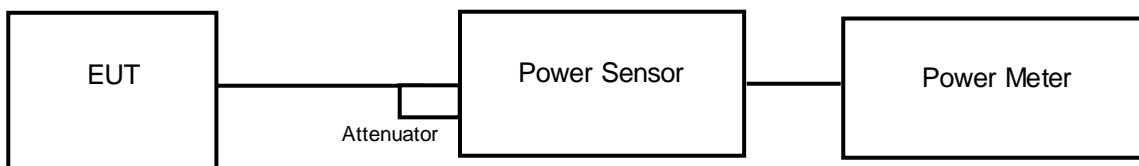

or

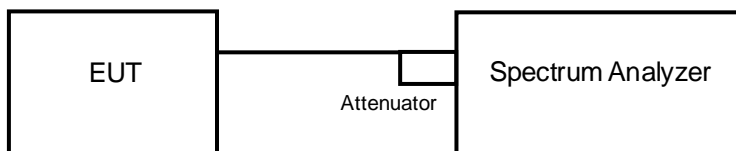

##### <26 dB Bandwidth>

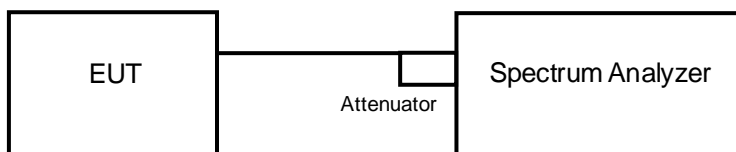

#### 4.3.3 Test Instruments

Refer to section 4.1.2 to get information of above instrument.

#### 4.3.4 Test Procedure

##### **Average Power Measurement**

<802.11a, 802.11n (HT20), 802.11n (HT40)>

Method PM is used to perform output power measurement, trigger and gating function of wide band power meter is enabled to measure max output power of TX on burst. Duty factor is not added to measured value.

<802.11ac (VHT80)>

- a. Set span to encompass the entire 26 dB EBW (or, alternatively, the entire 99 % occupied bandwidth) of the signal.
- b. Set sweep trigger to “free run”.
- c. Set RBW = 1 MHz.
- d. Set VBW  $\geq$  3 MHz
- e. Number of points in sweep  $\geq$  2 Span / RBW.
- f. Sweep time  $\leq$  (number of points in sweep) \* T
- g. Using emission bandwidth to determine the frequency span for integration the channel bandwidth.
- h. Detector = RMS.
- i. Trace mode = max hold.
- j. Allow max hold to run for at least 60 seconds, or longer as needed to allow the trace to stabilize.

##### **26 dB Bandwidth**

- a. Set RBW = approximately 1 % of the emission bandwidth.
- b. Set the VBW > RBW.
- c. Detector = Peak.
- d. Trace mode = max hold.
- e. Measure the maximum width of the emission that is 26 dB down from the peak of the emission. Compare this with the RBW setting of the analyzer. Readjust RBW and repeat measurement as needed until the RBW/EBW ratio is approximately 1 %.

#### 4.3.5 Deviation from Test Standard

No deviation.

#### 4.3.6 EUT Operating Conditions

The software provided by client to enable the EUT under transmission condition continuously at lowest, middle and highest channel frequencies individually.

#### 4.3.7 Test Results

##### Power Output:

##### 802.11a

Channel	Frequency (MHz)	Maximum Conducted Power (mW)	Maximum Conducted Power (dBm)	Power Limit (dBm)	Pass / Fail
36	5180	24.378	13.87	24	Pass
40	5200	23.496	13.71	24	Pass
48	5240	23.714	13.75	24	Pass
52	5260	24.099	13.82	23.88	Pass
60	5300	23.823	13.77	23.85	Pass
64	5320	24.660	13.92	23.88	Pass
100	5500	24.946	13.97	23.87	Pass
116	5580	23.442	13.7	23.83	Pass
140	5700	24.378	13.87	23.83	Pass
144	5720 (U-NII-2C)	27.138	14.34	22.78	Pass
144	5720 (U-NII-3)	6.54	8.16	30	Pass
149	5745	23.605	13.73	30	Pass
157	5785	23.227	13.66	30	Pass
165	5825	24.434	13.88	30	Pass

##### Note:

##### For U-NII-2A, U-NII-2C Band:

- $11 \text{ dBm} + 10\log(19.41) = 23.88 \text{ dBm} < 24 \text{ dBm}$ .
- $11 \text{ dBm} + 10\log(19.28) = 23.85 \text{ dBm} < 24 \text{ dBm}$ .
- $11 \text{ dBm} + 10\log(19.45) = 23.88 \text{ dBm} < 24 \text{ dBm}$ .
- $11 \text{ dBm} + 10\log(19.40) = 23.87 \text{ dBm} < 24 \text{ dBm}$ .
- $11 \text{ dBm} + 10\log(19.19) = 23.83 \text{ dBm} < 24 \text{ dBm}$ .
- $11 \text{ dBm} + 10\log(19.21) = 23.83 \text{ dBm} < 24 \text{ dBm}$ .
- $11 \text{ dBm} + 10\log(15.09) = 22.78 \text{ dBm} < 24 \text{ dBm}$ .

### 802.11n (HT20)

Channel	Frequency (MHz)	Maximum Conducted Power (dBm)		Total Power (mW)	Total Power (dBm)	Power Limit (dBm)	Pass / Fail
		Chain 0	Chain 1				
36	5180	10.87	10.83	24.324	13.86	24	Pass
40	5200	10.93	10.73	24.218	13.84	24	Pass
48	5240	10.83	10.92	24.465	13.89	24	Pass
52	5260	14.75	14.94	61.043	17.86	24	Pass
60	5300	14.78	14.86	60.681	17.83	24	Pass
64	5320	14.91	15.02	62.743	17.98	24	Pass
100	5500	12.89	12.48	37.155	15.70	24	Pass
116	5580	14.73	14.69	59.161	17.72	24	Pass
140	5700	10.45	10.65	22.706	13.56	24	Pass
144	5720 (U-NII-2C)	14.85	15.09	68.699	18.37	22.94	Pass
144	5720 (U-NII-3)	9.49	10.60	22.276	13.48	30	Pass
149	5745	14.89	14.86	61.452	17.89	30	Pass
157	5785	14.70	14.78	59.573	17.75	30	Pass
165	5825	14.58	14.79	58.838	17.70	30	Pass

**Note:**

**For U-NII-2A, U-NII-2C Band:**

**Chain 0**

1.  $11 \text{ dBm} + 10\log(28.73) = 25.58 \text{ dBm} > 24 \text{ dBm}$ .
2.  $11 \text{ dBm} + 10\log(30.78) = 25.88 \text{ dBm} > 24 \text{ dBm}$ .
3.  $11 \text{ dBm} + 10\log(22.39) = 24.50 \text{ dBm} > 24 \text{ dBm}$ .
4.  $11 \text{ dBm} + 10\log(20.76) = 24.17 \text{ dBm} > 24 \text{ dBm}$ .
5.  $11 \text{ dBm} + 10\log(22.53) = 24.52 \text{ dBm} > 24 \text{ dBm}$ .
6.  $11 \text{ dBm} + 10\log(20.64) = 24.14 \text{ dBm} > 24 \text{ dBm}$ .
7.  $11 \text{ dBm} + 10\log(15.64) = 22.94 \text{ dBm} < 24 \text{ dBm}$ .

**Chain 1**

1.  $11 \text{ dBm} + 10\log(31.47) = 25.97 \text{ dBm} > 24 \text{ dBm}$ .
2.  $11 \text{ dBm} + 10\log(26.72) = 25.26 \text{ dBm} > 24 \text{ dBm}$ .
3.  $11 \text{ dBm} + 10\log(28.07) = 25.48 \text{ dBm} > 24 \text{ dBm}$ .
4.  $11 \text{ dBm} + 10\log(20.54) = 24.12 \text{ dBm} > 24 \text{ dBm}$ .
5.  $11 \text{ dBm} + 10\log(21.04) = 24.23 \text{ dBm} > 24 \text{ dBm}$ .
6.  $11 \text{ dBm} + 10\log(20.34) = 24.08 \text{ dBm} > 24 \text{ dBm}$ .
7.  $11 \text{ dBm} + 10\log(17.87) = 23.52 \text{ dBm} < 24 \text{ dBm}$ .



### 802.11n (HT40)

Channel	Frequency (MHz)	Maximum Conducted Power (dBm)		Total Power (mW)	Total Power (dBm)	Power Limit (dBm)	Pass / Fail
		Chain 0	Chain 1				
38	5190	12.18	11.83	31.761	15.02	24	Pass
46	5230	13.71	14.07	49.023	16.90	24	Pass
54	5270	13.75	13.98	48.717	16.88	24	Pass
62	5310	13.53	13.78	46.420	16.67	24	Pass
102	5510	10.66	10.24	22.209	13.47	24	Pass
110	5550	13.87	14.02	49.613	16.96	24	Pass
134	5670	13.63	13.72	46.617	16.69	24	Pass
142	5710 (U-NII-2C)	12.61	13.01	44.611	16.49	24	Pass
142	5710 (U-NII-3)	5.21	6.69	9.317	9.69	30	Pass
151	5755	13.48	13.78	46.162	16.64	30	Pass
159	5795	13.93	13.82	48.816	16.89	30	Pass

**Note:**

**For U-NII-2A, U-NII-2C Band:**

**Chain 0**

1.  $11 \text{ dBm} + 10\log(45.87) = 27.61 \text{ dBm} > 24 \text{ dBm}$ .
2.  $11 \text{ dBm} + 10\log(45.75) = 27.60 \text{ dBm} > 24 \text{ dBm}$ .
3.  $11 \text{ dBm} + 10\log(44.93) = 27.52 \text{ dBm} > 24 \text{ dBm}$ .
4.  $11 \text{ dBm} + 10\log(47.53) = 27.76 \text{ dBm} > 24 \text{ dBm}$ .
5.  $11 \text{ dBm} + 10\log(45.67) = 27.59 \text{ dBm} > 24 \text{ dBm}$ .
6.  $11 \text{ dBm} + 10\log(37.28) = 26.71 \text{ dBm} > 24 \text{ dBm}$ .

**Chain 1**

1.  $11 \text{ dBm} + 10\log(53.52) = 28.28 \text{ dBm} > 24 \text{ dBm}$ .
2.  $11 \text{ dBm} + 10\log(48.13) = 27.82 \text{ dBm} > 24 \text{ dBm}$ .
3.  $11 \text{ dBm} + 10\log(52.34) = 28.18 \text{ dBm} > 24 \text{ dBm}$ .
4.  $11 \text{ dBm} + 10\log(45.36) = 27.56 \text{ dBm} > 24 \text{ dBm}$ .
5.  $11 \text{ dBm} + 10\log(43.26) = 27.36 \text{ dBm} > 24 \text{ dBm}$ .
6.  $11 \text{ dBm} + 10\log(43.69) = 27.40 \text{ dBm} > 24 \text{ dBm}$ .

### 802.11ac (VHT80)

Channel	Frequency (MHz)	Maximum Conducted Power (dBm)		Total Power (mW)	Total Power (dBm)	Power Limit (dBm)	Pass / Fail
		Chain 0	Chain 1				
42	5210	8.47	8.07	13.443	11.28	24	Pass
58	5290	11.25	10.90	25.638	14.09	24	Pass
106	5530	8.97	8.27	14.603	11.64	24	Pass
122	5610	13.65	13.72	46.724	16.70	24	Pass
138	5690 (U-NII-2C)	12.90	13.59	56.076	17.49	24	Pass
138	5690 (U-NII-3)	1.78	2.14	4.163	6.19	30	Pass
155	5775	13.74	13.56	46.358	16.66	30	Pass

**Note:**

**For U-NII-2A, U-NII-2C Band:**

**Chain 0**

1.  $11 \text{ dBm} + 10\log(82.76) = 30.17 \text{ dBm} > 24 \text{ dBm}$ .
2.  $11 \text{ dBm} + 10\log(82.61) = 30.17 \text{ dBm} > 24 \text{ dBm}$ .
3.  $11 \text{ dBm} + 10\log(83.12) = 30.19 \text{ dBm} > 24 \text{ dBm}$ .
4.  $11 \text{ dBm} + 10\log(76.28) = 29.82 \text{ dBm} > 24 \text{ dBm}$ .

**Chain 1**

1.  $11 \text{ dBm} + 10\log(81.29) = 30.10 \text{ dBm} > 24 \text{ dBm}$ .
2.  $11 \text{ dBm} + 10\log(82.89) = 30.18 \text{ dBm} > 24 \text{ dBm}$ .
3.  $11 \text{ dBm} + 10\log(81.27) = 30.09 \text{ dBm} > 24 \text{ dBm}$ .
4.  $11 \text{ dBm} + 10\log(75.76) = 29.79 \text{ dBm} > 24 \text{ dBm}$ .

**26 dB Bandwidth:**
**802.11a**

Channel	Frequency (MHz)	26 dBc Bandwidth (MHz)
36	5180	19.26
40	5200	20.05
48	5240	19.19
52	5260	19.41
60	5300	19.28
64	5320	19.45
100	5500	19.40
116	5580	19.19
140	5700	19.21
144	5720 (U-NII-2C)	15.09
144	5720 (U-NII-3)	4.79

**802.11n (HT20)**

Channel	Frequency (MHz)	26 dBc Bandwidth (MHz)	
		Chain 0	Chain 1
36	5180	20.43	20.19
40	5200	20.45	20.51
48	5240	20.52	20.25
52	5260	28.73	31.47
60	5300	30.78	26.72
64	5320	22.39	28.07
100	5500	20.76	20.54
116	5580	22.53	21.04
140	5700	20.64	20.34
144	5720 (U-NII-2C)	15.64	17.87
144	5720 (U-NII-3)	6.42	9.86

### 802.11n (HT40)

Channel	Frequency (MHz)	26 dBc Bandwidth (MHz)	
		Chain 0	Chain 1
38	5190	48.73	52.41
46	5230	46.79	44.93
54	5270	45.87	53.52
62	5310	45.75	48.13
102	5510	44.93	52.34
110	5550	47.53	45.36
134	5670	45.67	43.26
142	5710 (U-NII-2C)	37.28	43.69
142	5710 (U-NII-3)	6.78	10.20

### 802.11ac (VHT80)

Channel	Frequency (MHz)	26 dBc Bandwidth (MHz)	
		Chain 0	Chain 1
42	5210	84.05	80.83
58	5290	82.76	81.29
106	5530	82.61	82.89
122	5610	83.12	81.27
138	5690 (U-NII-2C)	76.28	75.76
138	5690 (U-NII-3)	5.90	5.43

### Spectrum Plot of Worst Value

#### 802.11a

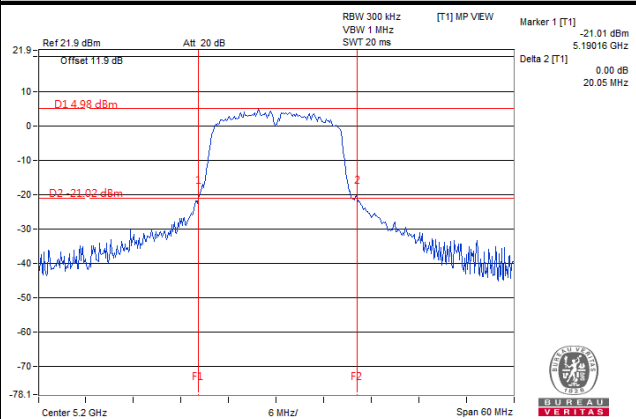

#### 802.11n (HT20)

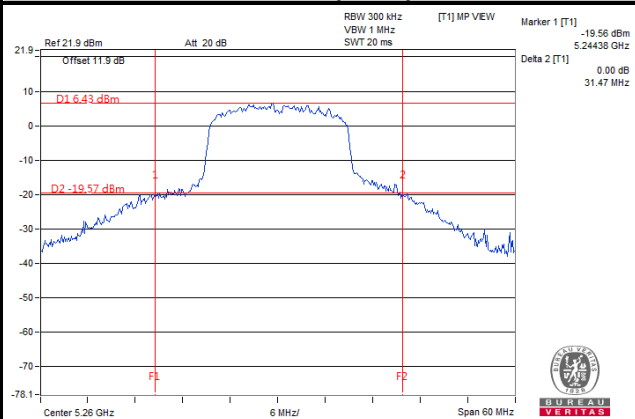

#### 802.11n (HT40)

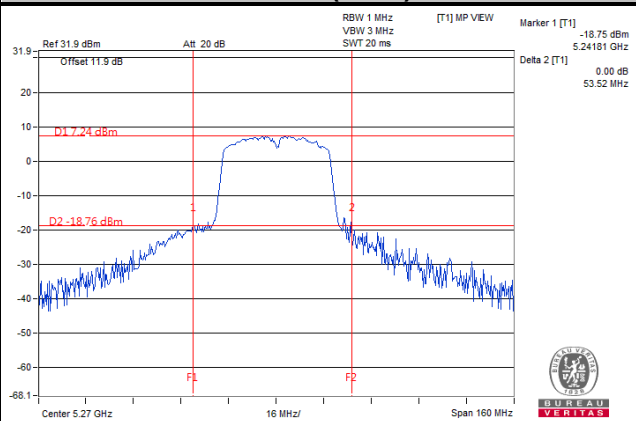

#### 802.11ac (VHT80)

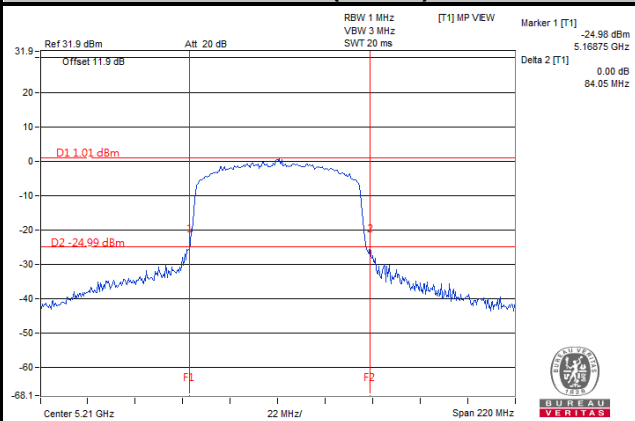

## 4.4 Occupied Bandwidth Measurement

### 4.4.1 Test Setup

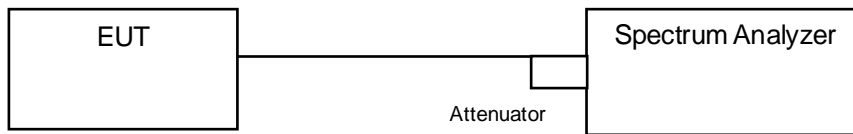

### 4.4.2 Test Instruments

Refer to section 4.1.2 to get information of above instrument.

### 4.4.3 Test Procedure

The transmitter output was connected to the spectrum analyzer through an attenuator. The bandwidth of the fundamental frequency was measured by spectrum analyzer with resolution bandwidth in the range of 1 % to 5 % of the anticipated emission bandwidth, and a video bandwidth at least 3x the resolution bandwidth and set the detector to SAMPLE. The width of a frequency band such that, below the lower and above the upper frequency limits, the mean powers emitted are each equal to a specified percentage 0.5 % of the total mean power of a given emission.

4.4.4 Test Results

802.11a

Channel	Channel Frequency (MHz)	Occupied Bandwidth (MHz)
36	5180	16.32
40	5200	16.32
48	5240	16.32
52	5260	16.32
60	5300	16.32
64	5320	16.32
100	5500	16.32
116	5580	16.32
140	5700	16.32
144	5720 (U-NII-2C)	13.16
144	5720 (U-NII-3)	3.04
149	5745	16.32
157	5785	16.32
165	5825	16.32

802.11n (HT20)

Channel	Channel Frequency (MHz)	Occupied Bandwidth (MHz)	
		Chain 0	Chain 1
36	5180	17.40	17.40
40	5200	17.40	17.40
48	5240	17.40	17.40
52	5260	17.76	17.64
60	5300	17.76	17.64
64	5320	17.52	17.64
100	5500	17.40	17.40
116	5580	17.52	17.52
140	5700	17.40	17.40
144	5720 (U-NII-2C)	13.76	13.76
144	5720 (U-NII-3)	3.76	3.76
149	5745	17.52	17.76
157	5785	17.64	17.52
165	5825	18.96	17.64

**802.11n (HT40)**

Channel	Channel Frequency (MHz)	Occupied Bandwidth (MHz)	
		Chain 0	Chain 1
38	5190	36.12	36.00
46	5230	36.12	36.12
54	5270	36.12	36.12
62	5310	36.12	36.12
102	5510	36.12	36.00
110	5550	36.12	36.12
134	5670	36.12	36.12
142	5710 (U-NII-2C)	33.12	33.12
142	5710 (U-NII-3)	3.00	3.00
151	5755	36.12	36.12
159	5795	36.24	36.12

**802.11ac (VHT80)**

Channel	Channel Frequency (MHz)	Occupied Bandwidth (MHz)	
		Chain 0	Chain 1
42	5210	74.88	74.64
58	5290	74.88	74.88
106	5530	74.88	74.88
122	5610	74.88	74.88
138	5690 (U-NII-2C)	72.92	72.68
138	5690 (U-NII-3)	2.20	2.20
155	5775	75.12	74.88



### Spectrum Plot of Worst Value

#### 802.11a

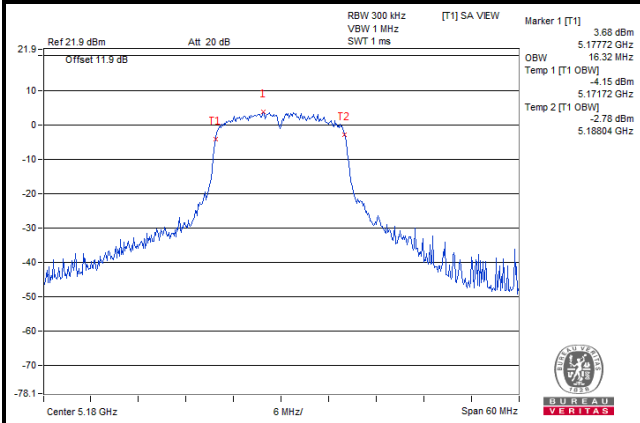

#### 802.11n (HT20)

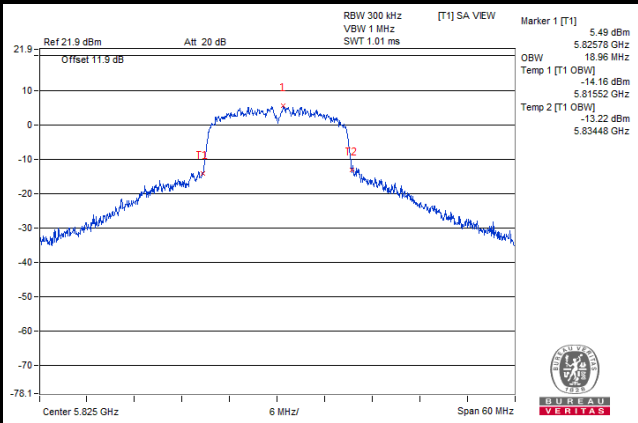

#### 802.11n (HT40)

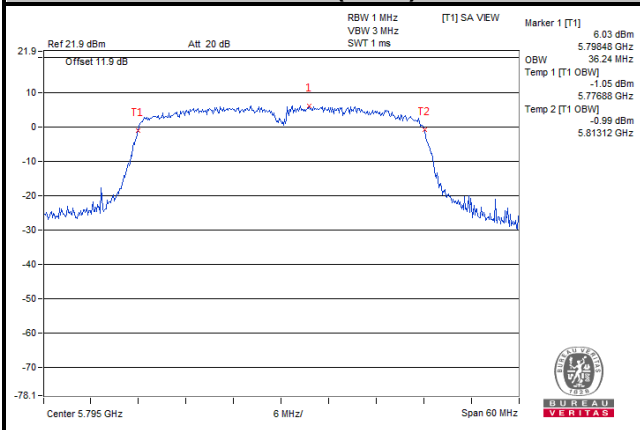

#### 802.11ac (VHT80)

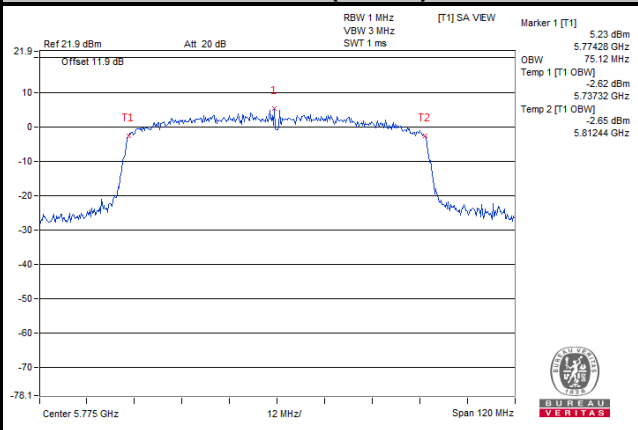

## 4.5 Peak Power Spectral Density Measurement

### 4.5.1 Limits of Peak Power Spectral Density Measurement

Operation Band	EUT Category		Limit
U-NII-1		Outdoor Access Point	17 dBm/MHz
		Fixed point-to-point Access Point	
		Indoor Access Point	
	√	Mobile and Portable client device	11 dBm/MHz
U-NII-2A		√	11 dBm/MHz
U-NII-2C		√	11 dBm/MHz
U-NII-3		√	30 dBm/500 kHz

### 4.5.2 Test Setup

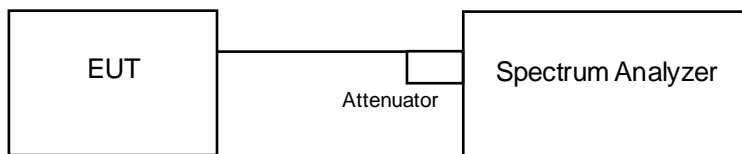

### 4.5.3 Test Instruments

Refer to section 4.1.3 to get information of above instrument.

### 4.5.4 Test Procedures

#### For U-NII-1, U-NII-2A, U-NII-2C band:

Using method SA-2

1. Set span to encompass the entire emission bandwidth (EBW) of the signal.
2. Set RBW = 1 MHz, Set VBW  $\geq$  3 RBW, Detector = RMS
3. Sweep time = auto, trigger set to "free run".
4. Trace average at least 100 traces in power averaging mode.
5. Record the max value and add 10 log (1/duty cycle)

#### ※For U-NII-3:

1. Set span to encompass the entire emission bandwidth (EBW) of the signal.
2. Set RBW = 300 kHz, Set VBW  $\geq$  1 RBW, Detector = RMS
3. Use the peak marker function to determine the maximum power level in any 300 kHz band segment within the fundamental EBW.
4. Scale the observed power level to an equivalent value in 500 kHz by adjusting (reducing) the measured power by a bandwidth correction factor (BWCF) where  $BWCF = 10\log(500 \text{ kHz} / 300 \text{ kHz})$ .
5. Sweep time = auto, trigger set to "free run".
6. Trace average at least 100 traces in power averaging mode.
7. Record the max value and add 10 log (1/duty cycle)

#### 4.5.5 Deviation from Test Standard

No deviation.

#### 4.5.6 EUT Operating Conditions

The software provided by client to enable the EUT under transmission condition continuously at lowest, middle and highest channel frequencies individually.

#### 4.5.7 Test Results

##### 802.11a

Channel	Frequency (MHz)	PSD w/o Duty Factor (dBm/MHz)	Duty Factor (dB)	PSD with Duty Factor (dBm/MHz)	Maximum Limit (dBm/MHz)	Pass / Fail
36	5180	0.89	0.39	1.28	11	Pass
40	5200	1.04	0.39	1.43	11	Pass
48	5240	1.46	0.39	1.85	11	Pass
52	5260	1.41	0.39	1.80	11	Pass
60	5300	1.74	0.39	2.13	11	Pass
64	5320	1.73	0.39	2.12	11	Pass
100	5500	1.43	0.39	1.82	11	Pass
116	5580	1.37	0.39	1.76	11	Pass
140	5700	1.86	0.39	2.25	11	Pass
144	5720 (U-NII-2C)	1.37	0.39	1.76	11	Pass

**Note:** Refer to section 3.3 for duty cycle spectrum plot.

##### 802.11n (HT20)

Channel	Frequency (MHz)	PSD (dBm/MHz)		Duty Factor (dB)	Total PSD with Duty Factor (dBm/MHz)	Max. Limit (dBm/MHz)	Pass / Fail
		Chain 0	Chain 1				
36	5180	-1.64	-1.82	0.39	1.67	8.99	Pass
40	5200	-1.78	-1.78	0.39	1.62	8.99	Pass
48	5240	-1.55	-1.78	0.39	1.73	8.99	Pass
52	5260	2.60	2.84	0.39	6.12	8.99	Pass
60	5300	2.47	2.68	0.39	5.97	8.99	Pass
64	5320	2.18	2.80	0.39	5.90	8.99	Pass
100	5500	0.74	1.14	0.39	4.34	8.99	Pass
116	5580	2.72	2.80	0.39	6.16	8.99	Pass
140	5700	-1.62	-1.35	0.39	1.92	8.99	Pass
144	5720 (U-NII-2C)	1.68	2.01	0.39	5.25	8.99	Pass

**Note:**

- Method 2) a) of power density measurement of KDB 662911 is using for calculating total power density. Total power density is summing entire spectra across corresponding frequency bins on the various outputs by computer.
- Directional gain = 5 dBi + 10log(2) = 8.01 dBi > 6 dBi , so the power density limit shall be reduced to 11-(8.01-6) = 8.99 dBm.
- Refer to section 3.3 for duty cycle spectrum plot.

### 802.11n (HT40)

Channel	Frequency (MHz)	PSD (dBm/MHz)		Duty Factor (dB)	Total PSD with Duty Factor (dBm/MHz)	Max. Limit (dBm/MHz)	Pass / Fail
		Chain 0	Chain 1				
38	5190	-4.02	-4.06	0.67	-0.36	8.99	Pass
46	5230	-2.92	-2.24	0.67	1.11	8.99	Pass
54	5270	-2.73	-1.30	0.67	1.72	8.99	Pass
62	5310	-3.15	-2.80	0.67	0.71	8.99	Pass
102	5510	-5.15	-4.63	0.67	-1.20	8.99	Pass
110	5550	-2.25	-1.95	0.67	1.58	8.99	Pass
134	5670	-2.58	-2.16	0.67	1.31	8.99	Pass
142	5710 (U-NII-2C)	-3.29	-2.62	0.67	0.74	8.99	Pass

**Note:**

- Method 2) a) of power density measurement of KDB 662911 is using for calculating total power density. Total power density is summing entire spectra across corresponding frequency bins on the various outputs by computer.
- Directional gain =  $5 \text{ dBi} + 10\log(2) = 8.01 \text{ dBi} > 6 \text{ dBi}$ , so the power density limit shall be reduced to  $11 - (8.01 - 6) = 8.99 \text{ dBm}$ .
- Refer to section 3.3 for duty cycle spectrum plot.

### 802.11ac (VHT80)

Channel	Frequency (MHz)	PSD (dBm/MHz)		Duty Factor (dB)	Total PSD with Duty Factor (dBm/MHz)	Max. Limit (dBm/MHz)	Pass / Fail
		Chain 0	Chain 1				
42	5210	-10.50	-10.57	1.22	-6.31	8.99	Pass
58	5290	-7.67	-7.76	1.22	-3.49	8.99	Pass
106	5530	-9.80	-9.88	1.22	-5.61	8.99	Pass
122	5610	-5.02	-5.11	1.22	-0.84	8.99	Pass
138	5690 (U-NII-2C)	-6.08	-5.76	1.22	-1.69	8.99	Pass

**Note:**

- Method 2) a) of power density measurement of KDB 662911 is using for calculating total power density. Total power density is summing entire spectra across corresponding frequency bins on the various outputs by computer.
- Directional gain =  $5 \text{ dBi} + 10\log(2) = 8.01 \text{ dBi} > 6 \text{ dBi}$ , so the power density limit shall be reduced to  $11 - (8.01 - 6) = 8.99 \text{ dBm}$ .
- Refer to section 3.3 for duty cycle spectrum plot.

### Spectrum Plot of Worst Value

#### 802.11a

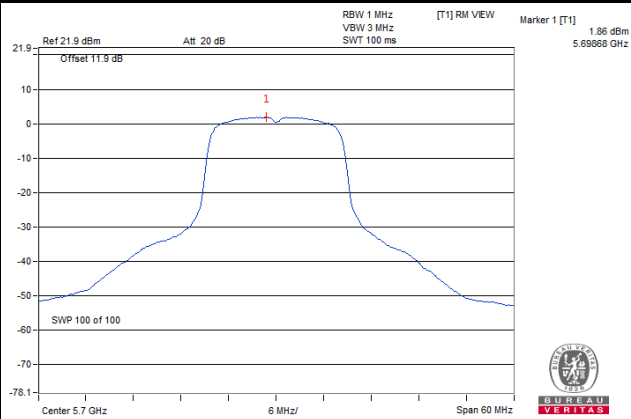

#### 802.11n (HT20)

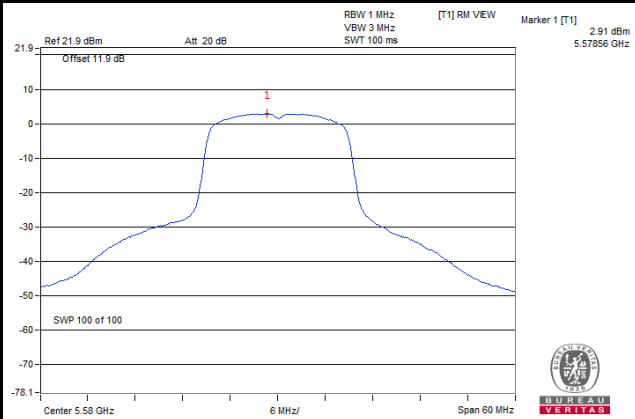

#### 802.11n (HT40)

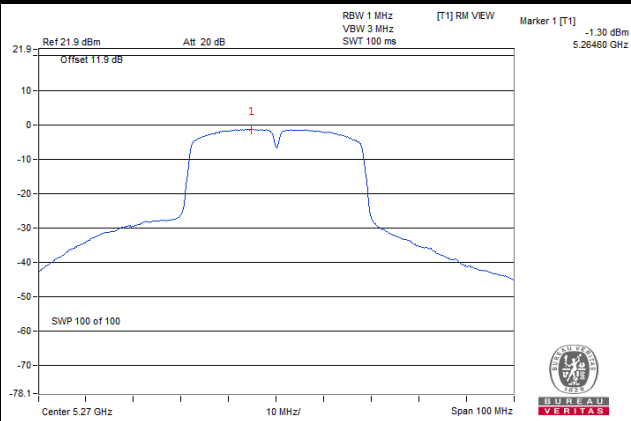

#### 802.11ac (VHT80)

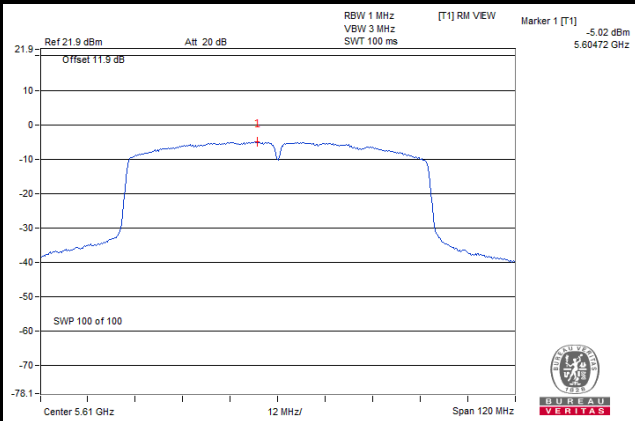

## For U-NII-3 Band

### 802.11a

Channel	Frequency (MHz)	PSD w/o Duty Factor		Duty Factor (dB)	PSD with Duty Factor (dBm/500 kHz)	Limit (dBm/500 kHz)	Pass / Fail
		(dBm/300 kHz)	(dBm/500 kHz)				
144	5720 (U-NII-3)	-5.00	-2.78	0.39	-2.39	30	Pass
149	5745	-3.27	-1.05	0.39	-0.66	30	Pass
157	5785	-3.42	-1.20	0.39	-0.81	30	Pass
165	5825	-3.14	-0.92	0.39	-0.53	30	Pass

**Note:** Refer to section 3.3 for duty cycle spectrum plot.

### 802.11n (HT20)

TX Chain	Channel	Frequency (MHz)	PSD w/o Duty Factor		10 log (N=2) dB	Duty Factor (dB)	Total PSD with Duty Factor (dBm/500 kHz)	Limit (dBm/500 kHz)	Pass / Fail
			(dBm/300 kHz)	(dBm/500 kHz)					
0	149	5745	-4.52	-2.30	3.01	0.39	1.10	27.99	Pass
	157	5785	-3.03	-0.81	3.01	0.39	2.59	27.99	Pass
	165	5825	-2.86	-0.64	3.01	0.39	2.76	27.99	Pass
1	149	5745	-2.79	-0.57	3.01	0.39	2.83	27.99	Pass
	157	5785	-3.89	-1.67	3.01	0.39	1.73	27.99	Pass
	165	5825	-1.82	0.40	3.01	0.39	3.80	27.99	Pass

**Note:**

- Method 2) a) of power density measurement of KDB 662911 is using for calculating total power density. Total power density is summing entire spectra across corresponding frequency bins on the various outputs by computer.
- Directional gain = 5 dBi + 10log(2) = 8.01 dBi > 6 dBi , so the power density limit shall be reduced to 30-(8.01-6) = 27.99 dBm.
- Refer to section 3.3 for duty cycle spectrum plot.

### 802.11n (HT40)

TX Chain	Channel	Frequency (MHz)	PSD w/o Duty Factor		10 log (N=2) dB	Duty Factor (dB)	Total PSD with Duty Factor (dBm/500 kHz)	Limit (dBm/500 kHz)	Pass / Fail
			(dBm/300 kHz)	(dBm/500 kHz)					
0	142	5710 (U-NII-3)	-10.75	-8.53	3.01	0.67	-4.85	27.99	Pass
	151	5755	-8.21	-5.99	3.01	0.67	-2.31	27.99	Pass
	159	5795	-7.86	-5.64	3.01	0.67	-1.96	27.99	Pass
1	142	5710 (U-NII-3)	-10.08	-7.86	3.01	0.67	-4.18	27.99	Pass
	151	5755	-7.71	-5.49	3.01	0.67	-1.81	27.99	Pass
	159	5795	-7.45	-5.23	3.01	0.67	-1.55	27.99	Pass

**Note:**

- Method 2) a) of power density measurement of KDB 662911 is using for calculating total power density. Total power density is summing entire spectra across corresponding frequency bins on the various outputs by computer.
- Directional gain = 5 dBi + 10log(2) = 8.01 dBi > 6 dBi , so the power density limit shall be reduced to 30-(8.01-6) = 27.99 dBm.
- Refer to section 3.3 for duty cycle spectrum plot.

### 802.11ac (VHT80)

TX Chain	Channel	Frequency (MHz)	PSD		10 log (N=2) dB	Duty Factor (dB)	Total PSD with Duty Factor (dBm/500 kHz)	Limit (dBm/500 kHz)	Pass / Fail
			(dBm/300 kHz)	(dBm/500 kHz)					
0	138	5690 (U-NII-3)	-15.63	-13.41	3.01	1.22	-9.18	27.99	Pass
	155	5775	-10.90	-8.68	3.01	1.22	-4.45	27.99	Pass
1	138	5690 (U-NII-3)	-15.20	-12.98	3.01	1.22	-8.75	27.99	Pass
	155	5775	-10.77	-8.55	3.01	1.22	-4.32	27.99	Pass

**Note:**

- Method 2) a) of power density measurement of KDB 662911 is using for calculating total power density. Total power density is summing entire spectra across corresponding frequency bins on the various outputs by computer.
- Directional gain = 5 dBi + 10log(2) = 8.01 dBi > 6 dBi , so the power density limit shall be reduced to 30-(8.01-6) = 27.99 dBm.
- Refer to section 3.3 for duty cycle spectrum plot.



### Spectrum Plot of Worst Value

#### 802.11a

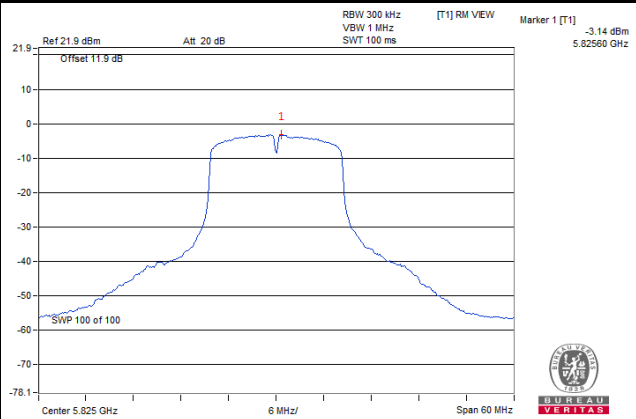

#### 802.11n (HT20)

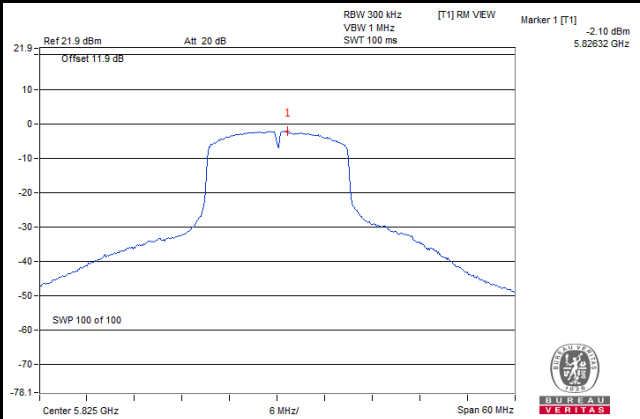

#### 802.11n (HT40)

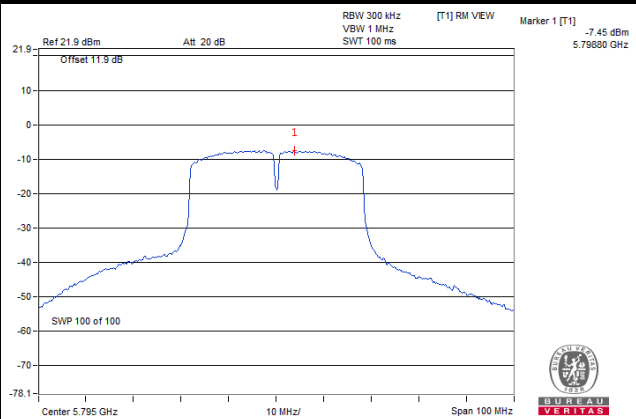

#### 802.11ac (VHT80)

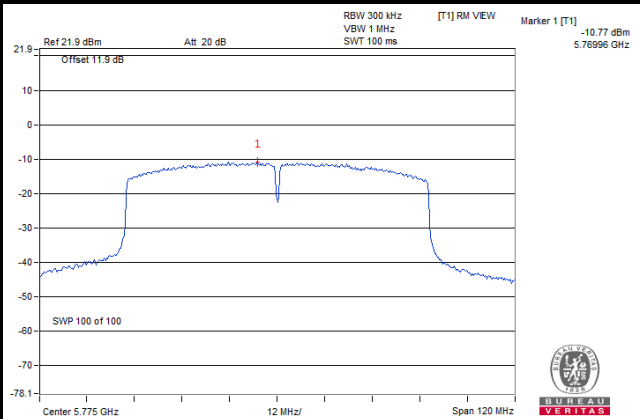

## 4.6 Frequency Stability

### 4.6.1 Limit of Frequency Stability Measurement

The frequency of the carrier signal shall be maintained within band of operation.

### 4.6.2 Test Setup

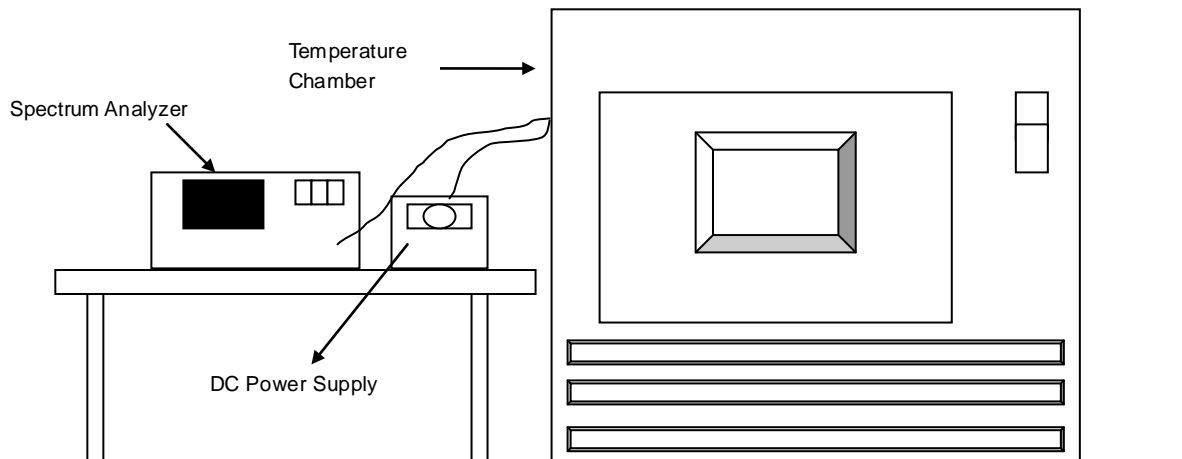

### 4.6.3 Test Instruments

Refer to section 4.1.3 to get information of above instrument.

### 4.6.4 Test Procedure

- To ensure emission at the band edge is maintained within the authorized band, those values shall be measured by radiation emissions at upper and lower frequency points, and finally compensated by frequency deviation as procedures below.
- The EUT was operated at the maximum output power, and connected to the spectrum analyzer, which is set to maximum hold function and peak detector. The peak value of the power envelope was measured and noted. The upper and lower frequency points were respectively measured relatively 10 dB lower than the measured peak value.
- The frequency deviation was calculated by adding the upper frequency point and the lower frequency point divided by two. Those detailed values of frequency deviation are provided in table below.

### 4.6.5 Deviation from Test Standard

No deviation.

### 4.6.6 EUT Operating Condition

Set the EUT transmit at un-modulation mode to test frequency stability.

#### 4.6.7 Test Results

Frequency Stability Versus Temp.									
Operating Frequency: 5180 MHz									
Temp. (°C)	Power Supply (Vdc)	0 Minute		2 Minute		5 Minute		10 Minute	
		Measured Frequency (MHz)	Result	Measured Frequency (MHz)	Result	Measured Frequency (MHz)	Result	Measured Frequency (MHz)	Result
85	3.3	5179.987	PASS	5179.9847	PASS	5179.9861	PASS	5179.9869	PASS
80	3.3	5180.0032	PASS	5180.0036	PASS	5180.003	PASS	5180.0027	PASS
70	3.3	5179.9836	PASS	5179.9836	PASS	5179.9827	PASS	5179.9839	PASS
60	3.3	5180.0066	PASS	5180.0073	PASS	5180.0093	PASS	5180.0093	PASS
50	3.3	5180.0172	PASS	5180.0185	PASS	5180.017	PASS	5180.0179	PASS
40	3.3	5179.9835	PASS	5179.984	PASS	5179.9798	PASS	5179.9842	PASS
30	3.3	5179.993	PASS	5179.9924	PASS	5179.9903	PASS	5179.9885	PASS
20	3.3	5179.9868	PASS	5179.9831	PASS	5179.9859	PASS	5179.9836	PASS
10	3.3	5180.0157	PASS	5180.0176	PASS	5180.0193	PASS	5180.0162	PASS
0	3.3	5180.0194	PASS	5180.0193	PASS	5180.0216	PASS	5180.0188	PASS
-10	3.3	5179.9984	PASS	5180.001	PASS	5180.0034	PASS	5180.0026	PASS
-20	3.3	5180.0205	PASS	5180.0182	PASS	5180.0198	PASS	5180.0179	PASS
-30	3.3	5179.9932	PASS	5179.9892	PASS	5179.9937	PASS	5179.9903	PASS
-40	3.3	5179.987	PASS	5179.9901	PASS	5179.9886	PASS	5179.9901	PASS

Frequency Stability Versus Voltage									
Operating Frequency: 5180 MHz									
Temp. (°C)	Power Supply (Vdc)	0 Minute		2 Minute		5 Minute		10 Minute	
		Measured Frequency (MHz)	Result	Measured Frequency (MHz)	Result	Measured Frequency (MHz)	Result	Measured Frequency (MHz)	Result
20	3.795	5179.9876	PASS	5179.9823	PASS	5179.9866	PASS	5179.9844	PASS
	3.3	5179.9868	PASS	5179.9831	PASS	5179.9859	PASS	5179.9836	PASS
	2.805	5179.9867	PASS	5179.9837	PASS	5179.9849	PASS	5179.9826	PASS

## 4.7 6 dB Bandwidth Measurement

### 4.7.1 Limits of 6 dB Bandwidth Measurement

The minimum of 6 dB Bandwidth Measurement is 0.5 MHz.

### 4.7.2 Test Setup



### 4.7.3 Test Instruments

Refer to section 4.1.3 to get information of above instrument.

### 4.7.4 Test Procedure

#### MEASUREMENT PROCEDURE REF

- Set resolution bandwidth (RBW) = 100 kHz
- Set the video bandwidth (VBW)  $\geq 3 \times$  RBW, Detector = Peak.
- Trace mode = max hold.
- Sweep = auto couple.
- Measure the maximum width of the emission that is constrained by the frequencies associated with the two amplitude points (upper and lower) that are attenuated by 6 dB relative to the maximum level measured in the fundamental emission

### 4.7.5 Deviation from Test Standard

No deviation.

### 4.7.6 EUT Operating Condition

The software provided by client to enable the EUT under transmission condition continuously at lowest, middle and highest channel frequencies individually.

## 4.7.7 Test Results

## 802.11a

Channel	Frequency (MHz)	6 dB Bandwidth (MHz)	Minimum Limit (MHz)	Pass / Fail
144	5720 (U-NII-3)	2.57	0.5	Pass
149	5745	15.14	0.5	Pass
157	5785	15.14	0.5	Pass
165	5825	15.15	0.5	Pass

## 802.11n (HT20)

Channel	Frequency (MHz)	6 dB Bandwidth (MHz)		Minimum Limit (MHz)	Pass / Fail
		Chain 0	Chain 1		
144	5720 (U-NII-3)	2.62	2.63	0.5	Pass
149	5745	15.15	15.19	0.5	Pass
157	5785	15.16	15.19	0.5	Pass
165	5825	15.14	15.20	0.5	Pass

## 802.11n (HT40)

Channel	Frequency (MHz)	6 dB Bandwidth (MHz)		Minimum Limit (MHz)	Pass / Fail
		Chain 0	Chain 1		
142	5710 (U-NII-3)	2.63	2.63	0.5	Pass
151	5755	35.18	35.24	0.5	Pass
159	5795	35.26	35.21	0.5	Pass

## 802.11ac (VHT80)

Channel	Frequency (MHz)	6 dB Bandwidth (MHz)		Minimum Limit (MHz)	Pass / Fail
		Chain 0	Chain 1		
138	5690 (U-NII-3)	2.60	2.61	0.5	Pass
155	5775	75.29	75.29	0.5	Pass

### Spectrum Plot of Worst Value

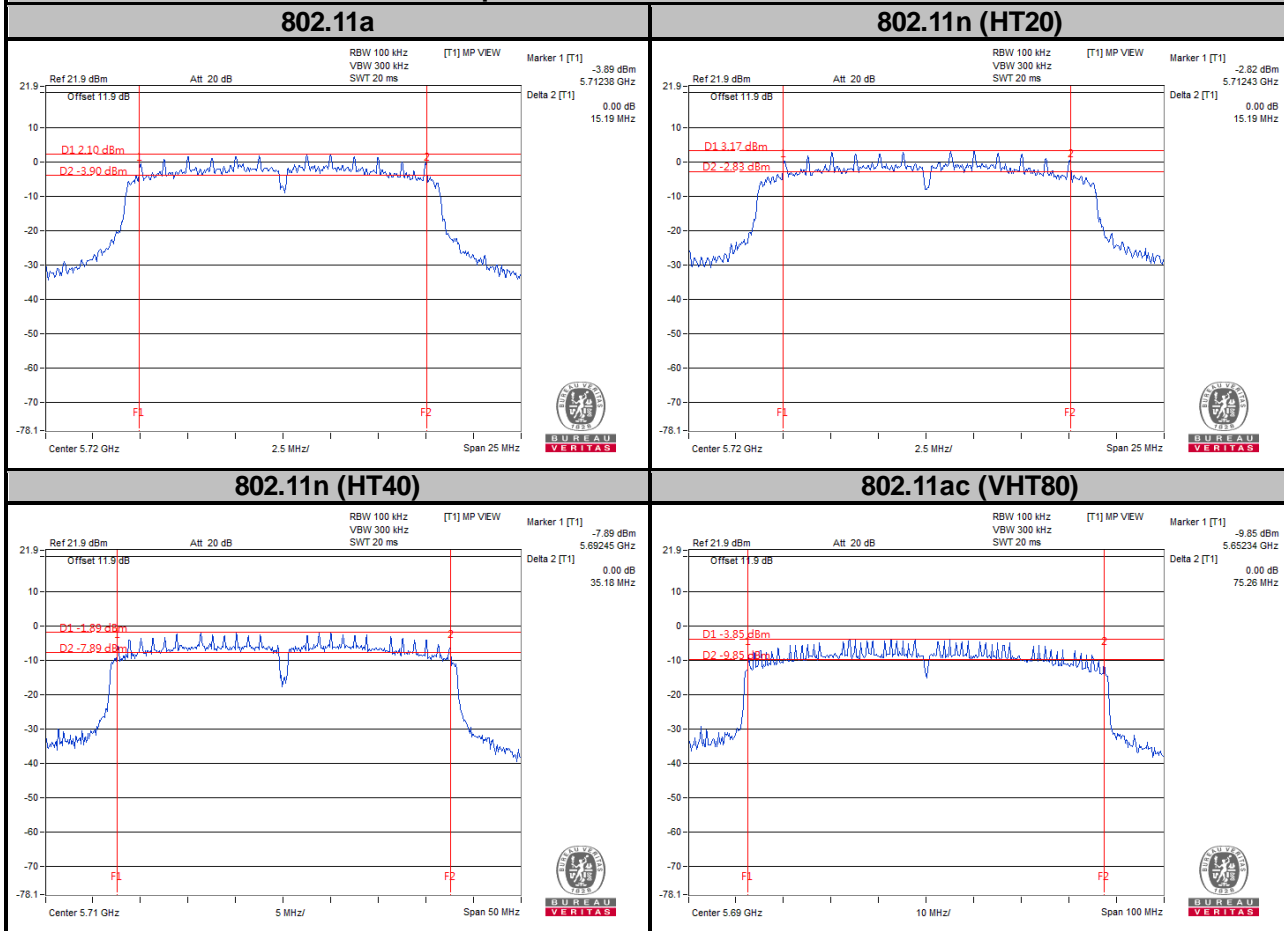

**Note:**

For Ch114 (UNII-3 Band): The 6 dB bandwidth above 5725 MHz = Marker 1 + Delta 2 – 5725 MHz  
 For Ch142 (UNII-3 Band): The 6 dB bandwidth above 5725 MHz = Marker 1 + Delta 2 – 5725 MHz  
 For Ch138 (UNII-3 Band): The 6 dB bandwidth above 5725 MHz = Marker 1 + Delta 2 – 5725 MHz

## 5 Pictures of Test Arrangements

Please refer to the attached file (Test Setup Photo).

# Annex A- Radiated Out of Band Emission (OOBE) Measurement (For U-NII-3 band)

## 802.11a

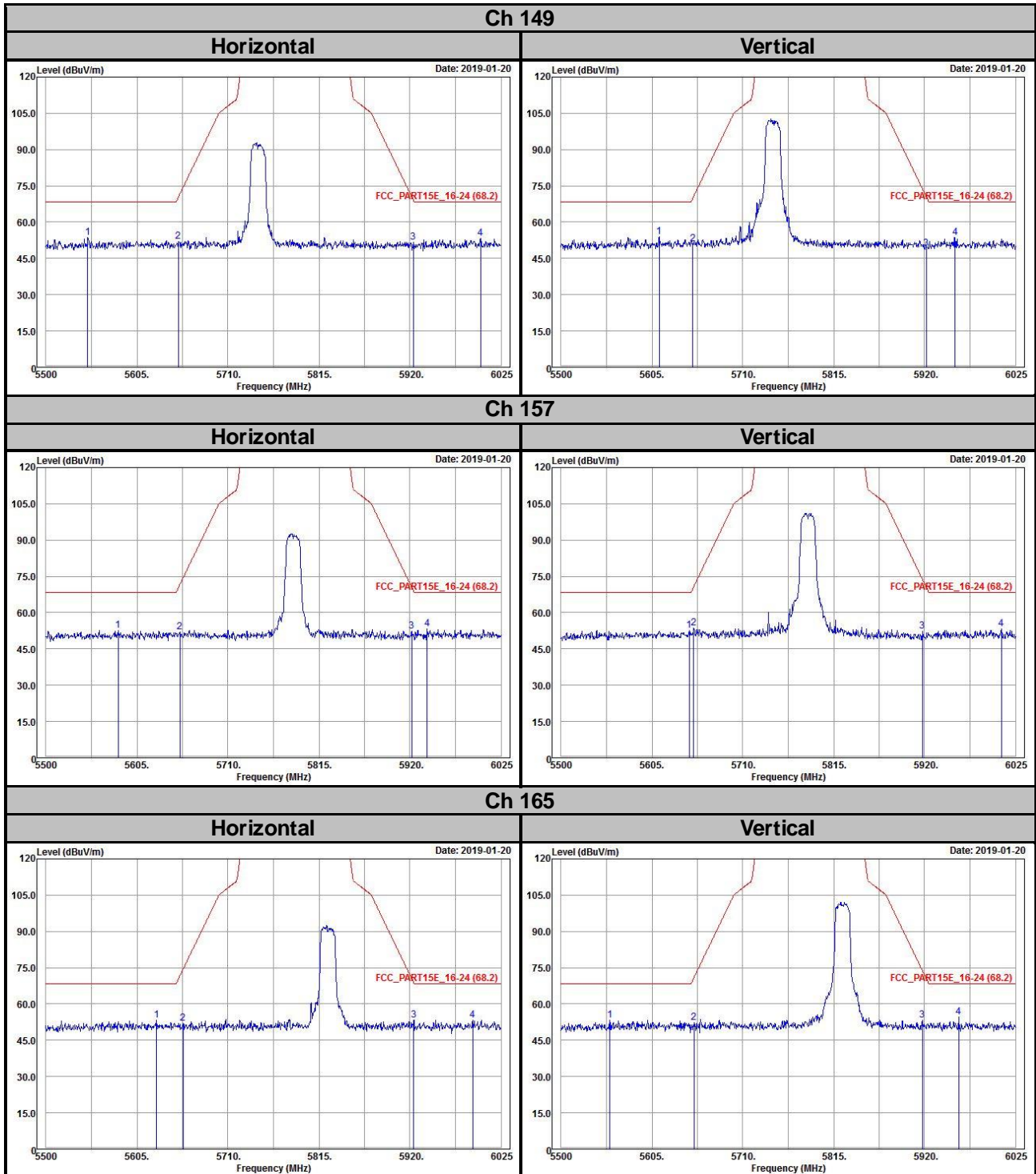



802.11n (HT20)

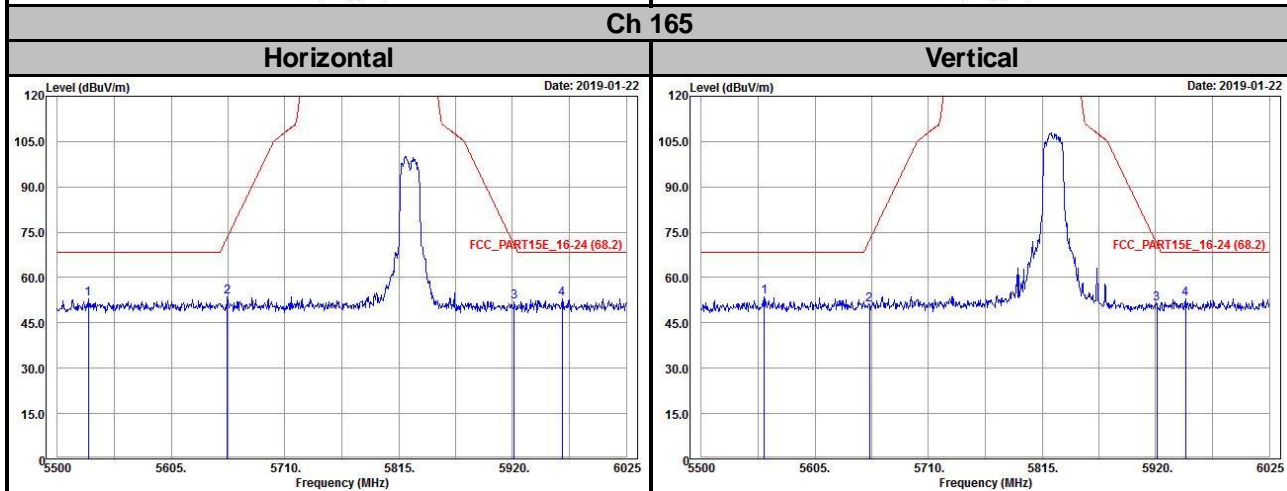
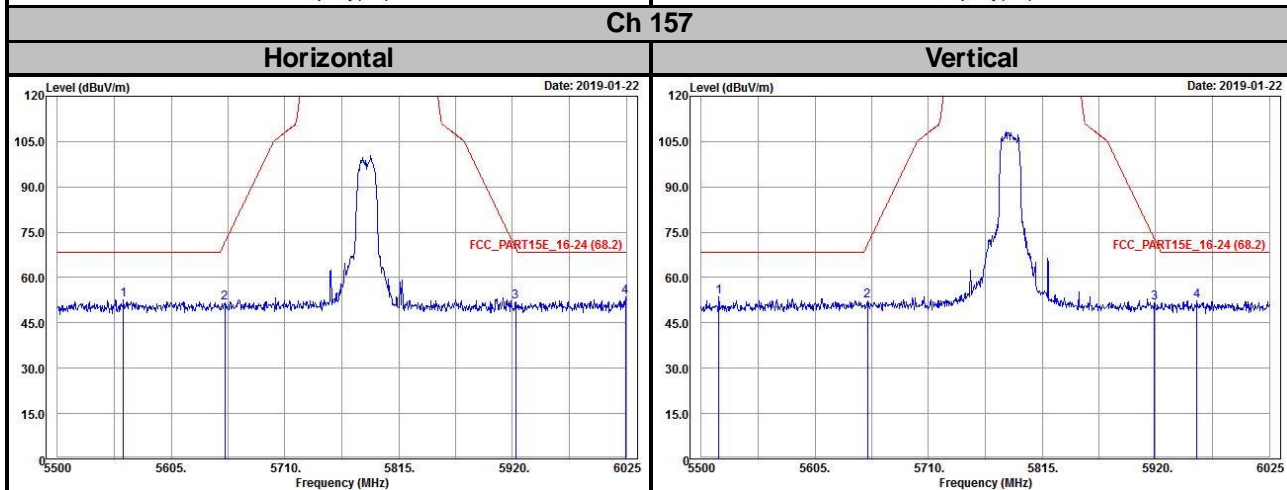
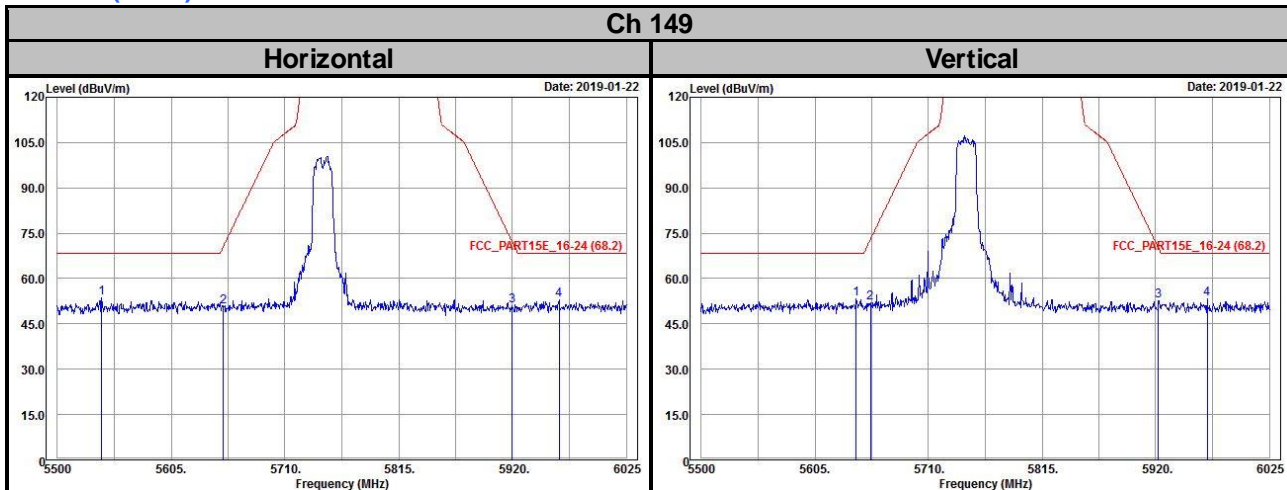

### 802.11n (HT40)

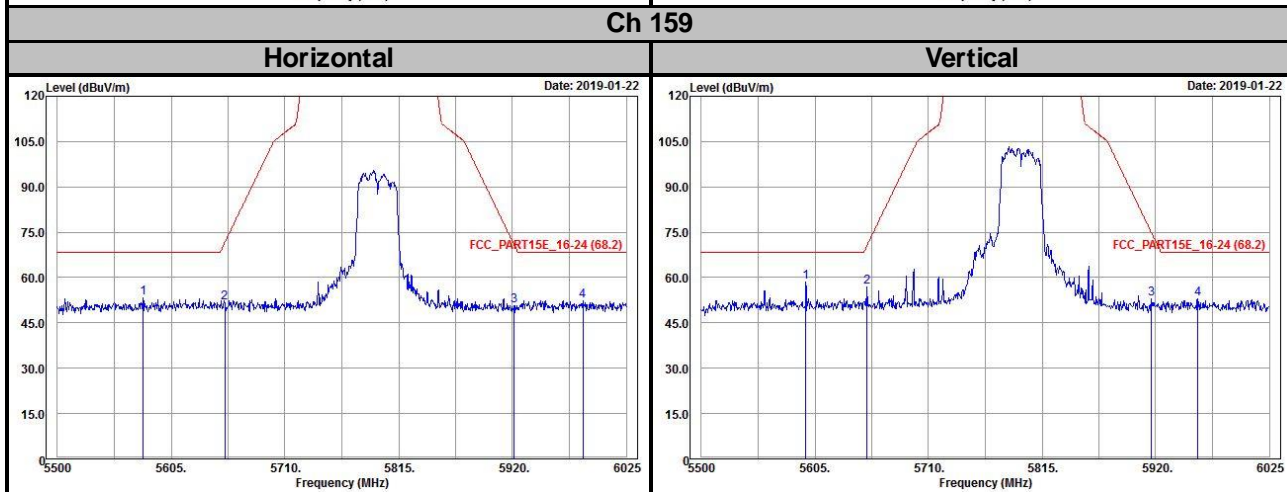
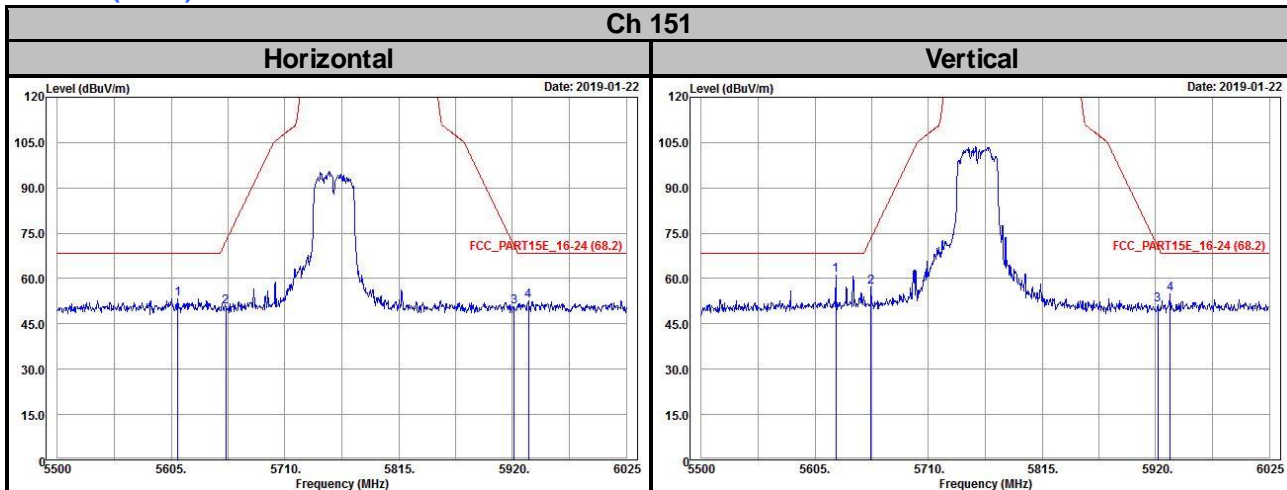

### 802.11ac (VHT80)

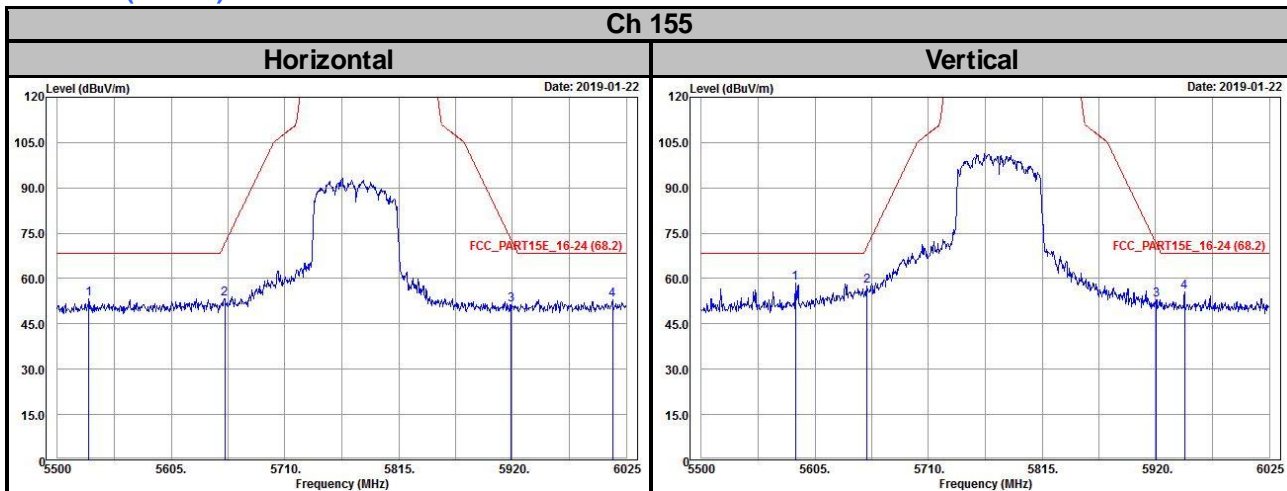

## Appendix – Information of the Testing Laboratories

We, Bureau Veritas Consumer Products Services (H.K.) Ltd., Taoyuan Branch, were founded in 1988 to provide our best service in EMC, Radio, Telecom and Safety consultation. Our laboratories are FCC recognized accredited test firms and accredited according to ISO/IEC 17025.

If you have any comments, please feel free to contact us at the following:

**Linko EMC/RF Lab**

Tel: 886-2-26052180

Fax: 886-2-26051924

**Hsin Chu EMC/RF/Telecom Lab**

Tel: 886-3-6668565

Fax: 886-3-6668323

**Hwa Ya EMC/RF/Safety**

Tel: 886-3-3183232

Fax: 886-3-3270892

**Email:** [service.adt@tw.bureauveritas.com](mailto:service.adt@tw.bureauveritas.com)

**Web Site:** [www.bureauveritas-adt.com](http://www.bureauveritas-adt.com)

The address and road map of all our labs can be found in our web site also.

--- END ---