

Figure 6-56 Spurious Emissions 2110.7MHz TX2_64QAM 1.4MHz Band Edge (ACP 15kHz -550kHz)

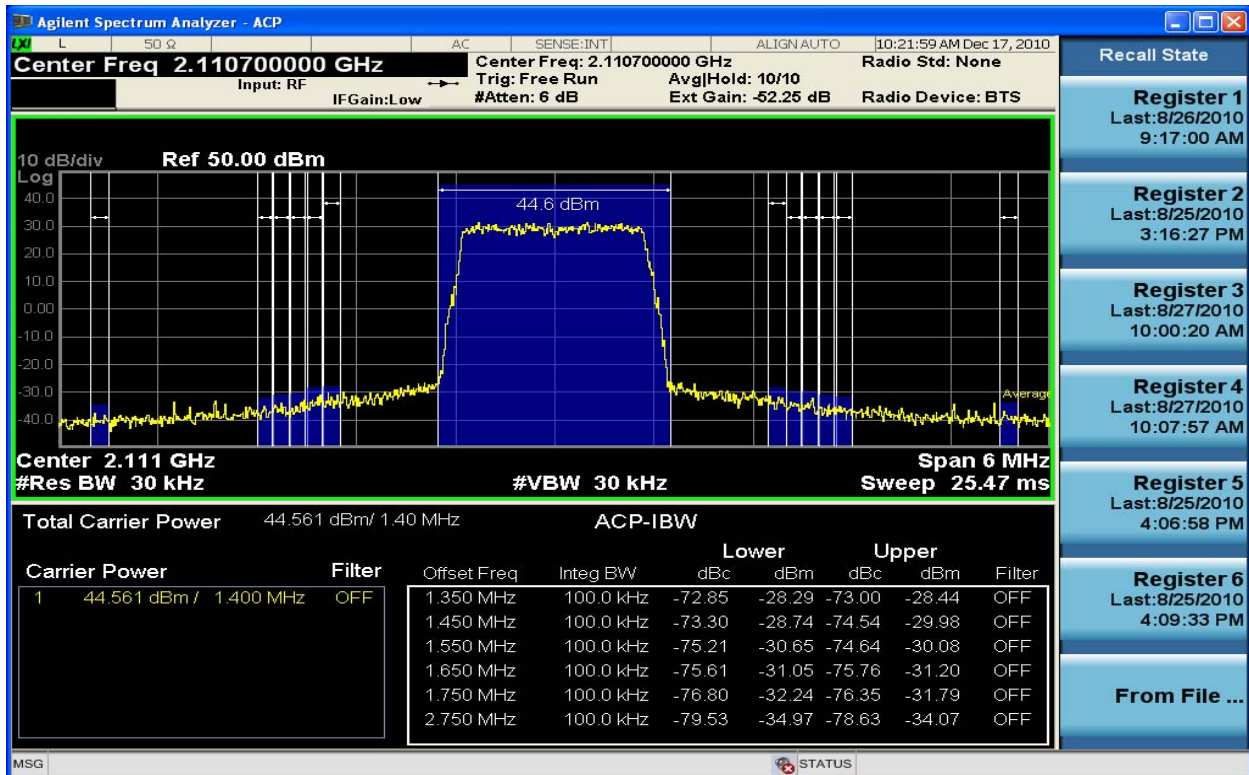

Figure 6-57 Spurious Emissions 2110.7MHz TX2_64QAM 1.4MHz Band Edge (ACP 650kHz - 2MHz)

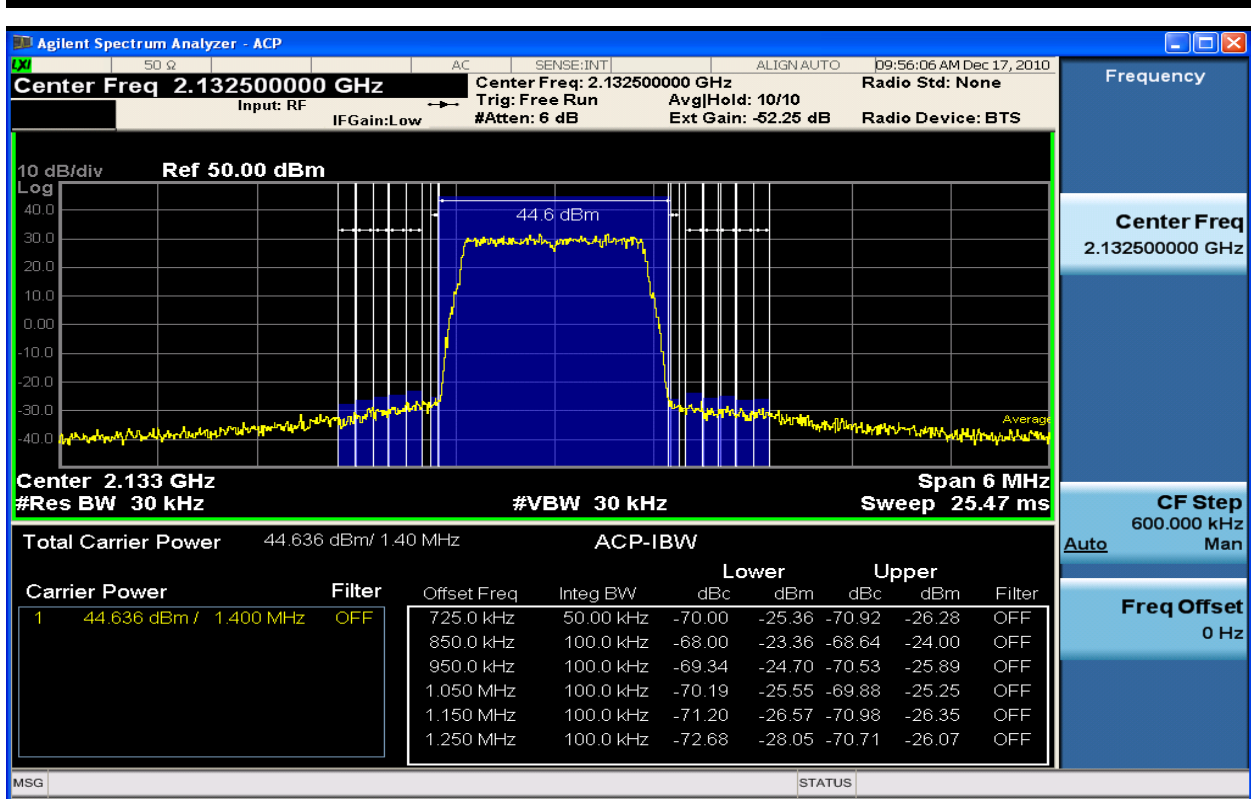

Figure 6-58 Spurious Emissions 2132.5MHz TX1_QPSK 1.4MHz Band Edge (ACP 15kHz – 550kHz)

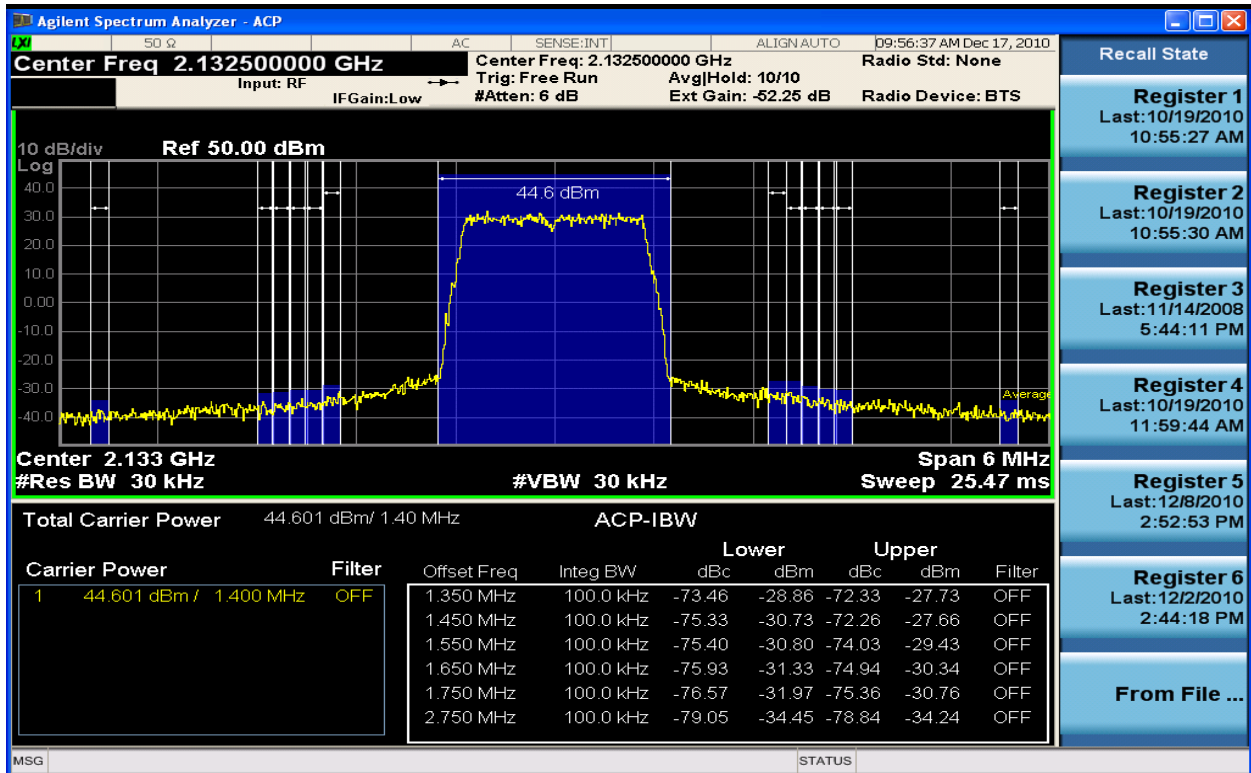

Figure 6-59 Spurious Emissions 2132.5MHz TX1_QPSK 1.4MHz Band Edge (ACP 650kHz – 2MHz)

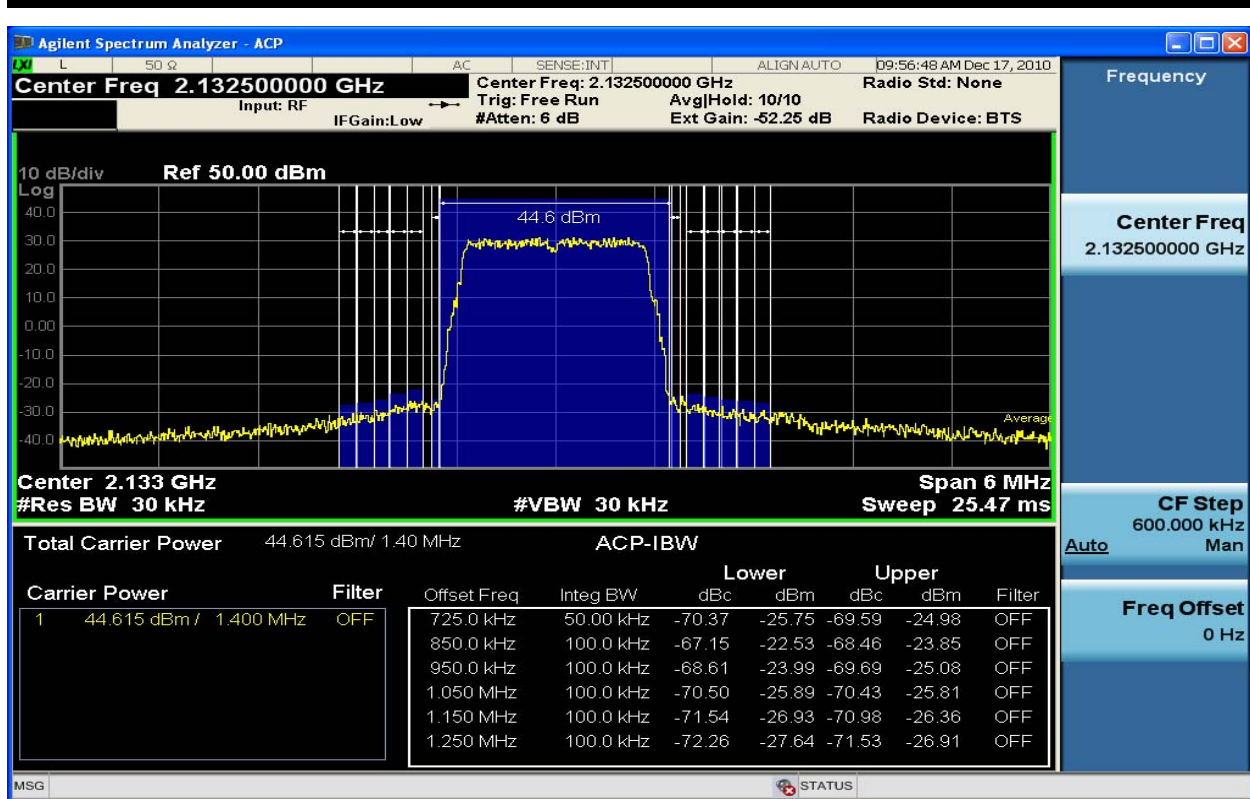

Figure 6-60 Spurious Emissions 2132.5MHz TX2_QPSK 1.4MHz Band Edge (ACP 15kHz – 550kHz)

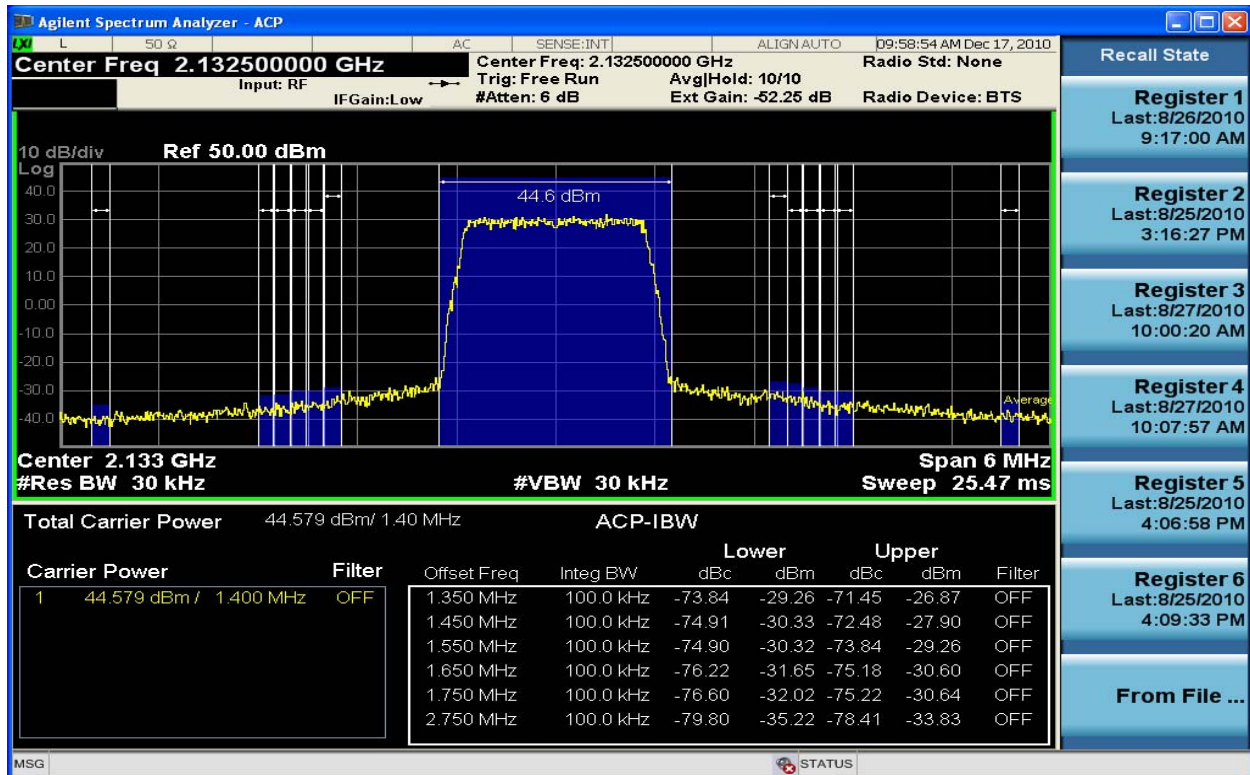

Figure 6-61 Spurious Emissions 2132.5MHz TX2_QPSK 1.4MHz Band Edge (ACP 650kHz – 2MHz)

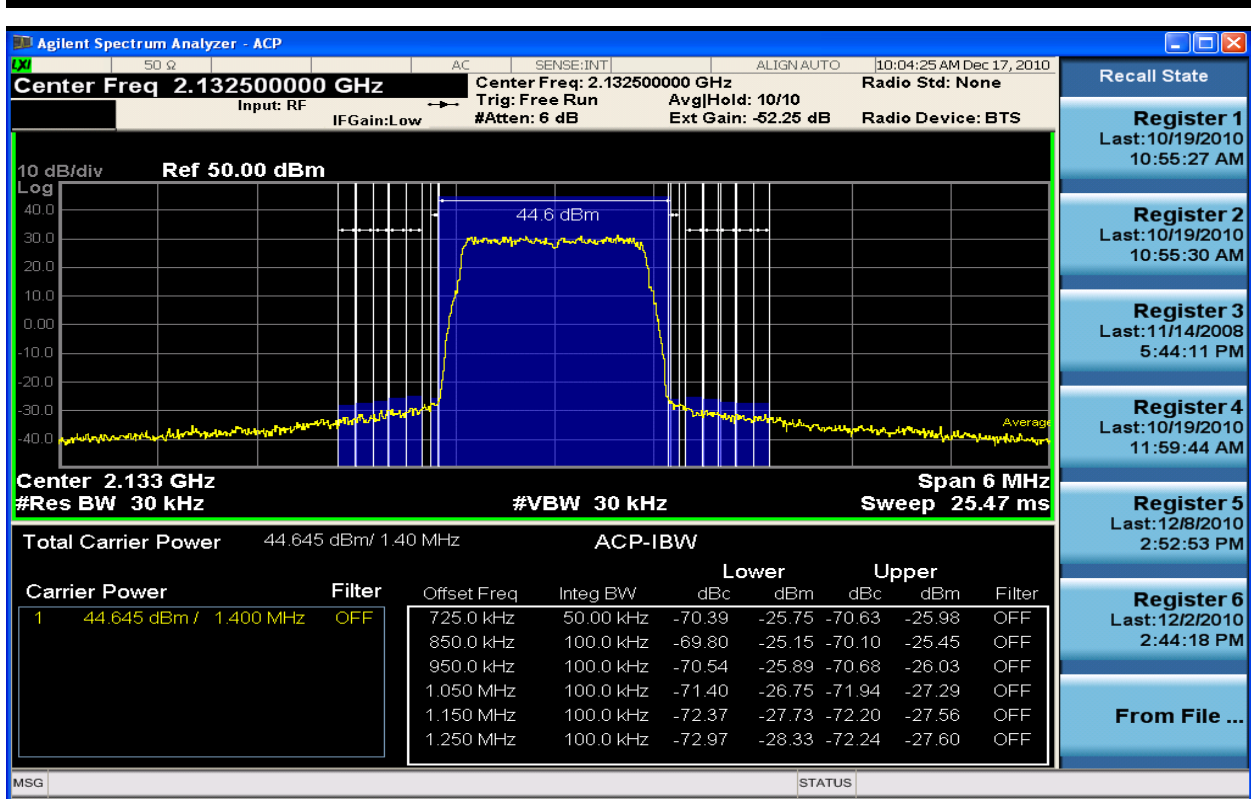

Figure 6-62 Spurious Emissions 2132.5MHz TX1_16QAM 1.4MHz Band Edge (ACP 15kHz – 550kHz)

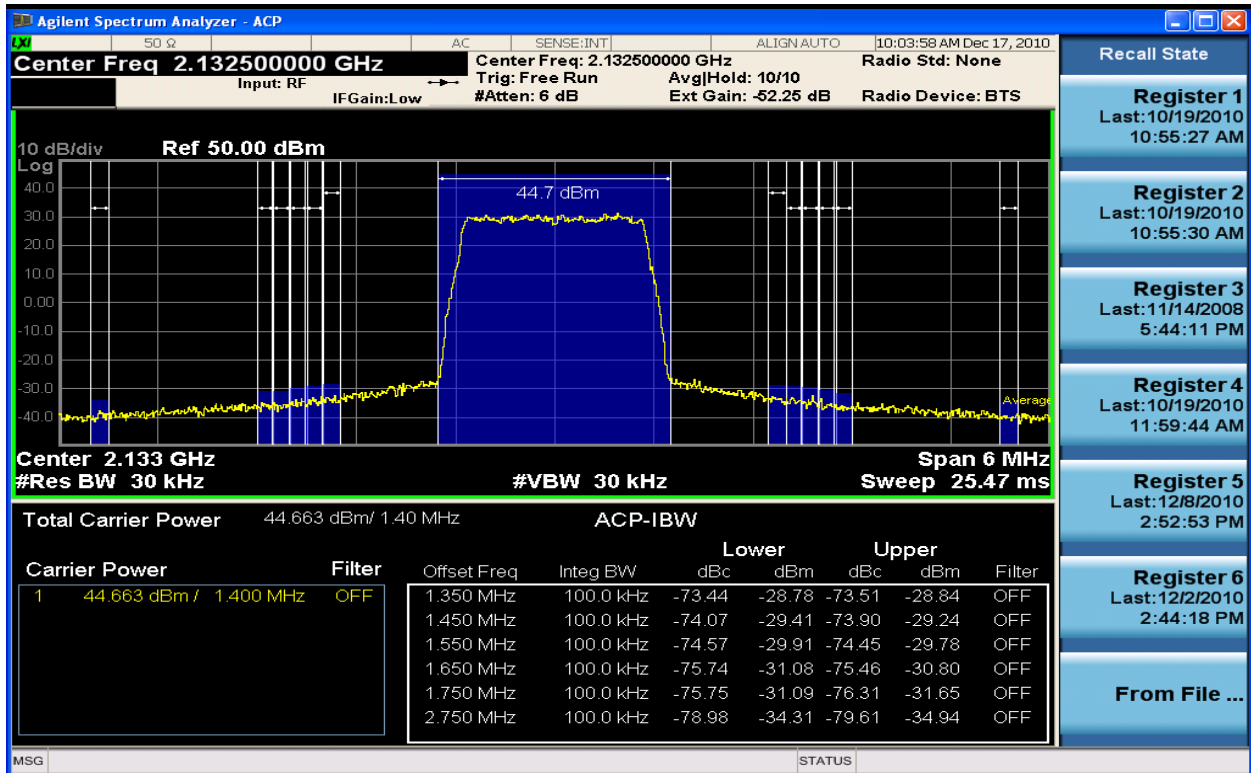

Figure 6-63 Spurious Emissions 2132.5MHz TX1_16QAM 1.4MHz Band Edge (ACP 650kHz – 2MHz)

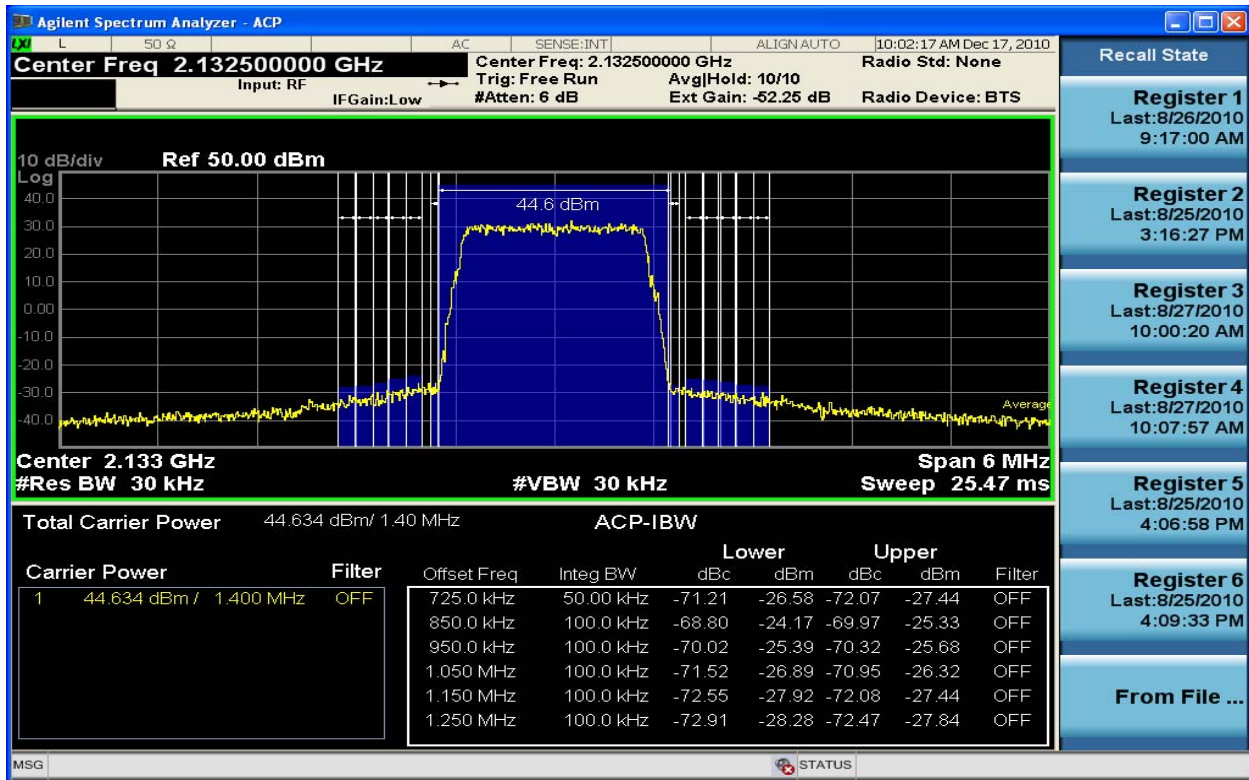

Figure 6-64 Spurious Emissions 2132.5MHz TX2_16QAM 1.4MHz Band Edge (ACP 15kHz – 550kHz)

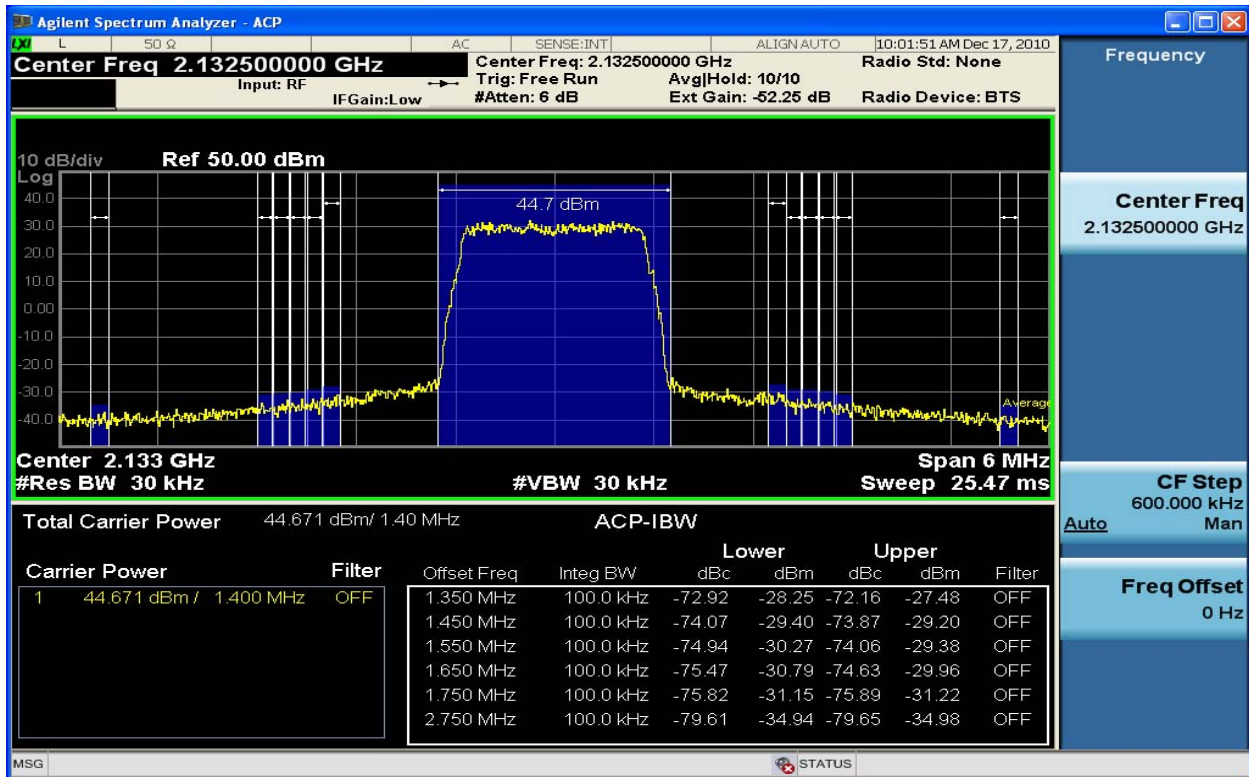

Figure 6-65 Spurious Emissions 2132.5MHz TX2_16QAM 1.4MHz Band Edge (ACP 650kHz – 2MHz)

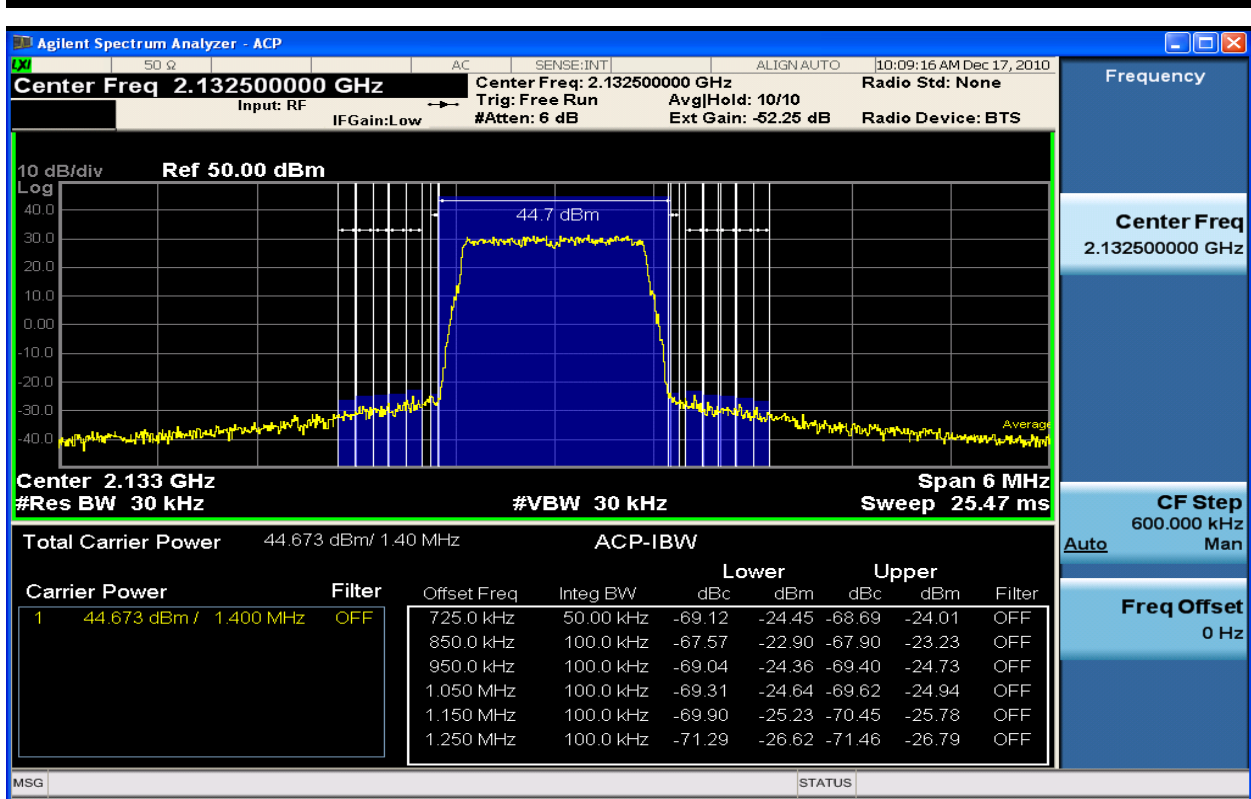

Figure 6-66 Spurious Emissions 2132.5MHz TX1_64QAM 1.4MHz Band Edge (ACP 15kHz – 550kHz)

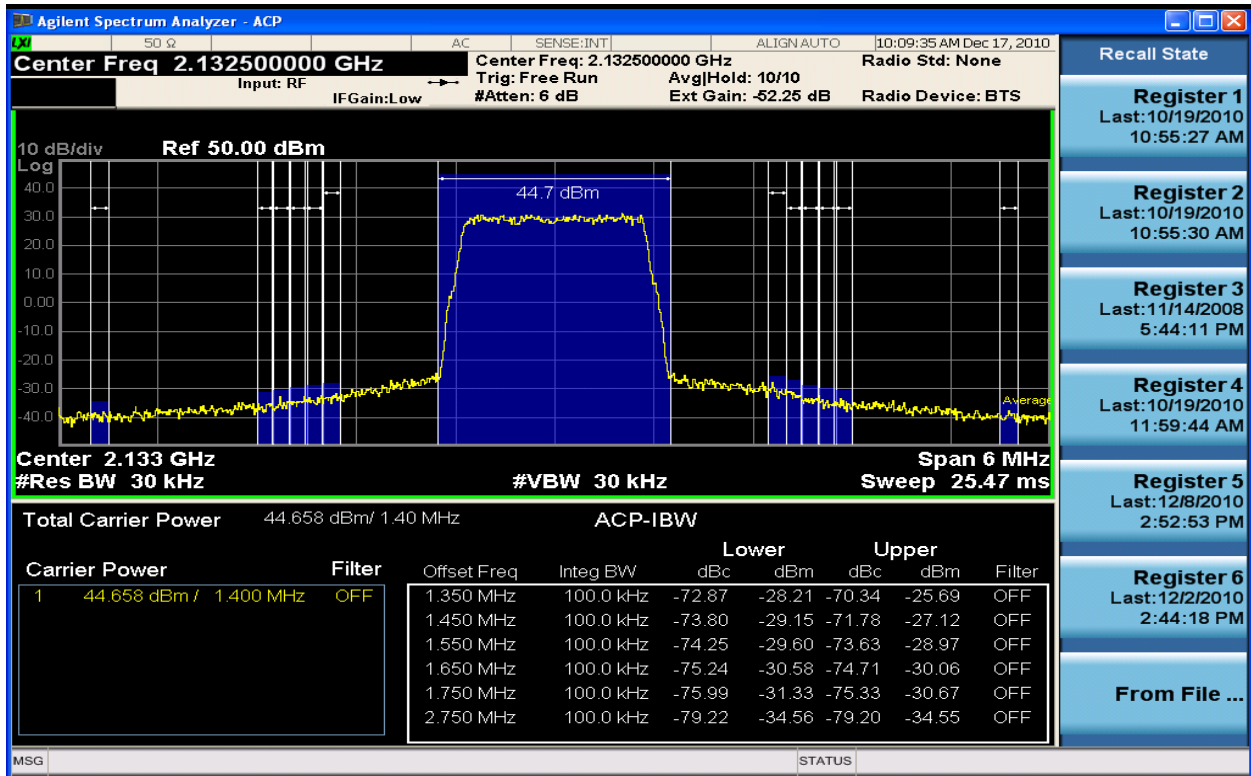

Figure 6-67 Spurious Emissions 2132.5MHz TX1_64QAM 1.4MHz Band Edge (ACP 650kHz – 2MHz)

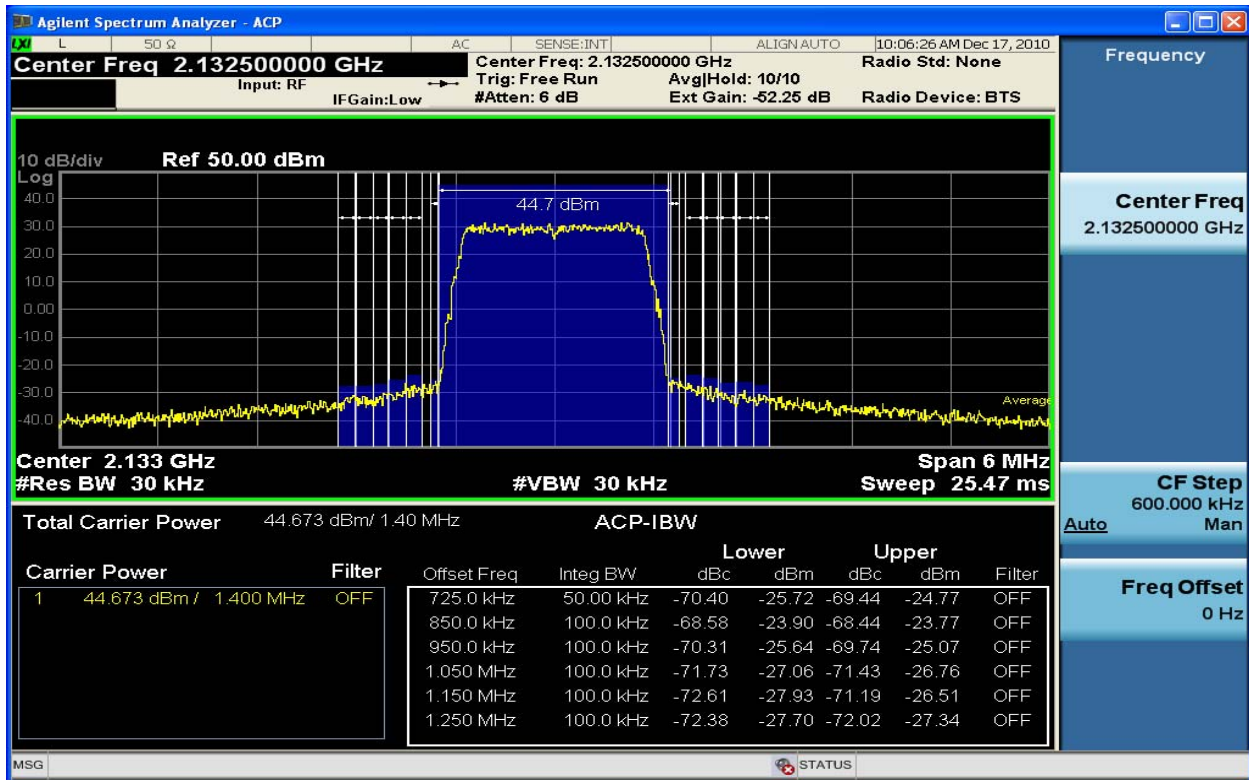

Figure 6-68 Spurious Emissions 2132.5MHz TX2_64QAM 1.4MHz Band Edge (ACP 15kHz – 550kHz)

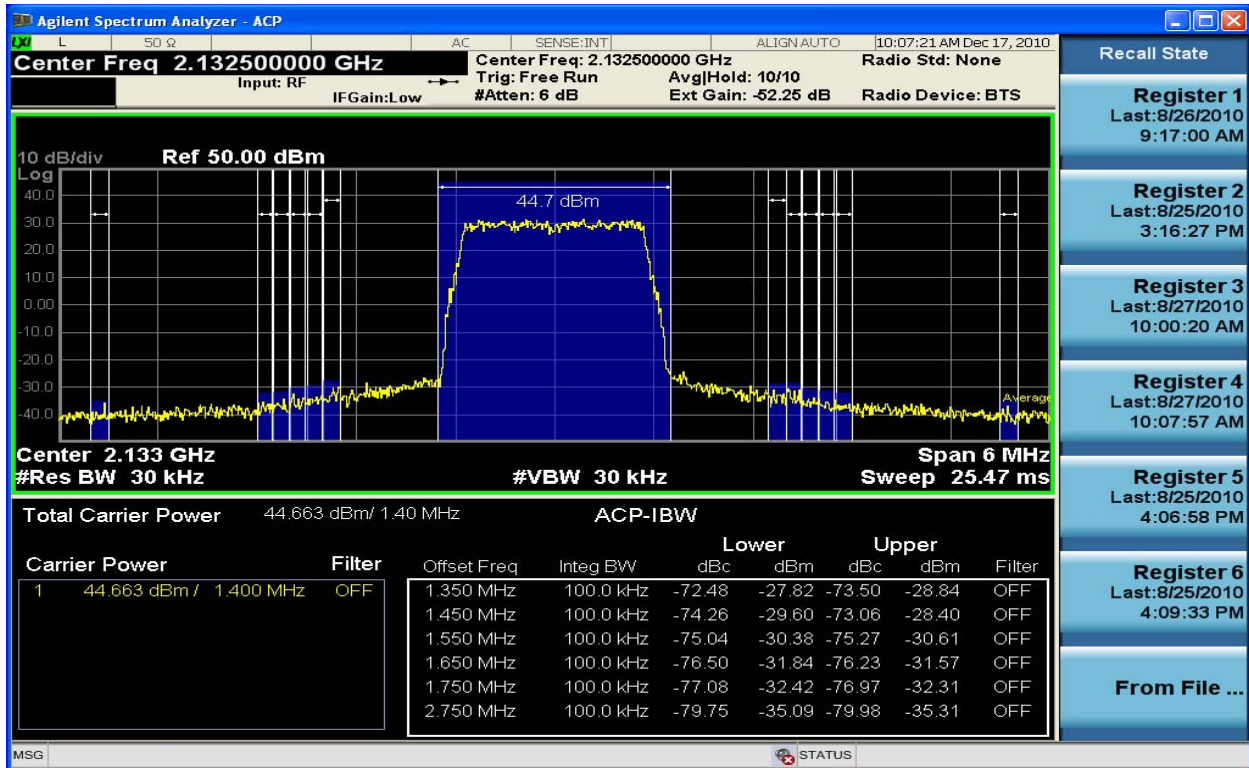

Figure 6-69 Spurious Emissions 2132.5MHz TX2_64QAM 1.4MHz Band Edge (ACP 650kHz – 2MHz)

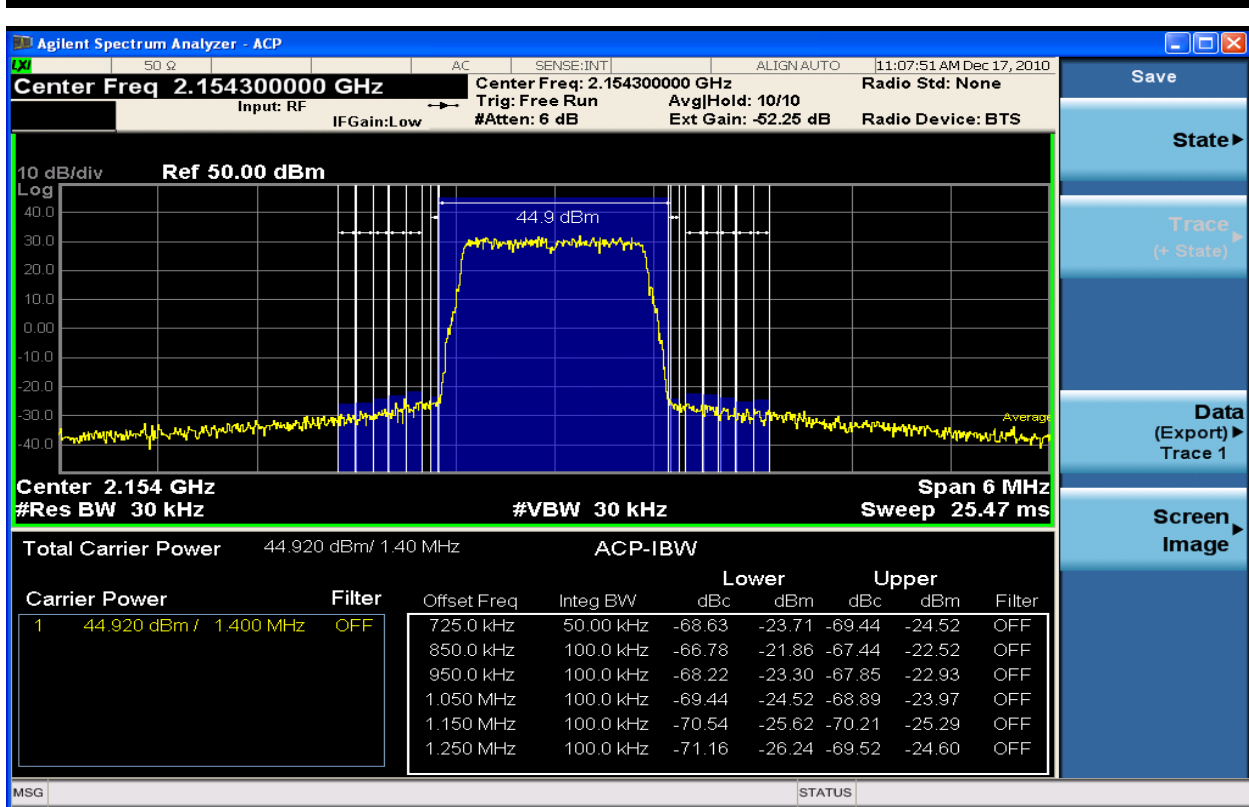

Figure 6-70 Spurious Emissions 2154.3MHz TX1_QPSK 1.4MHz Band Edge (ACP 15kHz – 550KHz)

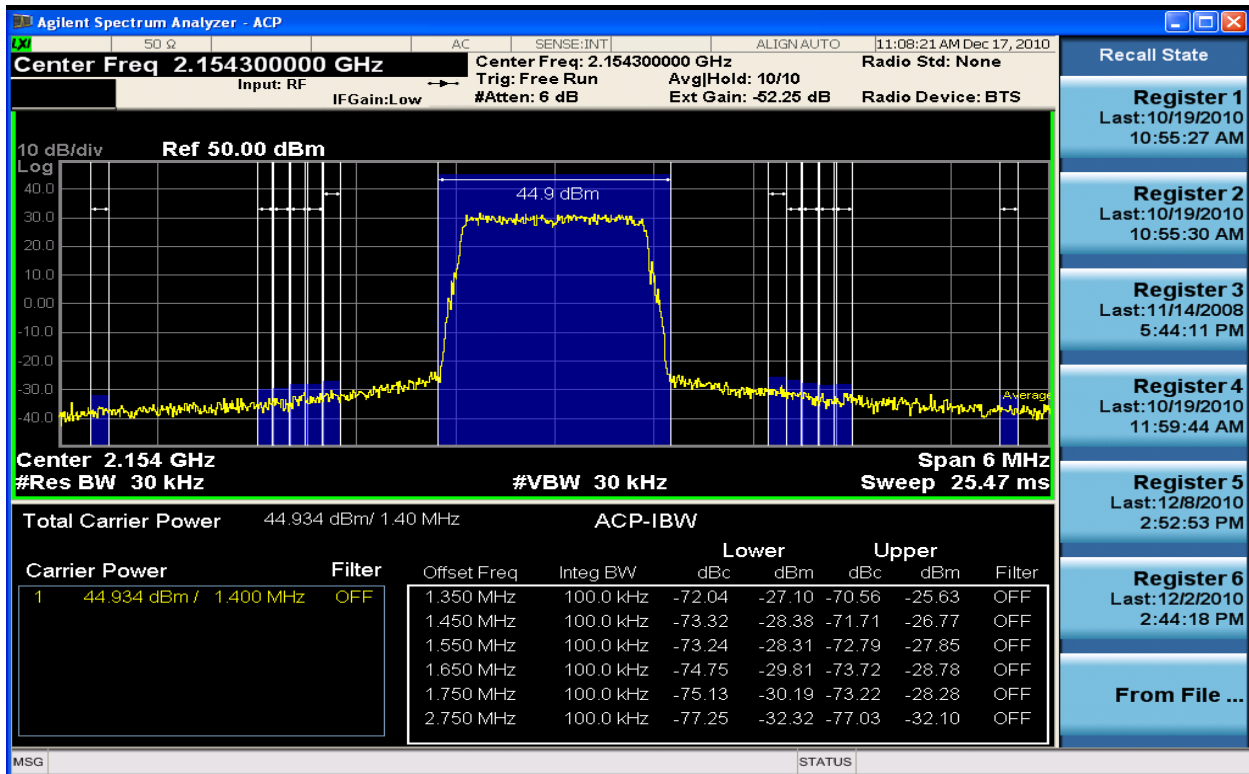

Figure 6-71 Spurious Emissions 2154.3MHz TX1_QPSK 1.4MHz Band Edge (ACP 650kHz – 2MHz)

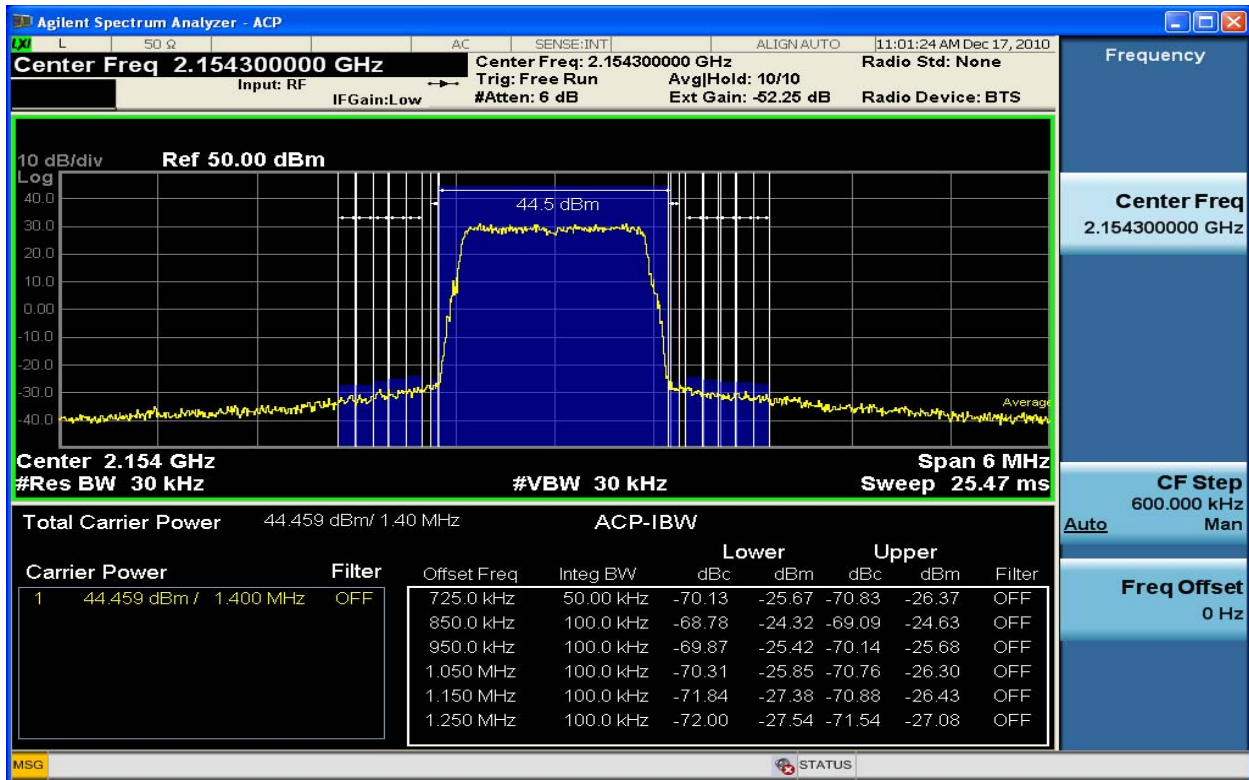

Figure 6-72 Spurious Emissions 2154.3MHz TX2_QPSK 1.4MHz Band Edge (ACP 15kHz – 550kHz)

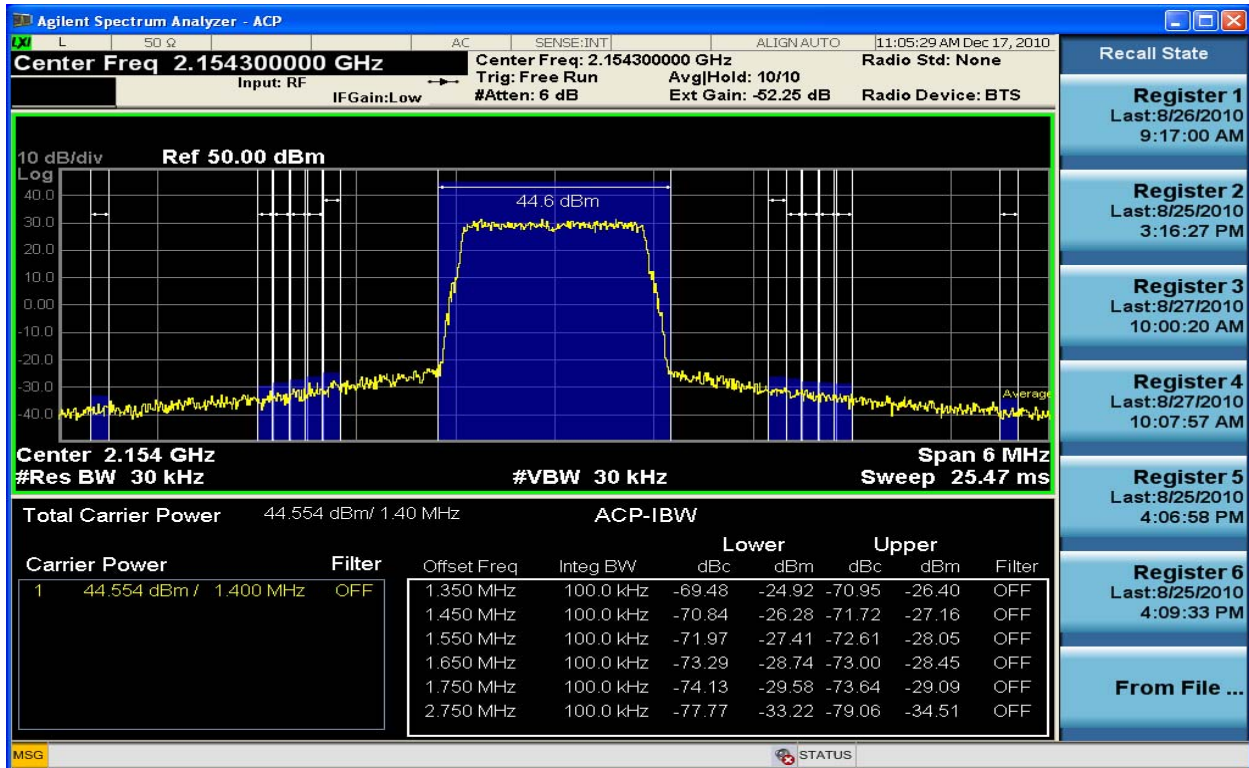

Figure 6-73 Spurious Emissions 2154.3MHz TX2_QPSK 1.4MHz Band Edge (ACP 650kHz – 2MHz)

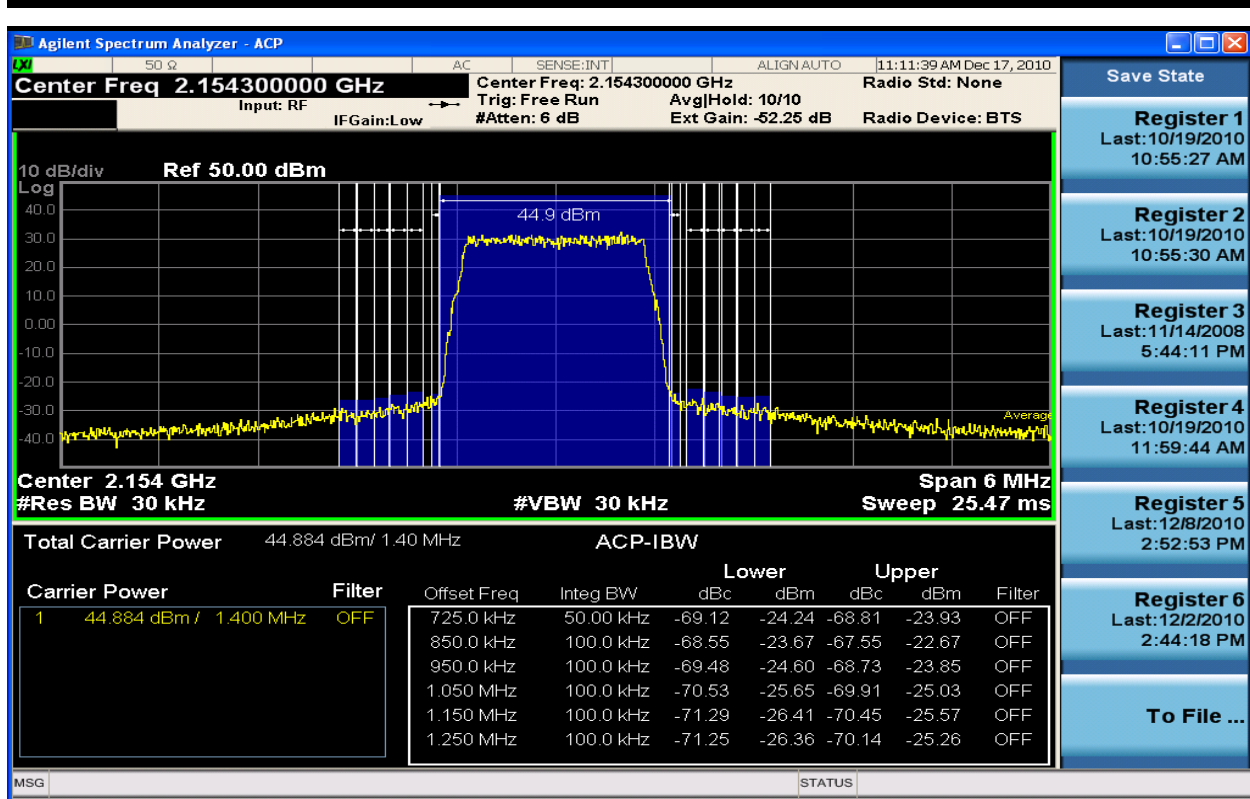

Figure 6-74 Spurious Emissions 2154.3MHz TX1_16QAM 1.4MHz Band Edge (ACP 15kHz – 550KHz)

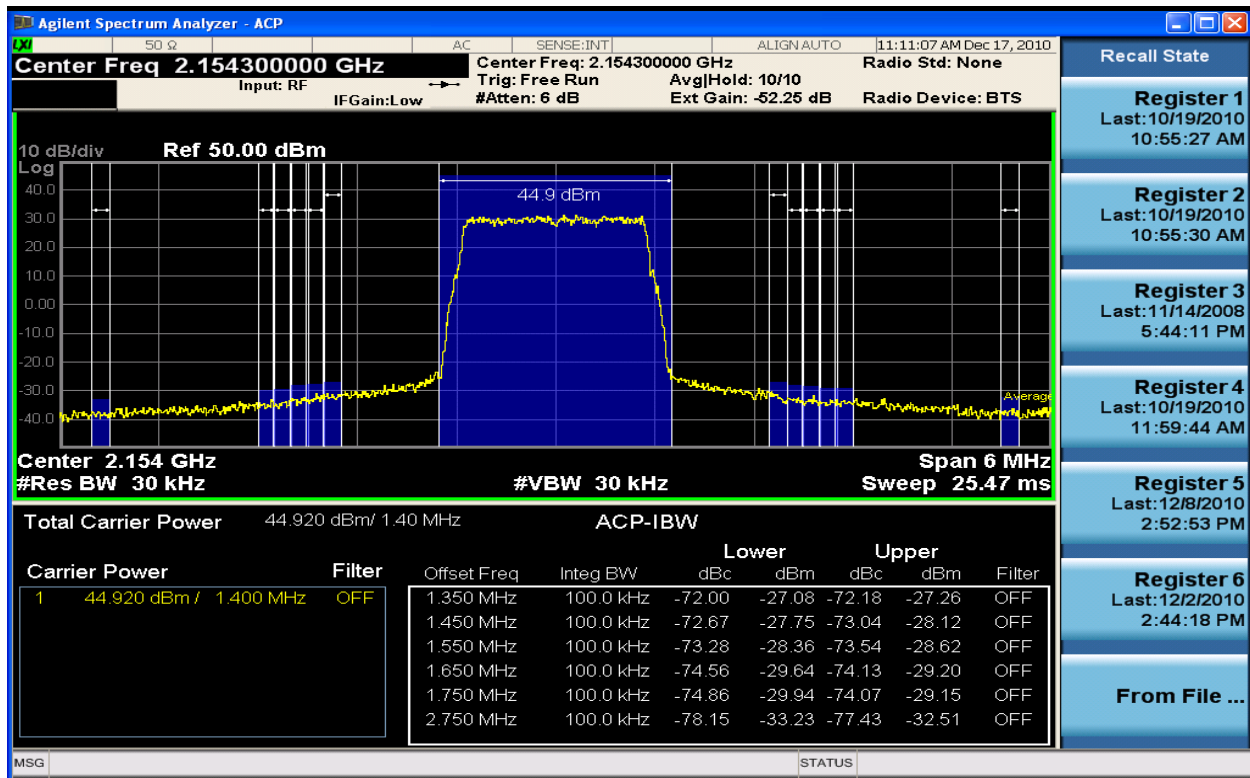

Figure 6-75 Spurious Emissions 2154.3MHz TX1_16QAM 1.4MHz Band Edge (ACP 650KHz – 2MHz)

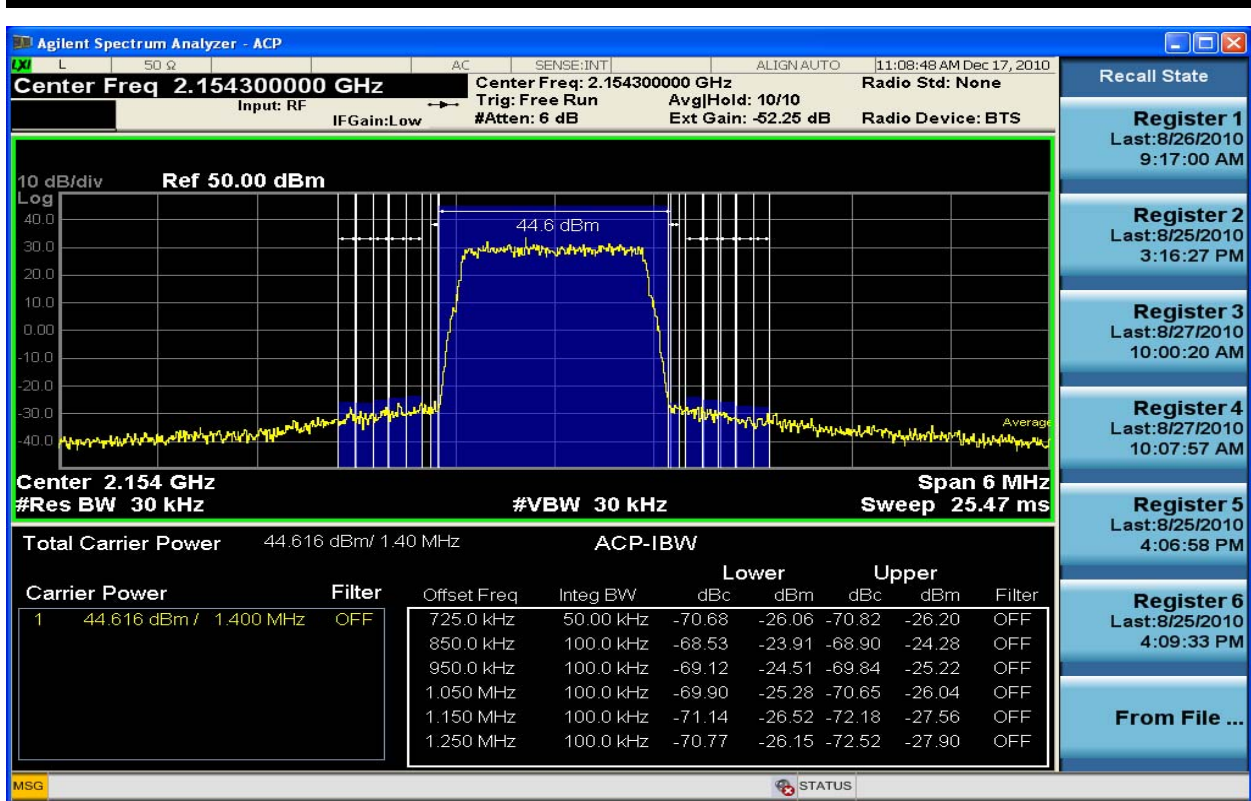

Figure 6-76 Spurious Emissions 2154.3MHz TX2_16QAM 1.4MHz Band Edge (ACP 15kHz – 550KHz)

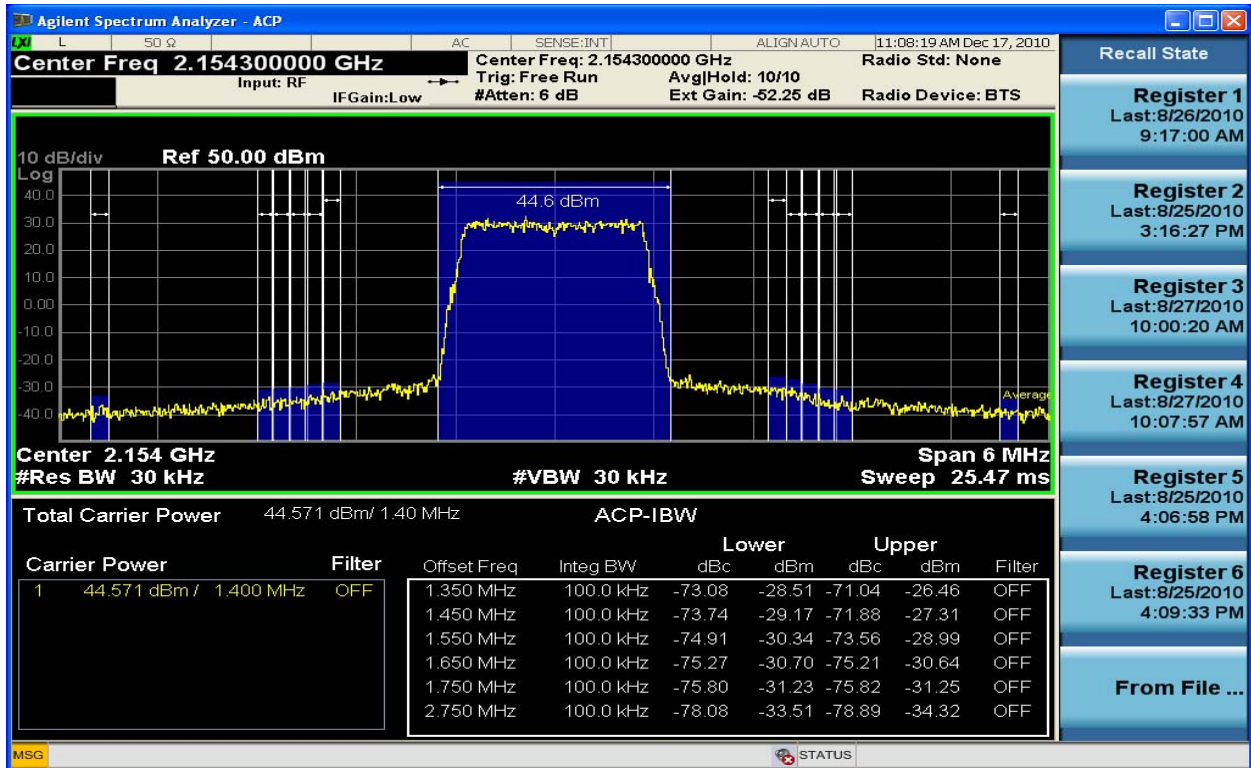

Figure 6-77 Spurious Emissions 2154.3MHz TX2_16QAM 1.4MHz Band Edge (ACP 650kHz – 2MHz)

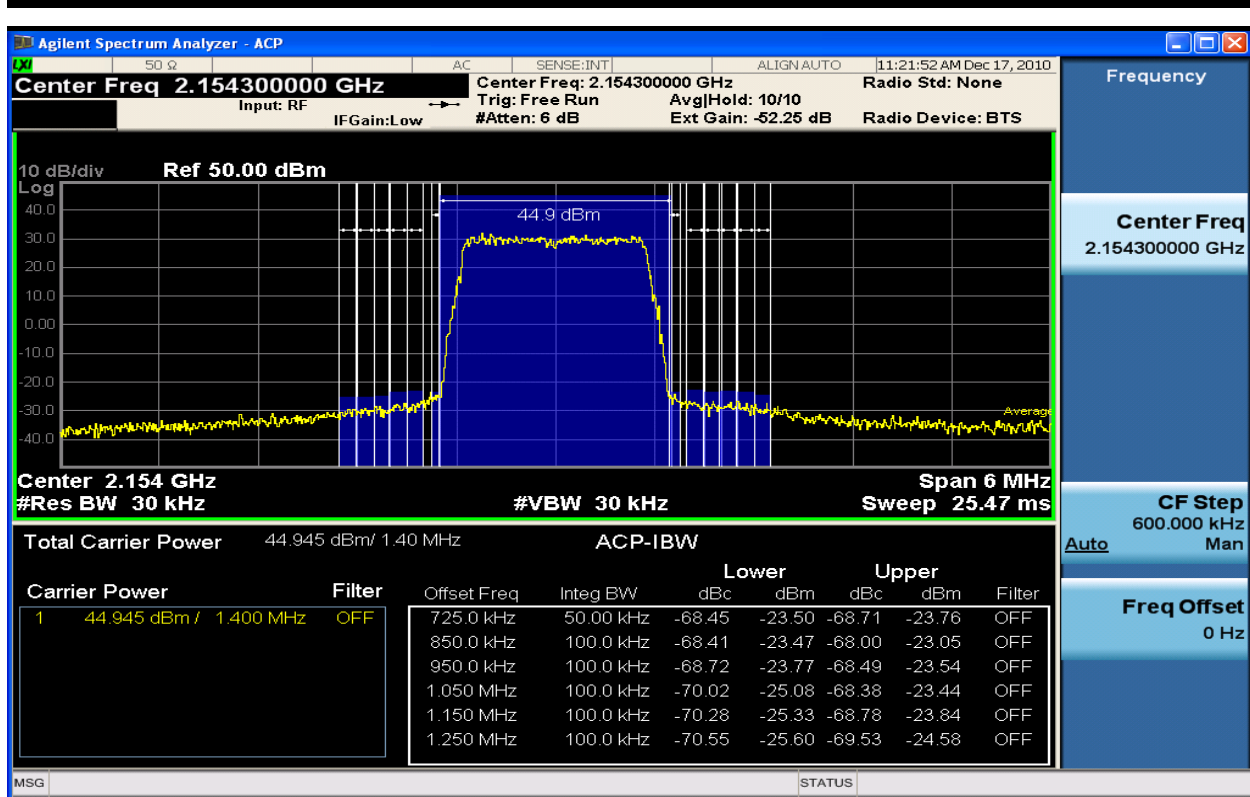

Figure 6-78 Spurious Emissions 2154.3MHz TX1_64QAM 1.4MHz Band Edge (ACP 15kHz – 550kHz)

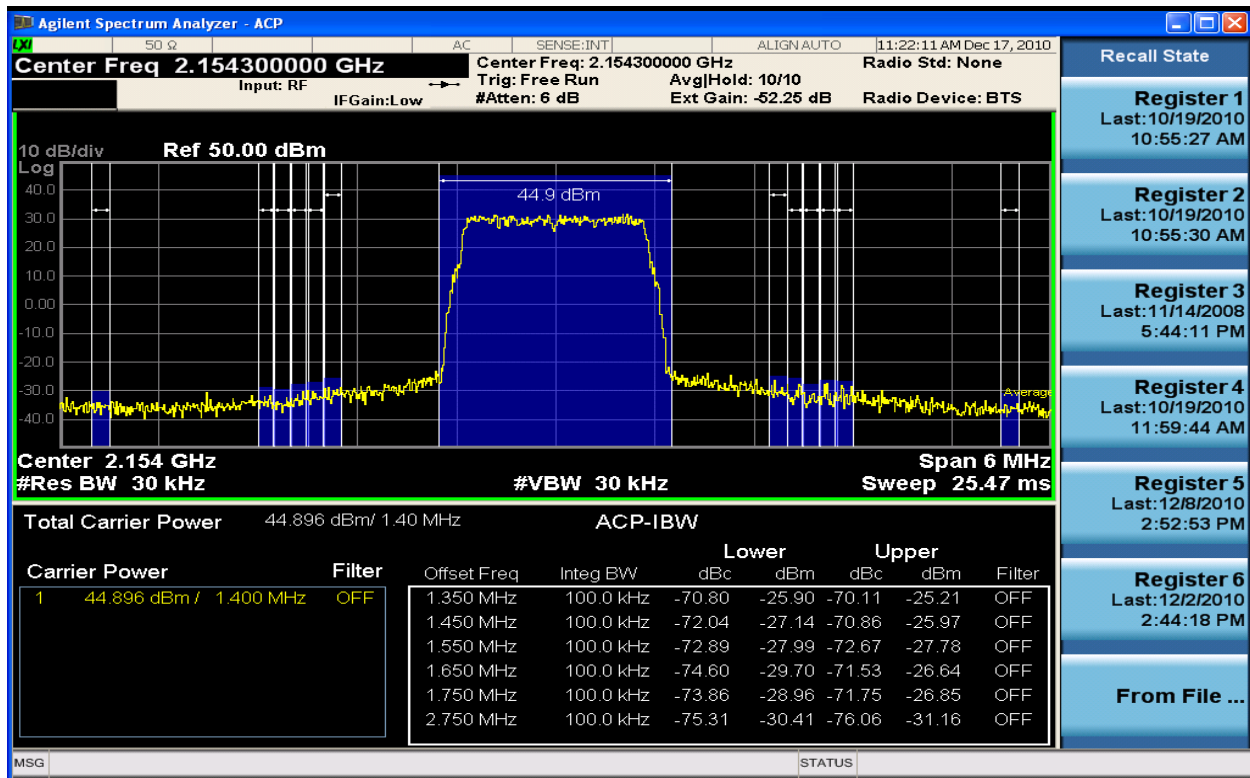

Figure 6-79 Spurious Emissions 2154.3MHz TX1_64QAM 1.4MHz Band Edge (ACP 650kHz – 2MHz)

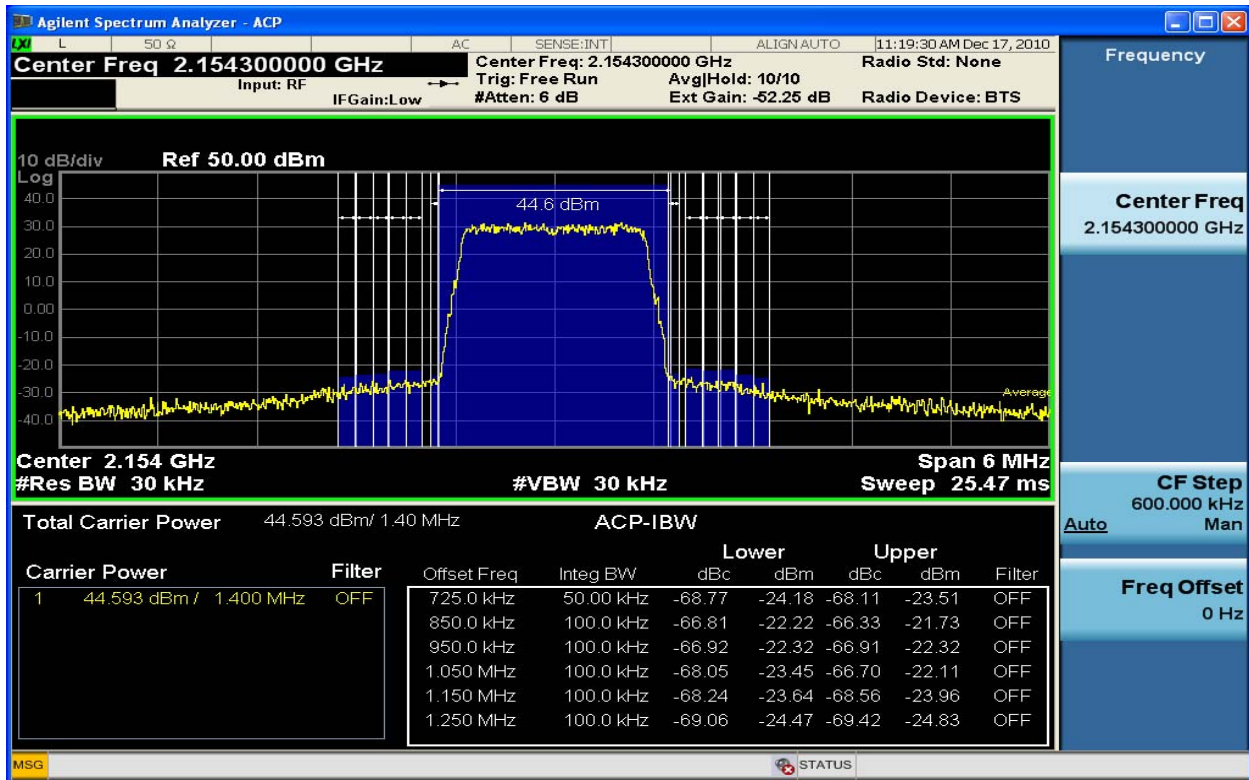

Figure 6-80 Spurious Emissions 2154.3MHz TX2_64QAM 1.4MHz Band Edge (ACP 15kHz – 550KHz)

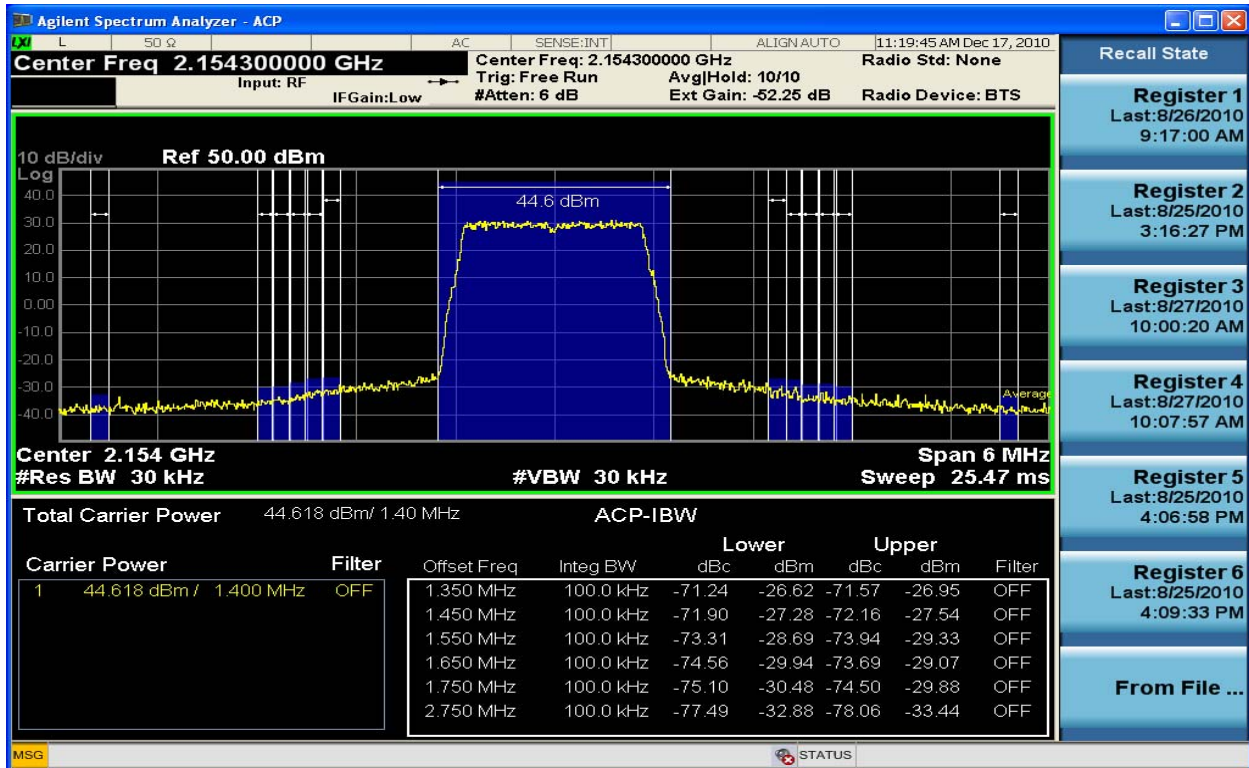

Figure 6-81 Spurious Emissions 2154.3MHz TX2_64QAM 1.4MHz Band Edge (ACP 650kHz – 2MHz)

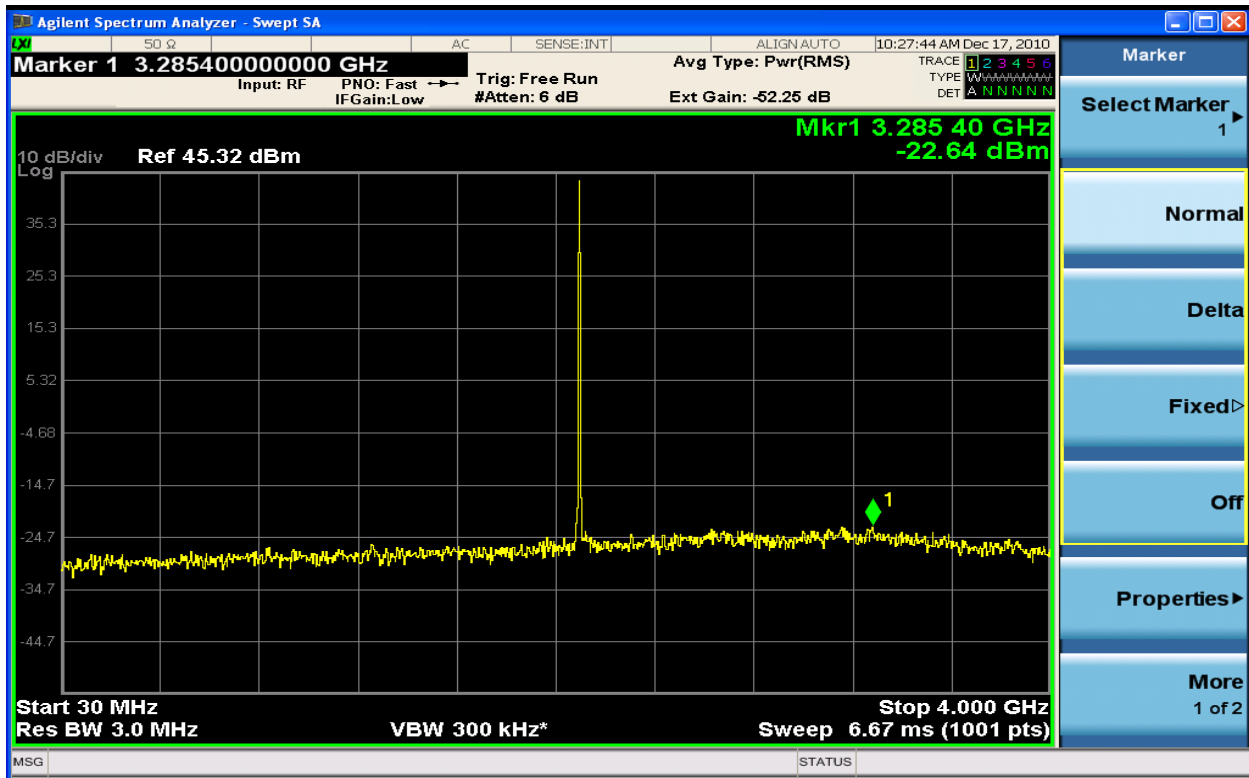

Figure 6-82 Spurious Emission TX1 64QAM 2110.7MHz - 1.4MHz (30MHz - 4GHz)

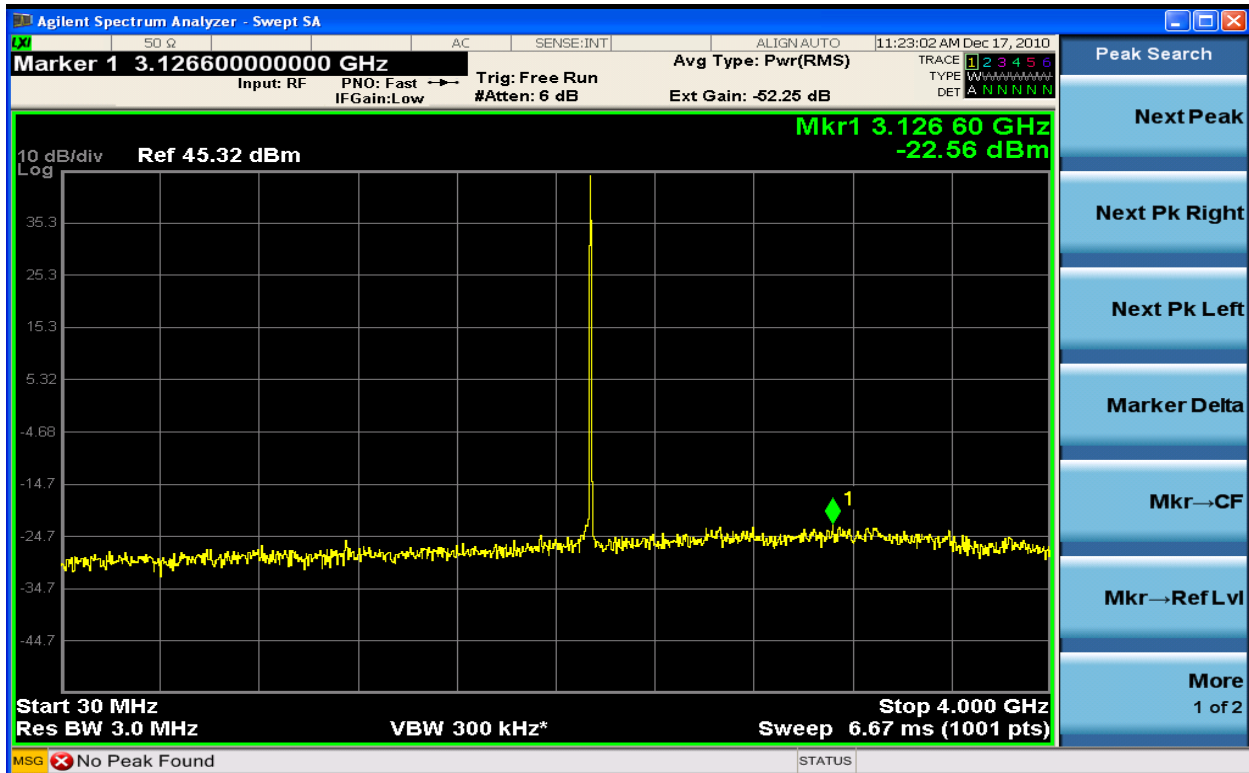

Figure 6-83 Spurious Emission TX1 64QAM 2154.3MHz - 1.4MHz (30MHz - 4GHz)

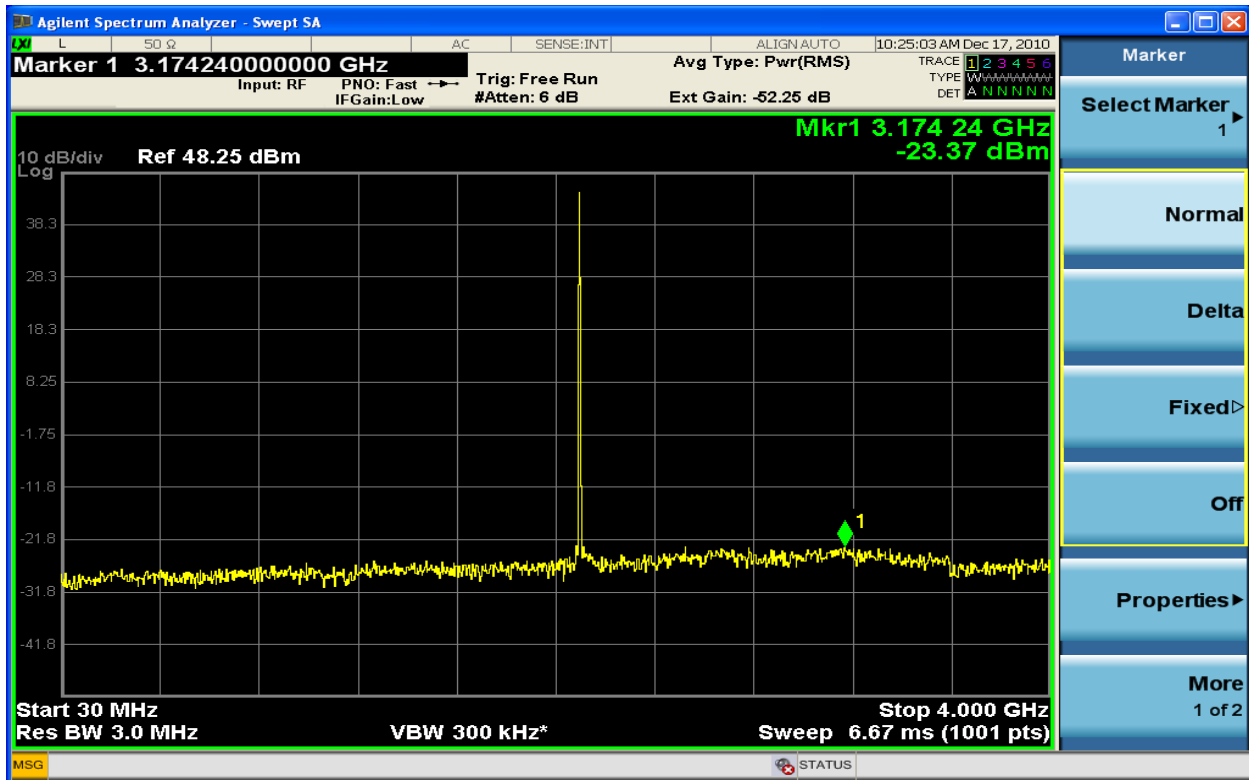

Figure 6-84 Spurious Emission TX2 64QAM 2110.7MHz - 1.4MHz (30MHz - 4GHz)

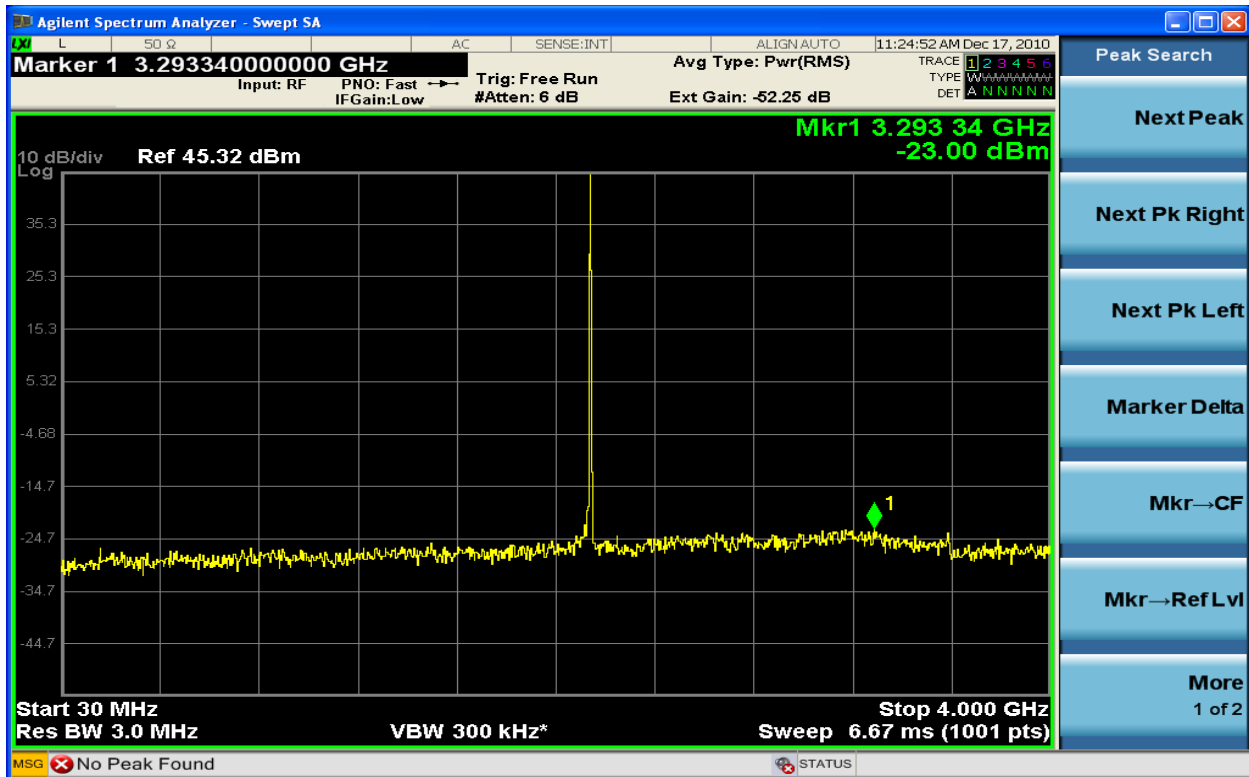

Figure 6-85 Spurious Emission TX2 64QAM 2154.3MHz - 1.4MHz (30MHz - 4GHz)

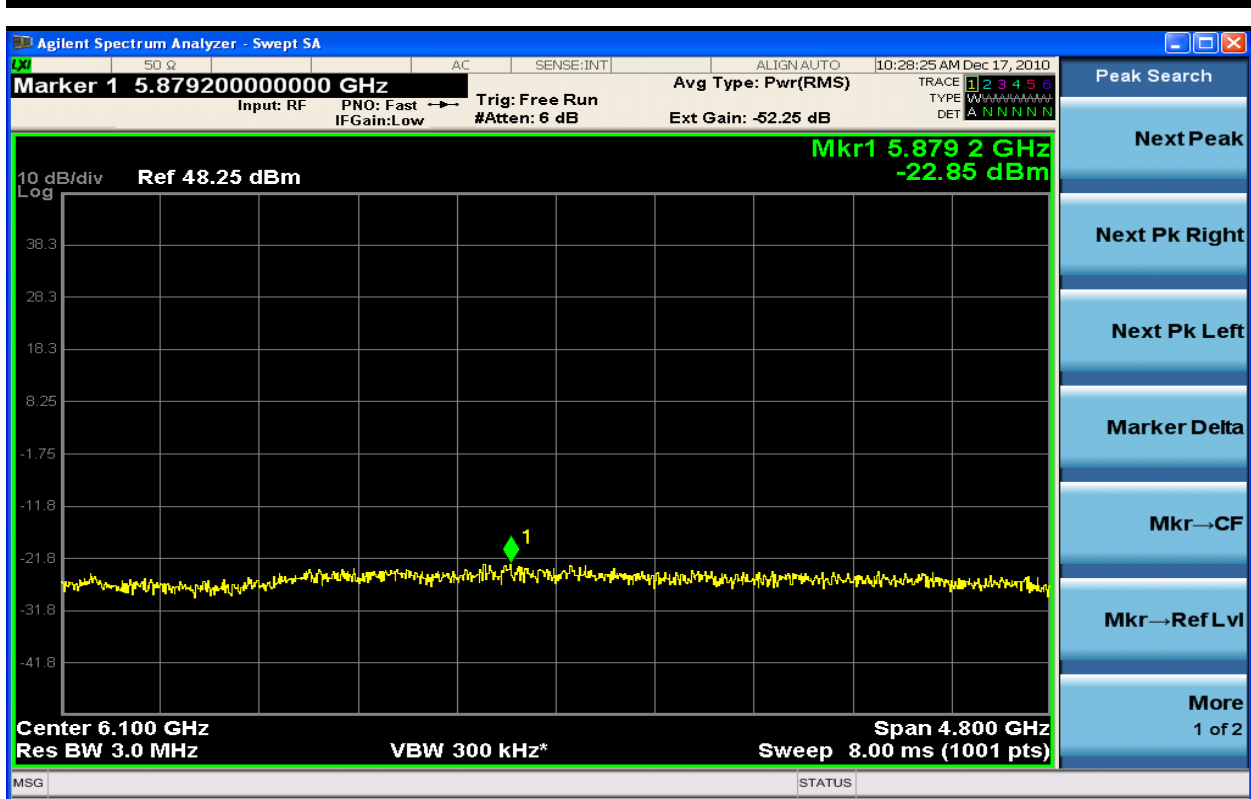

Figure 6-86 Spurious Emission TX1 64QAM 2110.7MHz - 1.4MHz (3.5GHz – 8.4GHz)

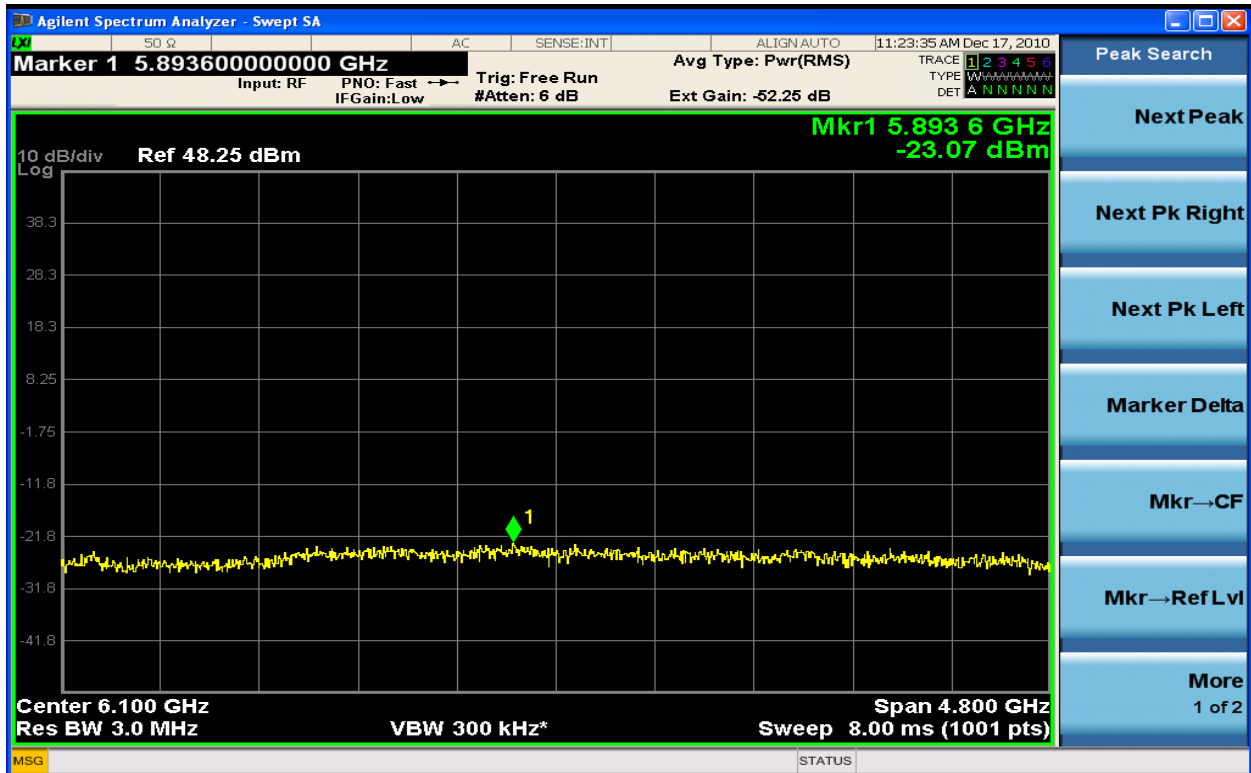

Figure 6-87 Spurious Emission TX1 64QAM 2154.3MHz – 1.4MHz (3.5GHz – 8.4GHz)

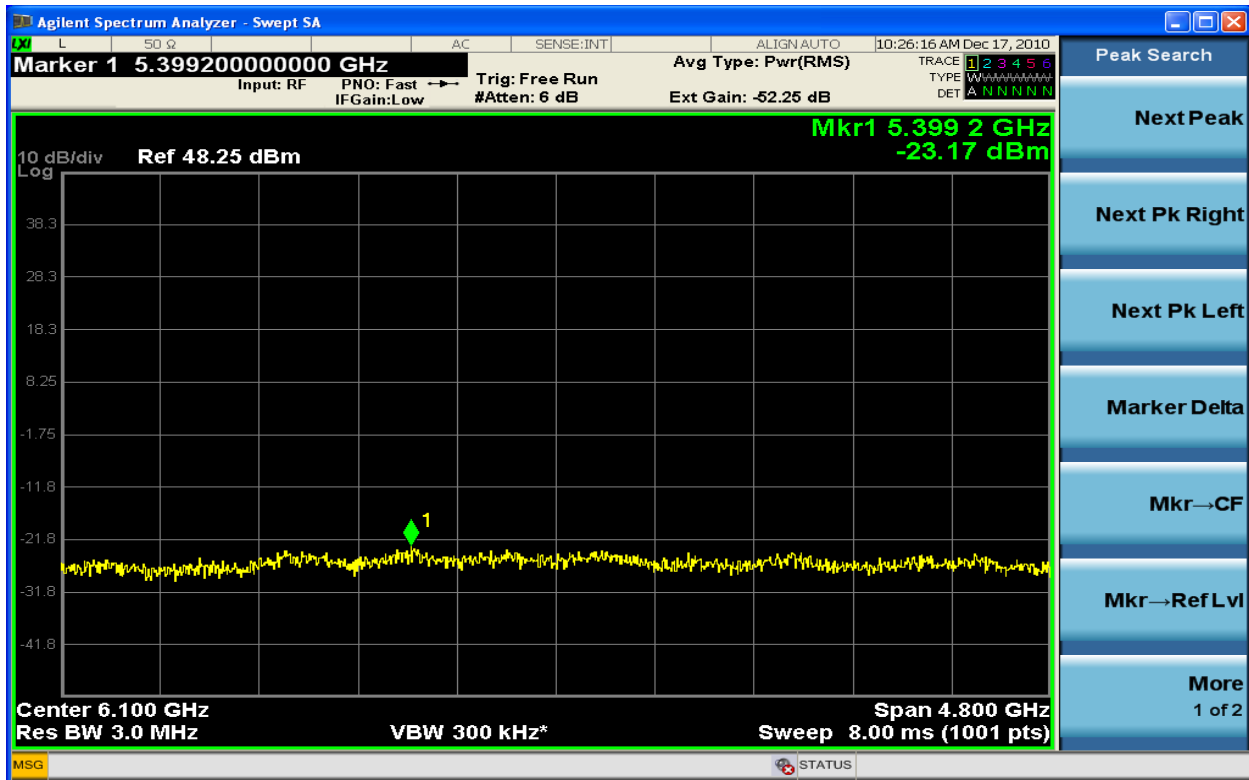

Figure 6-88 Spurious Emission TX2 64QAM 2110.7MHz - 1.4MHz (3.5GHz – 8.4GHz)

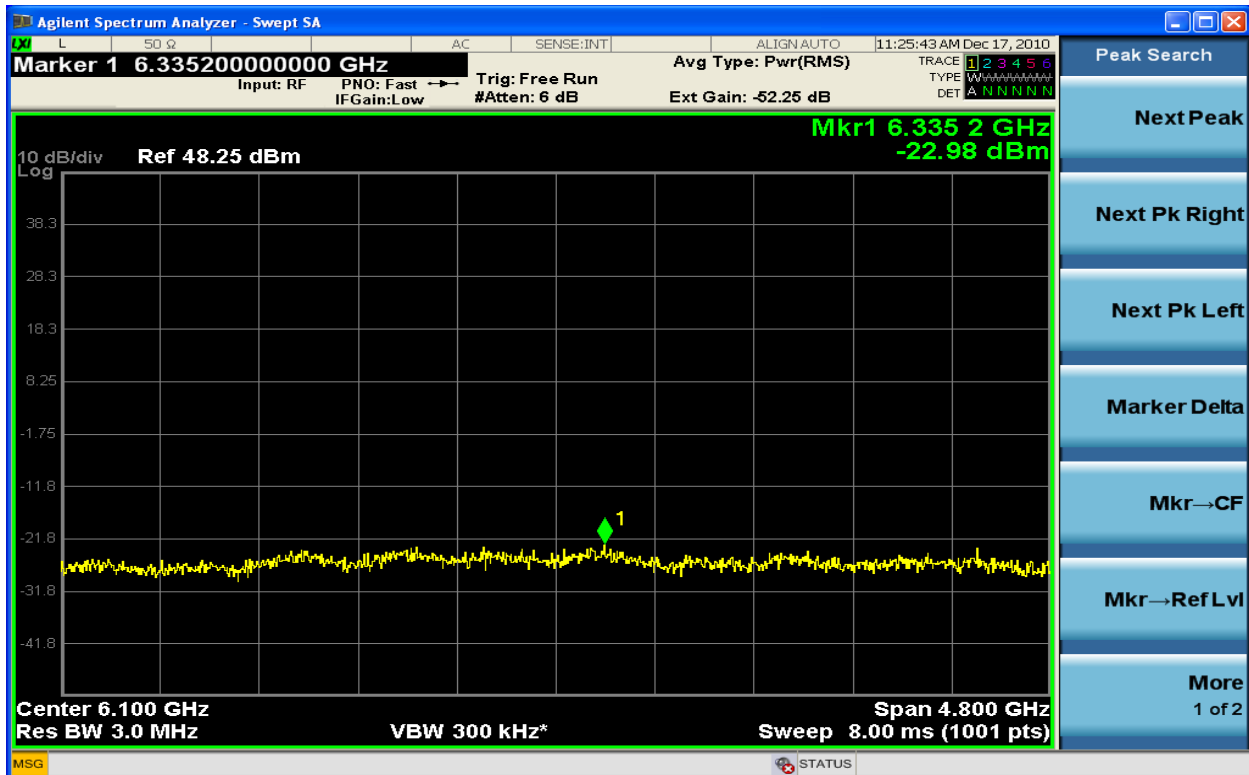

Figure 6-89 Spurious Emission TX2 64QAM 2154.3MHz – 1.4MHz (3.5GHz – 8.4GHz)



Figure 6-90 Spurious Emission TX1 64QAM 2110.7MHz - 1.4MHz (8GHz- 16GHz)



Figure 6-91 Spurious Emission TX1 64QAM 2154.3MHz - 1.4MHz (8GHz- 16GHz)



Figure 6-92 Spurious Emission TX2 64QAM 2110.7MHz - 1.4MHz (8GHz- 16GHz)



Figure 6-93 Spurious Emission TX2 64QAM 2154.3MHz - 1.4MHz (8GHz- 16GHz)

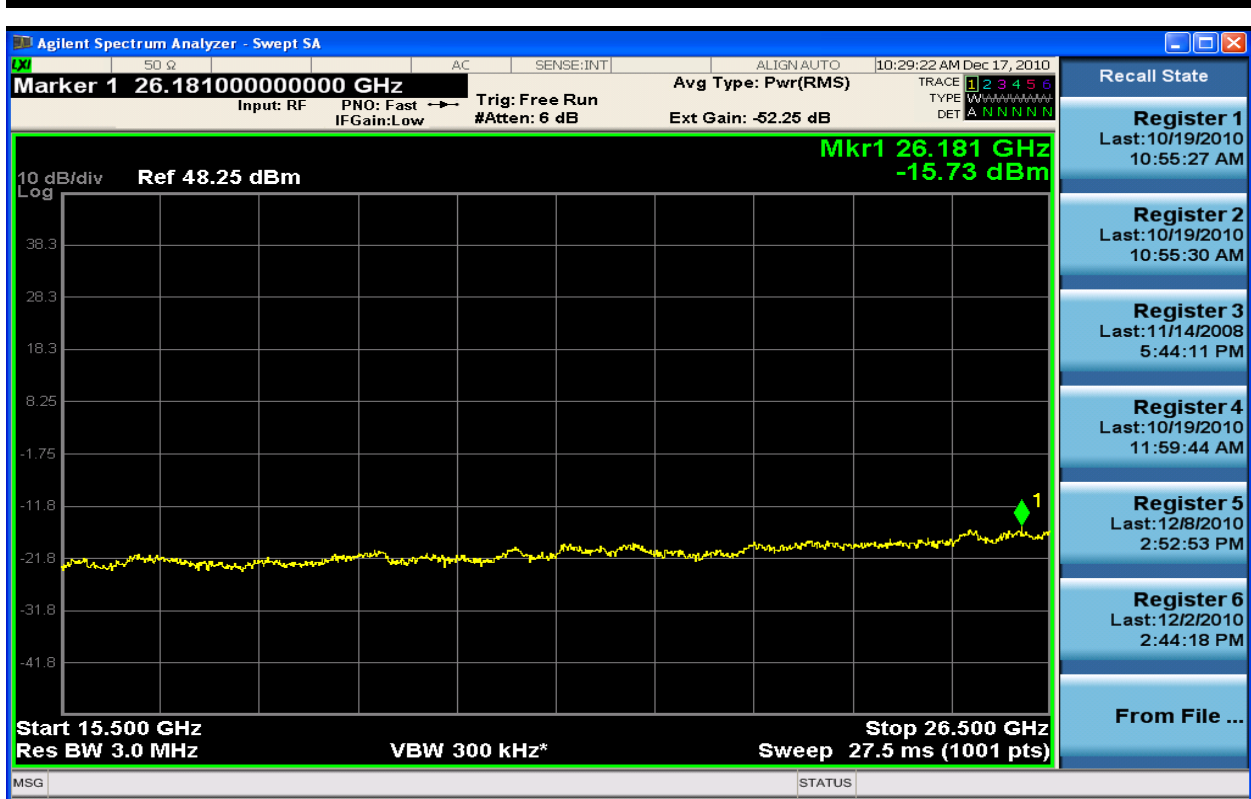

Figure 6-94 Spurious Emission TX1 64QAM 2110.7MHz - 1.4MHz (15.5GHz – 26.5GHz)

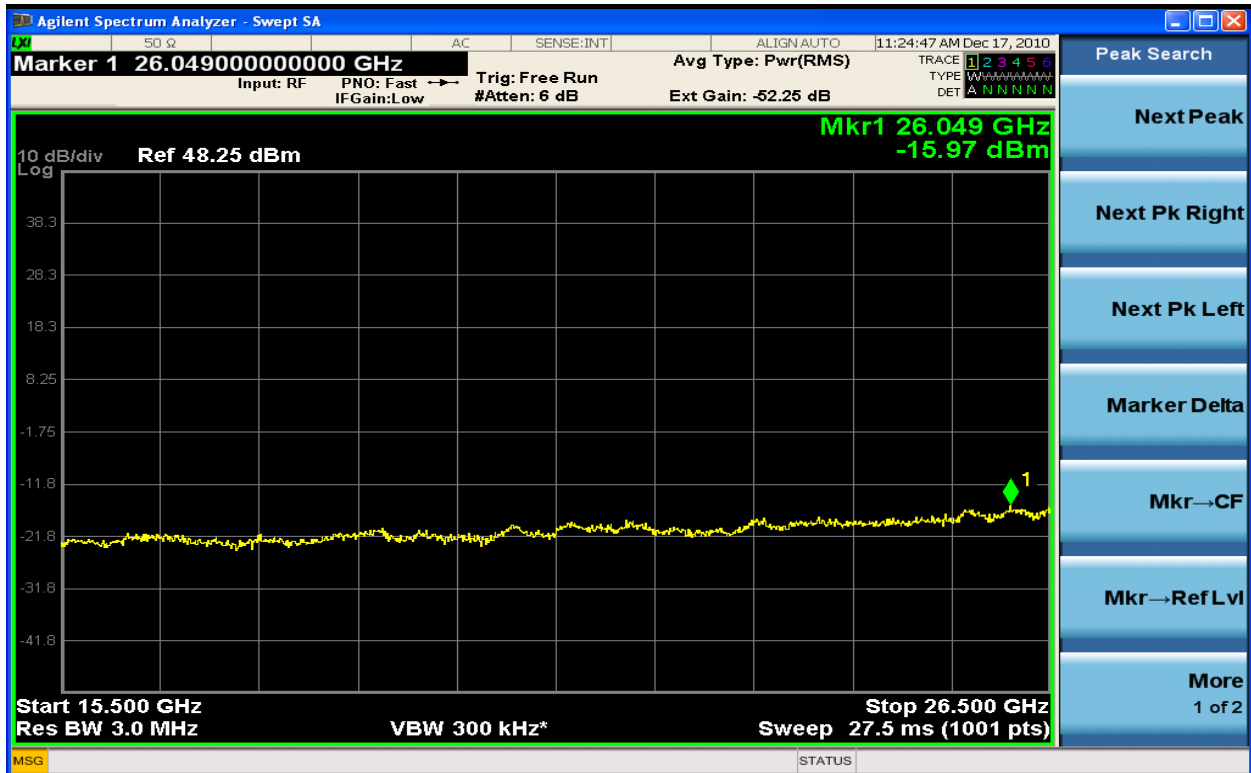

Figure 6-95 Spurious Emission TX1 64QAM 2154.3MHz – 1.4MHz (15.5GHz – 26.5GHz)

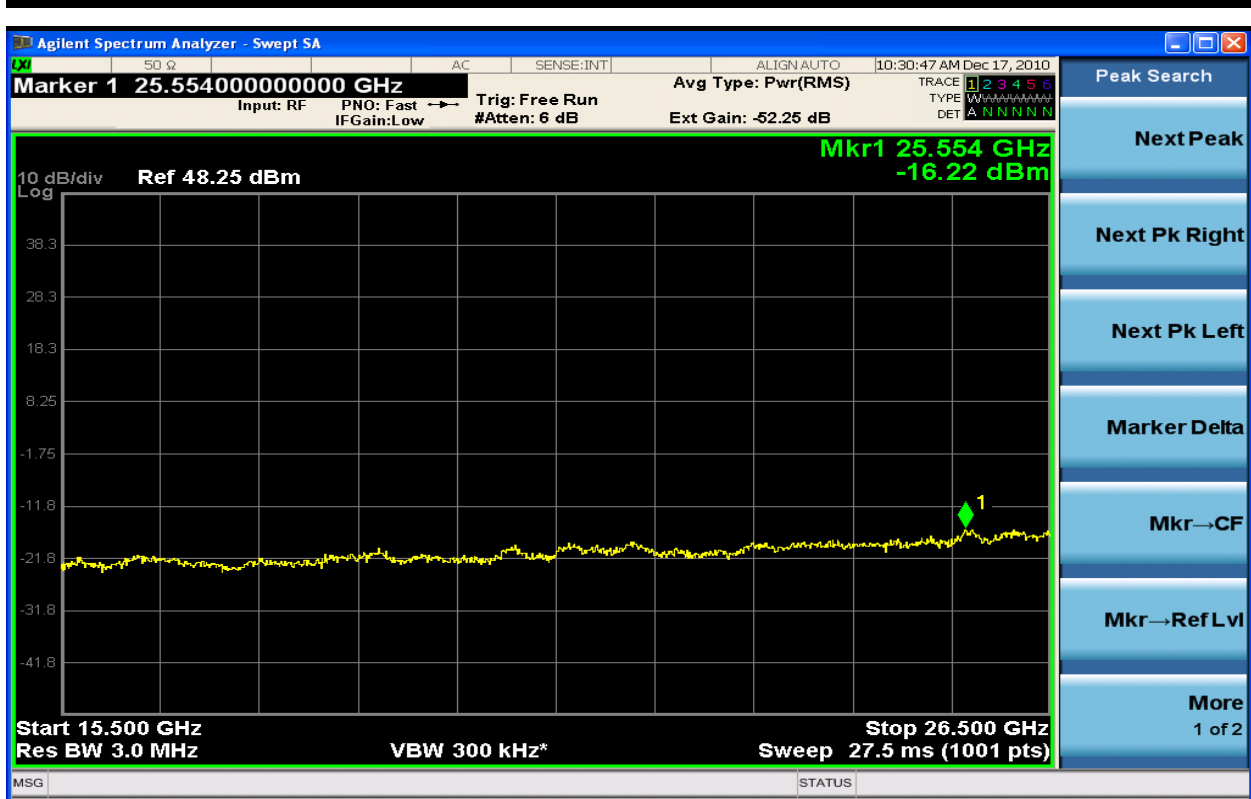

Figure 6-96 Spurious Emission TX2 64QAM 2110.7MHz - 1.4MHz (15.5GHz – 26.5GHz)

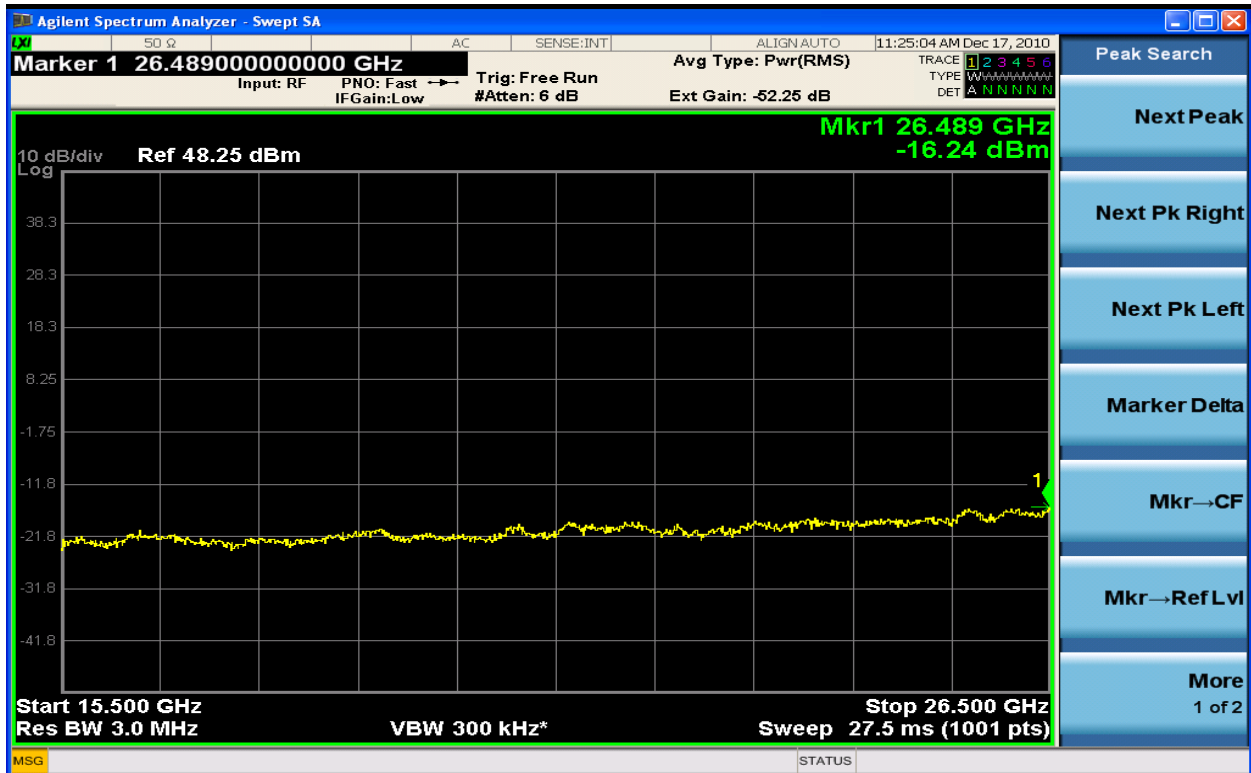

Figure 6-97 Spurious Emission TX2 64QAM 2154.3MHz – 1.4MHz (15.5GHz – 26.5GHz)

6.4 Field Strength of Spurious Radiation

Clause 27.53(h)

(h) For operations in the 1710–1755 MHz and 2110–2155 MHz bands, the power of any emission outside a licensee’s frequency block shall be attenuated below the transmitter power (P) by at least $43 + 10 \log_{10}(P)$ dB.

(1) Compliance with this provision is based on the use of measurement instrumentation employing a resolution bandwidth of 1 megahertz or greater. However, in the 1 megahertz bands immediately outside and adjacent to the licensee’s frequency block, a resolution bandwidth of at least one percent of the emission bandwidth of the fundamental emission of the transmitter may be employed. The emission bandwidth is defined as the width of the signal between two points, one below the carrier center frequency and one above the carrier center frequency, outside of which all emissions are attenuated at least 26 dB below the transmitter power.

(2) When measuring the emission limits, the nominal carrier frequency shall be adjusted as close to the licensee’s frequency block edges, both upper and lower, as the design permits.

(3) The measurements of emission power can be expressed in peak or average values, provided they are expressed in the same parameters as the transmitter power.

(i) When an emission outside of the authorized bandwidth causes harmful interference, the Commission may, at its discretion, require greater attenuation than specified in this section.

Test Setup:

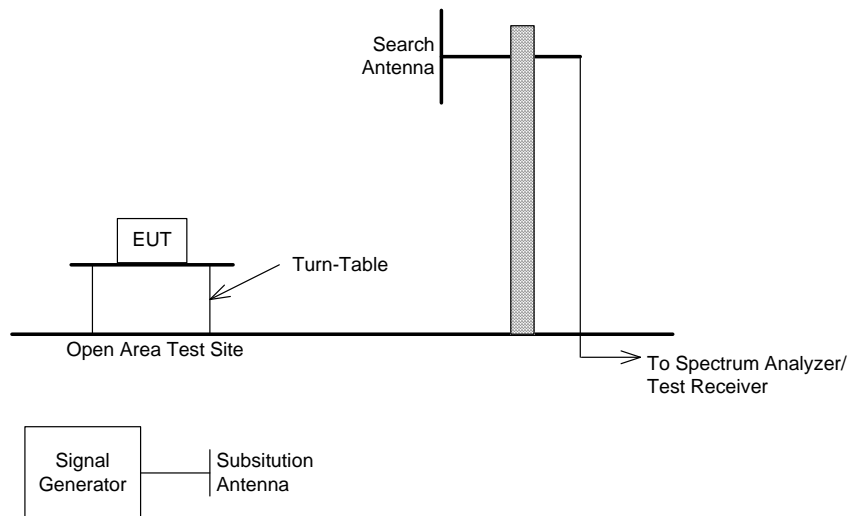

Figure 6-98: RRU Field Strength Set Up / Configuration

Test Procedure

- The EUT was placed on a turntable inside the AFC (configured as in normal operation). The system and its cables were separated from the ground plane by an insulating support 10 mm in height. The system was grounded in accordance with its installation specifications. No additional grounding connections were connected.
- For tests between **30 MHz and 1 GHz** the receive antenna (bi-log/horn) was placed at 10 m away from the EUT. An initial scan was done to find emissions (frequencies) requiring detailed measurement. The pre-scan was done by rotating the system 360 degrees while recording all emissions (frequency and amplitude). This procedure was repeated for antenna heights of 1 to 4 m, and for horizontal and vertical polarizations of the receiving antenna. The detector mode was quasi-peak (QP) with a 120 kHz bandwidth unless otherwise noted.
- For tests between **1 GHz and 10 GHz** the receive antenna (bi-log/horn) was placed at 10 m away from the EUT. An initial scan was done to find emissions (frequencies) requiring detailed measurement. The pre-scan was done by rotating the system 360 degrees while recording all emissions (frequency and amplitude). This procedure was repeated for antenna heights of 1 to 4 m, and for horizontal and vertical polarizations of the receiving antenna. The detector mode was average (AVG) with a 1 MHz bandwidth unless otherwise noted.
- For tests between **10 GHz to 18 GHz** the receive horn antenna was placed at a 3 m distance from the EUT. An initial scan was done to find emissions (frequencies) requiring detail measurement. The pre-scan was done by rotating the system 360 degrees while recording all emissions (frequency and amplitude). This procedure was repeated for antenna heights of 1 to 4 m, and for horizontal and vertical polarizations of the receiving antenna. These measurements were made with an average detector mode (AVG) with a 1 MHz bandwidth unless otherwise noted.
- For **all the above frequency ranges** optimization was done based on the pre-scan data. For each identified frequency, the EUT was rotated in azimuth over 360 degrees and the direction of maximum emission was noted. Antenna height was then varied from 1 to 4 m at this azimuth to obtain maximum emissions. The procedure was repeated for both horizontal and vertical polarizations (where applicable) of the search antenna. The maximum level measured was recorded. The spectrum analyzer was verified to make sure it was not saturating in the presence of the radio signal.
- The highest emissions were re-evaluated using the substitution method. This is accomplished by replacing the EUT by a calibrated antenna, cable and signal generator. This equipment is used to transmit a signal that will generate a RF meter reading level identical to the one were done with a bandwidth of 1 MHz.

Calculation of the Compliance Margin

The following example illustrates the manner in which the emissions levels are calculated in the “RE Test Results” Table 6-5: Spurious Emissions ERP.

The rows in these tables are defined as follows.

Meter Reading (dBuV) =	Voltage measured using the spectrum analyzer with quasi-peak adapter
Gain/Loss Factor (dB) =	Cumulative gain or loss of pre-amplifier and cables used in the measurement path (a negative value indicates gain)
Transducer Factor (dB) =	Antenna factor
Level (dBuV/m) =	Corrected value or field strength, that is, the parameter of interest that is compared to the limit
Margin (dB) =	Level with respect to the appropriate limit (a positive Margin indicates that the Level is below the limit and that the measurement is a PASS)

The values in the Level row are calculated as follows:

$$\text{Level} = \text{Meter Reading} + \text{Gain/Loss Factor} + \text{Transducer Factor}$$

The values in the Margin row are calculated as follows:

$$\text{Margin} = \text{Limit} - \text{Level}$$

The following example shows the manner in which the compliance margin is calculated for ERP:

ERP = Effective radiated power or equivalent radiated power

$$\text{ERP} = \text{Signal generator level} - \text{Cable losses} + \text{Antenna gain} - \text{Half wave dipole gain}$$

$$\text{Margin} = \text{Limit} - \text{ERP}$$

$$\text{Limit} = \text{EUT Rated Power} - \text{Attenuation}$$

$$\text{Attenuation} = (43 + 10 \text{ Log} (\text{Pwr}))$$

$$\text{Limit} = 10 \text{ log} (30\text{Watt}) - (43 + 10 \text{ Log}(30\text{W}))$$

$$\text{Limit} = - 13 \text{ dBm}$$

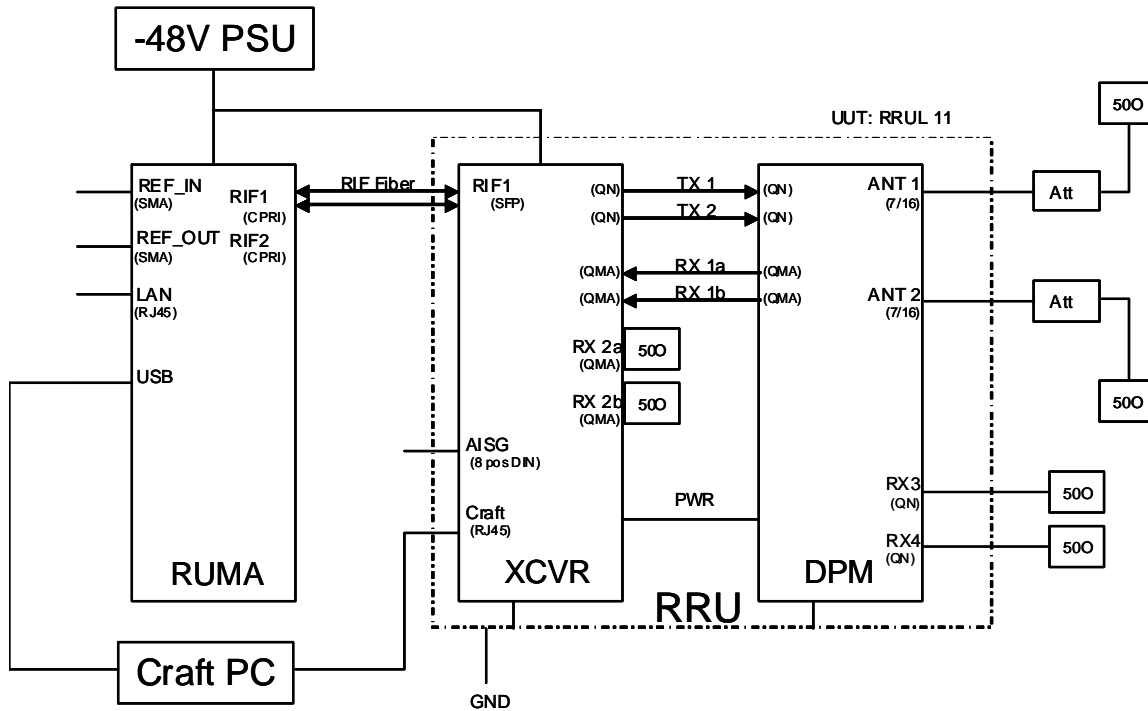

Figure 6-99: RRU EMC Set Up / Configuration

FCC 2.1053: Measurements required: Field strength of spurious radiation.

Measurements shall be made to detect spurious emissions that may be radiated directly from the cabinet, control circuits, power leads, or intermediate circuit elements under normal conditions of installation and operation. Curves or equivalent data shall be supplied showing the magnitude of each harmonic and other spurious emission. For this test, single sideband, independent sideband, and controlled carrier transmitters shall be modulated under the conditions specified in paragraph (c) of FCC 2.1049, as appropriate.

FCC 2.1057: Frequency spectrum to be investigated.

In all of the measurements set forth in 2.1051 and 2.1053, the spectrum shall be investigated from the lowest radio frequency signal generated in the equipment, without going below 9 kHz, up to at least the tenth harmonic of the highest fundamental frequency or to 40 GHz, whichever is lower. Particular attention should be paid to harmonics and sub-harmonics of the carrier frequency as well as to those frequencies removed from the carrier by multiples of the oscillator frequency. Radiation at the frequencies of multiplier stages should also be checked. The amplitude of spurious emissions which are attenuated more than 20 dB below the permissible value need not be reported.

27.55 Power Strength Limits.

(a) *Field strength limits:* For the following bands, the predicted or measured median field strength at any location on the geographical border of a licensee's service area shall not exceed the value specified unless the adjacent affected service area licensee(s) agree(s) to a different field strength. This value applies to both the initially offered service areas and to partitioned service areas.

- (1) 2110–2155, 2305–2320 and 2345–2360 MHz bands: 47 dBV/m.

EMC Reference Report: K0001795-TR-RAD-02-01, January 2011

Flextronics Design Validation Centre, 21 Richardson Side Road, Kanata On, K2K 2C1, Canada
Accreditation: SCC ISO/IEC 17025

Table 6-5: Spurious Emissions ERP

Frequency (MHz)	Field Strength (dBuV)	Signal Substitution (dBm)	Cable Loss (dB)	Antenna Gain (dBi)	dBi to dBd Conversion	ERP (dBm)	Limit (dBm)	Margin (dB)
4265.0	49.28	-45.5	7.64	10.45	2.15	-44.0	-13.0	31.8

Remarks: All other spurious have more margin

All emissions in the radiated emission scan were low compared to the FCC Part 15 limits. The worst case spurious emissions were verified using substitution method as tabulated above.

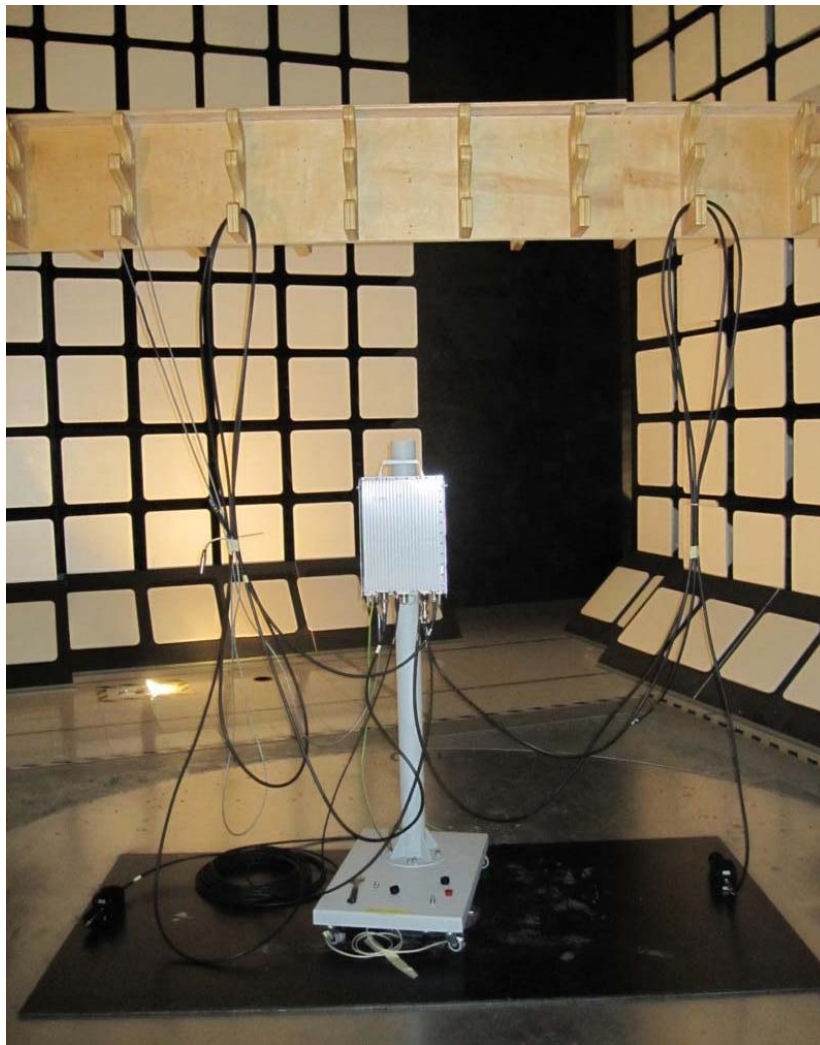

Figure 6-100: Radiated Emissions Set Up Photo

6.5 Submission Exhibits – Permissive Change

2.1033 Submission Exhibits

- FCC Form 731
- Test Report