RRUL 11 B4 CS – Remote Radio Unit AWS Radio Compliance – Class II Permissive Change 1.4MHz FCC CFR 47 Part 27 Test Report

Version: 1.0
Date: 27 January 2011
Document: RRUL 11 B4 Co-Site FCC 47 Part 27_Permissive Change TR
Status: Approved
Pages: 77
Editor: David Bolzon
File: RRUL 11 B4 CS AWS FCC PC1.4_TR_A.doc



CONFIDENTIAL INFORMATION
RESTRICTED USE AND DUPLICATION
© Ericsson Canada Inc. All Rights Reserved.

The information contained in this document is the property of Ericsson Canada. Except as specifically authorized in writing by Ericsson, the holder of this document shall keep all information contained herein confidential and shall protect same in whole or in part from disclosure and dissemination to all third parties.

Approvals and Key Reviewers

Name	Function	Role	Status
David Bolzon	Regulatory, Object Leader	Author / Approver	Approved

Revision History

Issue	Description of change	Changed by	Date
0.1	Draft	David Bolzon	21 December 2010
1.0	Approved Report	David Bolzon	27 January 2011

Reference Documents

1. FCC 47 CFR Part 27 “Wireless Communications Services”
2. FCC 47 CFR Part 15 “Unintentional Radiators”
3. ICES-003 “Digital Apparatus” EMC
4. EN 50385:2002—Product Standard to Demonstrate the Compliance of Radio Base Stations and Fixed Terminal Stations for Wireless Telecommunication Systems with the Basic Restrictions or the Reference Levels Related to Human Exposure to Radio-Frequency Electromagnetic Fields (110 MHz–40 GHz)—General Public
5. EN 55022, Limits and methods of measurement of radio disturbance characteristics of information technology equipment (CISPR22: 1997), 1998, European Committee for Electro-technical Standardization
6. SM.328: "Spectra and bandwidth of emissions".
7. CISPR 22: "Limits and methods of measurement of radio disturbance characteristics of information technology equipment".
8. CISPR 16-1-1: "Specification for radio disturbance and immunity measuring apparatus and methods - Measuring apparatus".
9. ETSI TS 136 141 V8.2.0 (2009-04) LTE; Evolved Universal Radio Access (E-UTRA); Base Station (BS) conformance testing (3GPP TS 36.141 version 8.2.0 Release 8)
10. ETSI TS 136 104 V8.5.0 (2009-04) LTE; Evolved Universal Terrestrial Radio Access (E-UTRA); Base Station (BS) radio transmission and reception (3GPP TS 36.104 version 8.5.0 Release 8)
11. ETSI TS 136 113 V8.1.0 (2009-01) LTE; Evolved Universal Terrestrial Radio Access (E-UTRA); Base Station (BS) and repeater Electro Magnetic Compatibility (EMC) (3GPP TS 36.113 version 8.1.0 Release 8)
12. 3GPP TS 36.141 V9.0.0 (2009-05): 3rd Generation Partnership Project; Technical Specification Group Radio Access Network; Evolved Universal Terrestrial Radio Access (E-UTRA) ; Base Station (BS) conformance testing (Release 9).
13. 3GPP TS 36.104 V9.0.0 (2009-05) 3rd Generation Partnership Project; Technical Specification Group Radio Access Network; Evolved Universal Terrestrial Radio Access (E-UTRA); Base Station (BS) radio transmission and reception (Release 9)
14. 3GPP TS 36.113 V9.0.0(2009-05) 3rd Generation Partnership Project; Technical Specification Group Radio Access Network; Evolved Universal Terrestrial Radio Access (E-UTRA); Base Station (BS) and repeater Electro Magnetic Compatibility (EMC) (Release 9)
15. 3GPP TS 36.211 V8.7.0 (2009-05) 3rd Generation Partnership Project; Technical Specification Group Radio Access Network; Evolved Universal Terrestrial Radio Access (E-UTRA); Physical Channels and Modulation (Release 8)
16. 3GPP TS 36.212 V8.7.0 (2009-05) 3rd Generation Partnership Project; Technical Specification Group Radio Access Network; Evolved Universal Terrestrial Radio Access (E-UTRA); Multiplexing and channel coding (Release 8)
17. 3GPP TS 36.213 V8.7.0 (2009-05) 3rd Generation Partnership Project; Technical Specification Group Radio Access Network; Evolved Universal Terrestrial Radio Access (E-UTRA); Physical layer procedures (Release 8)
18. AWS LTE Remote Radio Unit, System Design Specification (RRUL 11 B4)

Table of Contents

Approvals and Key Reviewers	2
Revision History	2
Reference Documents	3
Table of Contents	4
List of Tables	5
List of Figures.....	6
Acronyms	8
1 Summary	9
2 Introduction	10
3 Equipment Under Test.....	11
3.1 Product Identification	11
3.2 Technical Specifications of the EUT	11
3.3 Technical Description – Class II Permissive Change	11
4 Test Conditions	14
4.1 Specifications.....	14
4.2 Test Environment	14
4.3 Test Equipment.....	14
5 Applicable Tests.....	16
5.1 FCC Part 27: Test Parameters.....	16
6 Test Results	17
6.1 Effective Radiated Power	17
Physical Channels	17
6.2 Occupied Bandwidth	32
6.3 Spurious Emissions at the Antenna Terminal.....	43
6.4 Field Strength of Spurious Radiation.....	72
6.5 Submission Exhibits – Permissive Change.....	77

List of Tables

Table 3-1: Applicable FCC AWS Blocks	12
Table 4-1: Conducted Emissions - List of Test Equipment.....	14
Table 4-2: Radiated Emissions - List of Test Equipment	15
Table 5-1: Applicable Test Parameters / Results Summary	16
Table 6-1: Setting / Measurement Results – 1.4MHz Channel Power	19
Table 6-2: Setting / Measurement Results – Occupied Bandwidth 1.4MHz.....	33
Table 6-3: Setting / Measurement Results – Spurious Emissions Band Edge BW = 1.4MHz.....	44
Table 6-4: Setting / Results – BW = 1.4MHz, Spurious Emissions 30MHz - 26.5GHz	45
Table 6-5: Spurious Emissions ERP	76

List of Figures

Figure 3-1: UUT – Block Diagram RRUL 11 B4 Co-Site AWS.....	13
Figure 6-1: RRU Radio Compliance Set Up / Configuration	18
Figure 6-2: 1.4MHz BW Channel Power TX1_QPSK at 2110.7 MHz	20
Figure 6-3: 1.4MHz BW Channel Power TX2_QPSK at 2110.7 MHz	20
Figure 6-4: 1.4MHz BW Channel Power TX1_16QAM at 2110.7 MHz.....	21
Figure 6-5: 1.4MHz BW Channel Power TX2_16QAM at 2110.7 MHz.....	21
Figure 6-6: 1.4MHz BW Channel Power TX1_64QAM at 2110.7 MHz.....	22
Figure 6-7: 1.4MHz BW Channel Power TX2_64QAM at 2110.7 MHz.....	22
Figure 6-8: 1.4MHz BW Modulation TX1_QPSK at 2132.5 MHz.....	23
Figure 6-9: 1.4MHz BW Channel Power TX1_QPSK at 2132.5 MHz	23
Figure 6-10: 1.4MHz BW Modulation TX2_QPSK at 2132.5 MHz.....	24
Figure 6-11: 1.4MHz BW Channel Power TX2_QPSK at 2132.5 MHz	24
Figure 6-12: 1.4MHz BW Modulation TX1_16QAM at 2132.5 MHz.....	25
Figure 6-13: 1.4MHz BW Channel Power TX1_16QAM at 2132.5 MHz.....	25
Figure 6-14: 1.4MHz BW Modulation TX2_16QAM at 2132.5 MHz.....	26
Figure 6-15: 1.4MHz BW Channel Power TX2_16QAM at 2132.5 MHz.....	26
Figure 6-16: 1.4MHz BW Modulation TX1_64QAM at 2132.5 MHz.....	27
Figure 6-17: 1.4MHz BW Channel Power TX1_64QAM at 2132.5 MHz.....	27
Figure 6-18: 1.4MHz BW Modulation TX2_64QAM at 2132.5 MHz.....	28
Figure 6-19: 1.4MHz BW Channel Power TX2_64QAM at 2132.5 MHz.....	28
Figure 6-20: 1.4MHz BW Channel Power TX1_QPSK at 2154.3 MHz	29
Figure 6-21: 1.4MHz BW Channel Power TX2_QPSK at 2154.3 MHz	29
Figure 6-22: 1.4MHz BW Channel Power TX1_16QAM at 2154.3 MHz.....	30
Figure 6-23: 1.4MHz BW Channel Power TX2_16QAM at 2154.3 MHz.....	30
Figure 6-24 : 1.4MHz BW Channel Power TX1_64QAM at 2154.3 MHz.....	31
Figure 6-25 : 1.4MHz BW Channel Power TX2_64QAM at 2154.3 MHz.....	31
Figure 6-26: RRU Radio Compliance Set Up / Configuration	32
Figure 6-27: 1.4MHz Occupied Bandwidth TX1_QPSK at 2110.7 MHz	34
Figure 6-28: 1.4MHz Occupied Bandwidth TX2_QPSK at 2110.7 MHz	34
Figure 6-29: 1.4MHz Occupied Bandwidth TX1_16QAM at 2110.7 MHz	35
Figure 6-30: 1.4MHz Occupied Bandwidth TX2_16QAM at 2110.7 MHz	35
Figure 6-31: 1.4MHz Occupied Bandwidth TX1_64QAM at 2110.7 MHz	36
Figure 6-32: 1.4MHz Occupied Bandwidth TX2_64QAM at 2110.7 MHz	36
Figure 6-33: 1.4MHz Occupied Bandwidth TX1_QPSK at 2132.5 MHz	37
Figure 6-34: 1.4MHz Occupied Bandwidth TX2_QPSK at 2132.5 MHz	37
Figure 6-35: 1.4MHz Occupied Bandwidth TX1_16QAM at 2132.5 MHz	38
Figure 6-36: 1.4MHz Occupied Bandwidth TX2_16QAM at 2132.5 MHz	38
Figure 6-37: 1.4MHz Occupied Bandwidth TX1_64QAM at 2132.5 MHz	39
Figure 6-38: 1.4MHz Occupied Bandwidth TX2_64QAM at 2132.5 MHz	39
Figure 6-39: 1.4MHz Occupied Bandwidth TX1_QPSK at 2154.3 MHz	40
Figure 6-40: 1.4MHz Occupied Bandwidth TX2_QPSK at 2154.3 MHz	40
Figure 6-41: 1.4MHz Occupied Bandwidth TX1_16QAM at 2154.3 MHz	41
Figure 6-42: 1.4MHz Occupied Bandwidth TX2_16QAM at 2154.3 MHz	41
Figure 6-43: 1.4MHz Occupied Bandwidth TX1_64QAM at 2154.3 MHz	42
Figure 6-44: 1.4MHz Occupied Bandwidth TX2_64QAM at 2154.3 MHz	42
Figure 6-45: RRU Radio Compliance Set Up / Configuration	43
Figure 6-46 Spurious Emissions 2110.7MHz TX1_QPSK 1.4MHz Band Edge (ACP 15kHz – 550kHz)	46
Figure 6-47 Spurious Emissions 2110.7MHz TX1_QPSK 1.4MHz Band Edge (ACP 650kHz – 2MHz).....	46
Figure 6-48 Spurious Emissions 2110.7MHz TX2_QPSK 1.4MHz Band Edge (ACP 15kHz – 550kHz)	47

Figure 6-49 Spurious Emissions 2110.7MHz TX2_QPSK 1.4MHz Band Edge (ACP 650kHz – 2MHz).....	47
Figure 6-50 Spurious Emissions 2110.7MHz TX1_16QAM 1.4MHz Band Edge (ACP 15kHz – 550kHz)	48
Figure 6-51 Spurious Emissions 2110.7MHz TX1_16QAM 1.4MHz Band Edge (ACP 650kHz – 2MHz).....	48
Figure 6-52 Spurious Emissions 2110.7MHz TX2_16QAM 1.4MHz Band Edge (ACP 15kHz – 550kHz)	49
Figure 6-53 Spurious Emissions 2110.7MHz TX2_16QAM 1.4MHz Band Edge (ACP 650kHz – 2MHz).....	49
Figure 6-54 Spurious Emissions 2110.7MHz TX1_64QAM 1.4MHz Band Edge (ACP 15kHz – 550kHz)	50
Figure 6-55 Spurious Emissions 2110.7MHz TX1_64QAM 1.4MHz Band Edge (ACP 650kHz – 2MHz).....	50
Figure 6-56 Spurious Emissions 2110.7MHz TX2_64QAM 1.4MHz Band Edge (ACP 15kHz – 550kHz)	51
Figure 6-57 Spurious Emissions 2110.7MHz TX2_64QAM 1.4MHz Band Edge (ACP 650kHz – 2MHz).....	51
Figure 6-58 Spurious Emissions 2132.5MHz TX1_QPSK 1.4MHz Band Edge (ACP 15kHz – 550kHz)	52
Figure 6-59 Spurious Emissions 2132.5MHz TX1_QPSK 1.4MHz Band Edge (ACP 650kHz – 2MHz).....	52
Figure 6-60 Spurious Emissions 2132.5MHz TX2_QPSK 1.4MHz Band Edge (ACP 15kHz – 550kHz)	53
Figure 6-61 Spurious Emissions 2132.5MHz TX2_QPSK 1.4MHz Band Edge (ACP 650kHz – 2MHz).....	53
Figure 6-62 Spurious Emissions 2132.5MHz TX1_16QAM 1.4MHz Band Edge (ACP 15kHz – 550kHz)	54
Figure 6-63 Spurious Emissions 2132.5MHz TX1_16QAM 1.4MHz Band Edge (ACP 650kHz – 2MHz).....	54
Figure 6-64 Spurious Emissions 2132.5MHz TX2_16QAM 1.4MHz Band Edge (ACP 15kHz – 550kHz)	55
Figure 6-65 Spurious Emissions 2132.5MHz TX2_16QAM 1.4MHz Band Edge (ACP 650kHz – 2MHz).....	55
Figure 6-66 Spurious Emissions 2132.5MHz TX1_64QAM 1.4MHz Band Edge (ACP 15kHz – 550kHz)	56
Figure 6-67 Spurious Emissions 2132.5MHz TX1_64QAM 1.4MHz Band Edge (ACP 650kHz – 2MHz).....	56
Figure 6-68 Spurious Emissions 2132.5MHz TX2_64QAM 1.4MHz Band Edge (ACP 15kHz – 550kHz)	57
Figure 6-69 Spurious Emissions 2132.5MHz TX2_64QAM 1.4MHz Band Edge (ACP 650kHz – 2MHz).....	57
Figure 6-70 Spurious Emissions 2154.3MHz TX1_QPSK 1.4MHz Band Edge (ACP 15kHz – 550kHz)	58
Figure 6-71 Spurious Emissions 2154.3MHz TX1_QPSK 1.4MHz Band Edge (ACP 650kHz – 2MHz).....	58
Figure 6-72 Spurious Emissions 2154.3MHz TX2_QPSK 1.4MHz Band Edge (ACP 15kHz – 550kHz)	59
Figure 6-73 Spurious Emissions 2154.3MHz TX2_QPSK 1.4MHz Band Edge (ACP 650kHz – 2MHz).....	59
Figure 6-74 Spurious Emissions 2154.3MHz TX1_16QAM 1.4MHz Band Edge (ACP 15kHz – 550kHz)	60
Figure 6-75 Spurious Emissions 2154.3MHz TX1_16QAM 1.4MHz Band Edge (ACP 650kHz – 2MHz).....	60
Figure 6-76 Spurious Emissions 2154.3MHz TX2_16QAM 1.4MHz Band Edge (ACP 15kHz – 550kHz)	61
Figure 6-77 Spurious Emissions 2154.3MHz TX2_16QAM 1.4MHz Band Edge (ACP 650kHz – 2MHz).....	61
Figure 6-78 Spurious Emissions 2154.3MHz TX1_64QAM 1.4MHz Band Edge (ACP 15kHz – 550kHz)	62
Figure 6-79 Spurious Emissions 2154.3MHz TX1_64QAM 1.4MHz Band Edge (ACP 650kHz – 2MHz).....	62
Figure 6-80 Spurious Emissions 2154.3MHz TX2_64QAM 1.4MHz Band Edge (ACP 15kHz – 550kHz)	63
Figure 6-81 Spurious Emissions 2154.3MHz TX2_64QAM 1.4MHz Band Edge (ACP 650kHz – 2MHz).....	63
Figure 6-82 Spurious Emission TX1 64QAM 2110.7MHz - 1.4MHz (30MHz - 4GHz).....	64
Figure 6-83 Spurious Emission TX1 64QAM 2154.3MHz – 1.4MHz (30MHz - 4GHz)	64
Figure 6-84 Spurious Emission TX2 64QAM 2110.7MHz - 1.4MHz (30MHz - 4GHz).....	65
Figure 6-85 Spurious Emission TX2 64QAM 2154.3MHz – 1.4MHz (30MHz - 4GHz)	65
Figure 6-86 Spurious Emission TX1 64QAM 2110.7MHz - 1.4MHz (3.5GHz – 8.4GHz).....	66
Figure 6-87 Spurious Emission TX1 64QAM 2154.3MHz – 1.4MHz (3.5GHz – 8.4GHz)	66
Figure 6-88 Spurious Emission TX2 64QAM 2110.7MHz - 1.4MHz (3.5GHz – 8.4GHz).....	67
Figure 6-89 Spurious Emission TX2 64QAM 2154.3MHz – 1.4MHz (3.5GHz – 8.4GHz)	67
Figure 6-90 Spurious Emission TX1 64QAM 2110.7MHz - 1.4MHz (8GHz- 16GHz).....	68
Figure 6-91 Spurious Emission TX1 64QAM 2154.3MHz – 1.4MHz (8GHz- 16GHz).....	68
Figure 6-92 Spurious Emission TX2 64QAM 2110.7MHz - 1.4MHz (8GHz- 16GHz).....	69
Figure 6-93 Spurious Emission TX2 64QAM 2154.3MHz – 1.4MHz (8GHz- 16GHz).....	69
Figure 6-94 Spurious Emission TX1 64QAM 2110.7MHz - 1.4MHz (15.5GHz – 26.5GHz).....	70
Figure 6-95 Spurious Emission TX1 64QAM 2154.3MHz – 1.4MHz (15.5GHz – 26.5GHz)	70
Figure 6-96 Spurious Emission TX2 64QAM 2110.7MHz - 1.4MHz (15.5GHz – 26.5GHz).....	71
Figure 6-97 Spurious Emission TX2 64QAM 2154.3MHz – 1.4MHz (15.5GHz – 26.5GHz)	71
Figure 6-98: RRU Field Strength Set Up / Configuration	72
Figure 6-99: RRU EMC Set Up / Configuration	75
Figure 6-100: Radiated Emissions Set Up Photo.....	76

Acronyms

RRU	Remote Radio Unit
RRUL	Remote Radio Unit LTE
UDM	Universal Digital Module
DDM	Dual Duplexer Module
BTS	Base Station Transceiver
EUT	Equipment Under Test
LTE	Long Term Evolution
ACP	Adjacent Channel Power
CPRI	Common Public Radio Interface
NIST	National Institute of Standards and Technology
NRTL	National Recognized Testing Laboratory
NVLAP	National Voluntary Laboratory Accreditation Program
LAP	Laboratory Accreditation Programs
IC	Industry Canada
FCC	Federal Communication Commission
CFR	Code of Federal Regulations (US)
CAB	Conformity assessment body
EMC	Electromagnetic Compatibility
EMI	Electromagnetic interference
RTTE	Radio and Telecommunications Terminal Equipment
TTE	Telecommunications equipment
TCB	Telecom Certification Body
CCB	Canadian Certification Body
IECEE	International Electro-technical Committee for Conformity Testing to Standards for Electrical Equipment
NCB	National Certification Bodies
CBTL	CB Test Laboratory
ITL	Independent Test Laboratory
ITE	Information Technology Equipment

1 Summary

Applicant: Ericsson Canada
3500 Carling Ave.
Ottawa, On
Canada
K2H 8E9

Apparatus: KRC 131 143/3 (RRUL11 B4 AWS)
Application: Fixed Wireless Base Station Transceiver

FCC ID: VZTAKRC131143-3

In Accordance With: FCC CFR 47 Part 27 Miscellaneous Wireless
Communications Services

This test report has been prepared for the purpose of demonstrating compliance with FCC CFR Title 47 Part 27. Conducted measurements have been performed in accordance with ANSI TIA-603-B-2002. Radiated tests have been conducted in accordance with ANSI C63.4-2003. Radiated emissions are assessed and measured at an accredited ITL in a 3 meter or 10 meter Semi-Anechoic chamber. Conducted Emissions have been assessed at Ericsson Carling facilities using calibrated equipment in accordance with Part 27 Requirements.

The assessment summary is as follows:

Apparatus Assessed: KRC 131 143/3 (RRUL 11 B4 Remote Radio Unit - AWS)

Specification: FCC CFR 47 Part 27 Miscellaneous Wireless
Communications Services

Compliance Status: Complies

Exclusions: None

Non-compliances: None

Report Release History: Original Release

2 Introduction

This document supports the FCC test process and filing requirements for North American approvals. Measurements are conducted to satisfy and demonstrate compliance to the Essential parameters for Radio Compliance and Conformance to the following standards:

- FCC CFR 47 Part 27 Subpart C, Miscellaneous Wireless Communications Services.
- FCC CFR 47, Subpart 2, Subpart J, Equipment Authorization Procedures – Equipment Authorization.

The initial RRU deployment will support a 1.4MHz, 5MHz and 10MHz BW for Fixed Wireless Base Station (BTS) applications with a rated output power of 30W (44.8dBm) in a 2 x 2 MIMO configuration. Frequency band for authorization will address the US AWS Block.

Hardware Description

The BTS equipment is comprised of the following:

- 1) KRC 131 143/3 RRUL 11 B4: LTE Remote Radio Unit [RRUL] EUT
- 2) CPRI Modem Emulator (RU-Master LPC 102 400/5 R1B S/N T01E684487)

RRU Details

Frequency: FCC AWS Band

Transmit / Downlink: 2110MHz – 2155MHz – AWS Block

- Modulation: OFDMA, QPSK, 16QAM, 64QAM
- BW: 1.4/5/10 MHz
- MIMO, 2 x 2 (Spatial Multiplexing)
- Diversity, 2 Way Transmit
- Throughput: Up to 60 Mbps
- Power: 44.8dBm (30W)
- PAPR: 7dB

Duplex: FDD (30MHz)

Frequency Stability: +/-0.05ppm

Channel Raster: 100 kHz

Receive / Uplink: 1710 - 1755MHz – AWS: Block

- Modulation: SC-FDMA, QPSK, 16QAM
- BW: 1.4/5/10 MHz
- MIMO, 2 x 2, Multi-User
- Throughput: Up to 20Mbps
- Diversity, 2 and 2 Co-Site Receive

RRU Physical Details:

PWR: -48V (typical) DC 350W (max), Size: 17” x 11.3” x 8.7” (H x W x D), Weight: 53lbs

3 Equipment Under Test

3.1 Product Identification

The Equipment Under Test (EUT) is identified for Fixed Base Station operation as follows:
Ericsson Remote Radio Unit RRUL 11 B4 (AWS 2110MHz – 2155MHz) KRC 131 143/3

3.2 Technical Specifications of the EUT

Manufacturer:	Ericsson Canada
Operating Frequency:	Downlink ...TX: 2110 – 2155MHz (1.4/5/10MHz) UplinkRX: 1710 – 1755MHz (1.4/5/10MHz)
Emission Designator:	1.4MHz:...1M40 W7D 5MHz: 5M00 W7D 10MHz: 10M0 W7D
Modulation:	LTE OFDMA, QPSK, 16QAM, 64QAM (Two transmitters, 2 receivers per sector)
Antenna Data: (for reference only)	Andrew HBX-6513DS-T6M 13.2dBd, 15.3dBi (max) Beam-width – Horizontal 65°

3.3 Technical Description – Class II Permissive Change

The Ericsson LTE RRU (RRUL) is a single sector Transceiver (2 transmitter, 2 receivers per radio / sector) operating in FDD mode which has been introduced as part of Ericsson's next generation BTS product line.

The RRU operates over the North American AWS band employing a band specific duplexer designed to limit operations to specific customer requirements. The RRUL product offering operates over a Down Link (DL) transmit frequency band from 2110MHz to 2155MHz, for channel bandwidths of 1.4MHz, 5MHz and 10MHz. LTE modulation formats OFDMA QPSK, 16QAM and 64QAM will be assessed at a rated output of 30W per transmitter.

All compliance measurements and ratings are referenced at the antenna ports / duplexer interface.

Radio Standard is LTE, OFDMA TX, (SC-FDMA RX) configured for a 2x2 MIMO operating mode with an output rated power of 30W (44.8dBm) at the antenna port. Transmit outputs 1 and 2 are isolated, non-

correlated outputs connected to two isolated customer furnished antenna and are measured/verified independently.

The TX Modulation schemes of QPSK, 16QAM, and 64QAM will be supported along with an operational bandwidth of 1.4MHz, 5MHz and 10MHz in the AWS Block spectrum. QPSK, 16QAM, and 64 QAM will employ 3/4 CTC data rate coding. The RRUL employs a CPRI (Common Public Radio Interface) for interoperability and standardization of the radio protocol interface. To demonstrate compliance, appropriate LTE waveforms will be utilized to generate the RF output, rated power and bandwidth requirements with respect to the modulation variables.

The KRC 131 143/3 has an added feature to permit Co-Site Receive functionality. Two isolated receiver outputs are provided on the connector Interface enabling this feature.

This Permissive Change Test Report will demonstrate compliance for an additional Bandwidth of 1.4MHz, added to the previously Approved Product (5MHz/10MHz) permitting the RRUL 11 to operate over all three bandwidths and LTE modulations.

Table 3-1: Applicable FCC AWS Blocks

<i>Band</i>	<i>Bandwidth</i>	<i>Frequency</i>
4	45MHz	2110 – 2155MHz and 1710 – 1755MHz

Test Units

Part 27: UUT KRC 131 143/3 RRUL 11 B4 AWS R1C, SN: C84C000002 AB43
CPRI Modem interface with LTE Test Vectors and traffic (RUMA LPC 102 400/5)

Part 15/27: UUT KRC 131 143/3 RRUL 11 B4 AWS R1C, SN: C84C000001 AB43
CPRI Modem interface with LTE Test Vectors and traffic (RUMA LPC 102 400/5)

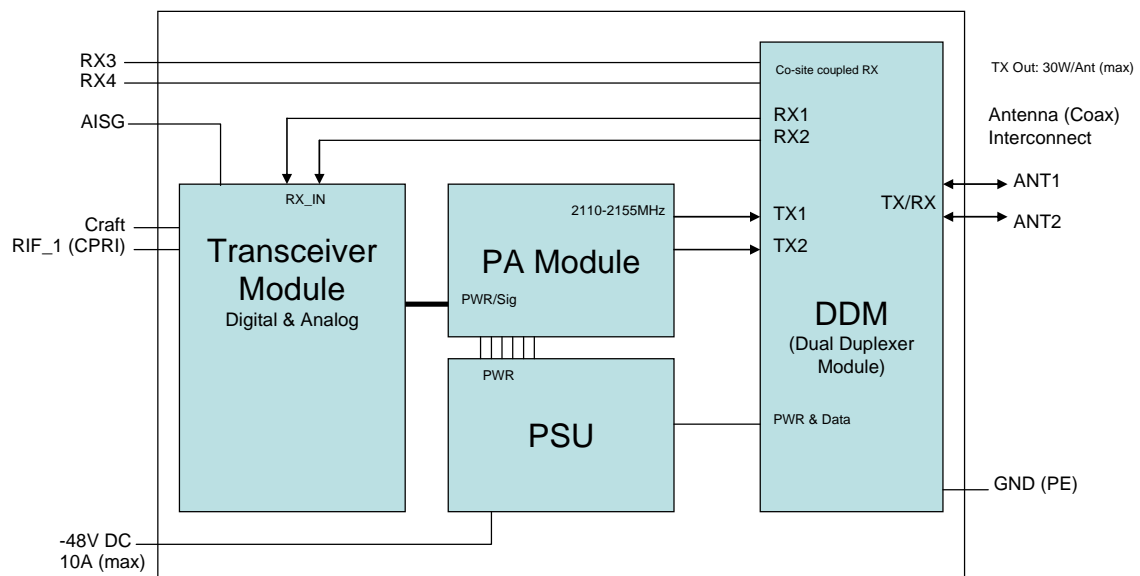

Figure 3-1: UUT – Block Diagram RRUL 11 B4 Co-Site AWS

4 Test Conditions

4.1 Specifications

The apparatus has been assessed against the following specifications:
FCC CFR 47 Part 27 Miscellaneous Wireless Communications Services

4.2 Test Environment

All tests are performed under the following environmental conditions:

Temperature range	:	15 – 30 °C
Humidity range	:	20 - 75 %
Pressure range	:	86 - 106 kPa
Power supply range	:	+/- 5% of rated voltages

4.3 Test Equipment

Table 4-1: Conducted Emissions - List of Test Equipment

Equipment	Manufacturer	Model No.	Asset/Serial No.	Cal Due
Signal Analyzer (20Hz-8.4GHz)	Agilent	MXA N9020A	1081485/MY47380104	15 Feb 2012
Signal Analyzer (20Hz-26.5GHz)	Agilent	MXA N9020A	1081485/MY47380593	02 Nov 2011
Attenuator 30dB (Qty=2)	Narda	769-30	NA	NA
Attenuator 20dB (Qty=2)	Meca	650-20-1F4	NA	NA
Network Analyzer (Path Loss Calibration)	Agilent	N5230	MY45000798	NA
Power Supply	Xantrex	XHR 60-18	62016	NCR
Digital Volt Meter	Fluke			

Table 4-2: Radiated Emissions - List of Test Equipment

Equipment	Manufacturer	Model No.	Asset/Serial No.	Next Cal.
10 m EMI Test Chamber				
Coaxial Cable # 27	Huber & Suhner	ST18/Nm/Nm/36, Sucoflex	SSG012786	1/26/2011
Coaxial Cable	Huber & Suhner	104B, Sucoflex	SSG012409	1/27/2011
Coaxial Cable # 3	Huber & Suhner	106A, Sucoflex	SSG012455	1/28/2011
Coaxial Cable # 2	Huber & Suhner	106A, Sucoflex	SSG012453	1/28/2011
Pre-Amplifier	BNR	LNA	SSG012360	2/15/2011
Double Ridged Horn	Emco	3115	SSG012298	2/19/2011
Double Ridged Horn	Emco	3115	SSG012267	3/12/2011
Spectrum Analyzer	Hewlett Packard	8564E	SSG012069	4/15/2011
Active Monopole Antenna	Emco	3301B	SSG012083	4/16/2011
Active Loop Antenna (H Field) 8529109000 ECCN EAR99	Emco	6502	SSG012276	5/17/2011
Spectrum Analyzer Display	Hewlett Packard	85662A	SSG013145	9/19/2011
Spectrum Analyzer	Hewlett Packard	8566B	SSG013144	9/19/2011
Spec. A, RF PreSelector	Hewlett Packard	85685A	SSG013143	9/20/2011
Signal Generator	Anritsu	69369A	SSG012138	9/22/2011
CDN	Fischer Custom Communications Inc.	FCC-801-M3-25A	SSG012045	9/23/2011
Coaxial Cable # 14	Huber & Suhner	104PEA, Sucoflex	SSG012041	10/7/2011
Bilog Antenna HTS 8529109000 5A991	Antenna Research Associates	LPB 2520A	SSG012772	12/20/2011
Coaxial Cable # 12	Huber & Suhner	104PEA, Sucoflex	SSG012716	1/4/2012
18-26.5-40 GHz, Sucoflex, Cable H4	Huber & Suhner	102A	SSG013084	1/7/2012
10-18 GHz, Coaxial Cable H3	Micro-Coax	UFA 210B-1-1500-504504, Utiflex	SSG012376	1/10/2012
Note: N/A = Not Applicable, NCR = No Cal Required, COU = CAL On Use				

5 Applicable Tests

This section contains the following:

FCC CFR 47 Part 27: Test Requirements

The column headed 'Required' indicates whether the associated clauses were invoked for the apparatus under test. The following abbreviations are used:

N No: Not Applicable / Not Relevant.

Y Yes: Mandatory i.e. the apparatus shall conform to these tests.

N/T Not Tested

The results compiled in this document are in accordance and representative of the operation of the apparatus as originally submitted.

5.1 FCC Part 27: Test Parameters

Table 5-1: Applicable Test Parameters / Results Summary

Clause	Test Method	Test description	Required	Result
27.50(d)	2.1046	RF Output Power	Y	Pass
-----	2.1047	Modulation Characteristics	Y	Pass
-----	2.1049	Occupied Bandwidth	Y	Pass
27.53(h)	2.1051	Band Edge Compliance	Y	Pass
27.53(h)	2.1051	Spurious Emissions at the Antenna Terminal	Y	Pass
27.53(h)	2.1053, 2.1057	Field Strength of Spurious Emissions	Y	Pass
27.54	2.1055	Frequency Stability	Y	Pass

6 Test Results

6.1 Effective Radiated Power

Clause 27.50(d) Limits: FCC CFR Part 2.1046 Fixed Base Station

(d) The following power and antenna height requirements apply to stations transmitting in the 1710–1755 MHz and 2110–2155 MHz bands:

(1) The power of each fixed or base station transmitting in the 2110–2155 MHz band and located in any county with population density of 100 or fewer persons per square mile, based upon the most recently available population statistics from the Bureau of the Census, is limited to a peak equivalent isotropically radiated power (EIRP) of 3280 watts. The power of each fixed or base station transmitting in the 2110–2155 MHz band from any other location is limited to a peak EIRP of 1640 watts. A licensee operating a base or fixed station utilizing a power of more than 1640 watts EIRP must coordinate such operations in advance with all Government and non-Government satellite entities in the 2025–2110 MHz band. Operations above 1640 watts EIRP must also be coordinated in advance with the following licensees within 120 kilometers (75 miles) of the base or fixed station: all Broadband Radio Service (BRS) licensees authorized under part 27 in the 2155–2160 MHz band and all AWS licensees in the 2110–2155 MHz band.

Test Conditions:

All modulation (QPSK, 16QAM, and 64QAM) modes and different data rates are evaluated using representative waveforms of all modulation schemes. The test results shall include 1.4MHz bandwidth configurations for Lower, Middle and Upper band frequency offsets as applicable.

Physical Channels

A downlink physical channel corresponds to a set of resource elements carrying information originating from higher layers and is the interface defined between 36.212 and 36.211 [15]. The following downlink physical channels are defined:

- Physical Downlink Shared Channel, PDSCH – QPSK, 16QAM, 64QAM
- Physical Broadcast Channel, PBCH - QPSK
- Physical Downlink Control Channel, PDCCH - QPSK
- Physical Control Format Indicator Channel, PCFICH - QPSK
- Physical Hybrid ARQ Indicator Channel, PHICH - BPSK

LTE standard defines BPSK as an ARQ Indicator Channel, thus being embedded into the LTE signal and does not contain traffic data. As BPSK is embedded in each modulation scheme, waveforms tested represent the worst case conditions.

Test Setup

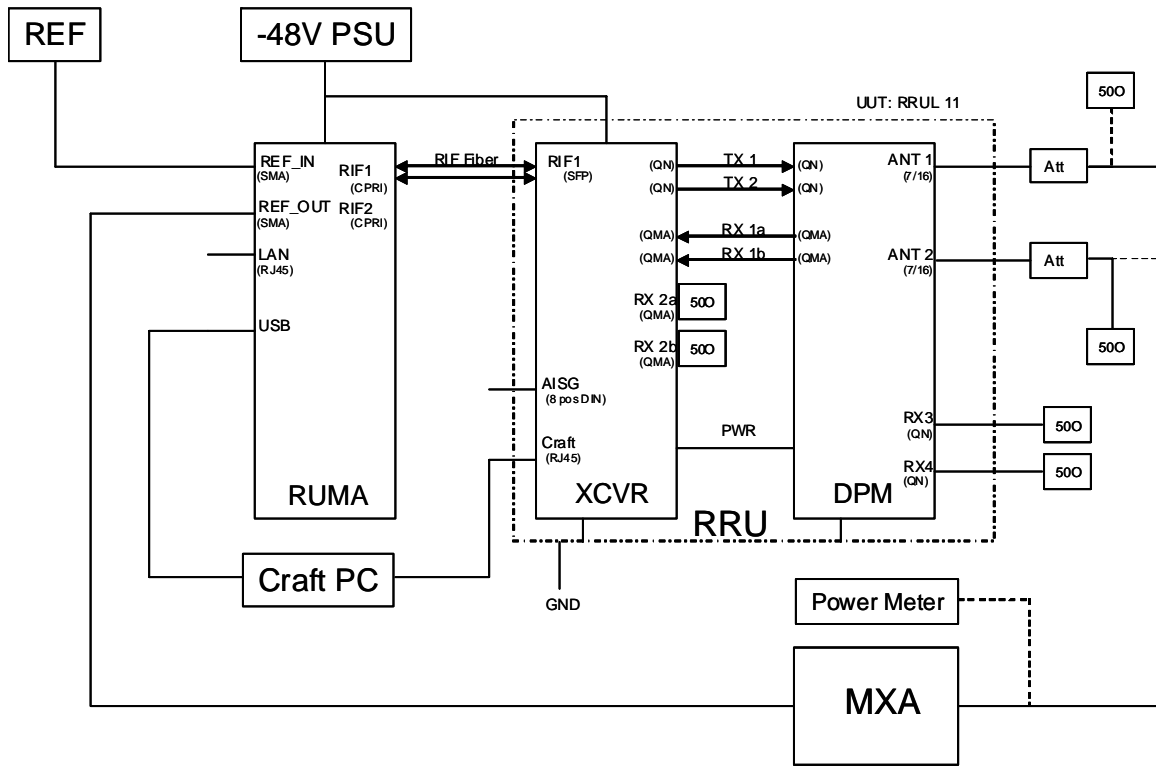

Figure 6-1: RRU Radio Compliance Set Up / Configuration

Procedure:

Channel Power measurements for each output shall be conducted for the applicable bandwidths and modulation schemes for the Lower, Middle and Upper frequency offsets as warranted. The following tables are used to summarize recorded results in addition to applicable captured plots.

Table 6-1: Setting / Measurement Results – 1.4MHz Channel Power

Setting			1.4MHz Channel Power Output (dBm)					
			QPSK		16 QAM		64 QAM	
			TX1	TX2	TX1	TX2	TX1	TX2
Frequency	(Lower CH_1957)	2110.7MHz	44.83	44.61	44.91	44.65	44.73	44.60
Frequency	(Middle CH_2175)	2132.5MHz	44.66	44.81	44.71	44.89	44.74	44.70
Frequency	(Upper CH_2393)	2154.3MHz	44.82	44.72	44.77	44.67	44.93	44.78
RBW	180kHz							
VBW	1.8MHz							
CH BW	1.4MHz							
Span	5MHz							
Sweep	1ms							
Reference Level Offset	52.25dB							
Detector	RMS		Aggregate Power = $10^{(10 \cdot \text{LOG}(10^{(TX1/10)} + 10^{(TX2/10)})/10)/1000}$					
Attenuation	10dB		59.99W		60.41W		61.18W	

1.4MHz Aggregate Power = TX1 + TX2
 $= 10 \cdot \log(10^{(44.93/10)} + 10^{(44.78/10)}) = 47.87\text{dBm}/1.4\text{MHz} = 10^{(47.87/10)/1000} = \mathbf{61.18W/1.4MHz}$

5MHz Aggregate Power = TX1 + TX2
 $= 10 \cdot \log(10^{(44.80/10)} + 10^{(44.88/10)}) = 47.85\text{dBm}/5\text{MHz} = 10^{(47.85/10)/1000} = \mathbf{60.96W/5MHz}$

10MHz Aggregate Power = TX1 + TX2
 $= 10 \cdot \log(10^{(44.92/10)} + 10^{(44.88/10)}) = 47.91\text{dBm}/10\text{MHz} = 10^{(47.91/10)/1000} = \mathbf{61.81W/10MHz}$

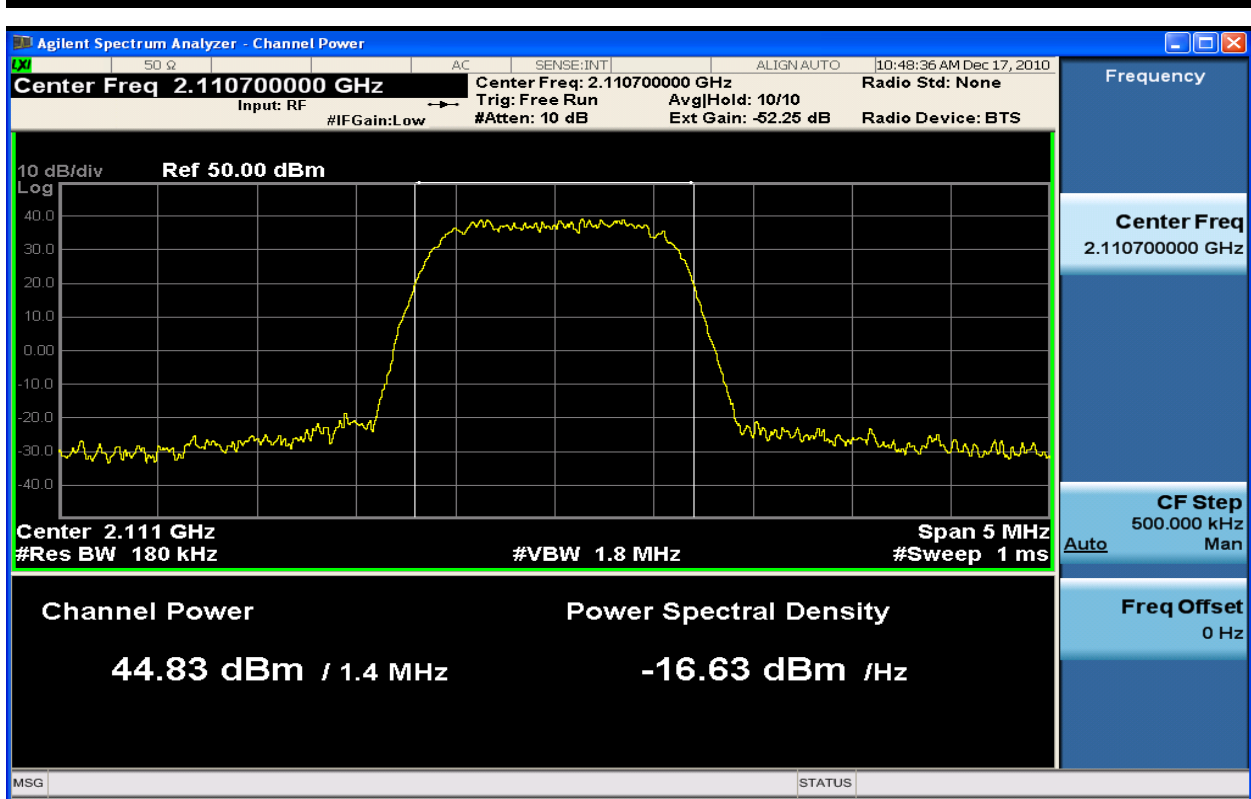

Figure 6-2: 1.4MHz BW Channel Power TX1_QPSK at 2110.7 MHz

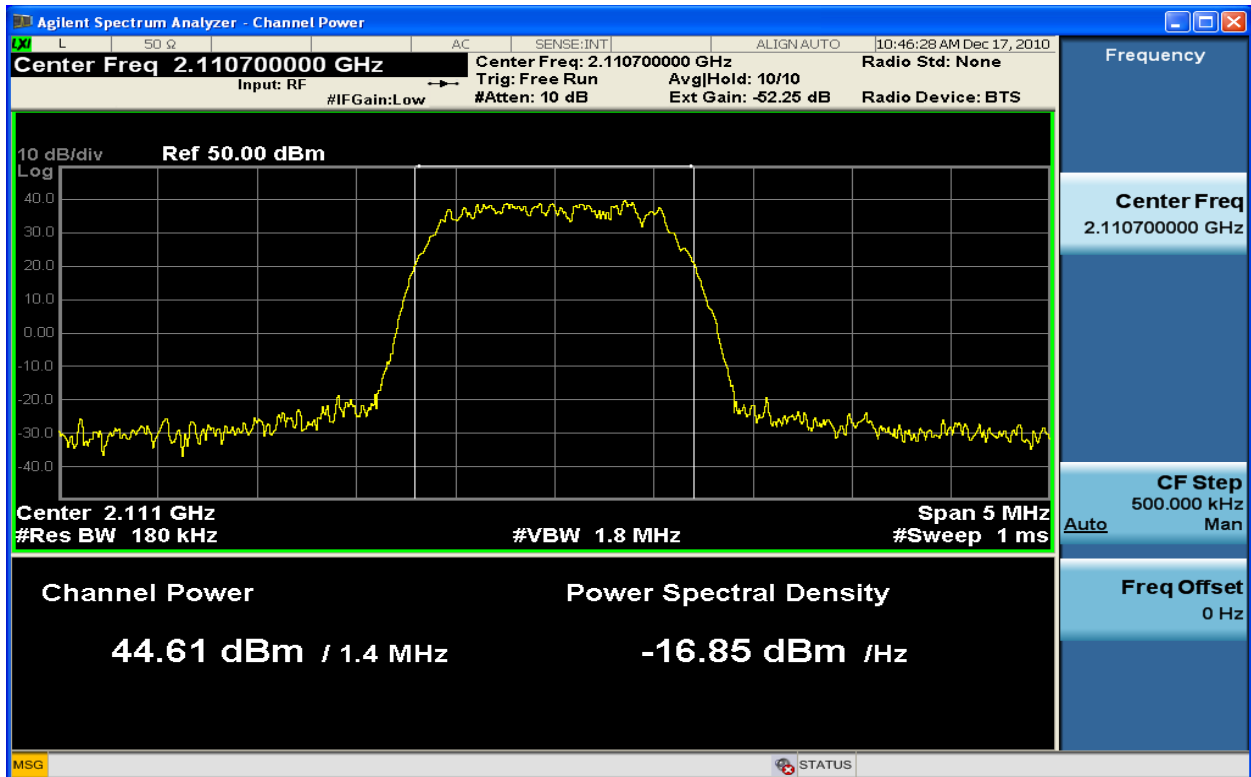

Figure 6-3: 1.4MHz BW Channel Power TX2_QPSK at 2110.7 MHz

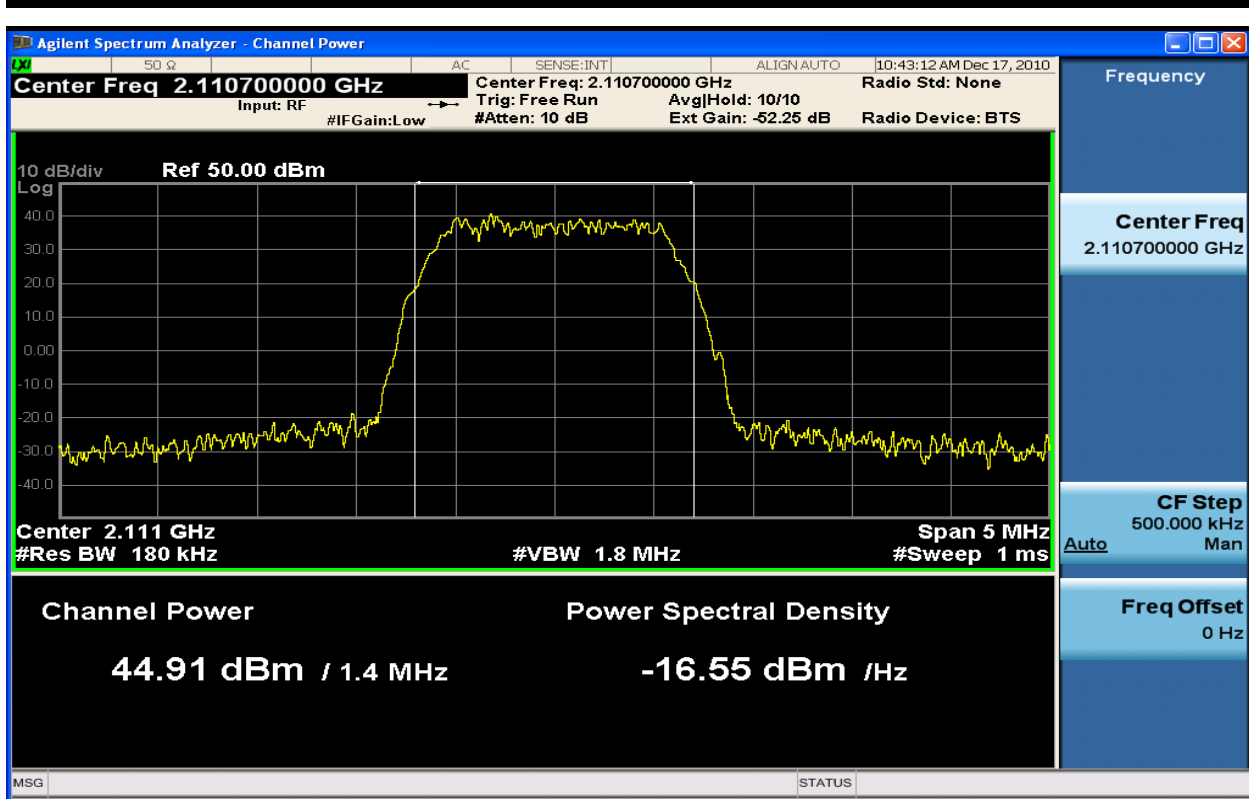

Figure 6-4: 1.4MHz BW Channel Power TX1_16QAM at 2110.7 MHz

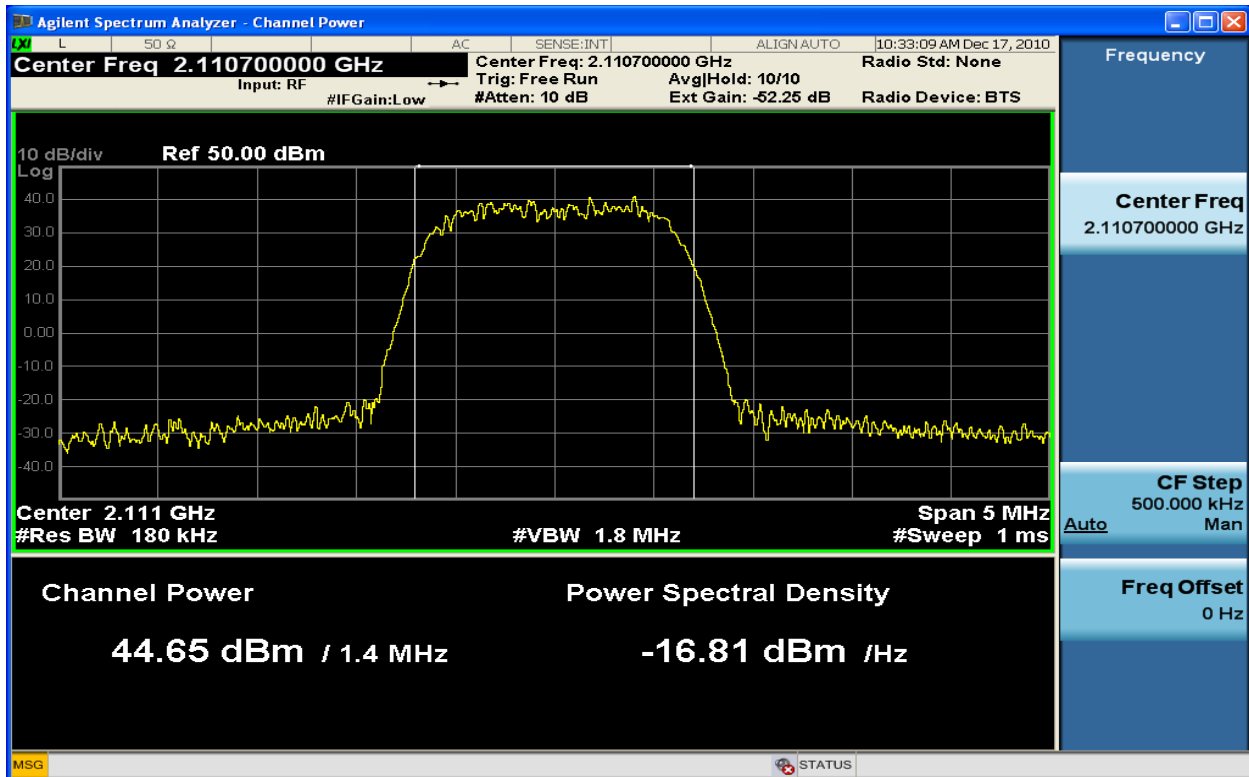

Figure 6-5: 1.4MHz BW Channel Power TX2_16QAM at 2110.7 MHz

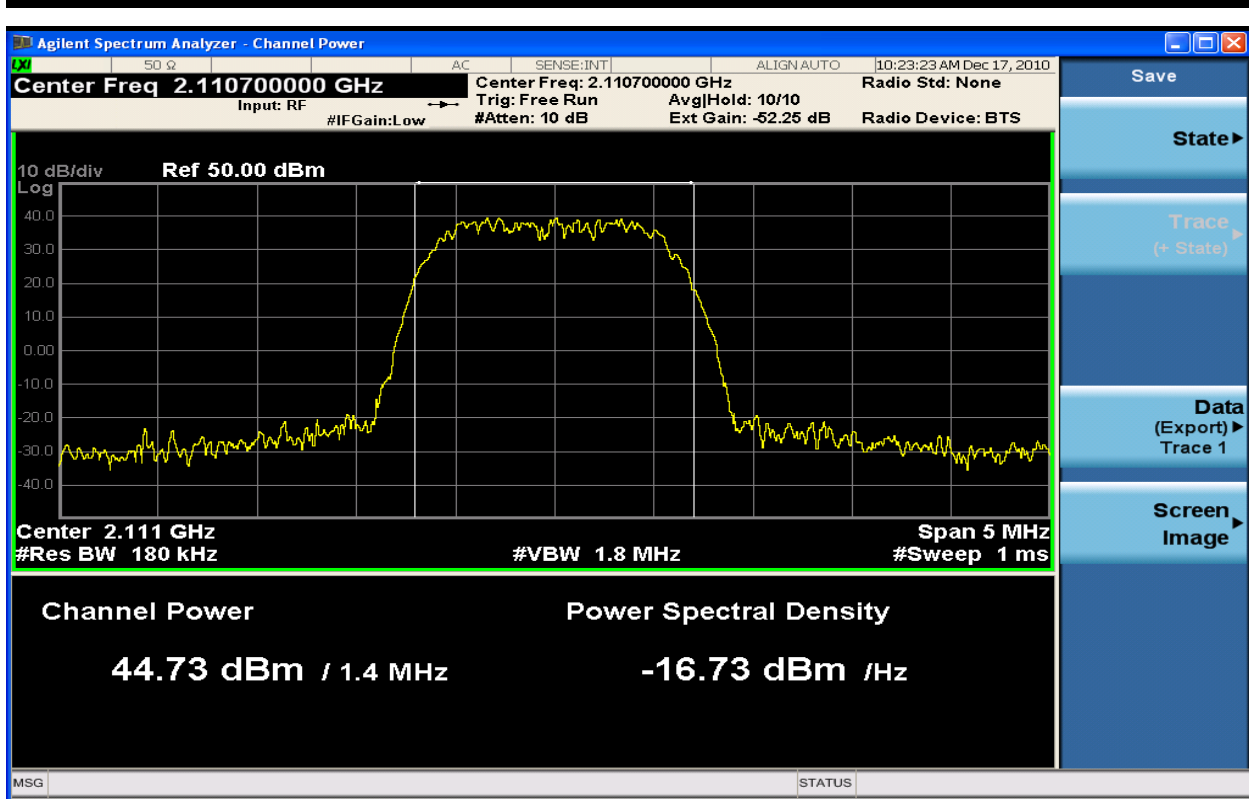

Figure 6-6: 1.4MHz BW Channel Power TX1_64QAM at 2110.7 MHz

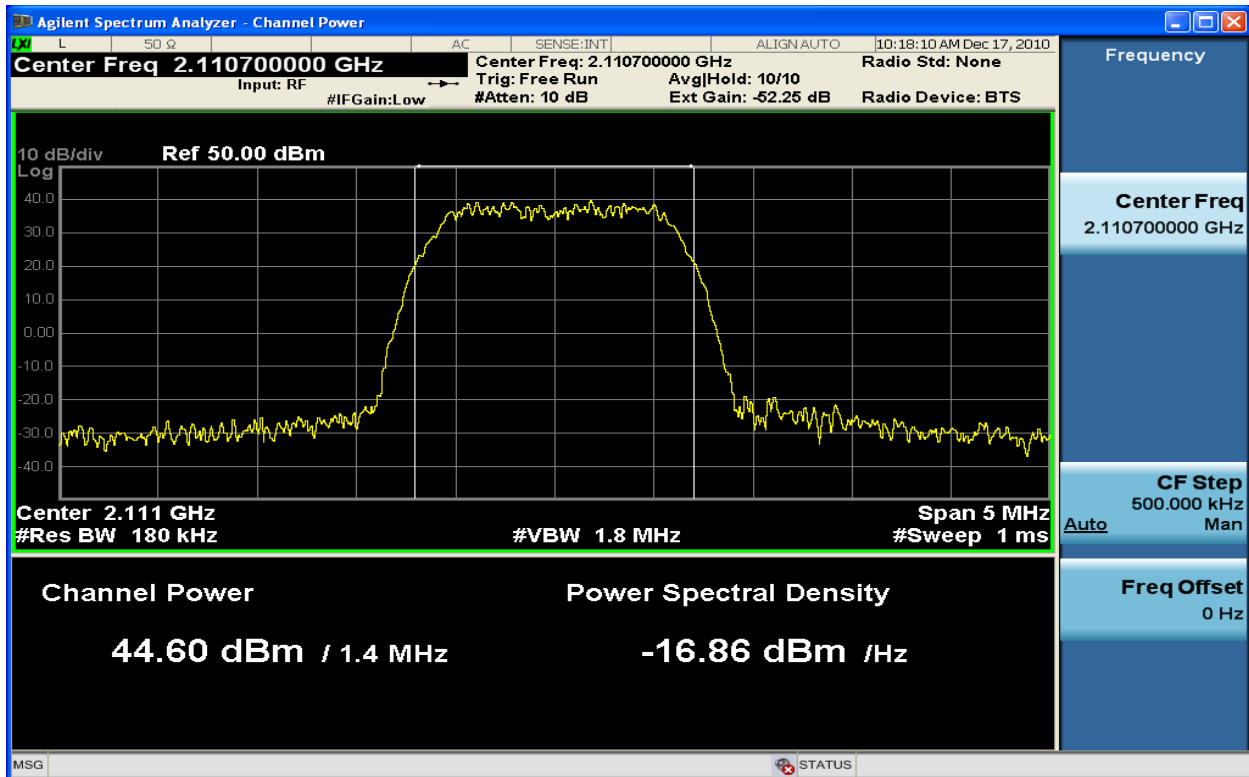

Figure 6-7: 1.4MHz BW Channel Power TX2_64QAM at 2110.7 MHz

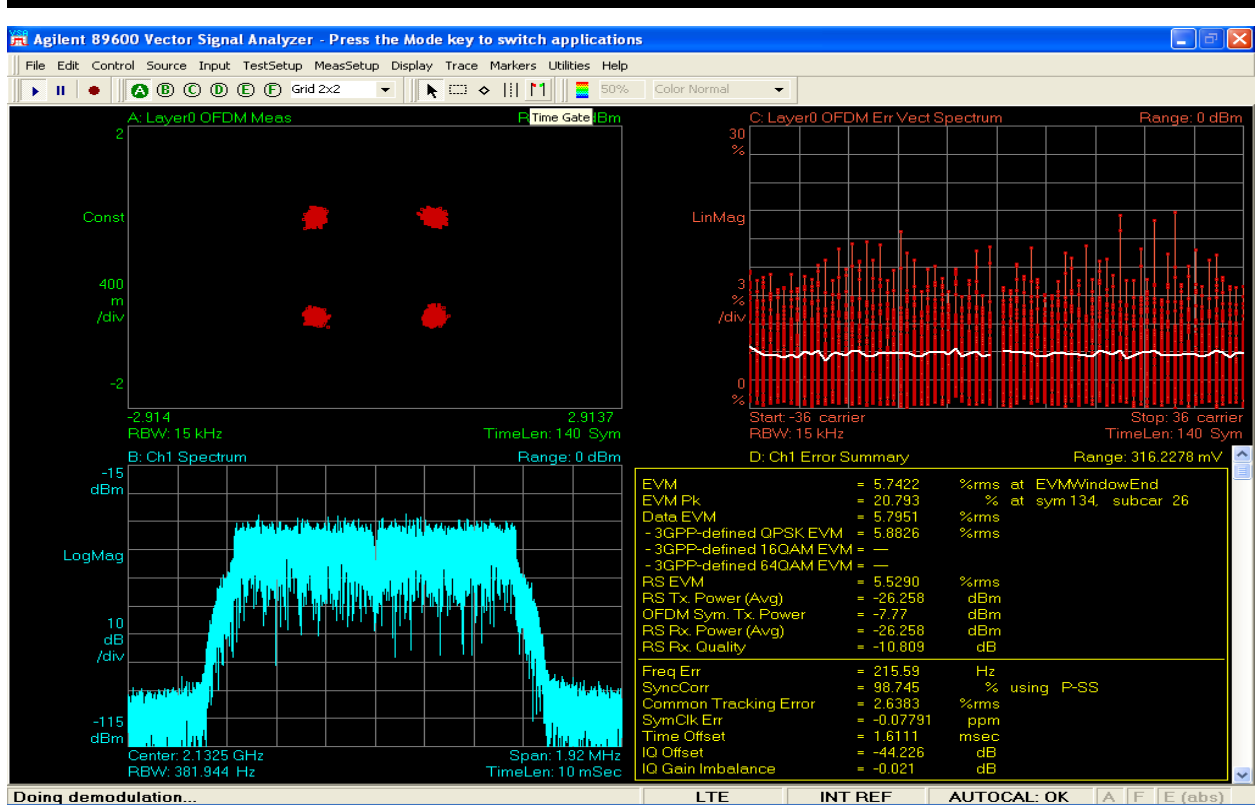

Figure 6-8: 1.4MHz BW Modulation TX1_QPSK at 2132.5 MHz

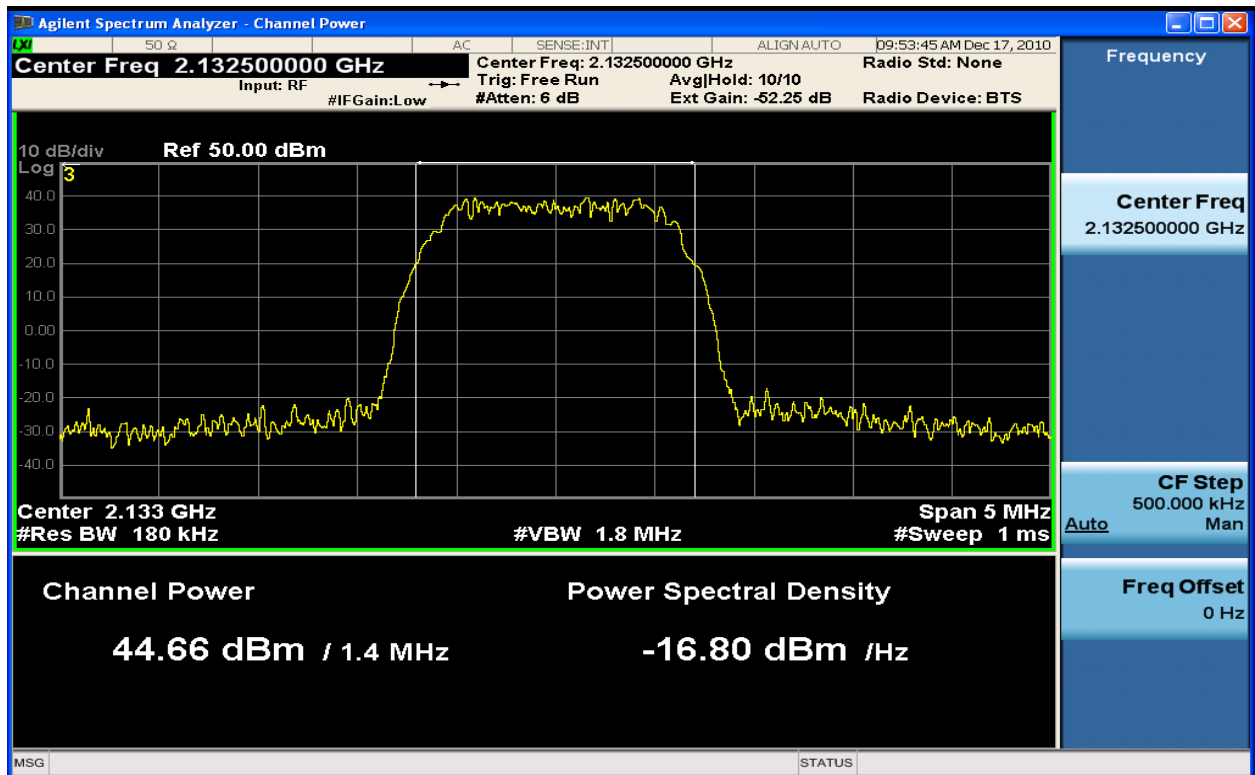

Figure 6-9: 1.4MHz BW Channel Power TX1_QPSK at 2132.5 MHz

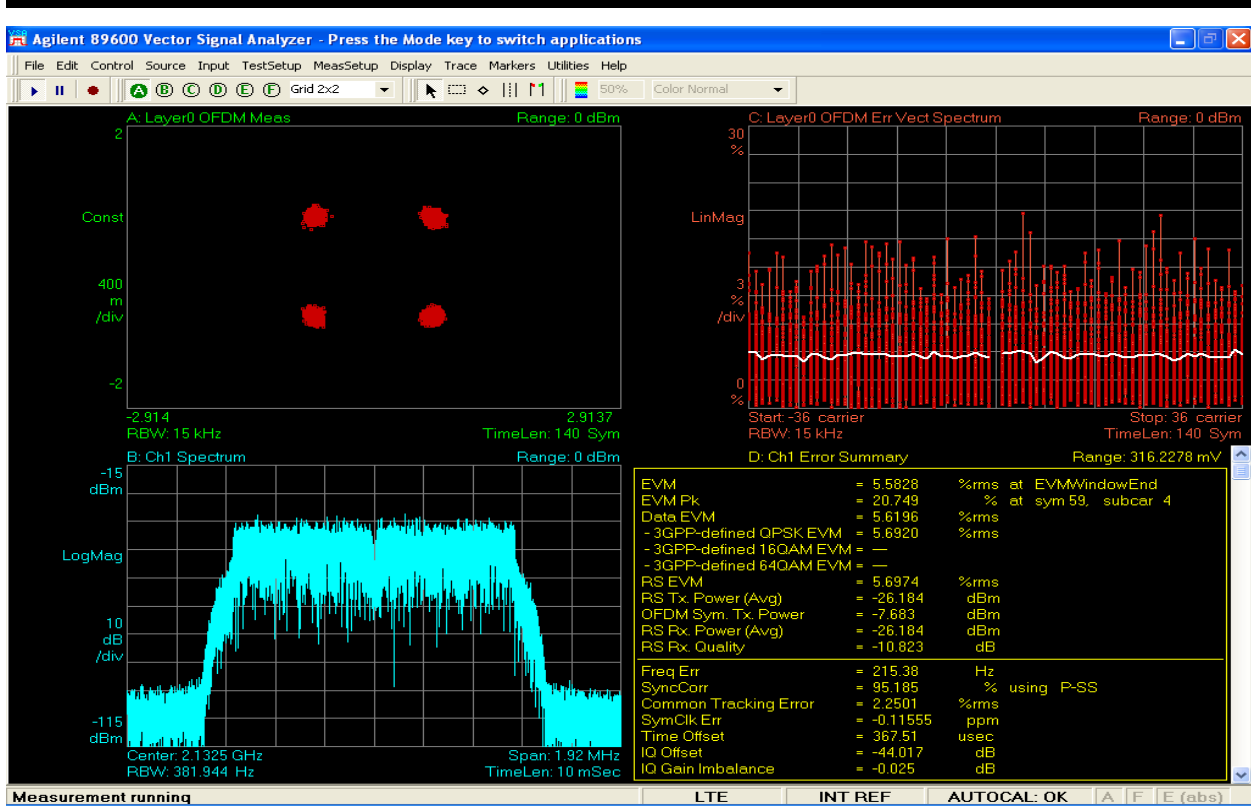

Figure 6-10: 1.4MHz BW Modulation TX2_QPSK at 2132.5 MHz

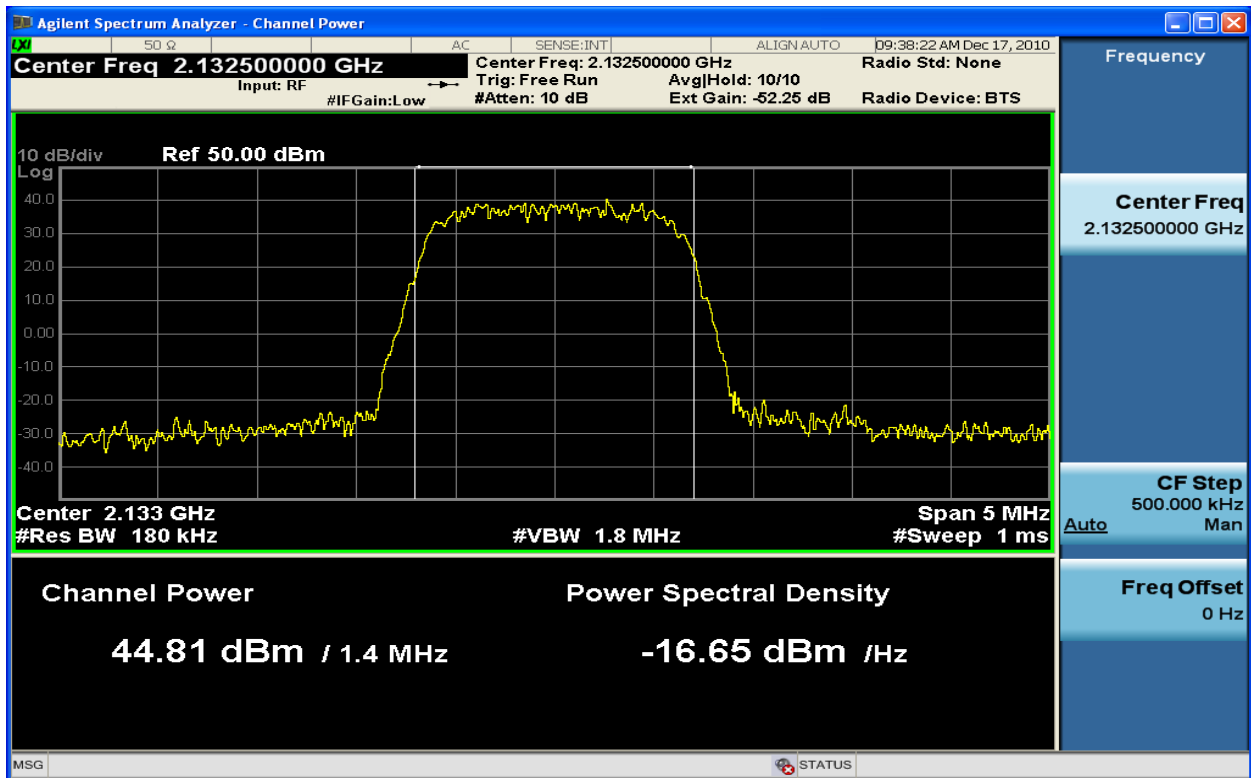

Figure 6-11: 1.4MHz BW Channel Power TX2_QPSK at 2132.5 MHz

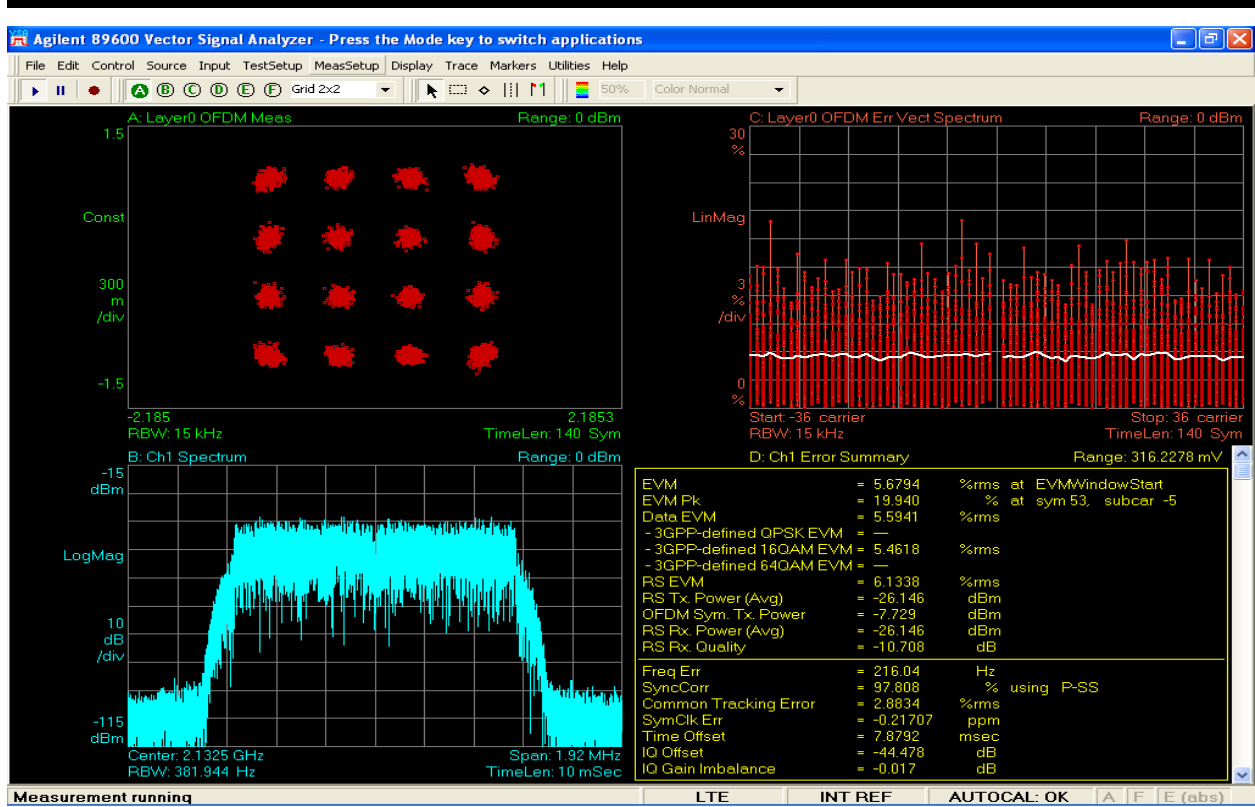

Figure 6-12: 1.4MHz BW Modulation TX1_16QAM at 2132.5 MHz

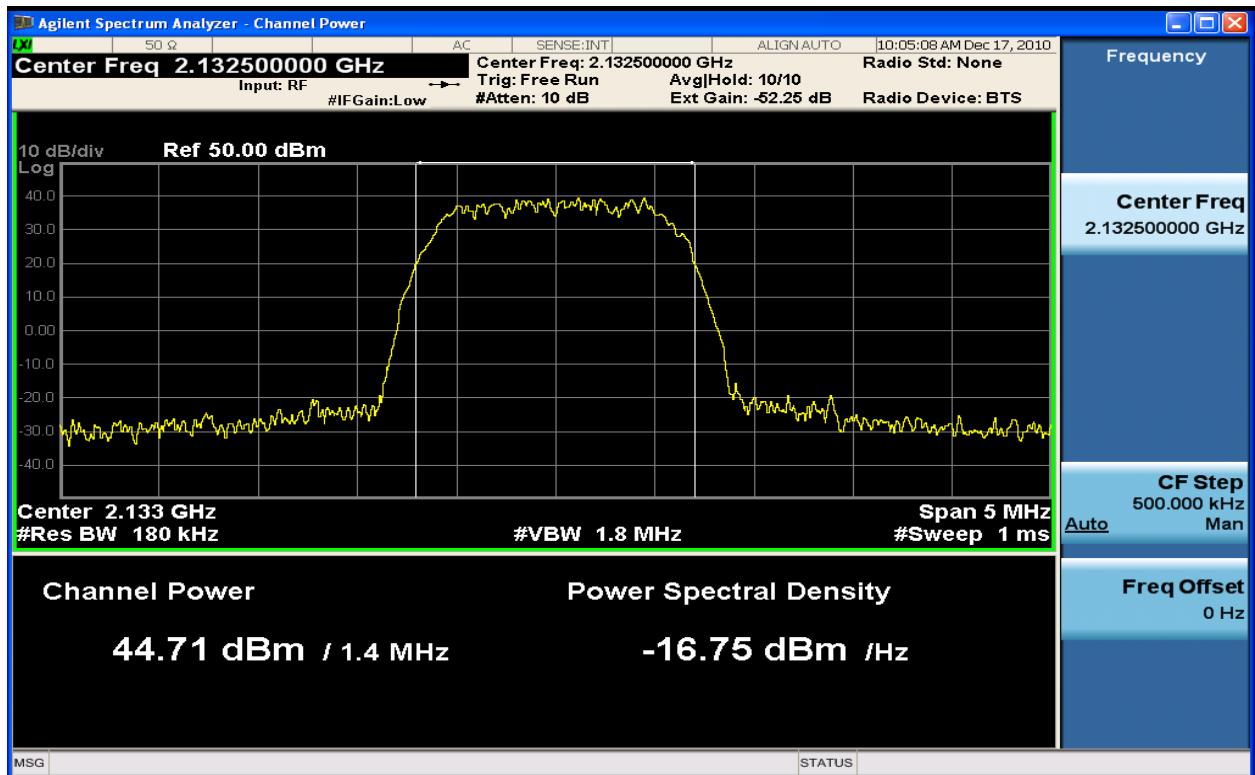

Figure 6-13: 1.4MHz BW Channel Power TX1_16QAM at 2132.5 MHz

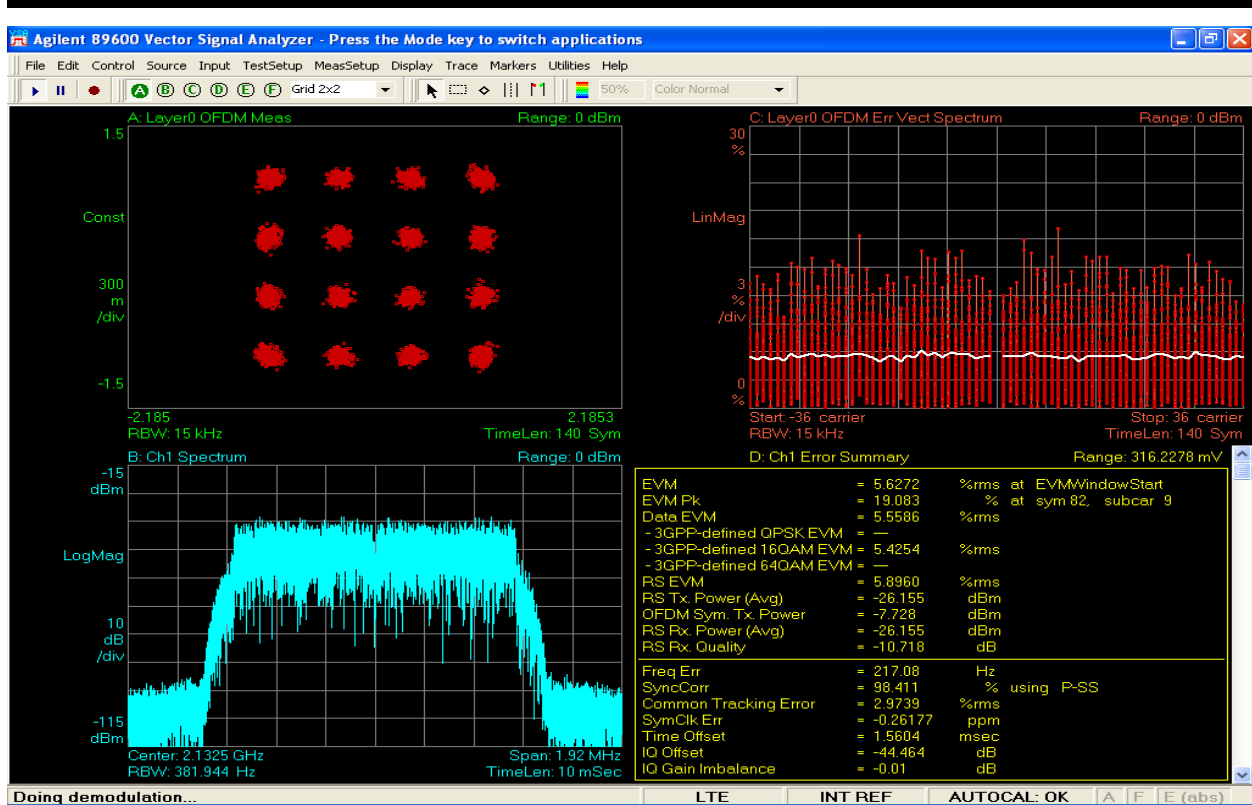

Figure 6-14: 1.4MHz BW Modulation TX2_16QAM at 2132.5 MHz

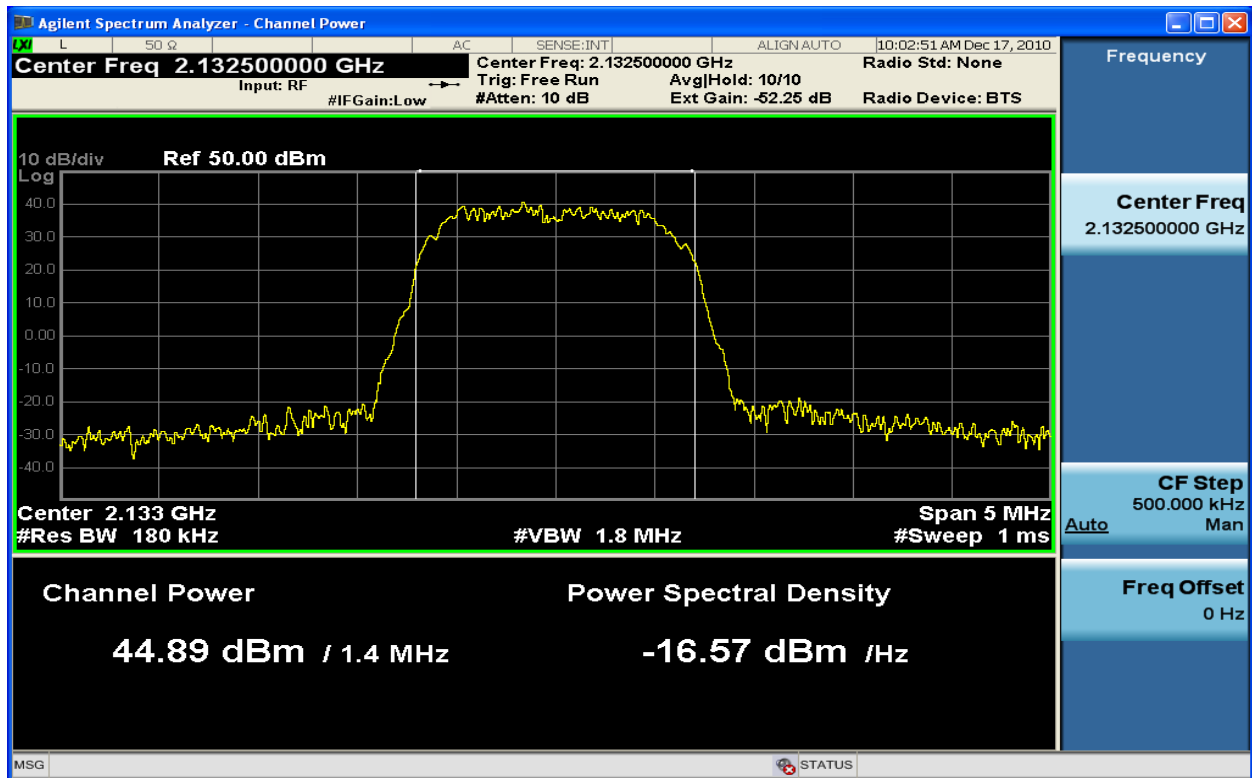

Figure 6-15: 1.4MHz BW Channel Power TX2_16QAM at 2132.5 MHz

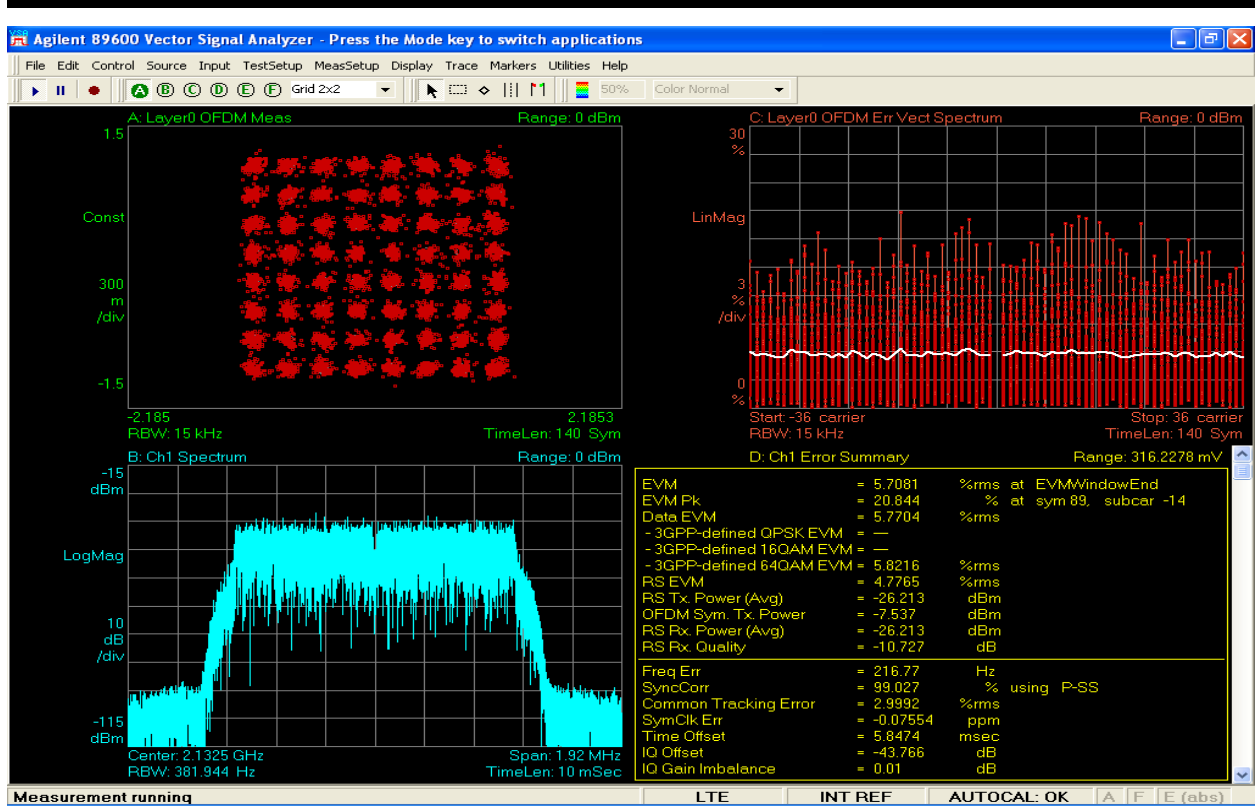

Figure 6-16: 1.4MHz BW Modulation TX1_64QAM at 2132.5 MHz

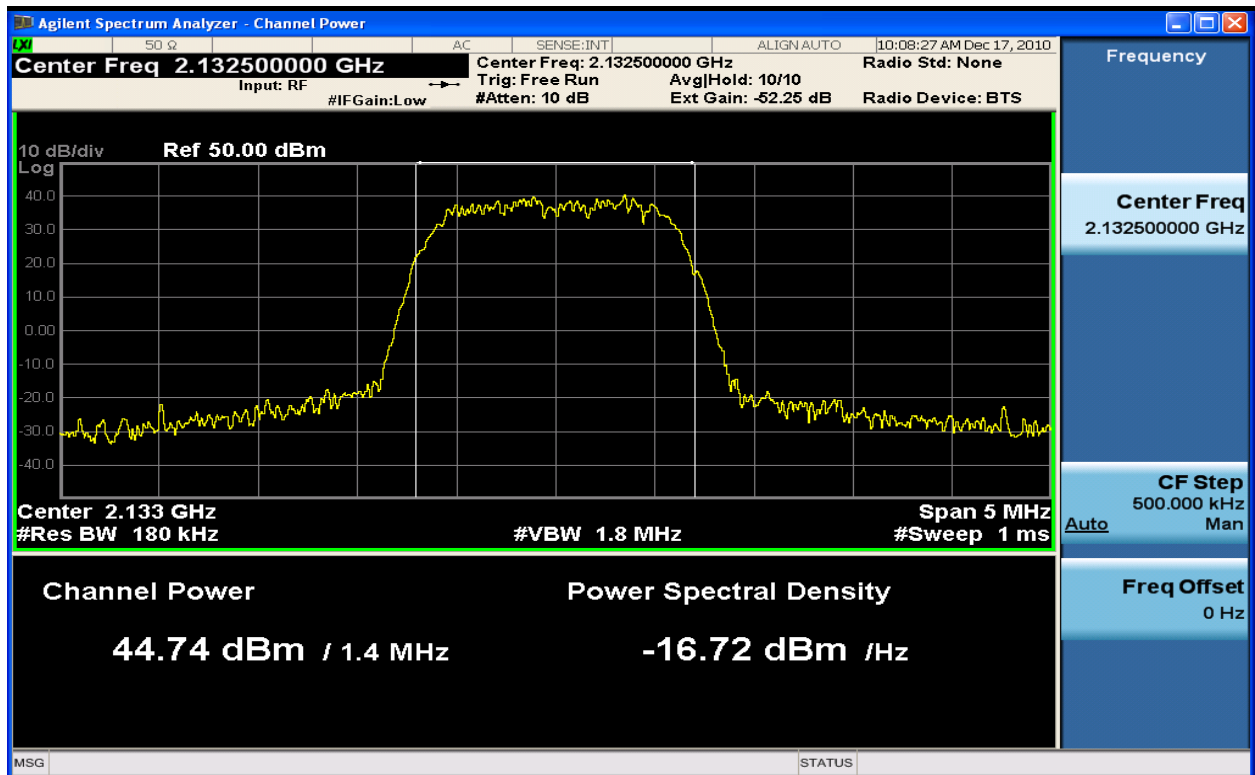

Figure 6-17: 1.4MHz BW Channel Power TX1_64QAM at 2132.5 MHz

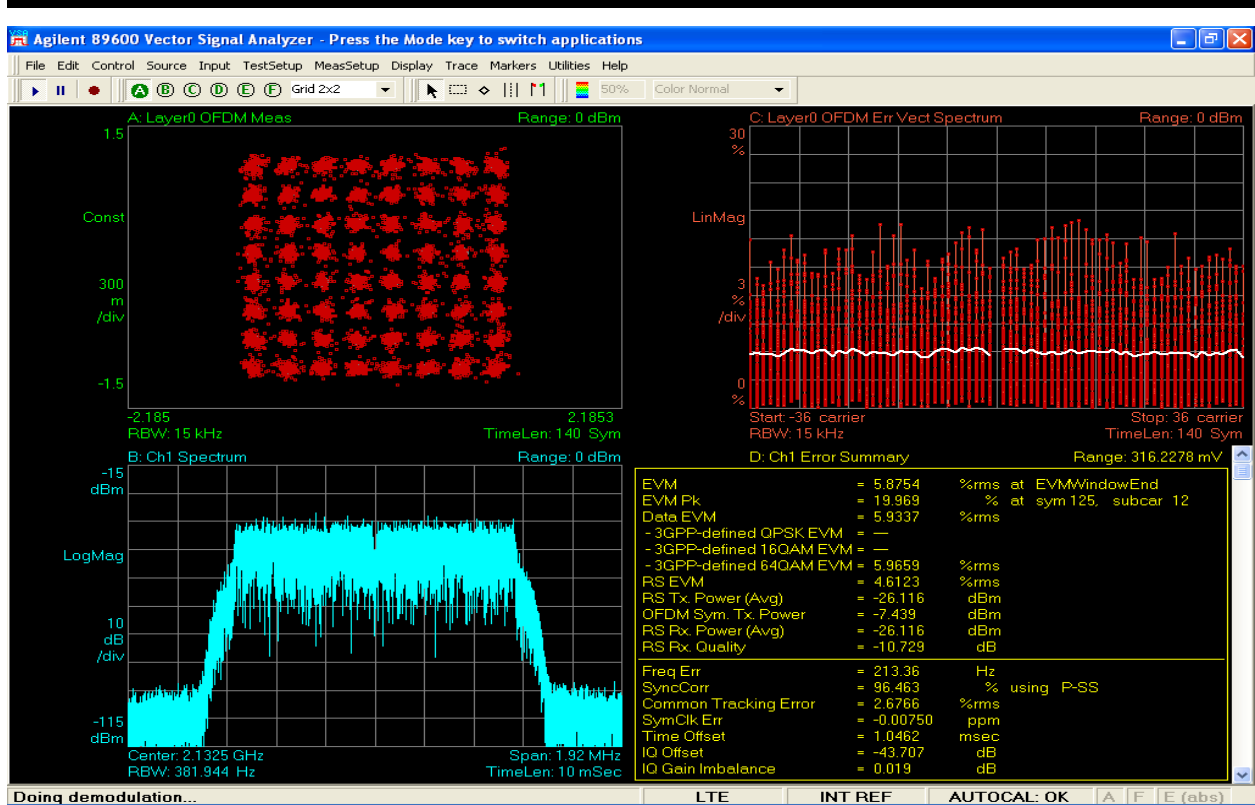

Figure 6-18: 1.4MHz BW Modulation TX2_64QAM at 2132.5 MHz

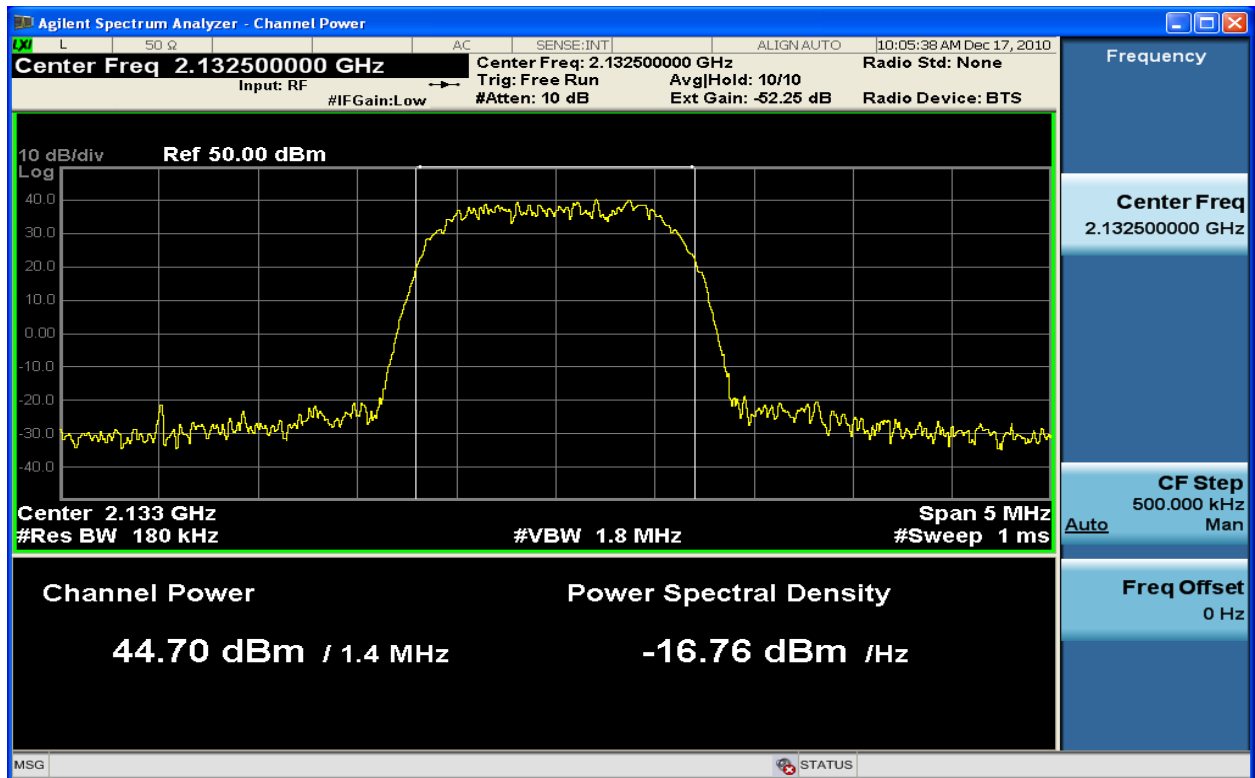

Figure 6-19: 1.4MHz BW Channel Power TX2_64QAM at 2132.5 MHz

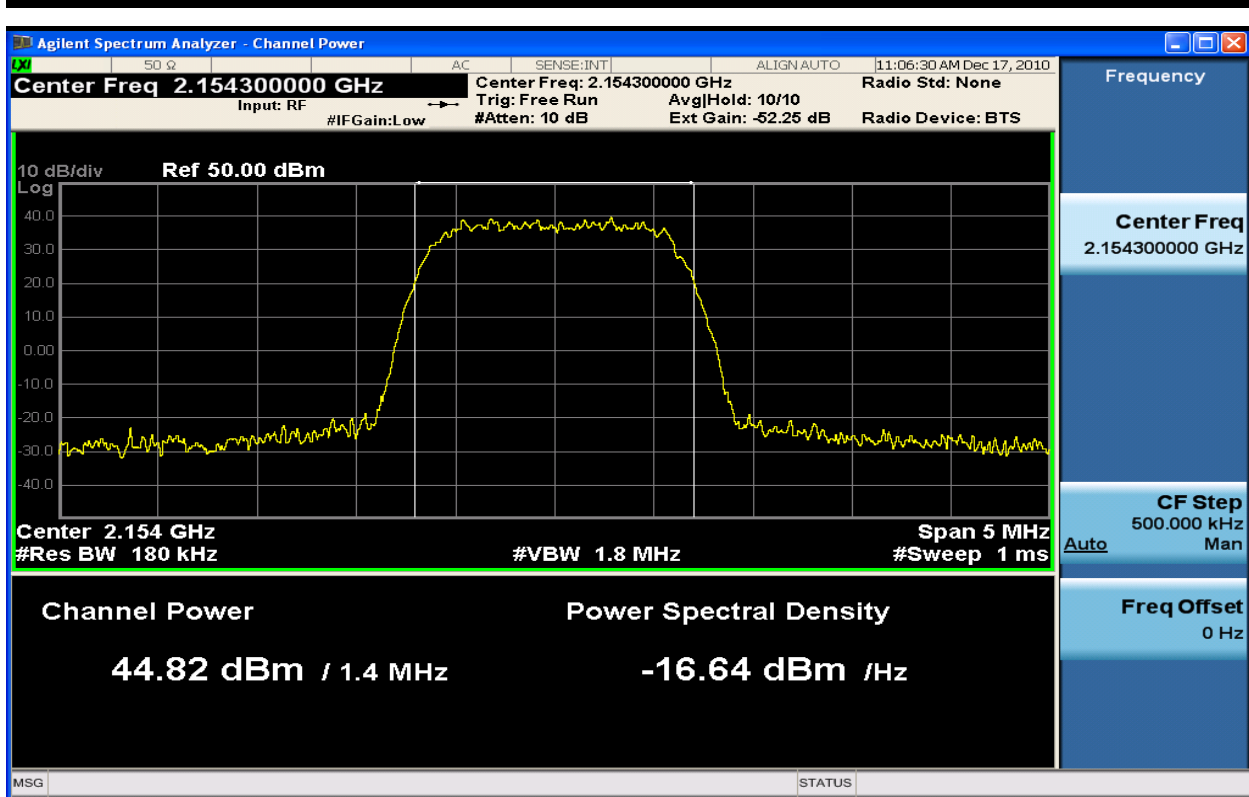

Figure 6-20: 1.4MHz BW Channel Power TX1_QPSK at 2154.3 MHz

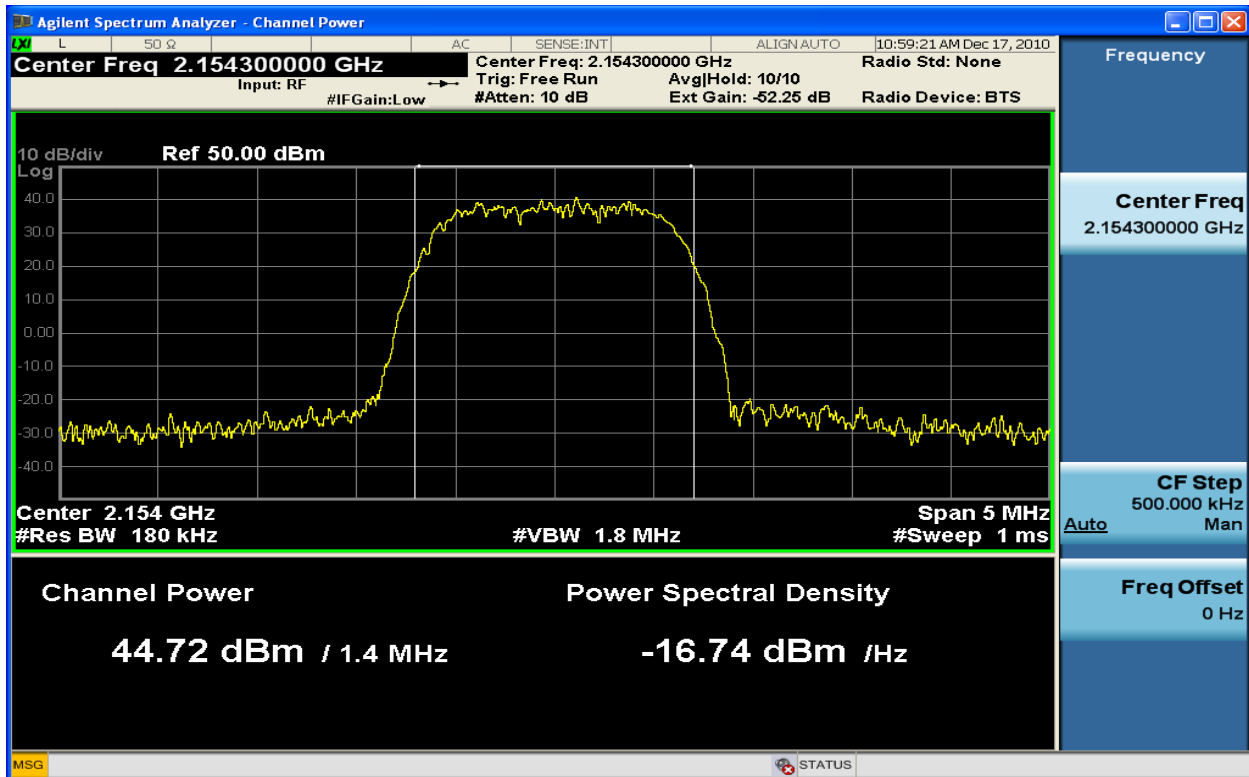

Figure 6-21: 1.4MHz BW Channel Power TX2_QPSK at 2154.3 MHz

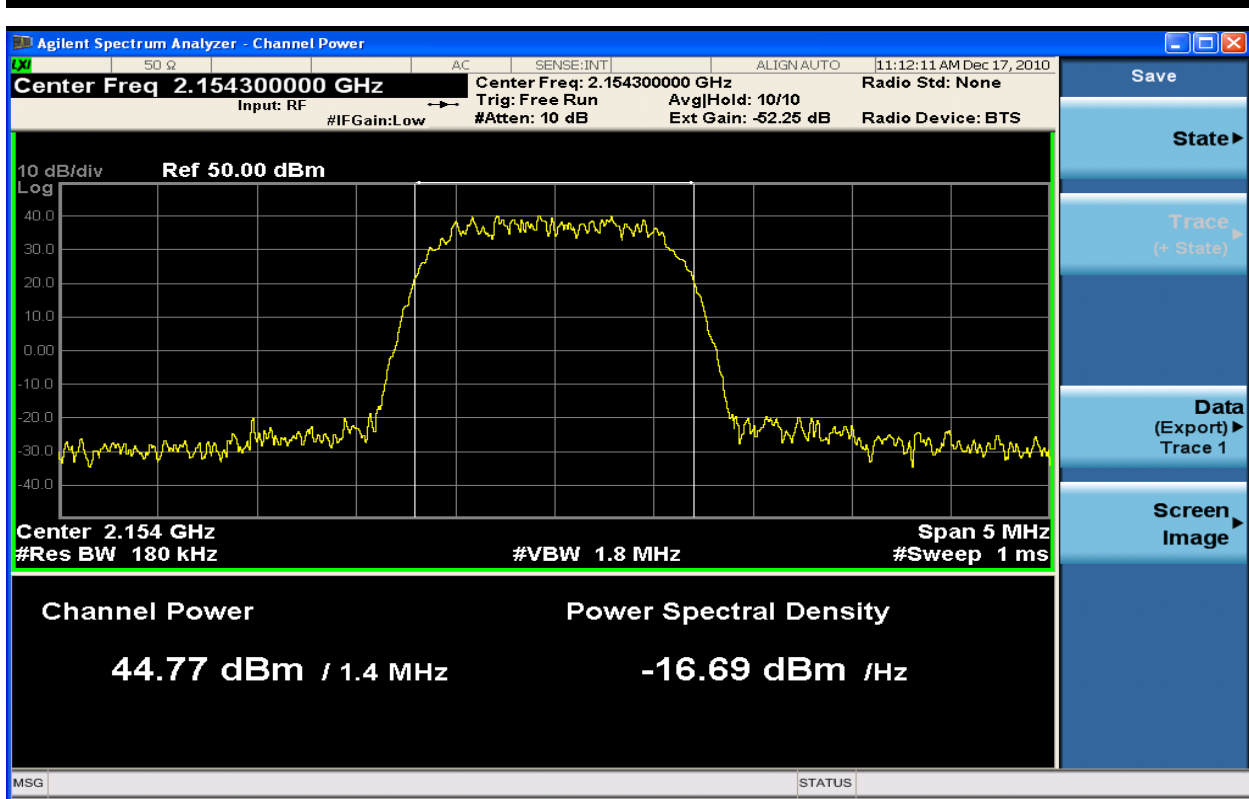

Figure 6-22: 1.4MHz BW Channel Power TX1_16QAM at 2154.3 MHz

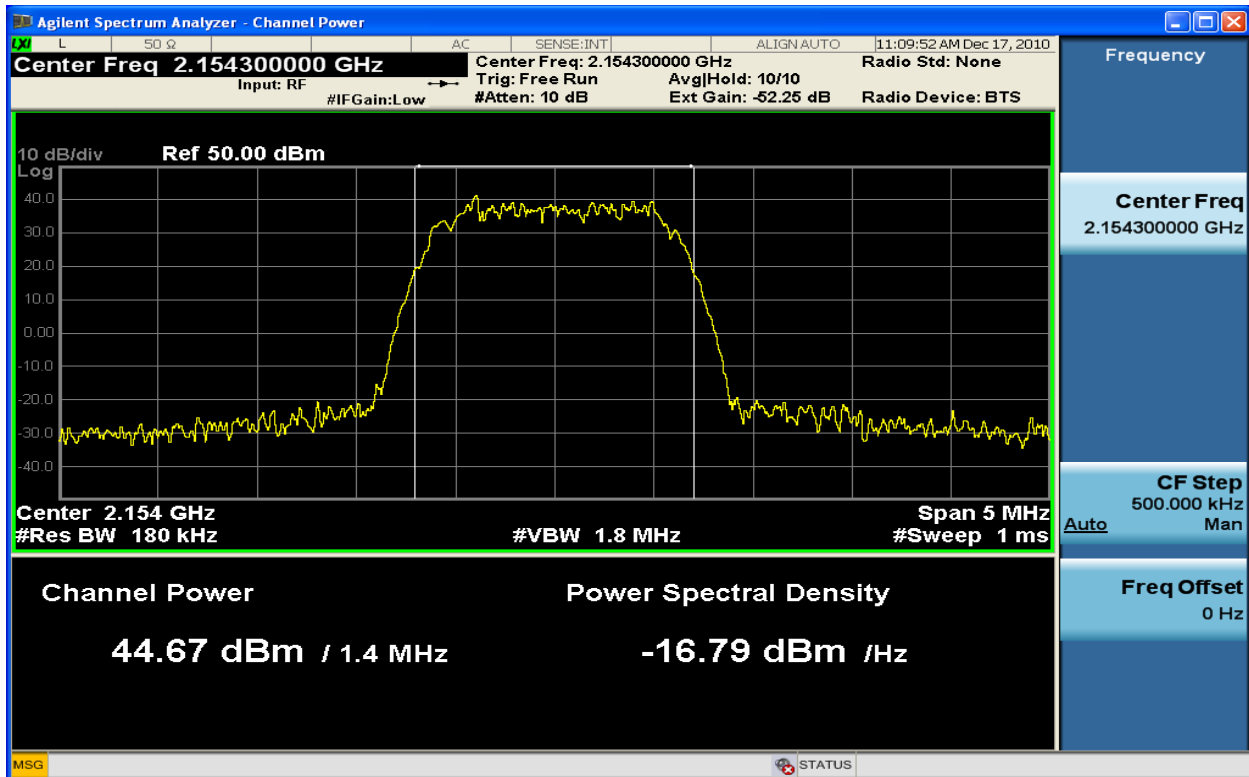

Figure 6-23: 1.4MHz BW Channel Power TX2_16QAM at 2154.3 MHz

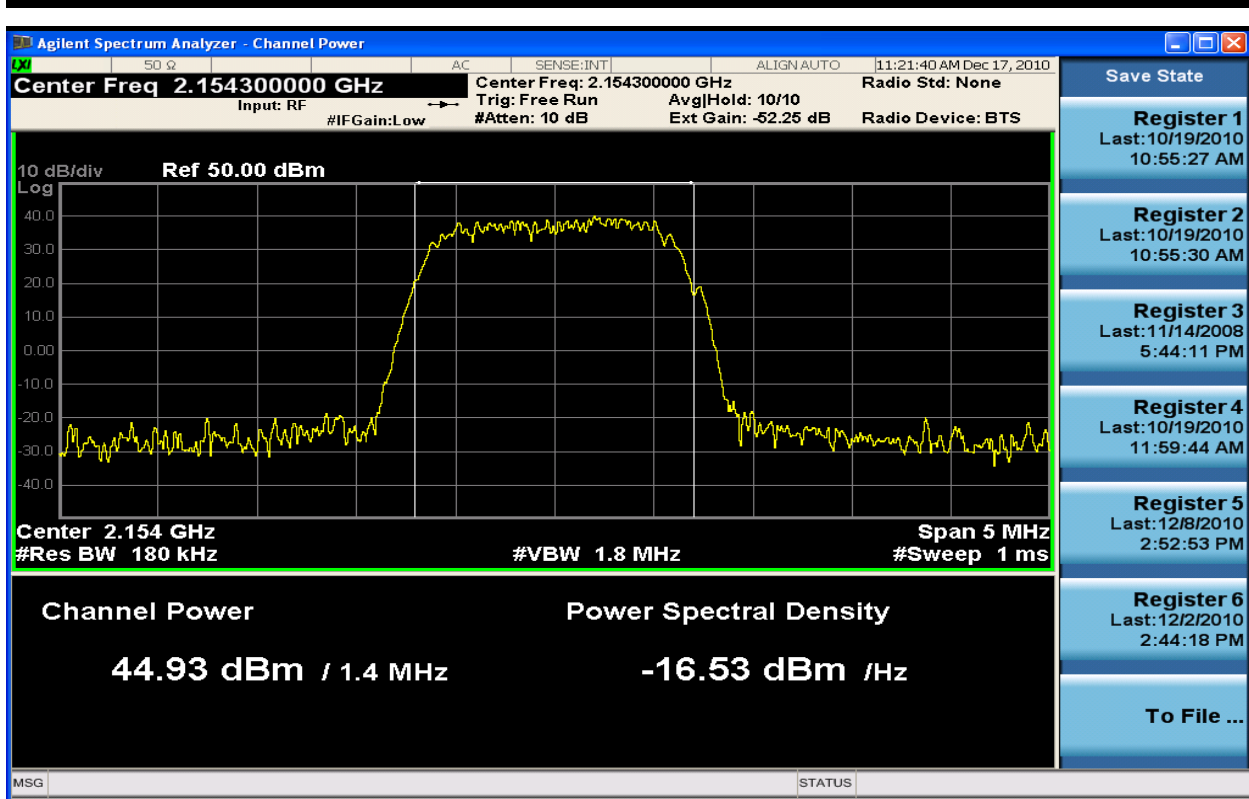

Figure 6-24 : 1.4MHz BW Channel Power TX1_64QAM at 2154.3 MHz

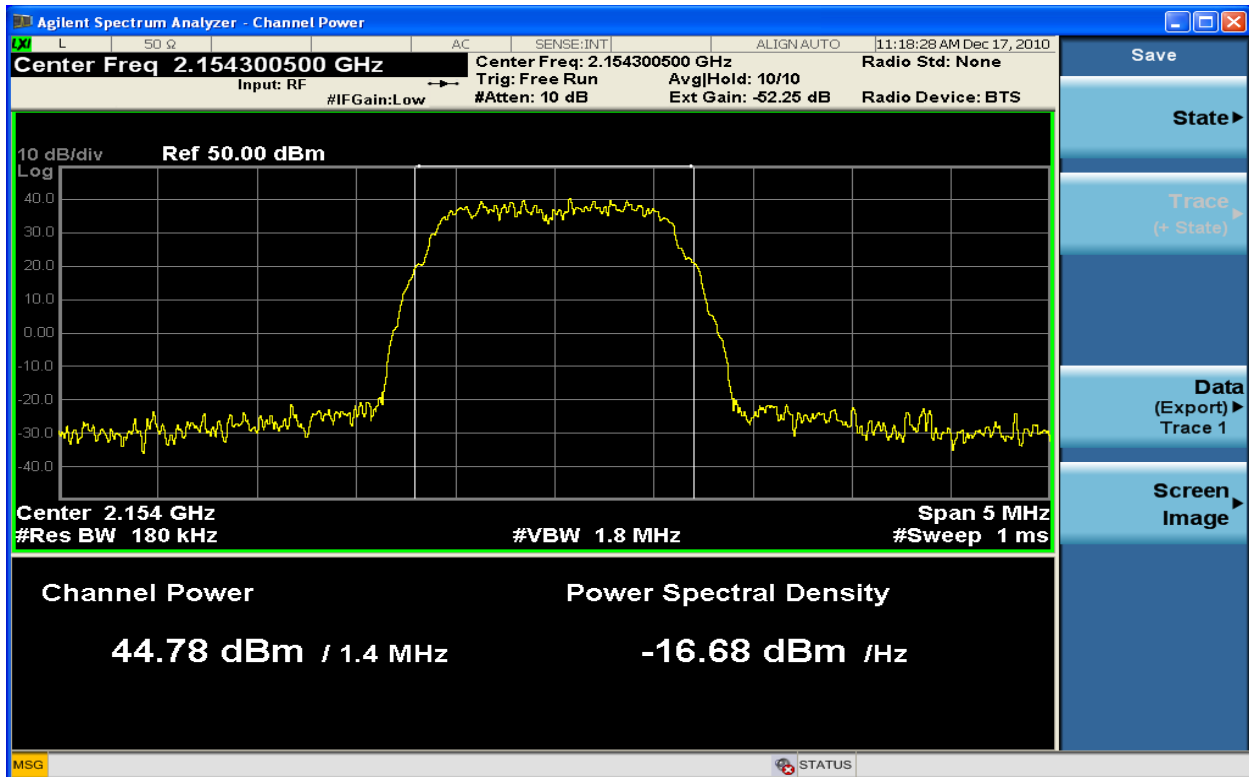

Figure 6-25 : 1.4MHz BW Channel Power TX2_64QAM at 2154.3 MHz

6.2 Occupied Bandwidth

Clause 27.50 2.1049

(a) *Occupied bandwidth.* The frequency bandwidth such that, below its lower and above its upper frequency limits, the mean powers radiated are each equal to 0.5 percent of the total mean power radiated by a given emission. Occupied BW is the portion of the spectrum which contains 99% of the emitted energy (.5% of the remaining is above and .5% is below the occupied BW). The occupied bandwidth may not exceed the authorized bandwidth in the radio service rules. The occupied bandwidth test should be performed for each type of emission listed on the grant.

Procedure:

The following procedure and conditions shall apply for Occupied Bandwidth measurements. As applicable, Lower, Middle and Upper frequency offsets, modulation, and bandwidths shall be assessed and recorded along with the relevant captured plots.

Test Setup

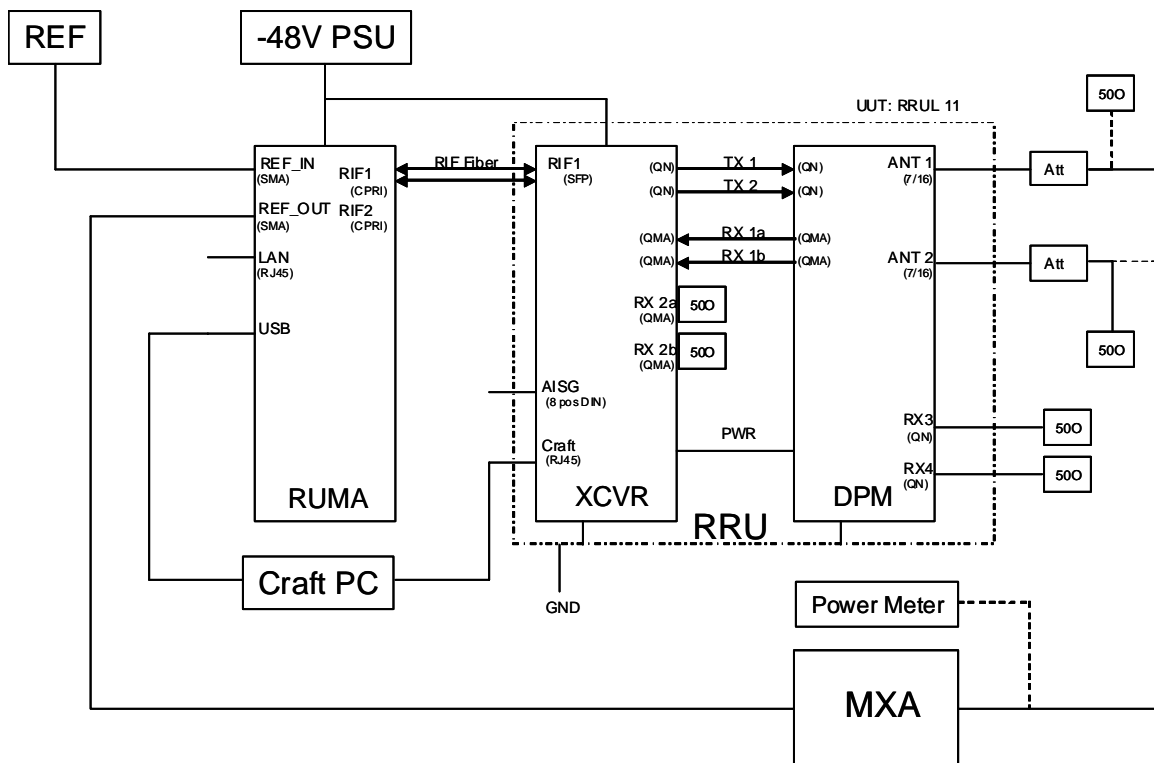

Figure 6-26: RRU Radio Compliance Set Up / Configuration

The following tables are used to summarize recorded results in addition to applicable captured plots.

Table 6-2: Setting / Measurement Results – Occupied Bandwidth 1.4MHz

Setting			Occupied Bandwidth (MHz)					
			QPSK		16 QAM		64 QAM	
			TX1	TX2	TX1	TX2	TX1	TX2
Frequency	(Lower CH_1957)	2110.7MHz	1.247	1.253	1.255	1.249	1.252	1.247
Frequency	(Middle CH_2175)	2132.5MHz	1.232	1.269	1.246	1.239	1.249	1.244
Frequency	(Upper CH_2393)	2154.3MHz	1.259	1.247	1.240	1.256	1.241	1.248
RBW		180kHz						
VBW		1.8MHz						
CH BW		1.4MHz						
Span		5MHz						
Sweep		1ms						
Reference Level Offset		52.25dB						
Detector		Peak						
Attenuation		10dB						

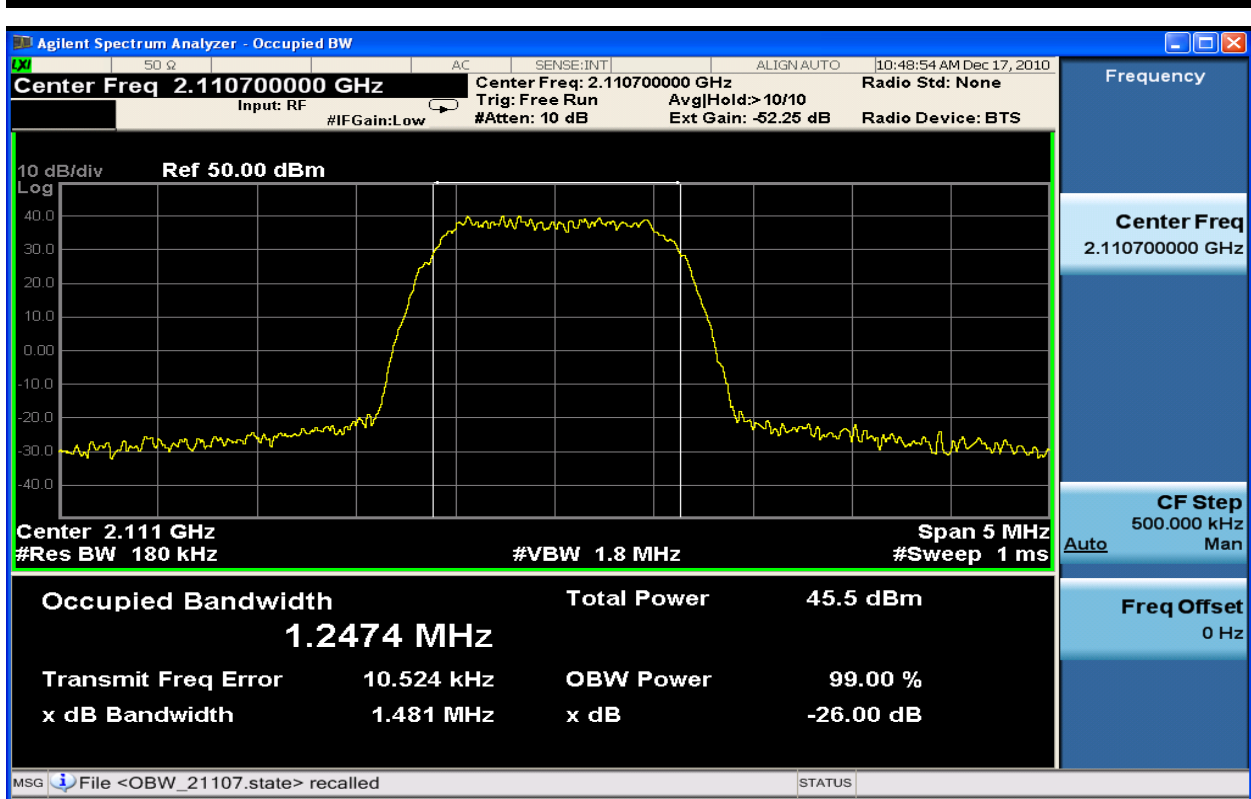

Figure 6-27: 1.4MHz Occupied Bandwidth TX1_QPSK at 2110.7 MHz

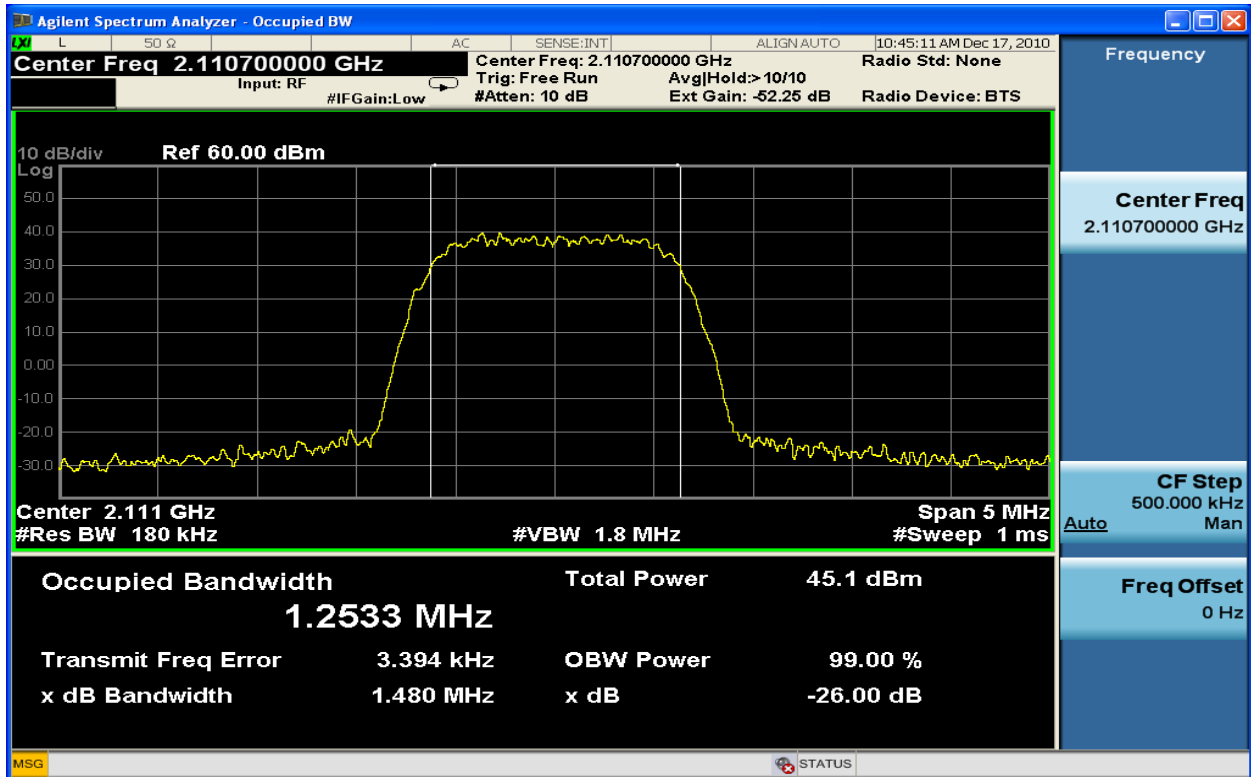

Figure 6-28: 1.4MHz Occupied Bandwidth TX2_QPSK at 2110.7 MHz

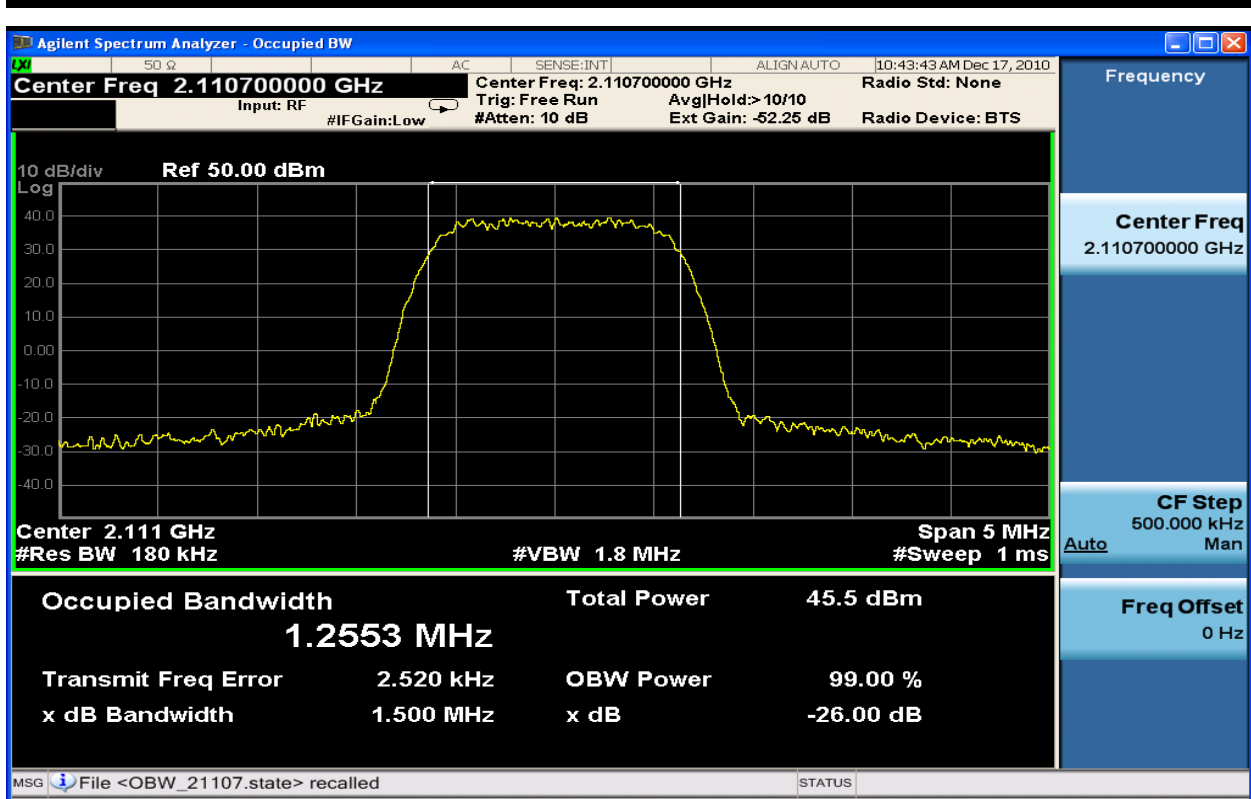

Figure 6-29: 1.4MHz Occupied Bandwidth TX1_16QAM at 2110.7 MHz

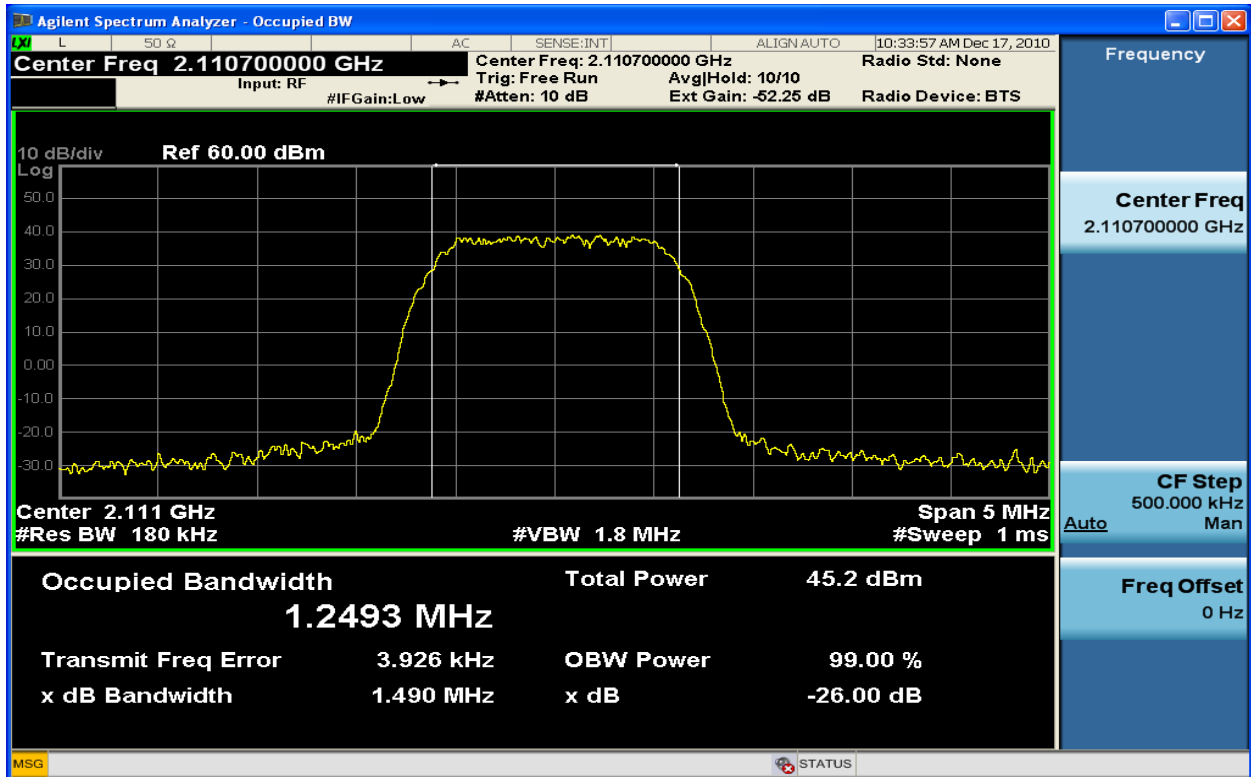

Figure 6-30: 1.4MHz Occupied Bandwidth TX2_16QAM at 2110.7 MHz

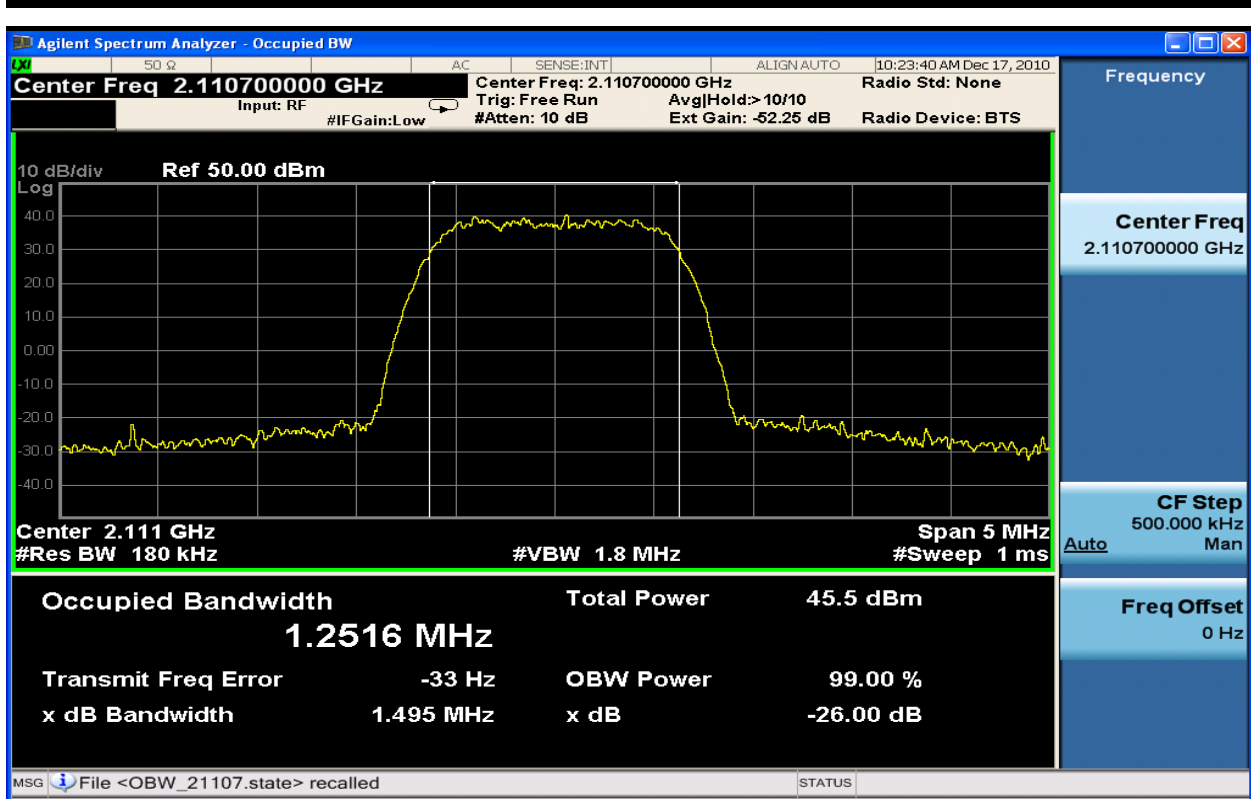

Figure 6-31: 1.4MHz Occupied Bandwidth TX1_64QAM at 2110.7 MHz

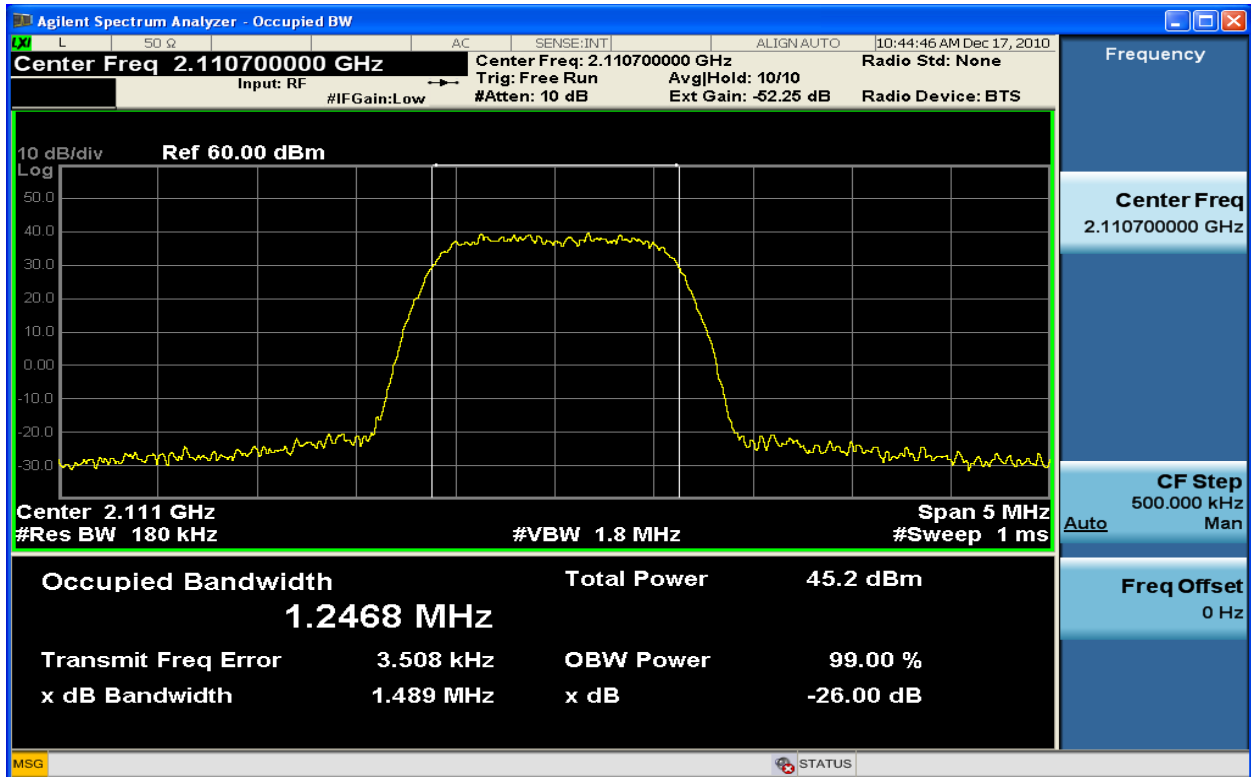

Figure 6-32: 1.4MHz Occupied Bandwidth TX2_64QAM at 2110.7 MHz

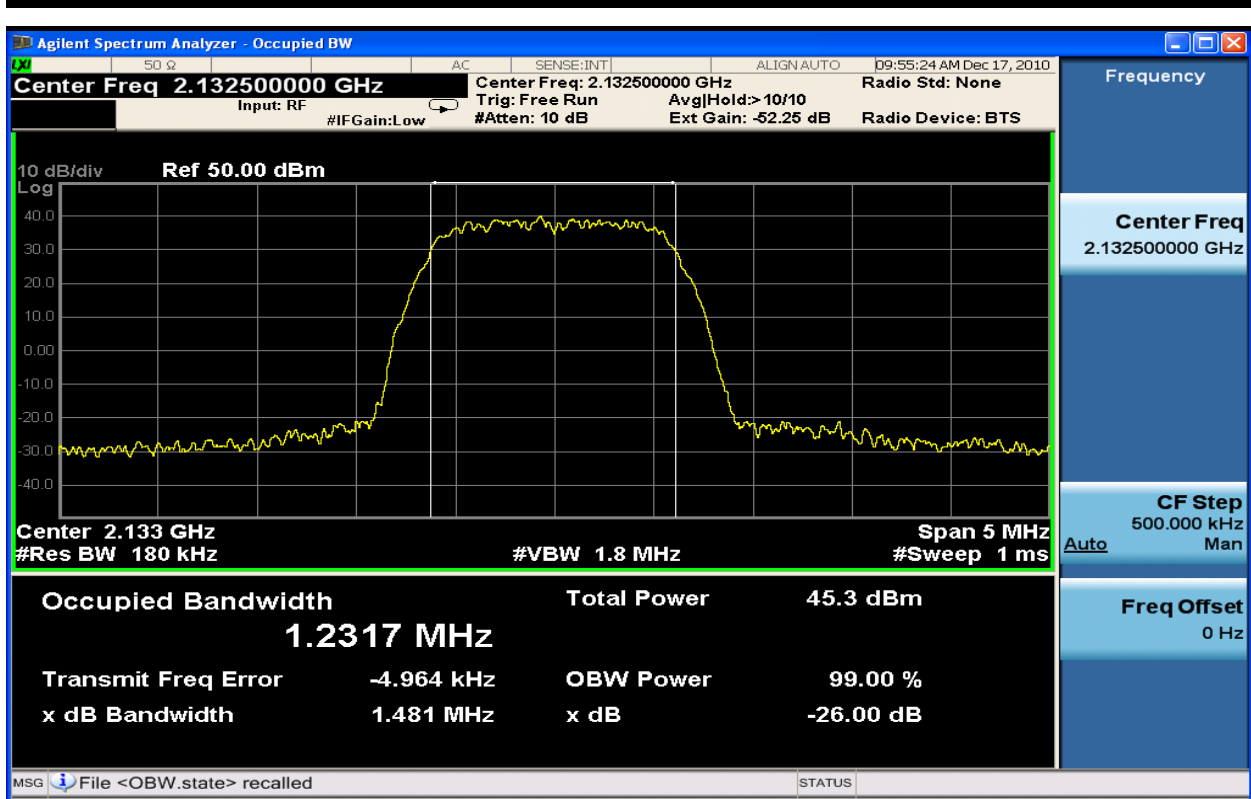

Figure 6-33: 1.4MHz Occupied Bandwidth TX1_QPSK at 2132.5 MHz

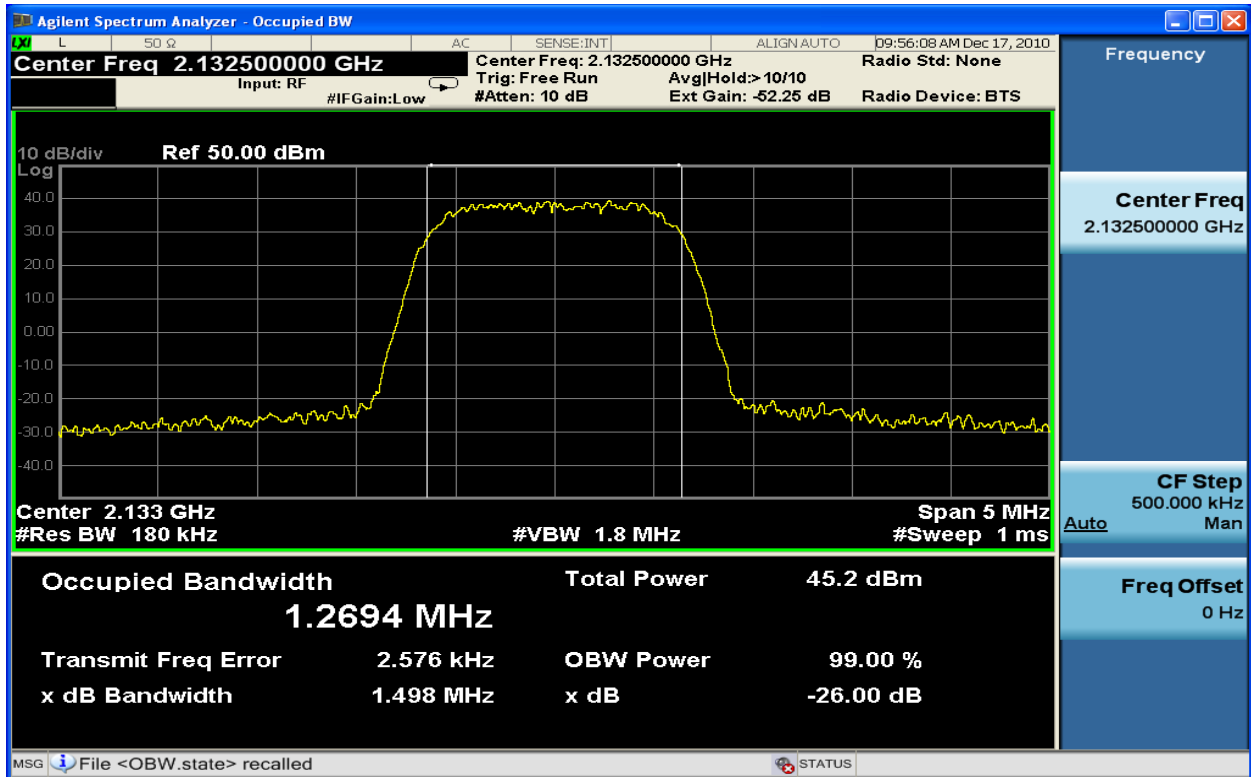

Figure 6-34: 1.4MHz Occupied Bandwidth TX2_QPSK at 2132.5 MHz

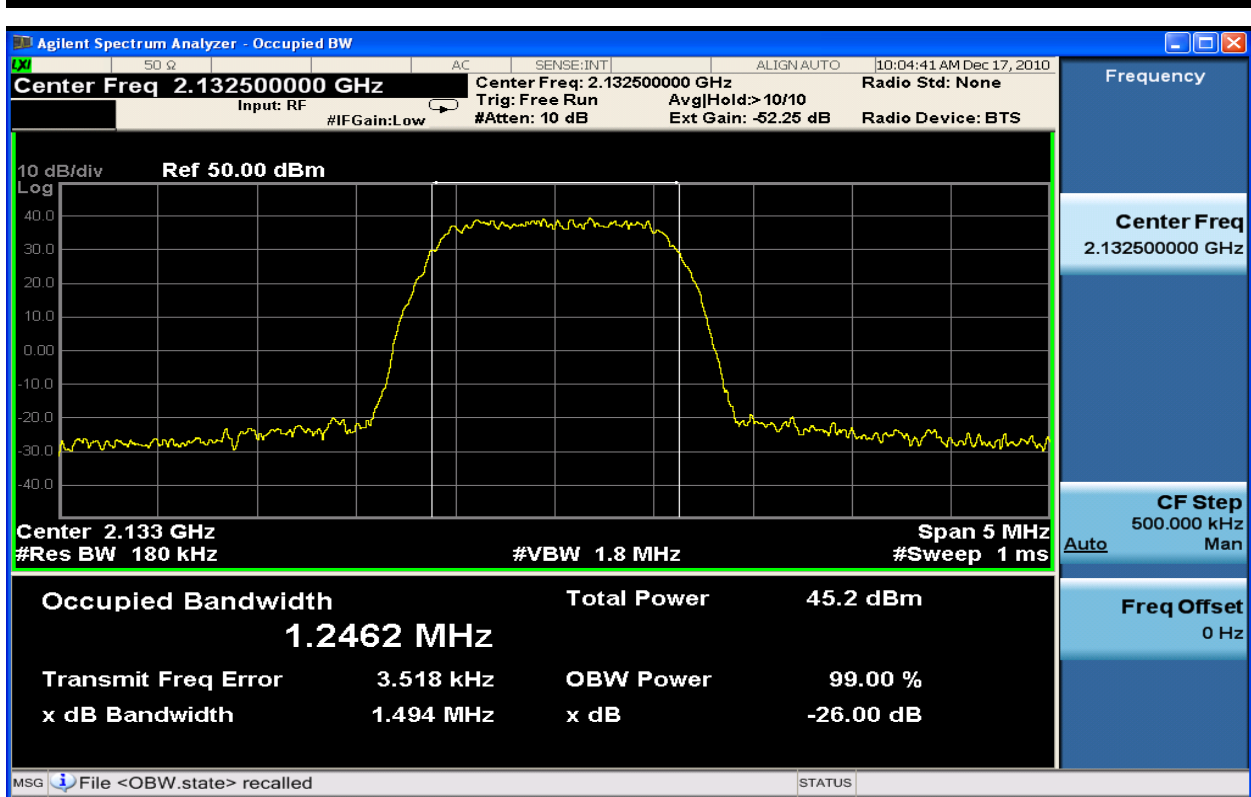

Figure 6-35: 1.4MHz Occupied Bandwidth TX1_16QAM at 2132.5 MHz

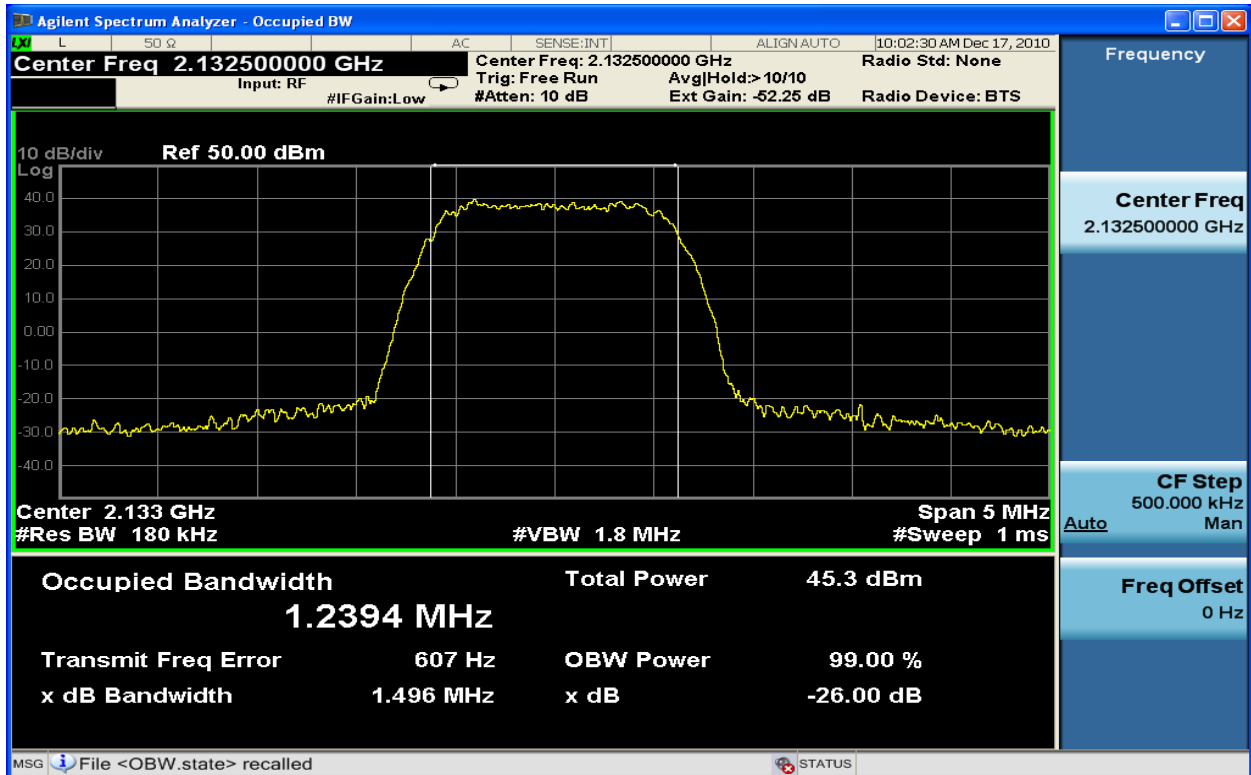

Figure 6-36: 1.4MHz Occupied Bandwidth TX2_16QAM at 2132.5 MHz

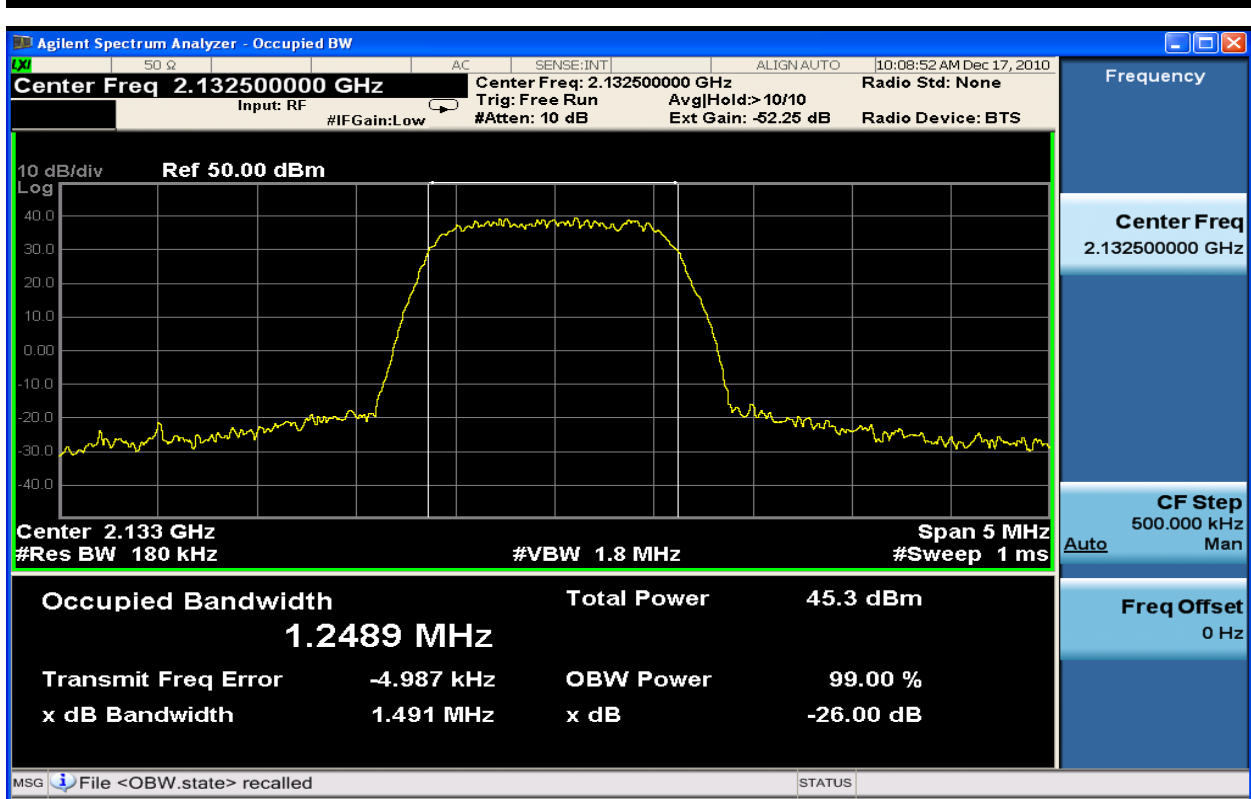

Figure 6-37: 1.4MHz Occupied Bandwidth TX1_64QAM at 2132.5 MHz

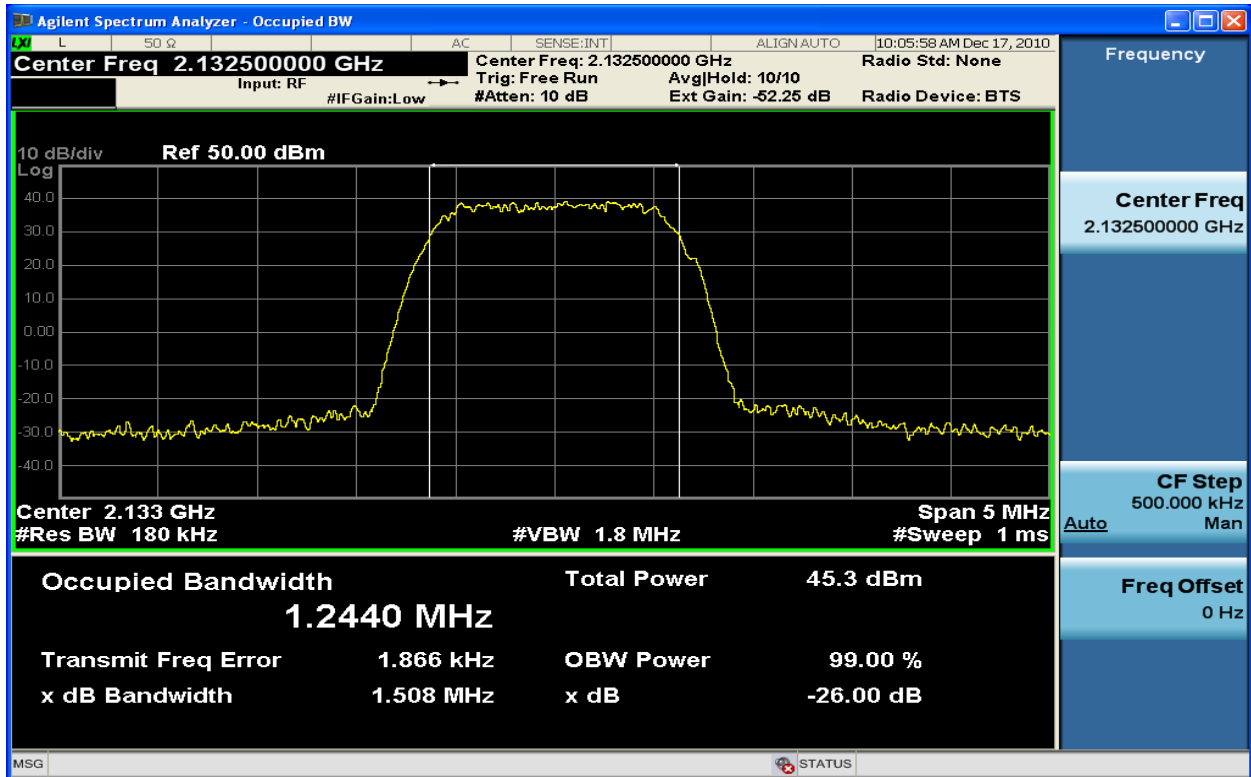

Figure 6-38: 1.4MHz Occupied Bandwidth TX2_64QAM at 2132.5 MHz

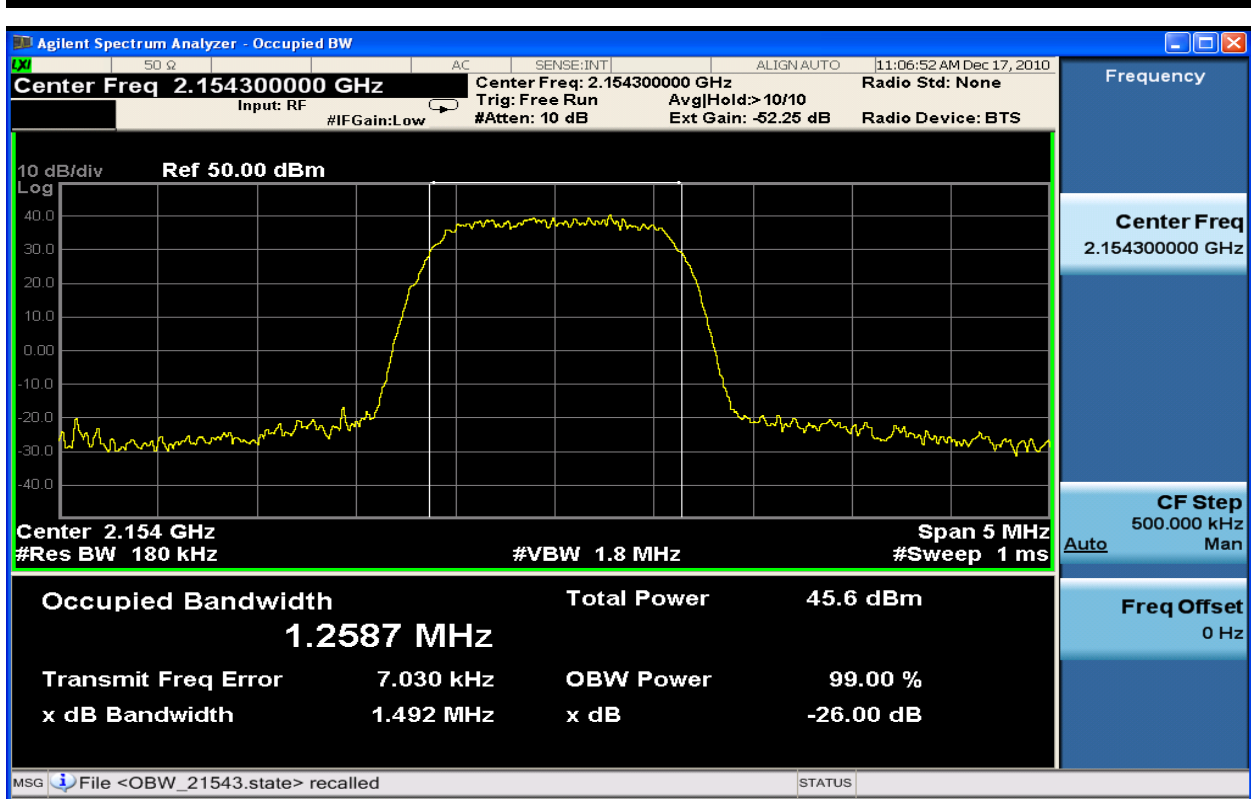

Figure 6-39: 1.4MHz Occupied Bandwidth TX1_QPSK at 2154.3 MHz

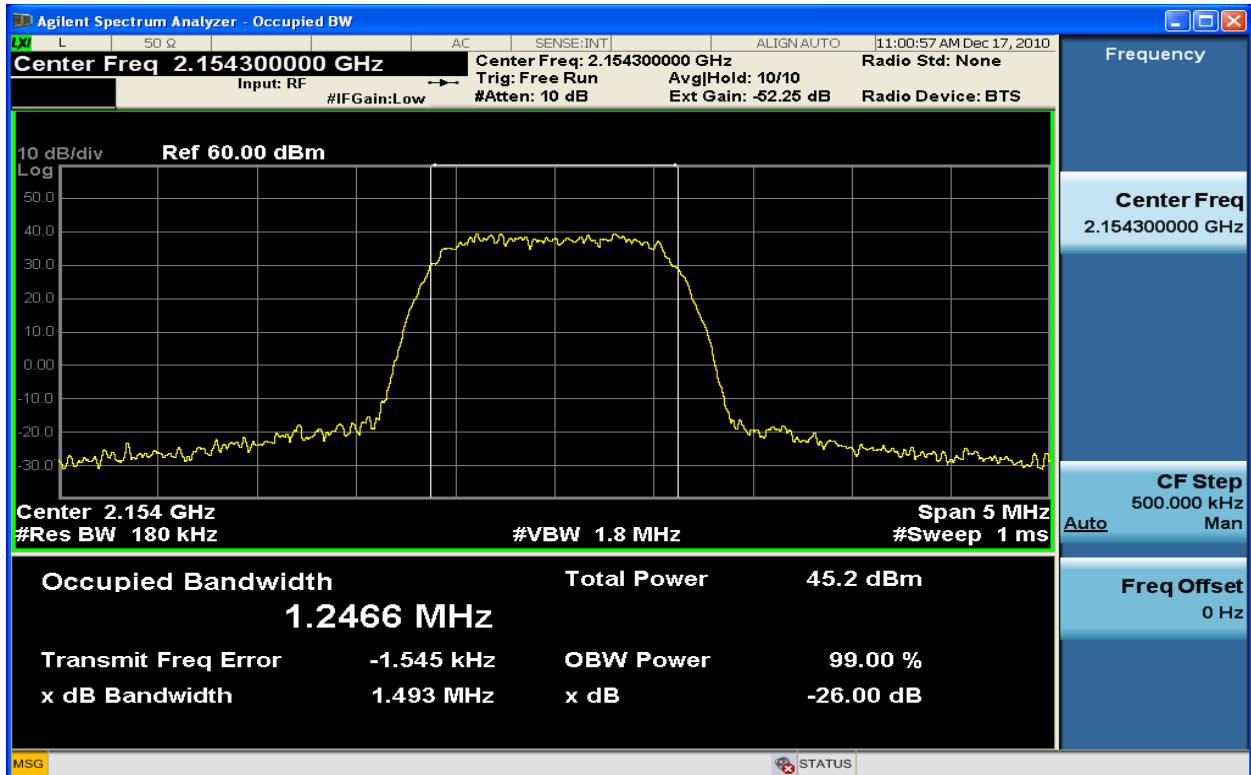

Figure 6-40: 1.4MHz Occupied Bandwidth TX2_QPSK at 2154.3 MHz

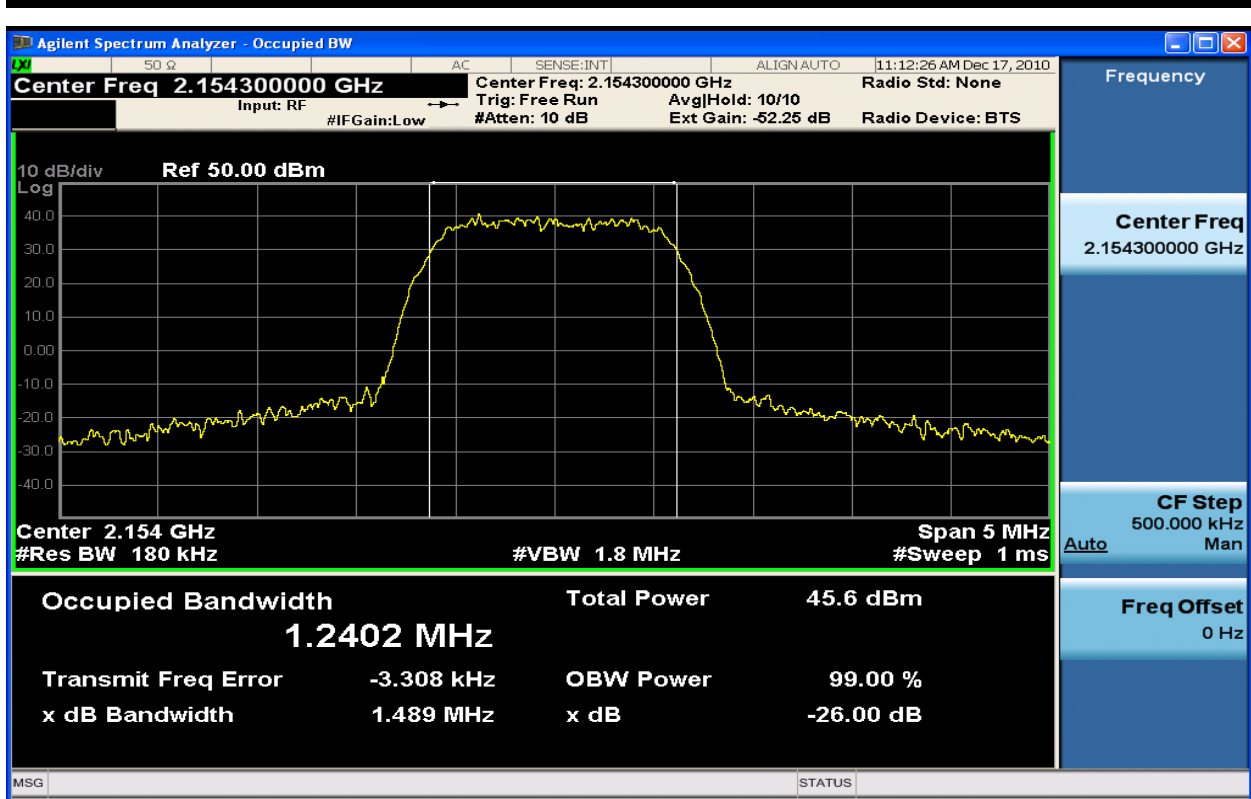

Figure 6-41: 1.4MHz Occupied Bandwidth TX1_16QAM at 2154.3 MHz

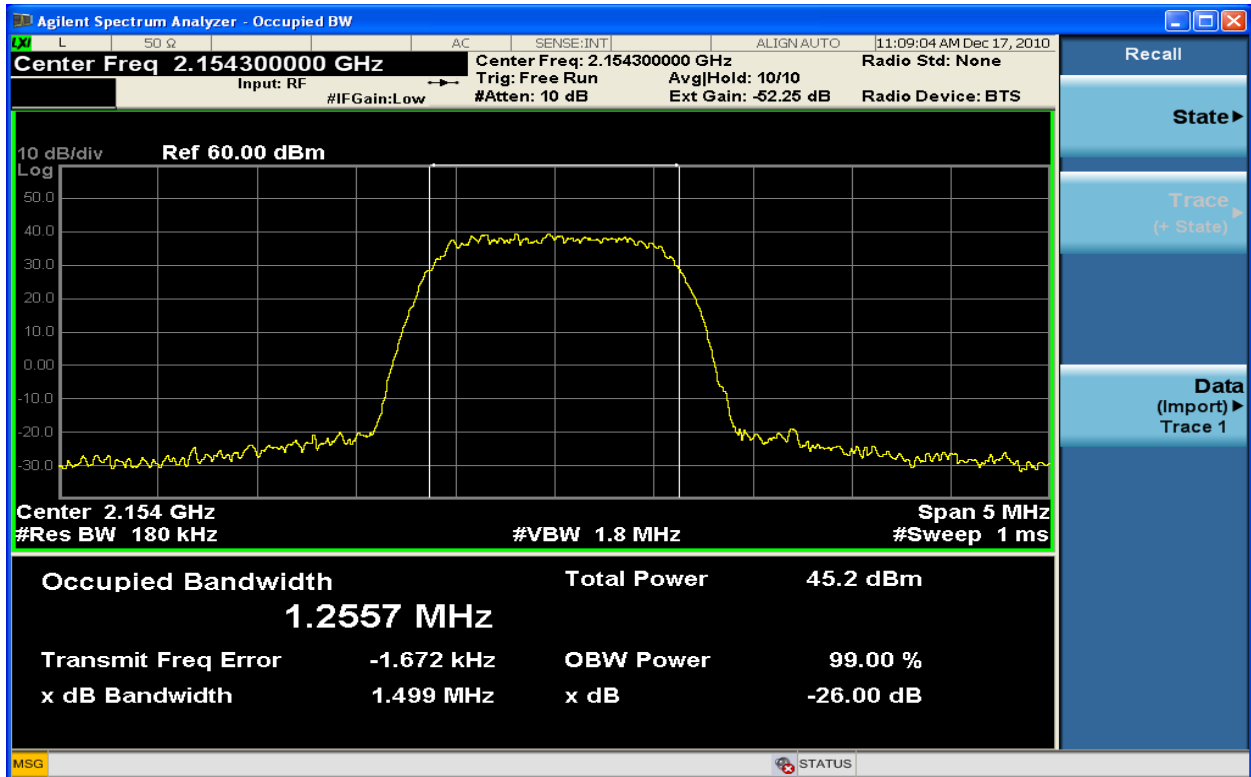

Figure 6-42: 1.4MHz Occupied Bandwidth TX2_16QAM at 2154.3 MHz

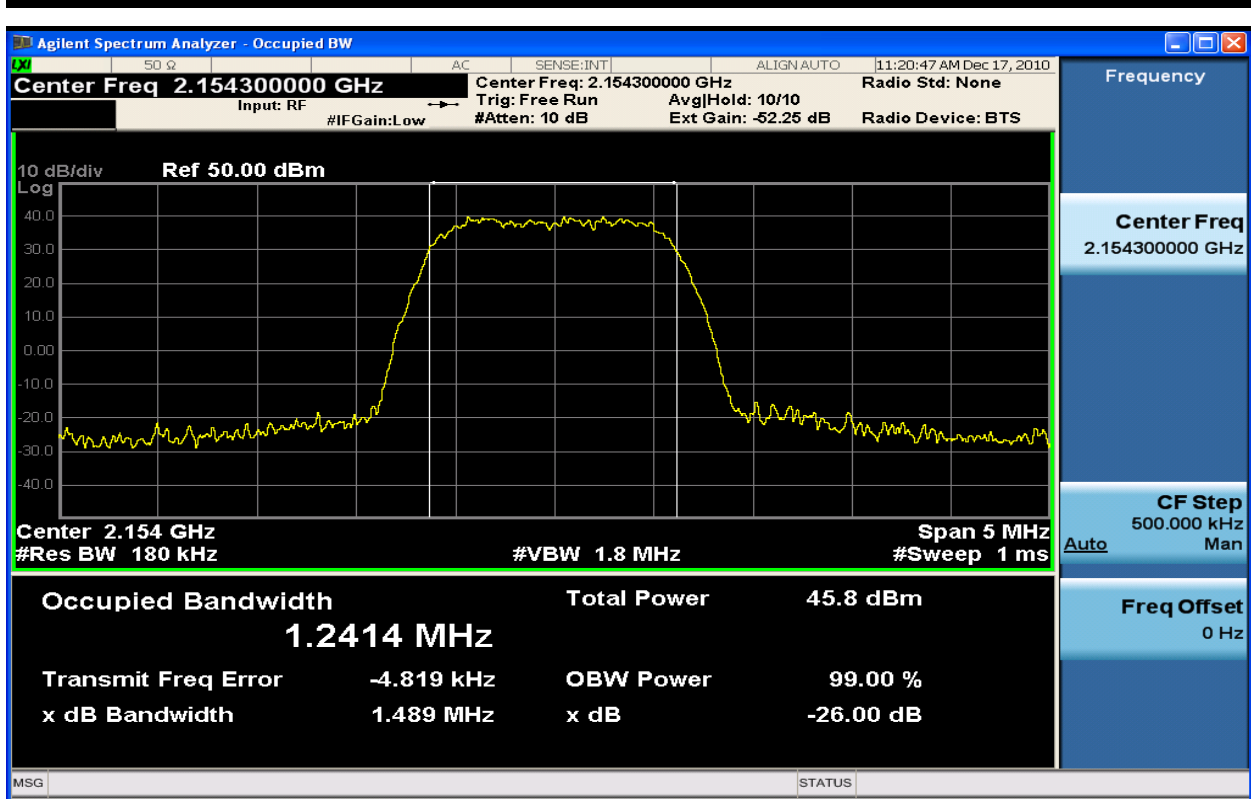

Figure 6-43: 1.4MHz Occupied Bandwidth TX1_64QAM at 2154.3 MHz

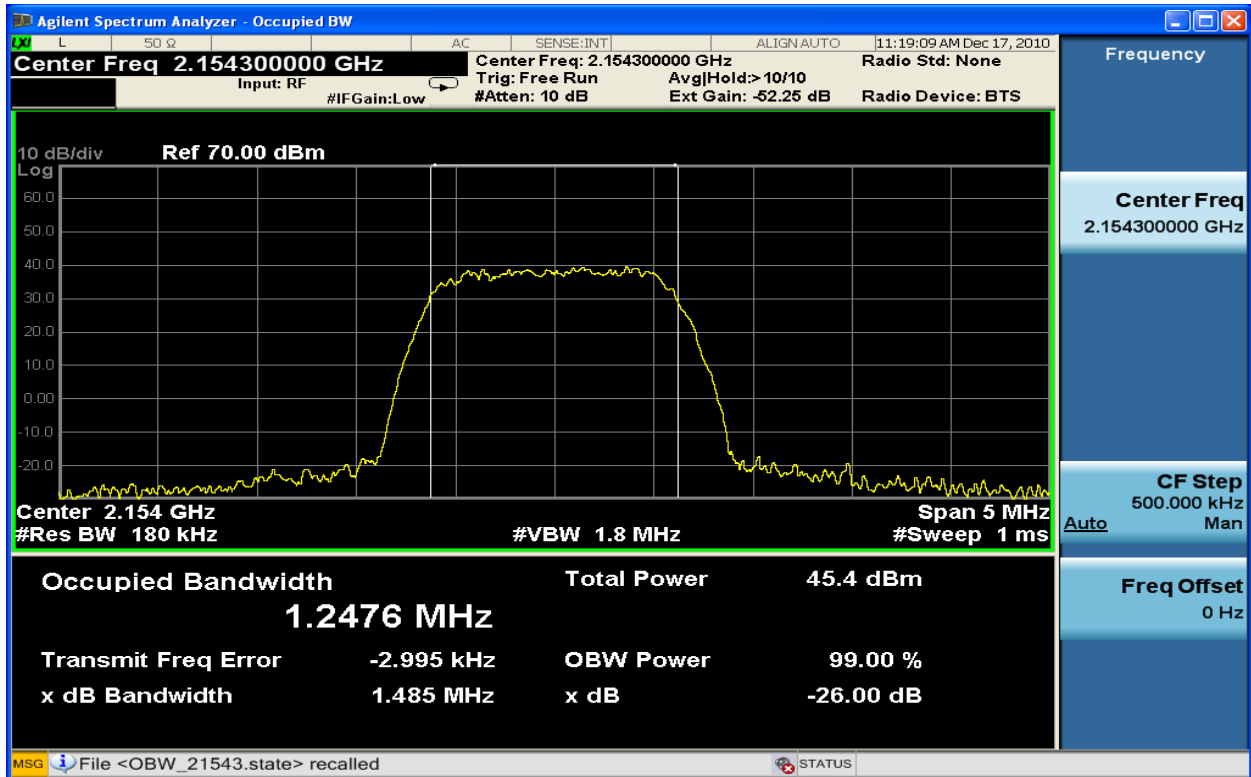

Figure 6-44: 1.4MHz Occupied Bandwidth TX2_64QAM at 2154.3 MHz

6.3 Spurious Emissions at the Antenna Terminal

Clause 27.53(h) 2.1051

(h) For operations in the 1710–1755 MHz and 2110–2155 MHz bands, the power of any emission outside a licensee’s frequency block shall be attenuated below the transmitter power (P) by at least $43 + 10 \log_{10}(P)$ dB.

(1) Compliance with this provision is based on the use of measurement instrumentation employing a resolution bandwidth of 1 megahertz or greater. However, in the 1 megahertz bands immediately outside and adjacent to the licensee’s frequency block, a resolution bandwidth of at least one percent of the emission bandwidth of the fundamental emission of the transmitter may be employed. The emission bandwidth is defined as the width of the signal between two points, one below the carrier center frequency and one above the carrier center frequency, outside of which all emissions are attenuated at least 26 dB below the transmitter power.

(2) When measuring the emission limits, the nominal carrier frequency shall be adjusted as close to the licensee’s frequency block edges, both upper and lower, as the design permits.

(3) The measurements of emission power can be expressed in peak or average values, provided they are expressed in the same parameters as the transmitter power.

(i) When an emission outside of the authorized bandwidth causes harmful interference, the Commission may, at its discretion, require greater attenuation than specified in this section.

Test Setup:

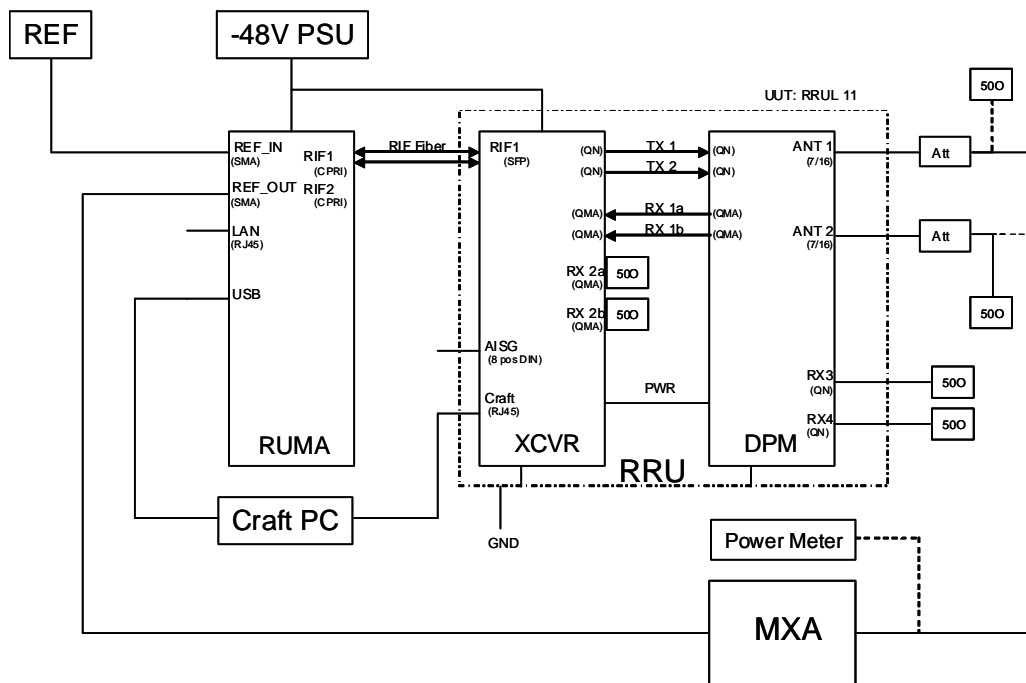

Figure 6-45: RRU Radio Compliance Set Up / Configuration

Procedure:

The following procedure and conditions shall apply for Spurious Emission measurements. As applicable, lower and high side offsets from the channel shall be assessed with respect to all modulation, and bandwidths as well as all emissions up to 26.5GHz. Results shall be compiled and recorded along with the relevant captured plots.

$$\text{FCC Limit} = \text{PWR (dBm)} - [43 + 10\log(\text{PWR (w)})] = 44.8 - 43 + 10\log(30) = -13\text{dBm}$$

Table 6-3: Setting / Measurement Results – Spurious Emissions Band Edge BW = 1.4MHz

Setting Measurement ACP < 2MHz		Spurious Emissions (dBm) FCC Limit -13dBm					
		QPSK		16 QAM		64 QAM	
		TX1	TX2	TX1	TX2	TX1	TX2
		Lower Edge Emission					
Frequency (Lower CH_1957)	2110.7MHz	-24.77	-25.79	-23.14	-23.76	-24.68	-25.39
Frequency (Middle CH_2175)	2132.5MHz	-23.36	-22.53	-25.15	-24.17	-22.90	-23.90
Frequency (Upper CH_2393)	2154.3MHz	-21.86	-24.32	-23.67	-23.91	-23.47	-22.22
		Upper Edge Emission					
Frequency (Lower CH_1957)	2110.7MHz	-25.01	-25.37	-24.47	-23.66	-25.68	-24.32
Frequency (Middle CH_2175)	2132.5MHz	-24.00	-23.85	-25.45	-25.33	-23.23	-23.77
Frequency (Upper CH_2393)	2154.3MHz	-22.93	-24.63	-22.67	-24.28	-23.05	-21.73
RBW (MBW=50/100kHz)	30kHz						
VBW	30kHz						
CH BW	1.4MHz	Lower Margin to FCC Limit (dB)					
Reference Level Offset	52.25dB	8.86	9.53	10.14	10.76	9.90	9.22
Detector	RMS	Upper Margin to FCC Limit (dB)					
Attenuation	6dB	9.93	10.85	9.67	10.66	10.05	8.73

Table 6-4: Setting / Results – BW = 1.4MHz, Spurious Emissions 30MHz - 26.5GHz

Setting Measurement 30MHz – 26.5GHz		Spurious Emissions (dBm) FCC Limit -13dBm			
		64 QAM			
		TX1	TX2		
Frequency (Lower CH_1957)	2110.7MHz	All emissions were below MXA noise floor			
Frequency (Upper CH_2393)	2154.3MHz	All emissions were below MXA noise floor			
RBW	3.0MHz				
VBW	300kHz				
CH BW	1.4MHz				
Reference Level Offset	52.25 dB				
Detector	RMS	Margin to FCC Limit (dB)			
Attenuation	6dB	> 8.0dB			

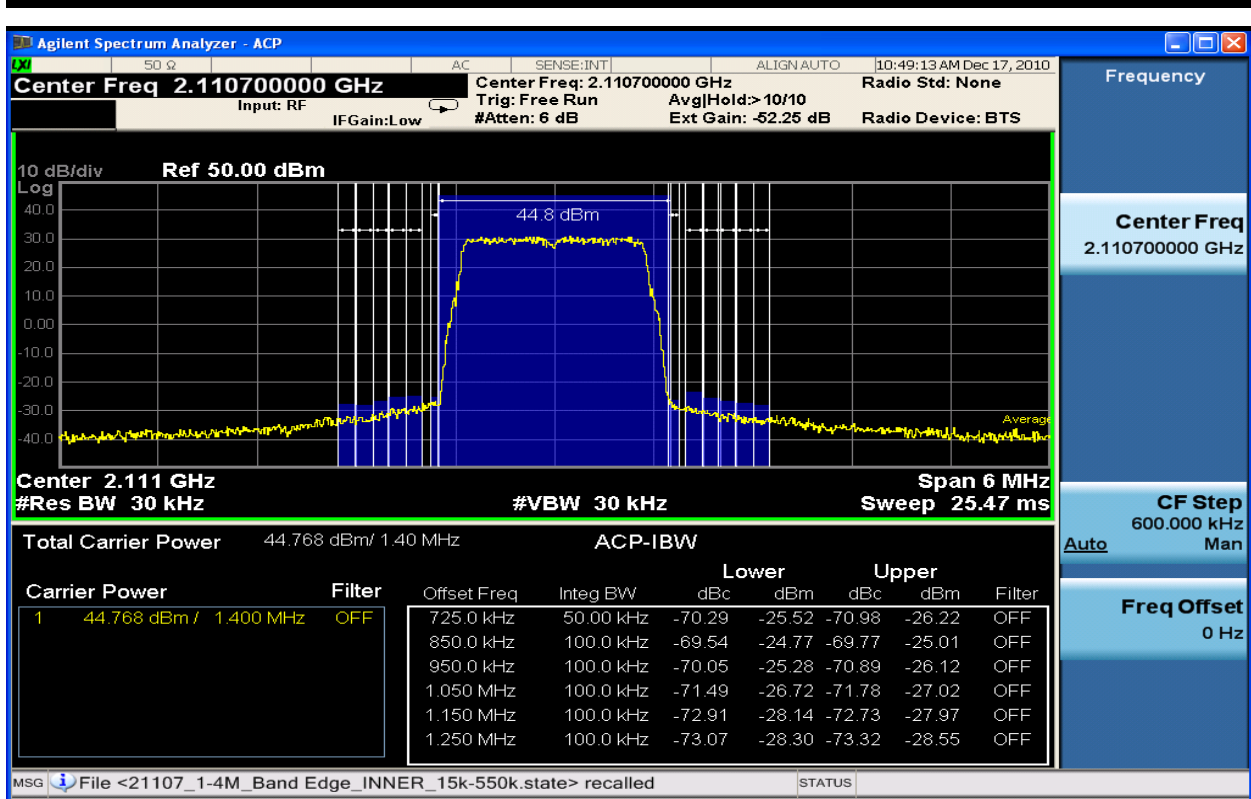

Figure 6-46 Spurious Emissions 2110.7MHz TX1_QPSK 1.4MHz Band Edge (ACP 15kHz – 550kHz)

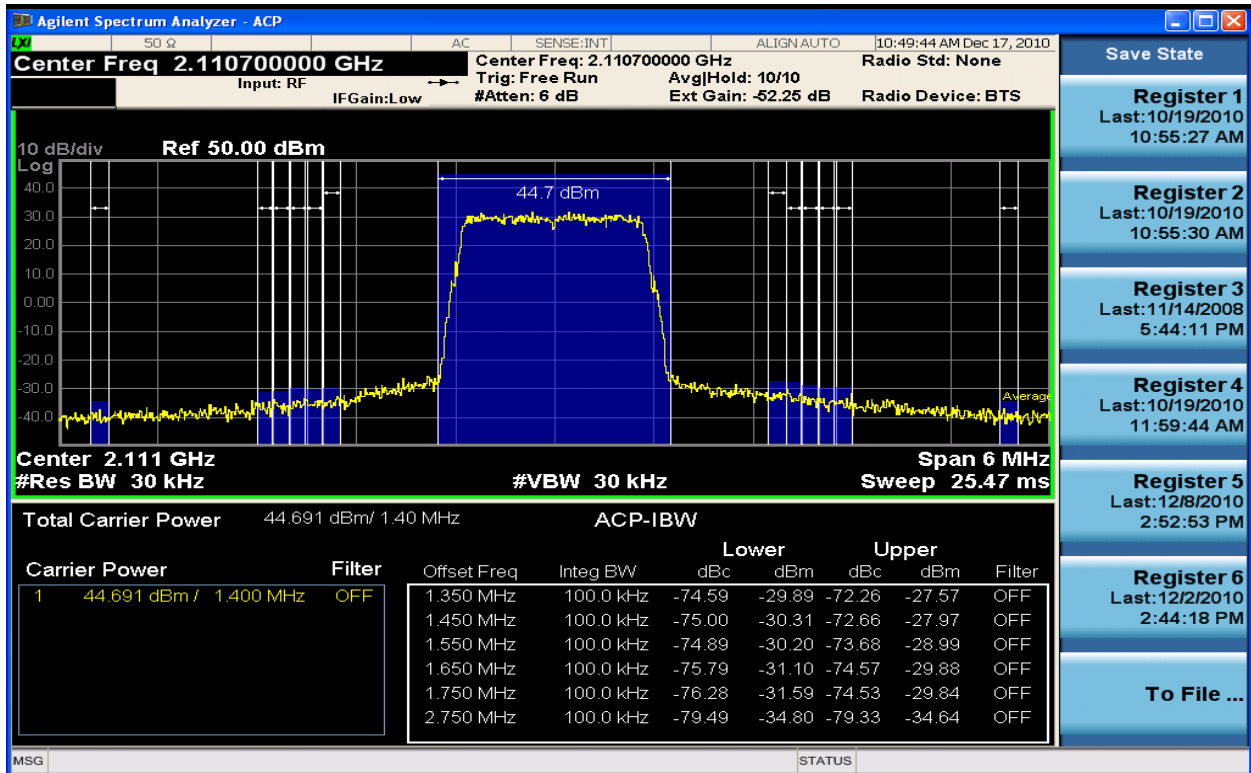

Figure 6-47 Spurious Emissions 2110.7MHz TX1_QPSK 1.4MHz Band Edge (ACP 650kHz – 2MHz)

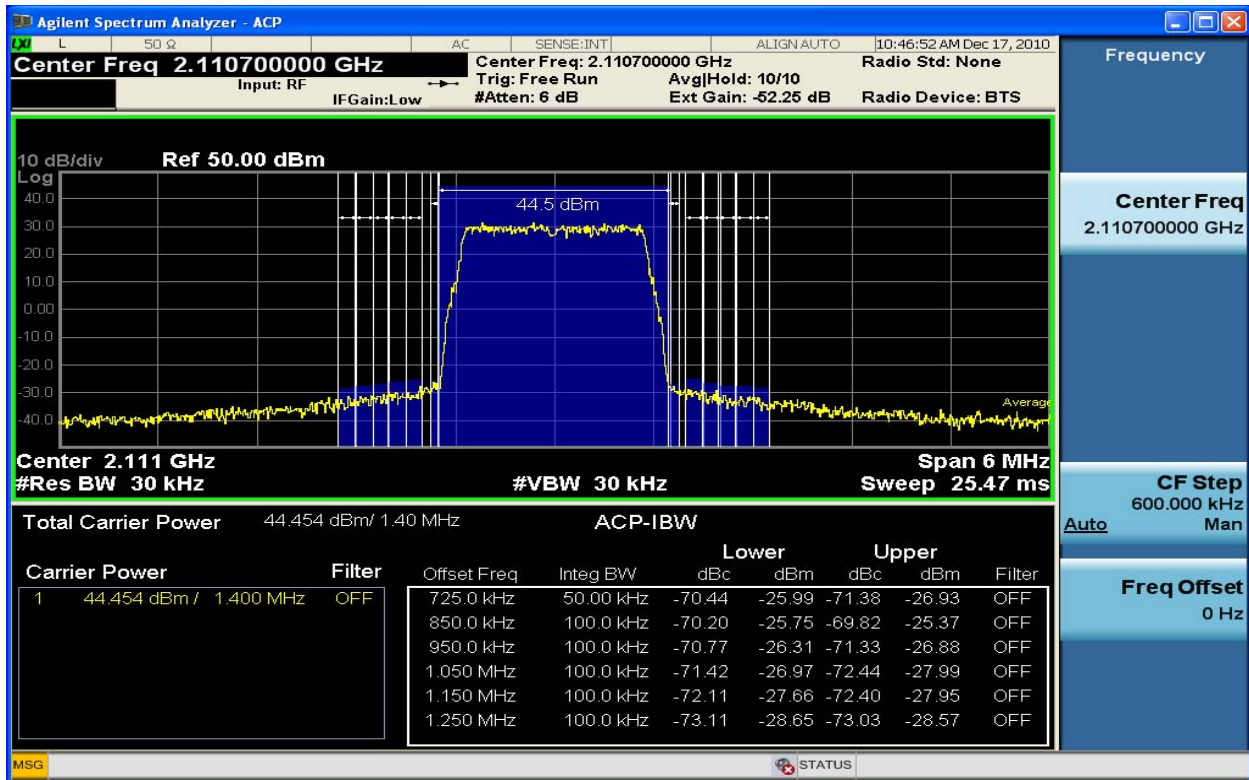

Figure 6-48 Spurious Emissions 2110.7MHz TX2_QPSK 1.4MHz Band Edge (ACP 15kHz – 550kHz)

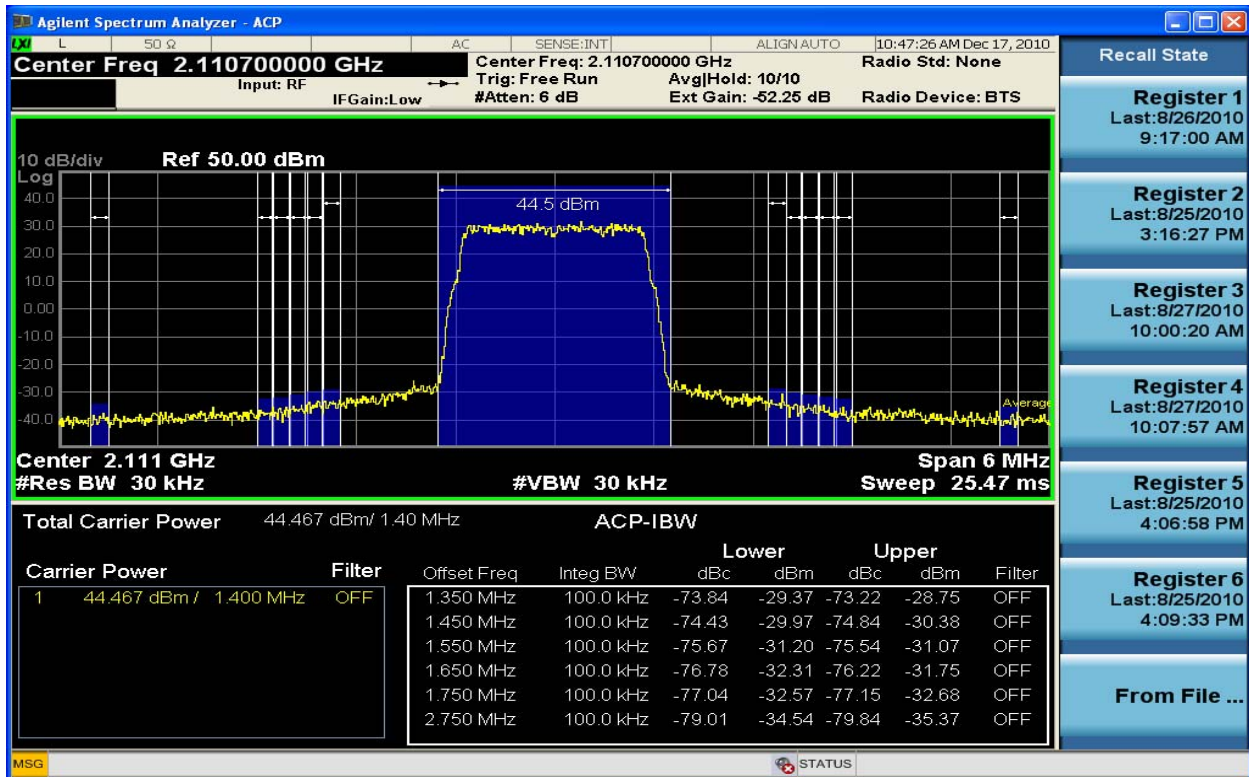

Figure 6-49 Spurious Emissions 2110.7MHz TX2_QPSK 1.4MHz Band Edge (ACP 650kHz – 2MHz)

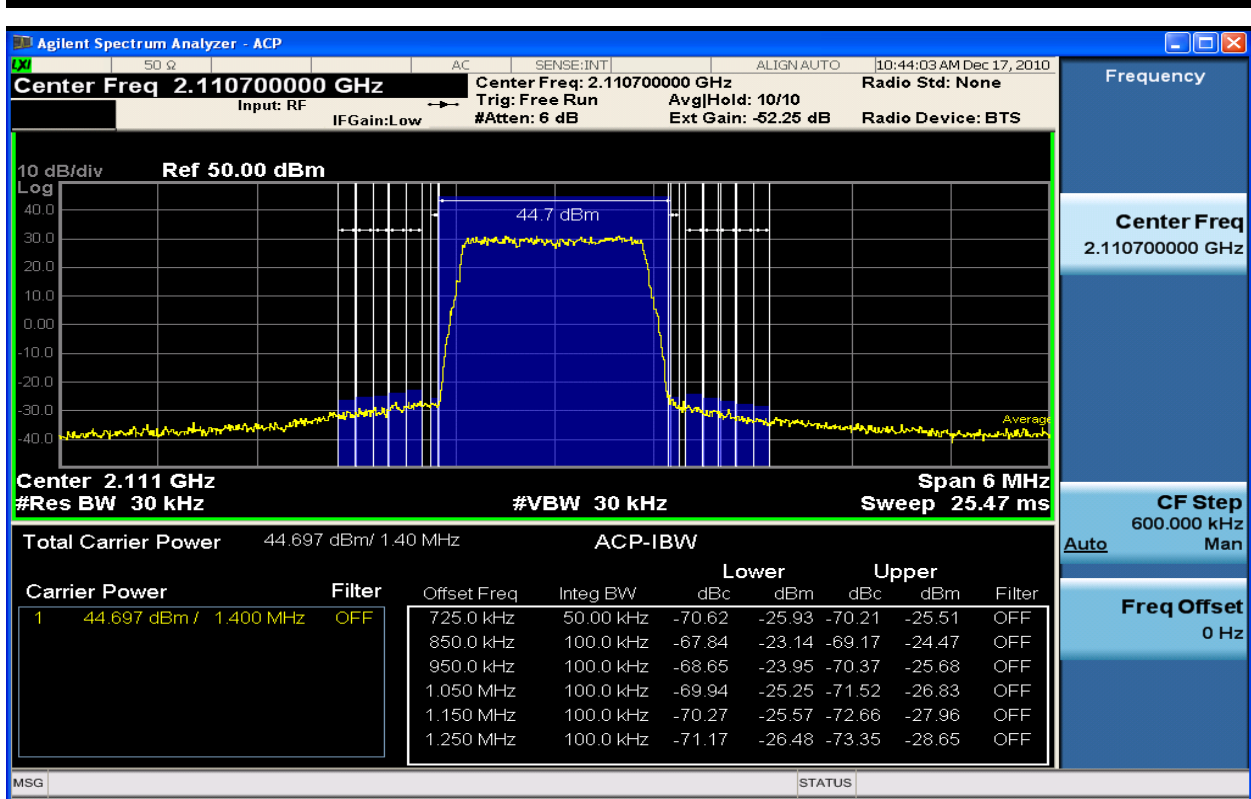

Figure 6-50 Spurious Emissions 2110.7MHz TX1_16QAM 1.4MHz Band Edge (ACP 15kHz – 550kHz)

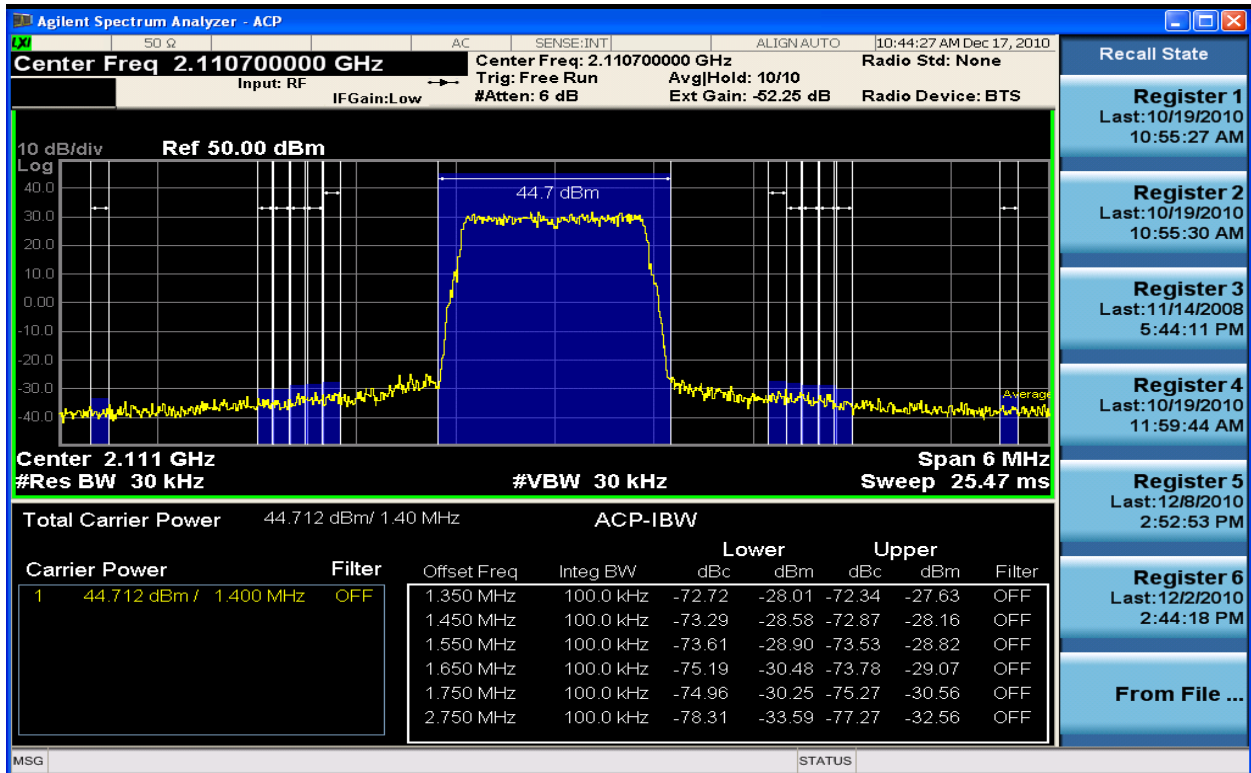

Figure 6-51 Spurious Emissions 2110.7MHz TX1_16QAM 1.4MHz Band Edge (ACP 650kHz – 2MHz)

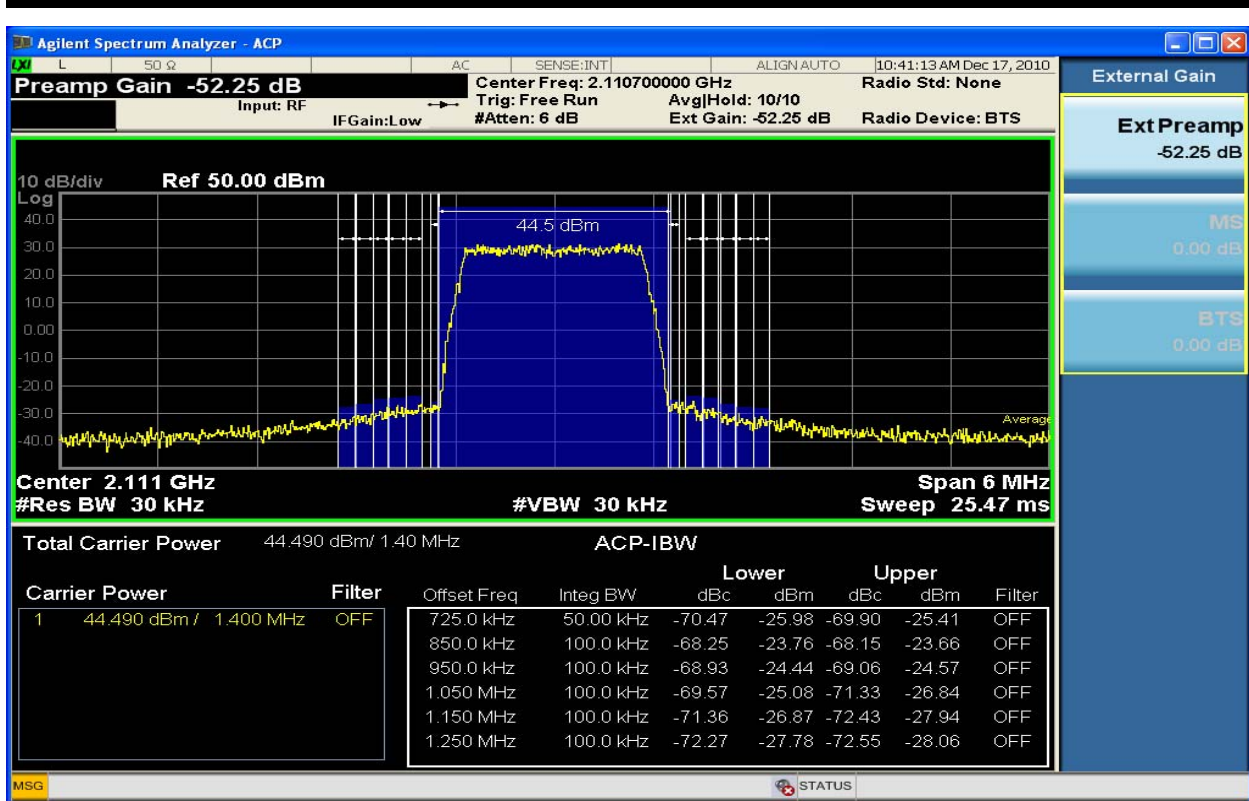

Figure 6-52 Spurious Emissions 2110.7MHz TX2_16QAM 1.4MHz Band Edge (ACP 15kHz – 550kHz)

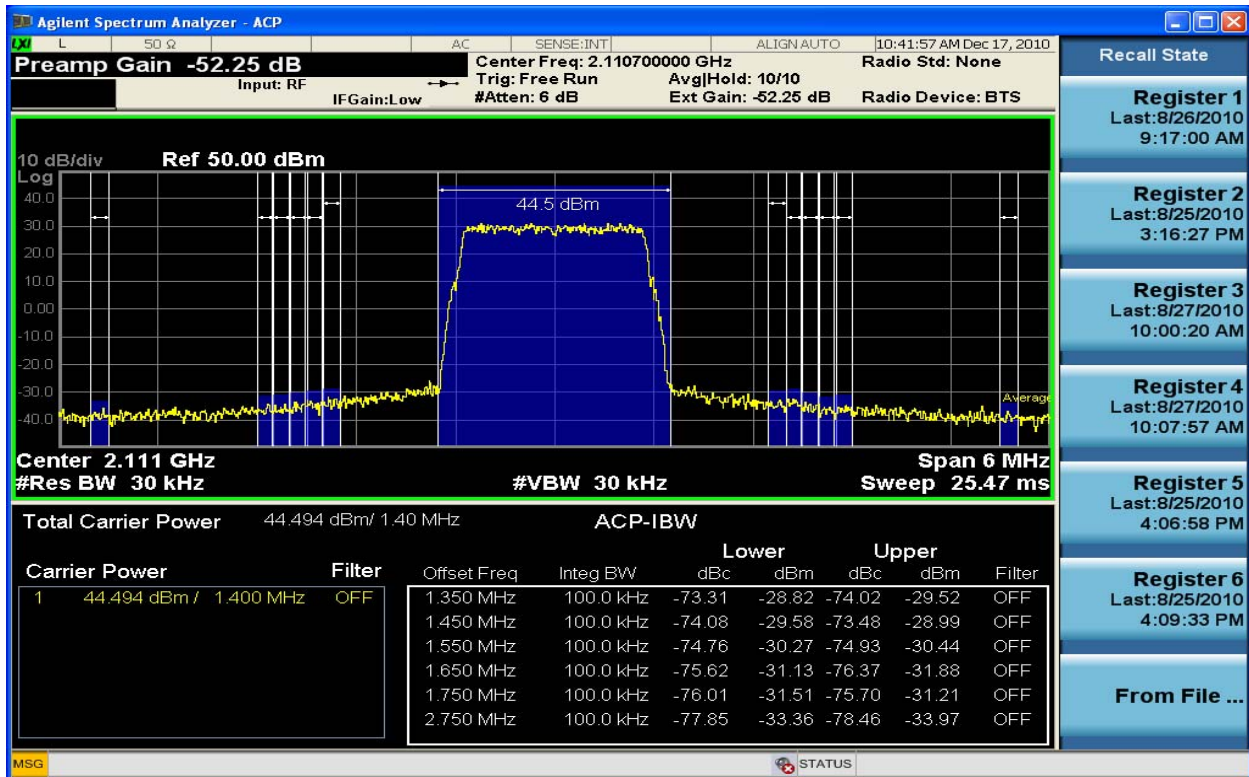

Figure 6-53 Spurious Emissions 2110.7MHz TX2_16QAM 1.4MHz Band Edge (ACP 650kHz – 2MHz)

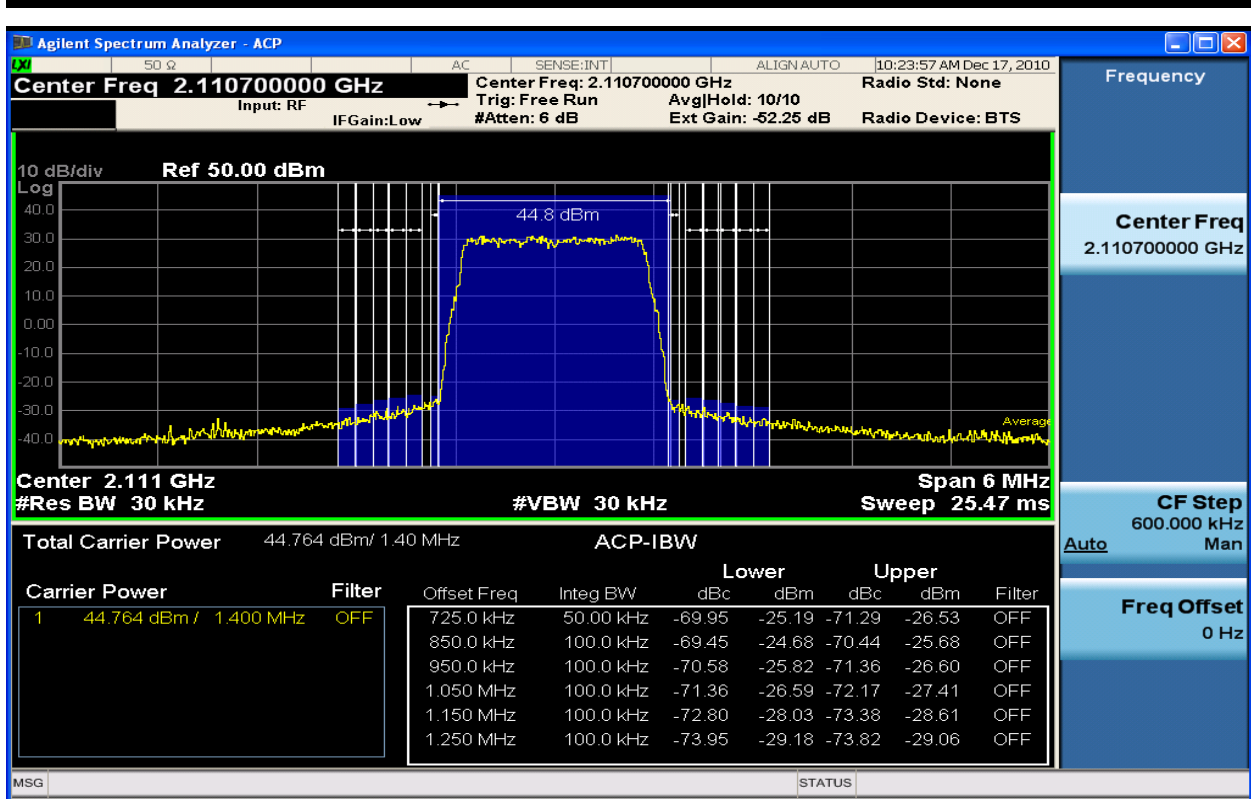

Figure 6-54 Spurious Emissions 2110.7MHz TX1_64QAM 1.4MHz Band Edge (ACP 15kHz – 550kHz)

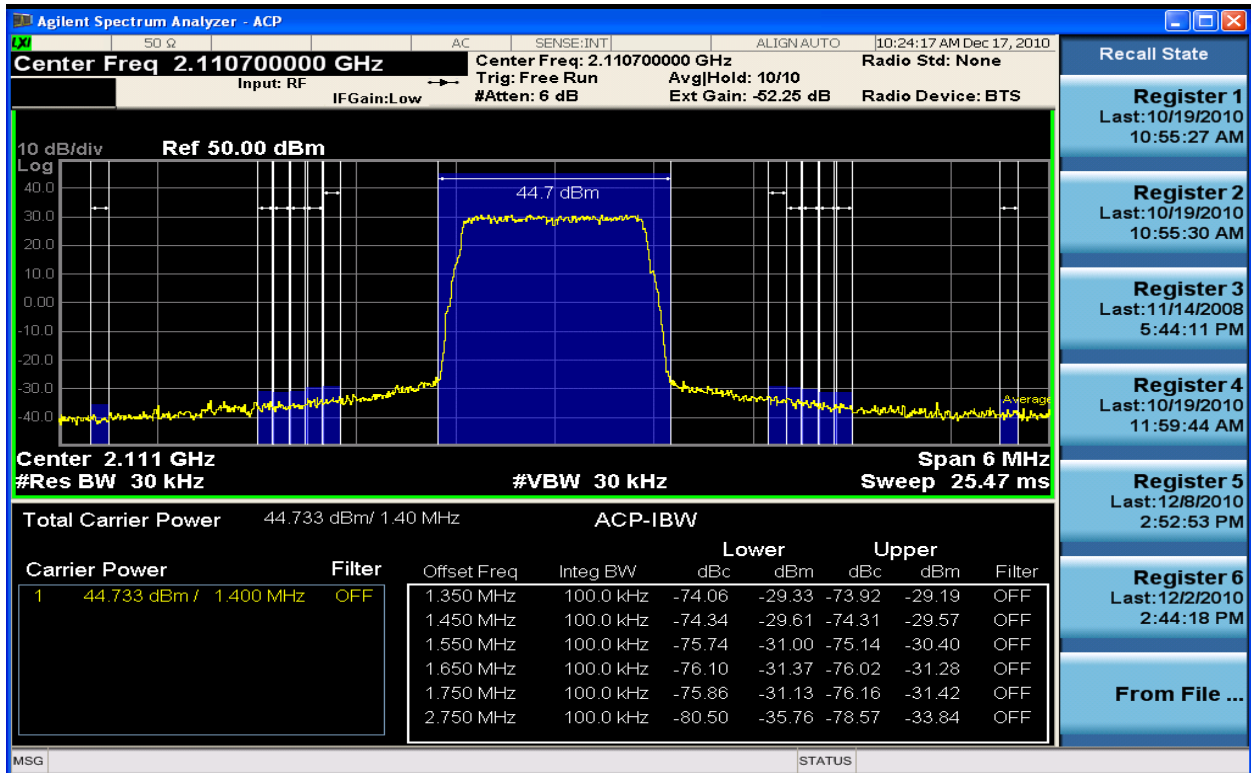

Figure 6-55 Spurious Emissions 2110.7MHz TX1_64QAM 1.4MHz Band Edge (ACP 650kHz – 2MHz)