RRUL 11 B4 CS – Remote Radio Unit AWS Radio Compliance FCC CFR 47 Part 27 Test Report

Version: 1.0
Date: 28 October 2010
Document: RRUL 11 B4 Co-Site FCC CFR 47 Part 27_TR
Status: Approved
Pages: 134
Editor: David Bolzon
File: RRUL 11 B4 CS AWS FCC TR_A.doc



CONFIDENTIAL INFORMATION
RESTRICTED USE AND DUPLICATION
© Ericsson Canada Inc. All Rights Reserved.

The information contained in this document is the property of Ericsson Canada. Except as specifically authorized in writing by Ericsson, the holder of this document shall keep all information contained herein confidential and shall protect same in whole or in part from disclosure and dissemination to all third parties.

Approvals and Key Reviewers

Name	Function	Role	Status
David Bolzon	Regulatory/PI, Object Leader	Author / Approver	Approved
David Webster	Regulatory Prime	Reviewer	27 October 2010

Revision History

Issue	Description of change	Changed by	Date
0.1	Draft - Preliminary	David Bolzon	14 October 2010
0.2	Draft – Updated with additional input	David Bolzon	27 October 2010
1.0	Approved	David Bolzon	28 October 2010

Reference Documents

1. FCC 47 CFR Part 27 “Wireless Communications Services”
2. FCC 47 CFR Part 15 “Unintentional Radiators”
3. ICES-003 “Digital Apparatus” EMC
4. EN 50385:2002—Product Standard to Demonstrate the Compliance of Radio Base Stations and Fixed Terminal Stations for Wireless Telecommunication Systems with the Basic Restrictions or the Reference Levels Related to Human Exposure to Radio-Frequency Electromagnetic Fields (110 MHz–40 GHz)—General Public
5. EN 55022, Limits and methods of measurement of radio disturbance characteristics of information technology equipment (CISPR22: 1997), 1998, European Committee for Electro-technical Standardization
6. SM.328: "Spectra and bandwidth of emissions".
7. CISPR 22: "Limits and methods of measurement of radio disturbance characteristics of information technology equipment".
8. CISPR 16-1-1: "Specification for radio disturbance and immunity measuring apparatus and methods - Measuring apparatus".
9. ETSI TS 136 141 V8.2.0 (2009-04) LTE; Evolved Universal Radio Access (E-UTRA); Base Station (BS) conformance testing (3GPP TS 36.141 version 8.2.0 Release 8)
10. ETSI TS 136 104 V8.5.0 (2009-04) LTE; Evolved Universal Terrestrial Radio Access (E-UTRA); Base Station (BS) radio transmission and reception (3GPP TS 36.104 version 8.5.0 Release 8)
11. ETSI TS 136 113 V8.1.0 (2009-01) LTE; Evolved Universal Terrestrial Radio Access (E-UTRA); Base Station (BS) and repeater Electro Magnetic Compatibility (EMC) (3GPP TS 36.113 version 8.1.0 Release 8)
12. 3GPP TS 36.141 V9.0.0 (2009-05): 3rd Generation Partnership Project; Technical Specification Group Radio Access Network; Evolved Universal Terrestrial Radio Access (E-UTRA) ; Base Station (BS) conformance testing (Release 9).
13. 3GPP TS 36.104 V9.0.0 (2009-05) 3rd Generation Partnership Project; Technical Specification Group Radio Access Network; Evolved Universal Terrestrial Radio Access (E-UTRA); Base Station (BS) radio transmission and reception (Release 9)
14. 3GPP TS 36.113 V9.0.0(2009-05) 3rd Generation Partnership Project; Technical Specification Group Radio Access Network; Evolved Universal Terrestrial Radio Access (E-UTRA); Base Station (BS) and repeater Electro Magnetic Compatibility (EMC) (Release 9)
15. 3GPP TS 36.211 V8.7.0 (2009-05) 3rd Generation Partnership Project; Technical Specification Group Radio Access Network; Evolved Universal Terrestrial Radio Access (E-UTRA); Physical Channels and Modulation (Release 8)
16. 3GPP TS 36.212 V8.7.0 (2009-05) 3rd Generation Partnership Project; Technical Specification Group Radio Access Network; Evolved Universal Terrestrial Radio Access (E-UTRA); Multiplexing and channel coding (Release 8)
17. 3GPP TS 36.213 V8.7.0 (2009-05) 3rd Generation Partnership Project; Technical Specification Group Radio Access Network; Evolved Universal Terrestrial Radio Access (E-UTRA); Physical layer procedures (Release 8)
18. AWS LTE Remote Radio Unit, System Design Specification (RRUL 11 B4)

Table of Contents

Approvals and Key Reviewers	2
Revision History	2
Reference Documents	3
Table of Contents	4
List of Tables	5
List of Figures.....	6
Acronyms	10
1 Summary	11
2 Introduction	12
3 Equipment Under Test.....	13
3.1 Product Identification	13
3.2 Technical Specifications of the EUT	13
3.3 Technical Description.....	13
4 Test Conditions	16
4.1 Specifications.....	16
4.2 Test Environment	16
4.3 Test Equipment.....	16
5 Applicable Tests.....	18
5.1 FCC Part 27: Test Parameters.....	18
6 Test Results	19
6.1 Effective Radiated Power	19
Physical Channels	19
6.2 RF Safety (Reference 27.52)	46
6.3 Occupied Bandwidth	47
6.4 Spurious Emissions at the Antenna Terminal.....	67
6.5 Field Strength of Spurious Radiation.....	122
6.6 Frequency Stability	127
6.7 Submission Exhibits	134

List of Tables

Table 3-1: Applicable FCC AWS Blocks	14
Table 4-1: Conducted Emissions - List of Test Equipment	16
Table 4-2 Radiated Emissions - List of Test Equipment	17
Table 5-1: Applicable Test Parameters / Results Summary.....	18
Table 6-1: Setting / Measurement Results – 5MHz Channel Power.....	21
Table 6-2: Setting / Measurement Results – 10MHz Channel Power.....	21
Table 6-3: Setting / Measurement Results – Occupied Bandwidth 5MHz	48
Table 6-4: Setting / Measurement Results – Occupied Bandwidth 10MHz	48
Table 6-5: Setting / Measurement Results – Spurious Emissions Band Edge BW = 5MHz	68
Table 6-6: Setting / Measurement Results – Spurious Emissions Band Edge BW = 10MHz	68
Table 6-7: Setting / Results – BW = 5MHz, Spurious Emissions 30MHz - 26.5GHz	69
Table 6-8: Setting / Results – BW = 10MHz, Spurious Emissions 30MHz – 26.5GHz.....	69
Table 6-9 Spurious Emissions ERP	126
Table 6-10: Frequency Stability vs. Temperature / Voltage Variation	128

List of Figures

Figure 3-1: UUT – Block Diagram RRUL 11 B4 Co-Site AWS.....	15
Figure 6-1 RRU Radio Compliance Set Up / Configuration	20
Figure 6-2: 5MHz BW Channel Power TX1_QPSK at 2112.5 MHz.....	22
Figure 6-3: 5MHz BW Channel Power TX2_QPSK at 2112.5 MHz.....	22
Figure 6-4: 5MHz BW Channel Power TX1_16QAM at 2112.5 MHz.....	23
Figure 6-5: 5MHz BW Channel Power TX2_16QAM at 2112.5 MHz.....	23
Figure 6-6: 5MHz BW Channel Power TX1_64QAM at 2112.5 MHz.....	24
Figure 6-7: 5MHz BW Channel Power TX2_64QAM at 2112.5 MHz.....	24
Figure 6-8: 5MHz BW Modulation TX1_QPSK at 2132.5MHz.....	25
Figure 6-9 : 5MHz BW Channel Power TX1_QPSK at 2132.5 MHz.....	25
Figure 6-10: 5MHz BW Modulation TX2_QPSK at 2132.5MHz.....	26
Figure 6-11 : 5MHz BW Channel Power TX2_QPSK at 2132.5 MHz.....	26
Figure 6-12: 5MHz BW Modulation TX1_16QAM at 2132.5MHz.....	27
Figure 6-13 : 5MHz BW Channel Power TX1_16QAM at 2132.5 MHz.....	27
Figure 6-14: 5MHz BW Modulation TX2_16QAM at 2132.5MHz.....	28
Figure 6-15 : 5MHz BW Channel Power TX2_16QAM at 2132.5 MHz.....	28
Figure 6-16: 5MHz BW Modulation TX1_64QAM at 2132.5MHz.....	29
Figure 6-17 : 5MHz BW Channel Power TX1_64QAM at 2132.5 MHz.....	29
Figure 6-18: 5MHz BW Modulation TX2_64QAM at 2132.5MHz.....	30
Figure 6-19 : 5MHz BW Channel Power TX2_64QAM at 2132.5 MHz.....	30
Figure 6-20 : 5MHz BW Channel Power TX1_QPSK at 2152.5 MHz.....	31
Figure 6-21 : 5MHz BW Channel Power TX2_QPSK at 2152.5 MHz.....	31
Figure 6-22 : 5MHz BW Channel Power TX1_16QAM at 2152.5 MHz.....	32
Figure 6-23 : 5MHz BW Channel Power TX2_16QAM at 2152.5 MHz.....	32
Figure 6-24 : 5MHz BW Channel Power TX1_64QAM at 2152.5 MHz.....	33
Figure 6-25 : 5MHz BW Channel Power TX2_64QAM at 2152.5 MHz.....	33
Figure 6-26 : 10MHz BW Channel Power TX1_QPSK at 2115.0 MHz.....	34
Figure 6-27 : 10MHz BW Channel Power TX2_QPSK at 2115.0 MHz.....	34
Figure 6-28 : 10MHz BW Channel Power TX1_16QAM at 2115.0 MHz.....	35
Figure 6-29 : 10MHz BW Channel Power TX2_16QAM at 2115.0 MHz.....	35
Figure 6-30 : 10MHz BW Channel Power TX1_64QAM at 2115.0 MHz.....	36
Figure 6-31 : 10MHz BW Channel Power TX2_64QAM at 2115.0 MHz.....	36
Figure 6-32 : 10MHz BW Modulation TX1_QPSK at 2132.5 MHz.....	37
Figure 6-33 : 10MHz BW Channel Power TX1_QPSK at 2132.5 MHz.....	37
Figure 6-34 : 10MHz BW Modulation TX2_QPSK at 2132.5MHz.....	38
Figure 6-35 : 10MHz BW Channel Power TX2_QPSK at 2132.5 MHz.....	38
Figure 6-36 : 10MHz BW Modulation TX1_16QAM at 2132.5 MHz.....	39
Figure 6-37 : 10MHz BW Channel Power TX1_16QAM at 2132.5 MHz.....	39
Figure 6-38 : 10MHz BW Modulation TX2_16QAM at 2132.5MHz.....	40
Figure 6-39 : 10MHz BW Channel Power TX2_16QAM at 2132.5 MHz.....	40
Figure 6-40 : 10MHz BW Modulation TX1_64QAM at 2132.5 MHz.....	41
Figure 6-41 : 10MHz BW Channel Power TX1_64QAM at 2132.5MHz.....	41
Figure 6-42 : 10MHz BW Modulation TX2_64QAM at 2132.5MHz.....	42
Figure 6-43 : 10MHz BW Channel Power TX2_64QAM at 2132.5MHz.....	42
Figure 6-44 : 10MHz BW Channel Power TX1_QPSK at 2150.0 MHz.....	43
Figure 6-45 : 10MHz BW Channel Power TX2_QPSK at 2150.0 MHz.....	43
Figure 6-46 : 10MHz BW Channel Power TX1_16QAM at 2150.0 MHz.....	44
Figure 6-47 : 10MHz BW Channel Power TX2_16QAM at 2150.0 MHz.....	44
Figure 6-48 : 10MHz BW Channel Power TX1_64QAM at 2150.0 MHz.....	45

Figure 6-49 : 10MHz BW Channel Power TX2_64QAM at 2150.0 MHz.....	45
Figure 6-50 RRU Radio Compliance Set Up / Configuration	47
Figure 6-51: 5MHz Occupied Bandwidth TX1_QPSK at 2112.5 MHz	49
Figure 6-52: 5MHz Occupied Bandwidth TX2_QPSK at 2112.5 MHz	49
Figure 6-53: 5MHz Occupied Bandwidth TX1_16QAM at 2112.5 MHz.....	50
Figure 6-54: 5MHz Occupied Bandwidth TX2_16QAM at 2112.5 MHz.....	50
Figure 6-55: 5MHz Occupied Bandwidth TX1_64QAM at 2112.5 MHz.....	51
Figure 6-56: 5MHz Occupied Bandwidth TX2_64QAM at 2112.5 MHz.....	51
Figure 6-57: 5MHz Occupied Bandwidth TX1_QPSK at 2132.5 MHz	52
Figure 6-58: 5MHz Occupied Bandwidth TX2_QPSK at 2132.5 MHz	52
Figure 6-59: 5MHz Occupied Bandwidth TX1_16QAM at 2132.5 MHz.....	53
Figure 6-60: 5MHz Occupied Bandwidth TX2_16QAM at 2132.5 MHz.....	53
Figure 6-61: 5MHz Occupied Bandwidth TX1_64QAM at 2132.5 MHz.....	54
Figure 6-62: 5MHz Occupied Bandwidth TX2_64QAM at 2132.5 MHz.....	54
Figure 6-63: 5MHz Occupied Bandwidth TX1_QPSK at 2152.5 MHz	55
Figure 6-64: 5MHz Occupied Bandwidth TX2_QPSK at 2152.5 MHz	55
Figure 6-65: 5MHz Occupied Bandwidth TX1_16QAM at 2152.5 MHz.....	56
Figure 6-66: 5MHz Occupied Bandwidth TX2_16QAM at 2152.5 MHz.....	56
Figure 6-67: 5MHz Occupied Bandwidth TX1_64QAM at 2152.5 MHz.....	57
Figure 6-68: 5MHz Occupied Bandwidth TX2_64QAM at 2152.5 MHz.....	57
Figure 6-69: 10MHz Occupied Bandwidth TX1_QPSK at 2115.0 MHz	58
Figure 6-70: 10MHz Occupied Bandwidth TX2_QPSK at 2115.0 MHz	58
Figure 6-71: 10MHz Occupied Bandwidth TX1_16QAM at 2115.0 MHz.....	59
Figure 6-72: 10MHz Occupied Bandwidth TX2_16QAM at 2115.0 MHz.....	59
Figure 6-73: 10MHz Occupied Bandwidth TX1_64QAM at 2115.0 MHz.....	60
Figure 6-74: 10MHz Occupied Bandwidth TX2_64QAM at 2115.0 MHz.....	60
Figure 6-75: 10MHz Occupied Bandwidth TX1_QPSK at 2132.5 MHz	61
Figure 6-76: 10MHz Occupied Bandwidth TX2_QPSK at 2132.5 MHz	61
Figure 6-77: 10MHz Occupied Bandwidth TX1_16QAM at 2132.5 MHz.....	62
Figure 6-78: 10MHz Occupied Bandwidth TX2_16QAM at 2132.5 MHz.....	62
Figure 6-79: 10MHz Occupied Bandwidth TX1_64QAM at 2132.5 MHz.....	63
Figure 6-80: 10MHz Occupied Bandwidth TX2_64QAM at 2132.5 MHz.....	63
Figure 6-81: 10MHz Occupied Bandwidth TX1_QPSK at 2150.0 MHz	64
Figure 6-82: 10MHz Occupied Bandwidth TX2_QPSK at 2150.0 MHz	64
Figure 6-83: 10MHz Occupied Bandwidth TX1_16QAM at 2150.0 MHz.....	65
Figure 6-84: 10MHz Occupied Bandwidth TX2_16QAM at 2150.0 MHz.....	65
Figure 6-85: 10MHz Occupied Bandwidth TX1_64QAM at 2150.0 MHz.....	66
Figure 6-86: 10MHz Occupied Bandwidth TX2_64QAM at 2150.0 MHz.....	66
Figure 6-87 RRU Radio Compliance Set Up / Configuration	67
Figure 6-88 Spurious Emissions 2112.5MHz TX1_QPSK 5MHz Band Edge (ACP 15kHz – 550kHz)	70
Figure 6-89 Spurious Emissions 2112.5MHz TX1_QPSK 5MHz Band Edge (ACP 650kHz – 2MHz).....	70
Figure 6-90 Spurious Emissions 2112.5MHz TX2_QPSK 5MHz Band Edge (ACP 15kHz – 550kHz)	71
Figure 6-91 Spurious Emissions 2112.5MHz TX2_QPSK 5MHz Band Edge (ACP 650kHz – 2MHz).....	71
Figure 6-92 Spurious Emissions 2112.5MHz TX1_16QAM 5MHz Band Edge (ACP 15kHz – 550kHz)	72
Figure 6-93 Spurious Emissions 2112.5MHz TX1_16QAM 5MHz Band Edge (ACP 650kHz – 2MHz).....	72
Figure 6-94 Spurious Emissions 2112.5MHz TX2_16QAM 5MHz Band Edge (ACP 15kHz – 550kHz)	73
Figure 6-95 Spurious Emissions 2112.5MHz TX2_16QAM 5MHz Band Edge (ACP 650kHz – 2MHz).....	73
Figure 6-96 Spurious Emissions 2112.5MHz TX1_64QAM 5MHz Band Edge (ACP 15kHz – 550kHz)	74
Figure 6-97 Spurious Emissions 2112.5MHz TX1_64QAM 5MHz Band Edge (ACP 650kHz – 2MHz).....	74
Figure 6-98 Spurious Emissions 2112.5MHz TX2_64QAM 5MHz Band Edge (ACP 15kHz – 550kHz)	75
Figure 6-99 Spurious Emissions 2112.5MHz TX2_64QAM 5MHz Band Edge (ACP 650kHz – 2MHz).....	75
Figure 6-100 Spurious Emissions 2132.5MHz TX1_QPSK 5MHz Band Edge (ACP 15kHz – 550kHz)	76
Figure 6-101 Spurious Emissions 2132.5MHz TX1_QPSK 5MHz Band Edge (ACP 650kHz – 2MHz).....	76

Figure 6-102 Spurious Emissions 2132.5MHz TX2_QPSK 5MHz Band Edge (ACP 15kHz – 550kHz)	77
Figure 6-103 Spurious Emissions 2132.5MHz TX2_QPSK 5MHz Band Edge (ACP 650kHz – 2MHz).....	77
Figure 6-104 Spurious Emissions 2132.5MHz TX1_16QAM 5MHz Band Edge (ACP 15kHz – 550kHz)	78
Figure 6-105 Spurious Emissions 2132.5MHz TX1_16QAM 5MHz Band Edge (ACP 650kHz – 2MHz).....	78
Figure 6-106 Spurious Emissions 2132.5MHz TX2_16QAM 5MHz Band Edge (ACP 15kHz – 550kHz)	79
Figure 6-107 Spurious Emissions 2132.5MHz TX2_16QAM 5MHz Band Edge (ACP 650kHz – 2MHz).....	79
Figure 6-108 Spurious Emissions 2132.5MHz TX1_64QAM 5MHz Band Edge (ACP 15kHz – 550kHz)	80
Figure 6-109 Spurious Emissions 2132.5MHz TX1_64QAM 5MHz Band Edge (ACP 650kHz – 2MHz).....	80
Figure 6-110 Spurious Emissions 2132.5MHz TX2_64QAM 5MHz Band Edge (ACP 15kHz – 550kHz)	81
Figure 6-111 Spurious Emissions 2132.5MHz TX2_64QAM 5MHz Band Edge (ACP 650kHz – 2MHz).....	81
Figure 6-112 Spurious Emissions 2152.5MHz TX1_QPSK 5MHz Band Edge (ACP 15kHz – 550kHz)	82
Figure 6-113 Spurious Emissions 2152.5MHz TX1_QPSK 5MHz Band Edge (ACP 650kHz – 2MHz).....	82
Figure 6-114 Spurious Emissions 2152.5MHz TX2_QPSK 5MHz Band Edge (ACP 15kHz – 550kHz)	83
Figure 6-115 Spurious Emissions 2152.5MHz TX2_QPSK 5MHz Band Edge (ACP 650kHz – 2MHz).....	83
Figure 6-116 Spurious Emissions 2152.5MHz TX1_16QAM 5MHz Band Edge (ACP 15kHz – 550kHz)	84
Figure 6-117 Spurious Emissions 2152.5MHz TX1_16QAM 5MHz Band Edge (ACP 650kHz – 2MHz).....	84
Figure 6-118 Spurious Emissions 2152.5MHz TX2_16QAM 5MHz Band Edge (ACP 15kHz – 550kHz)	85
Figure 6-119 Spurious Emissions 2152.5MHz TX2_16QAM 5MHz Band Edge (ACP 650kHz – 2MHz).....	85
Figure 6-120 Spurious Emissions 2152.5MHz TX1_64QAM 5MHz Band Edge (ACP 15kHz – 550kHz)	86
Figure 6-121 Spurious Emissions 2152.5MHz TX1_64QAM 5MHz Band Edge (ACP 650kHz – 2MHz).....	86
Figure 6-122 Spurious Emissions 2152.5MHz TX2_64QAM 5MHz Band Edge (ACP 15kHz – 550kHz)	87
Figure 6-123 Spurious Emissions 2152.5MHz TX2_64QAM 5MHz Band Edge (ACP 650kHz – 2MHz).....	87
Figure 6-124 Spurious Emission TX1 64QAM 2112.5MHz - 5MHz (30MHz - 4GHz)	88
Figure 6-125 Spurious Emission TX1 64QAM 2152.5MHz – 5MHz (30MHz - 4GHz)	88
Figure 6-126 Spurious Emission TX2 64QAM 2112.5MHz - 5MHz (30MHz - 4GHz)	89
Figure 6-127 Spurious Emission TX2 64QAM 2152.5MHz – 5MHz (30MHz - 4GHz)	89
Figure 6-128 Spurious Emission TX1 64QAM 2112.5MHz - 5MHz (3.5GHz – 8.4GHz)	90
Figure 6-129 Spurious Emission TX1 64QAM 2152.5MHz – 5MHz (3.5GHz – 8.4GHz)	90
Figure 6-130 Spurious Emission TX2 64QAM 2112.5MHz - 5MHz (3.5GHz – 8.4GHz)	91
Figure 6-131 Spurious Emission TX2 64QAM 2152.5MHz – 5MHz (3.5GHz – 8.4GHz)	91
Figure 6-132 Spurious Emission TX1 64QAM 2112.5MHz - 5MHz (8GHz- 16GHz).....	92
Figure 6-133 Spurious Emission TX1 64QAM 2152.5MHz – 5MHz (8GHz- 16GHz).....	92
Figure 6-134 Spurious Emission TX2 64QAM 2112.5MHz - 5MHz (8GHz- 16GHz).....	93
Figure 6-135 Spurious Emission TX2 64QAM 2152.5MHz – 5MHz (8GHz- 16GHz).....	93
Figure 6-136 Spurious Emission TX1 64QAM 2112.5MHz - 5MHz (15.5GHz – 26.5GHz)	94
Figure 6-137 Spurious Emission TX1 64QAM 2152.5MHz – 5MHz (15.5GHz – 26.5GHz)	94
Figure 6-138 Spurious Emission TX2 64QAM 2112.5MHz - 5MHz (15.5GHz – 26.5GHz)	95
Figure 6-139 Spurious Emission TX2 64QAM 2152.5MHz – 5MHz (15.5GHz – 26.5GHz)	95
Figure 6-140 Spurious Emissions 2115.0MHz TX1_QPSK 10MHz Band Edge (ACP 15kHz – 550kHz).....	96
Figure 6-141 Spurious Emissions 2115.0MHz TX1_QPSK 10MHz Band Edge (ACP 650kHz – 2MHz).....	96
Figure 6-142 Spurious Emissions 2115.0MHz TX2_QPSK 10MHz Band Edge (ACP 15kHz – 550kHz).....	97
Figure 6-143 Spurious Emissions 2115.0MHz TX2_QPSK 10MHz Band Edge (ACP 650kHz – 2MHz).....	97
Figure 6-144 Spurious Emissions 2115.0MHz TX1_16QAM 10MHz Band Edge (ACP 15kHz – 550kHz)	98
Figure 6-145 Spurious Emissions 2115.0MHz TX1_16QAM 10MHz Band Edge (ACP 650kHz – 2MHz).....	98
Figure 6-146 Spurious Emissions 2115.0MHz TX2_16QAM 10MHz Band Edge (ACP 15kHz – 550kHz)	99
Figure 6-147 Spurious Emissions 2115.0MHz TX2_16QAM 10MHz Band Edge (ACP 650kHz – 2MHz).....	99
Figure 6-148 Spurious Emissions 2115.0MHz TX1_64QAM 10MHz Band Edge (ACP 15kHz – 550kHz)	100
Figure 6-149 Spurious Emissions 2115.0MHz TX1_64QAM 10MHz Band Edge (ACP 650kHz – 2MHz).....	100
Figure 6-150 Spurious Emissions 2115.0MHz TX2_64QAM 10MHz Band Edge (ACP 15kHz – 550kHz)	101
Figure 6-151 Spurious Emissions 2115.0MHz TX2_64QAM 10MHz Band Edge (ACP 650kHz – 2MHz).....	101
Figure 6-152 Spurious Emissions 2132.5MHz TX1_QPSK 10MHz Band Edge (ACP 15kHz – 550kHz).....	102
Figure 6-153 Spurious Emissions 2132.5MHz TX1_QPSK 10MHz Band Edge (ACP 650kHz – 2MHz).....	102
Figure 6-154 Spurious Emissions 2132.5MHz TX2_QPSK 10MHz Band Edge (ACP 15kHz – 550kHz).....	103

Figure 6-155 Spurious Emissions 2132.5MHz TX2_QPSK 10MHz Band Edge (ACP 650kHz – 2MHz).....	103
Figure 6-156 Spurious Emissions 2132.5MHz TX1_16QAM 10MHz Band Edge (ACP 15kHz – 550KHz)	104
Figure 6-157 Spurious Emissions 2132.5MHz TX1_16QAM 10MHz Band Edge (ACP 650kHz – 2MHz).....	104
Figure 6-158 Spurious Emissions 2132.5MHz TX2_16QAM 10MHz Band Edge (ACP 15kHz – 550KHz)	105
Figure 6-159 Spurious Emissions 2132.5MHz TX2_16QAM 10MHz Band Edge (ACP 650kHz – 2MHz).....	105
Figure 6-160 Spurious Emissions 2132.5MHz TX1_64QAM 10MHz Band Edge (ACP 15kHz – 550KHz)	106
Figure 6-161 Spurious Emissions 2132.5MHz TX1_64QAM 10MHz Band Edge (ACP 650kHz – 2MHz).....	106
Figure 6-162 Spurious Emissions 2132.5MHz TX2_64QAM 10MHz Band Edge (ACP 15kHz – 550KHz)	107
Figure 6-163 Spurious Emissions 2132.5MHz TX2_64QAM 10MHz Band Edge (ACP 650kHz – 2MHz).....	107
Figure 6-164 Spurious Emissions 2150.0MHz TX1_QPSK 10MHz Band Edge (ACP 15kHz – 550KHz).....	108
Figure 6-165 Spurious Emissions 2150.0MHz TX1_QPSK 10MHz Band Edge (ACP 650kHz – 2MHz).....	108
Figure 6-166 Spurious Emissions 2150.0MHz TX2_QPSK 10MHz Band Edge (ACP 15kHz – 550KHz).....	109
Figure 6-167 Spurious Emissions 2150.0MHz TX2_QPSK 10MHz Band Edge (ACP 650kHz – 2MHz).....	109
Figure 6-168 Spurious Emissions 2150.0MHz TX1_16QAM 10MHz Band Edge (ACP 15kHz – 550KHz)	110
Figure 6-169 Spurious Emissions 2150.0MHz TX1_16QAM 10MHz Band Edge (ACP 650kHz – 2MHz).....	110
Figure 6-170 Spurious Emissions 2150.0MHz TX2_16QAM 10MHz Band Edge (ACP 15kHz – 550KHz)	111
Figure 6-171 Spurious Emissions 2150.0MHz TX2_16QAM 10MHz Band Edge (ACP 650kHz – 2MHz).....	111
Figure 6-172 Spurious Emissions 2150.0MHz TX1_64QAM 10MHz Band Edge (ACP 15kHz – 550KHz)	112
Figure 6-173 Spurious Emissions 2150.0MHz TX1_64QAM 10MHz Band Edge (ACP 650kHz – 2MHz).....	112
Figure 6-174 Spurious Emissions 2150.0MHz TX2_64QAM 10MHz Band Edge (ACP 15kHz – 550KHz)	113
Figure 6-175 Spurious Emissions 2150.0MHz TX2_64QAM 10MHz Band Edge (ACP 650kHz – 2MHz).....	113
Figure 6-176 Spurious Emission TX1 64QAM 2115.0MHz - 10MHz (30MHz - 4GHz).....	114
Figure 6-177 Spurious Emission TX1 64QAM 2150.0MHz - 10MHz (30MHz - 4GHz).....	114
Figure 6-178 Spurious Emission TX2 64QAM 2115.0MHz - 10MHz (30MHz - 4GHz).....	115
Figure 6-179 Spurious Emission TX2 64QAM 2150.0MHz - 10MHz (30MHz - 4GHz).....	115
Figure 6-180 Spurious Emission TX1 64QAM 2115.0MHz - 10MHz (3.5GHz – 8.4GHz).....	116
Figure 6-181 Spurious Emission TX1 64QAM 2150.0MHz - 10MHz (3.5GHz – 8.4GHz).....	116
Figure 6-182 Spurious Emission TX2 64QAM 2115.0MHz - 10MHz (3.5GHz – 8.4GHz).....	117
Figure 6-183 Spurious Emission TX2 64QAM 2150.0MHz – 10MHz (3.5GHz – 8.4GHz)	117
Figure 6-184 Spurious Emission TX1 64QAM 2115.0MHz - 10MHz (8GHz- 16GHz).....	118
Figure 6-185 Spurious Emission TX1 64QAM 2150.0MHz – 10MHz (8GHz- 16GHz).....	118
Figure 6-186 Spurious Emission TX2 64QAM 2115.0MHz - 10MHz (8GHz- 16GHz).....	119
Figure 6-187 Spurious Emission TX2 64QAM 2150.0MHz – 10MHz (8GHz- 16GHz).....	119
Figure 6-188 Spurious Emission TX1 64QAM 2115.0MHz - 10MHz (15.5GHz – 26.5GHz)	120
Figure 6-189 Spurious Emission TX1 64QAM 2150.0MHz – 10MHz (15.5GHz – 26.5GHz)	120
Figure 6-190 Spurious Emission TX2 64QAM 2115.0MHz - 10MHz (15.5GHz – 26.5GHz).....	121
Figure 6-191 Spurious Emission TX2 64QAM 2150.0MHz – 10MHz (15.5GHz – 26.5GHz)	121
Figure 6-192 RRU Field Strength Set Up / Configuration	122
Figure 6-193 RRU EMC Set Up / Configuration	125
Figure 6-197 Radiated Emissions Set Up Photo.....	126
Figure 6-198 RRU Stability Set Up / Configuration	127
Figure 6-199 Stability 10MHz @ -30C	129
Figure 6-200 Stability 10MHz @ -20C	129
Figure 6-201 Stability 10MHz @ -10C	130
Figure 6-202 Stability 10MHz @ 0C.....	130
Figure 6-203 Stability 10MHz @ +10C	131
Figure 6-204 Stability 10MHz @ +20C	131
Figure 6-205 Stability 10MHz @ +30C	132
Figure 6-206 Stability 10MHz @ +40C	132
Figure 6-207 Stability 10MHz @ +50C	133

Acronyms

RRU	Remote Radio Unit
RRUL	Remote Radio Unit LTE
DDM	Dual Duplexer Module
BTS	Base Station Transceiver
EUT	Equipment Under Test
LTE	Long Term Evolution
ACP	Adjacent Channel Power
CPRI	Common Public Radio Interface
NIST	National Institute of Standards and Technology
NRTL	National Recognized Testing Laboratory
NVLAP	National Voluntary Laboratory Accreditation Program
LAP	Laboratory Accreditation Programs
IC	Industry Canada
FCC	Federal Communication Commission
CFR	Code of Federal Regulations (US)
CAB	Conformity assessment body
EMC	Electromagnetic Compatibility
EMI	Electromagnetic interference
RTTE	Radio and Telecommunications Terminal Equipment
TTE	Telecommunications equipment
TCB	Telecom Certification Body
CCB	Canadian Certification Body
IECEE	International Electro-technical Committee for Conformity Testing to Standards for Electrical Equipment
NCB	National Certification Bodies
CBTL	CB Test Laboratory
ITL	Independent Test Laboratory
ITE	Information Technology Equipment

1 Summary

Applicant: Ericsson Canada
3500 Carling Ave.
Ottawa, On
Canada
K2H 8E9

Apparatus: KRC 131 143/3 (RRUL11 B4 AWS)
Application: Fixed Wireless Base Station Transceiver

FCC ID: VZTAKRC131143-3

In Accordance With: FCC CFR 47 Part 27 Miscellaneous Wireless
Communications Services

This test report has been prepared for the purpose of demonstrating compliance with FCC CFR Title 47 Part 27. Conducted measurements have been performed in accordance with ANSI TIA-603-B-2002. Radiated tests have been conducted in accordance with ANSI C63.4-2003. Radiated emissions are assessed and measured at an accredited ITL in a 3 meter or 10 meter Semi-Anechoic chamber. Conducted Emissions have been assessed at Ericsson Carling facilities using calibrated equipment in accordance with Part 27 Requirements.

The assessment summary is as follows:

Apparatus Assessed: KRC 131 143/3 (RRUL 11 B4 Remote Radio Unit - AWS)

Specification: FCC CFR 47 Part 27 Miscellaneous Wireless
Communications Services

Compliance Status: Complies

Exclusions: None

Non-compliances: None

Report Release History: Original Release

2 Introduction

This document supports the FCC test process and filing requirements for North American approvals. Measurements are conducted to satisfy and demonstrate compliance to the Essential parameters for Radio Compliance and Conformance to the following standards:

- FCC CFR 47 Part 27 Subpart C, Miscellaneous Wireless Communications Services.
- FCC CFR 47, Subpart 2, Subpart J, Equipment Authorization Procedures – Equipment Authorization.

The initial RRU deployment will support a 5MHz and 10MHz BW for Fixed Wireless Base Station (BTS) applications with a rated output power of 30W (44.8dBm) in a 2 x 2 MIMO configuration. Frequency band for authorization will address the US AWS Block.

Hardware Description

The BTS equipment is comprised of the following:

- 1) KRC 131 143/3 RRUL 11 B4: LTE Remote Radio Unit [RRUL] **EUT**
- 2) CPRI Modem Emulator (RU-Master LPC 102 400/5 R1B S/N T01E684474)

RRU Details

Frequency: FCC AWS Band

Transmit / Downlink: 2110MHz – 2155MHz – AWS Block

- Modulation: OFDMA, QPSK, 16QAM, 64QAM
- BW: 5/10 MHz
- MIMO, 2 x 2 (Spatial Multiplexing)
- Diversity, 2 Way Transmit
- Throughput: Up to 60 Mbps
- Power: 44.8dBm (30W)
- PAPR: 7dB

Duplex: FDD (30MHz)

Frequency Stability: +/-0.05ppm

Channel Raster: 100 kHz

Receive / Uplink: 1710 - 1755MHz – AWS: Block

- Modulation: SC-FDMA, QPSK, 16QAM
- BW: 5/10 MHz
- MIMO, 2 x 2, Multi-User
- Throughput: Up to 20Mbps
- Diversity, 2 and 2 Co-Site Receive

RRU Physical Details:

PWR: -48V (typical) DC 350W (max), Size: 17” x 11.3” x 8.7” (H x W x D), Weight: 53lbs

3 Equipment Under Test

3.1 Product Identification

The Equipment Under Test (UUT) is identified for Fixed Base Station operation as follows:
Ericsson Remote Radio Unit RRUL 11 B4 (AWS 2110MHz – 2155MHz) KRC 131 143/3

3.2 Technical Specifications of the EUT

Manufacturer:	Ericsson Canada
Operating Frequency:	Downlink ...TX: 2110 – 2155MHz (5/10MHz) UplinkRX: 1710 – 1755MHz (5/10MHz)
Emission Designator:	5MHz: 5M00 W7D 10MHz: 10M0 W7D
Modulation:	LTE OFDMA, QPSK, 16QAM, 64QAM (Two transmitters, 2 receivers per sector)
Antenna Data: (for reference only)	Andrew HBX-6513DS-T6M 13.2dBd, 15.3dBi (max) Beam-width – Horizontal 65°

3.3 Technical Description

The Ericsson LTE RRU (RRUL) is a single sector Transceiver (2 transmitter, 2 receivers per radio / sector) operating in FDD mode which will be introduced as part of Ericsson's next generation BTS product line. The initial RRU product offering addresses the LTE air interface, while the RRU radio architecture will be 4G agnostic to support OFDM based air interfaces including the long term evolution of GSM/UMTS (LTE), 802.16e OFDMA standards with Multiple Inputs Multiple Outputs (MIMO) operation. Transmitter outputs (TX1, TX2) are isolated and non-correlated for external interface to customer furnished antenna.

The Radio design will address outdoor installations for pole and building/wall mount deployment. RRU electronics are housed in a weather protected environmental enclosure intended for co-location in proximity to the customer furnished antenna. The RRU has an integrated active duplexer for enhanced up link performance and antenna interface. Compliance and performance testing will include a band / spectrum dependent DDM (duplexer) integrated with the RRU product offering.

The RRU operates over the North American AWS band employing a band specific duplexer designed to limit operations to specific customer requirements. The initial RRU product offering will operate over a Down Link (DL) transmit frequency band from 2110MHz to 2155MHz, for channel bandwidths of 5 and

10MHz. LTE modulation formats OFDMA QPSK, 16QAM and 64QAM will be assessed at a rated output of 30W per transmitter.

The recommended customer furnished antenna detail is as follows:

MFG: Andrew Antenna

Model: HBX-6513DS-T6M

Gain: 13.2dBd (15.3dBi)

Beam width: Horizontal 65°

The Ericsson RRU design consists of logical sections comprised of Digital, RF, Power Amplifiers, and a Power Supply and distribution housed in a single outdoor enclosure. Heat fins on the enclosure external surface provide convection cooling for thermal and environmental control. For protection against solar impact, a sun shield mounted on the unit provides additional thermal protection to limit direct solar exposure. The unit operates over an ambient temperature of -40°C to +55°C including sun loading.

The digital section provides processing resources to the RRU CPRI based optical link to the Modem and Soft Radio Core. This single sector Radio is targeted to support up to 20MHz base band data bandwidth. (Initial deployment will be limited to 10MHz) The digital section of the transceiver card provides the processing solution for the 4G Radio.

The PSU provides primary power conversion from a nominal input of -48VDC (350W) for the internal PCB circuit requirements. The PA board produces the RF output power for BTS transmission at a rated power up to 30W per transmitter port. The RRU consists of a Radio transceiver and integrated active Duplexer combination for applicable FCC compliance. All compliance measurements and ratings are referenced at the antenna ports / duplexer interface.

Radio Standard is LTE, OFDMA TX, (SC-FDMA RX) configured for a 2x2 MIMO operating mode with an output rated power of 30W (44.8dBm) at the antenna port. Transmit outputs 1 and 2 are isolated, non-correlated outputs connected to two isolated customer furnished antenna and are measured/verified independently.

The TX Modulation schemes of QPSK, 16QAM, and 64QAM will be supported along with an operational bandwidth of 5MHz and 10MHz for initial product release in the AWS Block spectrum. QPSK, 16QAM, and 64 QAM will employ 3/4 CTC data rate coding. The RRU employs a CPRI (Common Public Radio Interface) for interoperability and standardization of the radio protocol interface. To demonstrate compliance, appropriate LTE waveforms will be utilized to generate the RF output, rated power and bandwidth requirements with respect to the modulation variables. Bandwidths of 5MHz and 10MHz will be assessed for operation within the AWS block.

The KRC 131 143/3 has an added feature to permit Co-Site Receive functionality. Two isolated receiver outputs are provided on the connector Interface enabling this feature.

Table 3-1: Applicable FCC AWS Blocks

<i>Band</i>	<i>Bandwidth</i>	<i>Frequency</i>
4	45MHz	2110 – 2155MHz and 1710 – 1755MHz

Test Units

Part 27: UUT KRC 131 143/3 RRUL 11 B4 AWS, SN: C84700005F SA33
CPRI Modem interface with LTE Test Vectors and traffic (RUMA LPC 102 400/5)

Part 15/27: UUT KRC 131 143/3 RRUL 11 B4 AWS, SN: C84700005F SA33
CPRI Modem interface with LTE Test Vectors and traffic (RUMA LPC 102 400/5)

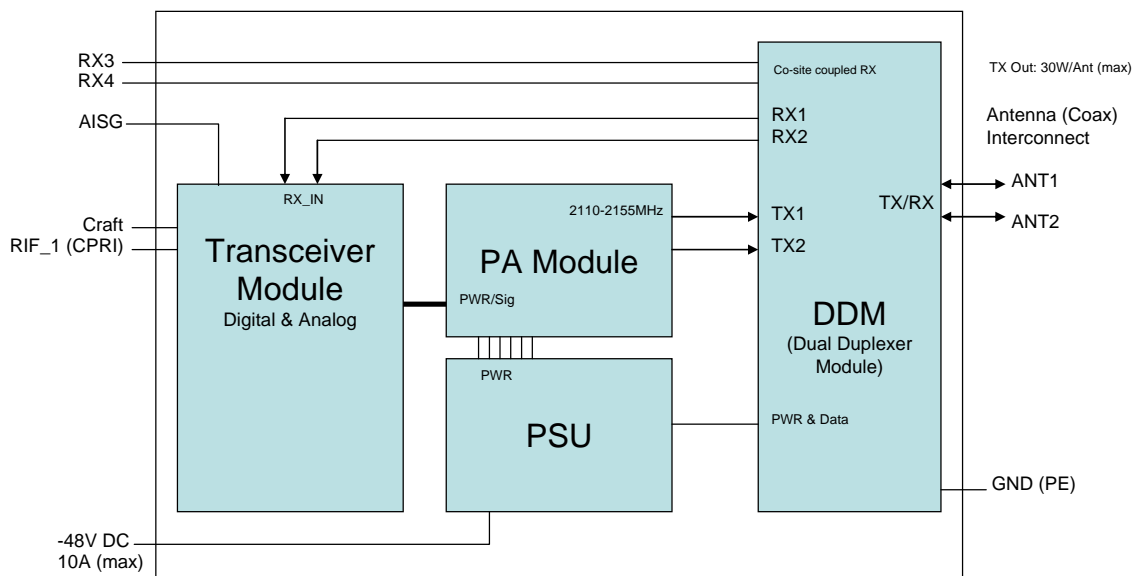

Figure 3-1: UUT – Block Diagram RRUL 11 B4 Co-Site AWS

4 Test Conditions

4.1 Specifications

The apparatus has been assessed against the following specifications:
 FCC CFR 47 Part 27 Miscellaneous Wireless Communications Services

4.2 Test Environment

All tests are performed under the following environmental conditions:

Temperature range	:	15 – 30 °C
Humidity range	:	20 - 75 %
Pressure range	:	86 - 106 kPa
Power supply range	:	+/- 5% of rated voltages

4.3 Test Equipment

Table 4-1: Conducted Emissions - List of Test Equipment

Equipment	Manufacturer	Model No.	Asset/Serial No.	Cal Due
Signal Analyzer (20Hz-8.4GHz)	Agilent	MXA N9020A	1099580/MY49100143	11 Sept 2011
Signal Analyzer (20Hz-26.5GHz)	Agilent	MXA N9020A	1072603/US46470544	15 Sept 2012
Power Meter	HP	438A	L0544032	24 Nov 2010
Power Sensor	HP	8481A	US37290233	24 Nov 2010
Attenuator 30dB (Qty=2)	Narda	769-30	NA	NA
Attenuator 20dB (Qty=2)	Meca	650-20-1F4	NA	NA
Network Analyzer	Agilent	N5230	MY45000798	NA
Climatic Chamber	Burnsco	RTC-37P-3-3	07-07	27 Oct 2010
Power Supply	Sorenson	DLM 60-10	R2310	NCR
Digital Volt Meter	Fluke			

Table 4-2 Radiated Emissions - List of Test Equipment

Equipment	Manufacturer	Model No.	Asset/Serial No.	Next Cal.
10 m EMI Test Chamber				
RF Amplifier	Hewlett Packard	8447D	SSG012405	02/17/2011
50 Coax cable	HUBER + SUHNER	104PEA	SSG012041	10/07/2011
50 Coax cable	HUBER + SUHNER	104PEA	SSG012131	10/29/2010
Spec. A, RF Pre-selector	Hewlett Packard	85685A	SSG012010	03/02/2011
Receiver/Spectrum Analyzer	Hewlett Packard	8566B	SSG012521	03/02/2011
Quasi Peak Adaptor	Hewlett Packard	85650A	SSG012620	03/02/2011
50 Coax cable	HUBER + SUHNER	106A	SSG012453	01/28/2011
50 Coax cable	HUBER + SUHNER	106A	SSG012455	01/28/2011
Active Loop Antenna (H Field)	EMCO	6502	SSG012080	12/01/2010
Active Monopole Antenna	EMCO	3301B	SSG012083	04/16/2011
Bilog Antenna	ARA	LPB 2520A	SSG012772	12/21/2010
Horn Antenna, Double ridged	EMCO	3115	SSG012298	02/19/2011
50 Coax cable	HUBER + SUHNER	ST18	SSG012786	01/26/2011
Pre-Amplifier	BNR	LNA	SSG012360	02/15/2011
Power Supply	Hewlett Packard	6216A	SSG012069	NR
Spectrum Analyzer	Hewlett Packard	8564E	SSG012069	04/15/2011
DC Power Supply	BNR	Nortel 12V	SSG013628	NR
50 Coax cable	HUBER + SUHNER	102A	SSG013084	01/07/2011
50 Coax cable	Micro-Coax	UFA 210B	SSG012376	01/08/2011
Horn Antenna, 18-26GHz	EMCO	3160-09	SSG012292	12/22/2010
Signal Generator	Anritsu	69369A	SSG012138	09/22/2011
Horn Antenna, Double Ridged	EMCO	3115	SSG012267	03/12/2011
50 Coax cable	HUBER + SUHNER	104B	SSG012409	01/27/2011
Radio Frequency Filter	FSY Microwave	DC 9371	SSG013702	02/10/2011
Note: N/A = Not Applicable, NCR = No Cal Required, COU = CAL On Use				

5 Applicable Tests

This section contains the following:

FCC CFR 47 Part 27: Test Requirements

The column headed 'Required' indicates whether the associated clauses were invoked for the apparatus under test. The following abbreviations are used:

N No: Not Applicable / Not Relevant.

Y Yes: Mandatory i.e. the apparatus shall conform to these tests.

N/T Not Tested

The results compiled in this document are in accordance and representative of the operation of the apparatus as originally submitted.

5.1 FCC Part 27: Test Parameters

Table 5-1: Applicable Test Parameters / Results Summary

Clause	Test Method	Test description	Required	Result
27.50(d)	2.1046	RF Output Power	Y	Pass
-----	2.1047	Modulation Characteristics	Y	Pass
-----	2.1049	Occupied Bandwidth	Y	Pass
27.53(h)	2.1051	Band Edge Compliance	Y	Pass
27.53(h)	2.1051	Spurious Emissions at the Antenna Terminal	Y	Pass
27.53(h)	2.1053, 2.1057	Field Strength of Spurious Emissions	Y	Pass
27.54	2.1055	Frequency Stability	Y	Pass

6 Test Results

6.1 Effective Radiated Power

Clause 27.50(d) Limits: FCC CFR Part 2.1046 Fixed Base Station

(d) The following power and antenna height requirements apply to stations transmitting in the 1710–1755 MHz and 2110–2155 MHz bands:

(1) The power of each fixed or base station transmitting in the 2110–2155 MHz band and located in any county with population density of 100 or fewer persons per square mile, based upon the most recently available population statistics from the Bureau of the Census, is limited to a peak equivalent isotropically radiated power (EIRP) of 3280 watts. The power of each fixed or base station transmitting in the 2110–2155 MHz band from any other location is limited to a peak EIRP of 1640 watts. A licensee operating a base or fixed station utilizing a power of more than 1640 watts EIRP must coordinate such operations in advance with all Government and non-Government satellite entities in the 2025–2110 MHz band. Operations above 1640 watts EIRP must also be coordinated in advance with the following licensees within 120 kilometers (75 miles) of the base or fixed station: all Broadband Radio Service (BRS) licensees authorized under part 27 in the 2155–2160 MHz band and all AWS licensees in the 2110–2155 MHz band.

Test Conditions:

All modulation (QPSK, 16QAM, and 64QAM) modes and different data rates are evaluated using representative waveforms of all modulation schemes. The test results shall include 5MHz and 10MHz bandwidths configurations for Lower, Middle and Upper band frequency offsets as applicable.

Physical Channels

A downlink physical channel corresponds to a set of resource elements carrying information originating from higher layers and is the interface defined between 36.212 and 36.211 [15]. The following downlink physical channels are defined:

- Physical Downlink Shared Channel, PDSCH – QPSK, 16QAM, 64QAM
- Physical Broadcast Channel, PBCH - QPSK
- Physical Downlink Control Channel, PDCCH - QPSK
- Physical Control Format Indicator Channel, PCFICH - QPSK
- Physical Hybrid ARQ Indicator Channel, PHICH - BPSK

LTE standard defines BPSK as an ARQ Indicator Channel, thus being embedded into the LTE signal and does not contain traffic data. As BPSK is embedded in each modulation scheme, waveforms tested represent the worst case conditions.

Test Setup

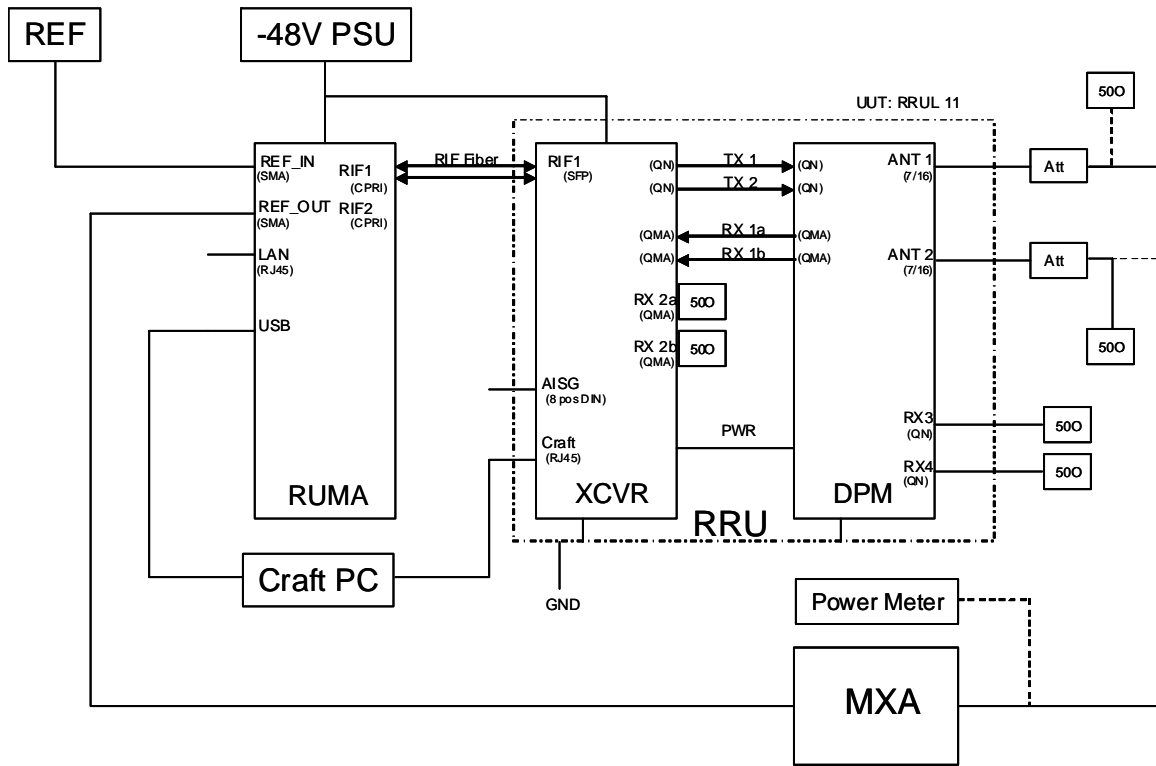

Figure 6-1 RRU Radio Compliance Set Up / Configuration

Procedure:

Channel Power measurements for each output shall be conducted for the applicable bandwidths and modulation schemes for the Lower, Middle and Upper frequency offsets as warranted. The following tables are used to summarize recorded results in addition to applicable captured plots.

Table 6-1: Setting / Measurement Results – 5MHz Channel Power

Setting			5MHz Channel Power Output (dBm)					
			QPSK		16 QAM		64 QAM	
			TX1	TX2	TX1	TX2	TX1	TX2
Frequency	(Lower CH_1975)	2112.5MHz	44.75	44.65	44.85	44.67	44.79	44.67
Frequency	(Middle CH_2175)	2132.5MHz	44.69	44.92	44.76	44.71	44.85	44.79
Frequency	(Upper CH_2375)	2152.5MHz	44.80	44.82	44.80	44.88	44.76	44.72
RBW	180kHz							
VBW	1.8MHz							
CH BW	5MHz							
Span	20MHz							
Sweep	1ms							
Reference Level Offset	53.2dB							
Detector	RMS		Aggregate Power = $10^{(10 \cdot \text{LOG}(10^{(TX1/10)} + 10^{(TX2/10)})/10)/1000}$					
Attenuation	10dB		60.54W		60.96W		60.68W	

Table 6-2: Setting / Measurement Results – 10MHz Channel Power

Setting			10MHz Channel Power Output (dBm)					
			QPSK		16 QAM		64 QAM	
			TX1	TX2	TX1	TX2	TX1	TX2
Frequency	(Lower CH_2000)	2115.0MHz	44.77	44.89	44.79	44.82	44.61	44.99
Frequency	(Middle CH_2175)	2132.5MHz	44.84	44.79	44.77	44.86	44.73	44.93
Frequency	(Upper CH_2350)	2150.0MHz	44.83	44.88	44.93	44.83	44.92	44.88
RBW	180kHz							
VBW	1.8MHz							
CH BW	10MHz							
Span	20MHz							
Sweep	1ms							
Reference Level Offset	53.2dB							
Detector	RMS		Aggregate Power = $10^{(10 \cdot \text{LOG}(10^{(TX1/10)} + 10^{(TX2/10)})/10)/1000}$					
Attenuation	10dB		61.17W		61.53W		61.81W	

5MHz Aggregate Power = TX1 + TX2
 $= 10 \cdot \log(10^{(44.80/10)} + 10^{(44.88/10)}) = 47.85\text{dBm}/5\text{MHz} = 10^{(47.85/10)/1000} = \mathbf{60.96W}/5\text{MHz}$

10MHz Aggregate Power = TX1 + TX2
 $= 10 \cdot \log(10^{(44.92/10)} + 10^{(44.88/10)}) = 47.91\text{dBm}/10\text{MHz} = 10^{(47.91/10)/1000} = \mathbf{61.81W}/10\text{MHz}$

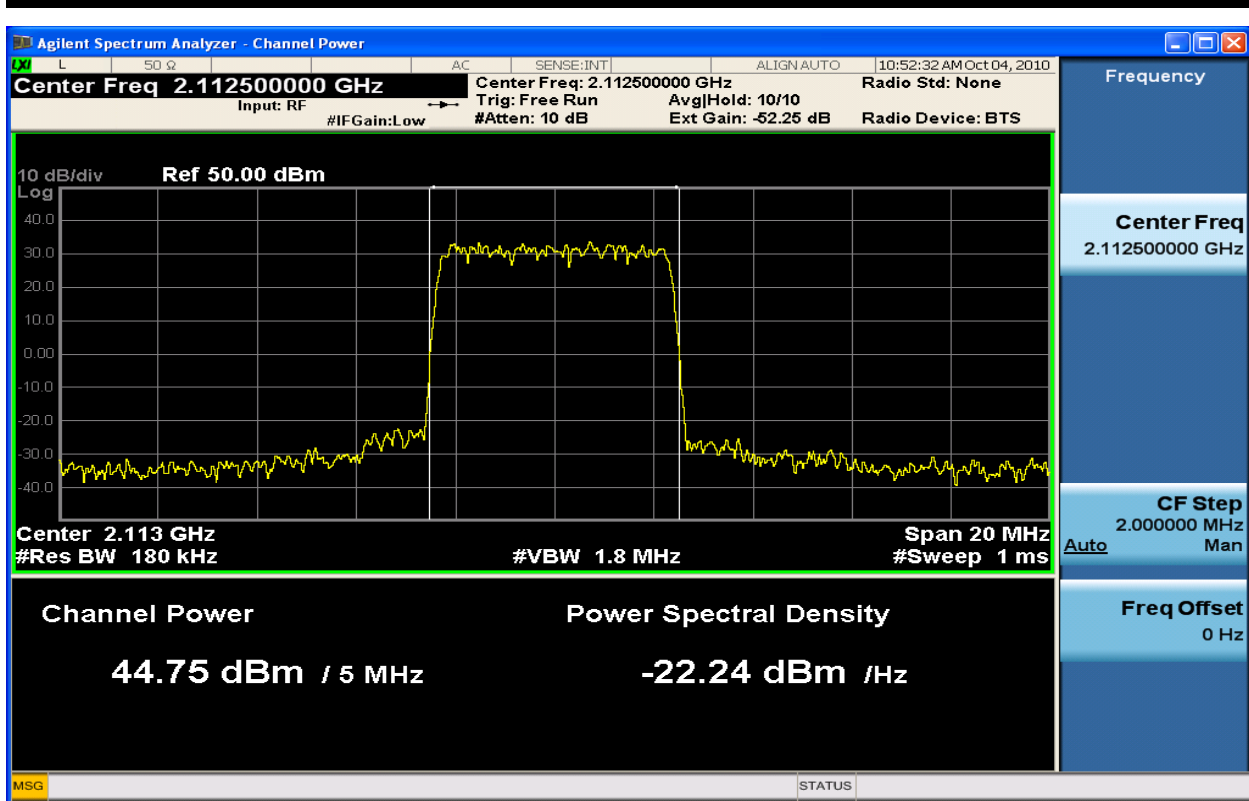

Figure 6-2: 5MHz BW Channel Power TX1_QPSK at 2112.5 MHz

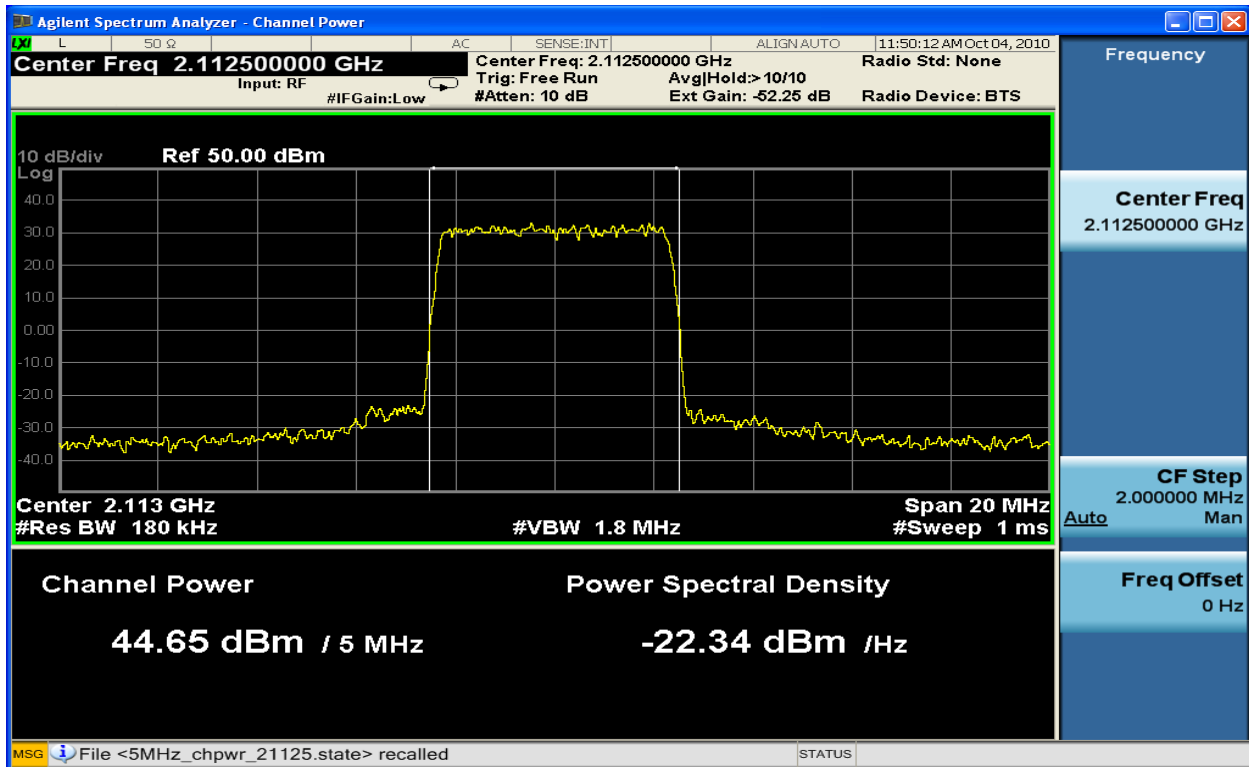

Figure 6-3: 5MHz BW Channel Power TX2_QPSK at 2112.5 MHz

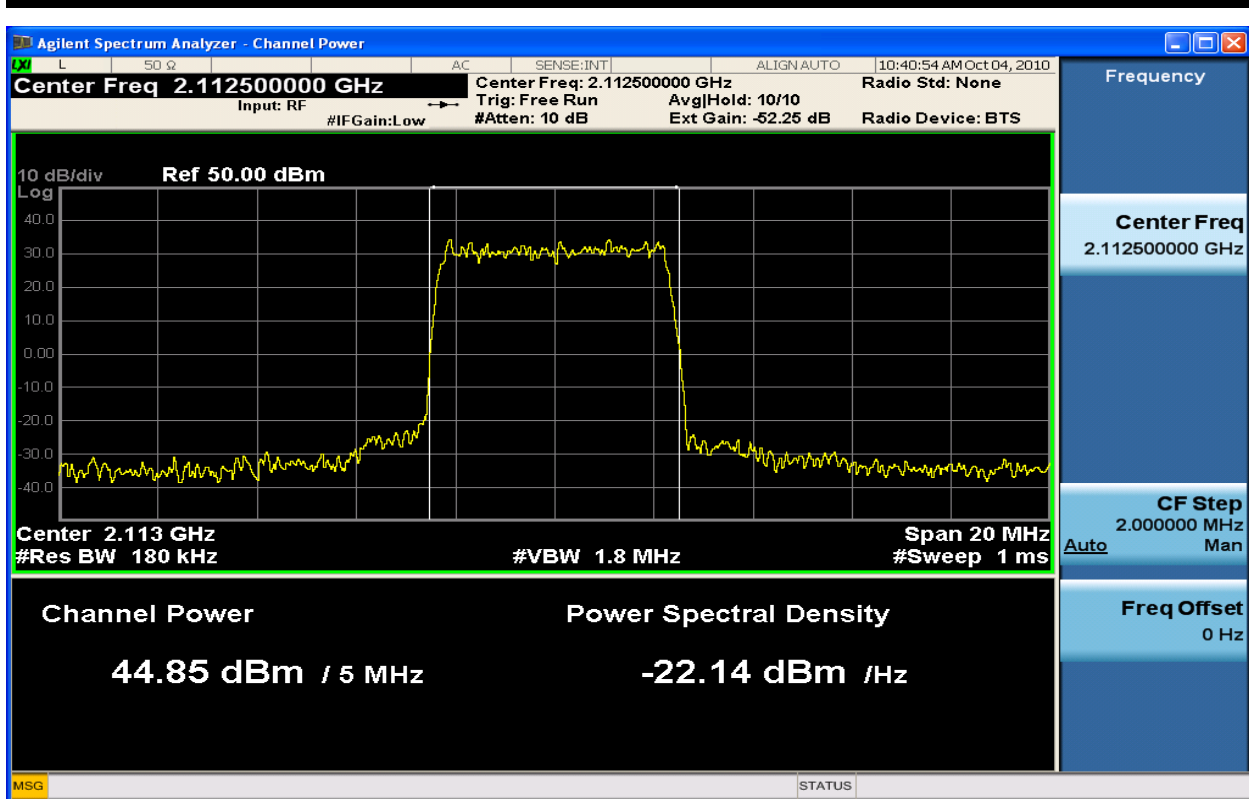

Figure 6-4: 5MHz BW Channel Power TX1_16QAM at 2112.5 MHz

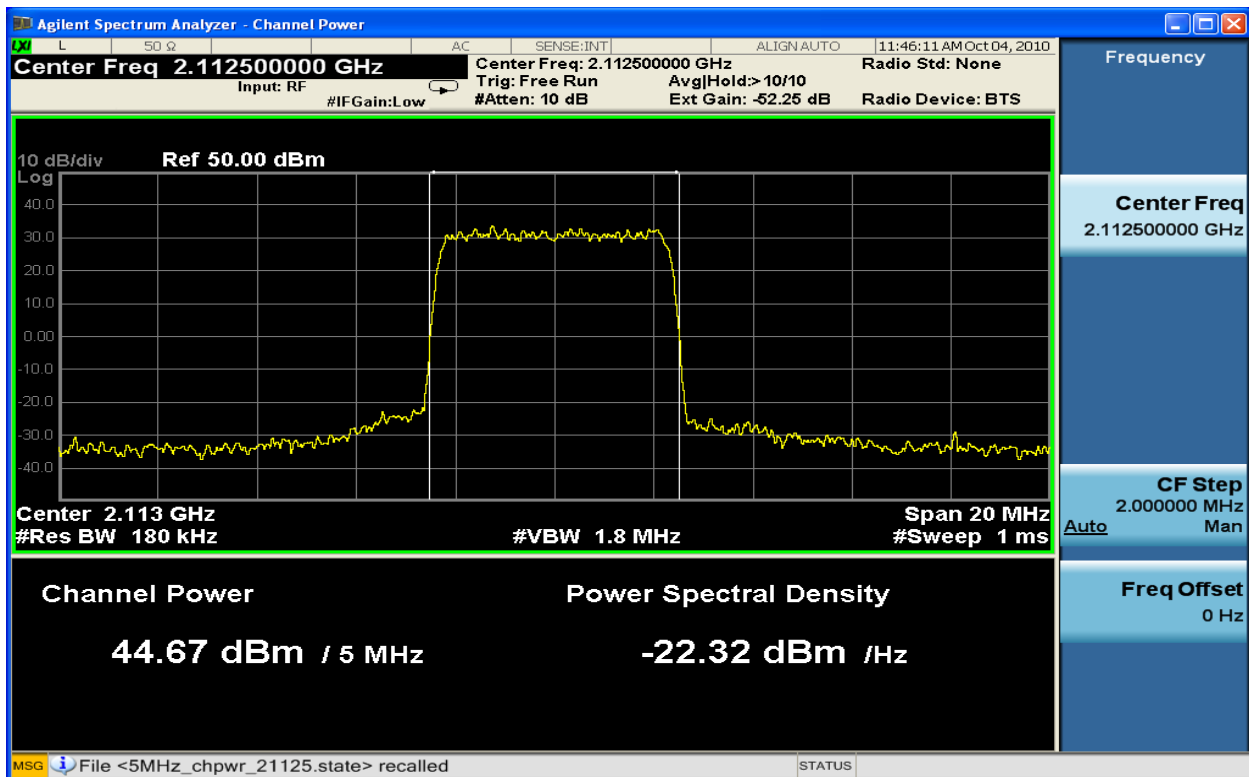

Figure 6-5: 5MHz BW Channel Power TX2_16QAM at 2112.5 MHz

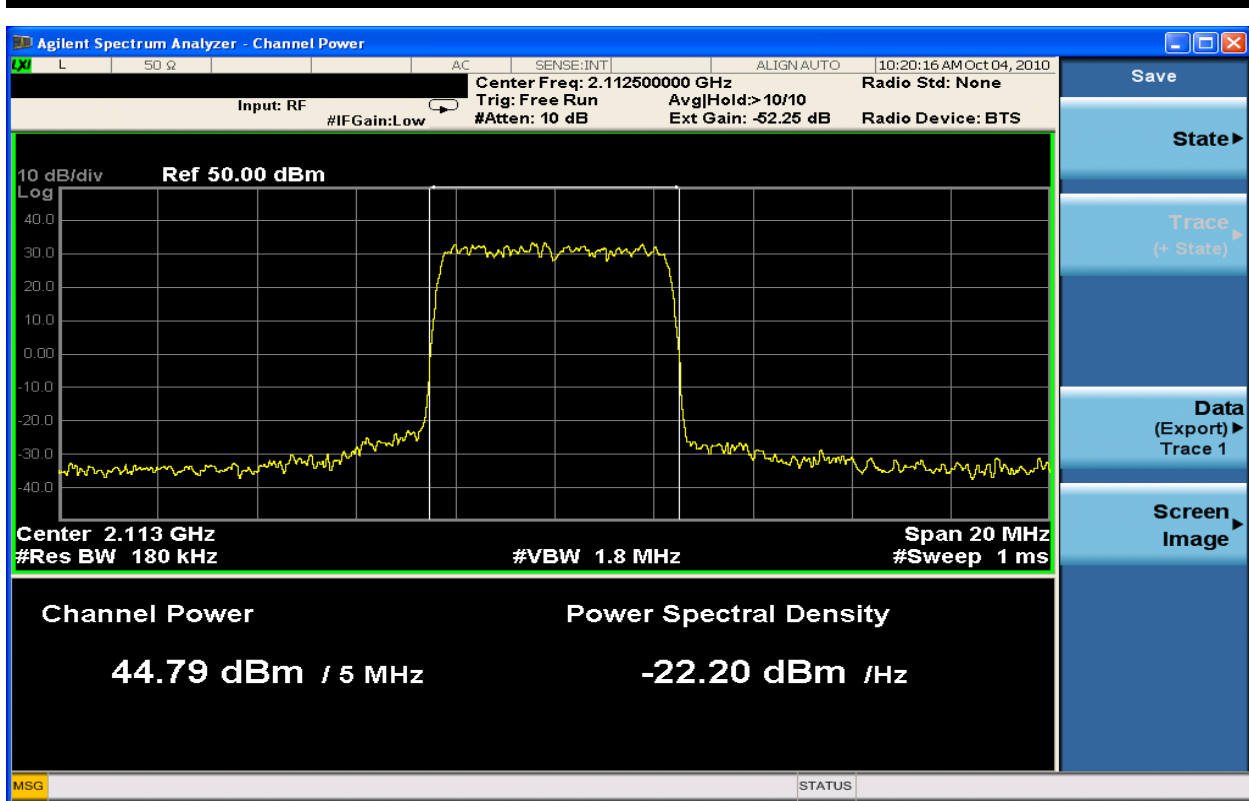

Figure 6-6: 5MHz BW Channel Power TX1_64QAM at 2112.5 MHz

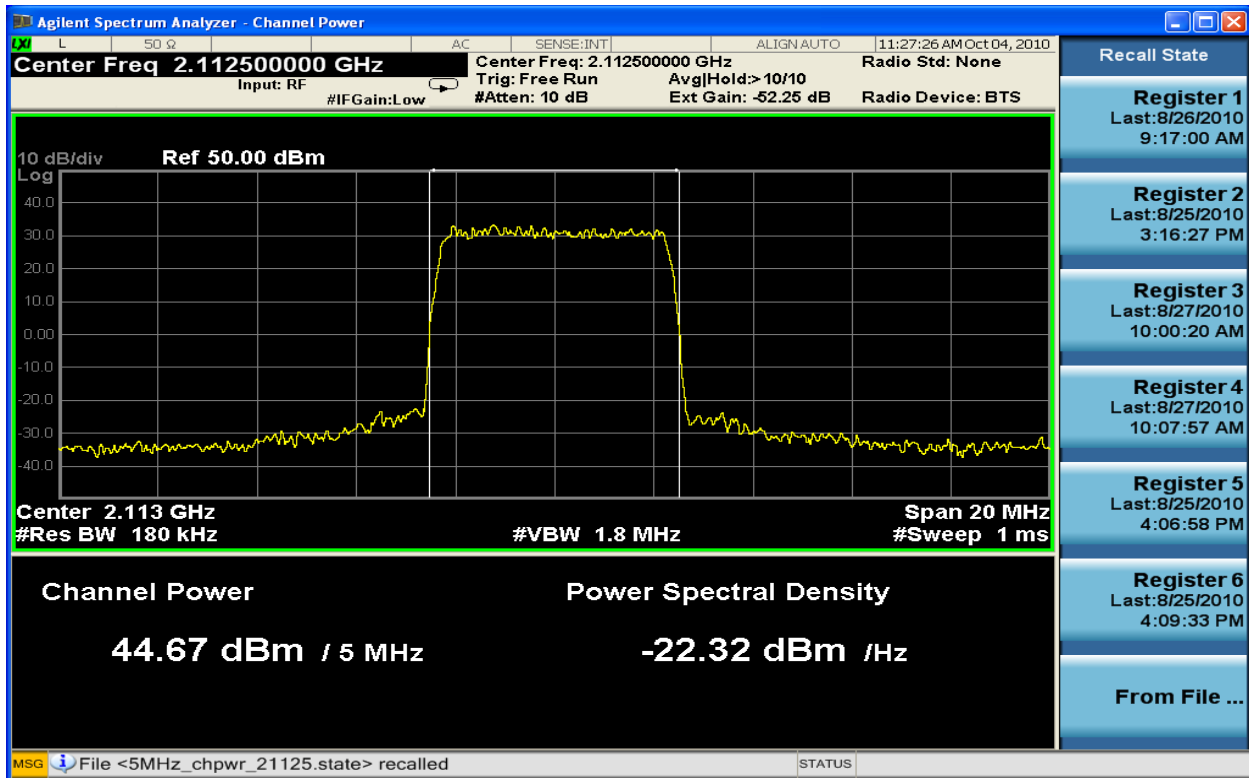

Figure 6-7: 5MHz BW Channel Power TX2_64QAM at 2112.5 MHz

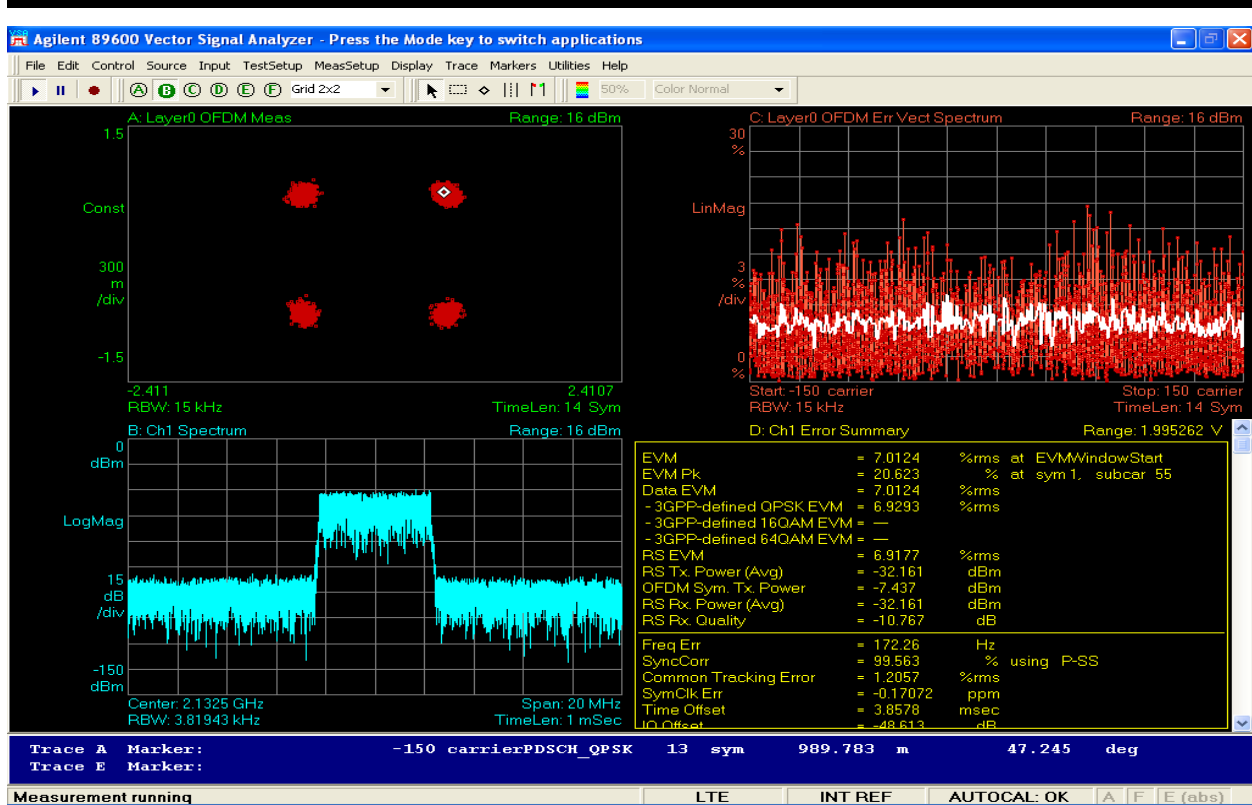

Figure 6-8: 5MHz BW Modulation TX1_QPSK at 2132.5MHz

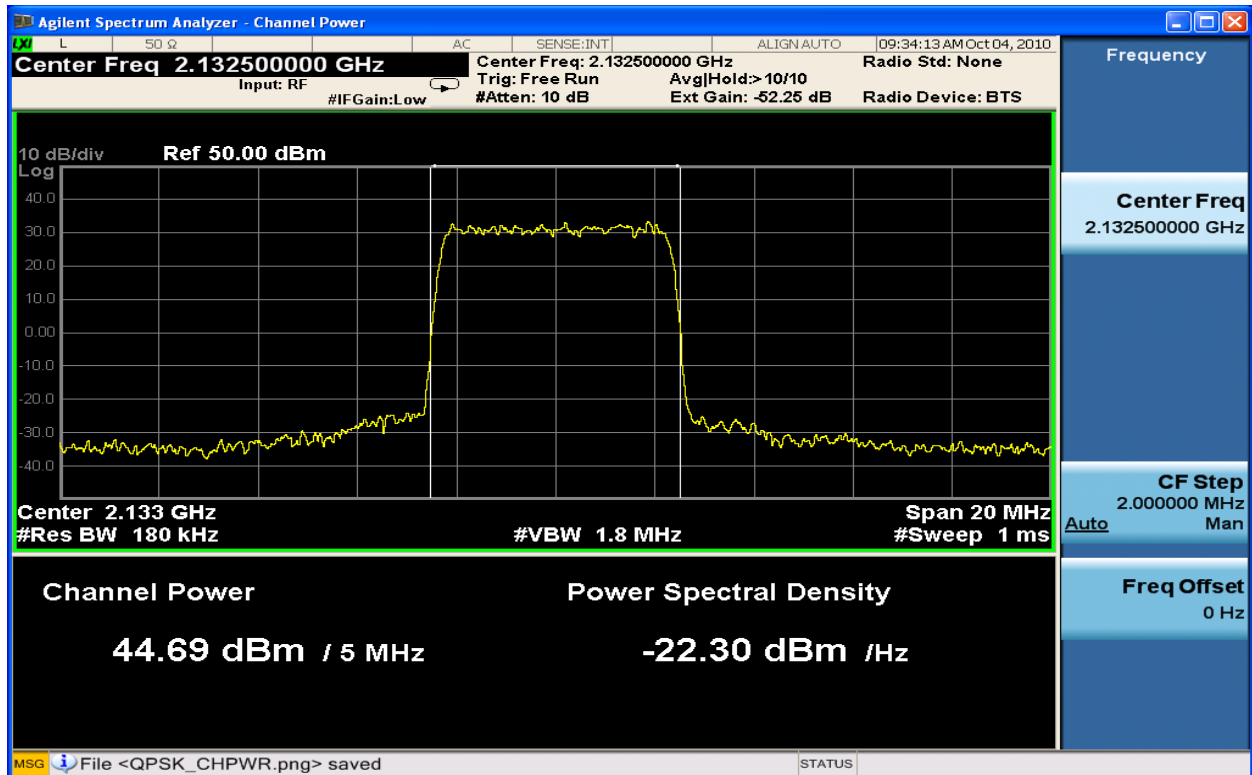

Figure 6-9 : 5MHz BW Channel Power TX1_QPSK at 2132.5 MHz

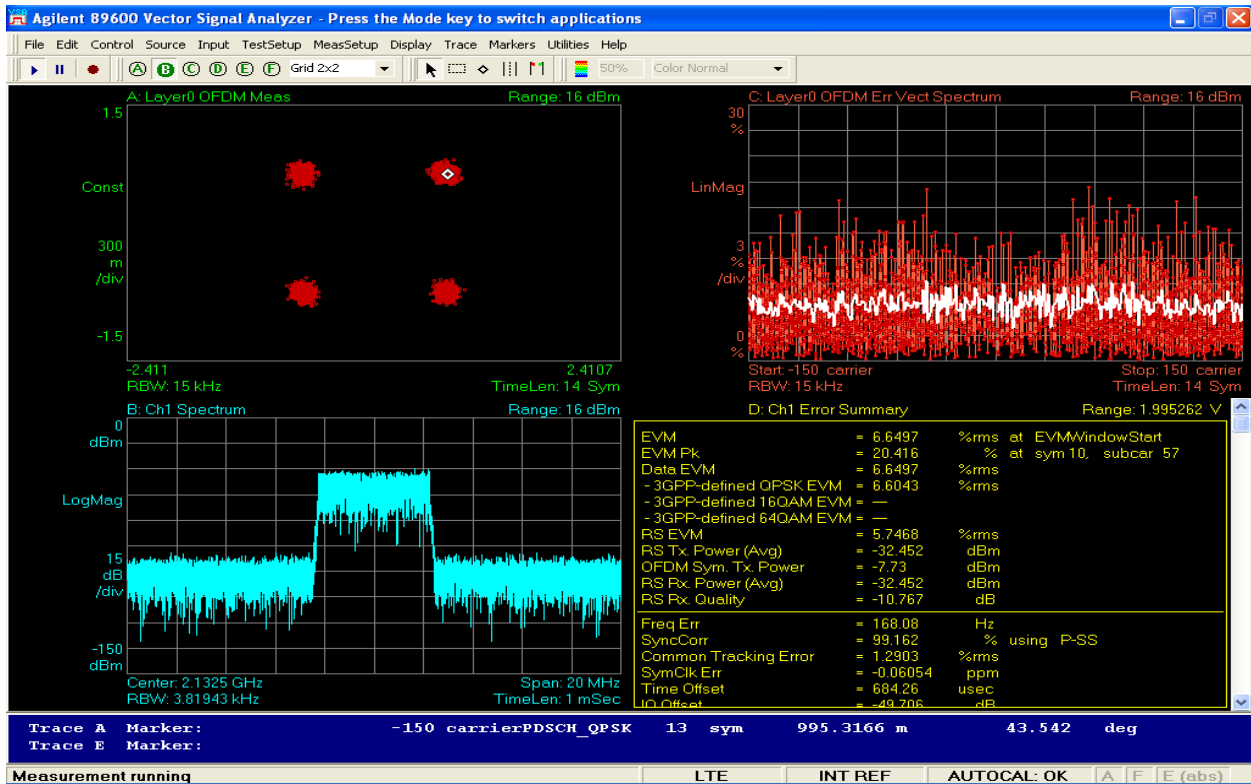

Figure 6-10: 5MHz BW Modulation TX2_QPSK at 2132.5MHz

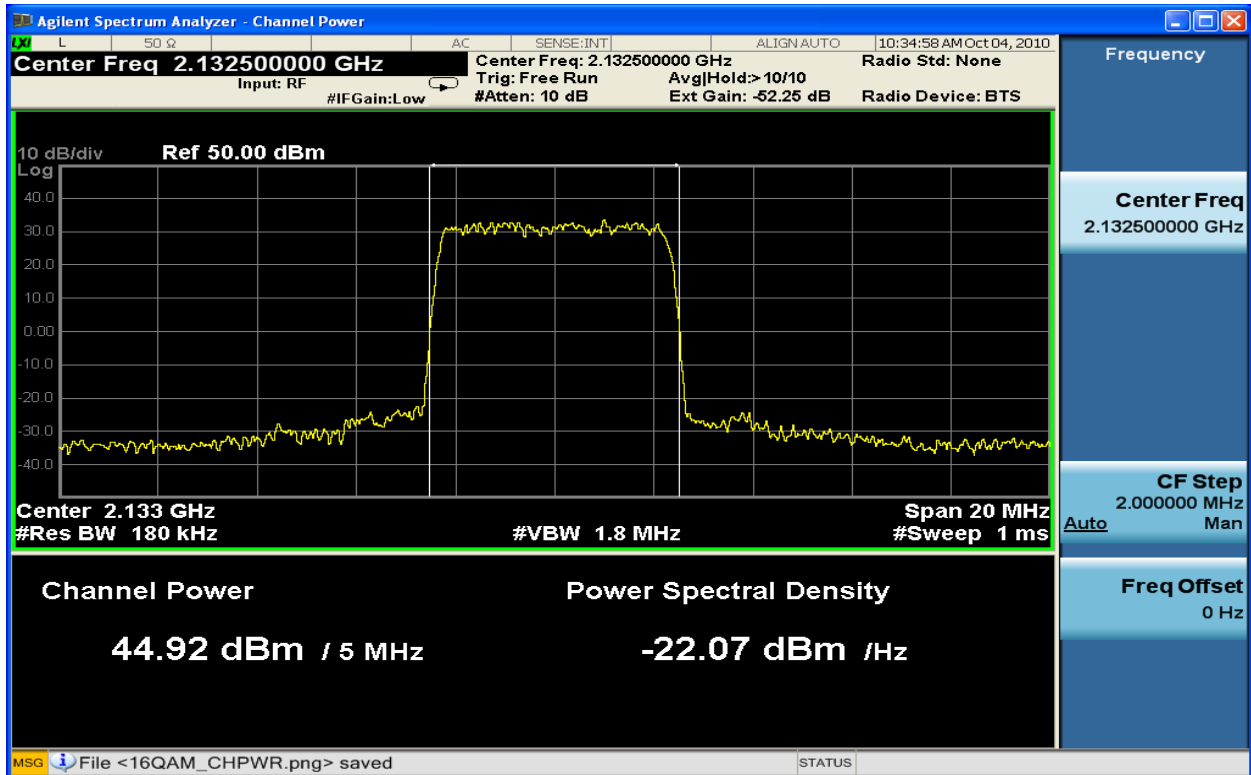

Figure 6-11 : 5MHz BW Channel Power TX2_QPSK at 2132.5 MHz

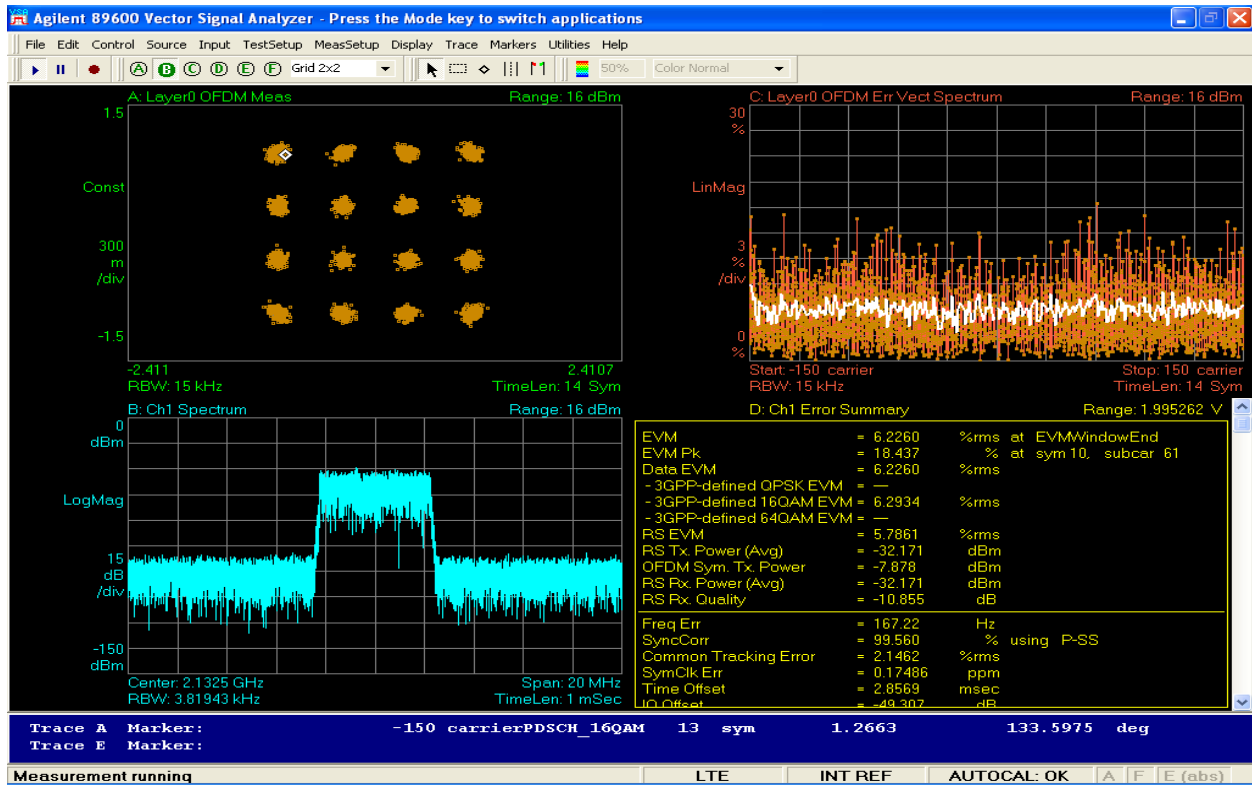

Figure 6-12: 5MHz BW Modulation TX1_16QAM at 2132.5MHz

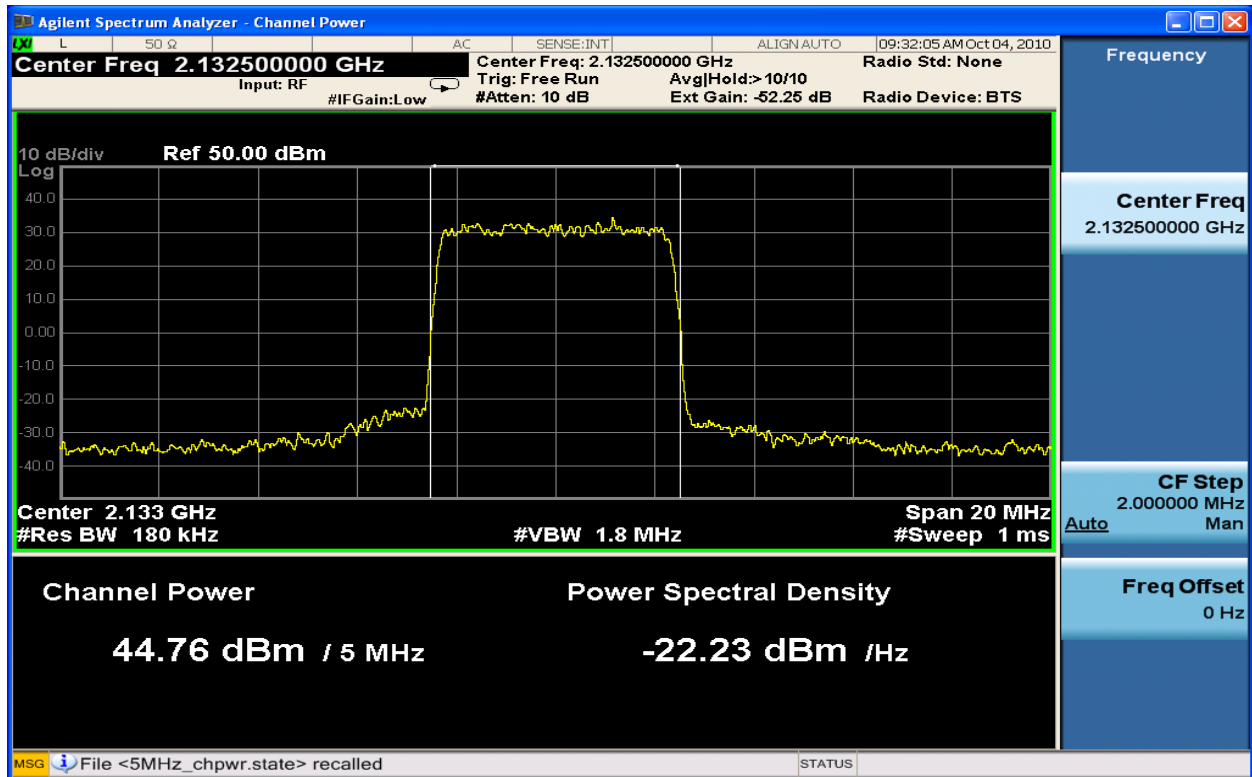

Figure 6-13 : 5MHz BW Channel Power TX1_16QAM at 2132.5 MHz

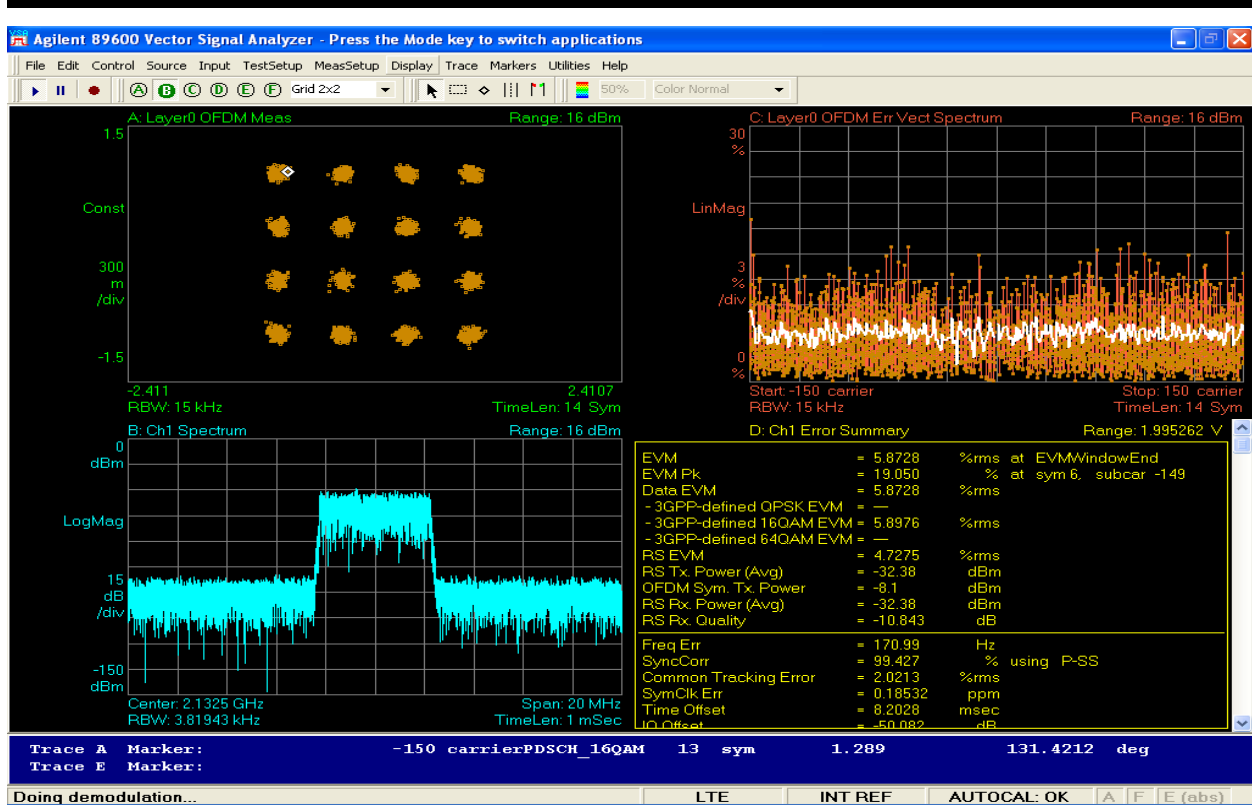

Figure 6-14: 5MHz BW Modulation TX2_16QAM at 2132.5MHz

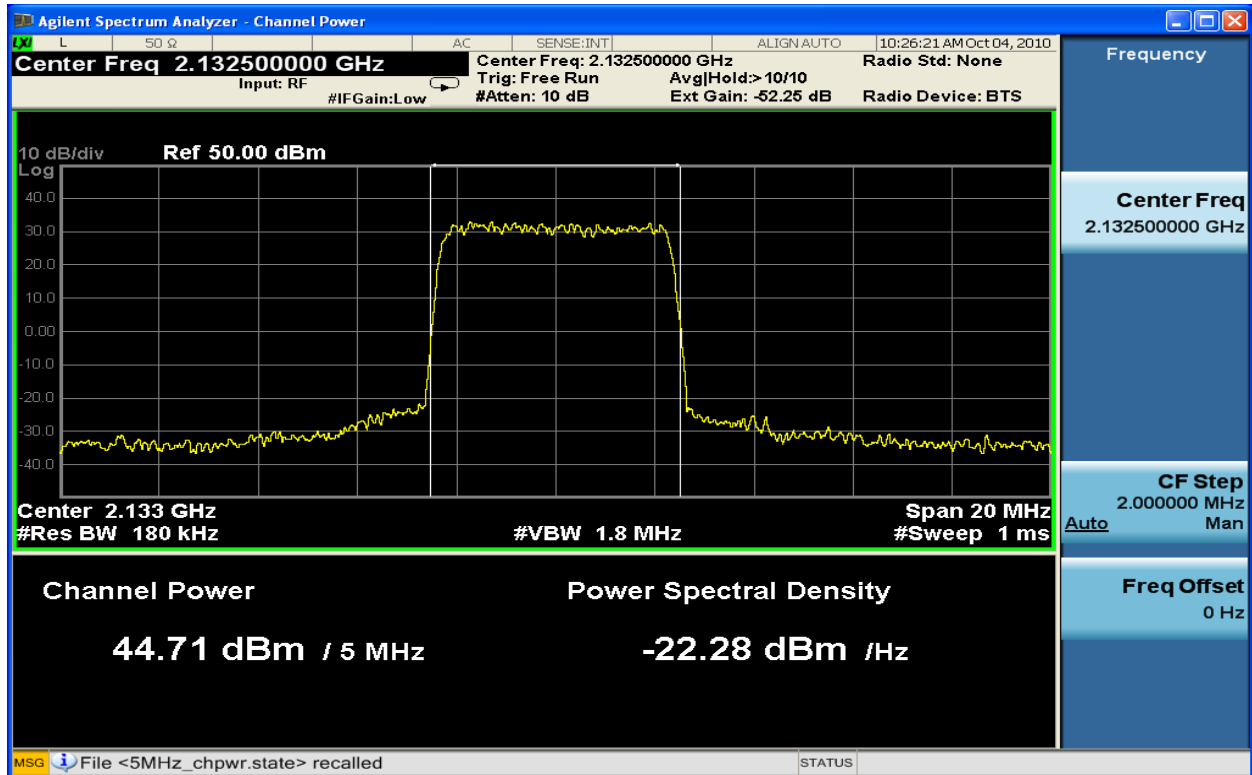

Figure 6-15 : 5MHz BW Channel Power TX2_16QAM at 2132.5 MHz

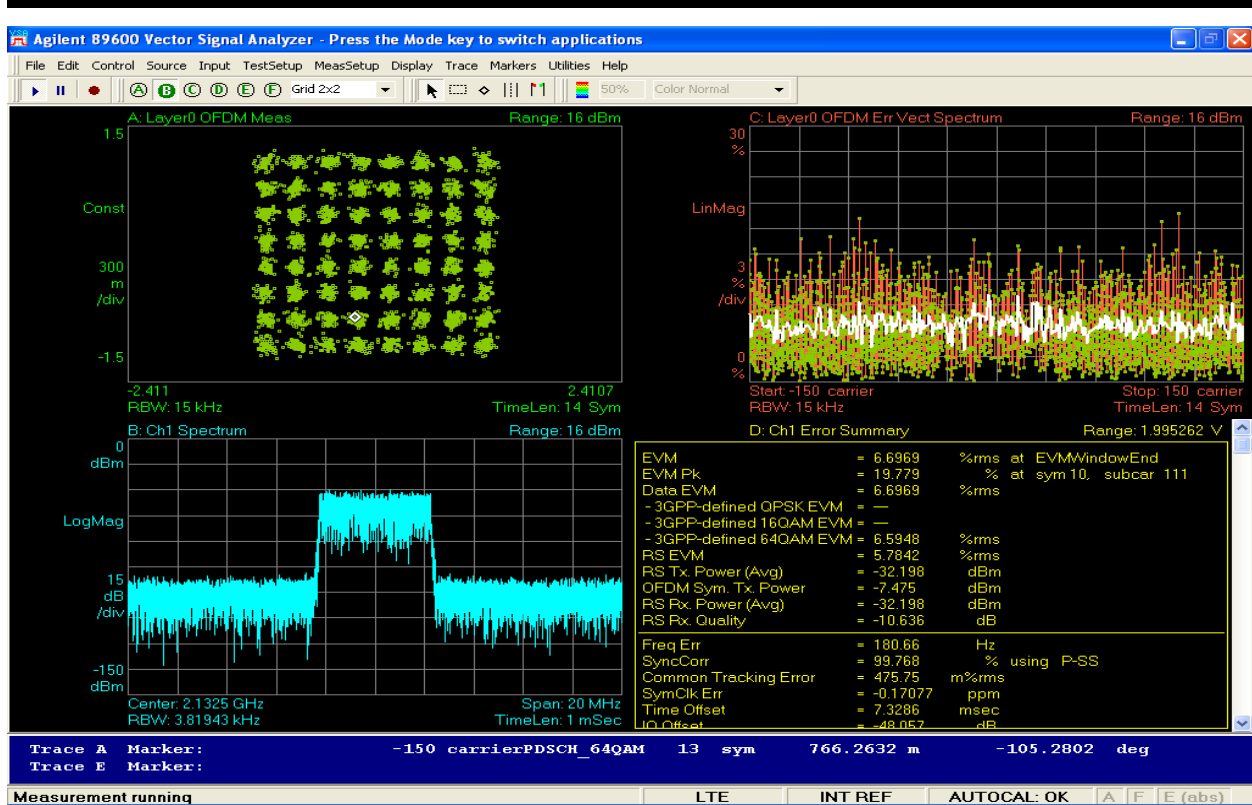

Figure 6-16: 5MHz BW Modulation TX1_64QAM at 2132.5MHz

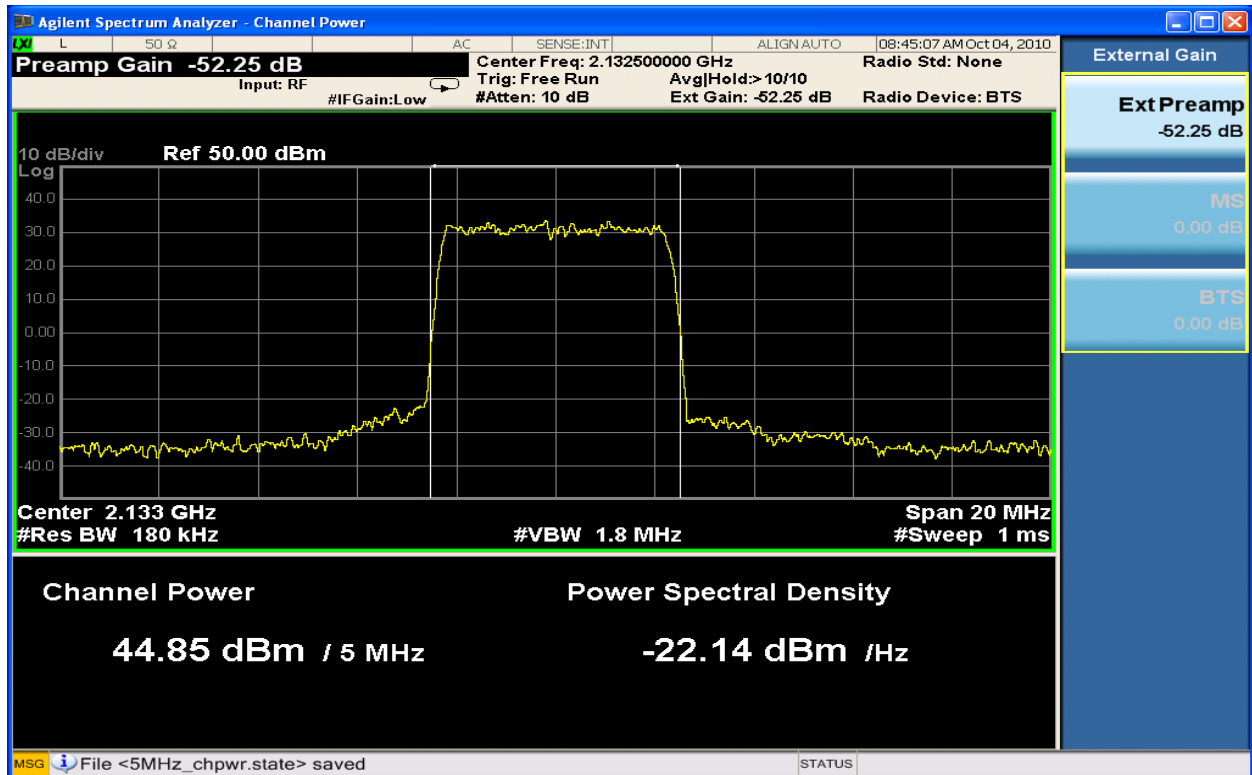

Figure 6-17 : 5MHz BW Channel Power TX1_64QAM at 2132.5 MHz

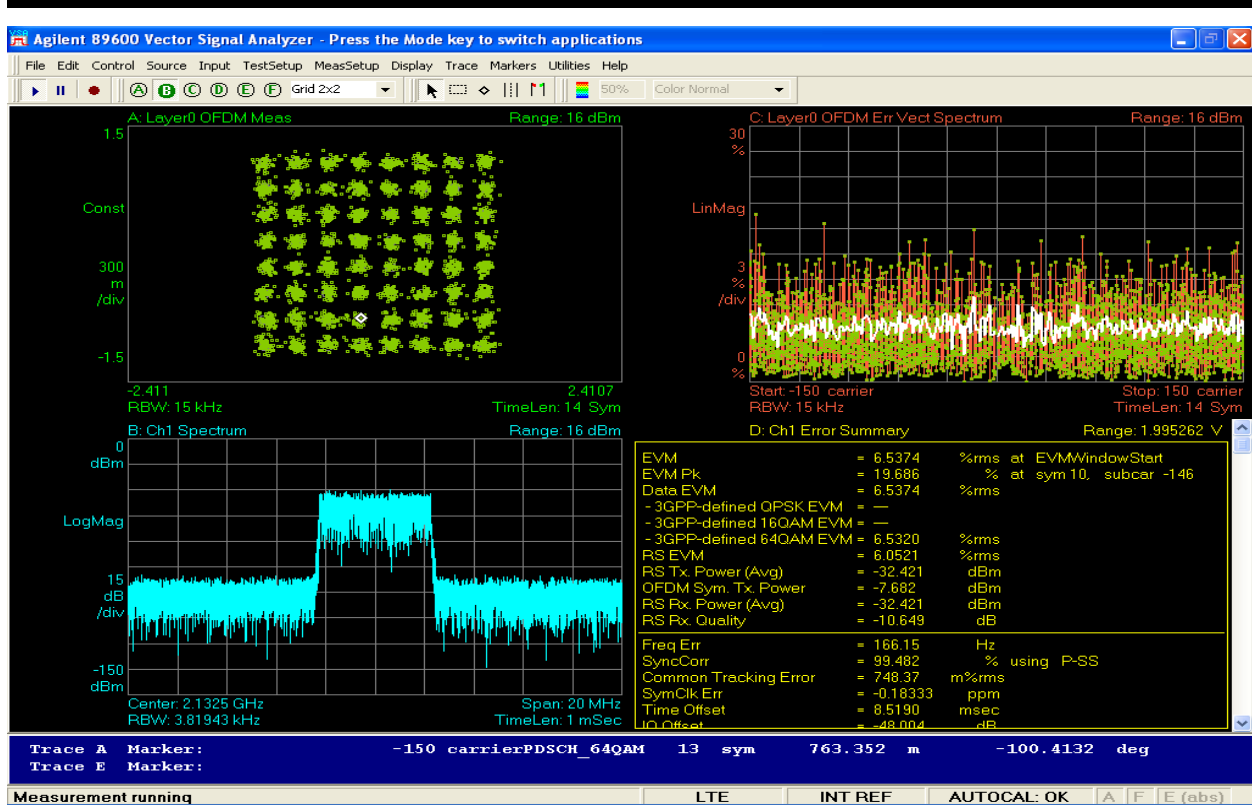

Figure 6-18: 5MHz BW Modulation TX2_64QAM at 2132.5MHz

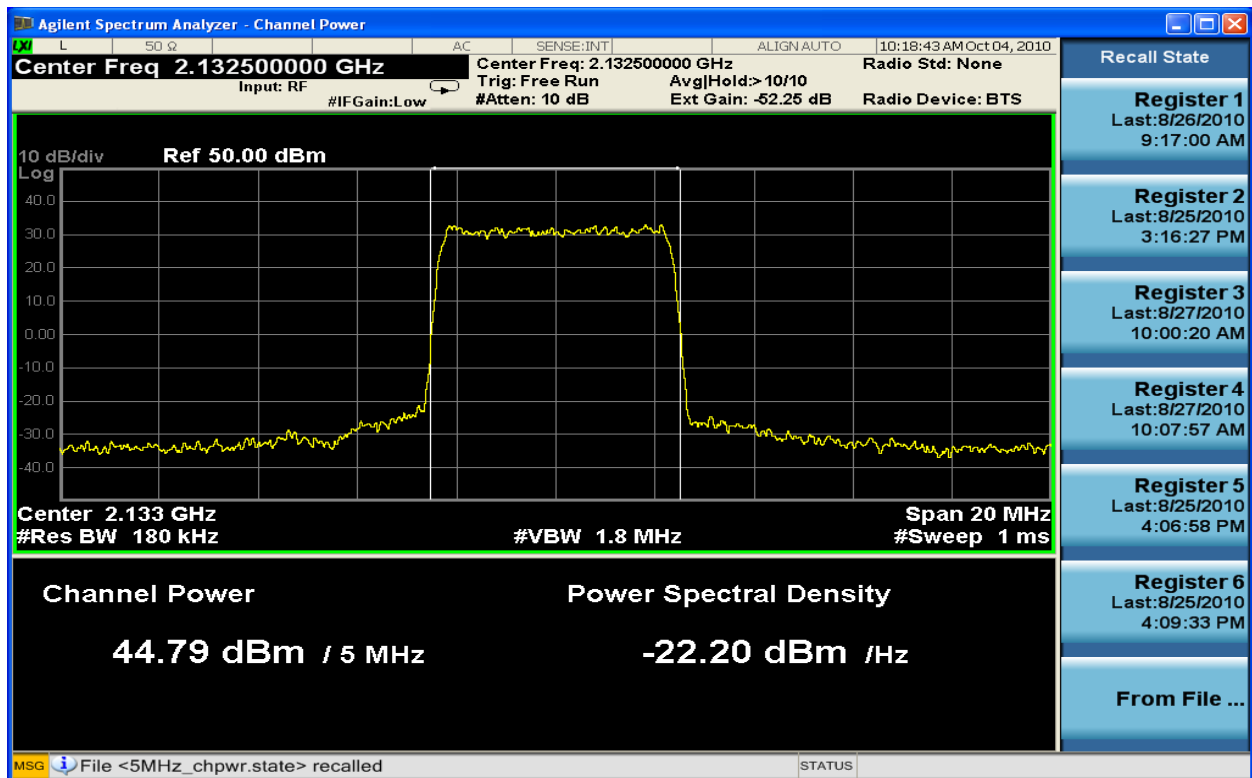

Figure 6-19 : 5MHz BW Channel Power TX2_64QAM at 2132.5 MHz

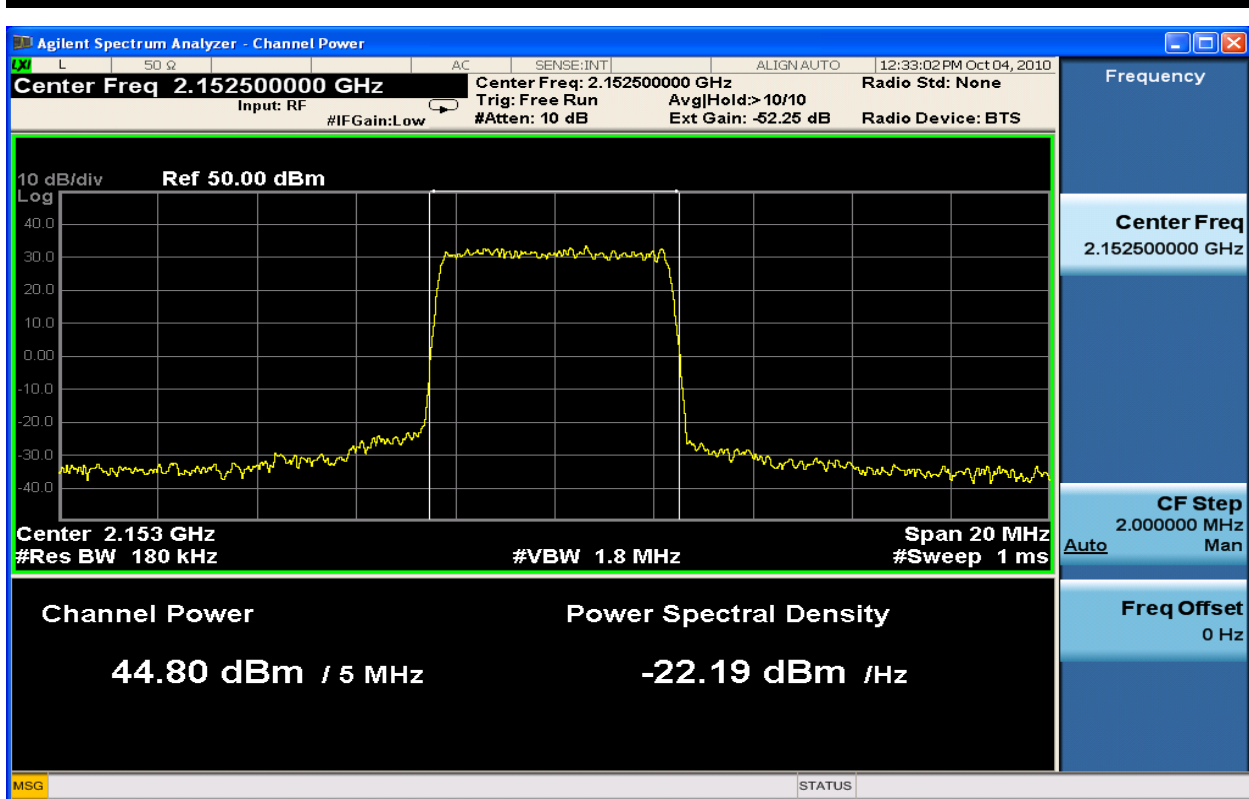

Figure 6-20 : 5MHz BW Channel Power TX1_QPSK at 2152.5 MHz

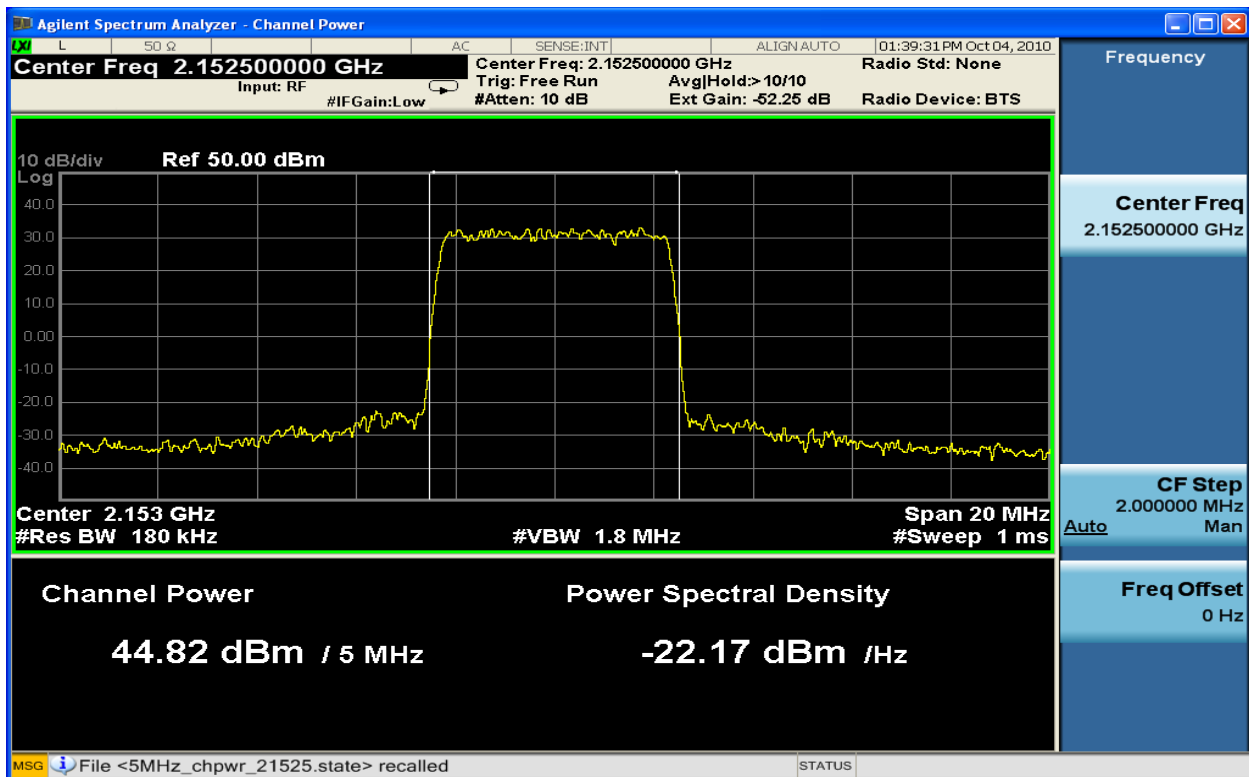

Figure 6-21 : 5MHz BW Channel Power TX2_QPSK at 2152.5 MHz

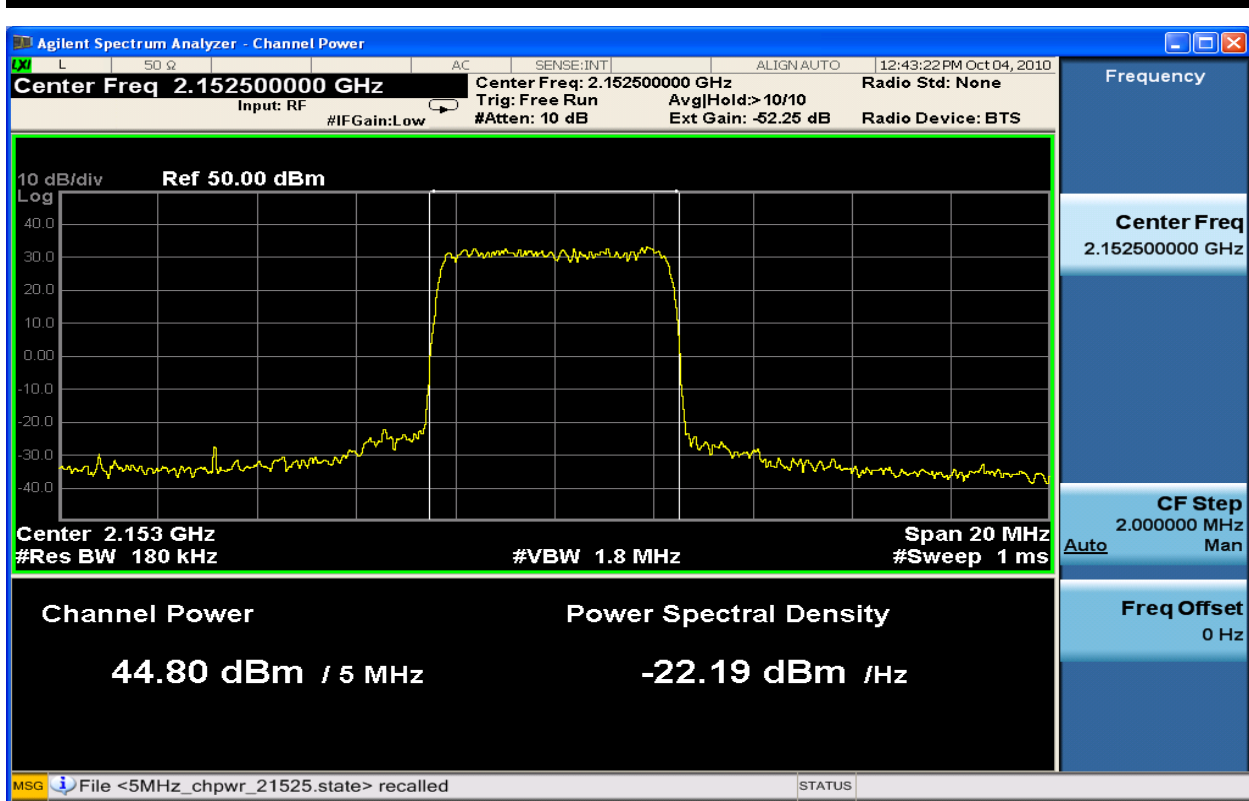

Figure 6-22 : 5MHz BW Channel Power TX1_16QAM at 2152.5 MHz

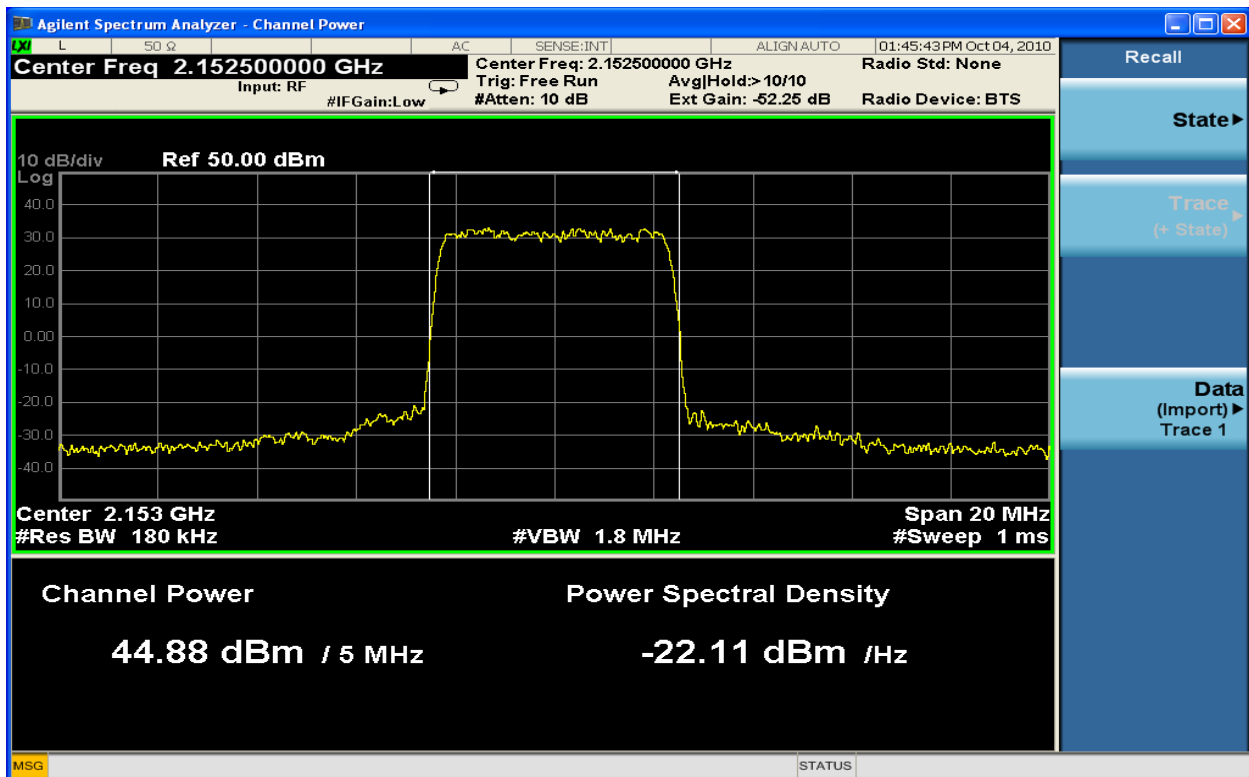

Figure 6-23 : 5MHz BW Channel Power TX2_16QAM at 2152.5 MHz

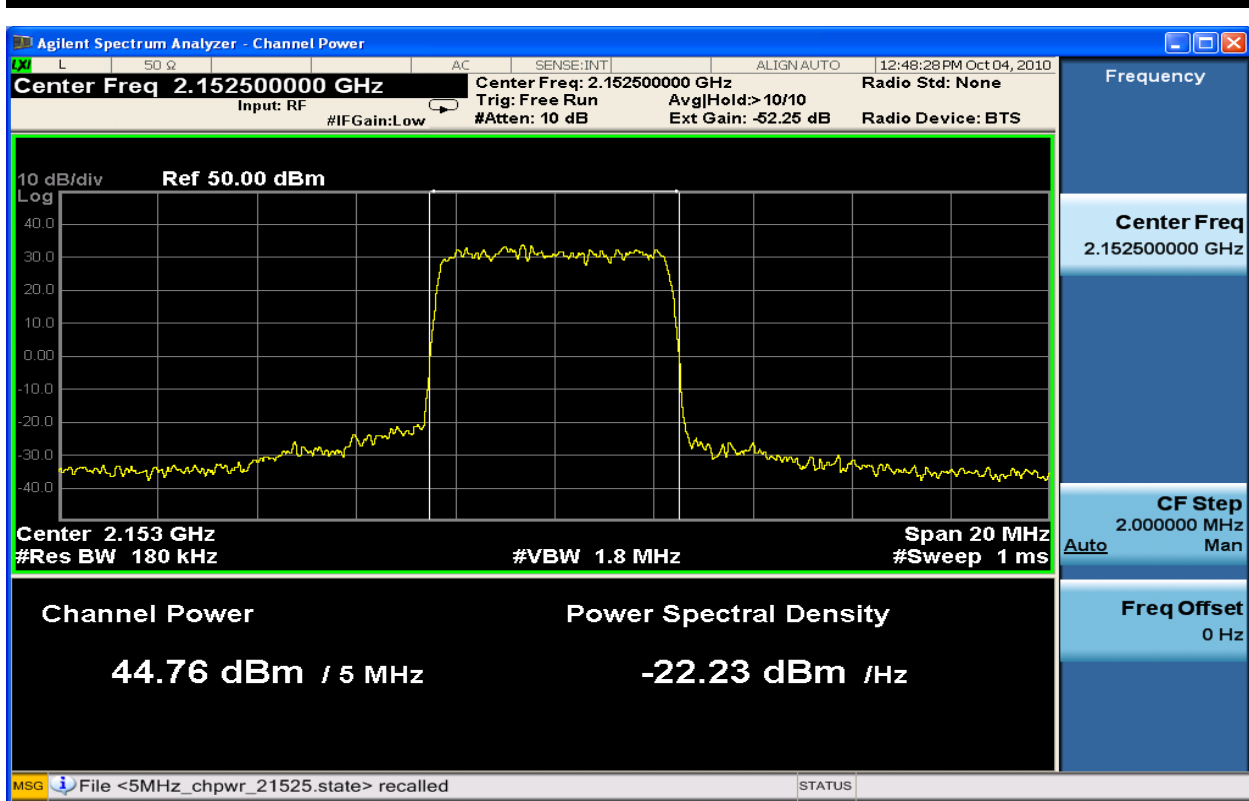

Figure 6-24 : 5MHz BW Channel Power TX1_64QAM at 2152.5 MHz

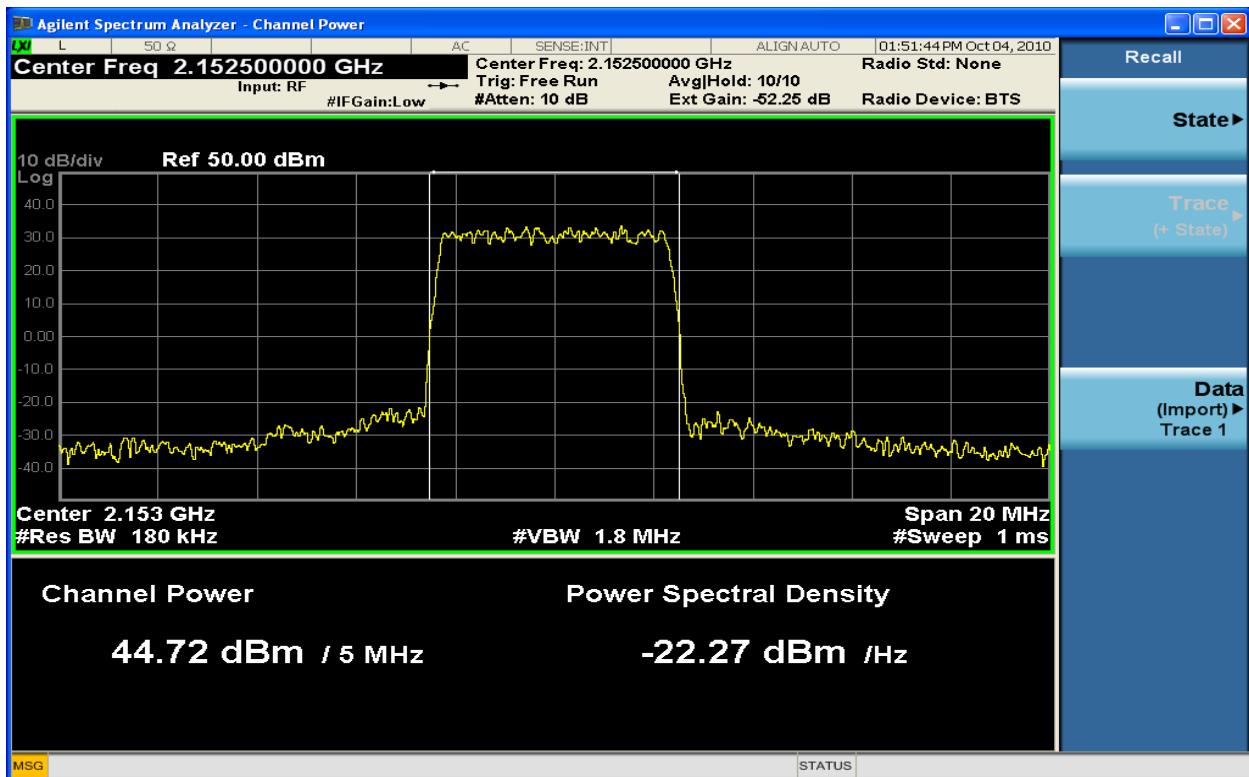

Figure 6-25 : 5MHz BW Channel Power TX2_64QAM at 2152.5 MHz

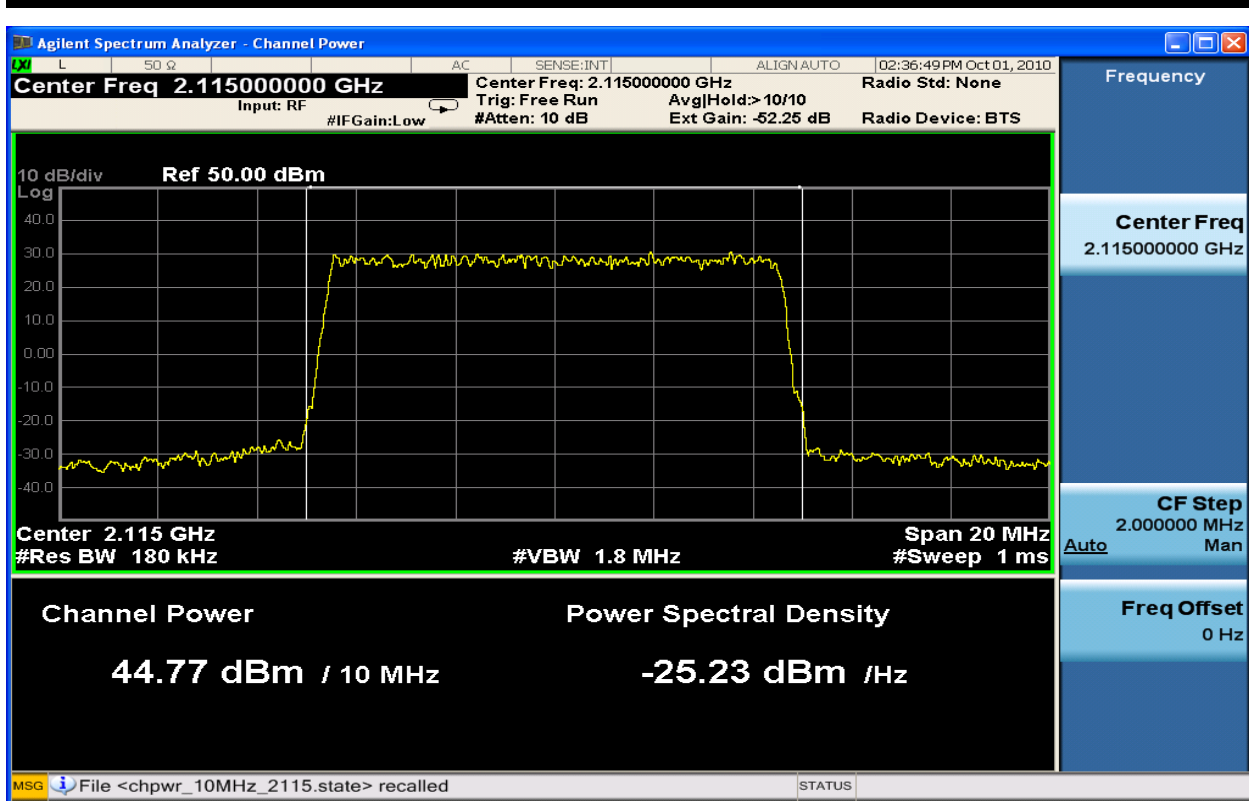

Figure 6-26 : 10MHz BW Channel Power TX1_QPSK at 2115.0 MHz

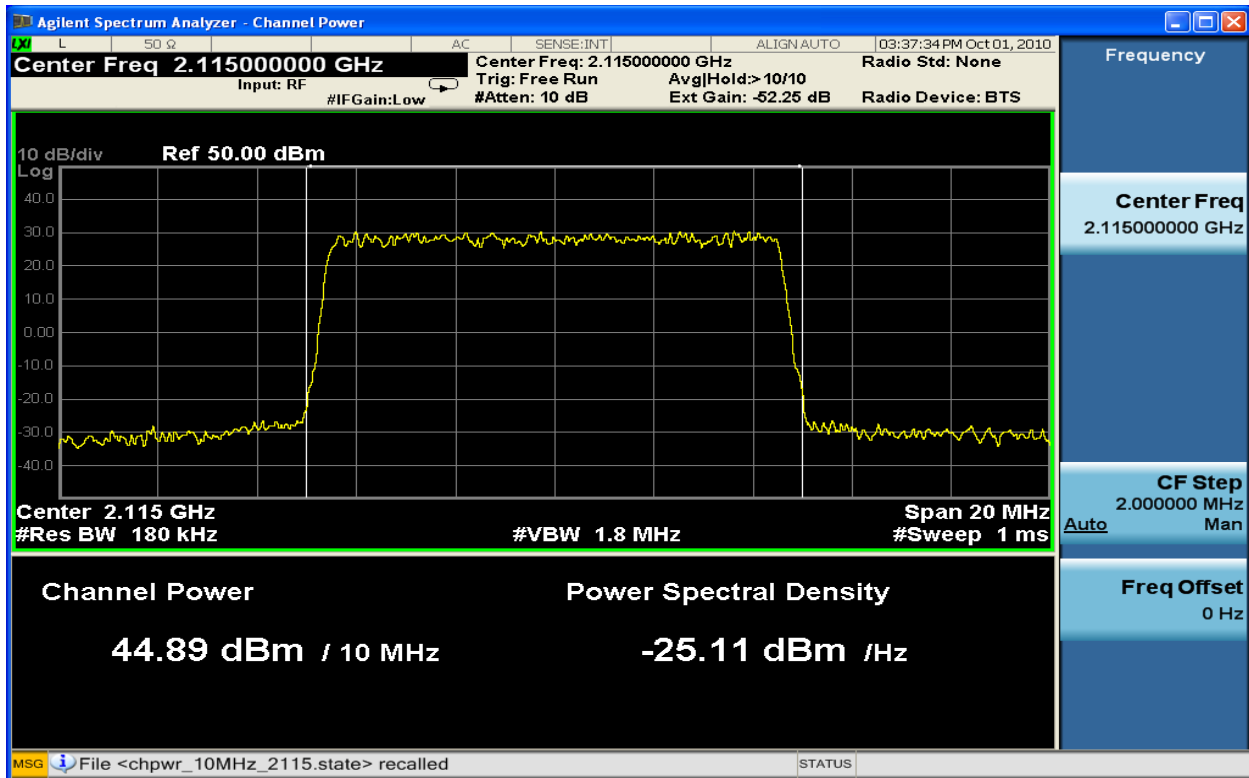

Figure 6-27 : 10MHz BW Channel Power TX2_QPSK at 2115.0 MHz

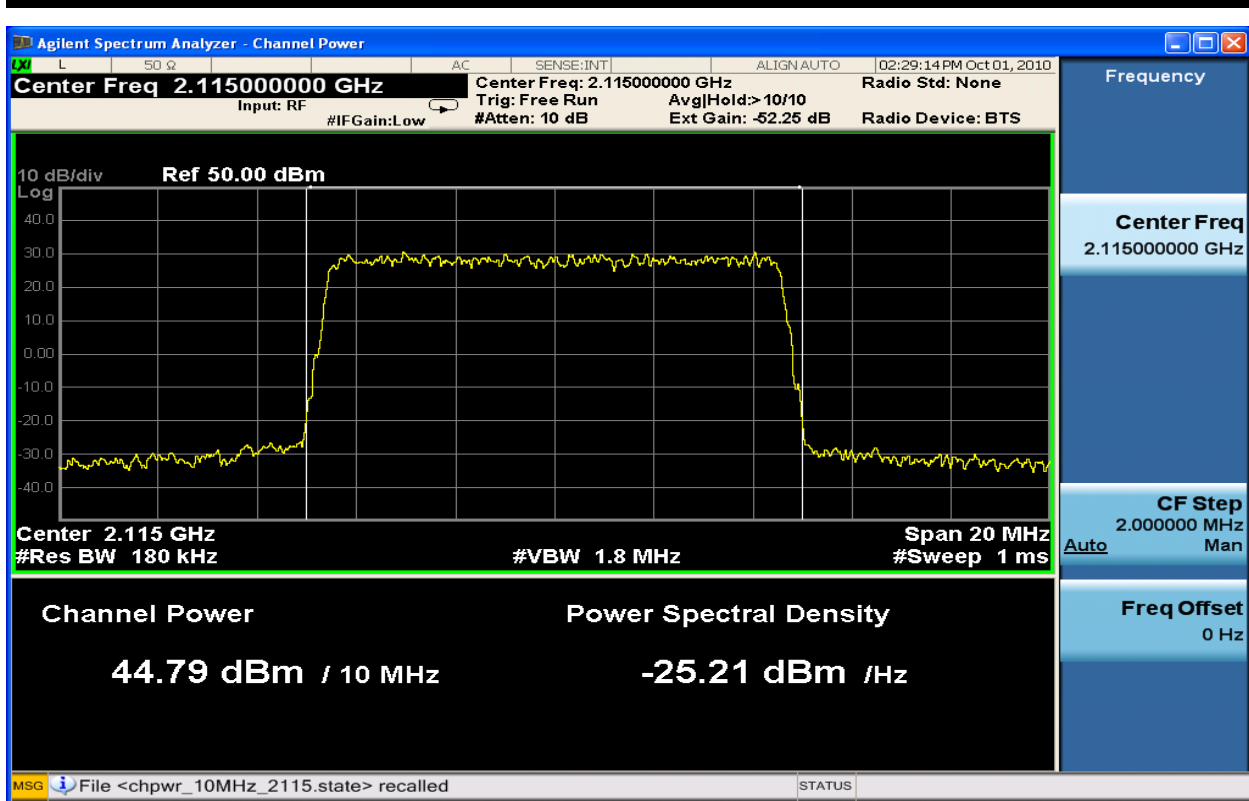

Figure 6-28 : 10MHz BW Channel Power TX1_16QAM at 2115.0 MHz

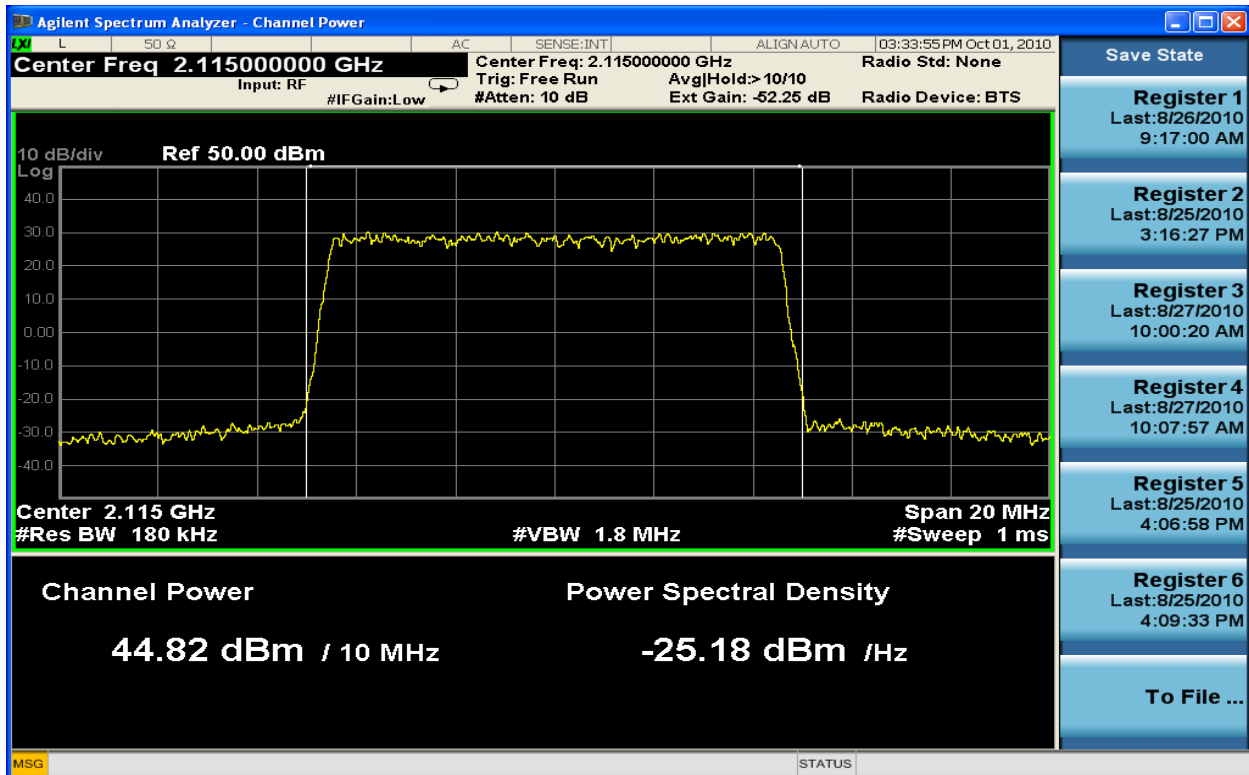

Figure 6-29 : 10MHz BW Channel Power TX2_16QAM at 2115.0 MHz

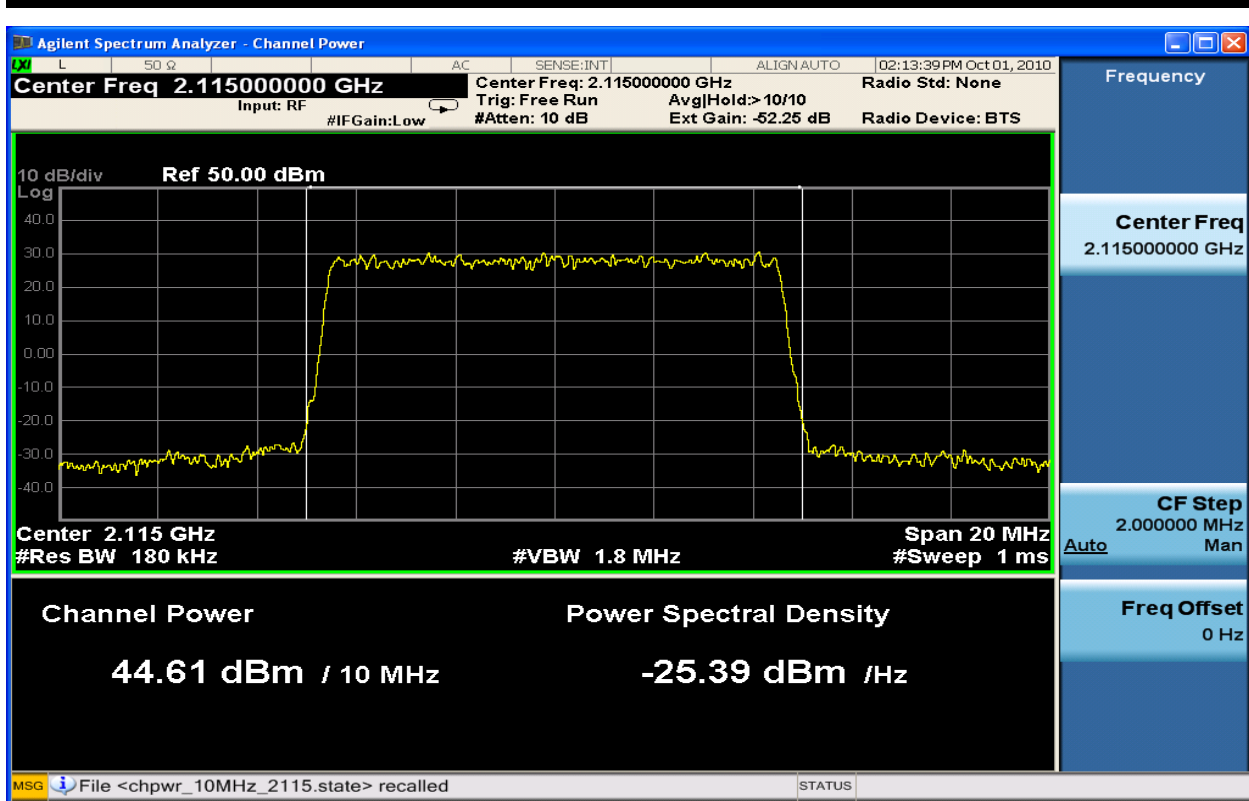

Figure 6-30 : 10MHz BW Channel Power TX1_64QAM at 2115.0 MHz

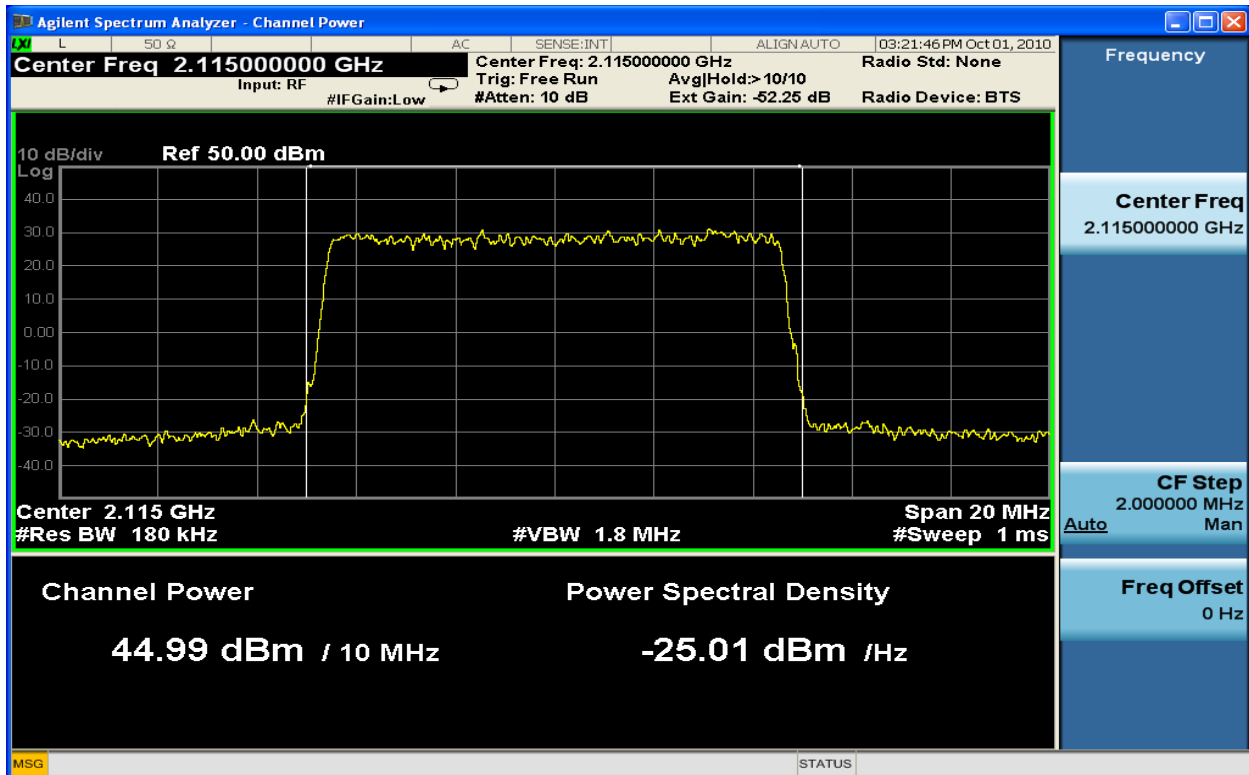

Figure 6-31 : 10MHz BW Channel Power TX2_64QAM at 2115.0 MHz

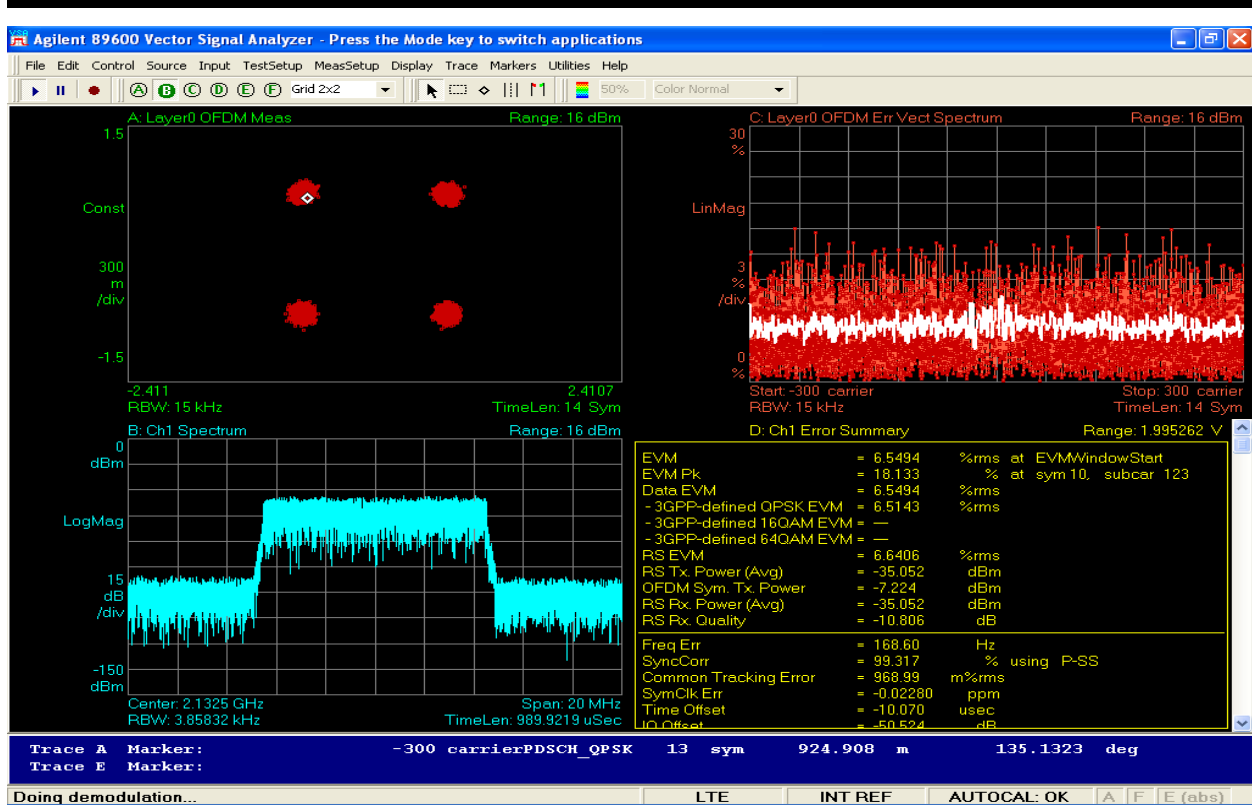

Figure 6-32 : 10MHz BW Modulation TX1_QPSK at 2132.5 MHz

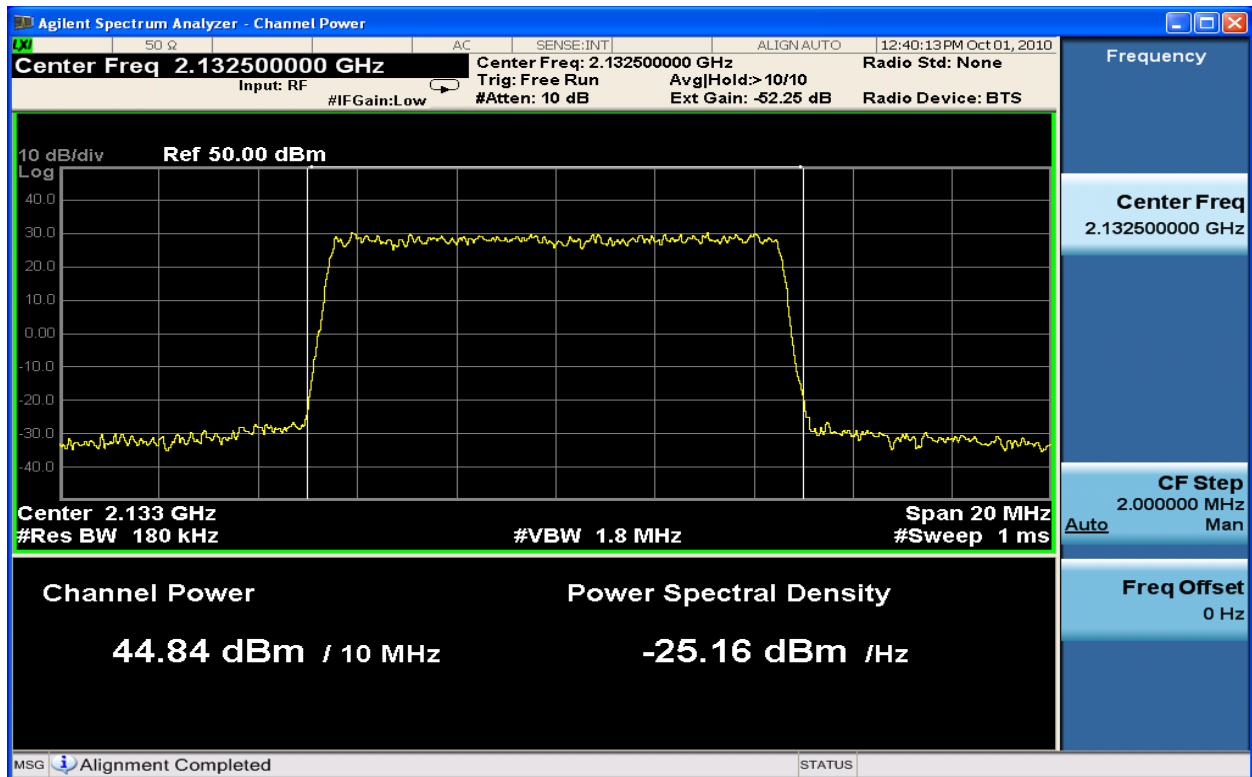

Figure 6-33 : 10MHz BW Channel Power TX1_QPSK at 2132.5 MHz

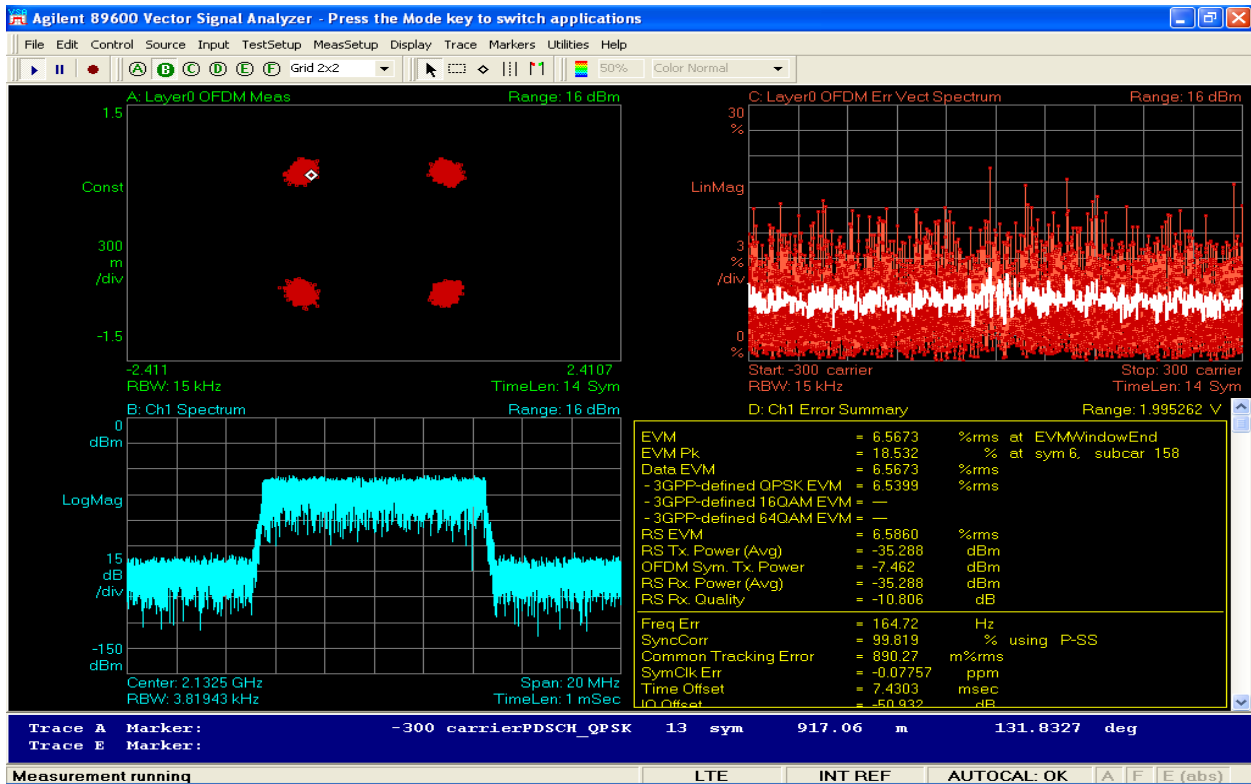

Figure 6-34 : 10MHz BW Modulation TX2_QPSK at 2132.5MHz

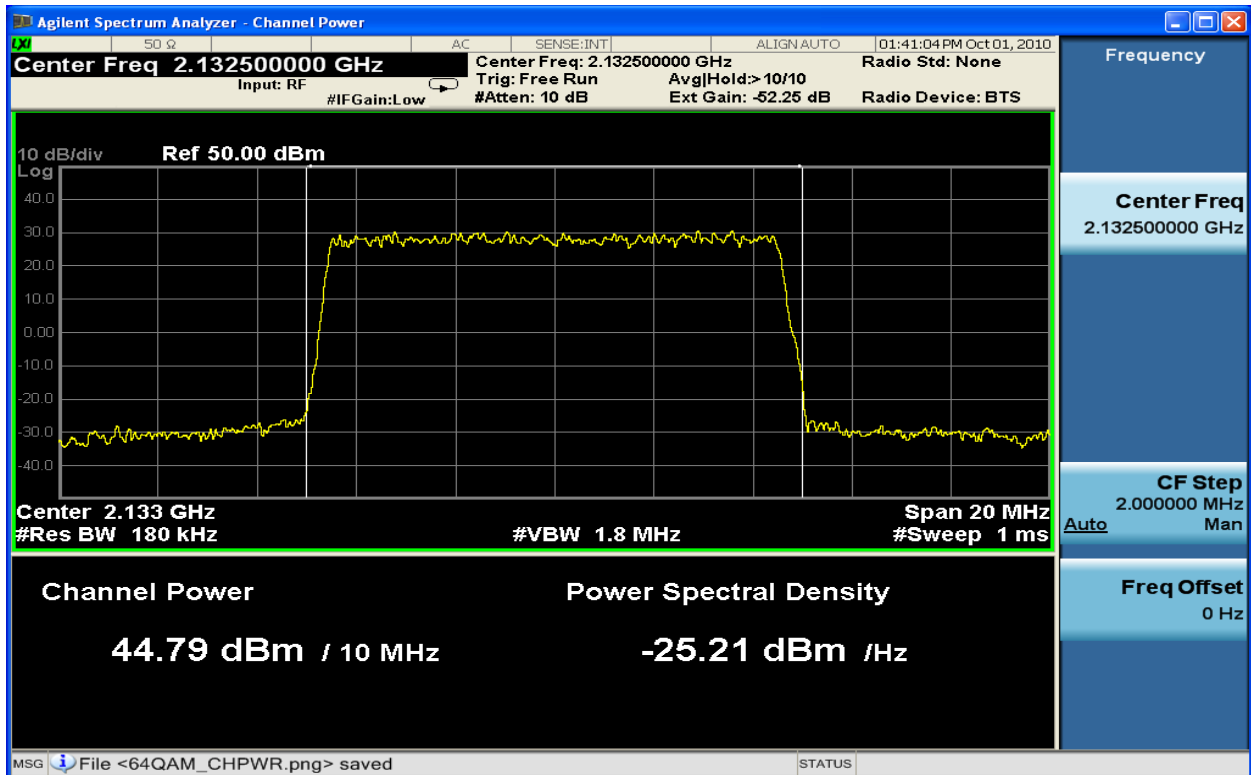

Figure 6-35 : 10MHz BW Channel Power TX2_QPSK at 2132.5 MHz

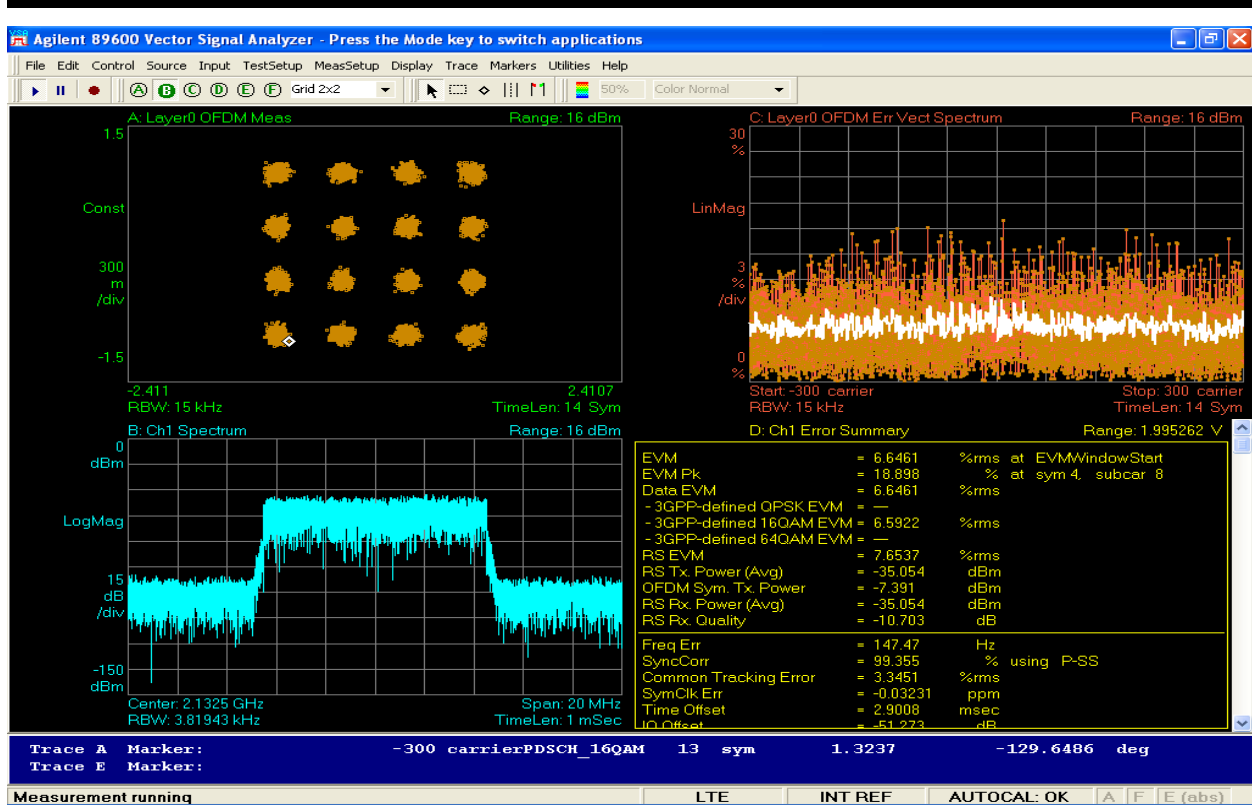

Figure 6-36 : 10MHz BW Modulation TX1_16QAM at 2132.5 MHz

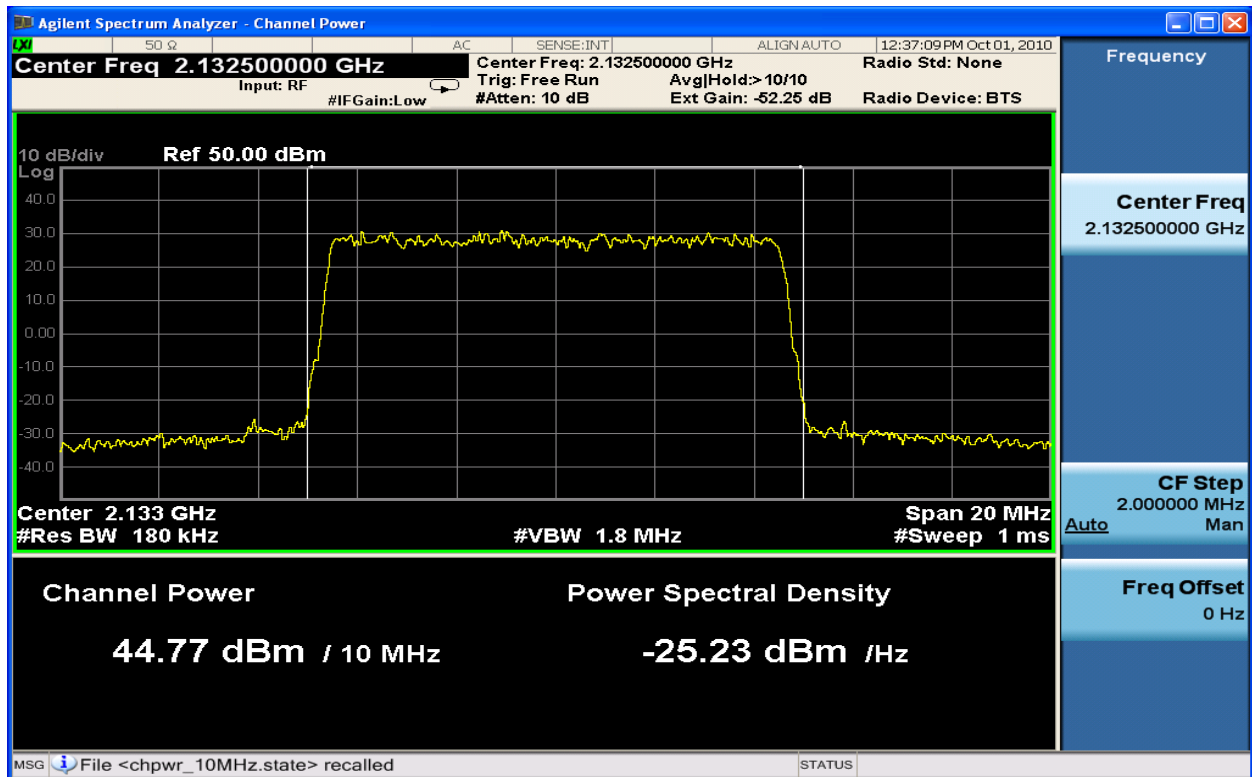

Figure 6-37 : 10MHz BW Channel Power TX1_16QAM at 2132.5 MHz

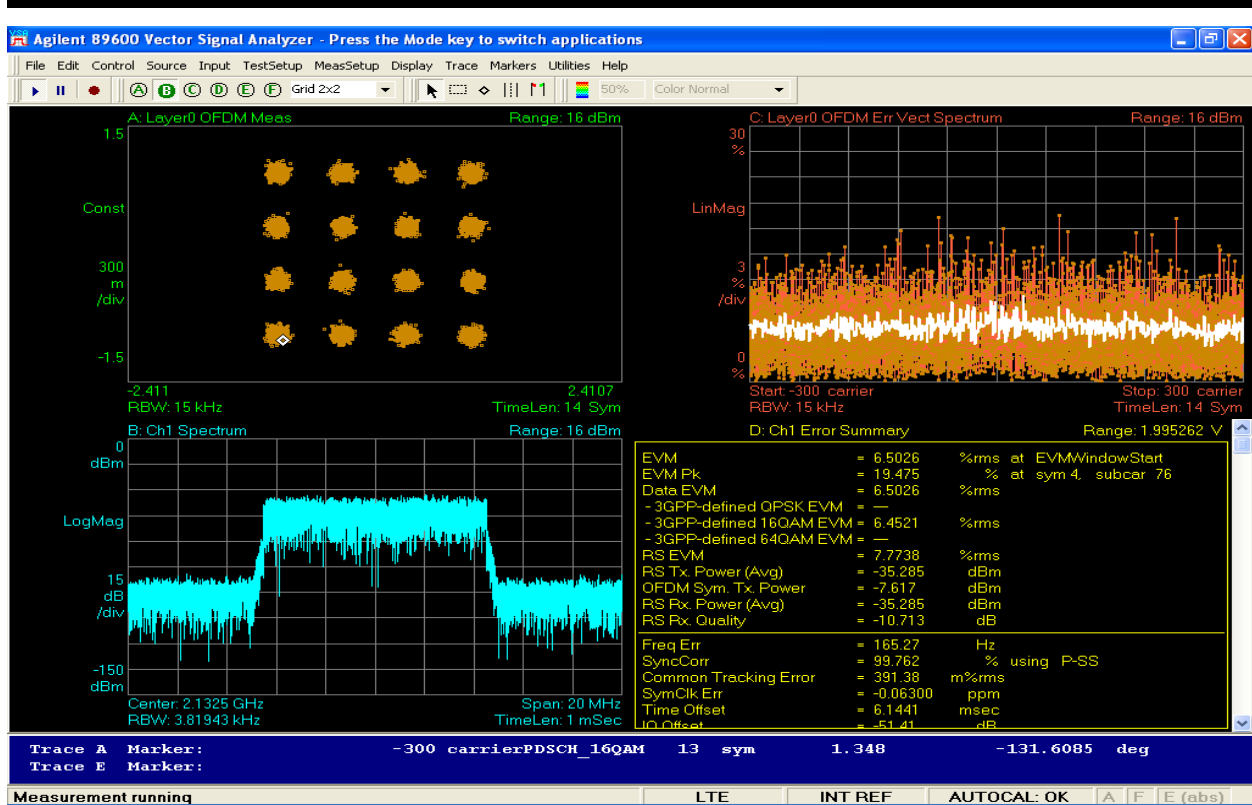

Figure 6-38 : 10MHz BW Modulation TX2_16QAM at 2132.5MHz

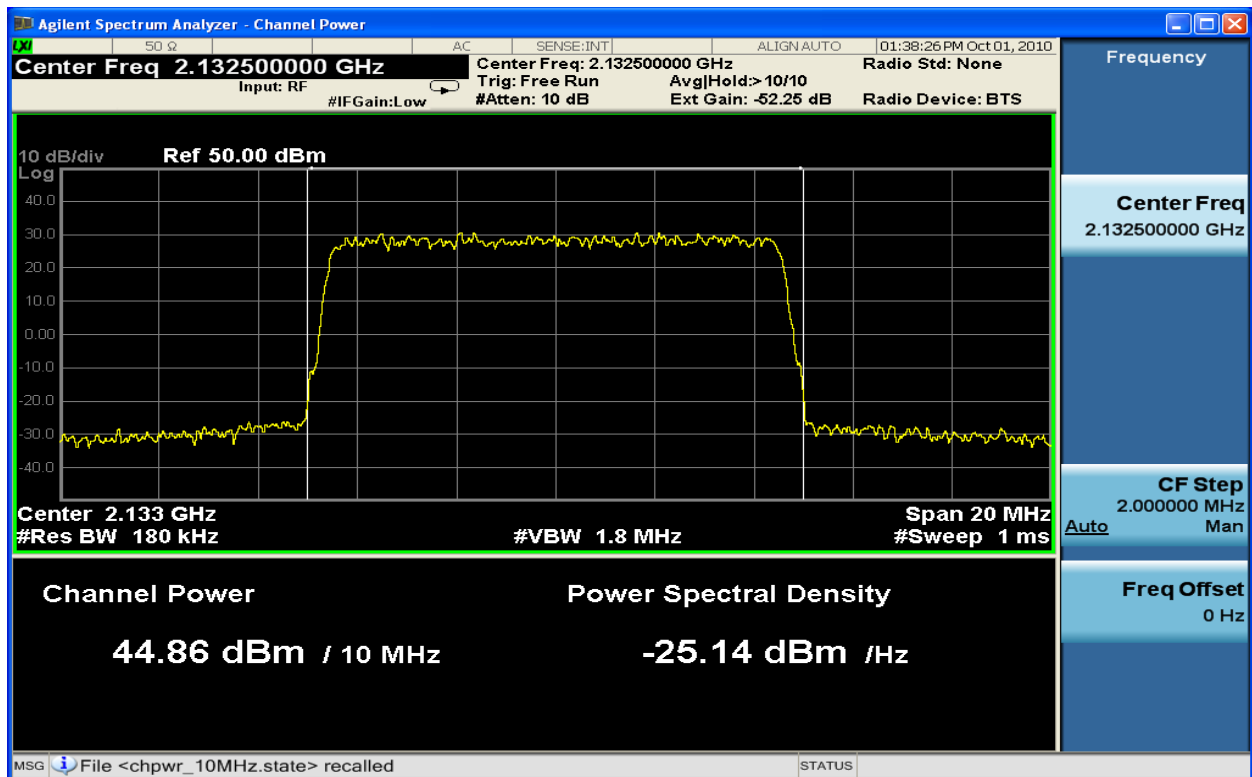

Figure 6-39 : 10MHz BW Channel Power TX2_16QAM at 2132.5 MHz

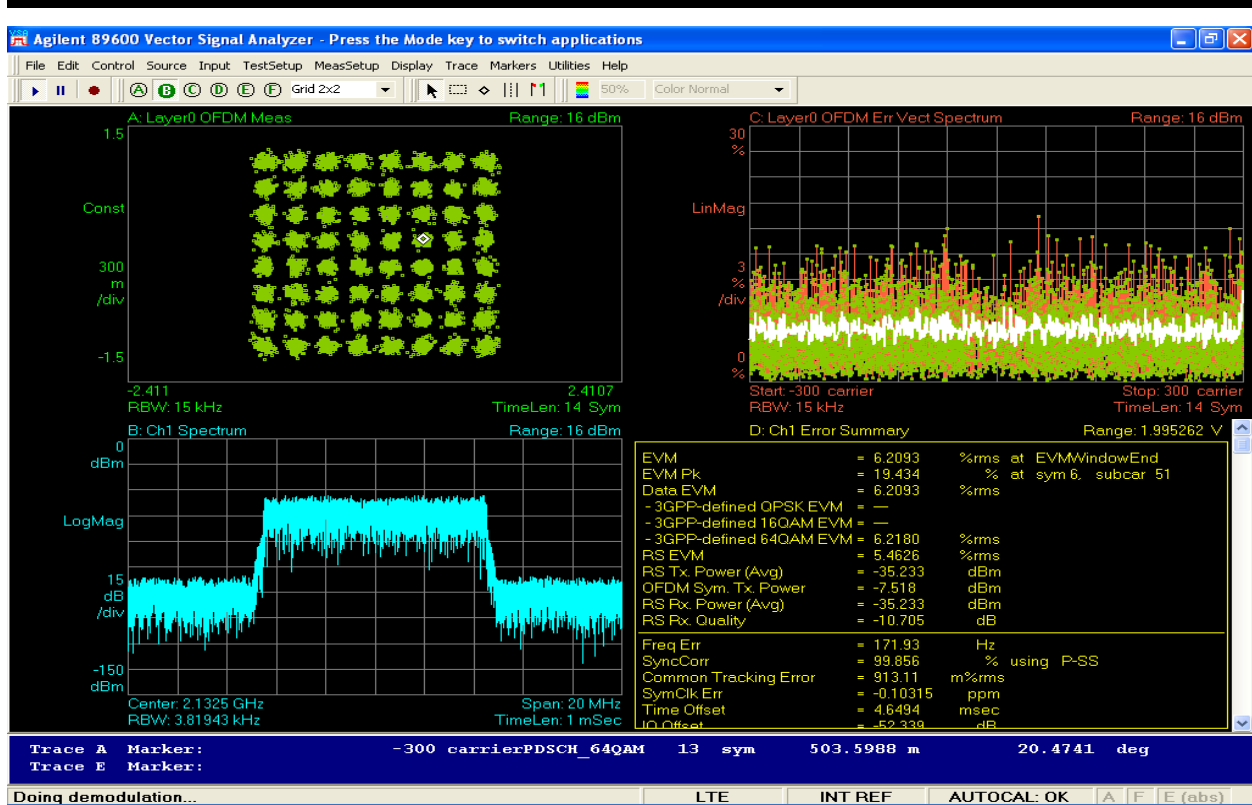

Figure 6-40 : 10MHz BW Modulation TX1_64QAM at 2132.5 MHz

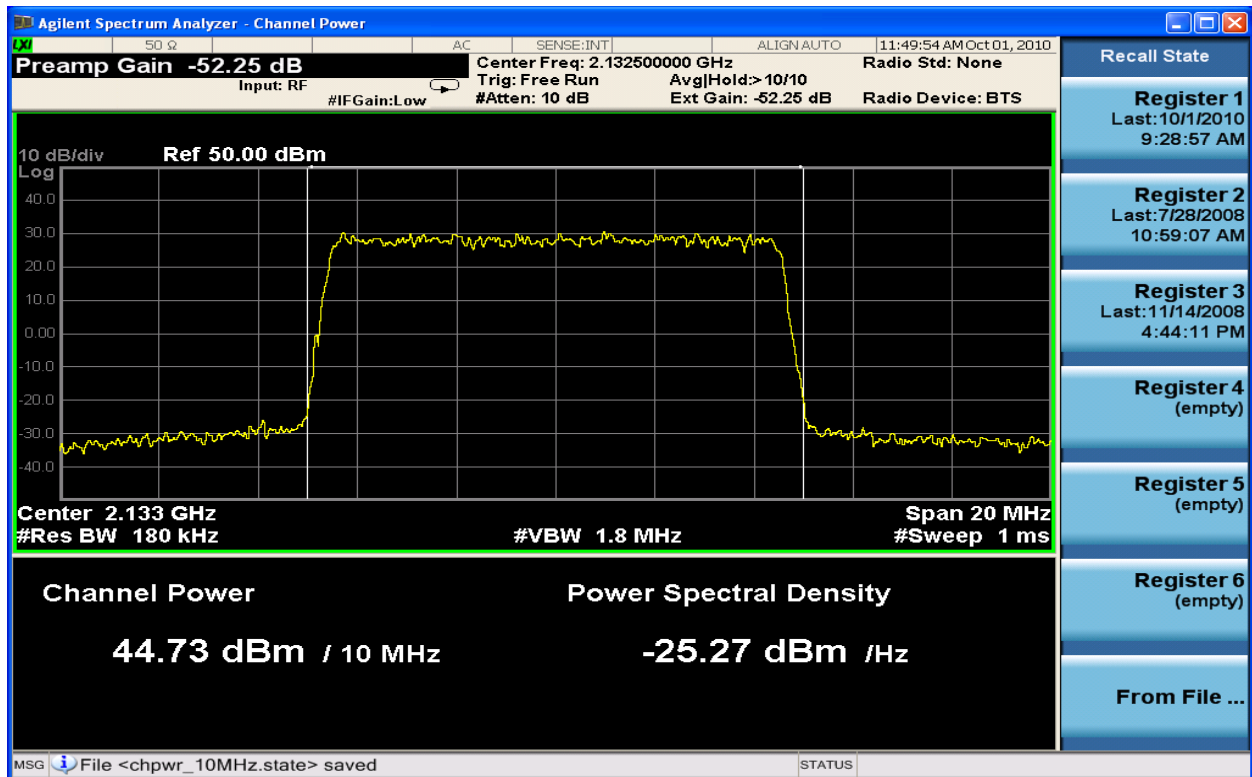

Figure 6-41 : 10MHz BW Channel Power TX1_64QAM at 2132.5MHz

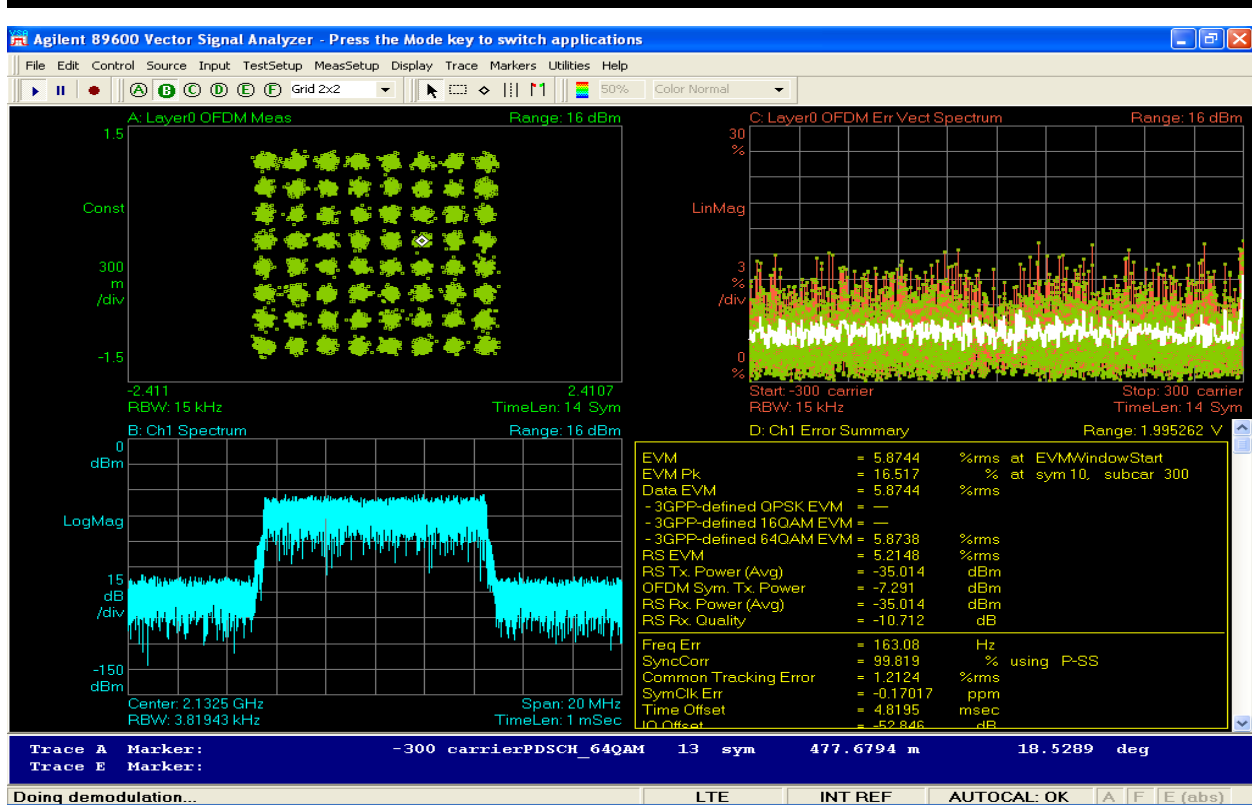

Figure 6-42 : 10MHz BW Modulation TX2_64QAM at 2132.5MHz

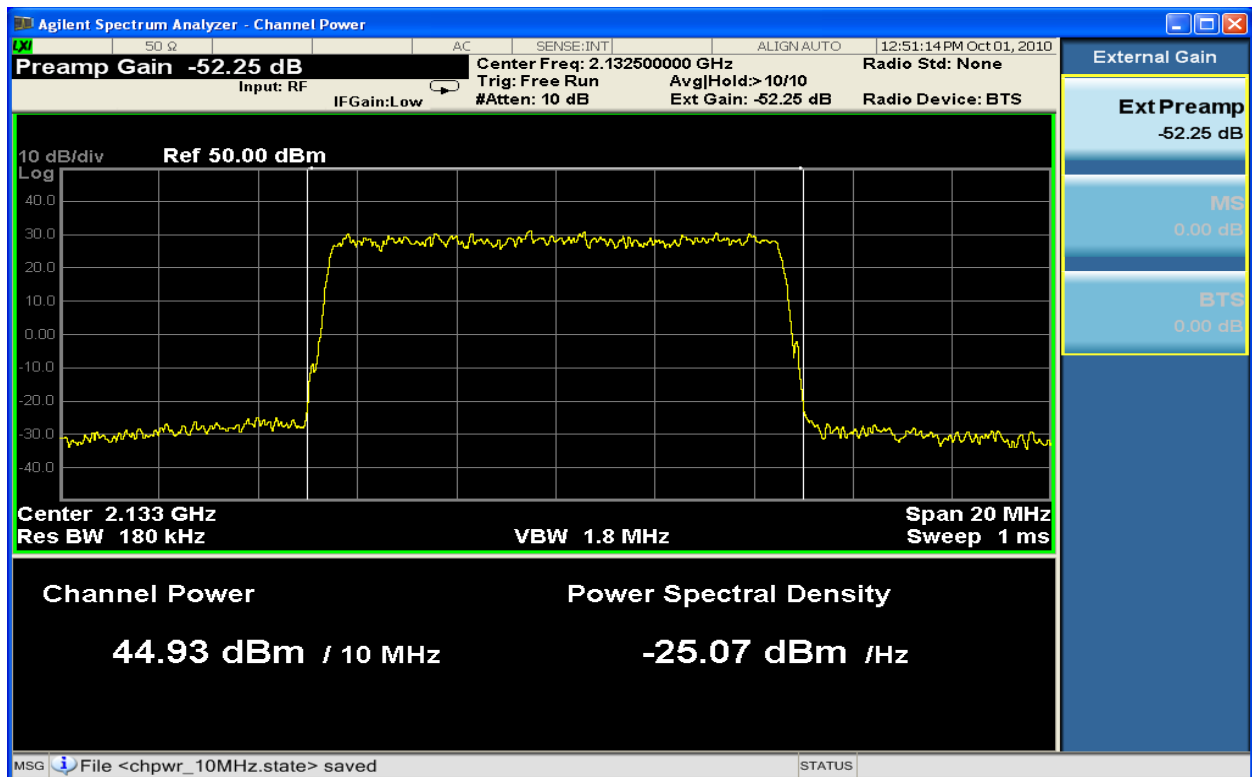

Figure 6-43 : 10MHz BW Channel Power TX2_64QAM at 2132.5MHz

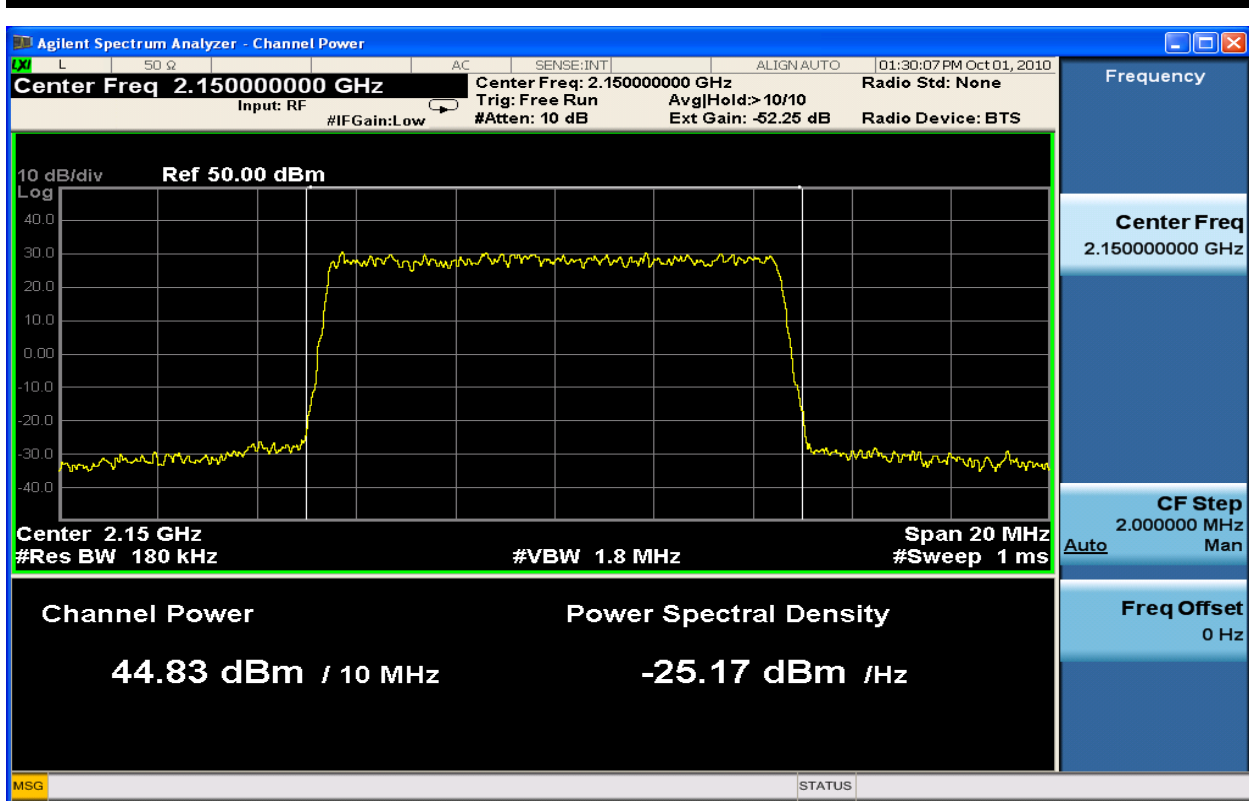

Figure 6-44 : 10MHz BW Channel Power TX1_QPSK at 2150.0 MHz

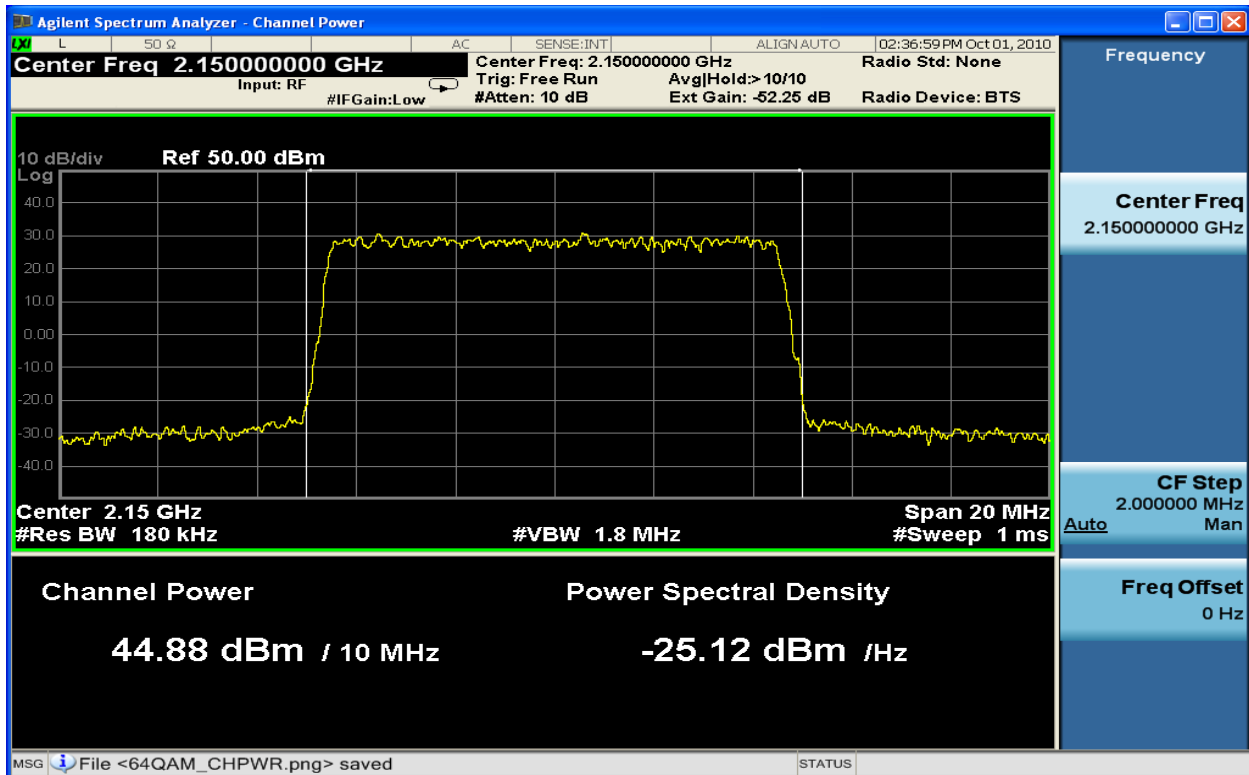

Figure 6-45 : 10MHz BW Channel Power TX2_QPSK at 2150.0 MHz

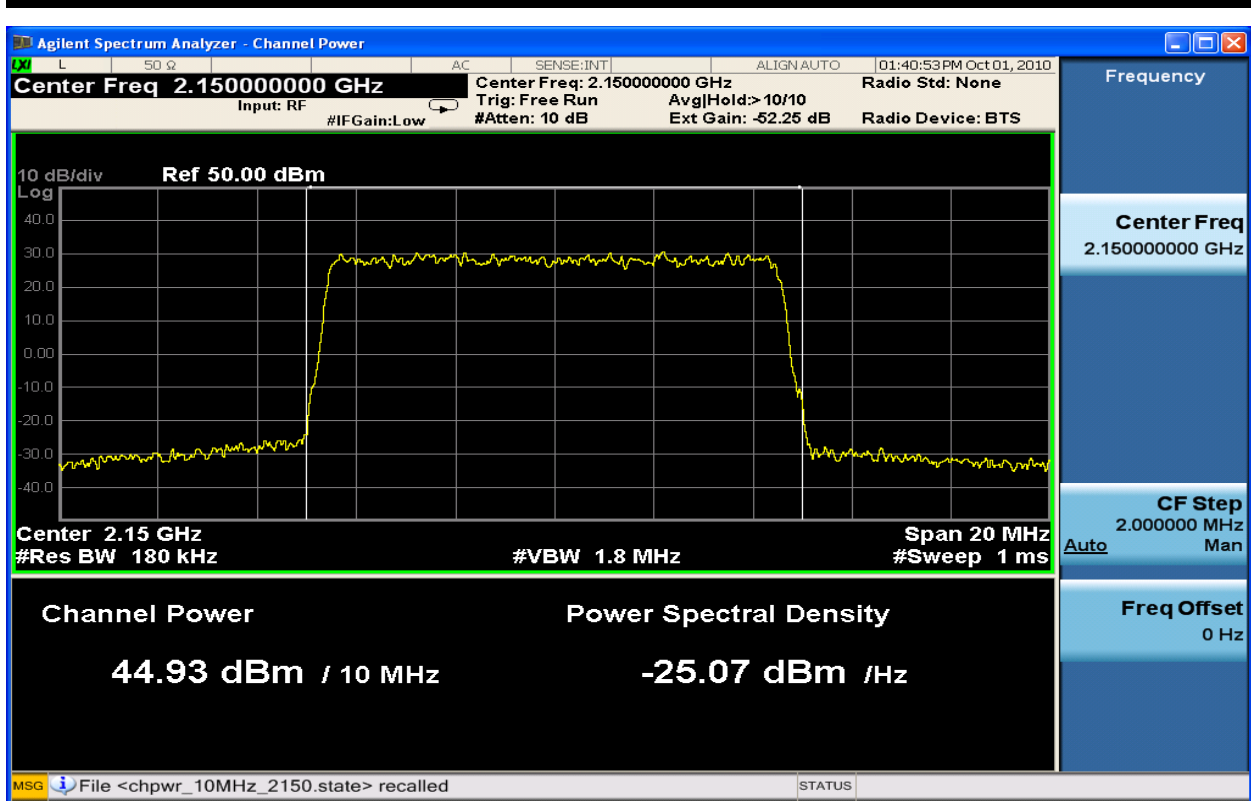

Figure 6-46 : 10MHz BW Channel Power TX1_16QAM at 2150.0 MHz

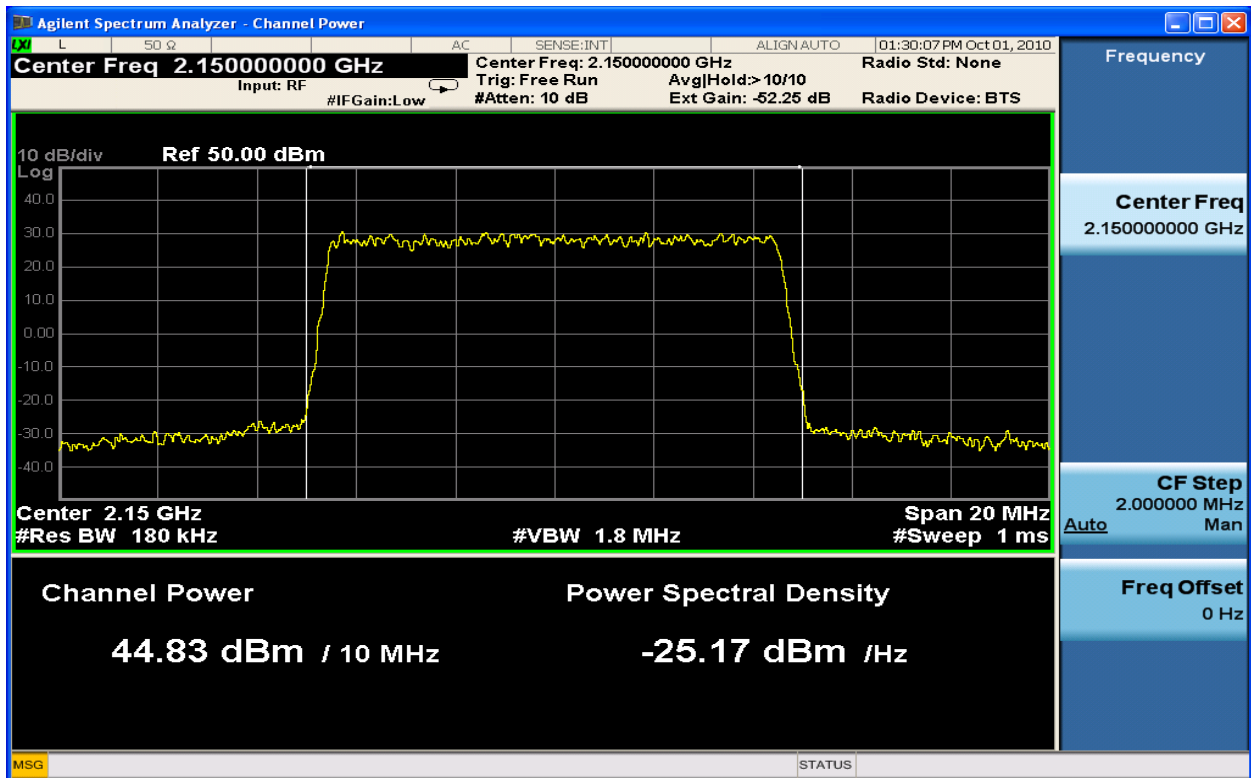

Figure 6-47 : 10MHz BW Channel Power TX2_16QAM at 2150.0 MHz

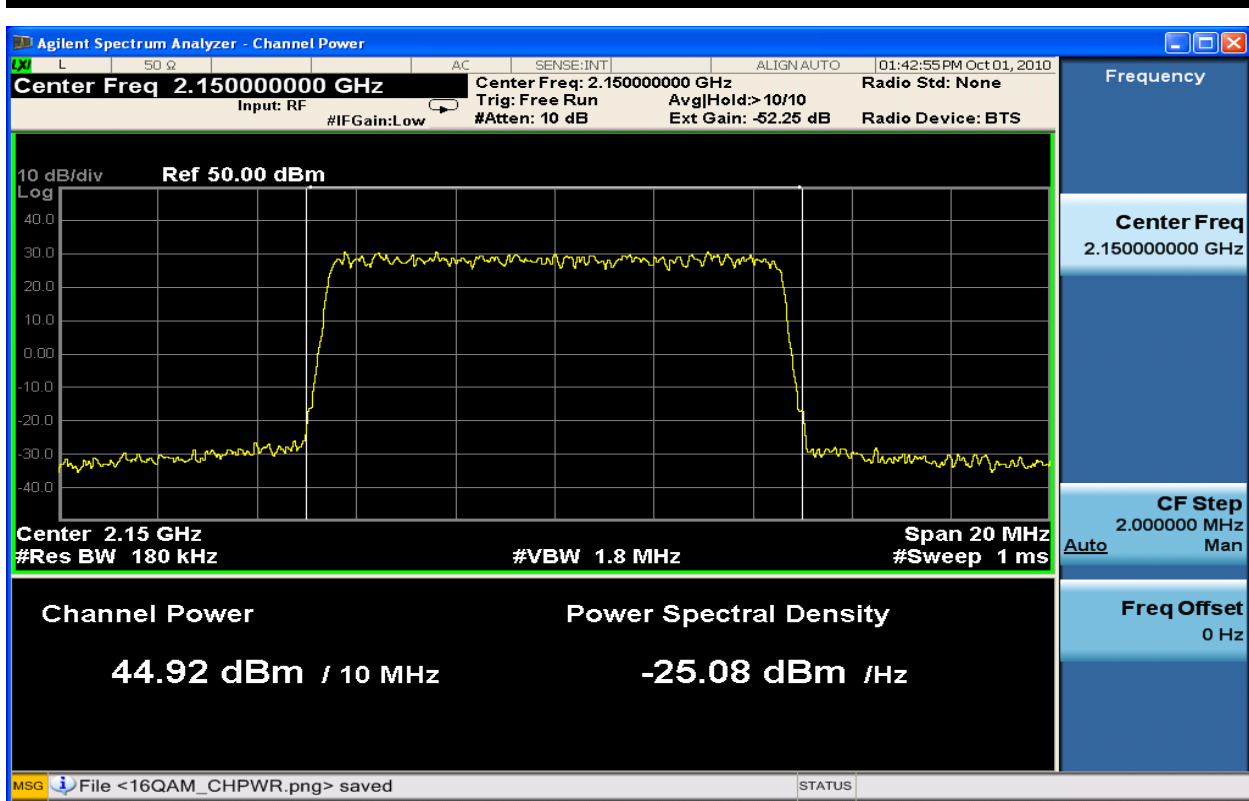

Figure 6-48 : 10MHz BW Channel Power TX1_64QAM at 2150.0 MHz

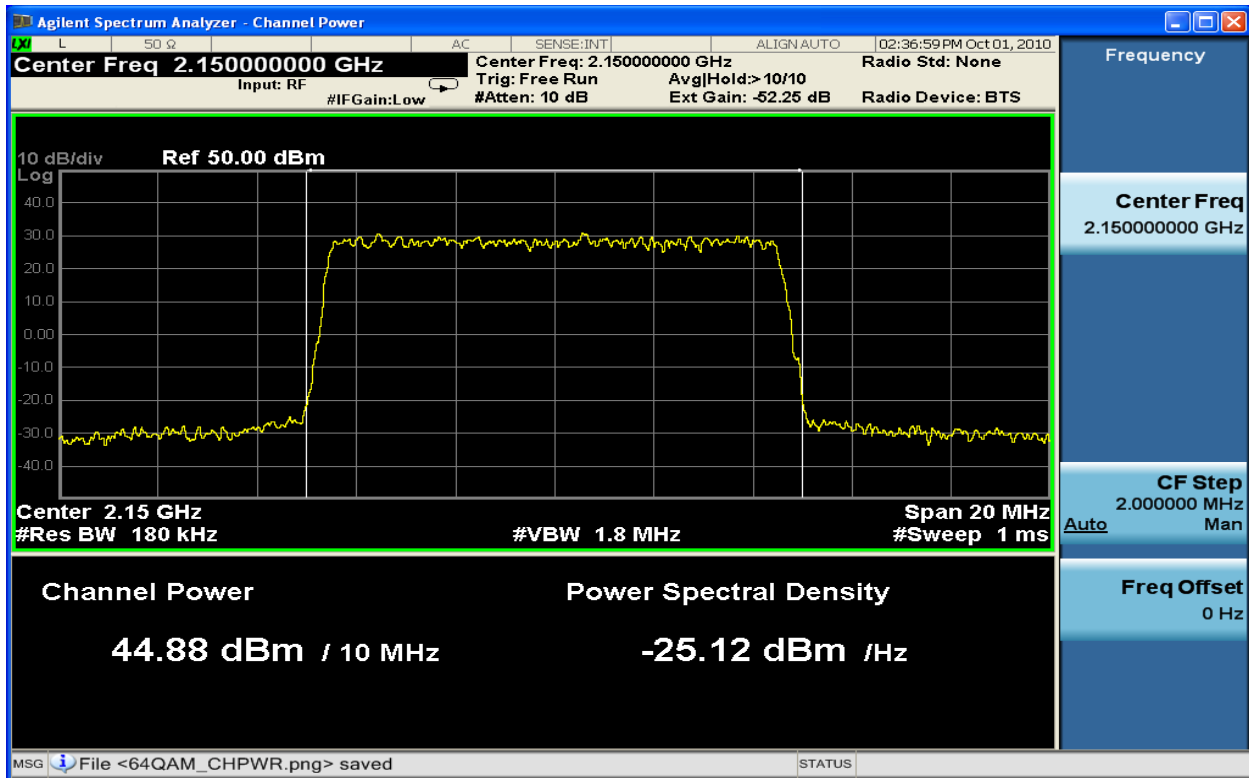

Figure 6-49 : 10MHz BW Channel Power TX2_64QAM at 2150.0 MHz

6.2 RF Safety (Reference 27.52)

Licenses and manufacturers are subject to the radio frequency radiation exposure requirements specified in sections 1.1307(b), 2.1091, and 2.1093 of this chapter, as appropriate.

Technical information showing the basis for this statement must be submitted to the Commission upon request.

The following spread sheet shows an example of the required calculation for MPE (Maximum Permissible Exposure) for RF safety submissions. This calculation is required as a separate exhibit under the FCC submission.

RF Safety: Based on the rated output power and 15.3dB antenna gain, a minimum distance of 3.0 meters to the operating antenna must be maintained.



Prediction of MPE limit at a given distance

Reference_1: Equation from page 51 of EN 50385: Basic standard for the calculation and measurement of electromagnetic field strength and SAR related to human exposure from radio base stations and fixed terminal stations for wireless telecommunication systems (110 MHz - 40 GHz)

Reference 2: Equation from page 18 of OET Bulletin 65, Edition 97-01: Evaluating Compliance with FCC Guidelines for Human Exposure to Radiofrequency Electromagnetic Fields.

$$S \leq \frac{PG}{4\beta R^2}$$

RRUL 11 B4: 2110-2155MHz

where: S = power density
P = power input to the antenna
G = power gain of the antenna in the direction of interest relative to an isotropic radiator
R = distance to the center of radiation of the antenna

Maximum peak output power at antenna input terminal:	<u>44.80</u> (dBm)
Maximum peak output power at antenna input terminal:	<u>30199.5172</u> (mW)
Antenna gain(typical):	<u>15.3</u> (dBi)
Maximum antenna gain:	<u>33.88441561</u> (numeric)
Prediction distance:	<u>300</u> (cm)
Prediction frequency:	<u>2155</u> (MHz)
MPE limit for uncontrolled exposure at prediction frequency:	<u>1</u> (mW/cm ²)
Power density at prediction frequency:	0.904790 (mW/cm ²)
Maximum allowable antenna gain:	15.73452373 (dBi)
Margin of Compliance:	0.434523735

6.3 Occupied Bandwidth

Clause 27.50 2.1049

(a) *Occupied bandwidth.* The frequency bandwidth such that, below its lower and above its upper frequency limits, the mean powers radiated are each equal to 0.5 percent of the total mean power radiated by a given emission. Occupied BW is the portion of the spectrum which contains 99% of the emitted energy (.5% of the remaining is above and .5% is below the occupied BW). The occupied bandwidth may not exceed the authorized bandwidth in the radio service rules. The occupied bandwidth test should be performed for each type of emission listed on the grant.

Procedure:

The following procedure and conditions shall apply for Occupied Bandwidth measurements. As applicable, Lower, Middle and Upper frequency offsets, modulation, and bandwidths shall be assessed and recorded along with the relevant captured plots.

Test Setup

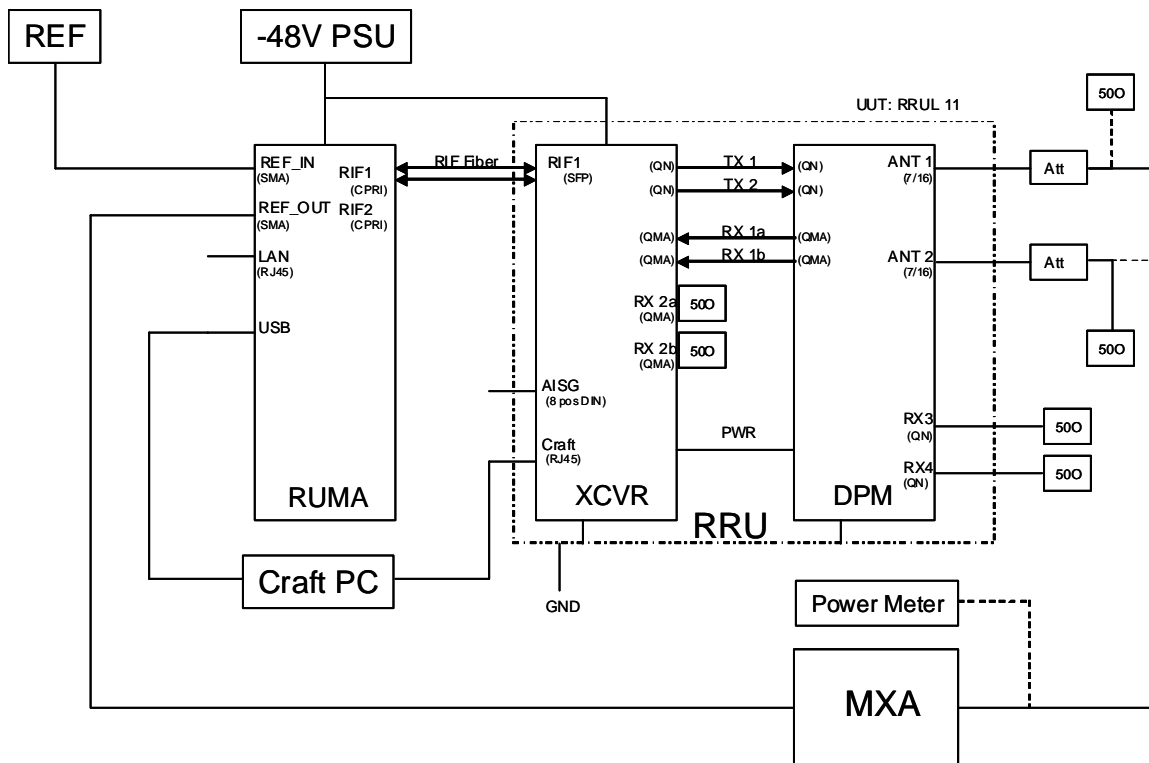

Figure 6-50 RRU Radio Compliance Set Up / Configuration

The following tables are used to summarize recorded results in addition to applicable captured plots.

Table 6-3: Setting / Measurement Results – Occupied Bandwidth 5MHz

Setting			Occupied Bandwidth (MHz)					
			QPSK		16 QAM		64 QAM	
			TX1	TX2	TX1	TX2	TX1	TX2
Frequency	(Lower CH_1975)	2112.5MHz	4.564	4.557	4.552	4.563	4.577	4.565
Frequency	(Middle CH_2175)	2132.5MHz	4.564	4.543	4.528	4.543	4.575	4.556
Frequency	(Upper CH_2375)	2152.5MHz	4.583	4.531	4.557	4.538	4.537	4.570
RBW		180kHz						
VBW		1.8MHz						
CH BW		5MHz						
Span		20MHz						
Sweep		1ms						
Reference Level Offset		53.2dB						
Detector		Peak						
Attenuation		10dB						

Table 6-4: Setting / Measurement Results – Occupied Bandwidth 10MHz

Setting			Occupied Bandwidth (MHz)					
			QPSK		16 QAM		64 QAM	
			TX1	TX2	TX1	TX2	TX1	TX2
Frequency	(Lower CH_2000)	2115.0MHz	8.933	8.965	8.967	8.977	8.968	8.989
Frequency	(Middle CH_2175)	2132.5MHz	8.956	8.942	8.972	8.969	8.962	8.943
Frequency	(Upper CH_2350)	2150.0MHz	8.961	8.958	8.991	8.970	8.941	8.980
RBW		180kHz						
VBW		1.8MHz						
CH BW		10MHz						
Span		20MHz						
Sweep		1ms						
Reference Level Offset		53.2dB						
Detector		Peak						
Attenuation		10dB						

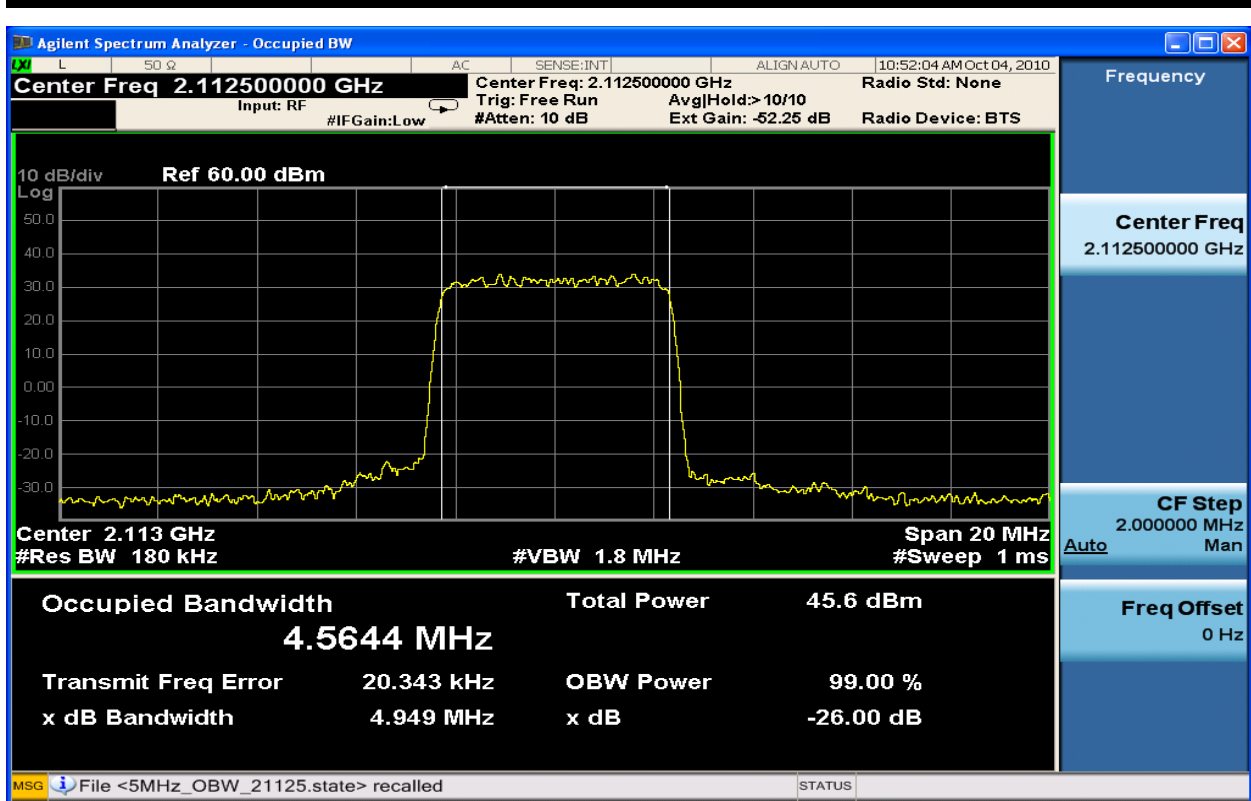

Figure 6-51: 5MHz Occupied Bandwidth TX1_QPSK at 2112.5 MHz

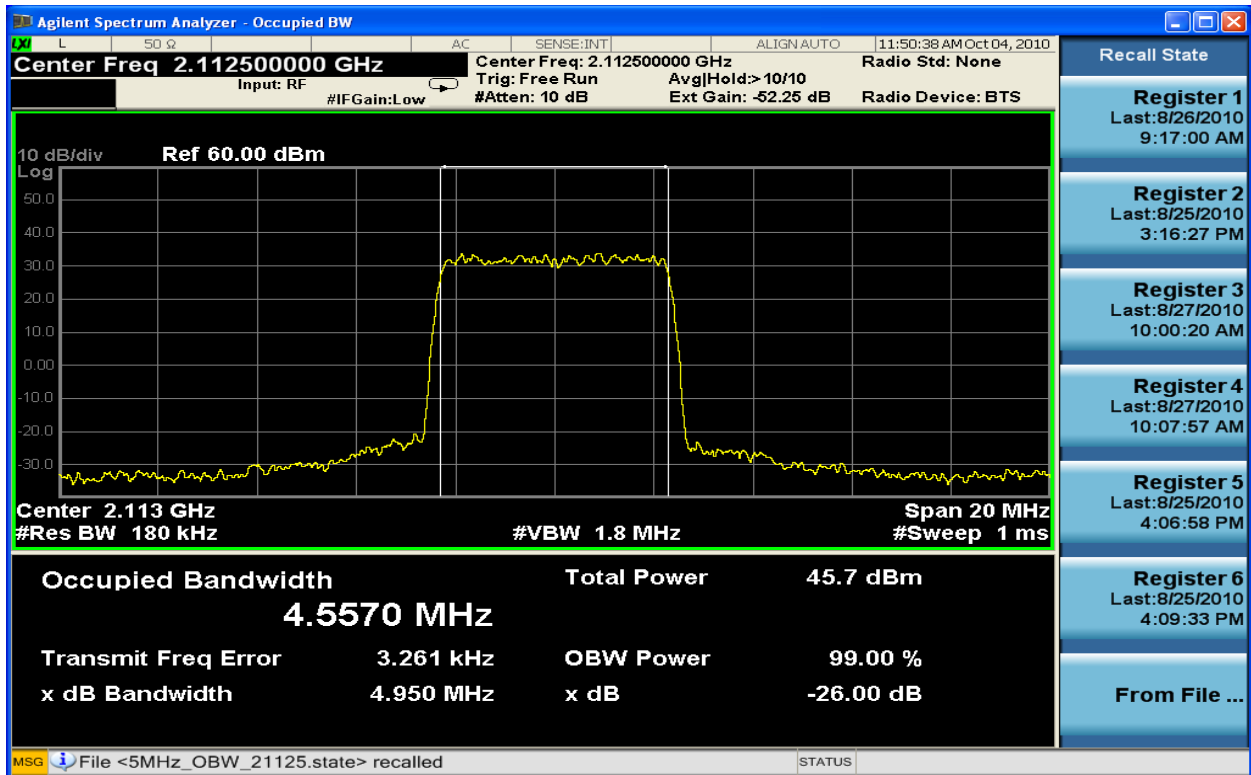

Figure 6-52: 5MHz Occupied Bandwidth TX2_QPSK at 2112.5 MHz

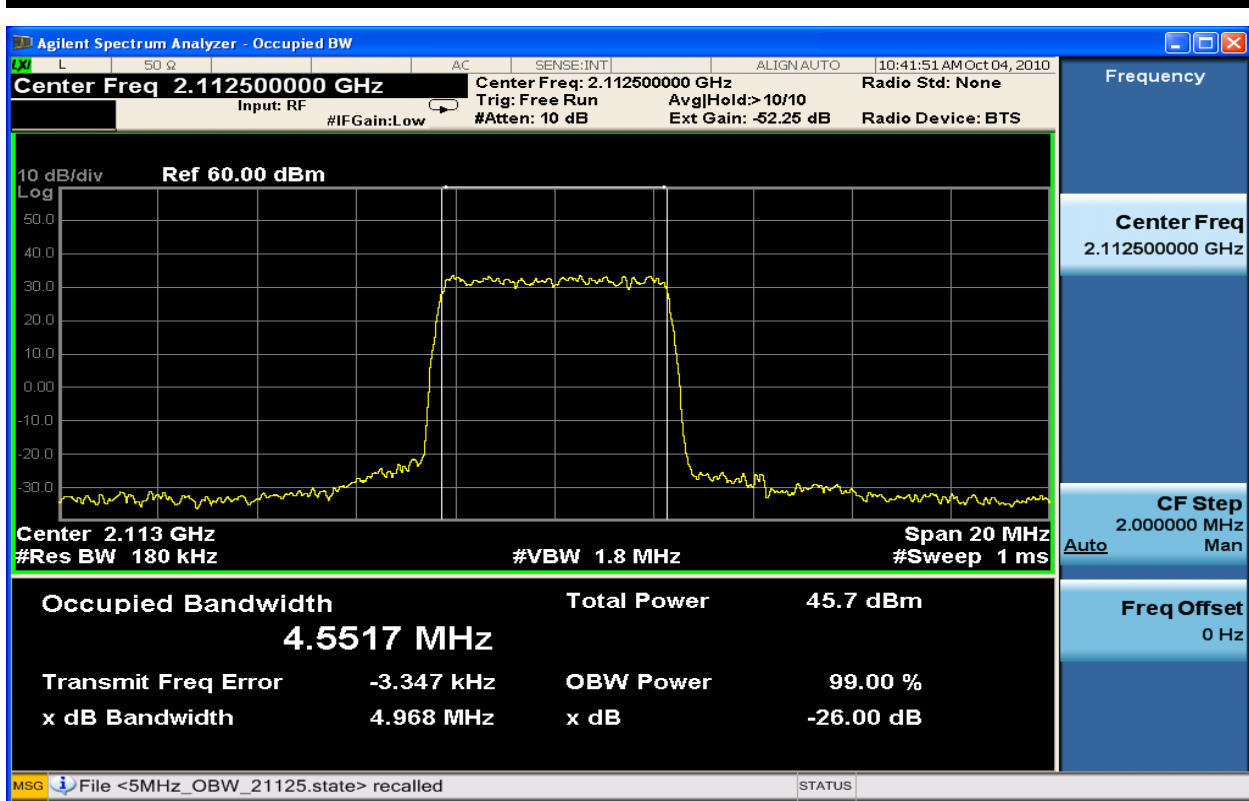

Figure 6-53: 5MHz Occupied Bandwidth TX1_16QAM at 2112.5 MHz

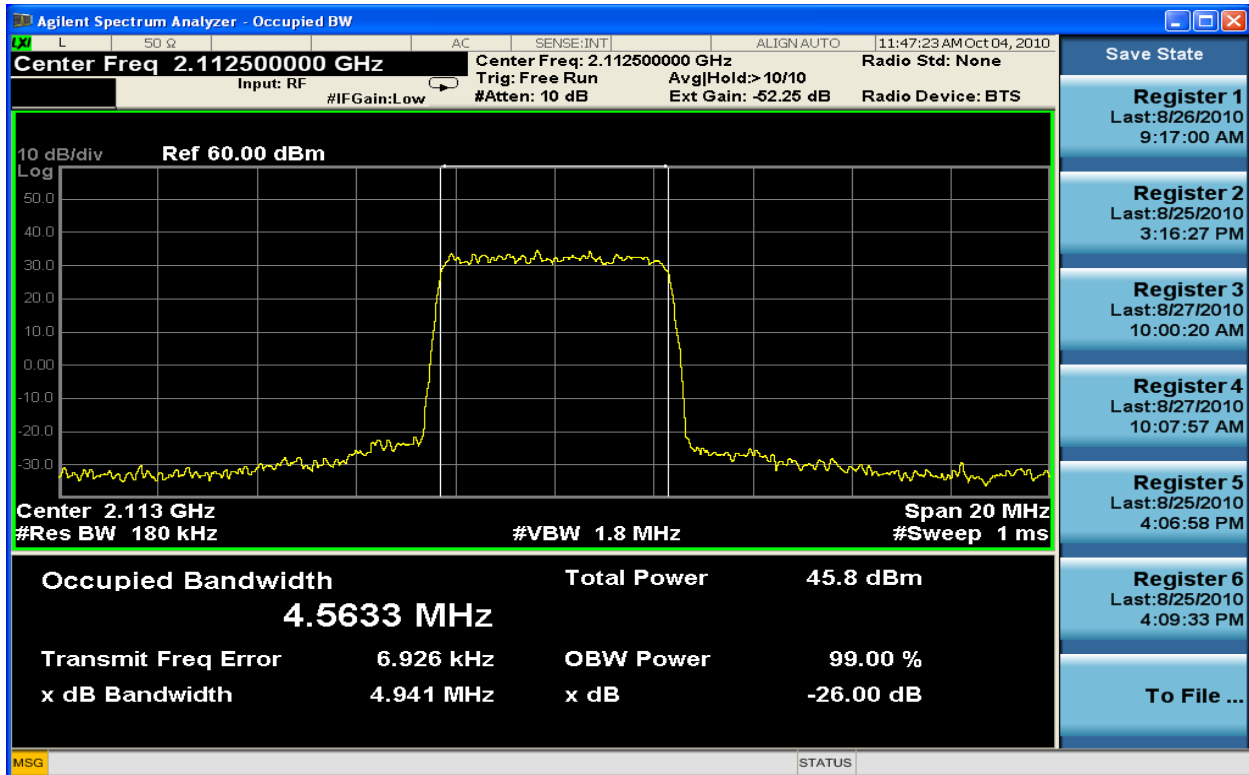

Figure 6-54: 5MHz Occupied Bandwidth TX2_16QAM at 2112.5 MHz

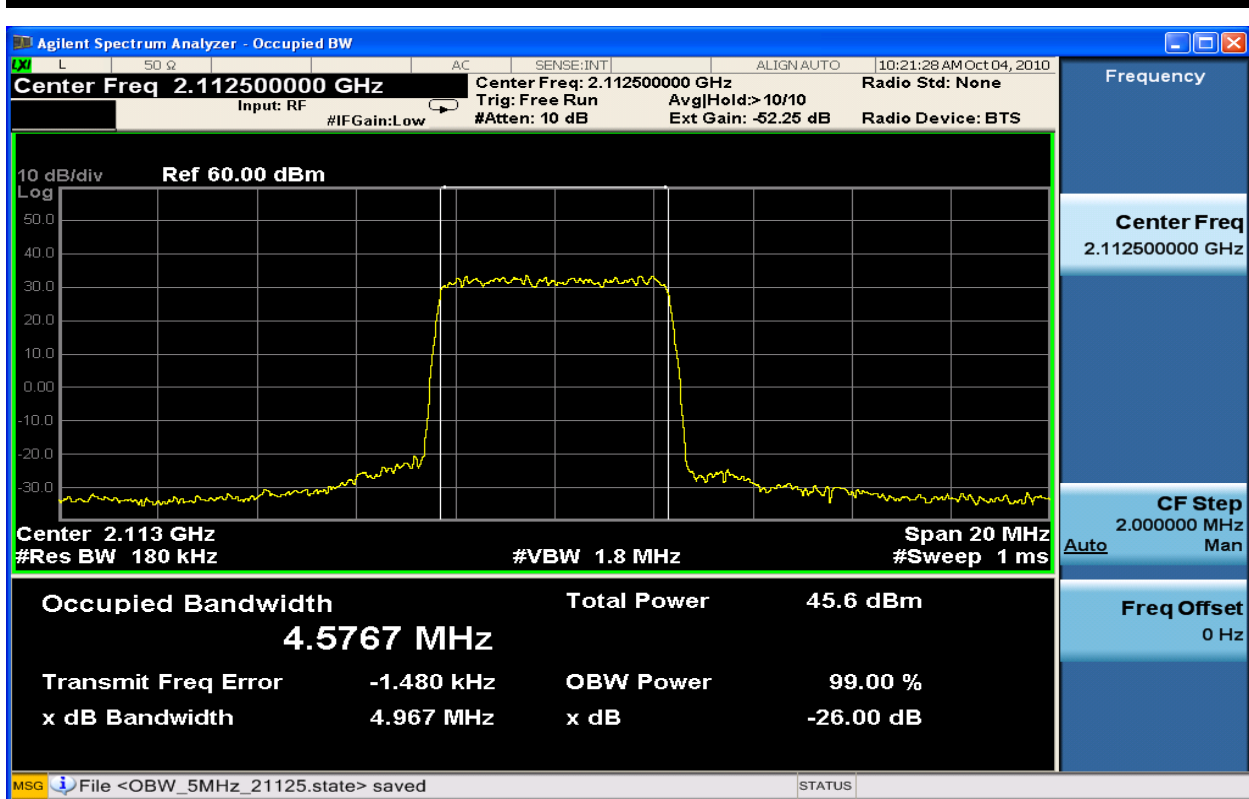

Figure 6-55: 5MHz Occupied Bandwidth TX1_64QAM at 2112.5 MHz

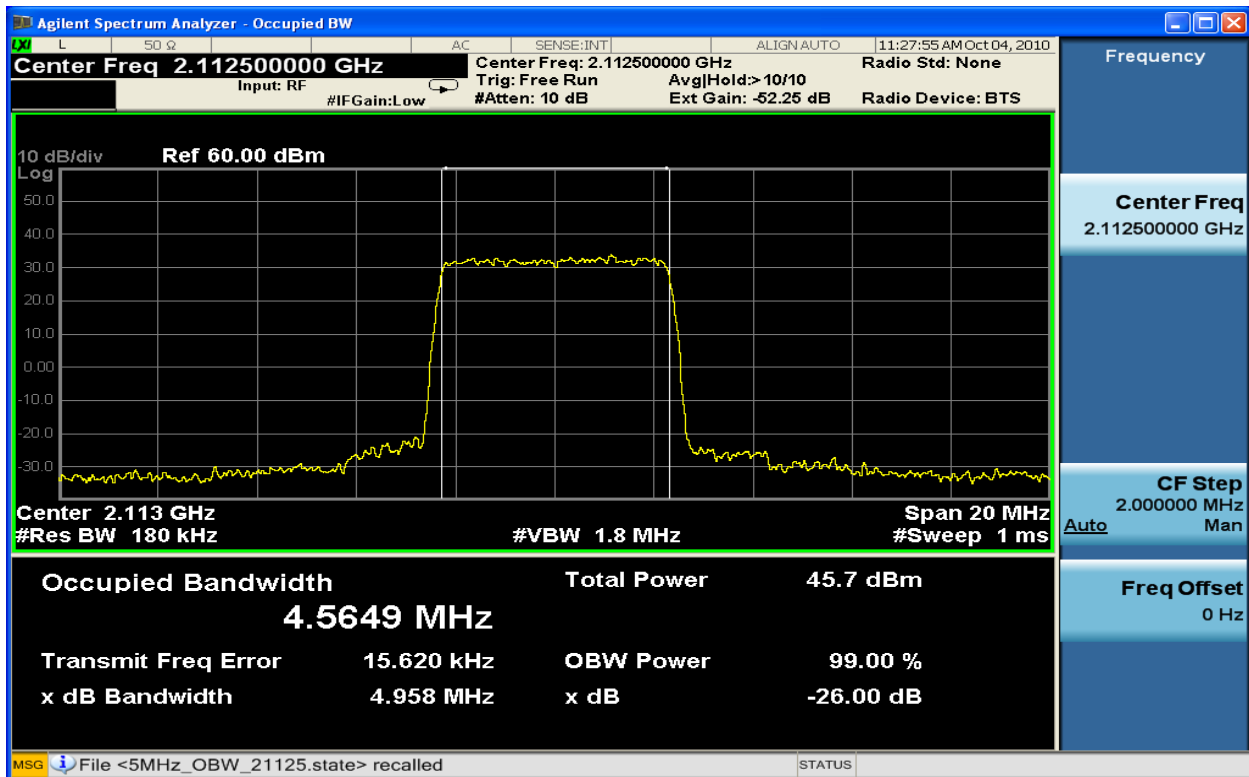

Figure 6-56: 5MHz Occupied Bandwidth TX2_64QAM at 2112.5 MHz

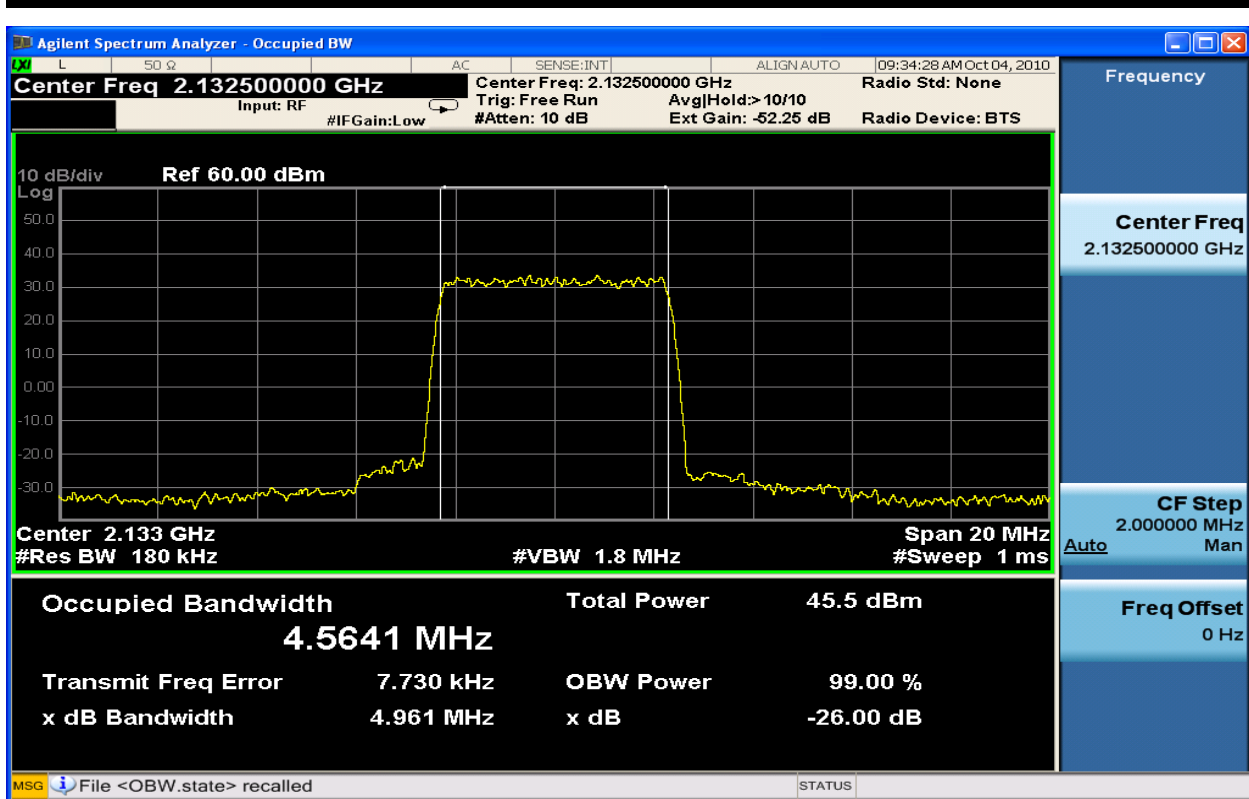

Figure 6-57: 5MHz Occupied Bandwidth TX1_QPSK at 2132.5 MHz

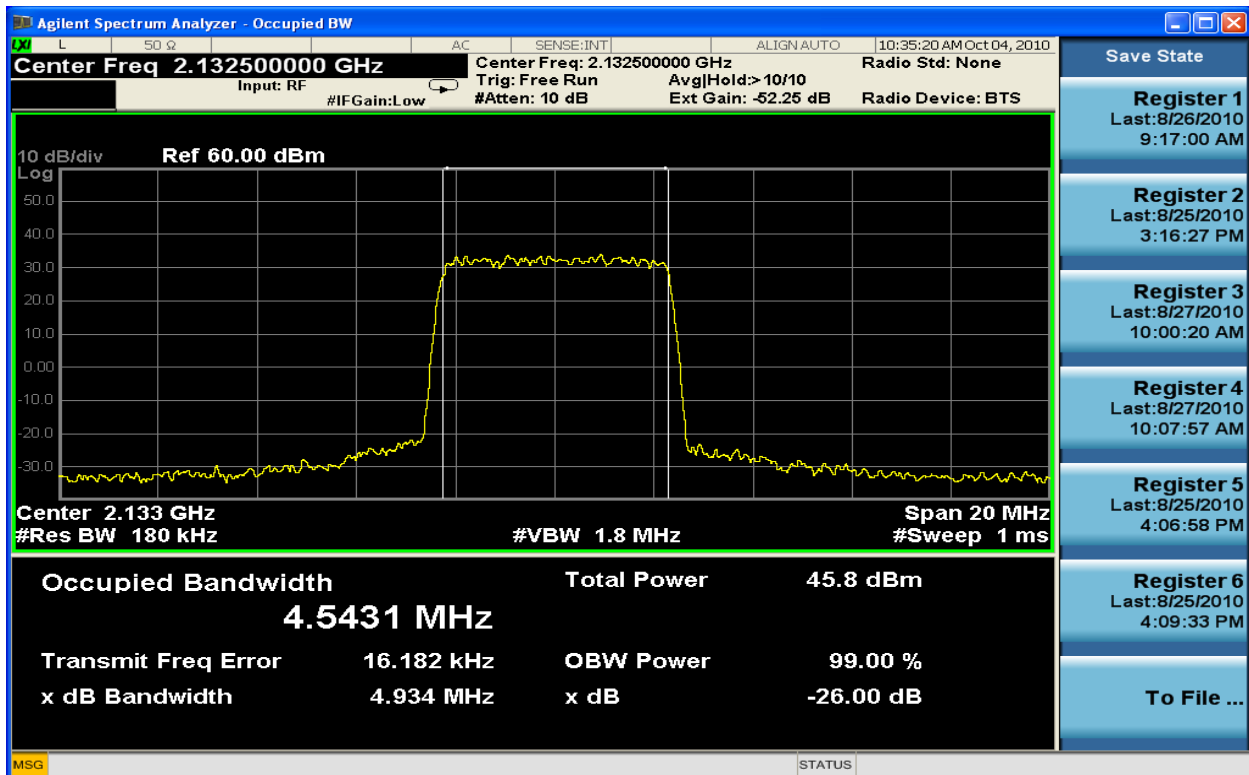

Figure 6-58: 5MHz Occupied Bandwidth TX2_QPSK at 2132.5 MHz

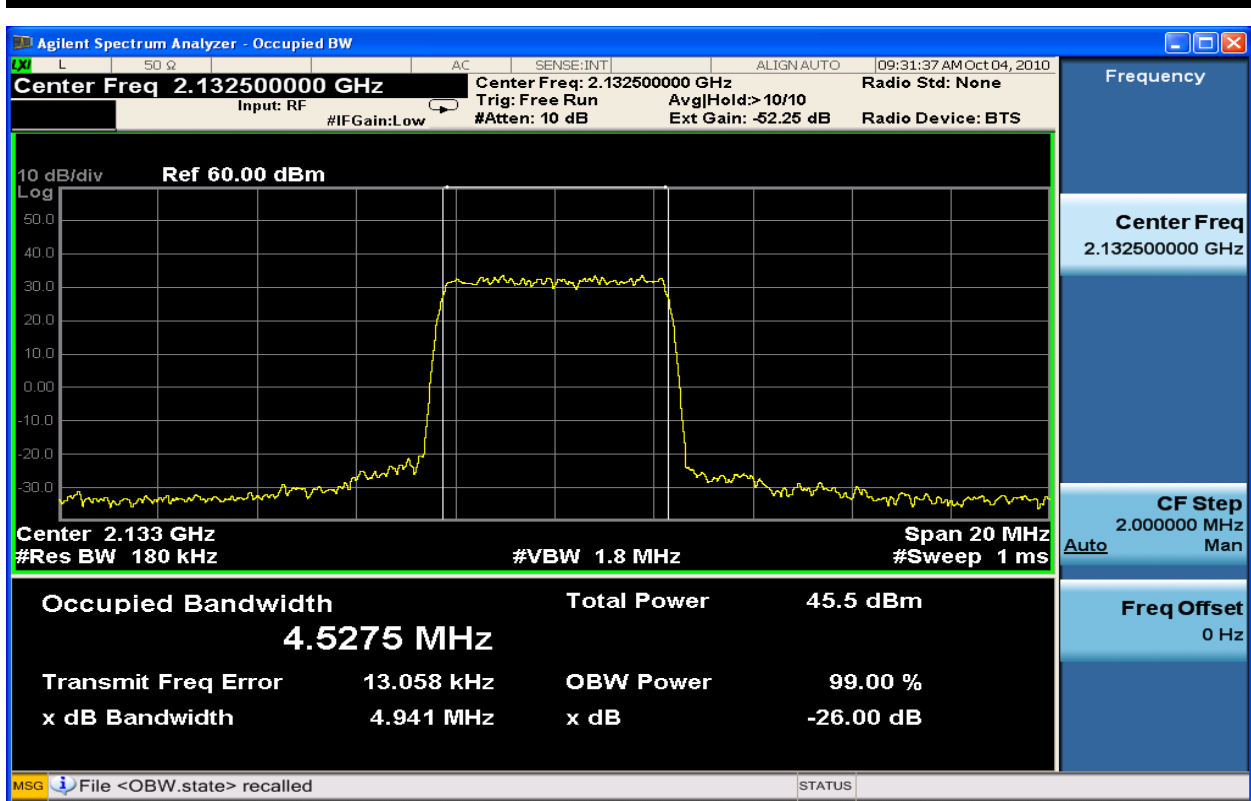

Figure 6-59: 5MHz Occupied Bandwidth TX1_16QAM at 2132.5 MHz

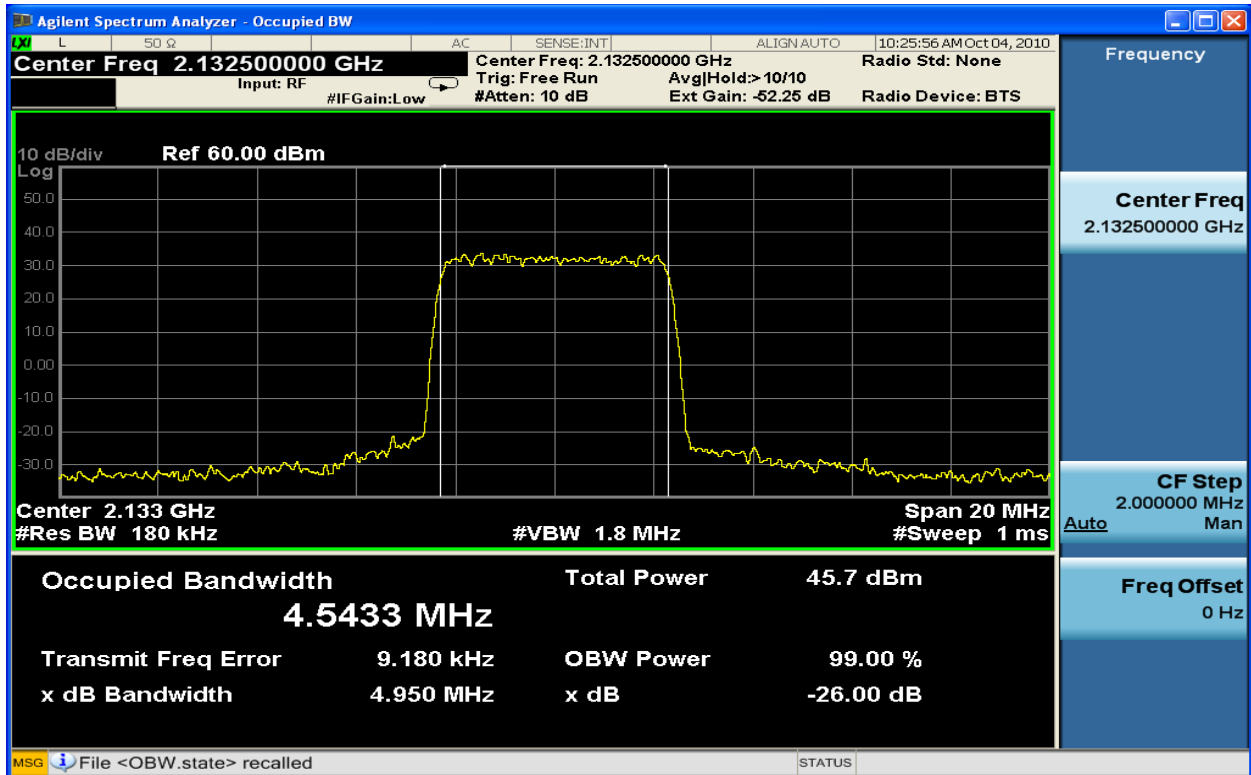

Figure 6-60: 5MHz Occupied Bandwidth TX2_16QAM at 2132.5 MHz

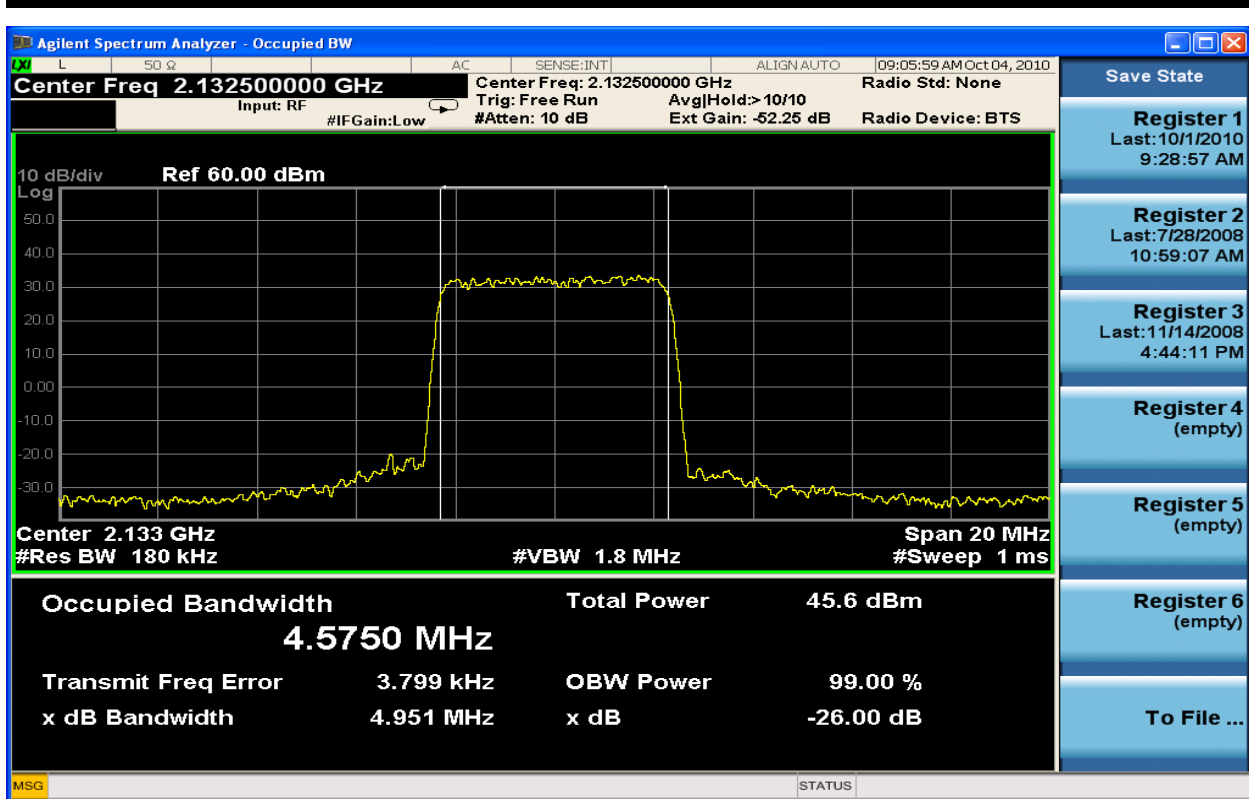

Figure 6-61: 5MHz Occupied Bandwidth TX1_64QAM at 2132.5 MHz

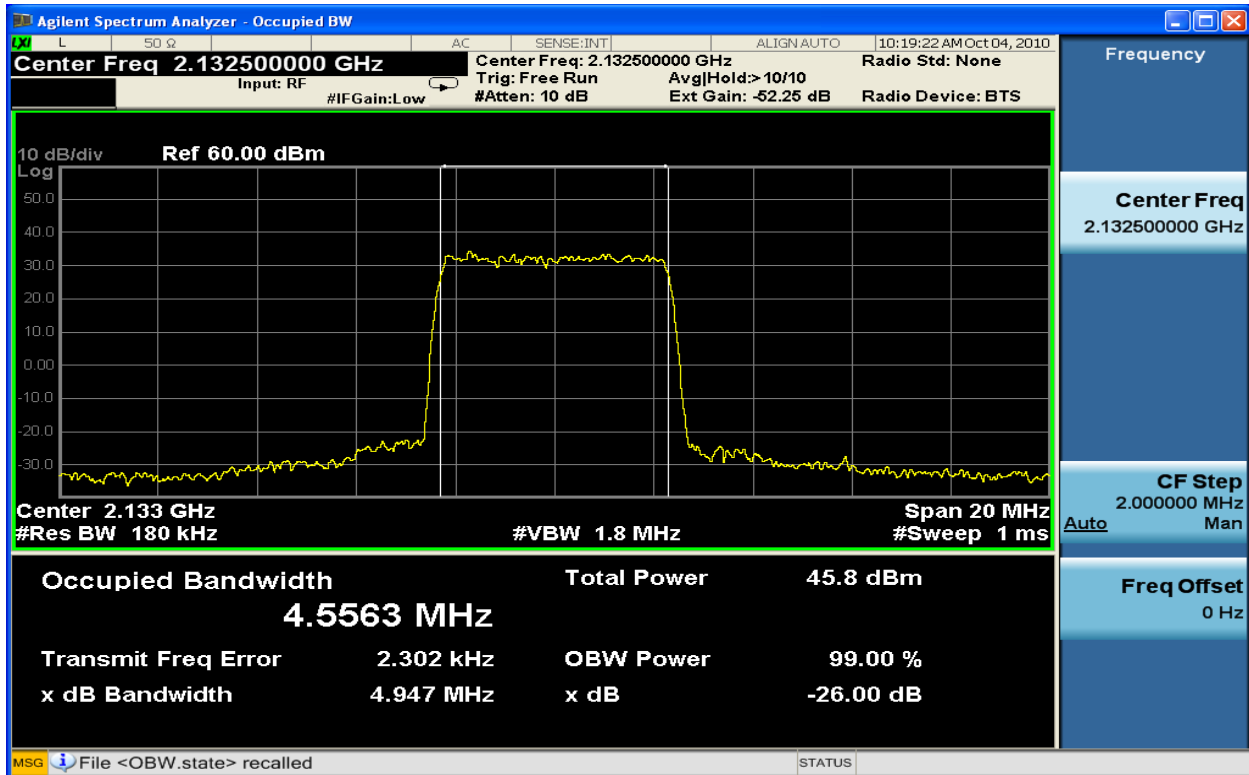

Figure 6-62: 5MHz Occupied Bandwidth TX2_64QAM at 2132.5 MHz

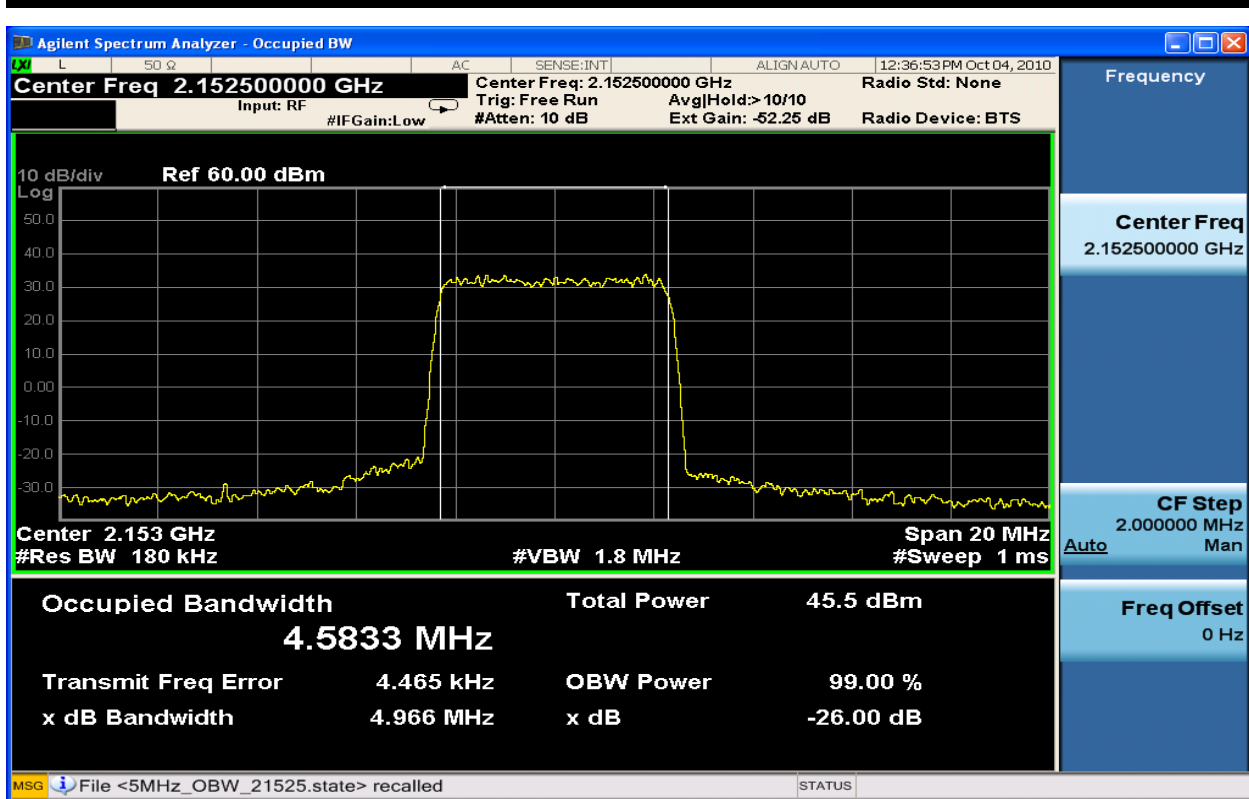

Figure 6-63: 5MHz Occupied Bandwidth TX1_QPSK at 2152.5 MHz

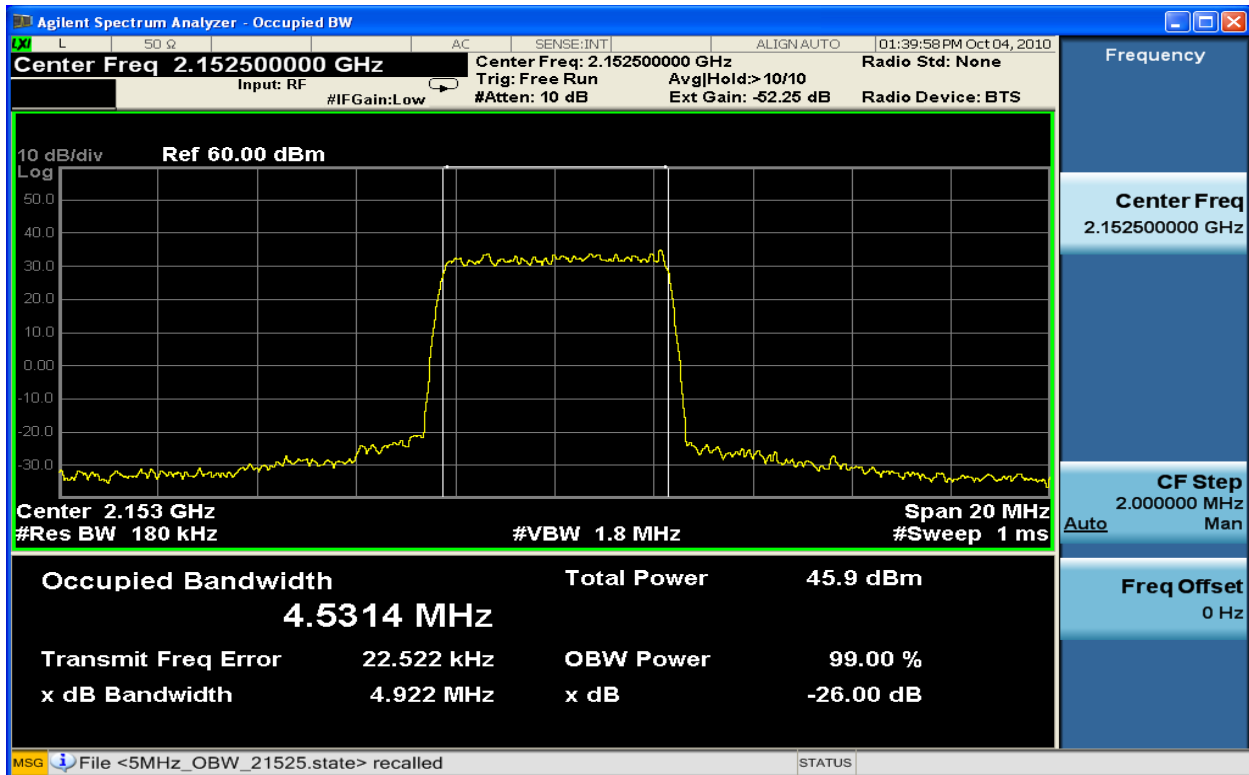

Figure 6-64: 5MHz Occupied Bandwidth TX2_QPSK at 2152.5 MHz

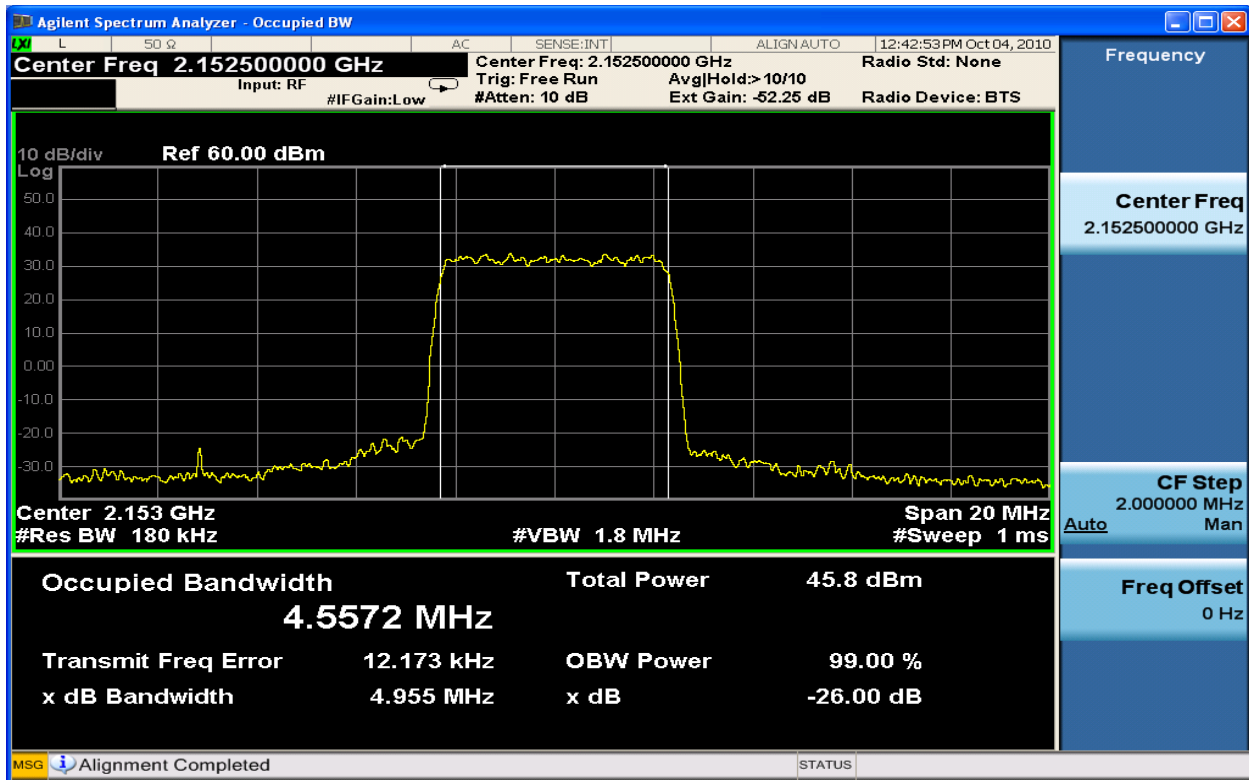

Figure 6-65: 5MHz Occupied Bandwidth TX1_16QAM at 2152.5 MHz

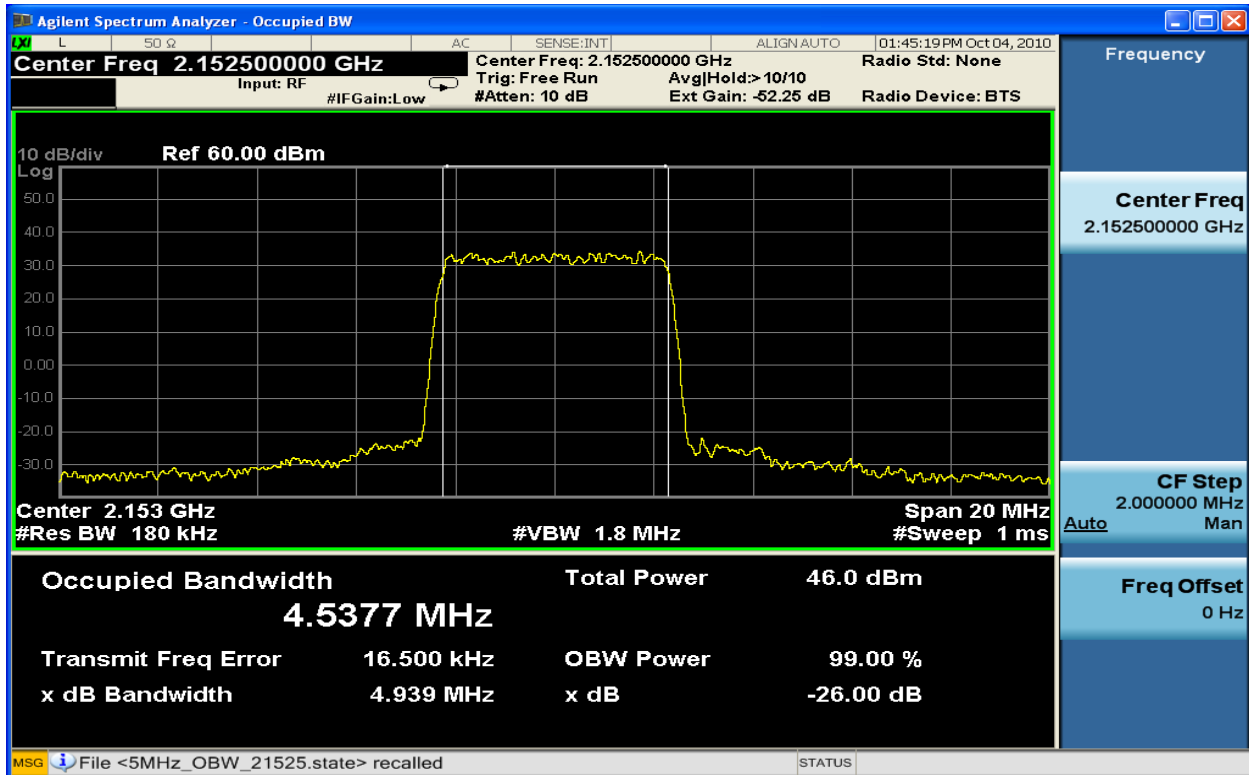

Figure 6-66: 5MHz Occupied Bandwidth TX2_16QAM at 2152.5 MHz

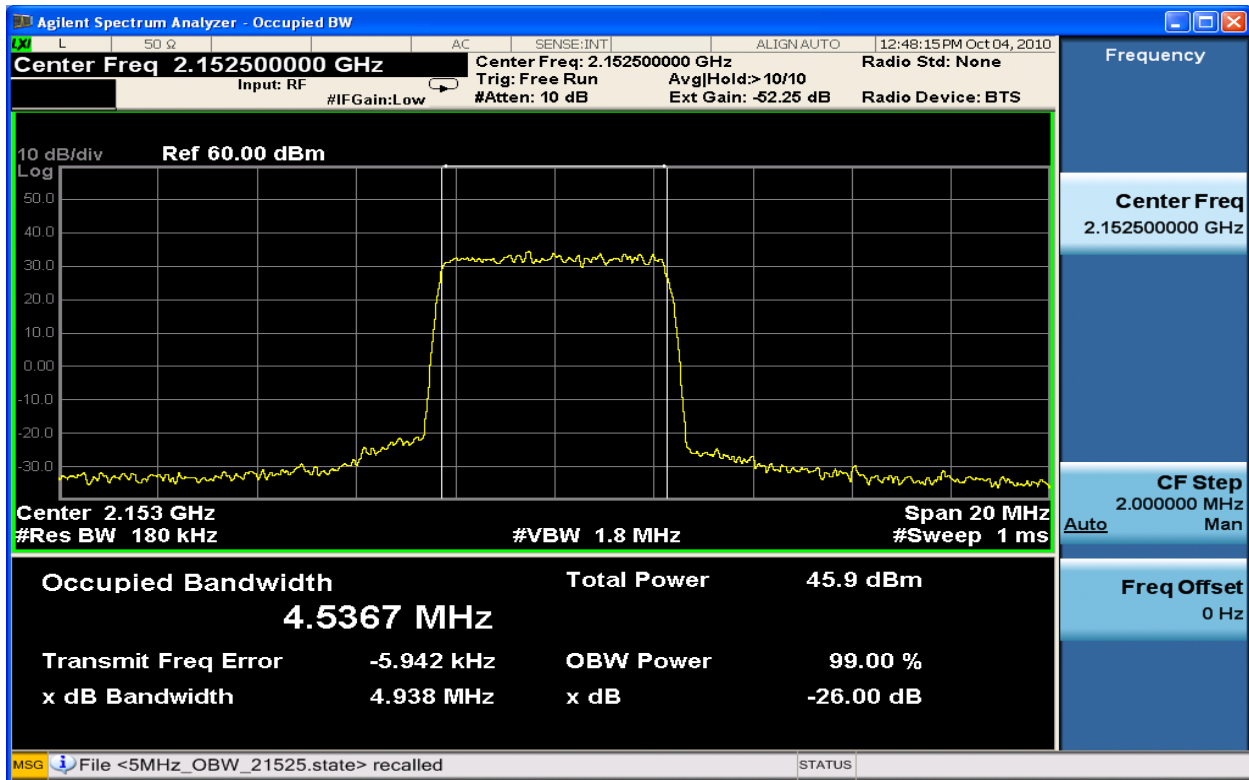

Figure 6-67: 5MHz Occupied Bandwidth TX1_64QAM at 2152.5 MHz

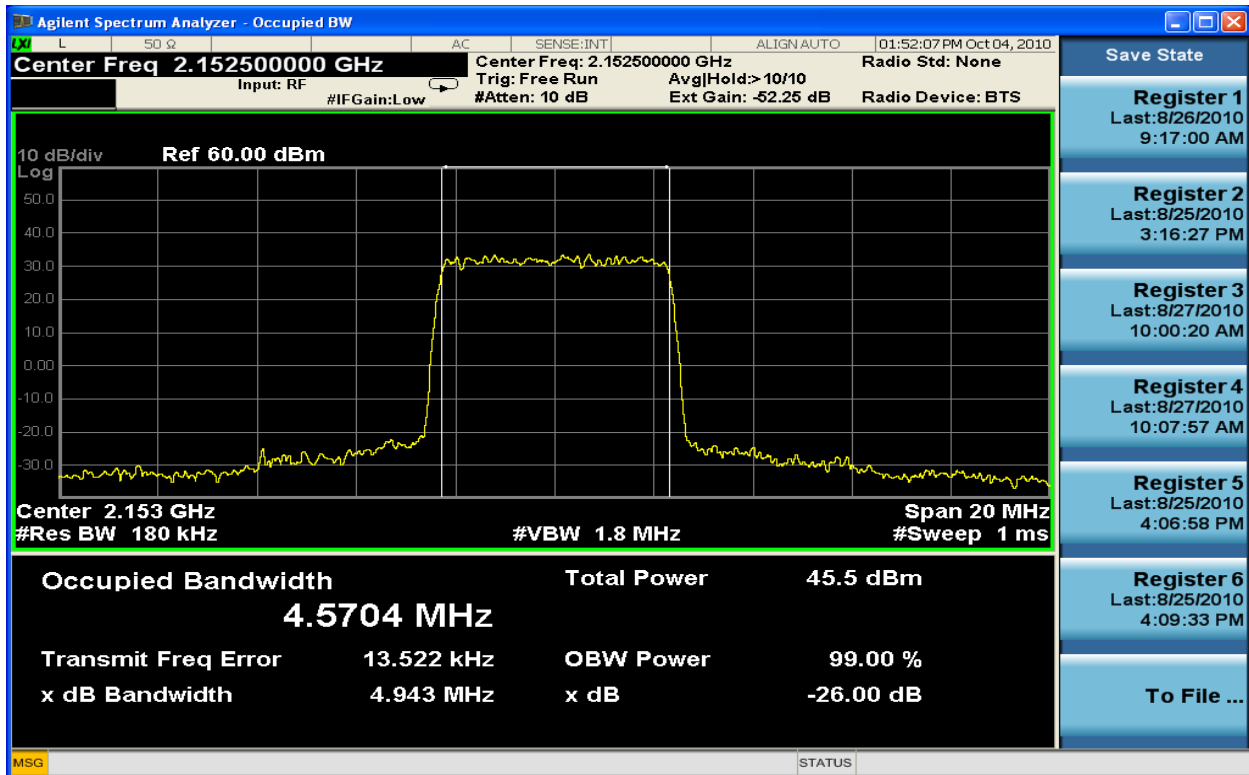

Figure 6-68: 5MHz Occupied Bandwidth TX2_64QAM at 2152.5 MHz

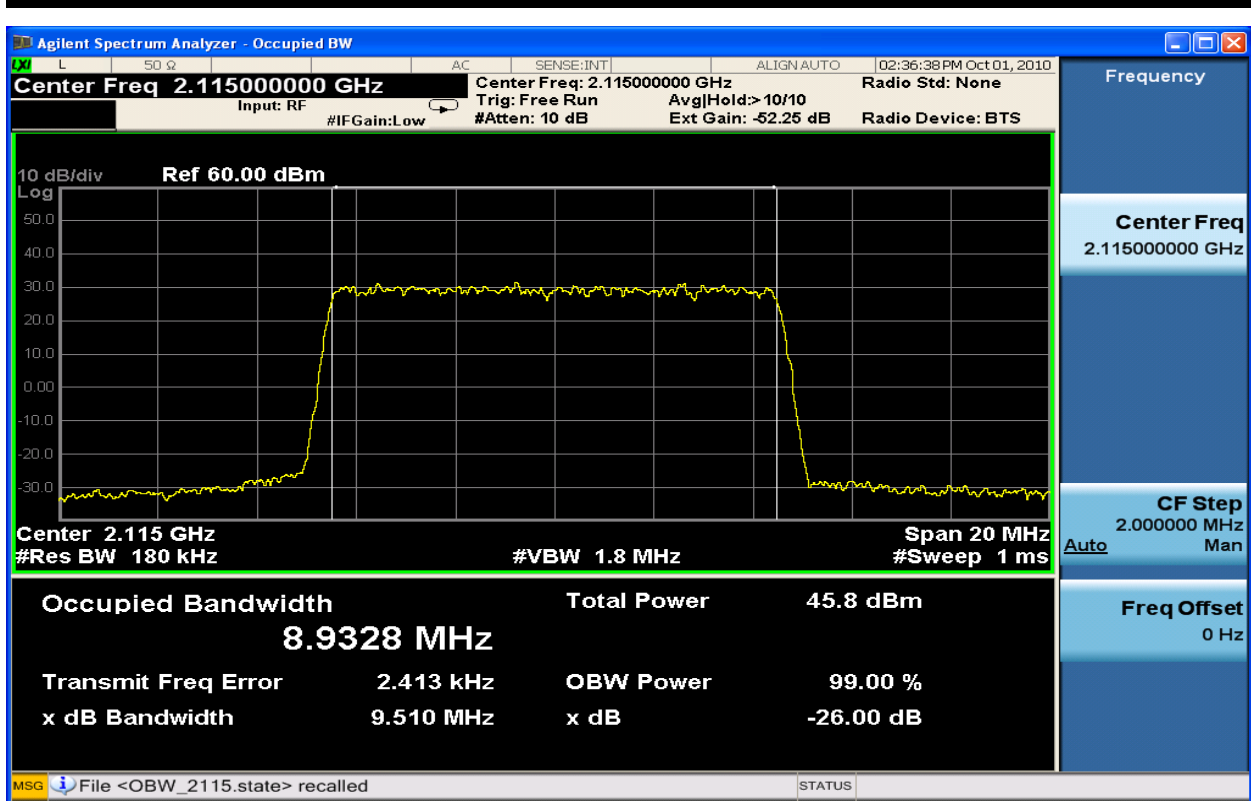

Figure 6-69: 10MHz Occupied Bandwidth TX1_QPSK at 2115.0 MHz

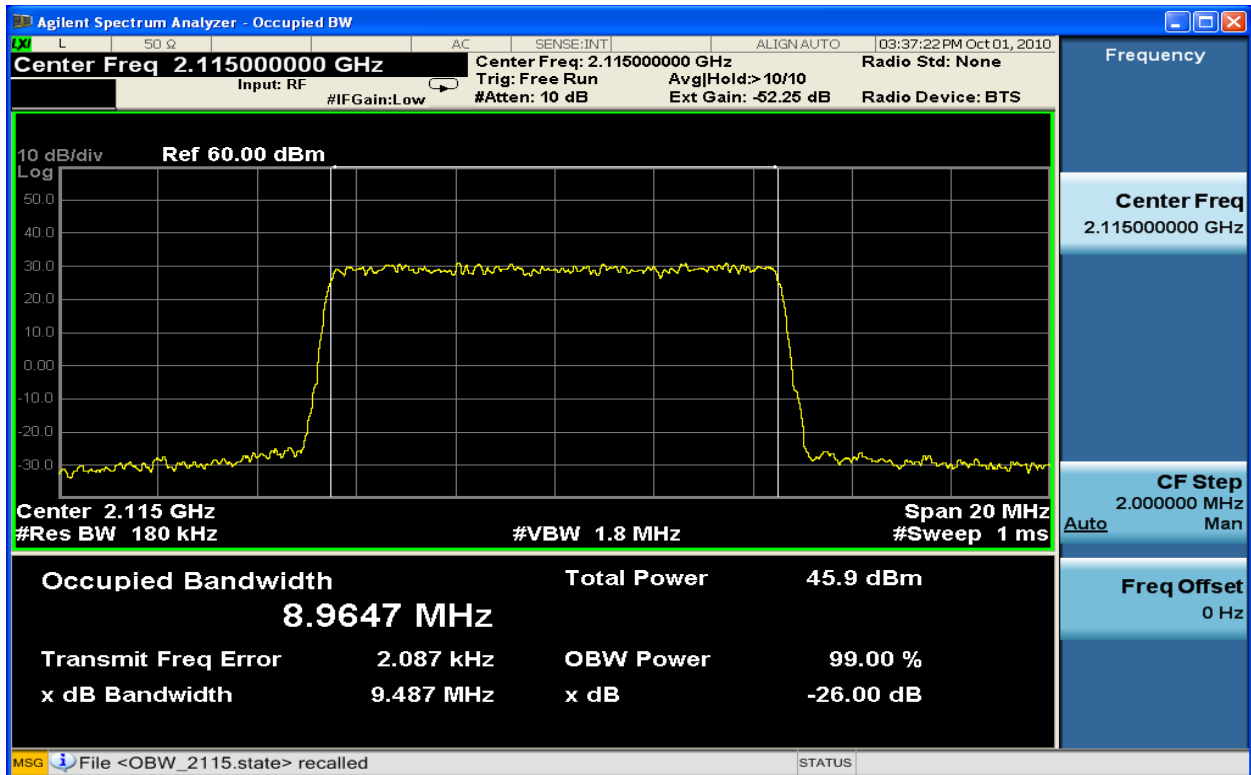

Figure 6-70: 10MHz Occupied Bandwidth TX2_QPSK at 2115.0 MHz

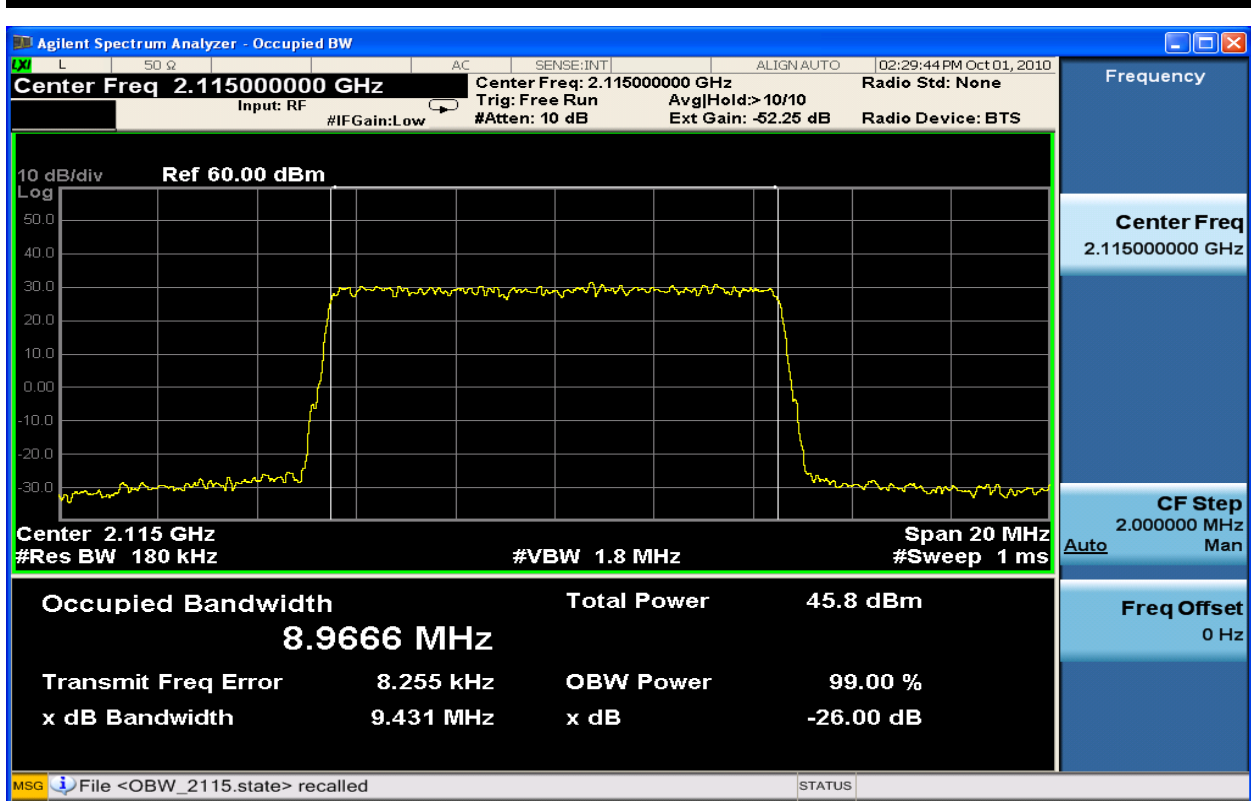

Figure 6-71: 10MHz Occupied Bandwidth TX1_16QAM at 2115.0 MHz

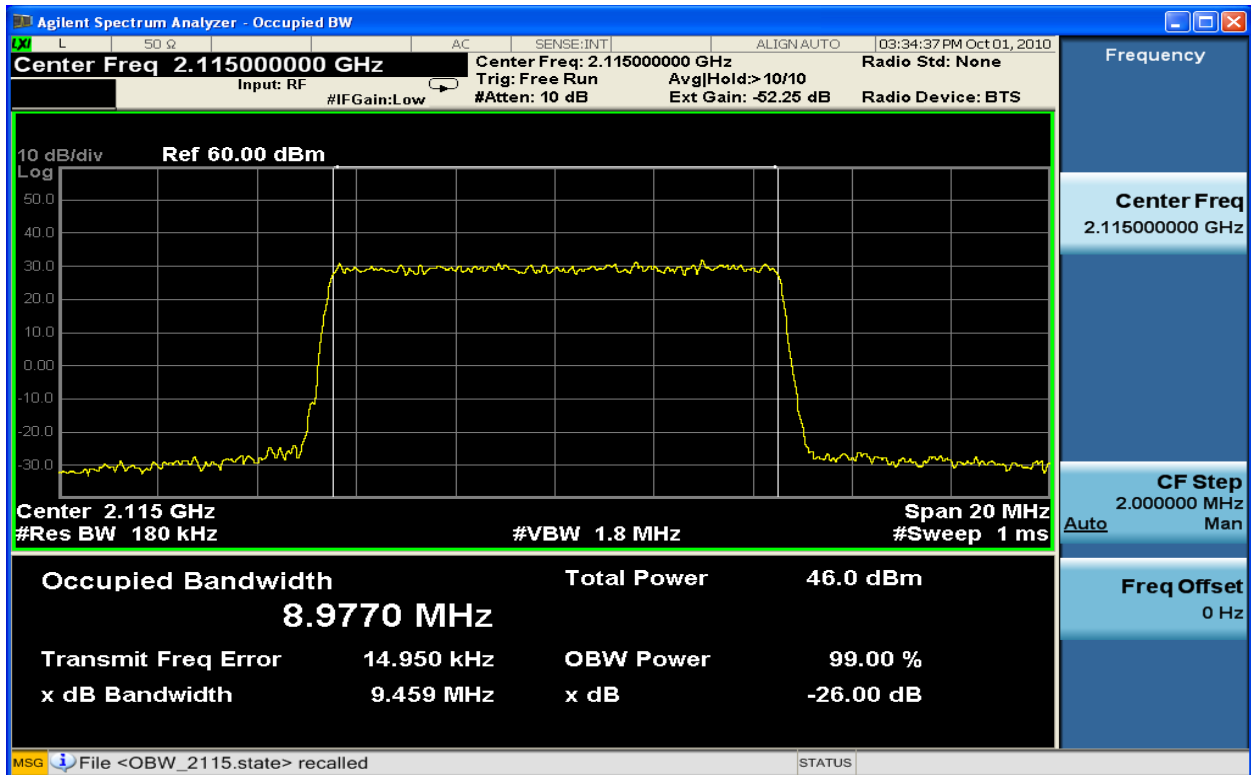

Figure 6-72: 10MHz Occupied Bandwidth TX2_16QAM at 2115.0 MHz

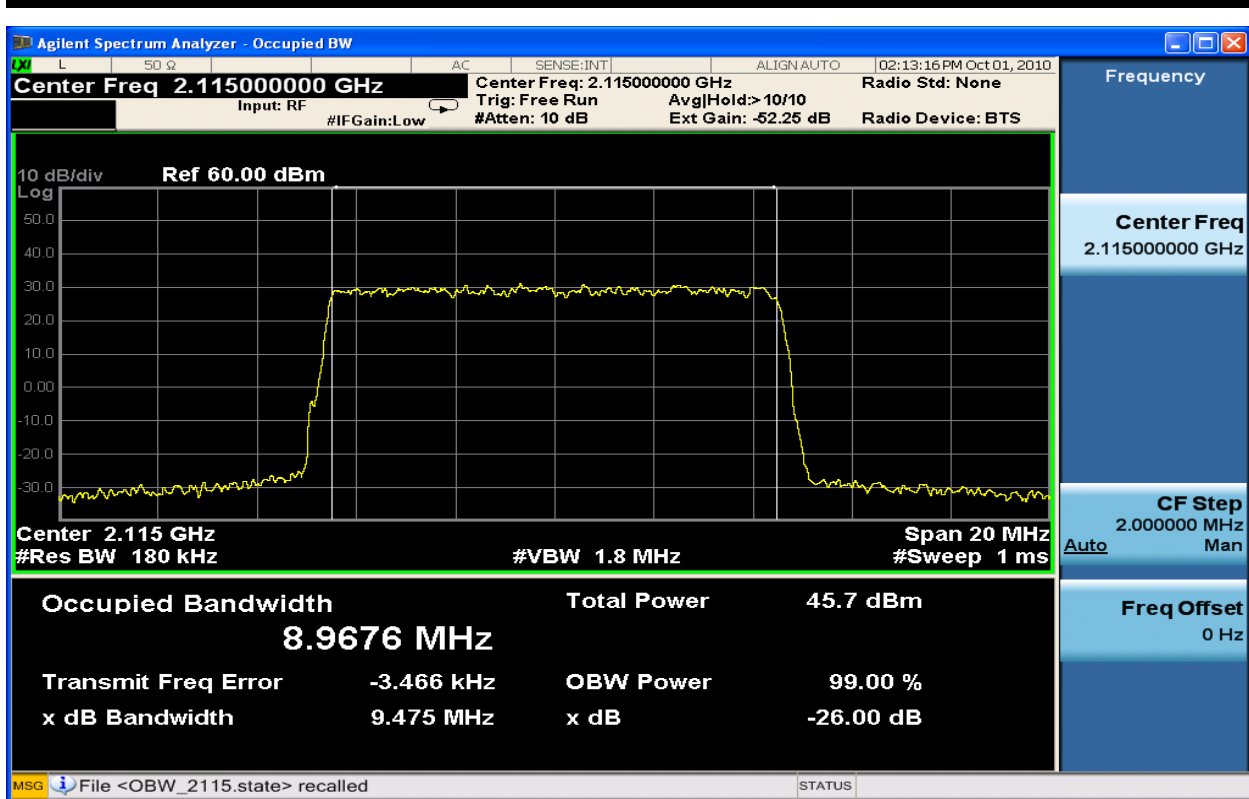

Figure 6-73: 10MHz Occupied Bandwidth TX1_64QAM at 2115.0 MHz

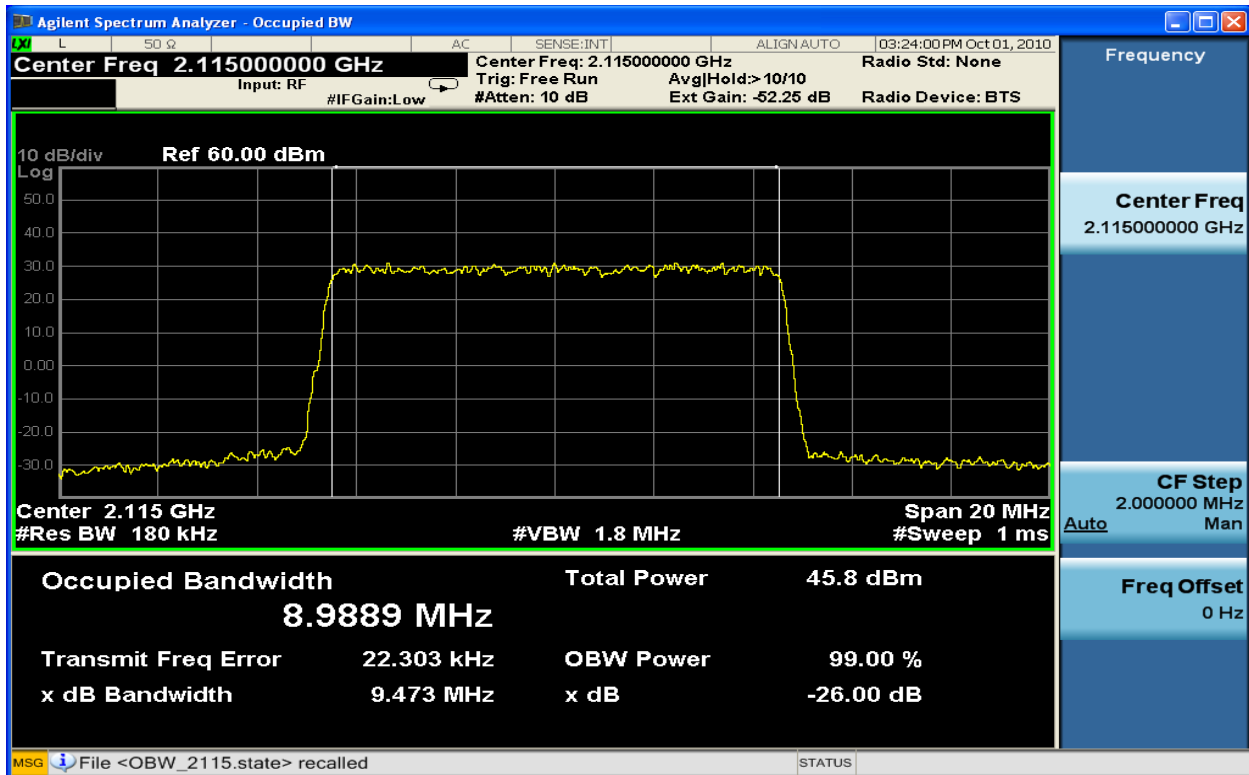

Figure 6-74: 10MHz Occupied Bandwidth TX2_64QAM at 2115.0 MHz

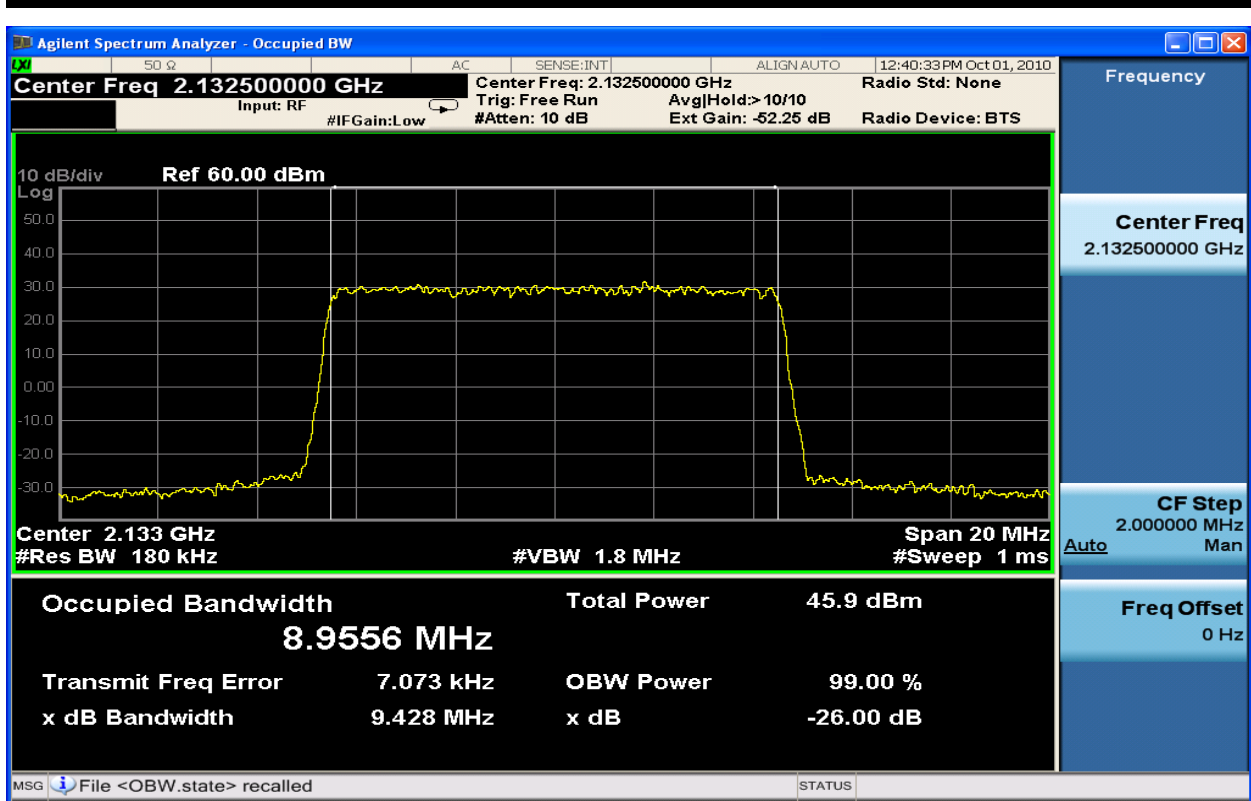

Figure 6-75: 10MHz Occupied Bandwidth TX1_QPSK at 2132.5 MHz

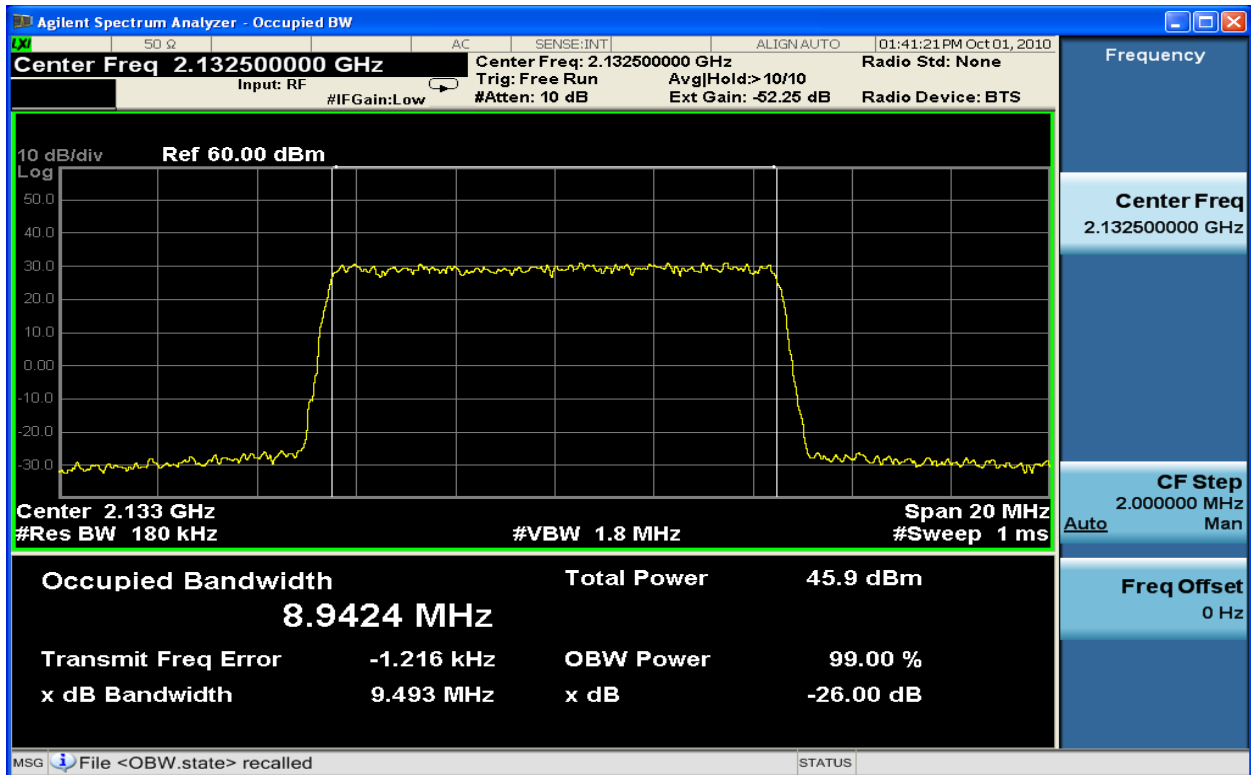

Figure 6-76: 10MHz Occupied Bandwidth TX2_QPSK at 2132.5 MHz

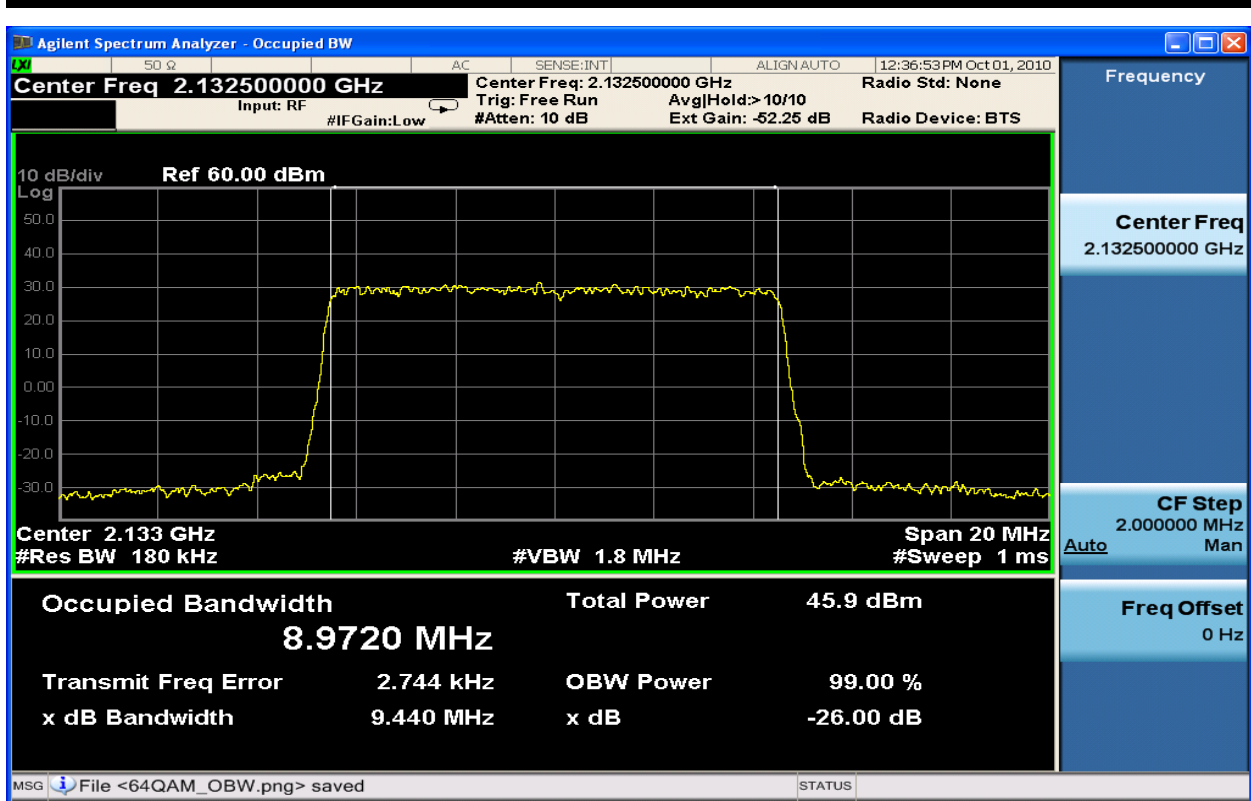

Figure 6-77: 10MHz Occupied Bandwidth TX1_16QAM at 2132.5 MHz

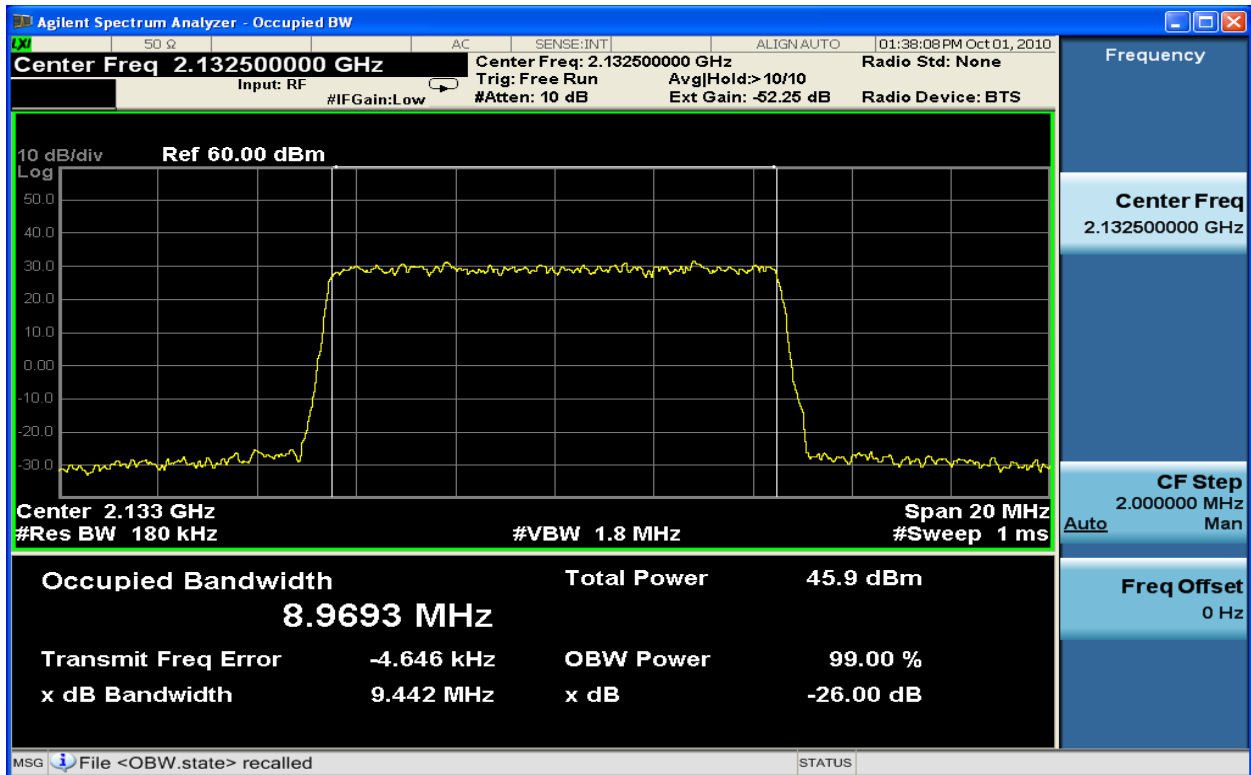

Figure 6-78: 10MHz Occupied Bandwidth TX2_16QAM at 2132.5 MHz

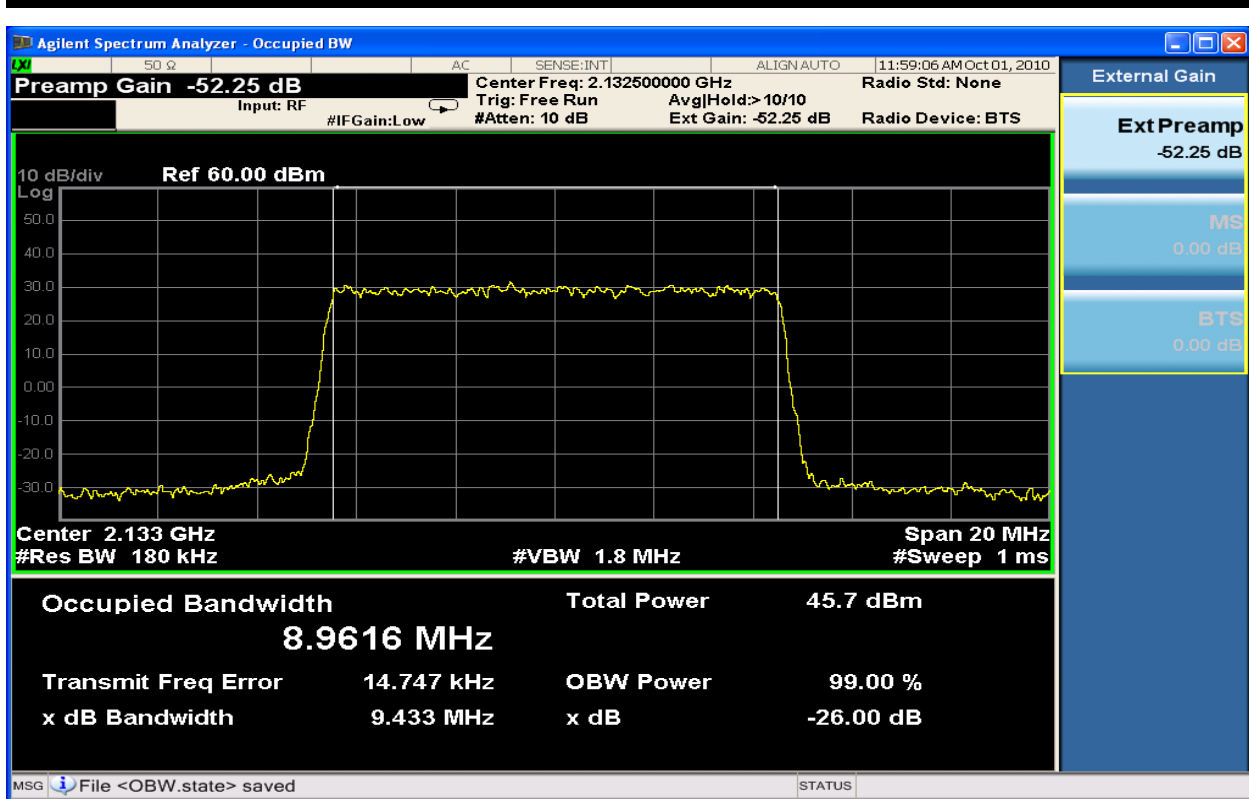

Figure 6-79: 10MHz Occupied Bandwidth TX1_64QAM at 2132.5 MHz

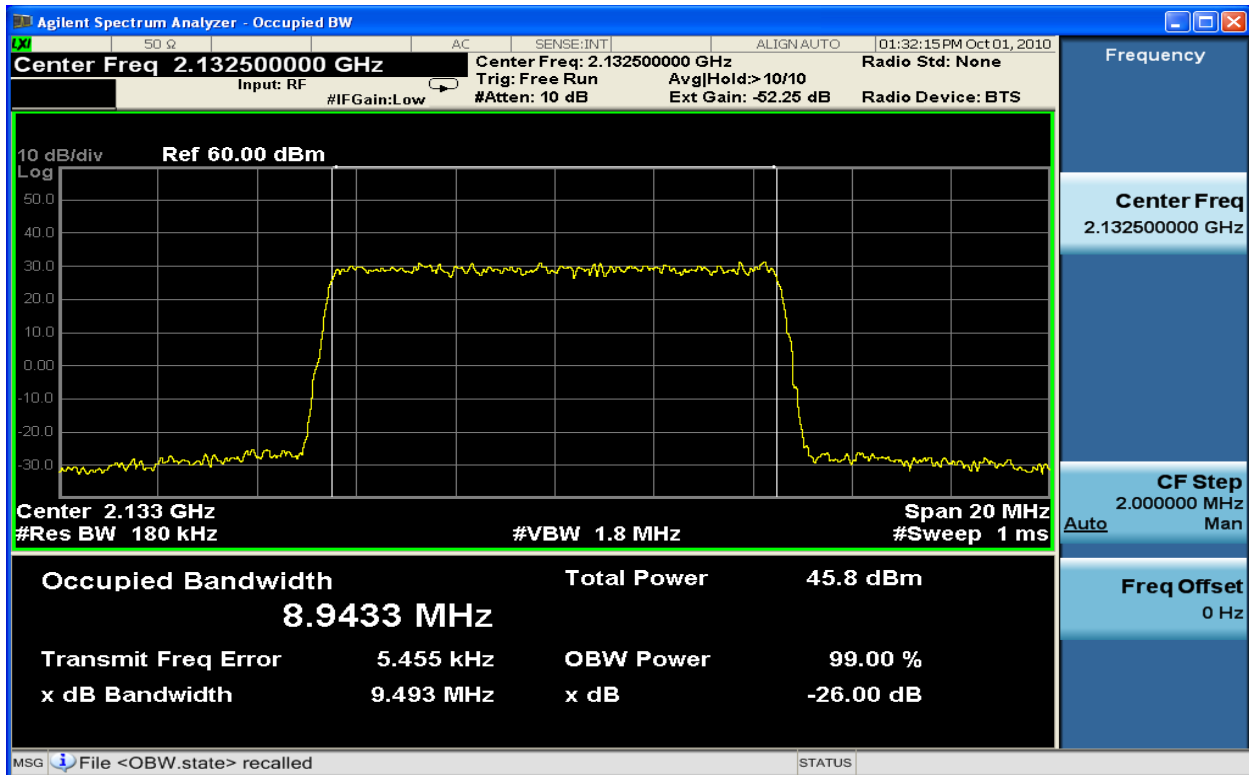

Figure 6-80: 10MHz Occupied Bandwidth TX2_64QAM at 2132.5 MHz

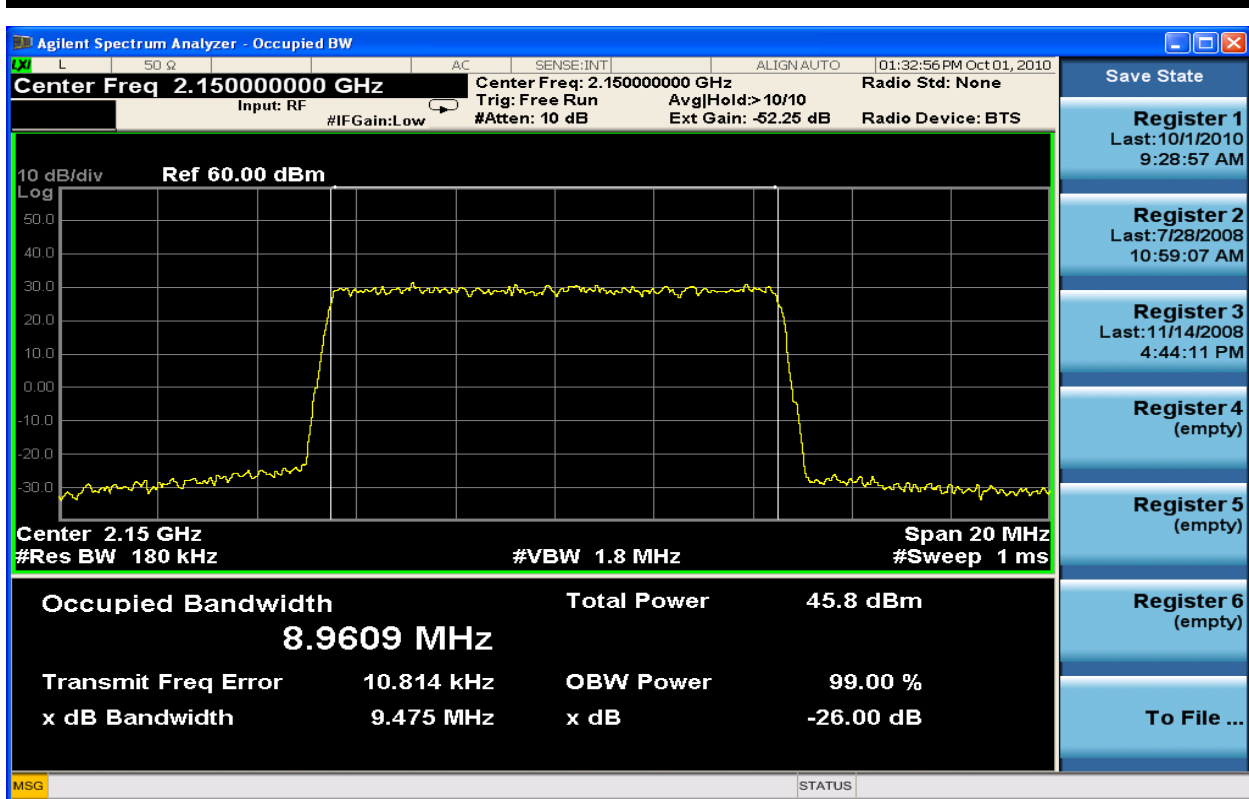

Figure 6-81: 10MHz Occupied Bandwidth TX1_QPSK at 2150.0 MHz

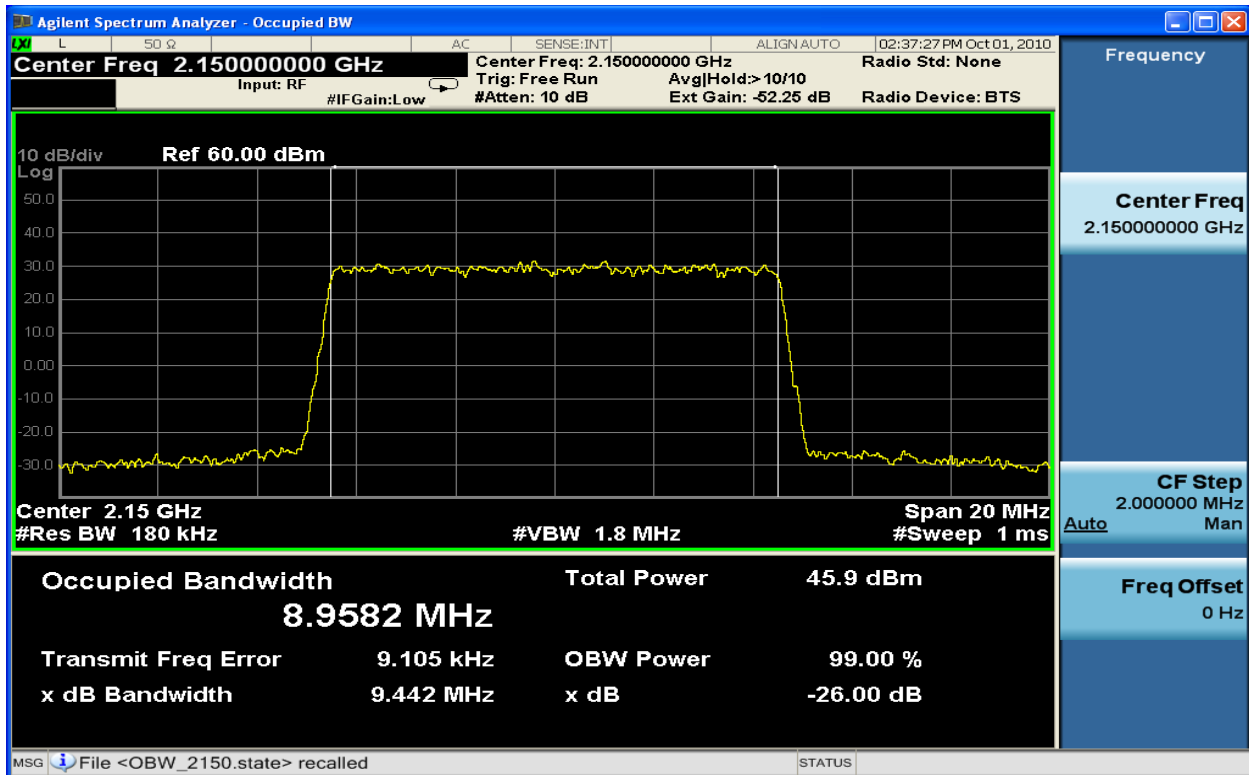

Figure 6-82: 10MHz Occupied Bandwidth TX2_QPSK at 2150.0 MHz

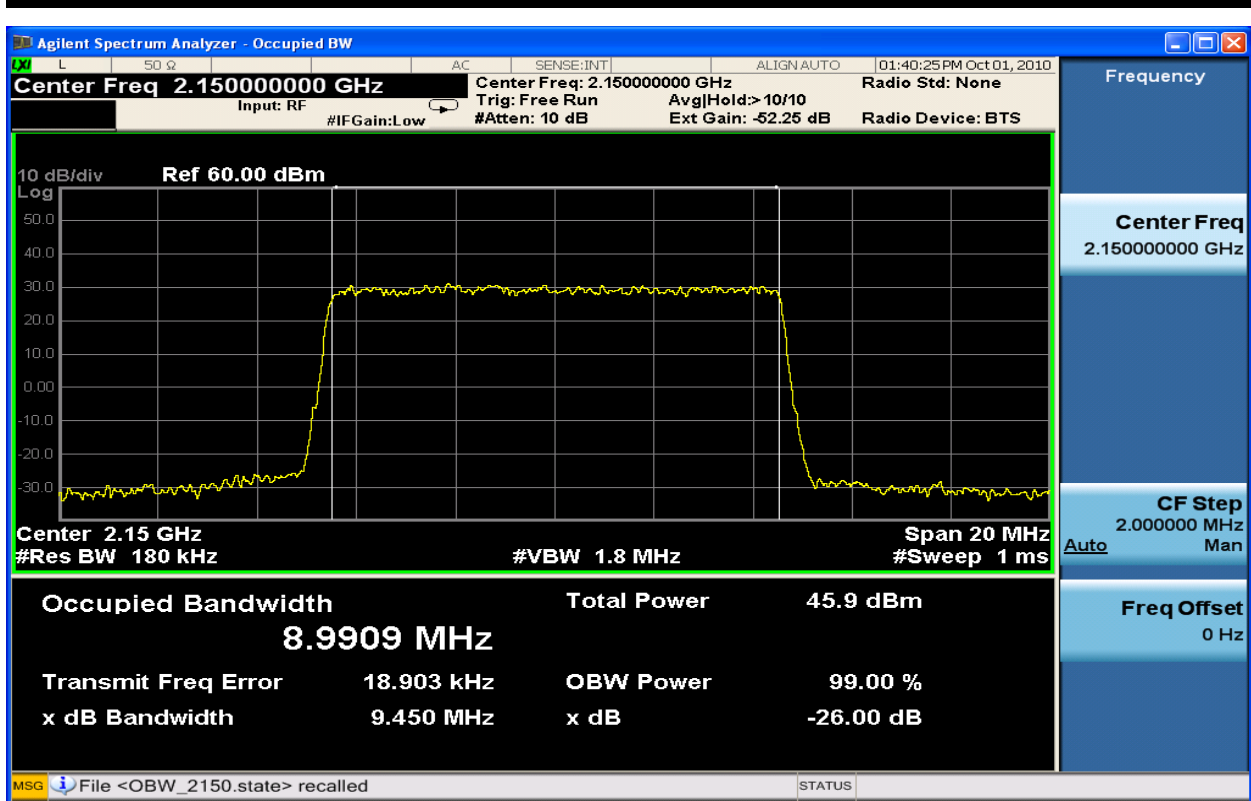

Figure 6-83: 10MHz Occupied Bandwidth TX1_16QAM at 2150.0 MHz

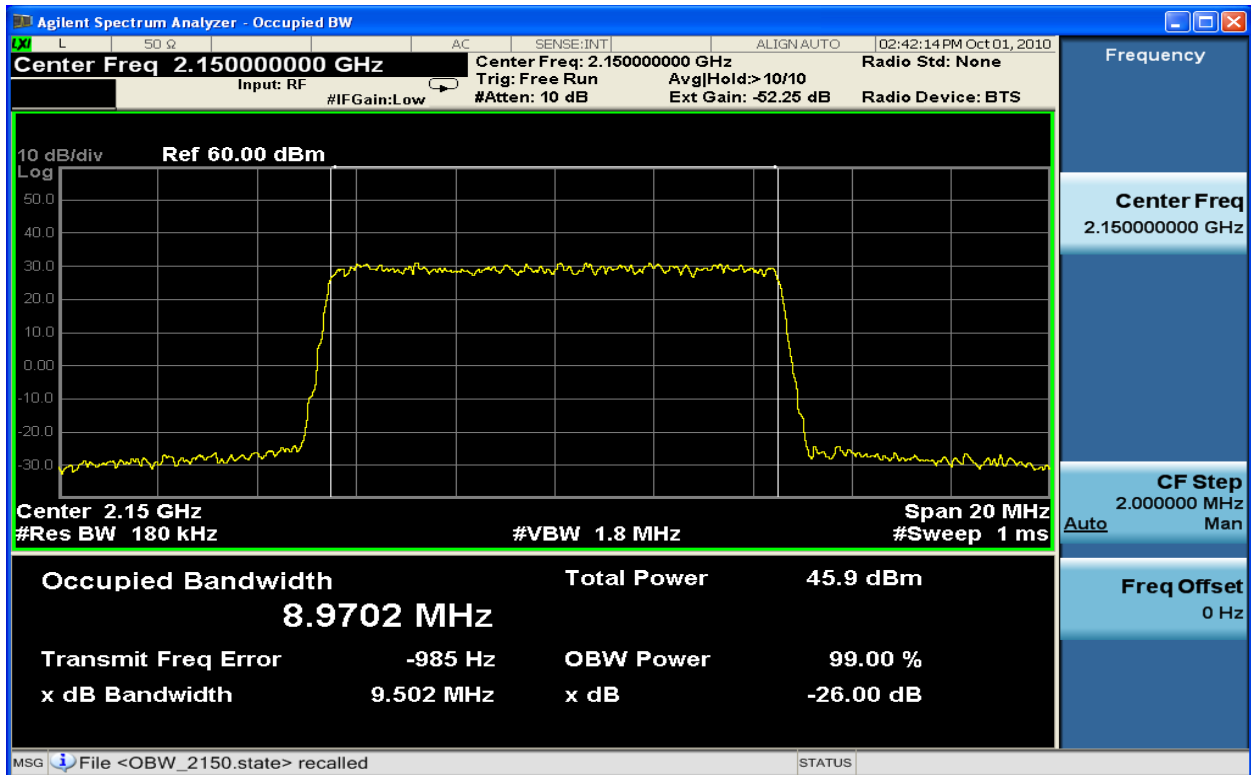

Figure 6-84: 10MHz Occupied Bandwidth TX2_16QAM at 2150.0 MHz

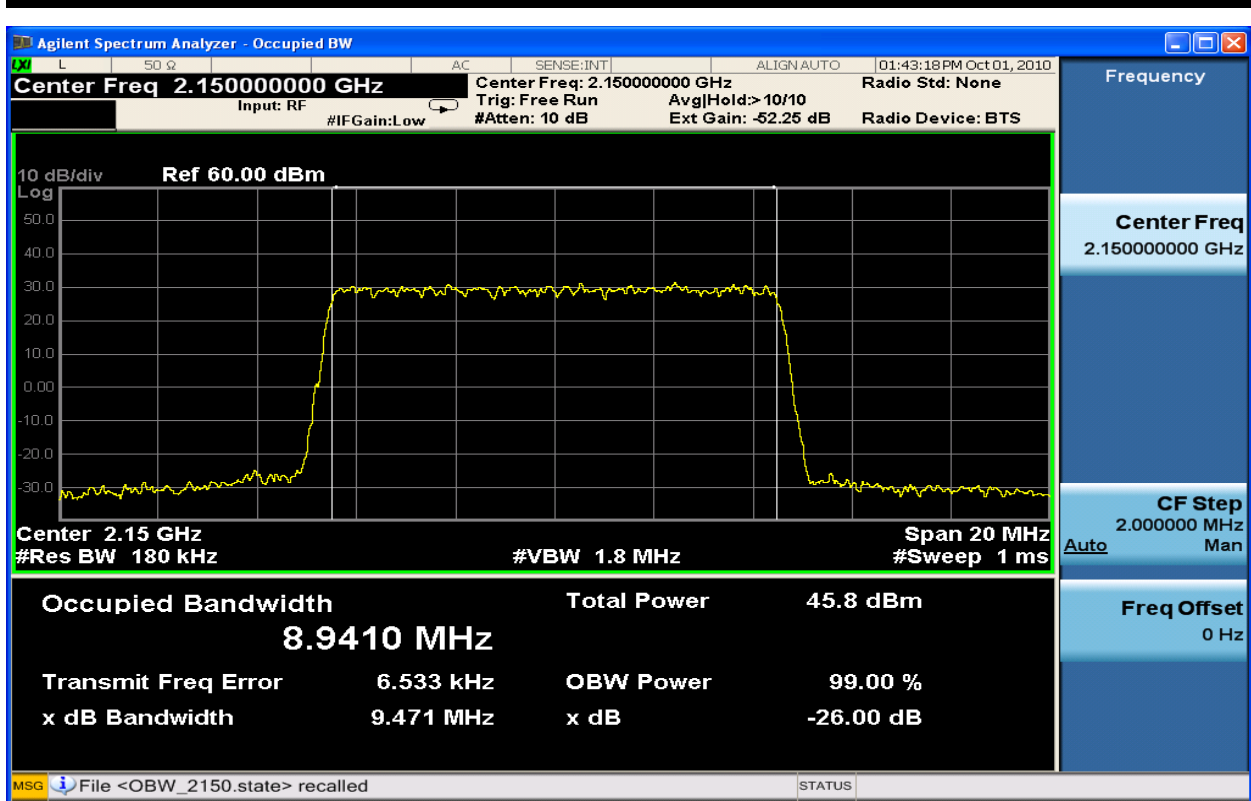

Figure 6-85: 10MHz Occupied Bandwidth TX1_64QAM at 2150.0 MHz

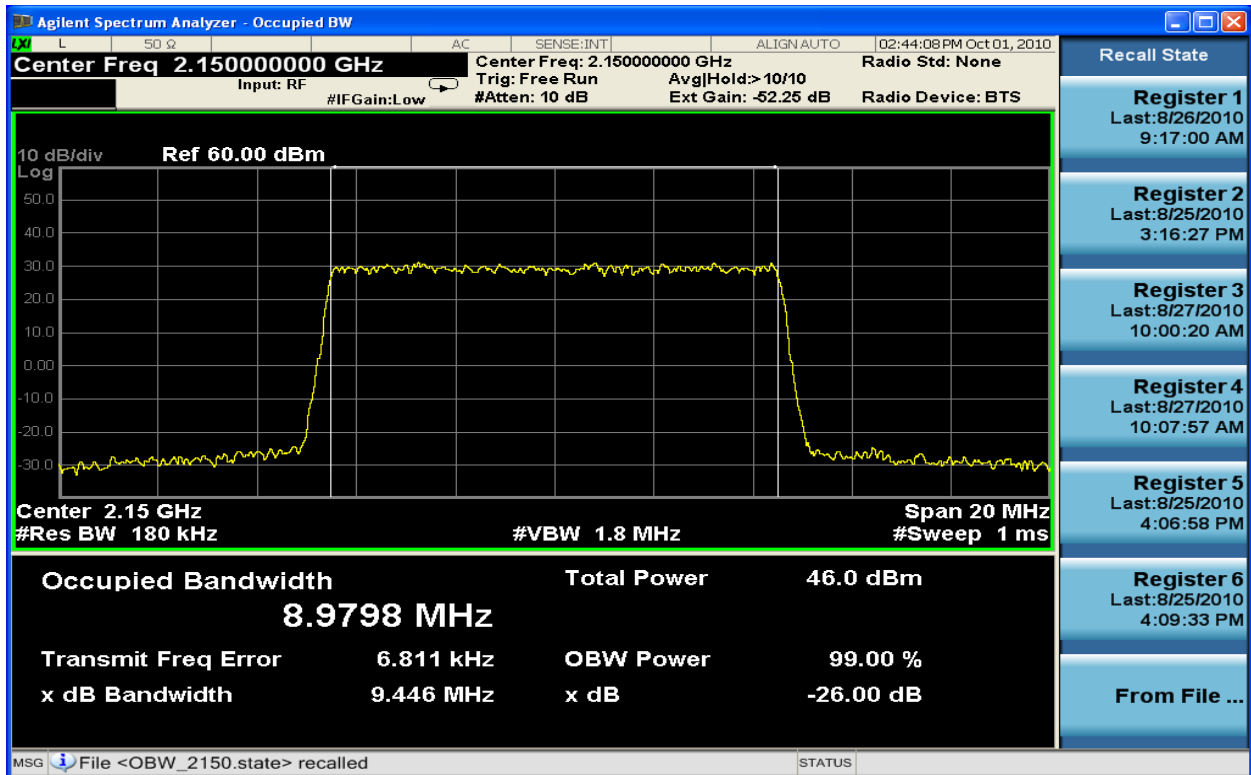

Figure 6-86: 10MHz Occupied Bandwidth TX2_64QAM at 2150.0 MHz

6.4 Spurious Emissions at the Antenna Terminal

Clause 27.53(h) 2.1051

(h) For operations in the 1710–1755 MHz and 2110–2155 MHz bands, the power of any emission outside a licensee’s frequency block shall be attenuated below the transmitter power (P) by at least $43 + 10 \log_{10}(P)$ dB.

(1) Compliance with this provision is based on the use of measurement instrumentation employing a resolution bandwidth of 1 megahertz or greater. However, in the 1 megahertz bands immediately outside and adjacent to the licensee’s frequency block, a resolution bandwidth of at least one percent of the emission bandwidth of the fundamental emission of the transmitter may be employed. The emission bandwidth is defined as the width of the signal between two points, one below the carrier center frequency and one above the carrier center frequency, outside of which all emissions are attenuated at least 26 dB below the transmitter power.

(2) When measuring the emission limits, the nominal carrier frequency shall be adjusted as close to the licensee’s frequency block edges, both upper and lower, as the design permits.

(3) The measurements of emission power can be expressed in peak or average values, provided they are expressed in the same parameters as the transmitter power.

(i) When an emission outside of the authorized bandwidth causes harmful interference, the Commission may, at its discretion, require greater attenuation than specified in this section.

Test Setup:

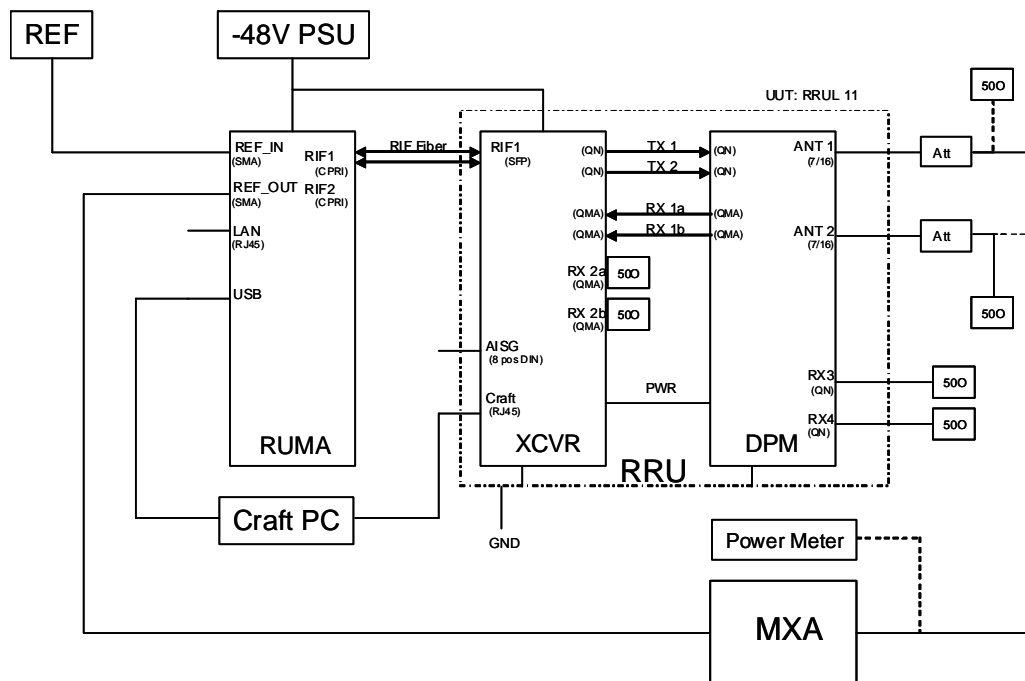

Figure 6-87 RRU Radio Compliance Set Up / Configuration

Procedure:

The following procedure and conditions shall apply for Spurious Emission measurements. As applicable, lower and high side offsets from the channel shall be assessed with respect to all modulation, and bandwidths as well as all emissions up to 26.5GHz. Results shall be compiled and recorded along with the relevant captured plots.

$$\text{FCC Limit} = \text{PWR (dBm)} - [43 + 10\log(\text{PWR (w)})] = 44.8 - 43 + 10\log(30) = -13\text{dBm}$$

Table 6-5: Setting / Measurement Results – Spurious Emissions Band Edge BW = 5MHz

Setting Measurement ACP < 2MHz		Spurious Emissions (dBm) FCC Limit -13dBm					
		QPSK		16 QAM		64 QAM	
		TX1	TX2	TX1	TX2	TX1	TX2
		Lower Edge Emission					
Frequency (Lower CH_1975)	2112.5MHz	-25.96	-26.72	-26.47	-25.84	-25.64	-25.89
Frequency (Middle CH_2175)	2132.5MHz	-26.35	-26.07	-25.93	-26.49	-26.50	-26.41
Frequency (Upper CH_2375)	2152.5MHz	-26.05	-26.05	-25.94	-26.08	-26.02	-26.14
		Upper Edge Emission					
Frequency (Lower CH_1975)	2112.5MHz	-28.65	-27.73	-29.23	-27.88	-28.78	-28.09
Frequency (Middle CH_2175)	2132.5MHz	-28.73	-29.11	-28.65	-28.71	-29.23	-28.63
Frequency (Upper CH_2375)	2152.5MHz	-29.54	-27.88	-28.33	-27.78	-28.63	-27.78
RBW (MBW=50/100kHz)	30kHz						
VBW	30kHz						
CH BW	5MHz	Lower Margin to FCC Limit (dB)					
Reference Level Offset	53.2dB	12.96	13.05	12.93	12.84	12.64	12.89
Detector	RMS	Upper Margin to FCC Limit (dB)					
Attenuation	6dB	15.65	14.73	15.33	14.78	15.63	14.78

Table 6-6: Setting / Measurement Results – Spurious Emissions Band Edge BW = 10MHz

Setting Measurement ACP < 2MHz		Spurious Emissions (dBm) FCC Limit -13dBm					
		QPSK		16 QAM		64 QAM	
		TX1	TX2	TX1	TX2	TX1	TX2
		Lower Edge Emission					
Frequency (Lower CH_2000)	2115.0MHz	-29.82	-29.96	-30.02	-30.07	-30.37	-30.42
Frequency (Middle CH_2175)	2132.5MHz	-30.33	-29.71	-29.92	-29.72	-30.38	-30.59
Frequency (Upper CH_2350)	2150.0MHz	-29.90	-29.22	-29.49	-29.35	-29.46	29.18
		Upper Edge Emission					
Frequency (Lower CH_2000)	2115.0MHz	-32.28	-30.90	-31.79	-30.53	-32.08	-30.49
Frequency (Middle CH_2175)	2132.5MHz	-32.15	-30.88	-31.74	-30.94	-32.14	-30.56
Frequency (Upper CH_2350)	2150.0MHz	-31.86	-29.91	-31.67	-29.49	-31.43	-29.82
RBW (MBW=100kHz)	30kHz						
VBW	30kHz						
CH BW	10MHz	Lower Margin to FCC Limit (dB)					
Reference Level Offset	53.2dB	16.82	16.22	16.49	16.35	16.46	16.18
Detector	RMS	Upper Margin to FCC Limit (dB)					
Attenuation	6dB	18.86	16.91	18.67	16.49	18.43	16.82

Table 6-7: Setting / Results – BW = 5MHz, Spurious Emissions 30MHz - 26.5GHz

Setting Measurement 30MHz – 26.5GHz		Spurious Emissions (dBm) FCC Limit -13dBm				
		64 QAM				
		TX1	TX2			
Frequency (Lower CH_1975)	2112.5MHz	All emissions were below MXA noise floor				
Frequency (Upper CH_2375)	2152.5MHz	All emissions were below MXA noise floor				
RBW	3.0MHz					
VBW						
CH BW	5MHz					
Reference Level Offset	53.2 dB					
Detector	RMS	Margin to FCC Limit (dB)				
Attenuation	6dB	> 8.0dB				

Table 6-8: Setting / Results – BW = 10MHz, Spurious Emissions 30MHz – 26.5GHz

Setting Measurement 30MHz – 26.5GHz		Spurious Emissions (dBm) FCC Limit -13dBm				
		64 QAM				
		TX1	TX1			
Frequency (Lower CH_2000)	2115.0MHz	All emissions were below MXA noise floor				
Frequency (Upper CH_2350)	2150.0MHz	All emissions were below MXA noise floor				
RBW	3.0MHz					
VBW						
CH BW	10MHz					
Reference Level Offset	53.2dB					
Detector	RMS	Margin to FCC Limit (dB)				
Attenuation	6dB	> 8.0dB				

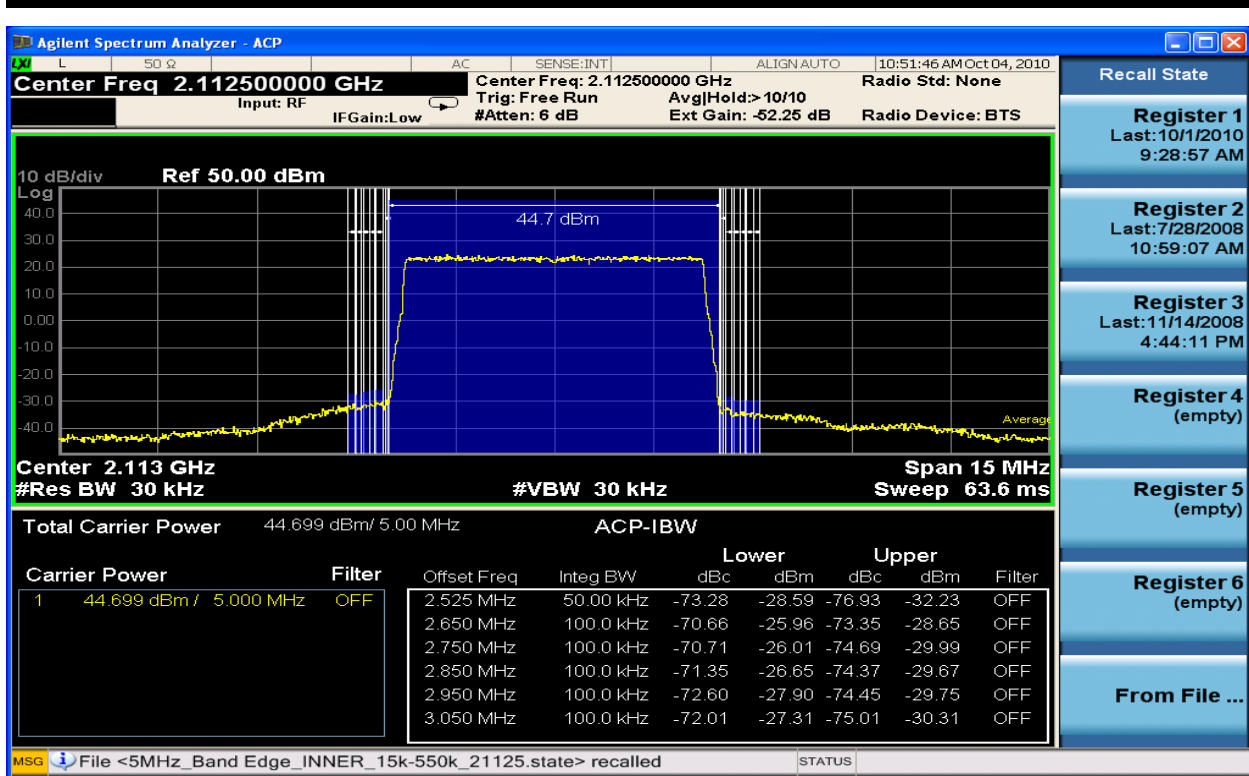

Figure 6-88 Spurious Emissions 2112.5MHz TX1_QPSK 5MHz Band Edge (ACP 15kHz – 550kHz)

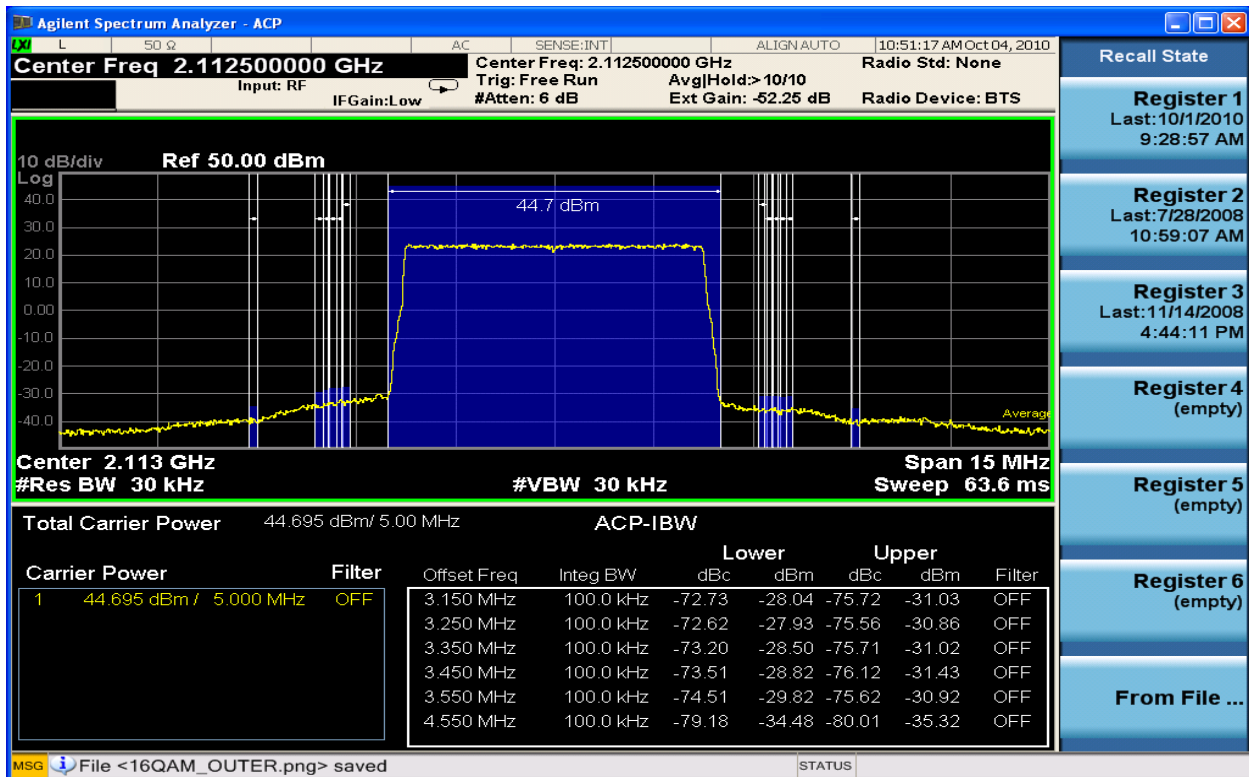

Figure 6-89 Spurious Emissions 2112.5MHz TX1_QPSK 5MHz Band Edge (ACP 650kHz – 2MHz)

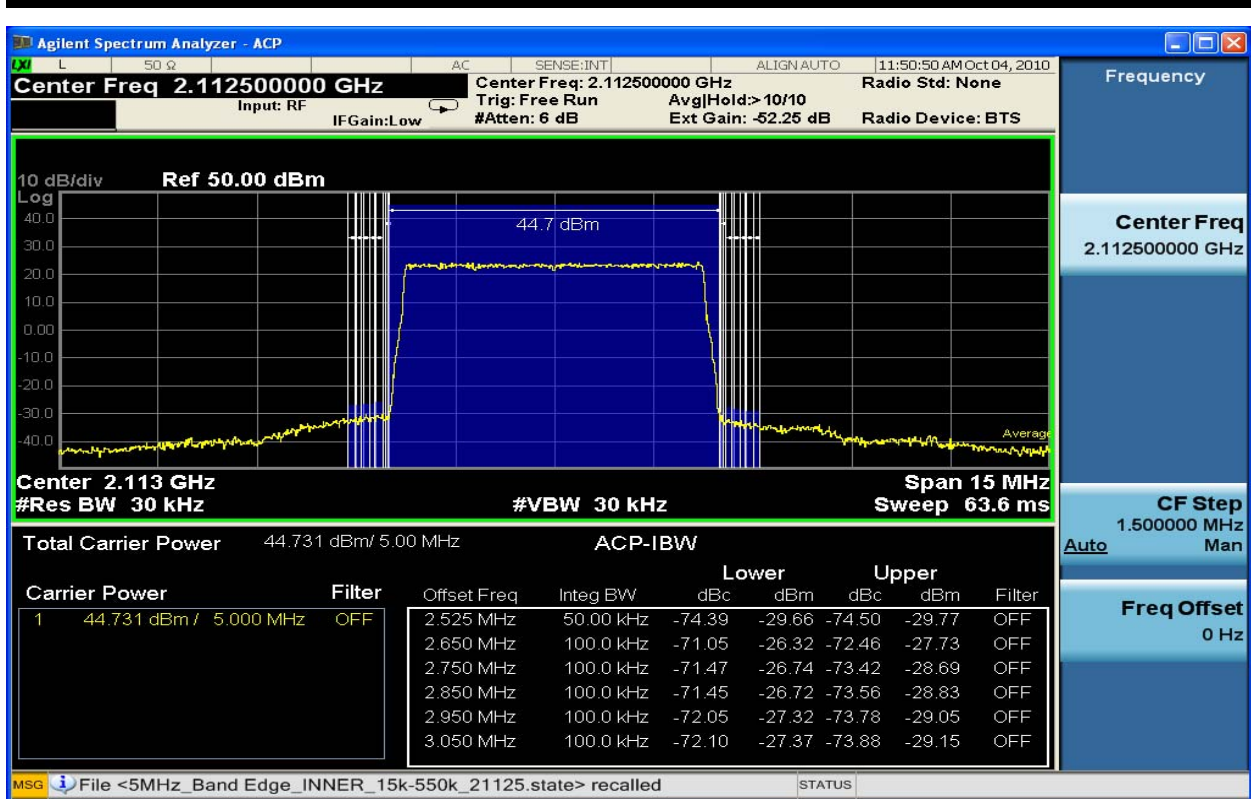

Figure 6-90 Spurious Emissions 2112.5MHz TX2_QPSK 5MHz Band Edge (ACP 15kHz – 550kHz)

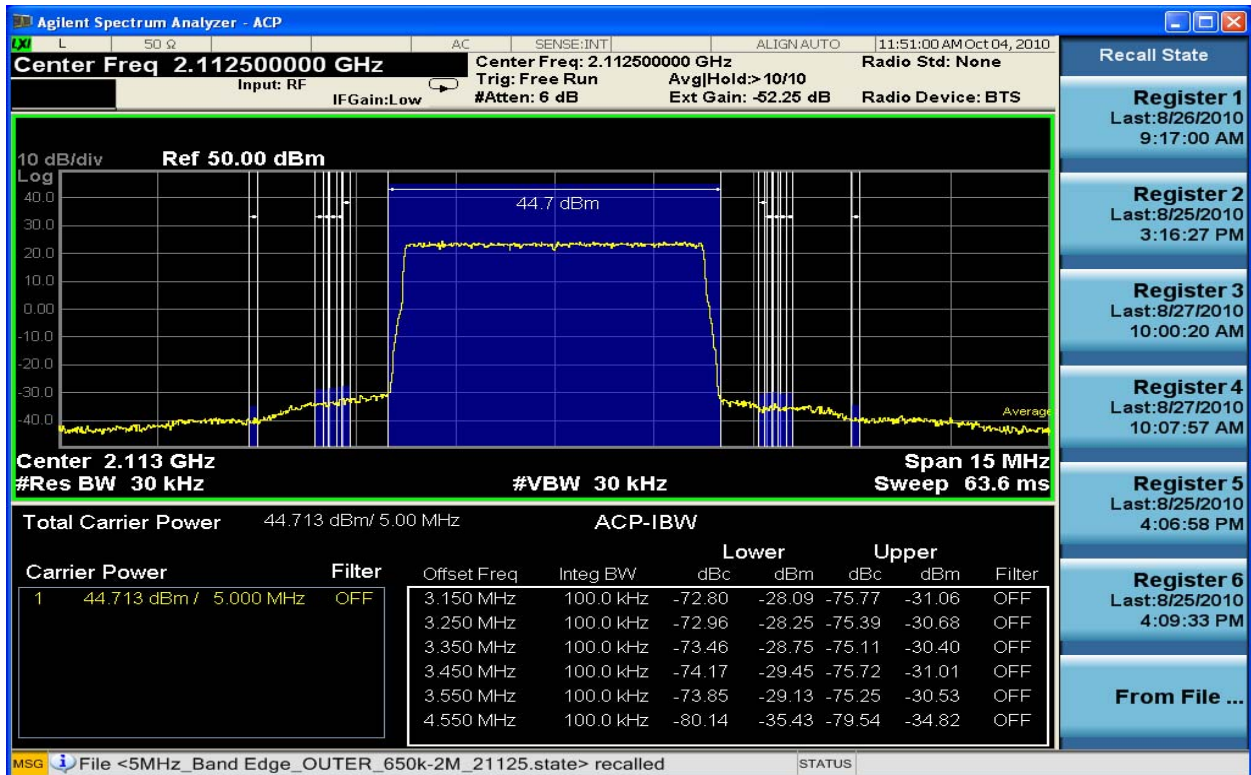

Figure 6-91 Spurious Emissions 2112.5MHz TX2_QPSK 5MHz Band Edge (ACP 650kHz – 2MHz)

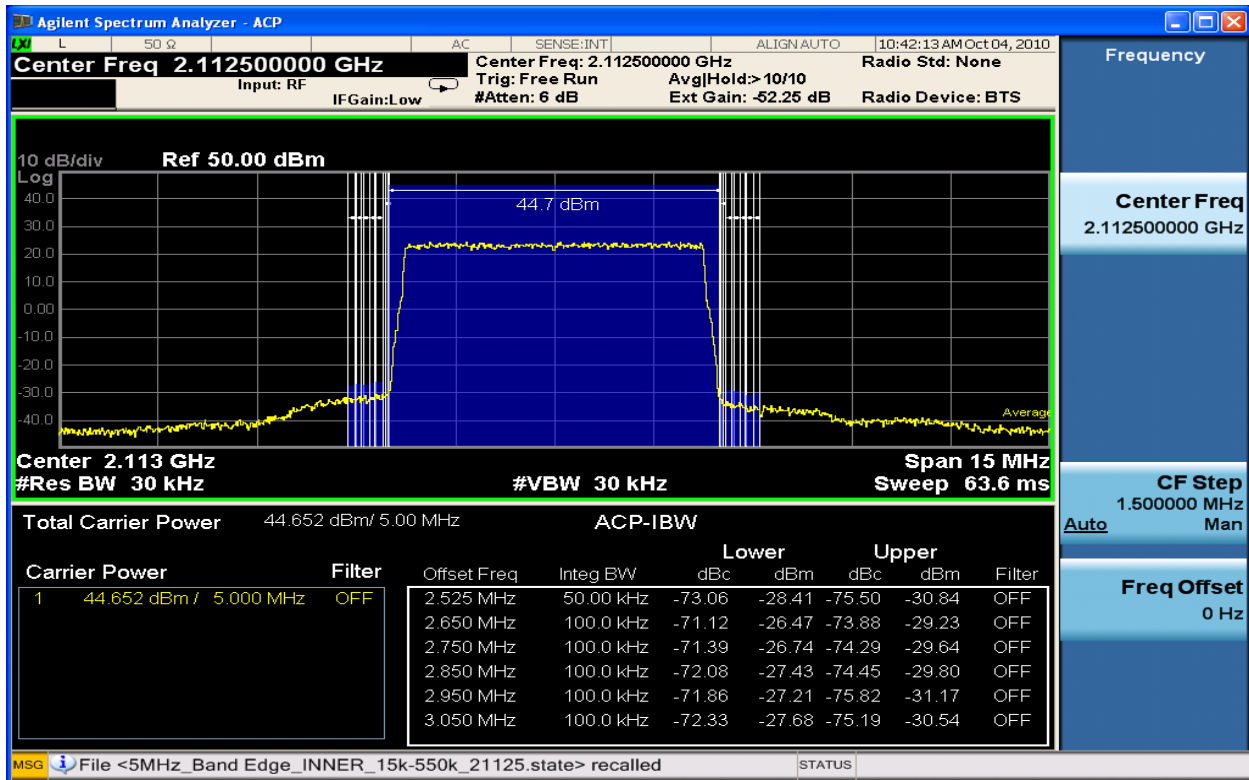

Figure 6-92 Spurious Emissions 2112.5MHz TX1_16QAM 5MHz Band Edge (ACP 15kHz – 550kHz)

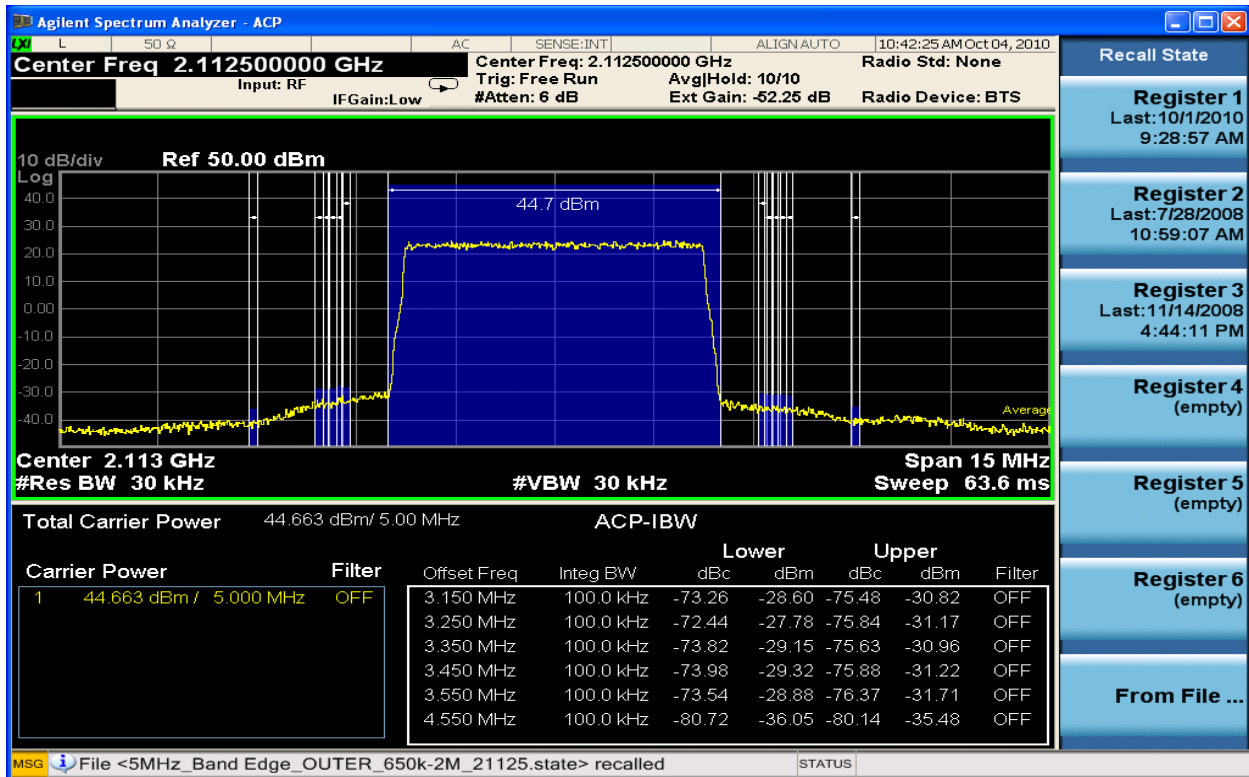

Figure 6-93 Spurious Emissions 2112.5MHz TX1_16QAM 5MHz Band Edge (ACP 650kHz – 2MHz)