

M12 2.4GHZ FH4T RADIO CONTROL SYSTEM USER'S GUIDE

F/S (FAIL SAFE)

SETUP

Choosing Fail Safe Settings:

- 1) From within the SETUP menu, scroll UP or DOWN to highlight the F/S menu.
- 2) Press the ENTER key to open the F/S menu. ST > FREE will be highlighted.
- 3) Scroll UP or DOWN to highlight the desired channel you would like to change the Fail Safe value for.
- 4) Press the ENTER key, then scroll UP or DOWN to choose the desired Fail Safe value for that channel. If you choose to program a % value, see step 5 below.

F/S setting range is FREE, HOLD or %. The default setting for all channels is FREE.

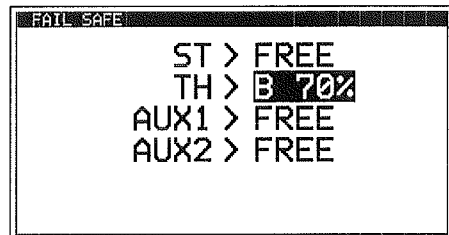
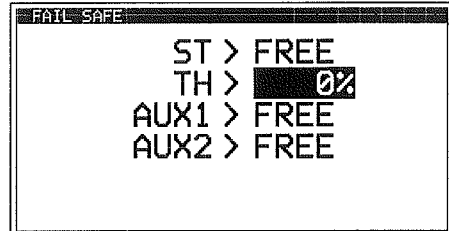
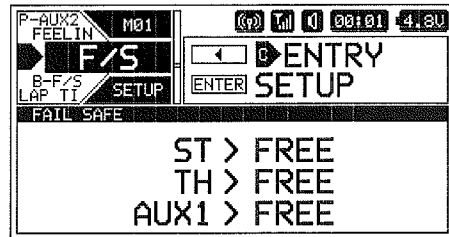

- 5) To program a Fail Safe % value, move the transmitter control (e.g., Throttle Trigger) the desired amount, then press and HOLD the ENTER key until an audible Tone sounds. The direction and percentage the servo will travel will be displayed. For example, to set the Brakes to Engage when the Fail Safe function Activates, push the Throttle Trigger toward the Brake Side the desired amount, HOLD the Throttle Trigger in that position, then press and HOLD the ENTER key.

- 6) Check to ensure your Fail Safe settings are working properly. Make sure that both the transmitter and receiver are turned ON, then, while someone is holding your Model, turn the transmitter OFF. The servos should react correctly based on the Fail Safe values chosen.

⚠ When using an FH2 receiver with your transmitter, these Fail Safe features are not supported. In this case, the Fail Safe function must be programmed directly through the receiver. For more information, follow the Fail Safe Programming instructions provided with your FH2 receiver.

⚠ If using a Car Type that features two Steering channels or two Throttle channels (like a Rock Crawler) and you're programming a Fail Safe % value, we suggest setting one of the Steering or Throttle channels to FREE and the other Steering or Throttle channels to the desired Fail Safe % value. This will ensure one of the channels won't be fighting the other duplicate channel should the Fail Safe function Activate.

B-F/S (RECEIVER BATTERY VOLTAGE FAIL SAFE)

SETUP

The Receiver Battery Voltage Fail Safe function is designed to alert you when your receiver battery requires recharging. This ensures that the receiver battery's voltage doesn't drop so low that your servos aren't provided adequate voltage to operate optimally. When Activated, the servo(s) will move to the predetermined position that you programmed in step 5 in the *Choosing Fail Safe Settings* section to indicate your receiver battery's voltage has dropped below the programmed Voltage value.

When used with an FH4 or FH4T receiver, the Receiver Battery Voltage Fail Safe function can be Activated for all four channels independently. When used with an FH3 receiver, the Receiver Battery Voltage Fail Safe function can be Activated only for the Throttle channel. The Receiver Battery Voltage Fail Safe function cannot be used with FH2 receivers.

WARNING: This function is designed for use with glow- or gas-powered Models that use a separate receiver battery pack. Do NOT use this function with an electric Model that uses the motor battery to power the servos and receiver.

Choosing the Receiver Battery Voltage Value:

- 1) From within the SETUP menu, scroll UP or DOWN to highlight the B-F/S menu.

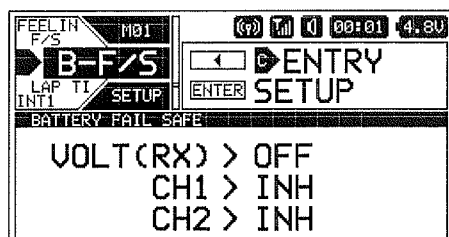

M12 2.4GHZ FH4T RADIO CONTROL SYSTEM USER'S GUIDE

B - F / S (RECEIVER BATTERY VOLTAGE FAIL SAFE)

SETUP

Choosing the Receiver Battery Voltage Value, Continued....

2) Press the ENTER key to open the B-F/S menu. VOLT (RX) > OFF will be highlighted.

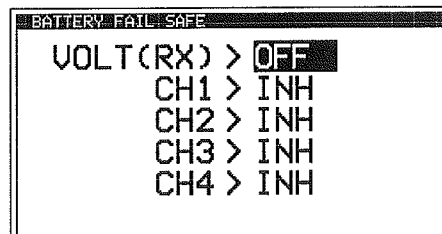

3) Press the ENTER key, then scroll UP or DOWN to choose the desired Receiver Battery Voltage value. Many factors, such as the current draw of your servos and how many servos you're using, etc., will determine the value to use. A good starting point would be 3.7V. If it appears your servos are slow or not producing adequate torque what that Voltage value is reached, increase the Voltage value.

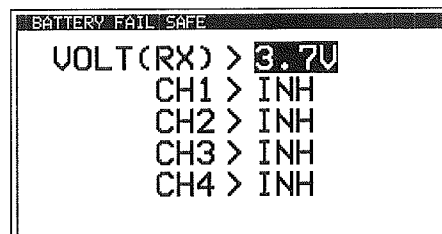

VOLT (RX) setting range for FH4 and FH4T receivers is OFF and 3.5V to 7.4V. VOLT (RX) setting range for FH3 receivers is OFF and 3.5V to 5.0V. The default setting is OFF regardless of the Modulation Type chosen. Use with FH2 receivers is not supported.

Activating the Receiver Battery Voltage Fail Safe Function:

The Receiver Battery Fail Safe function can be Activated for one or more channels, however, in most cases you will want to Activate this function only for the Throttle channel. When Activated, the Throttle servo will move to the predetermined position that you programmed in step 5 in the *Choosing Fail Safe Settings* section to indicate your receiver battery's voltage has dropped below the programmed Voltage value. When this happens, stop using your Model and recharge the receiver battery.

! A % value must be Selected to be able to Activate the Receiver Battery Voltage Fail Safe function. If FREE or HOLD is Selected for any of the channels, you cannot Activate the Receiver Battery Voltage Fail Safe function.

- 1) From within the B-F/S menu, scroll UP or DOWN to highlight desired channel number you want to Activate the Receiver Battery Voltage Fail Safe function for.
- 2) Press the ENTER key, then scroll UP or DOWN to choose the desired Battery Fail Safe value, either ACT or INH.
- 3) Press the ENTER key, then repeat steps 1 and 2 to change any other desired Battery Fail Safe values.

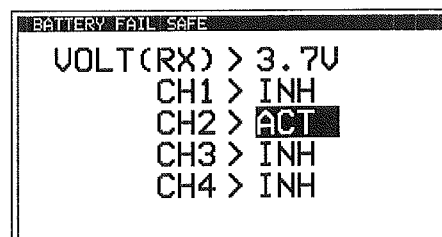

CH1, CH2, CH3 and CH4 setting range is INH and ACT. The default setting for all channels is INH.

LAP TIMER MENU (VIEW LAP TIMES AND CHOOSE LAP TIMER OPTIONS)

SETUP

The Lap Timer function allows you to measure and record Lap Times for up to 250 Laps. The total number of Laps, the Current Lap Time, the Best Lap Time and the Average Lap Time are all displayed. After the Lap Timer is Stopped, the Cumulative Time will be displayed. Lap Times are displayed in the following format: 00:00.00 (Minutes : Seconds : 1/100th of a Second).

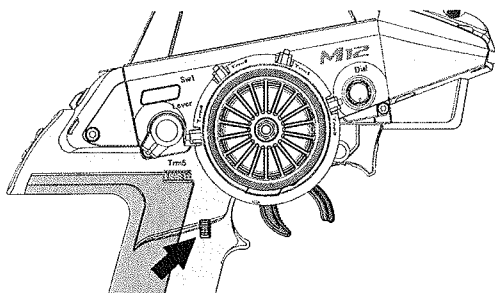

In addition to being able to view Lap Times, a Goal Time function is featured that will sound when you reach your Goal Time. For example, you can set the Goal Time value to the total time you would like to finish your race under. If desired, a Pre-Alarm function can be programmed to Alert you to your upcoming Goal Time.

Lap Times can be viewed within the LAP TIMER menu or on the TELEMETRY screen ALL and LAP pages. In addition, a pop-up window will display when the Lap Timer Starts and Stops, and each time a Lap Time is counted.

In the default configuration, placing the Lap Timer in Standby, Starting and Stopping the Lap Timer, and counting Lap Times, is controlled using the Lap Timer Switch (Push-Button Switch Sw3). In addition, if desired, the Throttle Trigger can be used to Start the Lap Timer after it's been placed in Standby.

M12 2.4GHZ FH4T RADIO CONTROL SYSTEM USER'S GUIDE

LAP TIMER MENU (VIEW LAP TIMES AND CHOOSE LAP TIMER OPTIONS)

SETUP

Setting the Goal Time:

When the Lap Timer is counting Up, a long audible Tone will sound when the Goal Time is reached. For example, if you set the Goal Time value for 5 Minutes, a long audible Tone will sound when the Lap Timer reaches 5 minutes.

⚠ When the Goal Time is reached the Lap Timer will continue counting Up, but you will no longer be able to continue counting Lap Times. The next time you press the Lap Timer Switch, the Lap Timer will Stop.

1) From within the SETUP menu, scroll UP or DOWN to highlight the LAP TIMER menu.

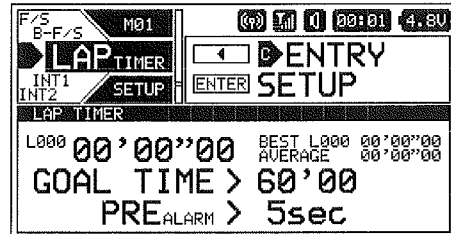

2) Press the ENTER key to open the LAP TIMER menu. GOAL TIME > 60'00 will be highlighted.

3) Press the ENTER key, then scroll UP or DOWN to choose the desired Goal Time value in Minutes : Seconds.

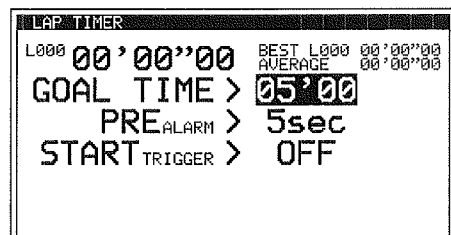

GOAL TIME setting range is 10 Seconds to 60 Minutes (00'10 to 60'00) and is adjustable in 10 second intervals. The default setting is 60 Minutes.

Setting the Pre-Alarm Time:

The Pre-Alarm function is used to alert you that your Goal Time is approaching. You can program the Pre-Alarm to sound once every second the desired number of seconds prior to reaching your Goal Time. For example, if the Pre-Alarm value is set to 5 Seconds, a short audible Tone will sound every second, 5 seconds prior to reaching your Goal Time. If desired, the Pre-Alarm value can be set to OFF to turn the Pre-Alarm OFF.

1) From within the LAP TIMER menu, scroll UP or DOWN to highlight PREALARM > 5sec.

2) Press the ENTER key, then scroll UP or DOWN to choose the desired Pre-Alarm value in Seconds.

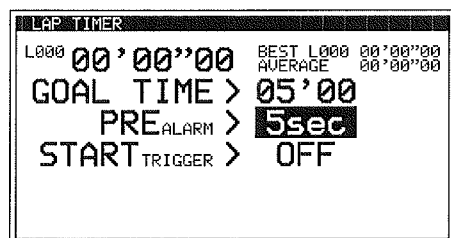

PREALARM setting range is OFF and 1 to 20 Seconds. The default setting is 5 Seconds.

Choosing the Optional Throttle Trigger Start:

The Throttle Trigger can be used to Start the Lap Timer after the Lap Timer as been placed in Standby. This is much more convenient than worrying about pressing the Lap Timer Switch again to Start the Lap Timer when you're starting your race.

1) From within the LAP TIMER menu, scroll UP or DOWN to highlight STARTTRIGGER > OFF.

2) Press the ENTER key, then scroll UP or DOWN to choose the desired Start Trigger value, either ON or OFF.

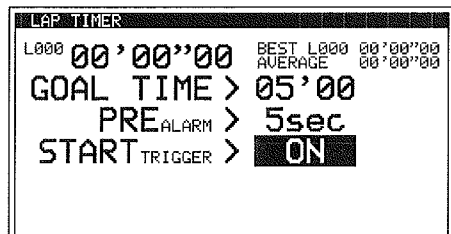

STARTTRIGGER setting range is OFF and ON. The default setting is OFF.

Starting the Lap Timer and Counting Lap Times:

1) In the default configuration, the Lap Timer Switch (Push-Button Switch Sw3) controls the Lap Timer. Press and HOLD the Lap Timer Switch for 3 seconds. An audible Double-Tone will sound and LAP [STANDBY] will be displayed momentarily in a pop-up window, indicating the Lap Timer is in Standby. To start the Lap Timer, press the Lap Timer Switch a second time or pull the Throttle Trigger if you've Enabled the Start Trigger function. An audible Double-Tone will sound and the Lap Timer will start counting Up.

2) Press the Lap Timer Switch a second time to store the first Lap Time and begin counting a second Lap Time. Each time you press the Lap Timer Switch, an audible Tone sounds, the previous Lap Time is stored, a new Lap Time begins and the current Lap Time is displayed momentarily in a pop-up window.

M12 2.4GHZ FH4T RADIO CONTROL SYSTEM USER'S GUIDE

LAP TIMER MENU (VIEW LAP TIMES AND CHOOSE LAP TIMER OPTIONS)

SETUP

Stopping the Lap Timer:

- 1) To Stop the Lap Timer, press and HOLD the Lap Timer Switch for 3 seconds. An audible Double-Tone will sound and LAP [STOPPED] will be displayed momentarily in a pop-up window, indicating the Lap Timer is stopped.

⚠ The Cumulative Time cannot be manually cleared. It will be automatically cleared when the Lap Timer is put in Standby again.

Viewing Lap Times:

The Cumulative Lap Time, the Best Lap Time and the Average Lap Time, in addition to up to 250 individual Lap Times can be viewed on the TELEMETRY screen LAP page.

- 1) From the STATUS screen, scroll UP or DOWN to open the TELEMETRY screen. Press the SELECT switch Right or Left to open the LAP page.
- 2) Press the ENTER key, then scroll UP or DOWN to view the individual Lap Times.

⚠ Lap Times are stored until you Restart the Lap Timer. When the Lap Timer is Restarted, old Lap Times are Cleared and new Lap Times are Stored.

INT1 AND INT2 MENU (INTERVAL 1 AND INTERVAL 2 TIMERS)

SETUP

The Interval Timer function is used to notify you when a set Interval elapses while you're driving. When the Interval Time is reached, an audible Double-Tone will sound, then the Interval Timer will Reset and begin counting Up again from zero. Interval Times are displayed in the following format: 00:00".00 (Minutes : Seconds : 1/100th of a Second). The Interval Timer can be programmed to work independently or programmed to work along with the Lap Timer function.

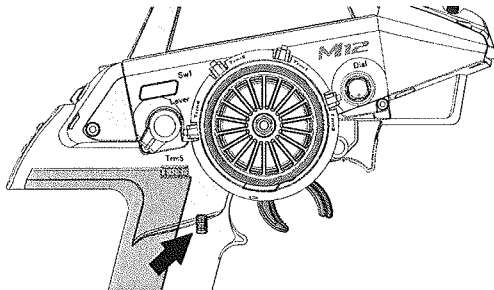

There are two Interval Timers. These Interval Timers can be Started and Stopped independently by Assigning each one to a different Push-Button Switch or they can be Started and Stopped simultaneously by Assigning both of them to the same Push-Button Switch. If desired, different Tones can be Assigned to each Interval Timer to differentiate them and the Throttle Trigger can be programmed to Start the Interval Timer(s).

In the default configuration, Interval Timer 1 is Started and Stopped along with the Lap Timer, using the Lap Timer Switch (Push-Button Switch Sw3).

⚠ This section covers both the INT1 and INT2 menus, since programming each of them is exactly the same. Choose either the INT1 or the INT2 menu depending on which of the two Interval Timers you want to program.

Setting the Interval Timer:

- 1) From within the SETUP menu, scroll UP or DOWN to highlight either the INT1 or the INT2 menu depending on which Interval Timer you want to program. In this section, we show programming Interval Timer 1.
- 2) Press the ENTER key to open the INT1 menu. INTERVAL > 00' will be highlighted.
- 3) Scroll UP or DOWN to highlight the desired Interval Timer value you would like to change, either 00' (Minutes) , 00" (Seconds) or 00 (1/100th Seconds).
- 4) Press the ENTER key, then scroll UP or DOWN to choose the desired Interval Timer value.
- 5) Press the ENTER key again, then repeat steps 3 and 4 to change any other desired Interval Timer values.

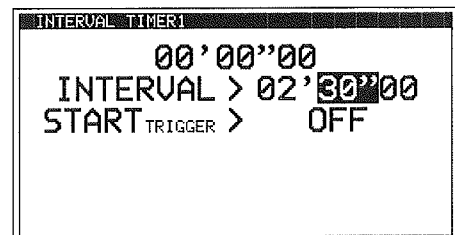
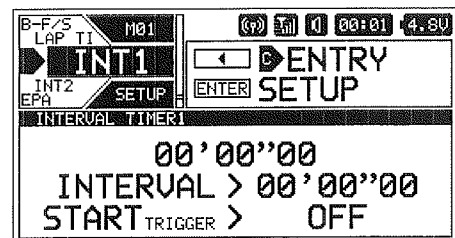

INT1 and INT2 INTERVAL setting range is 00:00:00 to 99:59:90. The default setting for both Interval Timers is 00:00:00 (OFF).

Choosing the Optional Throttle Trigger Start:

The Throttle Trigger can be used to Start the Interval Timer after the Interval Timer as been placed in Standby. This is much more convenient than worrying about pressing the Interval Timer Switch again to Start the Interval Timer when you're starting your race.

M12 2.4GHZ FH4T RADIO CONTROL SYSTEM USER'S GUIDE

INT1 AND INT2 MENU (INTERVAL 1 AND INTERVAL 2 TIMERS)

SETUP

Choosing the Optional Throttle Trigger Start, Continued....

- 1) From within the INT1 menu, scroll UP or DOWN to highlight STARTTRIGGER > OFF.
- 2) Press the ENTER key, then scroll UP or DOWN to choose the desired Start Trigger value, either ON or OFF.

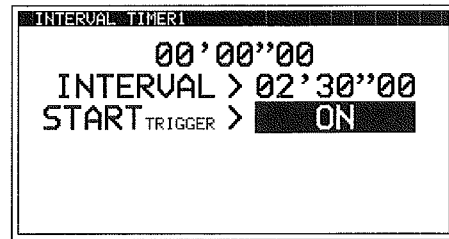

INT1 and INT2 STARTTRIGGER setting range is OFF and ON. The default setting for both Interval Timers is OFF.

Starting the Interval Timers:

In the default configuration, the Lap Timer Switch (Push-Button Switch Sw3) controls both the Lap Timer and Interval Timer 1. To control Interval Timer 2, it must first be Assigned to a Push-Button Switch. If desired, the Interval Timers can be Started and Stopped independently by Assigning each one to a different Push-Button Switch or they can be Started and Stopped simultaneously by Assigning both of them to the same Push-Button Switch. Regardless of what you decide, follow the step below to control the Interval Timer(s).

- 1) Press and HOLD the Push-Button Switch you've Assigned the Interval Timer(s) to for 3 seconds. An audible Double-Tone will sound and INT1 [STANDBY] or INT2 [STANDBY] will be displayed momentarily in a pop-up window, indicating the Interval Timer is in Standby. To Start the Interval Timer, press the Push-Button Switch a second time or pull the Throttle Trigger if you've Enabled the Start Trigger function. An audible Double-Tone will sound and the Interval Timer will start counting Up. Each time the Interval Time elapses, an audible Double-Tone will sound and the Interval Timer will Reset and start counting Up again from zero. If desired, you can manually Restart the Interval Timer from zero by pressing the Push-Button Switch while the Interval Timer is running.

! If the Interval Timer is Assigned to the same Push-Button Switch as the Lap Timer and the Lap Timer is Assigned to Function 1, LAP will flash and Lap Time information will be displayed in a pop-up window, but the Interval Timer will run in the background.

! When both Interval Timers are Assigned to the same Push-Button Switch, only the Interval Timer Assigned to Function 1 will be displayed in the pop-up window when the Interval Timers Start and Stop, however, if the Interval Timers are set to different values, each Interval Timer will be displayed in the pop-up window as the Interval Times are reached.

Stopping the Interval Timers:

- 1) To stop the Interval Timer(s), press and HOLD the Push-Button Switch you've Assigned the Interval Timer(s) for 3 seconds. An audible Double-Tone will sound indicating the Interval Timer(s) is stopped.

! When Stopped, the Interval Timer will read 00'01"00. This is normal. This value will be cleared when the Interval Timer is placed in Standby again.

RACING MENU OVERVIEW

RACING

To access the various RACING Programming Menus, turn the transmitter ON, then press the SELECT switch to highlight the RACING menu. Press the ENTER key to open the RACING menu.

Scroll UP or DOWN to highlight the desired Programming Menu, then press the ENTER key to open that menu.

! Depending on the Car Type chosen, some Function Programming Value Names may differ from those shown in this section.

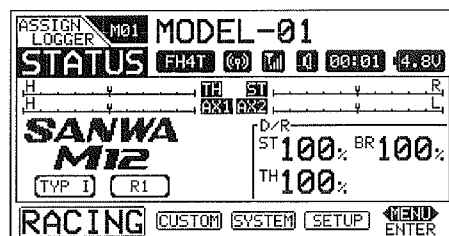

The following Programming Menus are available within the RACING menu:

MENU	MENU DESCRIPTION	PAGE #
R-MODE	Turn Racing Mode ON or OFF and Choose Racing Mode Options	PG. 75
D/R	Adjust Steering, Throttle and Brake Dual Rates	PG. 76
TRIM	Adjust Servo Trim, Including Auxiliary Channel Trim	PG. 77
CURVE	Adjust Channel Exponential, Adjustable Rate Control (ARC) and Curves	PG. 78
SPEEI	Adjust Servo Speed in the Forward and the Return to Neutral Directions	PG. 82
ALI	Turn Anti-Lock Braking ON or OFF and Choose Anti-Lock Braking Options	PG. 84

M12 2.4GHZ FH4T RADIO CONTROL SYSTEM USER'S GUIDE

RACING MENU OVERVIEW

RACING

The following Programming Menus are available within the RACING menu:

MENU	MENU DESCRIPTION	PAGE #
OFFSET	Turn Throttle Offset ON or OFF and Choose Throttle Offset Options	PG. 85
BR-MIX	Program Dual Brake Mixing Option (Dual Brake Car Types Only)	PG. 87
TH-HLI	Turn Throttle Hold ON or OFF and Choose Throttle Hold Options	PG. 87
C-MIX1	Program Compensation Mixing 1 Options	PG. 89
C-MIX2	Program Compensation Mixing 2 Options	PG. 89
ACKER	Program Ackerman Angle Options (Left and Right Steering Servo Car Types Only)	PG. 92
R-DLY	Program a Delay When Switching Between Racing Modes	PG. 92
CODE AX1	Program Code Auxiliary 1 Options (For Future Connected Products)	PG. 93
CODE AX2	Program Code Auxiliary 2 Options (For Future Connected Products)	PG. 93

R-MODE MENU (RACING MODE)

RACING

The Racing Mode function provides you with five separate Racing Modes that you can switch between while you're driving. For example, due to changing track conditions or other variables, such as tire wear, different Racing Modes can be Selected at any time to change your Model's setup. A number of functions, such as Dual Rate, Exponential, Curves, Compensation Mixing and more, that might commonly be required to be changed during the course of a race can be programmed with different Programming Values for each Racing Mode. This ensures that your Model can operate with the best-suited setup for ever-changing track conditions throughout an entire race, giving you an advantage over other drivers.

Functions can be programmed the same for all five Racing Modes or functions can be programmed independently, allowing you to have different function Programming Values for each of the five Racing Modes and switch between them while driving.

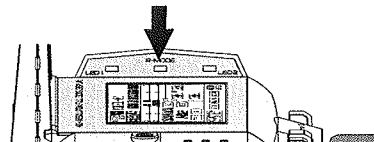
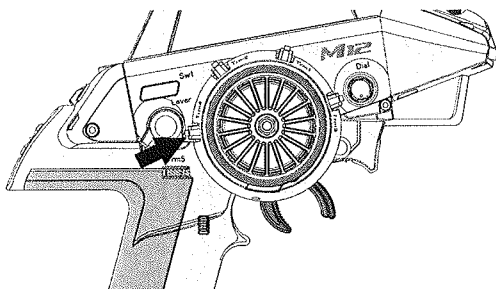

Active R-MODE LED Colors:

MODE LED	OFF	R1	R2	R3	R4	R5
COLOR	OFF	GREEN	MAGENTA	CYAN	YELLOW	WHITE

In the default configuration, after Activating the Racing Mode function, you can switch between Racing Modes using the Racing Mode Switch (Trim Switch Trm4). The R-MODE LED will change color to indicate the currently Active Racing Mode. In addition, the currently Active Racing Mode will be displayed on the STATUS screen. When you switch between Racing Modes, the currently Active Racing Mode will be momentarily displayed in a pop-up window.

Racing Mode functions will vary depending on the current Car Type. For a complete list of Racing Mode functions based on Car Type, see the Racing Mode Functions by Car Type table on page 99.

Turning Racing Mode ON and OFF:

- 1) From within the RACING menu, scroll UP or DOWN to highlight the R-MODE menu.
- 2) Press the ENTER key to open the R-MODE menu. R-MODE > INH will be highlighted.
- 3) Press the ENTER key, then scroll UP or DOWN to choose the desired R-MODE value, either ACT (Active) or INH (Inhibited/OFF).

R-MODE setting range is ACT and INH. The default setting is INH.

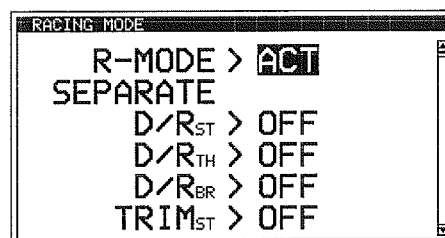
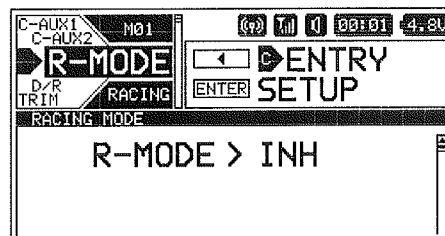

M12 2.4GHZ FH4T RADIO CONTROL SYSTEM USER'S GUIDE

R-MODE MENU (RACING MODE)

RACING

Turning Separate Functions ON and OFF:

When Racing Mode is turned ON (R-MODE > ACT), various functions can be programmed the same for all five Racing Modes or they can be programmed independently, allowing you to have different function Programming Values for each of the five Racing Modes. For example, with D/R_{ST} set to ON, you can choose a Dual Rate Steering percentage value of 100% for Racing Mode 1, a Dual Rate Steering percentage value of 90% for Racing Mode 2 and so on.

- 1) From within the R-MODE menu, scroll UP or DOWN to highlight desired function you would like to turn ON or OFF.
- 2) Press the ENTER key, then scroll UP or DOWN to choose the desired value, either ON or OFF. When set to ON, you will be able to choose different function Programming Values for each Racing Mode. When set to OFF, function Programming Values will be the same for all Racing Modes.

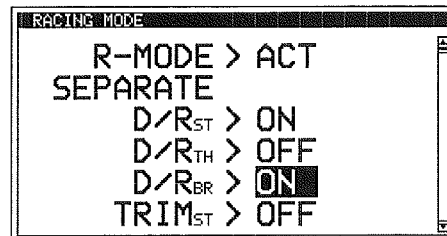

SEPARATE functions setting range is OFF and ON. The default setting for all functions is OFF.

- 3) Press the ENTER key, then repeat steps 1 and 2 to change any other desired values.

Switching Racing Modes to Program Separate Functions:

If you've chosen to program one or more Racing Mode functions separately (as described above), a Racing Mode Icon will be displayed within the specific function Programming Menu to indicate which Racing Mode you're currently programming the function for.

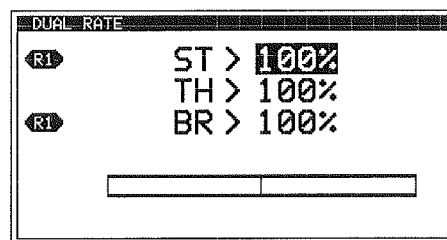

To program different values for each Racing Mode, make sure to switch to the desired Racing Mode first. For example, with SEPARATE D/R_{ST} set to ON, open the D/R menu. An R1, R2, R3, R4 or R5 Racing Mode Icon will be displayed next to the Steering function, depending on which current Racing Mode is Active.

Use the Racing Mode Switch (Trim Switch Trm4) to switch to Racing Mode 1. R1 will be displayed next to the ST > 100% percentage value. Choose the desired Steering Dual Rate percentage value for Racing Mode 1, then press Trim Switch Trm4 to switch to Racing Mode 2. R2 will be displayed next to the ST > 100% percentage value. Choose the desired Steering Dual Rate percentage value for Racing Mode 2. While you're driving, you can now switch to different Dual Rate settings simply by switching Racing Modes.

 The Racing Mode Icon will only be displayed for Programming Menus within the RACING menu and only if the specific function's Separate value is set to ON in the R-MODE menu. If no Racing Mode Icon is displayed, the function Programming Value will be the same regardless of which Racing Mode is currently Active.

D/R MENU (DUAL RATES)

RACING

The Dual Rate function allows you to change the control authority of the Steering, Throttle High Side and Throttle Brake Side by changing the amount of servo travel relative to control input. For example, by Increasing the Steering Dual Rate, you can make the Steering servo travel more which might prevent your Model from pushing during turns. If your Model oversteers during turns, you can reduce the amount of Steering Dual Rate.

IMPORTANT: Prior to programming the Dual Rate function, you should adjust the maximum Left and Right (or High and Low) End Points. For more information, see the EPA Menu section on page 62.

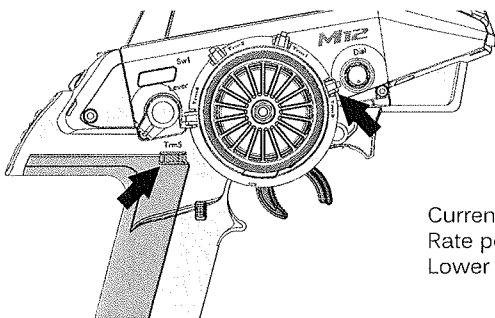

In the default configuration, Trim Switch Trm3 controls Steering Dual Rate and Trim Switch Trm5 controls Brake Dual Rate. Throttle Dual Rate can be changed while you're driving by Assigning the Dual Rate function to another Trim Switch or the Auxiliary Dial. For more information, see the ASSIGN Menu section on pages 33 ~ 38.

Current Steering, Throttle and Brake Dual Rate percentage values are displayed in the Lower Right corner of the STATUS screen.

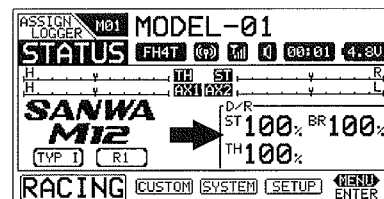

M12 2.4GHZ FH4T RADIO CONTROL SYSTEM USER'S GUIDE

D/R MENU (DUAL RATES)

RACING

Adjusting the Dual Rate Percentage Values:

- 1) From within the RACING menu, scroll UP or DOWN to highlight the D/R menu.
- 2) Press the ENTER key to open the D/R menu. ST > 100% will be highlighted.
- 3) Scroll UP or DOWN to highlight the desired Dual Rate percentage value you would like to change.
- 4) Press the ENTER key, then scroll UP or DOWN to Increase or Decrease the Dual Rate percentage value. Increasing the percentage value will Increase servo travel and Decreasing the percentage value will Decrease servo travel.
- 5) Press the ENTER key, then repeat steps 3 and 4 to change any other desired Dual Rate percentage values.

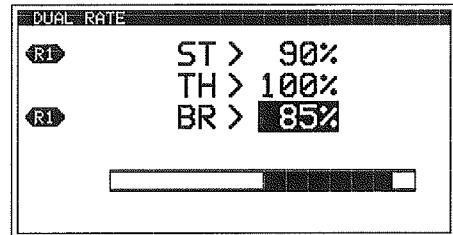
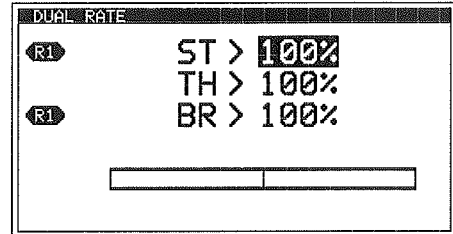
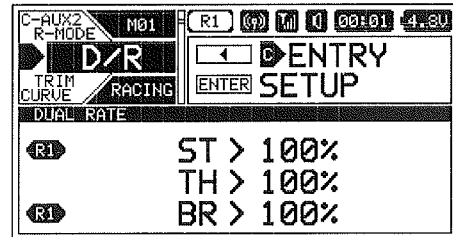

DUAL RATE setting range is 0% to 100%. The default setting for all channels is 100%.

! Dual Rate is a percentage of End Point Adjustment. For example, if you set the Steering Dual Rate percentage value to 100%, the Steering will travel the same amount defined by your End Point Adjustment programming. Alternately, if you set the Steering Dual Rate percentage value to 50%, the Steering will travel half the amount defined by your End Point Adjustment programming.

TRIM MENU (SERVO TRIM)

RACING

The Trim function allows you to view the current Trim value for each of the four channels and, if desired, allows you to change the Trim values using the Push-Button Rotary Dial from within the TRIM menu. For example, if you don't Assign Auxiliary 1 Trim to a Trim Switch, you can still Trim the Auxiliary 1 channel from within the TRIM menu.

The M12 features Digital Trim Memory. Any amount of Trim that you set during use using the Trim Switches or through the TRIM menu is automatically stored in memory for that specific channel and for that specific Model. The Trim values for each Model will automatically be loaded when the transmitter is turned ON.

Each time you move a Trim Switch a short audible Tone is heard. When the Trim value reaches 0 (Centered), a longer audible Tone sounds. This indicates to you that the Trim is centered without the need to look at the transmitter.

! In the default configuration, Trim Switch Trm1 and Trm2 move the Steering and Throttle/Brake Trim in 5% increments. If you want to Increase or Decrease the Trim Resolution, see the *Changing the Trim Switch Step Value* section on page 35.

PRO TIP: The Trim function features two different Trim Type options that you can choose from. Choose from either Center Trim or Parallel Trim. For more information, see the *TRIM TYPE Menu* section on page 43.

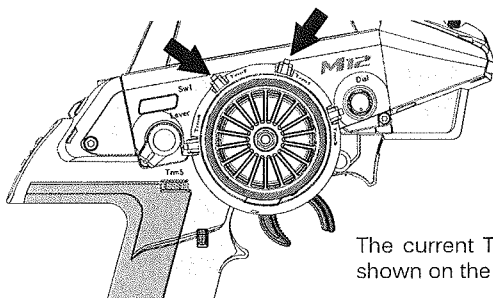

In the default configuration, Trim Switch Trm1 controls Steering Trim and Trim Switch Trm2 controls Throttle/Brake Trim. Auxiliary channel Trim can be changed while you're driving by Assigning the Trim function to another Trim Switch or the Auxiliary Dial. For more information, see the *ASSIGN Menu* section on pages 33 ~ 38.

The current Trim positions for all four channels is shown on the Trim Displays on the STATUS screen.

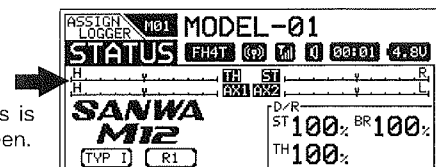

M12 2.4GHZ FH4T RADIO CONTROL SYSTEM USER'S GUIDE

TRIM MENU (SERVO TRIM)

RACING

! Before adjusting the Trim values, you should first verify that all Trim values are set to 0, then adjust the servo Sub-Trim values to center the servo horns perfectly. For more information, see the *SUB TRIM Menu* section on page 63.

Adjusting the Trim Values:

- 1) From within the RACING menu, scroll UP or DOWN to highlight the TRIM menu.
- 2) Press the ENTER key to open the TRIM menu. ST > 0 will be highlighted.
- 3) Scroll UP or DOWN to highlight the desired Trim value you would like to change.
- 4) Press the ENTER key, then scroll UP or DOWN to Increase or Decrease the Trim value in the desired direction.
- 5) Press the ENTER key, then repeat steps 3 and 4 to change any other desired Trim values.

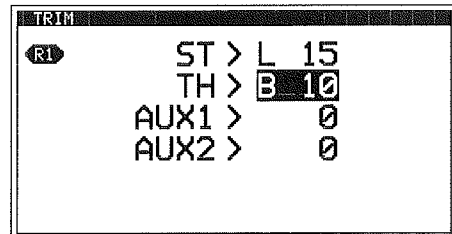
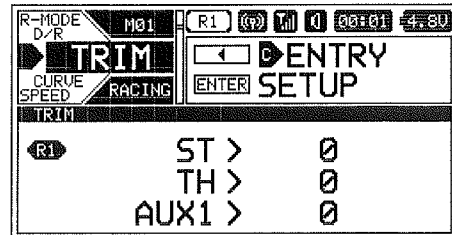

TRIM setting range is 0 to 100 in each direction. The default setting for all channels is 0.

CURVE MENU (EXPONENTIAL, ADJUSTABLE RATE CONTROL AND CURVE)

RACING

The CURVE menu allows you choose what method you would like to use to vary the amount of servo travel in relation to the amount of control movement. Choose from Exponential, Adjustable Rate Control (ARC) and Curve functions. Each of these three functions offers something different, and which function you choose to use for each channel will be determined by many factors, including your Car Type, track conditions, driving style and more.

! Exponential, Adjustable Rate Control and Curve functions can be programmed for each of the four channels. Programming options will differ within each function depending on the specific channel you're programming. For example, if your Car Type features Front and Rear Steering and Front and Rear Motors (such as Car Type X), only ST and TH channel options will be programmable, however, both Front and Rear channels will be programmed with the same Programming Values.

Exponential Programming

The Exponential function allows you to vary the amount of servo travel in relation to the movement of the Steering Wheel and Throttle Trigger (or in some cases, the Auxiliary Dial and/or the Auxiliary Lever) near the Neutral positions to change the way those functions react to control movement.

Decreasing the Exponential Rate percentage value will Soften the control feel around Neutral and Increasing the Exponential Rate percentage value will Heighten the control feel around Neutral. Using a Lower Negative value allows for smoother control. Using a Higher Positive value may result in more 'twitchy' control response.

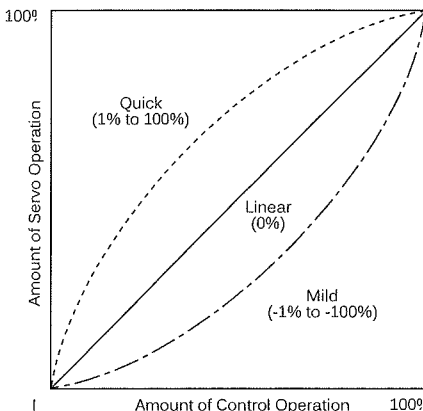

Exponential Rate percentage values can be adjusted from Mild through Linear to Quick to allow you to set the most effective control response for your Model. For example, if your Model over-steers, reduce the Steering Exponential Rate percentage value and if your Model under-steers, Increase the Steering Exponential Rate percentage value.

For another example, reduce the Throttle High Side Exponential Rate percentage value on a slippery track or with a Model that has a Higher-torque motor or engine, and Increase the Throttle High Side Exponential Rate percentage value on a high-grip track or with a Model that has a Lower-torque motor or engine.

For the utmost in precision control, Exponential Rate percentage values can be adjusted separately for the Throttle High Side and the Throttle Brake Side. In addition, the Exponential Tweak Right and Tweak Left function allows you to balance Exponential for Right and Left Steering.

A graph that depicts the control output and Exponential Curve relationship is featured to help visualize the changes you make.

! Exponential Programming Values can be changed while you're driving by Assigning these functions to a Trim Switch, the Auxiliary Dial or the Auxiliary Lever. For more information, see the *ASSIGN Menu* section on pages 33 ~ 38.

M12 2.4GHZ FH4T RADIO CONTROL SYSTEM USER'S GUIDE

CURVE MENU (EXPONENTIAL, ADJUSTABLE RATE CONTROL AND CURVE)

RACING

Choosing the Channel and the Curve Type:

- 1) From within the RACING menu, scroll UP or DOWN to highlight the CURVE menu.

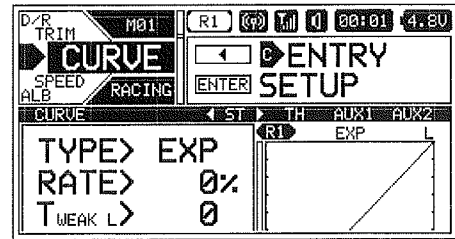

- 2) Press the ENTER key to open the CURVE menu. The < ST > channel will be Selected.
- 3) Press the SELECT switch RIGHT or LEFT to choose the desired channel you would like to program Exponential for.
- 4) From within the CURVE menu, scroll UP or DOWN to highlight the TYPE > value.
- 5) Press the ENTER key and scroll UP or DOWN to choose TYPE > EXP.

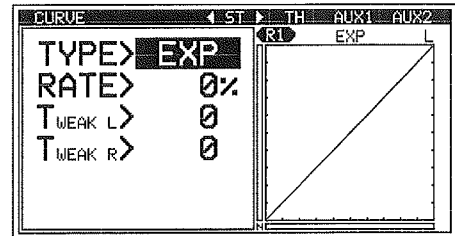

Adjusting the Rate Percentage Value:

The Rate percentage value determines the amount and type of Exponential, either Quick, Mild or Linear (see diagram on the previous page). When a Positive or Negative Exponential percentage value is programmed, a Curve will be created from a fixed Neutral Point. This Curve will be equal on both sides, except for the Throttle channel. For more information, see the notation below.

- 1) From within the CURVE menu, scroll UP or DOWN to highlight RATE > 0%.
- 2) Press the ENTER key, then scroll UP or DOWN to Increase or Decrease the Rate percentage value. Using a Negative Rate percentage value will Soften the control feel around Neutral and using a Positive Rate percentage value will Heighten the control feel around Neutral.

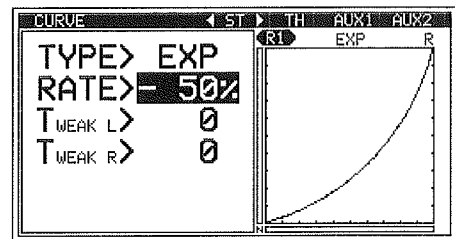

RATE setting range is -100% (Mild) to 100% (Quick). The default setting is 0% (Linear).

 You are able to adjust the Rate percentage value for the Throttle High Side and the Throttle Brake Side separately. In addition, you can even program Exponential for one Side and ARC or Channel Curve for the other Side.

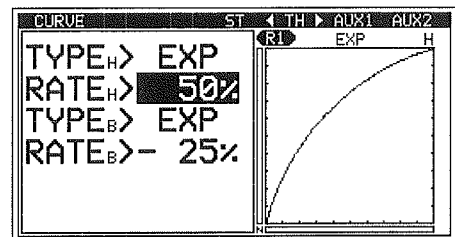

Adjusting the Steering Tweak Right and Tweak Left Values:

The Tweak function allows you to make small Exponential adjustments to the Right and/or Left sides of the Steering channel Neutral Point to fine-tune the balance between the two sides. Tweak value adjustments are effective whether you program a Negative or a Positive Rate value, or even program a Linear Rate value (0).

- 1) From within the CURVE menu, scroll UP or DOWN to highlight the desired Tweak value, either TWEAK L or TWEAK R.
- 2) Press the ENTER key, then scroll UP or DOWN to Increase or Decrease the Tweak value. Using a Negative Tweak value will Soften the control feel that side of Neutral and using a Positive Rate percentage value will Heighten the control feel around that side of Neutral.

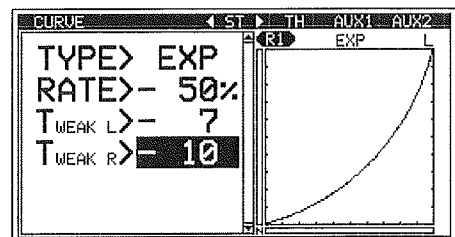

- 3) Press the ENTER key, then repeat steps 1 and 2 to change the other Tweak value, if desired.

TWEAK L and TWEAK R setting range is -20 (Mild) to 20 (Quick). The default setting for both Tweak values is 0 (Linear).

M12 2.4GHZ FH4T RADIO CONTROL SYSTEM USER'S GUIDE

CURVE MENU (EXPONENTIAL, ADJUSTABLE RATE CONTROL AND CURVE)

RACING

Adjustable Rate Control Programming

The Adjustable Rate Control (ARC) function allows you to vary the amount of servo travel in relation to the movement of the Steering Wheel and Throttle Trigger (or in some cases, the Auxiliary Dial and/or the Auxiliary Lever) near the Neutral positions to change the way those functions react to control movement.

Decreasing the ARC Rate percentage value will Soften the control feel around Neutral and Increasing the ARC Rate percentage value will Heighten the control feel around Neutral. Using a Lower Negative value allows for smoother control. Using a Higher Positive value may result in more 'twitchy' control response.

The Adjustable Rate Control function works like the Exponential function, except that the Adjustable Rate Control function features the added benefit of being able to move the Neutral Point, whereas the Exponential function Neutral Point is fixed. In addition, the ARC Curve is more Linear than the Exponential Curve.

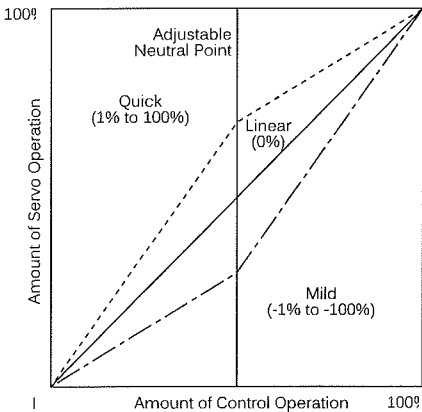

ARC Rate percentage values can be adjusted from Mild through Linear to Quick to allow you to set the most effective control response for your Model. For example, if your Model over-steers, reduce the Steering ARC Rate percentage value and if your Model under-steers, Increase the Steering ARC Rate percentage value.

For another example, reduce the Throttle High Side ARC Rate percentage value on a slippery track or with a Model that has a Higher-torque motor or engine, and increase the Throttle High Side ARC Rate percentage value on a high-grip track or with a Model that has a Lower-torque motor or engine.

For the utmost in precision control, ARC Point and Rate values can be adjusted separately for the Throttle High Side and the Throttle Brake Side. A graph that depicts the control output and ARC Curve relationship is featured to help visualize the changes you make.

! Adjustable Rate Control Programming Values can be changed while you're driving by Assigning these functions to a Trim Switch, the Auxiliary Dial or the Auxiliary Lever. For more information, see the ASSIGN Menu section on pages 33 - 38.

Choosing the Channel and the Curve Type:

- 1) From within the RACING menu, scroll UP or DOWN to highlight the CURVE menu.
- 2) Press the ENTER key to open the CURVE menu. The < ST > channel will be Selected.
- 3) Press the SELECT switch RIGHT or LEFT to choose the desired channel you would like to program ARC for.
- 4) From within the CURVE menu, scroll UP or DOWN to highlight the TYPE > value.
- 5) Press the ENTER key and scroll UP or DOWN to choose TYPE > ARC.

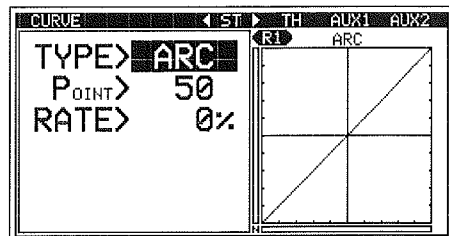
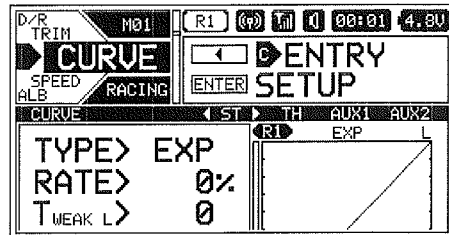

Adjusting the Point Value:

The Point value determines the Neutral Point where the Rate percentage value begins. For example, you may not want the Neutral Point to be centered between the High and Low End Points. You might want the Neutral Point shifted to the Right or to the Left.

- 1) From within the CURVE menu, scroll UP or DOWN to highlight POINT > 50.
- 2) Press the ENTER key, then scroll UP or DOWN to Increase or Decrease the Point value. Increasing the Point value will shift the Neutral Point to one side of center and Decreasing the Point value will shift the Neutral Point to the opposite side of center.

POINT setting range is 5 to 95. The default setting is 50 (Centered).

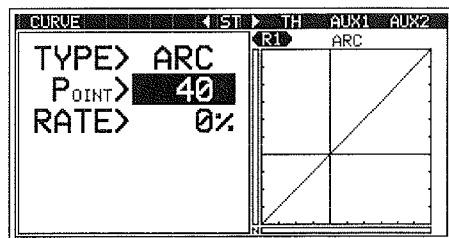

M12 2.4GHZ FH4T RADIO CONTROL SYSTEM USER'S GUIDE

CURVE MENU (EXPONENTIAL, ADJUSTABLE RATE CONTROL AND CURVE)

RACING

Adjusting the Rate Percentage Value:

The Rate percentage value determines the amount and type of ARC, either Quick, Mild or Linear (see diagram on the previous page). When a Positive or Negative ARC percentage value is programmed, a Linear Curve will be created from the Neutral Point.

- 1) From within the CURVE menu, scroll UP or DOWN to highlight RATE > 0%.
- 2) Press the ENTER key, then scroll UP or DOWN to Increase or Decrease the Rate percentage value. Using a Negative Rate percentage value will Soften the control feel around the Neutral Point and using a Positive Rate percentage value will Heighten the control feel around the Neutral Point.

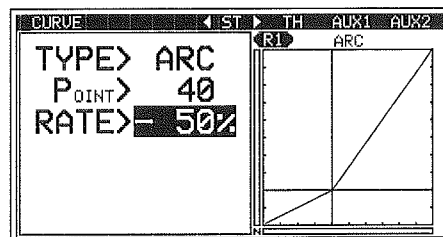

RATE setting range is -100% (Mild) to 100% (Quick). The default setting is 0% (Linear).

! You are able to adjust the Point value and the Rate percentage value for the Throttle High Side and the Throttle Brake Side separately. In addition, you can even program ARC for one Side and Exponential or Channel Curve for the other Side.

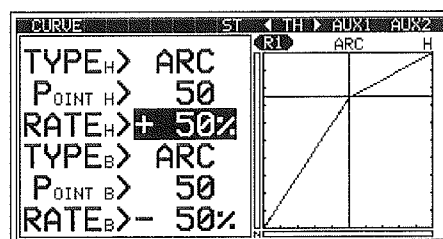

Channel Curve Programming

The Channel Curve function allows you to vary the amount of servo travel in relation to the movement of the Steering Wheel and Throttle Trigger (or in some cases, the Auxiliary Dial and/or the Auxiliary Lever) at different Points along the entire range of control travel to change the way those functions react to control movement. Nine programmable Points allow you to create your own custom Channel Curve to suit any situation.

The Channel Curve function works like the Exponential and ARC functions, except that the Channel Curve function allows you to program up to 9 different Points along the entire range of control travel to suit whatever setup or situation is required. For example, you can customize the Channel Curve to include Mild or Quick Points along the same Curve, or you can create a smooth Channel Curve or a more Linear Channel Curve.

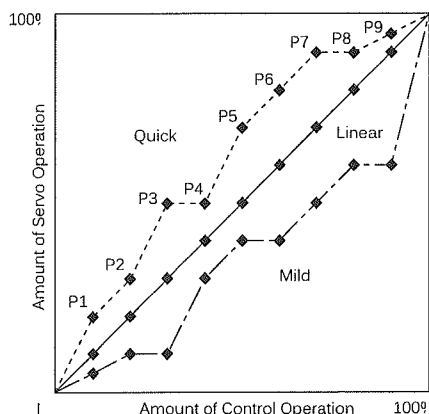

Channel Curve percentage values can be adjusted from Mild through Linear to Quick to allow you to set the most effective control response for your Model. For example, if your Model over-steers, reduce the Channel Curve percentage values and if your Model under-steers, Increase the Channel Curve percentage values.

For another example, reduce the Throttle High Side Channel Curve percentage values on a slippery track or with a Model that has a Higher-torque motor or engine, and Increase the Throttle High Side Channel Curve percentage values on a high-grip track or with a Model that has a Lower-torque motor or engine.

For the utmost in precision control, Channel Curves can be programmed separately for the Throttle High Side and the Throttle Brake Side. A graph that depicts the control output and Channel Curve relationship is featured to help visualize the changes you make.

! Channel Curve Programming Values can be changed while you're driving by Assigning these functions to a Trim Switch, the Auxiliary Dial or the Auxiliary Lever. For more information, see the *ASSIGN Menu* section on pages 33 ~ 38.

Choosing the Channel and the Curve Type:

- 1) From within the RACING menu, scroll UP or DOWN to highlight the CURVE menu.

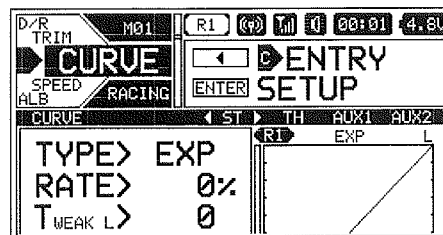

M12 2.4GHZ FH4T RADIO CONTROL SYSTEM USER'S GUIDE

CURVE MENU (EXPONENTIAL, ADJUSTABLE RATE CONTROL AND CURVE)

RACING

Choosing the Channel and the Curve Type, Continued....

- 2) Press the ENTER key to open the CURVE menu. The < ST > channel will be Selected.
- 3) Press the SELECT switch RIGHT or LEFT to choose the desired channel you would like to program Channel Curve for.

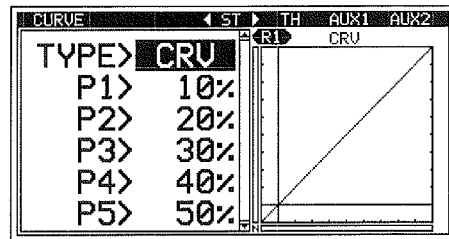

- 4) From within the CURVE menu, scroll UP or DOWN to highlight the TYPE > value, then press the ENTER key and scroll UP or DOWN to choose TYPE > CRV.

Adjusting the Point Percentage Values:

The Point percentage values determine the type of Channel Curve, either Quick, Mild or Linear (see diagram on the previous page). Programming a Point percentage value that is Lower than the default value for that specific Point will Soften the control feel (Mild) and programming a Point percentage value that is Higher than the default value for that specific Point will Heighten the control feel (Quick).

- 1) From within the CURVE menu, scroll UP or DOWN to highlight the desired Point you want to change the Point percentage value for. Choose from P1 through P9.
- 2) Press the ENTER key, then scroll UP or DOWN to Increase or Decrease the Point percentage value. Using a Lower Point percentage value will Soften the control feel and using a Higher Point percentage value will Heighten the control feel.

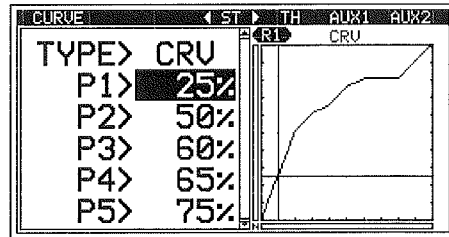

- 3) Press the ENTER key, then repeat steps 1 and 2 to choose the Point percentage value for any other desired Points.

POINT 1 ~ 9 setting range is 0% to 100%. The default setting for P1 is 10%, for P2 is 20%, for P3 is 30%, for P4 is 40%, for P5 is 50%, for P6 is 60%, for P7 is 70%, for P8 is 80% and for P9 is 90%.

! You are able to adjust Point percentage values for the Throttle High Side and the Throttle Brake Side separately. In addition, you can even program Channel Curve for one Side and Exponential or ARC for the other Side.

SPEED MENU (SERVO SPEED)

RACING

The Servo Speed function allows you to slow the transit speed of the Steering, Throttle, Auxiliary 1 and Auxiliary 2 channels. When driving your Model, proper Steering and Throttle control are vital. For example, lowering the transit speed of the Steering servo can help to limit excessive Steering, which will enable you to achieve smoother cornering. In addition, lowering the transit speed of the Throttle servo High Side can help to ensure smooth Throttle control. This function can be used in conjunction with the Exponential, ARC or Channel Curve functions to double the effect.

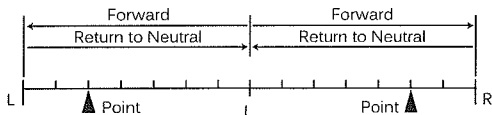

Servo transit speed can be slowed in the Forward and the Return to Neutral directions independently. In addition, you are able to program a Point on either side of servo travel, then define whether the servo transit speed is slowed down either Outside or Inside those two Points.

! The Servo Speed function can be programmed for each of the four channels, however, depending on the current Car Type, not all channels may be able to be Selected. For example, if your current Car Type features Front and Rear Steering and Front and Rear Motors (such as Car Type X), only ST and TH channel options will be programmable, however, both Front and Rear channels will be programmed with the same Programming Values.

! Servo Speed Programming Values can be changed while you're driving by Assigning these functions to a Trim Switch, the Auxiliary Dial or the Auxiliary Lever. For more information, see the ASSIGN Menu section on pages 33 ~ 38.

Choosing the Channel:

- 1) From within the RACING menu, scroll UP or DOWN to highlight the SPEED menu.

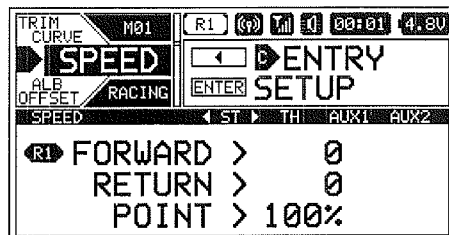

M12 2.4GHZ FH4T RADIO CONTROL SYSTEM USER'S GUIDE

SPEED MENU (SERVO SPEED)

RACING

Choosing the Channel, Continued....

- 2) Press the ENTER key to open the SPEED menu. The < ST > channel will be Selected.
- 3) Press the SELECT switch RIGHT or LEFT to choose the desired channel you would like to program the Servo Speed function for.

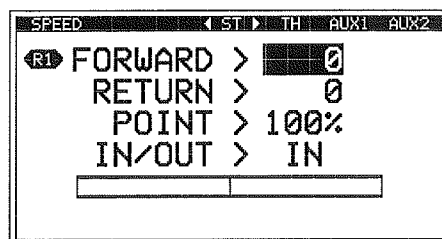

⚠ When the Throttle channel is Selected, you are able to adjust Servo Speed function Programming Values separately for both the Throttle High Side (H) and the Throttle Brake Side (B).

Adjusting the Servo Speed Forward Value:

- 1) From within the SPEED menu, scroll UP or DOWN to highlight FORWARD > 0.
- 2) Press the ENTER key, then scroll UP or DOWN to choose the desired Servo Speed Forward value. When 0 is Selected, the servo will travel at its normal speed in the Forward direction. When a Negative value is Selected, the servo transit speed will slow down in the Forward direction.

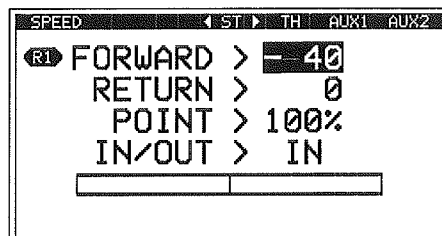

FORWARD setting range is 0 to -100. The default setting is 0 (Normal Speed).

Adjusting the Servo Speed Return Value:

- 1) From within the SPEED menu, scroll UP or DOWN to highlight RETURN > 0.
- 2) Press the ENTER key, then scroll UP or DOWN to choose the desired Servo Speed Return value. When 0 is Selected, the servo will travel at its normal speed in the Return to Neutral direction. When a Negative value is Selected, the servo transit speed will slow down in the Return to Neutral direction.

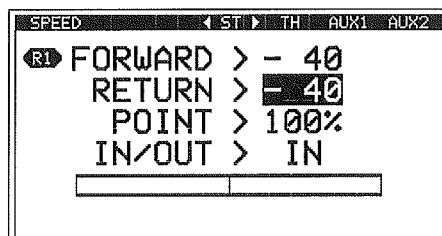

RETURN setting range is 0 to -100. The default setting is 0 (Normal Speed).

Adjusting the Point Percentage and IN and OUT Values:

The Point percentage value determines where along either side of servo travel that the servo's transit speed will be changed. The IN and OUT values determine whether the change in servo transit speed occurs between the two points (IN) or outside the two Points (OUT). See the diagram on the previous page.

⚠ If a 100% Point percentage value is chosen, the servo's transit speed will be the same along the entire length of travel. IN and OUT values are only discernible if a Point percentage value other than 100% is chosen.

- 1) From within the SPEED menu, scroll UP or DOWN to highlight POINT > 100%.
- 2) Press the ENTER key, then scroll UP or DOWN to choose the desired Point percentage value.

POINT setting range is 5% to 100%. The default setting is 100%.

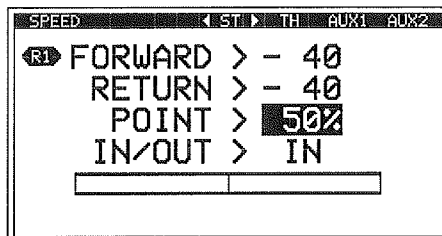

- 3) Press the ENTER key, then scroll DOWN to highlight IN/OUT > IN.
- 4) Press the ENTER key, then scroll UP or DOWN to choose the desired IN/OUT value, either IN or OUT.

IN/OUT setting range is IN or OUT. The default setting is IN.

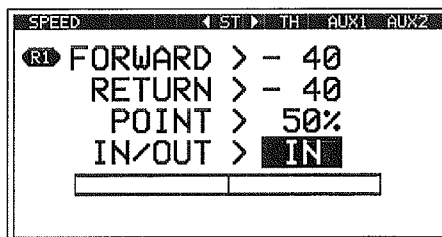

M12 2.4GHZ FH4T RADIO CONTROL SYSTEM USER'S GUIDE

ALB MENU (ANTI-LOCK BRAKING)

RACING

The Anti-Lock Braking function makes it possible to achieve stable Braking even on a slippery surface. With stable Braking, your Model is better able to trace an exact line under Braking. When the Anti-Lock Braking function is turned ON, the Throttle servo will pulse when you apply Brake. Different Anti-Lock Braking options can be programmed, including how quickly the Brake pulsates, the Point at which the Anti-Lock Braking function Starts and more.

The Anti-Lock Braking function is primarily used on gasoline- or glow-powered Models that feature a Throttle servo. It can be used on an electric Model that uses an Electronic Speed Control, however, if your Electronic Speed Control features a reverse function, the Anti-Lock Braking function will not operate properly.

! The Anti-Lock Braking function operates only when the Throttle Trigger is moved from Neutral to the Brake Side. Set the hardest Braking you can obtain from your Model by carefully setting the Anti-Lock Braking function Right before the tires fully lock up but do not slip and lose traction. Be aware that using the Anti-Lock Brake function will never result in your Model losing traction under Braking. It only improves Braking under less than ideal conditions.

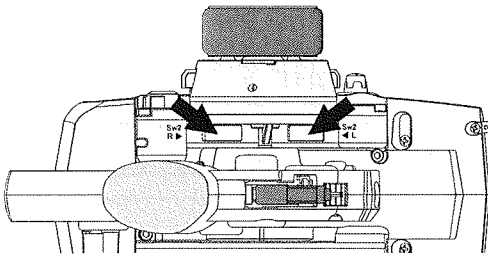
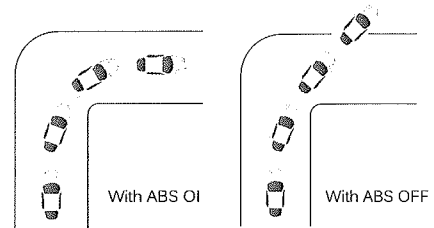

In the default configuration, Push-Button Switch Sw2 controls the Anti-Lock Braking Function. Pressing and HOLDING the switch will turn Anti-Lock Braking ON and releasing the switch will turn Anti-Lock Braking OFF.

! If desired, you can change the behavior of the switch from PUSH (default) to TOGGLE. For more information, see the *Changing the Switch Mode* section on page 34.

! Anti-Lock Braking Programming Values can be changed while you're driving by Assigning these functions to a Trim Switch, the Auxiliary Dial or the Auxiliary Lever. For more information, see the *ASSIGN Menu* section on pages 33 ~ 38.

! The diagram at Right illustrates the relationship between the Point, Lag, Release, Hold and Stroke functions, all of which can be programmed separately to suit your specific Car Type, track conditions and Anti-Lock Braking behavior.

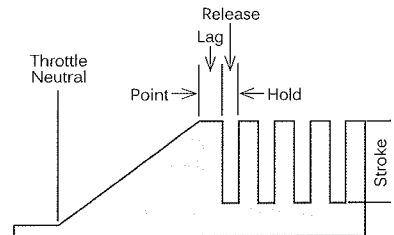

Adjusting the Stroke Percentage Value:

The Stroke percentage value determines the amount of Brake that's applied automatically when the Anti-Lock Braking function is turned ON.

! A Stroke percentage value of 1% or greater must be programmed for the Anti-Lock Braking function to be turned ON. If a Stroke value of OFF is chosen, the Anti-Lock Braking function cannot be turned ON.

1) From within the RACING menu, scroll UP or DOWN to highlight the ALB menu.

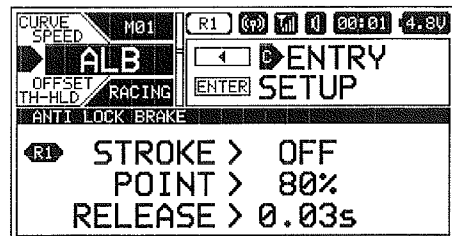

2) Press the ENTER key to open the ALB menu. STROKE > OFF will be highlighted.

3) Press the ENTER key, then scroll UP or DOWN to choose the desired Stroke percentage value. Increasing the Stroke percentage value will Increase Throttle servo travel in the Brake direction and Decreasing the Stroke percentage value will Decrease Throttle servo travel in the Brake direction.

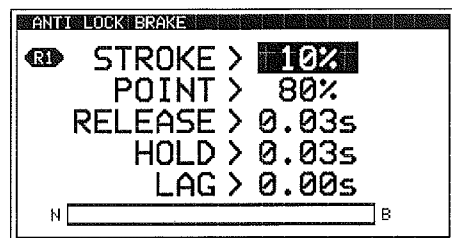

STROKE setting range is OFF to 100%. The default setting is OFF.

M12 2.4GHZ FH4T RADIO CONTROL SYSTEM USER'S GUIDE

ALB MENU (ANTI-LOCK BRAKING)

RACING

Adjusting the Point Percentage Value:

The Point percentage value determines the position along the length of Brake Side servo travel that the Anti-Lock Braking function Activates at when turned ON. For example, if set to 80%, you will have Normal Braking from the Throttle Neutral Point to 79% of servo travel. At 80% of servo travel and beyond, the Anti-Lock Braking function will Activate when turned ON.

- 1) From within the ALB menu, scroll UP or DOWN to highlight POINT > 80%.
- 2) Press the ENTER key, then scroll UP or DOWN to choose the desired Point percentage value. Increasing the Point percentage value will cause the Anti-Lock Braking function to Activate later and Decreasing the Point percentage value will cause the Anti-Lock Braking function to Activate sooner.

POINT setting range is 5% to 100%. The default setting is 80%.

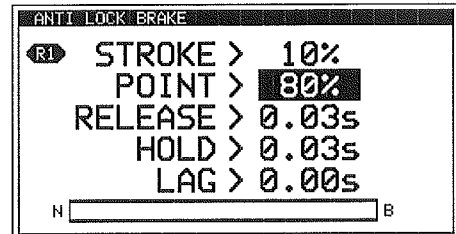

Adjusting the Release and Hold Values:

The Release and Hold values determine the speed at which the Brake pulsates. By adjusting the Release and Hold values, you can make the Brake pulsate Faster or Slower. The Release value determines how quickly the Brake moves from the Point setting to the Stroke setting and the Hold value determines how quickly the Brake moves from the Stroke setting back to the Point setting.

 We recommend using equal Release and Hold values, although different values can be used to fine-tune how the Brake pulsates. Using Lower values make the Brake pulsate Faster and using Higher values make the Brake pulsate Slower.

- 1) From within the ALB menu, scroll UP or DOWN to highlight RELEASE > 0.03s.
- 2) Press the ENTER key, then scroll UP or DOWN to choose the desired Release value in Seconds. Increasing the Release value will cause the Brake to move from the Point setting to the Stroke setting Slower and Decreasing the Release value will cause the Brake to move from the Point setting to the Stroke setting Faster.

RELEASE setting range is 0.01s to 1.00s. The default setting is 0.03s.

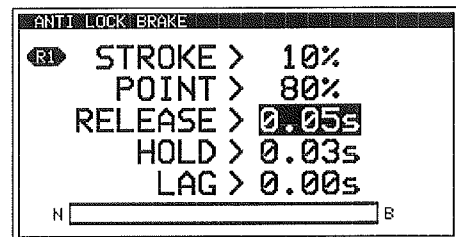

- 3) From within the ALB menu, scroll UP or DOWN to highlight HOLD > 0.03s.
- 4) Press the ENTER key, then scroll UP or DOWN to choose the desired Hold value in Seconds. Increasing the Hold value will cause the Brake to move from the Stroke setting back to the Point setting Slower and Decreasing the Hold value will cause the Brake to move from the Stroke setting back to the Point setting Faster.

HOLD setting range is 0.01s to 1.00s. The default setting is 0.03s.

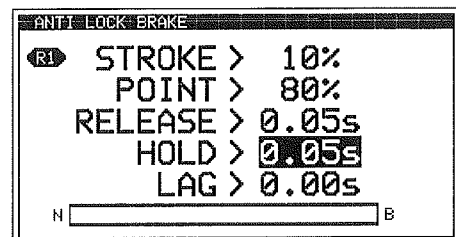

Adjusting the Lag Value:

The Lag value determines the amount of Delay before the Anti-Lock Braking function Activates after reaching the Point setting.

- 1) From within the ALB menu, scroll UP or DOWN to highlight LAG > 0.00s.
- 2) Press the ENTER key, then scroll UP or DOWN to choose the desired Lag value in Seconds. Increasing the Lag value increases the Delay time to Activate the Anti-Lock Braking function after reaching the Point setting and Decreasing the Lag value decreases the Delay time to Activate the Anti-Lock Braking function after reaching the Point setting.

LAG setting range is 0.00s to 1.00s. The default setting is 0.00s.

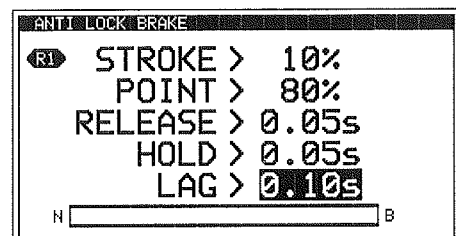

OFFSET MENU (THROTTLE OFFSET)

RACING

The Throttle Offset function allows you to shift the Neutral Point of the Throttle servo to a fixed position, either toward the High Side or the Brake Side, while still allowing you full control of the Throttle. For example, if you're driving a glow- or gas-powered Model, you can use the Throttle Offset function to raise the engine idle for starting or you can program the Throttle Offset function to Increase the engine to a steady idle while you're refueling during a race. If your Model features a separate Brake servo, a Brake Lock function is featured that can be programmed to apply Brake while the Throttle is increased to keep your Model from moving.

 The Throttle Offset function shifts the Neutral Point of the Throttle servo without affecting the High Side or Brake Side End Points. This allows you to have full control over the Throttle even when the Throttle Offset function is turned ON.

M12 2.4GHZ FH4T RADIO CONTROL SYSTEM USER'S GUIDE

OFFSET MENU (THROTTLE OFFSET)

RACING

When the Throttle Offset function is turned ON, [OFFST] ON will be momentarily displayed in a pop-up window, LED1 will flash and an Audible Alarm will sound until the Throttle Offset function is turned OFF.

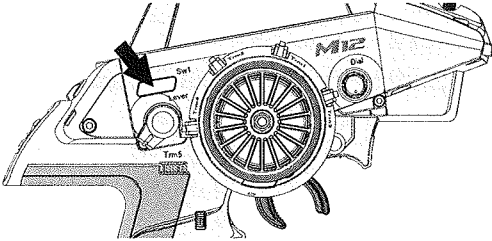

In the default configuration, Push-Button Switch Sw1 turns the Throttle Offset function ON and OFF.

! Throttle Offset Programming Values can be changed while you're driving by Assigning these functions to a Trim Switch, the Auxiliary Dial or the Auxiliary Lever. For more information, see the *ASSIGN Menu* section on pages 33 ~ 38.

Adjusting the Position Percentage Value:

- 1) From within the RACING menu, scroll UP or DOWN to highlight the OFFSET menu.
- 2) Press the ENTER key to open the OFFSET menu. OFFSET > OFF will be highlighted.
- 3) Scroll UP or DOWN to highlight POSITION > 0%.
- 4) Press the ENTER key, then scroll UP or DOWN to choose the desired High Side (H) or Brake Side (B) Position percentage value. The Position percentage value determines the position the Throttle servo Neutral Point will shift to when the Throttle Offset function is turned ON.

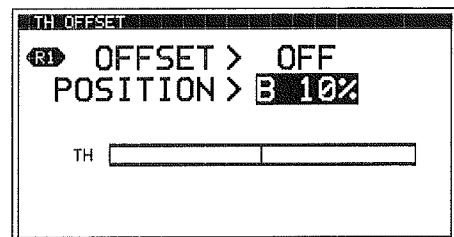
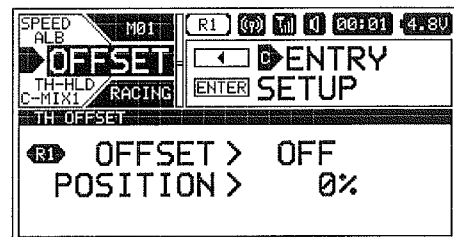

POSITION setting range is H100% to B100%. The default setting is 0%.

Turning the Throttle Offset Function ON and OFF:

- 1) From within the OFFSET menu, scroll UP or DOWN to highlight OFFSET > OFF.
- 2) Press the ENTER key, then scroll UP or DOWN to choose the desired Offset value, either ON or OFF.

OFFSET setting range is ON and OFF. The default setting is OFF.

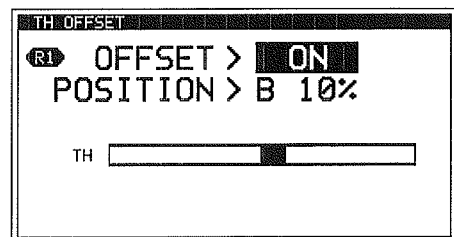

! Remember, the Throttle Offset function can be turned ON and OFF using Push-Button Switch Sw1 without needing to access the OFFSET menu.

Adjusting the Brake Lock Percentage Value:

When Car Type II, III, IV, VI or VII is Selected, the Brake Lock function can be programmed to apply Brake to keep your Model from moving while the Throttle Offset Position is increased. If your Car Type features two separate Brake channels, such as Car Type IV, the Brake Lock percentage value will affect both Brake channels equally.

- 1) From within the OFFSET menu, scroll UP or DOWN to highlight BR-LOCK > OFF.
- 2) Press the ENTER key, then scroll UP or DOWN to choose the desired Brake Lock percentage value. The Brake Lock percentage value determines the position your separate Brake servo (or servos) will shift to when the Throttle Offset function is turned ON.

BR-LOCK setting range is OFF and 0% to 100%. The default setting is OFF.

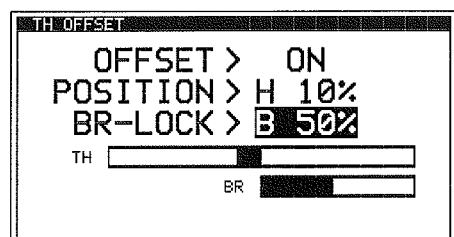

M12 2.4GHZ FH4T RADIO CONTROL SYSTEM USER'S GUIDE

BR-MIX MENU (DUAL BRAKE MIXING)

RACING

The Brake Mixing function allows you change the Brake Bias between the Front and Rear Brakes and is used primarily with 1:5th scale gas-powered Models that use separate Brake servos, although one of the separate Brake servos can be the Brake Side of the Throttle servo, such as when Car Type III is Selected. The Brake Mixing function slows the transit speed of one or both Brake servos, which not only allows to slow down the Braking action, but also allows you to set a Delay between them, which results in you being able to change the Brake Bias.

⚠ Brake Delay Programming Values can be changed while you're driving by Assigning the these functions to a Trim Switch or the Auxiliary Dial. For more information, see the *ASSIGN Menu* section on pages 33 ~ 38.

⚠ The Brake Mixing function is available only when either Car Type III, IV or VII is Selected.

Adjusting the Brake Delay Percentage Value:

1) From within the RACING menu, scroll UP or DOWN to highlight the BR-MIX menu.

2) Press the ENTER key to open the BR-MIX menu. BR-DELAY > 0% will be highlighted.

3) Scroll UP or DOWN to highlight the Brake Delay percentage value you would like to change, either BR-DELAY or BR2-DELAY.

⚠ Which Brake Delay percentage value affects the Front or Rear Brake servo depends on how your Brake servos are plugged into the receiver and will vary.

4) Press the ENTER key, then scroll UP or DOWN to choose the desired Brake Delay percentage value. Increasing the percentage value will slow the transit speed of that Brake servo.

5) Press the ENTER key, then repeat steps 3 and 4 to change the other Brake Delay percentage value, if desired. The larger the difference between the two Brake Delay percentage values, the greater the Brake Bias.

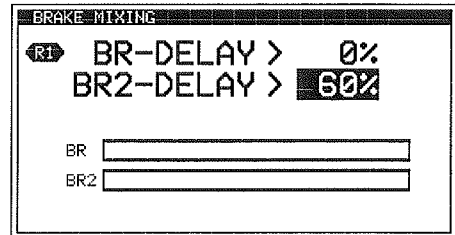
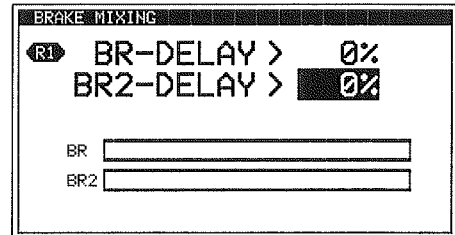
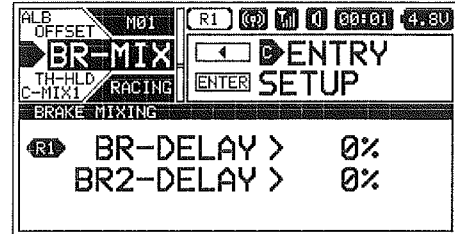

BR-DELAY and BR2-DELAY setting range is 0% to 100%. The default setting for both channels is 0%.

⚠ Setting both Brake Delay percentage values to the same percentage value will result in both Brake servos moving at the same speed. This allows you slow down the Braking action if that is desired. Using different percentage values will result in Brake Bias. You may find that you will need to use a larger percentage value to make a noticeable difference in Brake Bias.

TH-HLD MENU (THROTTLE HOLD)

RACING

The Throttle Hold function moves the Throttle servo to a fixed position, either toward the High Side or the Brake Side, and is used primarily with glow- or gas-powered Models. For example, if you're driving a glow- or gas-powered boat, you can use the Throttle Hold function to stop your engine with only the press of a button. This feature is often referred to as 'Engine Cut'. Alternately, you can use the Throttle Hold function to Increase the engine to a steady idle while you're refueling during a race. This feature is often referred to as 'Idle Up'. If your Model features a separate Brake servo, a Brake ON/OFF function is featured that will allow you to lock out the Brake servo (ON) or allow you control of the Brake servo (OFF) while the Throttle Hold function is turned ON.

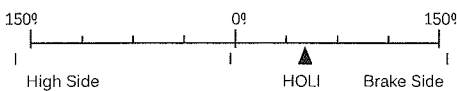

The Throttle Hold function moves the Throttle servo to a fixed position, either toward the High Side or the Brake Side. When the Throttle Hold function is turned ON, you will NOT have control of the Throttle. If your Model has a separate Brake servo and you set the Brake ON/OFF function to OFF, you will still have control over your Model's Brake. To regain Throttle control, you must turn the Throttle Hold function OFF.

WARNING: The Throttle Hold percentage value can be set Higher than your Throttle High Side and Throttle Brake Side End Points. To avoid damage to your Model, we don't suggest programming a Throttle Hold percentage value that exceeds your Throttle High Side or Throttle Brake Side End Points.

M12 2.4GHZ FH4T RADIO CONTROL SYSTEM USER'S GUIDE

TH-HLD MENU (THROTTLE HOLD)

RACING

! So that the Throttle Hold function can be turned ON and OFF while you're driving, it must first be Assigned to a Push-Button Switch. For more information, see the *Push-Button Switch Assignments* section on pages 33 ~ 34. When turned ON and OFF, [TH-HOLD] ACT or [TH-HOLD] INH will be displayed momentarily in a pop-up window.

! The Throttle Hold percentage value can be changed while you're driving by Assigning the Hold function to a Trim Switch or the Auxiliary Dial. For more information, see the *ASSIGN Menu* section on pages 33 ~ 38.

Adjusting the Hold Percentage Value:

- 1) From within the RACING menu, scroll UP or DOWN to highlight the TH-HLD menu.
- 2) Press the ENTER key to open the TH-HLD menu. HOLD > 0% will be highlighted.
- 3) Press the ENTER key, then scroll UP or DOWN to choose the desired Hold percentage value. The Hold percentage value determines the position the Throttle servo will move to when the Throttle Hold function is turned ON. Choosing a Positive Hold percentage value will move the Throttle servo toward the High Side and choosing a Negative Hold percentage value will move the Throttle Servo toward the Brake Side.

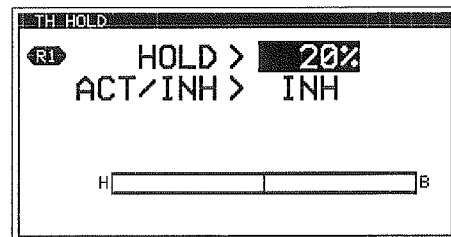
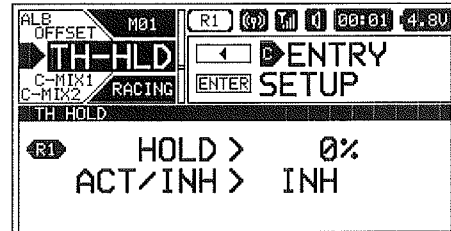

HOLD setting range is 150% to -150%. The default setting is 0%.

! Keep in mind that the Throttle Hold percentage value can be set Higher than your Throttle High Side and Throttle Brake Side End Points. To avoid damage to your Model, we don't suggest programming a Throttle Hold percentage value that exceeds your Throttle High Side or Throttle Brake Side End Points.

Turning the Throttle Hold Function ON and OFF:

- 1) From within the TH-HLD menu, scroll UP or DOWN to highlight ACT/INH > INH.
- 2) Press the ENTER key, then scroll UP or DOWN to choose the desired ACT/INH setting, either ACT (Active ON) or INH (Inhibited OFF).

ACT/INH setting range is ACT and INH. The default setting is INH.

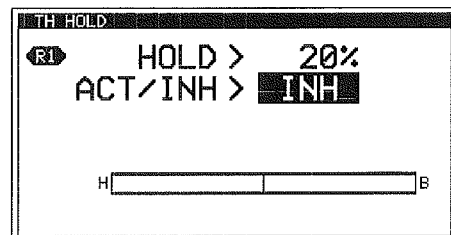

! We suggest Assigning the Throttle Hold function to a Push-Button Switch so that you can turn it ON and OFF without needing to access the TH-HLD menu. See the notation at the top of the page. In addition, ON and OFF behavior will differ based on the ACT/INH setting you choose. We recommend using the INH setting. With this setting, the Throttle Hold function will always be OFF until you turn it ON. If you choose ACT, the Throttle Hold function will always be ON until you turn it OFF.

Choosing the Brake Lock-Out Value:

When Car Type II, III, IV, VI or VII is Selected, the Brake Lock-Out function can be programmed, which gives you the option to lock out the Brake servo(s) or retain control of the Brake servo(s). This gives you the option of controlling your separate Brake servo(s) to keep your Model from moving, even when your engine's idle Increases when the Throttle Hold function is turned ON. If your Car Type features two separate Brake channels, such as Car Type IV, the Brake Lock-Out function will affect both Brake channels equally.

- 1) From within the TH-HLD menu, scroll UP or DOWN to highlight BR > ON.
- 2) Press the ENTER key, then scroll UP or DOWN to choose the desired Brake value, either ON or OFF. When set to ON, your separate Brake servo(s) will be locked out along with the Throttle servo when the Throttle Hold function is turned ON. When set to OFF, you will retain control of your separate Brake servo(s) when the Throttle Hold function is turned ON.

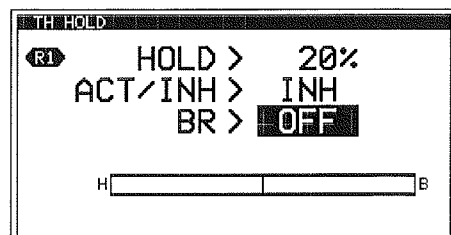

BR setting range is ON and OFF. The default setting is ON.

M12 2.4GHZ FH4T RADIO CONTROL SYSTEM USER'S GUIDE

C-MIX1 AND C-MIX2 MENU (COMPENSATION MIXING 1 AND COMPENSATION MIXING 2) RACING

The Compensation Mixing function is used to create your own custom Mixes that allow you to control any number of desired functions in different combinations. For example, you can use the Compensation Mixing function to deploy an air-Brake when you apply Brake or raise a wing as you Increase Throttle. You could use the Compensation Mixing function to counter-act torque steer by applying a very slight amount of Steering in one direction when you Increase Throttle. The possibilities are nearly endless.

Compensation Mixes are composed of a Master channel and a Slave channel. The Master channel always controls the Slave channel. Any of the four channels can be programmed as a Master or a Slave. The same channel can even be programmed as both a Master and a Slave. Two Rate percentage values can be programmed to determine the direction and amount of travel that the Slave channel servo moves in relation to the Master channel servo. In addition, an Offset function is featured that allows you to shift the Neutral Point of the Slave channel servo to center the Slave channel servo or to shift the Slave channel servo's Neutral Point to change the starting point of your Mix.

Two Compensation Mixers are available, and each can be turned ON separately or both can be turned ON at the same time. A graph is featured to help visualize the Compensation Mixing changes you make.

! Compensation Mixing Programming Values can be changed while you're driving by Assigning these functions to a Trim Switch, the Auxiliary Dial or the Auxiliary Lever. For more information, see the *ASSIGN Menu* section on pages 33 ~ 38.

This section covers both the Compensation Mixing 1 and Compensation Mixing 2 menus, since programming each of them is exactly the same. Choose either the C-MIX1 or the C-MIX2 menu depending on which of the two Compensation Mixers you want to program.

The Compensation Mixing Rate 1 and Rate 2 percentage values determine whether the Compensation Mixer(s) are Active (turned ON) or Inhibited (turned OFF). When no Rate percentage values are programmed, the Compensation Mixer(s) will be Inhibited and when a Rate percentage value is programmed, the Compensation Mixer(s) will become Active. To turn the Compensation Mixer(s) ON and OFF while you're driving, you will need to program the Compensation Mixer(s) with a Rate value to one Racing Mode (turned ON), then switch to a Racing Mode without any Compensation Mixer Rate values programmed (turned OFF).

Compensation Mixing 1 Steering to Throttle Mix Example:

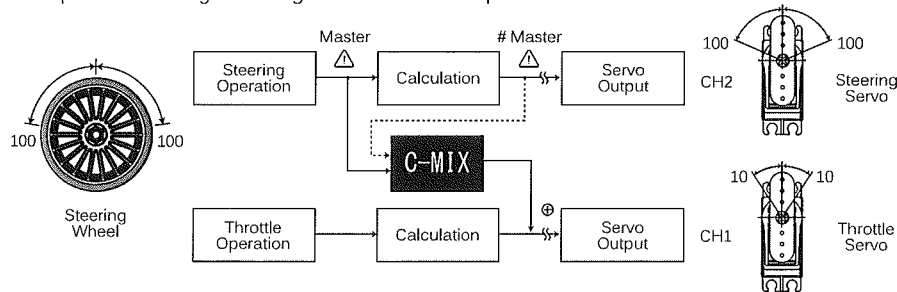

In the example above, Compensation Mixing 1 is programmed as follows: MASTER > ST, SLAVE > TH, RATE1 > 10%, RATE2 > 10% and OFFSET > 0. When you move the Steering Wheel 100% in each direction, the Steering servo will travel 100% in each direction and at the same time, the Throttle servo will travel 10% in each direction.

! Compensation Mixing Rate percentage values are a Ratio of Slave channel servo travel to Master channel servo travel. For example, if both Rate percentage values are set to 10%, the Throttle servo will travel 1:10th the amount as the Steering servo travels in both directions. Compensation Mixes are Linear throughout the entire range of travel. If a Rate value of 0% is chosen, the Slave servo will not move in that direction.

Available channels vary based on the Car Type currently chosen. The table below shows the available channels for each Car Type. See the table on the next page that describes the Channel Output Data of each of these channels. Channels denoted with a Pound sign (#) can be Selected only as Master channels. All other channels can be Selected as Master or Slave channels.

CH \ TYPE	TYP I	TYP II	TYP III	TYP IV	TYP V	TYP VI	TYP VII	TYP VIII	TYP IX	TYP X
CH 1	ST	ST	ST	ST	ST	ST	ST	ST	ST	ST
	#ST	#ST	#ST	#ST	#L-ST	#L-ST	#L-ST	#F/ST	#ST	#F/ST
CH 2	TI	TI	TI	TI	TI	TI	TI	TI	TI	TI
	#TI	#TI	#TI	#TI	#TI	#TI	#TI	#TI	#F/TI	#F/TI
CH 3	AUX1	BR	BR2	BR	---	---	---	---	---	---
	#AUX1	#BR	#BR2	#BR	#R-ST	#R-ST	#R-ST	#R/ST	#R/TI	#R/ST
CH 4	AUX2	AUX	AUX	BR2	AUX	BR	BR2	AUX	AUX	---
	#AUX2	#AUX	#AUX	#BR2	#AUX	#BR	#BR2	#AUX	#AUX	#R/TI

ST=Steering • TH=Throttle • BR=Brake • BR2=Brake 2 • R-ST=Right • L-ST=Left • R/ST or R/TH=Rear • F/ST or F/TH=Front

M12 2.4GHZ FH4T RADIO CONTROL SYSTEM USER'S GUIDE

C-MIX1 AND C-MIX2 MENU (COMPENSATION MIXING 1 AND COMPENSATION MIXING 2) RACING

The table below shows the Channel Output Data of each Master channel. This is the Data that will be duplicated on the Slave channel when Compensation Mixing is turned ON. Master channels denoted with a Pound sign (#) indicate that not only is the Raw Output Data duplicated on the Slave channel, but the other functions described are also duplicated on the Slave channel. For example, if MASTER > #ST is Selected, any Master channel Steering Trim, End Point Adjustments, Dual Rate, Curve and Speed values, plus the Raw Output Data will be duplicated on the Slave channel. Alternately, if you Select MASTER > ST, only Curve and Speed values, plus the Raw Output Data will be duplicated on the Slave channel.

CH.	CH. NAME	CH. OUTPUT DATA
ST	Steering	Raw Output Data, Plus CURVE and SPEE
#ST	# Steering	Raw Output Data, Plus TRIM, EPA, D/R, CURVE and SPEE
#L-ST	# Left Steering	Raw Output Data, Plus TRIM, EPA, D/R, CURVE and SPEE
#F/ST	# Front Steering	Raw Output Data, Plus TRIM, EPA, D/R, CURVE and SPEE
TI	Throttle	Raw Output Data, Plus CURVE, SPEED and BR-MIX
#TI	# Throttle	Raw Output Data, Plus TRIM, EPA, D/R, CURVE, SPEED, ALB, OFFSET, BR-MIX and TH-HOLI
#F/TI	# Front Throttle	Raw Output Data, Plus TRIM, EPA, D/R, CURVE, SPEED, ALB, OFFSET, BR-MIX and TH-HOLI
AUX1	Auxiliary 1	Raw Output Data, Plus CURVE and SPEED (Referred to as AUX in some Car Types)
BR	Brake	Raw Output Data, Plus CURVE, SPEED and BR-MIX
BR2	Brake 2	Raw Output Data, Plus CURVE, SPEED and BR-MIX
#AUX1	# Auxiliary 1	Raw Output Data, Plus TRIM, EPA, D/R, CURVE and SPEE
#BR	# Brake	Raw Output Data, Plus TRIM, EPA, D/R, CURVE, SPEED, ALB, OFFSET, BR-MIX and TH-HOLI
#BR2	# Brake 2	Raw Output Data, Plus TRIM, EPA, D/R, CURVE, SPEED, ALB, OFFSET, BR-MIX and TH-HOLI
#R-ST	# Right Steering	Raw Output Data, Plus TRIM, EPA, D/R, CURVE and SPEE
#R/ST	# Rear Steering	Raw Output Data, Plus TRIM, EPA, D/R, CURVE and SPEE
#R/TI	# Rear Throttle	Raw Output Data, Plus TRIM, EPA, D/R, CURVE, SPEED, ALB, OFFSET, BR-MIX and TH-HOLI
AUX2	Auxiliary 2	Raw Output Data, Plus CURVE and SPEE
#AUX2	# Auxiliary 2	Raw Output Data, Plus TRIM, EPA, D/R, CURVE and SPEE

Choosing the Master Channel:

- 1) From within the RACING menu, scroll UP or DOWN to highlight either the C-MIX1 or the C-MIX2 menu depending on which Compensation Mixer you want to program. In this section, we show programming Compensation Mixer 1.

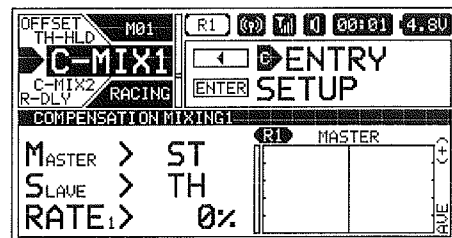

- 2) Press the ENTER key to open the C-MIX1 menu. MASTER > ST will be highlighted.
- 3) Press the ENTER key, then scroll UP or DOWN to choose the desired Master channel.

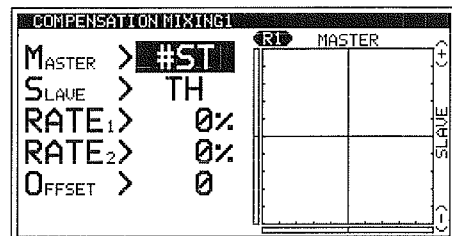

Choosing the Slave Channel:

- 1) From within the C-MIX1 menu, scroll UP or DOWN to highlight SLAVE > TH.
- 2) Press the ENTER key, then scroll UP or DOWN to choose the desired Slave channel.

Channels denoted with a Pound (#) sign cannot be chosen as Slaved channels.

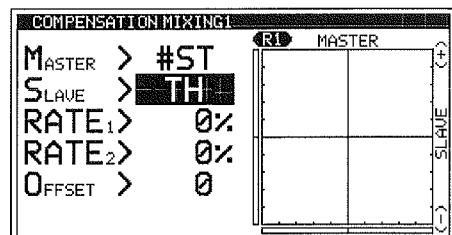

M12 2.4GHZ FH4T RADIO CONTROL SYSTEM USER'S GUIDE

C-MIX1 AND C-MIX2 MENU (COMPENSATION MIXING 1 AND COMPENSATION MIXING 2) RACING

Choosing the Rate 1 and Rate 2 Percentage Values:

The Rate percentage values determine the amount and direction of Slave channel servo travel. Use a Positive or Negative percentage value to change the amount and direction of Slave channel servo travel. The Right side of the graph indicates Rate 1 percentage values and the Left side of the graph indicates Rate 2 percentage values.

- 1) From within the C-MIX1 menu, scroll UP or DOWN to highlight either RATE1 > 0% or RATE2 > 0%.
- 2) Press the ENTER key, then scroll UP or DOWN to choose the desired Rate 1 or Rate 2 percentage value.

RATE1 and RATE2 setting range is -150% to 150%. The default setting for both Rate percentage values is 0%.

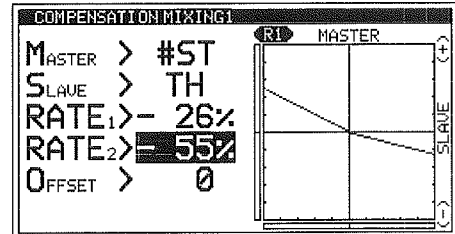

WARNING: The Rate percentage values can be set Higher than your Slave channel servo End Points (up to 150% in either direction). To avoid damage to your Model, we don't suggest programming Rate percentage values that exceed your Slave channel servo End Points.

⚠ When the Master and Slave are set to the same channel, Mixing takes place within the channel itself. This causes servo travel to Increase for Positive Rate percentage values and servo travel to Decrease for Negative Rate percentage values.

Choosing the Channel Offset Value:

The Offset function allows you to shift the Neutral Point of the Slave channel servo to compensate for any Master channel servo Trim or to change the starting point of your Mix.

- 1) With the Master channel control centered, check the Master Travel Indicator at the bottom of the graph to see if any Master channel Trim is displayed.

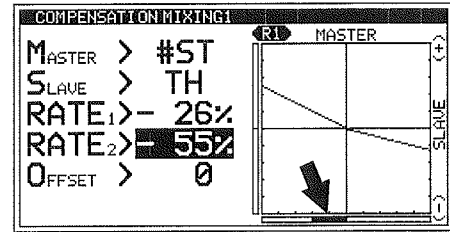

- 2) From within the C-MIX1 menu, scroll UP or DOWN to highlight OFFSET > 0.
- 3) Press the ENTER key, then scroll UP or DOWN to choose the desired Slave channel Offset value. Increase or Decrease the Offset value to move the vertical axis in the desired direction.

OFFSET setting range is -150 to 150. The default setting is 0%.

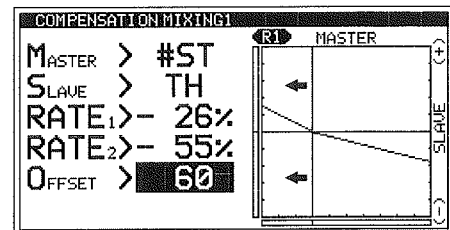

⚠ Adjust the Offset value to move the vertical axis and erase the Trim deviation from the Master Travel Indicator. If there is no Trim deviation displayed, you can simply position the starting point of your Mix by choosing the desired Offset value.

When the Auxiliary Dial is programmed to control Auxiliary 1 or Auxiliary 2 and you choose AUX1 or AUX 2 (or #AUX1 or #AUX2) to be the Master channel, by setting the Offset value to 100 or -100, the Auxiliary Dial can control the full range of Mixing travel in one direction, instead of half the Mixing travel in one direction and half the Mixing travel in the other direction. This is useful if you want the full range of Mixing travel in only one direction.

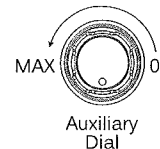

⚠ Setting the Offset value to a value greater than -100 or 100 will shift the Neutral Point of the Slave channel servo beyond the operation range of the Auxiliary Dial and is not recommended.

Following the example in the diagram at Right, set the Rate 1 percentage value to 0% and the Rate 2 percentage value to -50%, then set the Offset value to -100. The full range of Mixing travel can now be adjusted in one direction when turning the Auxiliary Dial counter-clockwise.

⚠ This same technique can also be used if you're using the Auxiliary Lever to control either Auxiliary 1 or Auxiliary 2.

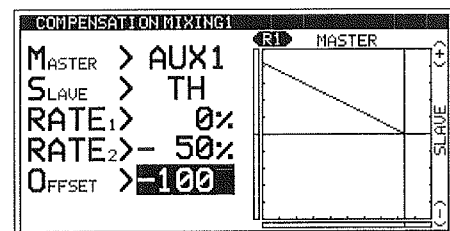

M12 2.4GHZ FH4T RADIO CONTROL SYSTEM USER'S GUIDE

ACKER MENU (ACKERMAN ANGLE ADJUSTMENT)

RACING

The Ackerman function allows you to change the Steering angle of the Front tires independently to prevent the tires from slipping during turns. Being able to change the Ackerman Angle can help improve your Model's high-speed cornering and improve tire wear. In general, your Model will corner better if the inner tire turns in at a sharper angle than the outer tire. The Ackerman function allows you reduce the turn-in angle of the outer tire, which increases the turn-in angle of the inner tire relative to it.

⚠ Ackerman Programming Values can be changed while you're driving by Assigning these functions to a Trim Switch, the Auxiliary Dial or the Auxiliary Lever. For more information, see the *ASSIGN Menu* section on pages 33 ~ 38.

⚠ The Ackerman function is available only when either Car Type V, VI or VII is Selected.

Adjusting the Ackerman Angle Percentage Values:

- 1) From within the RACING menu, scroll UP or DOWN to highlight the ACKER menu.
- 2) Press the ENTER key to open the ACKER menu. LEFT-ST L > 100% will be highlighted.
- 3) Scroll UP or DOWN to highlight the Ackerman Angle percentage value you would like change. Choose from either LEFT-ST (Left Steering) Left or Right, or RIGHT-ST (Right Steering) Left or Right.
- 4) Press the ENTER key, then scroll UP or DOWN to choose the desired Ackerman Angle percentage value. Reducing the Ackerman Angle percentage value will reduce the amount of control throw in that the direction for that specific servo.
- 5) Press the ENTER key, then repeat steps 3 and 4 to change any other desired Ackerman Angle percentage values.

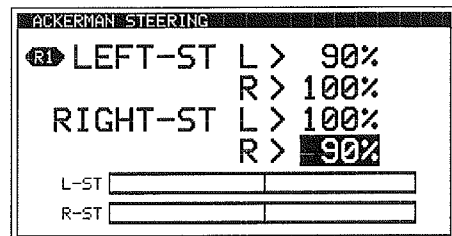
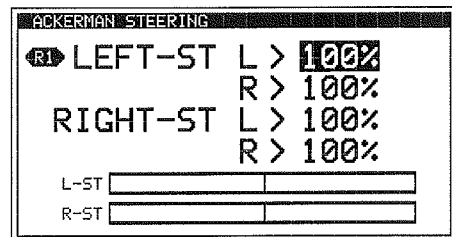
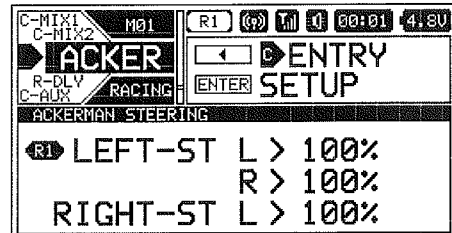

LEFT-ST L and R and RIGHT-ST L and R setting range is 0% to 100%. The default setting for both channels is 100%.

⚠ In general, you want the inner tire to turn in more than the outer tire when turning both Right and Left (unless you're running on an oval track). In order to achieve this, you will need to reduce the control throw of the outer tire in both the Right and Left directions by reducing those Ackerman Angle percentage values. The percentage values you will need to change will vary depending on several factors, so you'll need to experiment to find the ones you need to reduce to achieve the desired results.

R-DLY MENU (RACING MODE DELAY)

RACING

The Racing Mode Delay function allows you to program a Delay for each of the four channels to help prevent drastic changes in channel function settings when switching between Racing Modes. For example, you might have one Dual Rate setting for Racing Mode 1 and a different Dual Rate setting for Racing Mode 2. The Racing Mode Delay function allows you to program a Delay in the Steering channel so that the transition to the different Dual Rates when you switch back and forth between Racing Modes is smooth and less noticeable.

⚠ Racing Mode Delay Programming Values can be changed while you're driving by Assigning these functions to a Trim Switch, the Auxiliary Dial or the Auxiliary Lever. For more information, see the *ASSIGN Menu* section on pages 33 ~ 38.

Adjusting the Racing Mode Delay Percentage Values:

- 1) From within the RACING menu, scroll UP or DOWN to highlight the R-DLY menu.

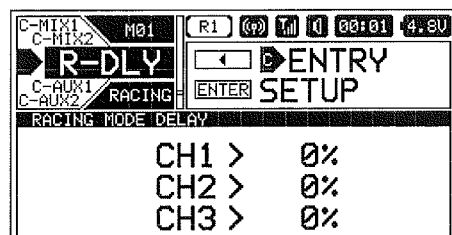

M12 2.4GHZ FH4T RADIO CONTROL SYSTEM USER'S GUIDE

R-DLY MENU (RACING MODE DELAY)

RACING

Adjusting the Racing Mode Delay Percentage Values, Continued...

2) Press the ENTER key to open the R-DLY menu. CH1 > 0% will be highlighted.

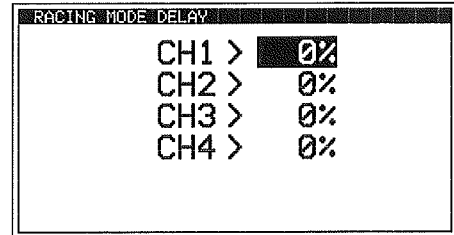

3) Scroll UP or DOWN to highlight the desired channel you want to change the Racing Mode Delay percentage value for.

4) Press the ENTER key, then scroll UP or DOWN to choose the desired Racing Mode Delay Percentage value. Increasing the Racing Mode Delay Percentage value will increase the Delay when switching between Racing Modes.

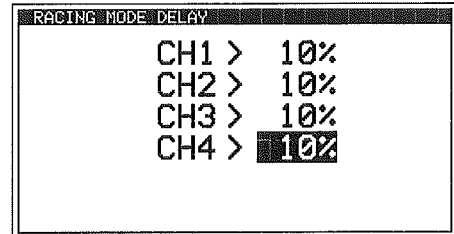

5) Press the ENTER key, then repeat steps 3 and 4 to change any other desired Racing Mode Delay percentage values.

CH1, CH2, CH3 and CH4 setting range is 0% to 100%. The default setting for all channels is 0%.

! The Racing Mode Delay function changes the speed of the servos as they move to their new positions when you switch between Racing Modes. The Higher the Racing Mode Delay percentage value, the Slower the servos will transition to their new positions when you switch Racing Modes, but the smoother the transition will be. You will need to experiment with different percentage values to find a happy medium of smooth, yet quick transition. When the Racing Mode Delay Percentage value is set to 0%, there will be no Delay and the transition between Racing Modes will be immediate.

CODEAX1 AND CODEAX2 MENU (CODE AUXILIARY 1 AND CODE AUXILIARY 2)

SETUP

The Code Auxiliary function is used with future connected products, such as an ESC, whose Programming Parameters can be changed directly via the transmitter. For example, you might be able to change the connected ESC's Driving Modes directly using the Auxiliary Dial to suit different conditions while you're driving.

! Code Auxiliary Programming Values can be changed while you're driving by Assigning these functions to a Trim Switch, the Auxiliary Dial or the Auxiliary Lever. For more information, see the *ASSIGN Menu* section on pages 33 ~ 38.

! This section covers both the Code Auxiliary 1 and Code Auxiliary 2 menus, since programming each of them is exactly the same. Choose either the CODEAX1 or the CODEAX2 menu depending on which of the two Code Auxiliary functions you want to program.

Changing the Code Auxiliary Values:

1) From within the RACING menu, scroll UP or DOWN to highlight either the CODEAX1 or the CODEAX2 menu depending on which Code Auxiliary function you want to program. In this section, we show programming Code Auxiliary 1.

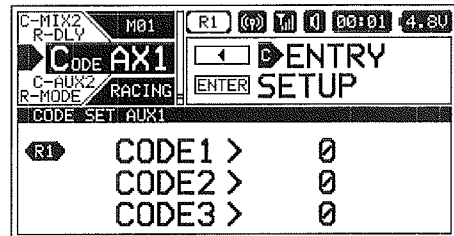

2) Press the ENTER key to open the CODEAX1 menu. CODE1 > 0 will be highlighted.

3) Scroll UP or DOWN to highlight the desired Code Auxiliary value you would like to change.

4) Press the ENTER key, then scroll UP or DOWN to choose the desired Code Auxiliary value.

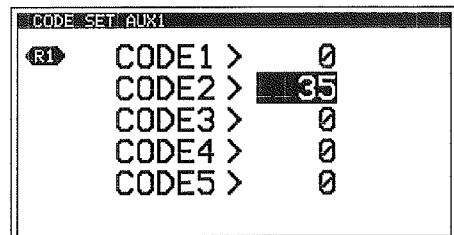

5) Press the ENTER key again, then repeat steps 3 and 4 to change any other desired Code Auxiliary values.

CODE1, CODE2, CODE3, CODE4 and CODE5 setting range is -100 to 100. The default setting for all Code Auxiliary functions is 0 (OFF).

M12 2.4GHZ FH4T RADIO CONTROL SYSTEM USER'S GUIDE

CUSTOM MENU OVERVIEW

CUSTOM

To access the CUSTOM menu, turn the transmitter ON, then press the SELECT switch to highlight the CUSTOM menu.

Press the ENTER key to open the CUSTOM menu. The CUSTOM menu features the CH-SET menu and any other favorite Programming Menus you've added.

Scroll UP or DOWN to highlight the desired Programming Menu, then press the ENTER key to open that menu.

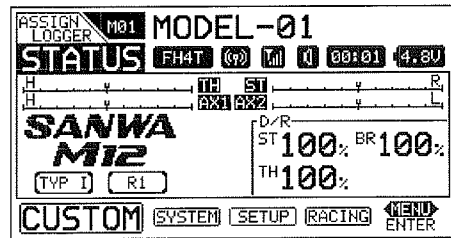

The following Programming Menus are available within the CUSTOM menu:

MENU	MENU DESCRIPTION	PAGE #
CH-SET	Adjust Programming Values for Common Functions in One Convenient Location	PG. 94

CH-SET MENU (CHANNEL SET MENU)

CUSTOM

The CH-SET menu allows you to make a number of common function Programming Value changes to all four channels without the need to enter each of those function's Programming Menus separately. For example, you can make all of your desired Programming Value choices for functions such as End Point Adjustment, Exponential, Curves, Servo Speed, Fail Safe settings and more for each channel, all from within the same menu.

If Racing Mode is turned ON and if you've chosen to program one or more Racing Mode functions separately, a Racing Mode Icon will be displayed next to the function Programming Value to indicate which Racing Mode you're currently programming the function for. For more information, see the *R-MODE Menu* section on pages 75 ~ 76.

! This section details how to use the CH-SET menu. For information about programming each of the Programming Menus within the CH-SET menu, refer to the specific Programming Menu sections detailed previously.

Choosing the Channel:

- From within the CUSTOM menu, scroll UP or DOWN to highlight the CH-SET menu.

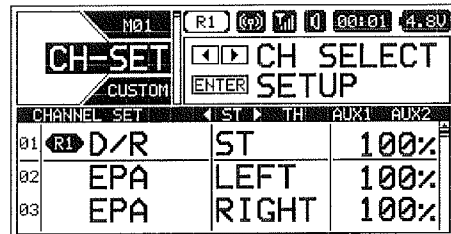

- Press the ENTER key open the CH-SET menu. The < ST > channel will be Selected.
- Press the SELECT switch RIGHT or LEFT to choose the desired channel you would like to change function Programming Values for.

! Channels and function Programming Values will vary depending on the current Car Type.

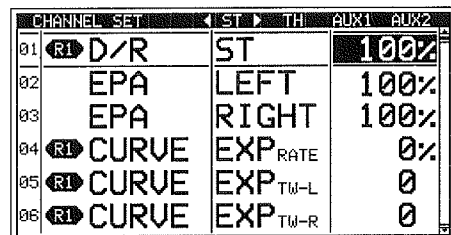

Changing Function Programming Values:

- After selecting the desired channel, scroll UP or DOWN to highlight the function Programming Value you would like to change.
- Press the ENTER key, then scroll UP or DOWN to choose the Selected function Programming Value.
- Press the ENTER key, then repeat steps 1 and 2 to change any other desired function Programming Values.

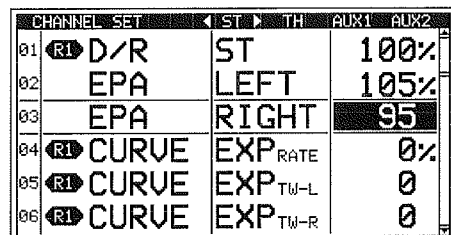

! Certain function Programming Values may not be displayed in the CH-SET menu because they haven't been Selected in the specific function's Programming Menu. For example, the CURVE EXP function Programming Value may be displayed in the CH-SET menu, but if you want to change the CURVE ARC function through the CH-SET menu, you will need to first choose the ARC function in the CURVE menu first. The CURVE ARC function Programming Value will then be able to be changed through the CH-SET menu.

! Function Programming Values changed from within the CH-SET menu are duplicated in the specific function's Programming Menu and vice-versa.

M12 2.4GHZ FH4T RADIO CONTROL SYSTEM USER'S GUIDE

ADDING AND REMOVING FAVORITE MENUS

CUSTOM

Many Programming Menus can be Added to the CUSTOM menu quickly and easily. This allows you to store and then access your most-used Programming Menus all in one place within the CUSTOM menu.

⚠ Not all Programming Menus can be added to the CUSTOM menu. If a Programming Menu can be added to the CUSTOM menu, 'C' ENTRY will be displayed in the Message Display Window when you highlight the Programming Menu.

Adding Programming Menus to the CUSTOM Menu:

- 1) Highlight the Programming Menu you would like to add to the CUSTOM menu. 'C' ENTRY will be displayed in the Message Display Window.

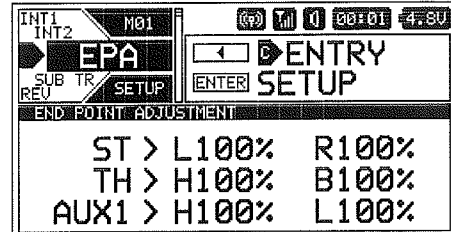

- 2) Press the SELECT switch in the direction of the arrow (LEFT). A 'C' will be displayed in the Pointer next to the Menu Name, indicating the Programming Menu is now added to the CUSTOM menu and CANCEL will now be displayed in the Message Display Window.

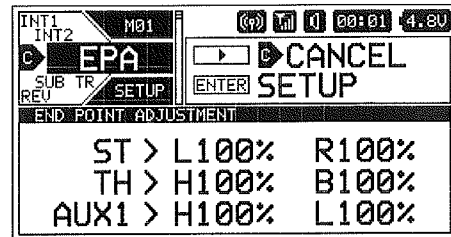

Removing Programming Menus From the CUSTOM Menu:

- 1) Highlight the Programming Menu you would like to remove from the CUSTOM menu. 'C' CANCEL will be displayed in the Message Display Window and a 'C' will be displayed in the Pointer next to the Menu Name, indicating the Programming Menu is part of the CUSTOM menu.

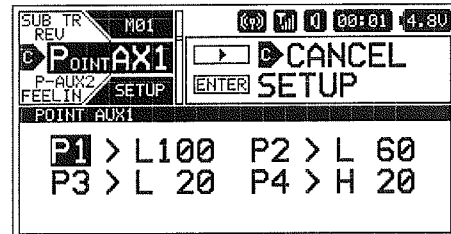

- 2) Press the SELECT switch in the direction of the arrow (RIGHT). The 'C' will be removed from the Pointer next to the Menu Name, indicating the Programming Menu has now been removed from the CUSTOM menu and ENTRY will be displayed in the Message Display Window.

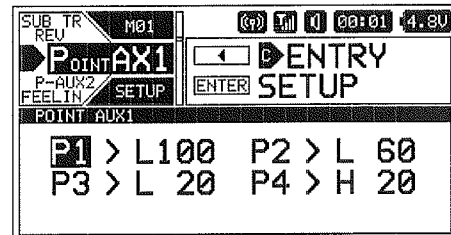

M12 2.4GHZ FH4T RADIO CONTROL SYSTEM USER'S GUIDE

TELEMETRY CONNECTIONS AND MOUNTING

REFERENCE

When used with an Airtronics 2.4GHz FH4T Telemetry-capable surface receiver, such as the RX-461 or RX-462, and up to two Temperature Sensors and an RPM Sensor (all available separately), Telemetry Data, such as RPM or Speed, Temperature, and Receiver Voltage can be viewed on the M12 transmitter's TELEMETRY screen.

This section details connecting the RPM and Temperature Sensors to the RX-461 and/or RX-462 receiver and how to mount those Sensors into your Model. For more information about the specifics of either receiver, refer to the User's Guide included with your receiver.

! For more information about viewing Telemetry Data on the TELEMETRY screen, see the *TELEMETRY Screen Overview* section on pages 22 ~ 23. For more information about choosing Telemetry options, see the *LOG SETUP Menu* section on pages 48 ~ 56.

Overview:

The RX-461 and RX-462 receivers each feature two Temperature Sensor Inputs and one RPM Sensor Input, in addition to the Voltage Sensor built into the receiver. Temperature and RPM Sensors can be installed into your Model to give you Temperature and RPM or Speed feedback in real-time displayed on the transmitter's TELEMETRY screen.

! The range of the Telemetry System is approximately 260 feet (80 meters), although the range can vary based on many environmental factors. Use the Telemetry Signal Indicator to determine the quality of the Telemetry Signal.

Plugging the Telemetry Sensors into the Receiver:

- 1) Carefully pry up and remove the plastic cover from over the Telemetry Sensor Input Ports on the receiver.
- 2) Plug the Telemetry Sensor(s) into their respective Input Ports in the receiver. The Temperature Sensor can be plugged into either the TEMP 1 or the TEMP 2 Input Port and the RPM Sensor is plugged into the RPM Input Port. The Sensor Plugs are indexed so they can be plugged in only one way.

! Make sure to push the Sensor Plugs firmly in place to ensure a good connection. When routing Sensor Wires inside your Model, be careful that they cannot come into contact with any moving parts. The Sensor Wires should be securely mounted and protected against damage. In addition, install the dust covers included with your receiver to prevent dirt and debris from getting into any unused Input Ports.

Mounting the RPM Sensor:

The RPM Sensor uses infrared technology to record RPM data from a rotating part, such as a flywheel or a spur gear. One Black and one White reflective decal is included that is attached to the rotating part so the Sensor Pickup can 'see' it.

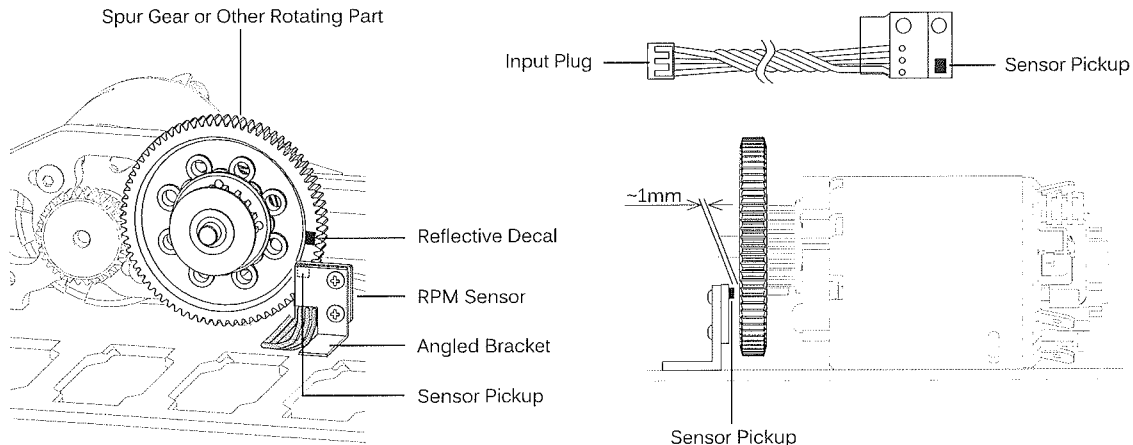

- 1) Mount the RPM Sensor to an aluminum or ABS angled bracket, then mount the bracket to your Model, making sure that it's held securely in place. **For optimal operation, the Sensor Pickup should be positioned approximately 1mm away from the rotating part (flywheel, spur gear, pinion gear etc.)**
- 2) Cut one of the two reflective decals included with the RPM Sensor into an ~2mm diameter and apply it to the rotating part, so that as the part rotates, the reflective decal passes in front of the Sensor Pickup. If the rotating part is metallic-colored (silver, aluminum, chrome, etc.), use the Black reflective decal and if the rotating part is dark-colored (black, blue or another dark color), use the White reflective decal.

! When installed, it's important that the Sensor Pickup face the rotating part and that the Black or White reflective decal is positioned so that it passes in front of the Sensor Pickup. It's also important that the reflective decal contrasts with the rotating part it's applied to and that the Sensor Pickup is mounted approximately 1mm away from the rotating part.

! After installing the RPM Sensor and connecting it to your receiver, the RPM Sensor must be calibrated. For more information, see the *RPM and Speed Telemetry Data Display Options* section on pages 48 ~ 50.

M12 2.4GHZ FH4T RADIO CONTROL SYSTEM USER'S GUIDE

TELEMETRY CONNECTIONS AND MOUNTING

REFERENCE

Mounting the Temperature Sensor:

- 1) Secure the Sensor End directly against the part of your engine, motor, battery or other object you want to monitor temperature readings from, using either a nylon cable tie or high-temperature clear tape. For example, to monitor the cylinder head temperature of your glow-powered Model, the best place to secure the Sensor End is where the bottom of the cylinder head meets the top of the engine case. The Sensor End can be held in place using a nylon cable tie wrapped around your engine. To monitor the temperature of your battery pack or electric motor, high-temperature clear tape can be used to secure the Sensor End to the exact spot you want to monitor.

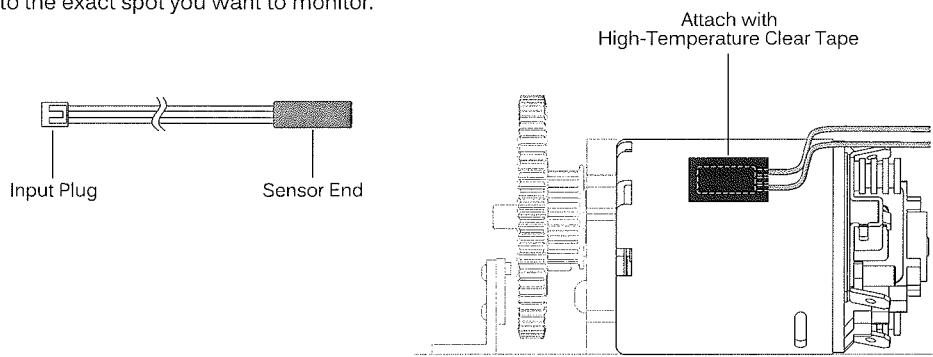

TROUBLESHOOTING GUIDE

REFERENCE

This troubleshooting guide can help you diagnose and solve some of the more common problems that you may encounter with your radio control system.

If you cannot solve the problem using this troubleshooting guide, please contact Airtronics Customer Service using the information in the *Service and Support* section on page 3.

PROBLEM	CAUSE	SOLUTION
Transmitter does not turn On	Transmitter batteries installed incorrectly	Reinstall batteries, observing correct polarity
	Battery tray not plugged in	Plug in battery tray
	Transmitter batteries are dead	Replace or recharge transmitter batteries
	Damage caused by using incorrect charger or reverse polarity	Contact Airtronics Customer Service
Transmitter will not bind to receiver	Modulation Type incorrect	Change Modulation Type to match receiver
	Too much time elapsed after pressing receiver Bind Button	Quickly press ENTER key in BIND menu after releasing receiver Bind Button
	Attempting to Bind incompatible receiver	Use only Airtronics 2.4GHz FH2, FH3, FH4 or FH4T surface receivers
	Using Electronic Speed control (ESC)	Disconnect ESC and use dry cell battery for Binding procedure, then reconnect ESC after Binding
	Receiver batteries are dead	Replace or recharge receiver batteries
	Using incorrect Binding procedure	Follow Binding procedure carefully
Receiver won't power On	Receiver batteries are dead	Replace or recharge receiver batteries
	Receiver batteries not installed correctly	Reinstall receiver batteries, observing correct polarity
	Loose switch connection	Double-check all connections including switch
Audible alarm beeps continuously	Low transmitter battery voltage	Replace or recharge transmitter batteries
	Transmitter left ON 10 minutes or more without control input	Move Steering Wheel or Throttle Trigger, or press any key to clear alarm and continue operation
	Transmitter battery voltage too high	Use transmitter battery whose voltage is 9.6 volts or less when fully charged
One or more LEDs flashing	Indicates transmitter status	For more information, see LED Condition Indicators table on page 10.
No key-press, Trim, alarm or alert sounds	Audible tones are Muted	Increase Tone volume in BUZZER menu
Servo movement is slow	Low receiver battery voltage	Replace or recharge receiver batteries
	Control linkages binding	Adjust control linkages to operate smoothly
	Using a negative Servo Speed value	Increase Servo Speed value

M12 2.4GHZ FH4T RADIO CONTROL SYSTEM USER'S GUIDE

PROBLEM	CAUSE	SOLUTION
Servo does not move when using Trim Switch	Trim is outside of operational range	Center Trim Switches to '0', center the servo horn and control linkages
Inadequate transmitting range	Low transmitter battery voltage	Replace or recharge transmitter battery
	Low receiver battery voltage	Replace or recharge receiver batteries
	Receiver antenna not mounted correctly	Mount receiver antenna as recommended
Servo(s) move the wrong direction	Incorrect Servo Reversing setting	Change Servo Reversing setting
Servo Horn(s) not centered	Servo horn not installed correctly	Turn servo horn 180° and reinstall
	Servo Sub-Trim out of adjustment	Adjust Servo Sub-Trim to center servo horn
Control linkage(s) bind	To much servo travel	Decrease servo travel using EPA function
Servo moves too much or not enough when Trim Switch is pressed	Trim Step resolution requires adjustment	Adjust Trim Step resolution
Throttle servo moves to programmed position without input	Receiver battery voltage has reached programmed Receiver Battery Voltage Fail Safe voltage value	Replace or recharge the receiver batteries
Can't program Receiver Battery Voltage Fail Safe	Throttle channel Fail Safe value set to FREE or HOLI	Set Throttle channel Fail Safe to a percentage value
LCD is difficult to read	Transmitter left in direct sunlight too long	Place transmitter in shade
	Contrast setting too high or too low	Readjust contrast setting
Throttle servo pulsates	ABS function is turned OI	This is normal under Braking with ABS function OI
Model veers right or left without control input	Steering out of trim	Use Steering Trim Switch to adjust Steering Trim so model drives straight
Model accelerates without control input	Throttle out of trim	Use Throttle Trim Switch to adjust Throttle Neutral Point
	Throttle Offset function turned OI	Turn Throttle Offset function OFF
	Throttle Hold function turned OI	Turn Throttle Hold function OFF
Model does not react to Throttle	Throttle Hold function turned OI	Turn Throttle Hold function OFF
No Telemetry connection	Telemetry system turned OFF	Turn Telemetry system OI
	Using FH2, FH3 or FH4 receiver	Use FH4T Telemetry receiver
	Out of Telemetry receiving range	Shorten distance between transmitter and receiver
Can't change Racing Modes	Racing Mode Inhibited (turned OFF)	Activate (turn ON) Racing Mode
Can't program RACING menu functions separately for each Racing Mode	SEPARATE value for functions in R-MODE menu set to OFF	Change SEPARATE value in R-MODE menu ON for desired functions
	Not choosing desired Racing Mode first	Choose desired Racing Mode to program function for, then program function
Model seems extremely sensitive to control input	Dual Rate value(s) set too high	Decrease Dual Rate value(s)
	Feeling value set too high	Decrease Feeling value
Transmitter does not control model	Safety Link Number doesn't match Selected Model	Choose correct Model that matches receiver or Bind Model again with correct Safety Link Number
	No RF Signal from transmitter	Transmitter is not turned ON. Only LCD is turned ON using DISPLAY key
	Transmitter in Receiver Mode	Turn DISPLAY OFF, then turn transmitter OI
Servo(s) and/or ESC don't operate at all or operate erratically	Using incorrect Servo Mode setting	Use correct Servo Mode setting based on the type of servos you're using in your Model. Use NOR mode for Throttle channel if using ESC
Direction of travel shown on Servo Monitor is different from control input travel	This is normal	Direction of travel displayed will vary depending on Servo Reversing settings
There is no LCD Backlighting	LCD Backlighting is turned OFF	Set LCD MODE to Key-On or Always
LCD Backlighting keeps turning OFF	LCD MODE is set to Key-On	This is normal to save battery power. Increase TIME value or set LCD MODE to Always
Can't control underscore when changing Model Name or User Name	Cursor is Active in Character Select screen	Press BACK key to re-gain control of underscore
Telemetry Data doesn't record when Lap Timer is Started	Telemetry Data Recording function turned OFF	Turn Telemetry Data Recording function OI
Can't clear Lap Timer	This is normal	Lap Timer will clear when you Start the Lap Timer again
Steering Wheel and/or Throttle Trigger won't center	Spring tension set too loose	Tighten spring tension

M12 2.4GHZ FH4T RADIO CONTROL SYSTEM USER'S GUIDE

RACING MODE FUNCTIONS BY CAR TYPE

REFERENCE

The table below shows the available Racing Mode functions by Car Type and channel.

FUNCTION		TYPE	TYP I	TYP II	TYP III	TYP IV	TYP V	TYP VI	TYP VII	TYP VIII	TYP IX	TYP X
D/R	CH1		ST	ST	ST	ST	ST	ST	ST	ST	ST	ST
	CH2		TH/BR	TI	TH/BR	TI	TH/BR	TI	TH/BR	TH/BR	TH/BR	TH/BR
	CH3		---	BR	BR2	BR	ST	ST	ST	ST	---	ST
	CH4		---	---	---	BR2	---	BR	BR2	---	---	---
TRIP	CH1		ST	ST	ST	ST	ST	ST	ST	ST	ST	ST
	CH2		TI	TI	TI	TI	TI	TI	TI	TI	F/TI	F/TI
	CH3		AUX1	BR	BR2	BR	ST	ST	ST	ST	R/TI	ST
	CH4		AUX2	AUX	AUX	BR2	AUX	BR	BR2	AUX	AUX	R/TI
CURVE	CH1		ST	ST	ST	ST	ST	ST	ST	ST	ST	ST
	CH2		TH/BR	TI	TH/BR	TI	TH/BR	TI	TH/BR	TH/BR	TH/BR	TH/BR
	CH3		AUX1	BR	BR2	BR	ST	ST	ST	ST	TH/BR	ST
	CH4		AUX2	AUX	AUX	BR2	AUX	BR	BR2	AUX	AUX	TH/BR
SPEEI	CH1		ST	ST	ST	ST	ST	ST	ST	ST	ST	ST
	CH2		TH/BR	TI	TH/BR	TI	TH/BR	TI	TH/BR	TH/BR	TH/BR	TH/BR
	CH3		AUX1	BR	BR2	BR	ST	ST	ST	ST	TH/BR	ST
	CH4		AUX1	AUX	AUX	BR2	AUX	BR	BR2	AUX	AUX	TH/BR
ALI	CH1		---	---	---	---	---	---	---	---	---	---
	CH2		BR	---	BR	---	BR	---	BR	BR	BR	BR
	CH3		---	BR	BR	BR	---	---	---	---	BR	---
	CH4		---	---	---	BR	---	BR	BR	---	---	BR
OFFSET	CH1		---	---	---	---	---	---	---	---	---	---
	CH2		TI	TI	TI	TI	TI	TI	TI	TI	TI	TI
	CH3		---	---	---	---	---	---	---	---	---	---
	CH4		---	---	---	---	---	---	---	---	---	---
OFFSET (BR-LOCK)	CH1		---	---	---	---	---	---	---	---	---	---
	CH2		---	---	---	---	---	---	---	---	---	---
	CH3		---	BR	BR	BR	---	---	---	---	---	---
	CH4		---	---	---	BR2	---	BR	BR2	---	---	---
BR-MIX	CH1		---	---	---	---	---	---	---	---	---	---
	CH2		---	---	BR	---	---	---	BR	---	---	---
	CH3		---	---	BR2	BR	---	---	---	---	---	---
	CH4		---	---	---	BR2	---	---	BR2	---	---	---
TH-HOLI	CH1		---	---	---	---	---	---	---	---	---	---
	CH2		HOLI	HOLI	HOLI	HOLI	HOLI	HOLI	HOLI	---	---	---
	CH3		---	HOLI (I)	HOLI (I)	HOLI (I)	---	---	---	---	---	---
	CH4		---	---	---	HOLI (I)	---	HOLI (I)	HOLI (I)	---	---	---
ACKERMAI	CH1		---	---	---	---	LEFT ST	LEFT ST	LEFT ST	---	---	---
	CH2		---	---	---	---	---	---	---	---	---	---
	CH3		---	---	---	---	RIGHT ST	RIGHT ST	RIGHT ST	---	---	---
	CH4		---	---	---	---	---	---	---	---	---	---
C-MIX MASTER	CH1		ST	ST	ST	ST	ST	ST	ST	ST	ST	ST
			#ST	#ST	#ST	#ST	#L-ST	#L-ST	#L-ST	#F/ST	#ST	#F/ST
	CH2		TI	TI	TI	TI	TI	TI	TI	TI	TI	TI
			#TI	#TI	#TI	#TI	#TI	#TI	#TI	#TI	#F/TI	#F/TI
	CH3		AUX1	BR	BR2	BR	---	---	---	---	---	---
			#AUX1	#BR	#BR2	#BR	#R-ST	#R-ST	#R-ST	#R/ST	#R/TI	#R/ST
	CH4		AUX2	AUX	AUX	BR2	AUX	BR	BR2	AUX	AUX	---
			#AUX2	#AUX	#AUX	#BR2	#AUX	#BR	#BR2	#AUX	#AUX	#R/TI
C-MIX SLAVE	CH1		ST	ST	ST	ST	L-ST	L-ST	L-ST	F/ST	ST	F/ST
	CH2		TI	TI	TI	TI	TI	TI	TI	TI	F/TI	F/TI
	CH3		AUX1	BR	BR2	BR	R-ST	R-ST	R-ST	R/ST	R/TI	R/ST
	CH4		AUX2	AUX	AUX	BR2	AUX	BR	BR2	AUX	AUX	R/TI

M12 2.4GHZ FH4T RADIO CONTROL SYSTEM USER'S GUIDE

TRIM SWITCH, AUXILIARY DIAL AND AUXILIARY LEVER FUNCTIONS

REFERENCE

The tables below shows the functions that can be Assigned to one of the five Trim Switches, the Auxiliary Dial or the Auxiliary Lever. Functions with an (*) Asterisk cannot be Assigned to the Auxiliary Lever. **Not all functions listed below can be Assigned to all Car Types. Functions will vary by Car Type.**

FUNCTION	DESCRIPTION
D/R ST	Dual Rate Steering
D/R TI	Dual Rate Throttle
D/R BR	Dual Rate Brake
D/R BR2	Dual Rate Brake 2
TRIM ST	Trim Steering
TRIM TI	Trim Throttle
TRIM BR	Trim Brake
TRIM BR2	Trim Brake 2
TRIM F/TI	Trim Front Throttle
TRIM R/TI	Trim Rear Throttle
TRIM AUX	Trim Auxiliary
TRIM AUX1	Trim Auxiliary 1
TRIM AUX2	Trim Auxiliary 2
EXP ST	Exponential Steering
EXPT ST-TW-L	Exponential Steering - Tweak - Left
EXP ST-TW-R	Exponential Steering - Tweak - Right
EXP TI	Exponential Throttle
EXP BR	Exponential Brake
EXP BR2	Exponential Brake 2
EXP AUX	Exponential Auxiliary
EXP AUX1	Exponential Auxiliary 1
EXP AUX2	Exponential Auxiliary 2
ARC ST-PNT	ARC Steering - Point
ARC ST-RATE	ARC Steering - Rate
ARC TH-PNT	ARC Throttle - Point
ARC TH-RATE	ARC Throttle - Rate
ARC BR-PNT	ARC Brake - Point
ARC BR-RATE	ARC Brake - Rate
ARC BR2-PNT	ARC Brake 2 - Point
ARC BR2-RATE	ARC Brake 2 - Rate
ARC AUX-PNT	ARC Auxiliary - Point
ARC AUX-RATE	ARC Auxiliary - Rate
ARC AX1-PNT	ARC Auxiliary 1 - Point
ARC AX1-RATE	ARC Auxiliary 1 - Rate
ARC AX2-PNT	ARC Auxiliary 2 - Point
ARC AX2-RATE	ARC Auxiliary 2 - Rate
CRV ST-P1~P9	Curve Steering - Point 1 ~ Point 9
CRV TH-P1~P9	Curve Throttle - Point 1 ~ Point 9
CRV BR-P1~P9	Curve Brake - Point 1 ~ Point 9
CRV BR2-P1~P9	Curve Brake 2 - Point 1 ~ Point 9
CRV AUX-P1~P9	Curve Auxiliary - Point 1 ~ Point 9
CRV AX1-P1~P9	Curve Auxiliary 1 - Point 1 ~ Point 9
CRV AX2-P1~P9	Curve Auxiliary 2 - Point 1 ~ Point 9
SPD ST-FWI	Speed Steering - Forward
SPD ST-RET	Speed Steering - Return to Neutral
SPD ST-PNT	Speed Steering - Point
SPD TH-FWI	Speed Throttle - Forward
SPD TH-RET	Speed Throttle - Return to Neutral
SPD TH-PNT	Speed Throttle - Point
SPD BR-FWI	Speed Brake - Forward
SPD BR-RET	Speed Brake - Return to Neutral
SPD BR-PNT	Speed Brake - Point
SPD BR2-FWI	Speed Brake 2 - Forward
SPD BR2-RET	Speed Brake 2 - Return to Neutral
SPD BR2-PNT	Speed Brake 2 - Point
SPD AUX-FWI	Speed Auxiliary - Forward

FUNCTION	DESCRIPTION
SPD AUX-RET	Speed Auxiliary - Return to Neutral
SPD AUX-PNT	Speed Auxiliary - Point
SPD AX1-FWI	Speed Auxiliary 1 - Forward
SPD AX1-RET	Speed Auxiliary 1 - Return to Neutral
SPD AX1-PNT	Speed Auxiliary 1 - Point
SPD AX2-FWI	Speed Auxiliary 2 - Forward
SPD AX2-RET	Speed Auxiliary 2 - Return to Neutral
SPD AX2-PNT	Speed Auxiliary 2 - Point
ALB STROKE	Anti-Lock Braking Stroke
ALB POINT	Anti-Lock Braking Point
ALB RELEASE	Anti-Lock Braking Release
ALB HOLI	Anti-Lock Braking Hold
ALB LA*	Anti-Lock Braking Lag
OFFST POS	Throttle Offset Position
OFFST LOCK	Throttle Offset Brake Lock
B-MX BR-DLY	Brake Mixing Brake Delay
B-MX BR2-DLY	Brake Mixing Brake 2 Delay
TH-HLI	Throttle Hold
C-M1 RATE1	Compensation Mixing 1 Rate 1
C-M1 RATE2	Compensation Mixing 1 Rate 2
C-M1 OFFST	Compensation Mixing 1 Offset
C-M2 RATE1	Compensation Mixing 2 Rate 1
C-M2 RATE2	Compensation Mixing 2 Rate 2
C-M2 OFFST	Compensation Mixing 2 Offset
ACKER LS-L	Ackerman Left Steering - Left
ACKER LS-R	Ackerman Left Steering - Right
ACKER RS-L	Ackerman Right Steering - Left
ACKER RS-R	Ackerman Right Steering - Right
R-DLY CH1	Racing Mode Delay Channel 1
R-DLY CH2	Racing Mode Delay Channel 2
R-DLY CH3	Racing Mode Delay Channel 3
R-DLY CH4	Racing Mode Delay Channel 4
AUX	Auxiliary
AUX1	Auxiliary 1
AUX2	Auxiliary 2
AXCODE01	Auxiliary Code 01
AXCODE02	Auxiliary Code 02
AXCODE03	Auxiliary Code 03
AXCODE04	Auxiliary Code 04
AXCODE05	Auxiliary Code 05
AX1CODE01	Auxiliary 1 Code 01
AX1CODE02	Auxiliary 1 Code 02
AX1CODE03	Auxiliary 1 Code 03
AX1CODE04	Auxiliary 1 Code 04
AX1CODE05	Auxiliary 1 Code 05
AX2CODE01	Auxiliary 2 Code 01
AX2CODE02	Auxiliary 2 Code 02
AX2CODE03	Auxiliary 2 Code 03
AX2CODE04	Auxiliary 2 Code 04
AX2CODE05	Auxiliary 2 Code 05
R-MODE	Racing Mode*
4WS MIX	Four Wheel Steering Mixing*
MOA MIX	Motor on Axle Mixing (Dig and Burn)*
◀▶	Select Right / Select Left*
INC/DEC	Increase / Decrease*

M12 2.4GHZ FH4T RADIO CONTROL SYSTEM USER'S GUIDE

GLOSSARY OF TERMS

REFERENCE

Ackerman Angle: An engineered value that allows the inner tire to turn at a sharper angle than the outer tire to prevent the tires from slipping during turns.

Activate: To turn ON a particular function.

Antenna: Transmits the signal from the transmitter to the receiver in the Model.

Antenna Reception Wire: The portion of the receiver antenna that receives the transmitter signal. The Antenna Reception Wire should never be bent or it could be damaged and limit the range of your Model.

Anti-Lock Braking: Makes it possible to achieve stable Braking even on slippery surfaces. With stable Braking, your Model is better able to trace an exact line under Braking.

Adjustable Rate Control: Allows you to vary the amount of servo travel in relation to the movement of the Steering Wheel, the Throttle Trigger, the Auxiliary Dial or the Auxiliary Lever near the Neutral positions to change the way those functions react to control movement. The ARC function works like the Exponential function, except that the ARC function features the added benefit of being able to move the Neutral Point, whereas the Exponential function Neutral Point is fixed. In addition, the ARC Curve is more Linear than the Exponential Curve.

Assign Screen: The ASSIGN screen displays the functions that are currently Assigned to the Push-Button Switches, the Trim Switches, the Auxiliary Dial and the Auxiliary Lever, all in one convenient location.

Audio Indicator: Indicates on the LCD screen whether Audible Key Tones and Transmitter Alarms are Muted or not.

Audible Key Tone: An audible Tone that is emitted from the transmitter each time the Push-Button Rotary Dial, the Trim Switches, the Push-Button Switches, the Auxiliary Dial or the Auxiliary Lever is used.

AUX1 Trim: Displays the current position of Auxiliary 1 Trim on the STATUS screen.

AUX2 Trim: Displays the current position of Auxiliary 2 Trim on the STATUS screen.

Auxiliary Dial: The Auxiliary Dial can rotate 360° and is programmable to perform a different function depending on what function is Assigned to it. In the default configuration, it controls Auxiliary 1 High and Low servo travel.

Auxiliary Lever: The Auxiliary Lever is programmable and will perform a different function depending on what function is Assigned to it. In the default configuration, it controls Auxiliary 2 High and Low servo travel.

Back Key: Returns to the previous menu. Repeatedly press to return to the STATUS screen.

Battery Compartment: Houses the four 'AA' Alkaline cells that power the transmitter. Alternatively, the transmitter can be powered using four 'AA' Ni-Cd or Ni-MH rechargeable batteries or a 2S Li-Po or Li-Fe battery pack.

Binding: The act of pairing the transmitter and receiver to prevent interference from transmitters operated by other users.

Bind Button: Used in the process of Binding the transmitter and receiver.

Bind LED: Displays the current operating status of the receiver.

Boot Screen: Displays the brand logo while the transmitter is initialized after being turned ON.

Brake Bias: The ability to vary the rate of Braking between two Brake servos. For example, programming the Front Brake to Engage sooner than the Rear Brake can affect the handling characteristic of your Model.

Brake Mixing: Allows you change the Brake Bias between the Front and Rear Brakes when two separate Brake servos are used.

Brake Side: Refers to the Throttle Trigger stroke that Engages the Brakes on your Model (pushing the Throttle Trigger).

Burn: Used mostly in Rock Crawling and in conjunction with the Motor on Axle function, power to the Front motor is reduced or turned OFF while keeping full control of the Rear motor.

Car Type Indicator: Indicates on the STATUS screen the current Car Type Selected.

Car Type Templates: Allows you to quickly set up the transmitter's Mixing options based on the type of Model you're driving. Common templates for Car or Truck and Crawler Car Types are provided.

Center Trim Type: A Trim technology that allows the servo End Points to remain stationary when you apply Trim. This can result in unbalanced servo travel. In order to balance servo travel, servo End Points need to be manually readjusted.

Channel Curve: Allows you to vary the amount of servo travel in relation to the movement of the Steering Wheel and Throttle Trigger (or in some cases, the Auxiliary Dial and/or the Auxiliary Lever) at different Points along the entire range of control travel to change the way those functions react to control movement.

Channel Set: Allows you to make Programming Value changes to each of the four channels without the need to enter each Programming Menu separately.

Charge Jack: Used for onboard charging of optional Ni-Cd or Ni-MH batteries. Only the recommended Airtronics 110v AC charger should be used through the Charge Jack. If using an after-market Peak-Detection charger or other type of fast charger, the batteries should be removed from the transmitter to avoid damage to the transmitter circuitry and/or your batteries.

Coaxial Cable: The portion of the receiver antenna that extends the Antenna Reception Wire. The Coaxial Cable can be bent into gentle curves, however, do not bend it acutely, or repeatedly bend it or the antenna core can be damaged.

M12 2.4GHZ FH4T RADIO CONTROL SYSTEM USER'S GUIDE

GLOSSARY OF TERMS

REFERENCE

Code Auxiliary: A function designed for use with future connected products, such as an ESC, whose Programming Parameters can be changed directly via the transmitter.

Compensation Mixing: Used to create your own custom Mixes that allow you to control any number of desired functions in different combinations.

Cursor Indicator: Indicates on the TELEMETRY screen the current position of the Cursor when reviewing Telemetry Data.

Data Point Scale: Indicates on the TELEMETRY screen the time in Seconds between recorded Telemetry Data Points.

Dig: Used mostly in Rock Crawling and in conjunction with the Motor on Axle function, power to the Rear motor is reduced or turned OFF while keeping full control of the Front motor.

Digital Trim Memory: Allows the transmitter to store Trim values in its memory. Any amount of Trim that you set during use using the Trim Switches is automatically stored in memory for that specific channel and for that specific Model. The Trim values for each Model will automatically be loaded when the transmitter is turned ON.

Direct Model Select: Allows you to choose up to three different Models that can be Selected when turning the transmitter ON. Simply press a key while turning the transmitter ON and the Programming Data for your favorite Model will load automatically.

Direction/Max/Min Indicators: Indicates on the TELEMETRY pages Control Movement Direction or Programmed Maximum and Minimum Telemetry Data values, depending on the current TELEMETRY page being displayed.

Display Key: Turns the transmitter's LCD Screen ON without actually turning the transmitter ON. This allows you to check and/or change programming options without actually turning the transmitter ON.

Dual Rate: Allows you to change the control authority of the Steering, Throttle High Side and Throttle Brake Side by changing the amount of servo travel relative to control input.

Dual Rate Display: Displays on the STATUS screen the current Dual Rate percentage value of channels that have Dual Rate programmed.

Elapsed Time: Displays on the TELEMETRY screen the current position in Time of the Cursor Indicator within the current Telemetry Data Log.

End Point Adjustment: Used to adjust the desired amount of servo travel in both directions independently. This makes it possible to balance servo travel in both directions.

Enter Key: Opens the Selected menu or programming option. Press and HOLD to reset the Selected programming option to its default value.

Exponential: Allows you to vary the amount of servo travel in relation to the movement of the Steering Wheel and Throttle Trigger (or in some cases, the Auxiliary Dial and/or the Auxiliary Lever) near the Neutral positions to change the way those functions react to control movement.

Fail Safe: Automatically moves the servos to a predetermined position in the event that the signal between the transmitter and the receiver is interrupted, whether due to signal degradation or low transmitter battery.

Feeling: Allows you to adjust the Response Time of the Steering and Throttle channels to fine-tune the sensitivity of these controls. Some users may find that the Response Time is in some cases too fast, therefore, it's adjustable to suit the driver's driving style, Car Type and track conditions.

FH2 Modulation: Frequency Hopping 2nd generation FHSS technology. FH2 Modulation is used in legacy Airtronics 2.4GHz FHSS-2 transmitters and receivers, such as the Airtronics M11, M11 FHSS-2, and MX-3FG radio control systems.

FH3 Modulation: Frequency Hopping 3rd generation FHSS technology. FH3 Modulation is used in newer-generation Airtronics radio control systems, such as the M11X and MX-3X.

FH4T Modulation: Frequency Hopping 4th generation FHSS technology. FH4T Modulation is the latest Airtronics 2.4GHz frequency modulation and supports Telemetry.

FHSS: Frequency Hopping Spread Spectrum. FHSS is a Modulation Type which transmits data across the entire frequency spectrum by transmitting data on different channels at an extremely fast interval.

Firmware: The transmitter's operating software. You can check the Firmware version in the SYSTEM - INFORMATION menu and even update the Firmware if new Firmware becomes available.

Four Wheel Steering Mixing: Used to control either the Front or Rear steering independently, or Mix the Front and Rear steering so that they can be used together. Front or Rear Independent Steering, Parallel Four Wheel Steering and Tandem Four Wheel Steering options are available.

Goal Time: Used in conjunction with the Lap Timer, the Goal Time is designed to alert you when you reach the maximum desired elapsed time during your race or during practice.

Grip: The Grip is molded from rubber in an ergonomic shape for increased comfort, control and feel.

High Side: Refers to the Throttle Trigger stroke that opens the Throttle and powers your Model (pulling the Throttle Trigger).

Hold Setting: Determines how quickly the Brake moves from the Stroke setting to the Point setting when the Anti-Lock Braking function is turned ON.

M12 2.4GHZ FH4T RADIO CONTROL SYSTEM USER'S GUIDE

GLOSSARY OF TERMS

REFERENCE

Inactivity Alarm: This alarm will sound if the transmitter is Left on for a period of 10 minutes without any control input from the user. This alarm alerts you to prevent unwanted draining of the transmitter battery.

Inhibit: To deactivate or turn OFF a particular function.

Interval Timer: Used separately or in conjunction with the Lap Timer, notifies you when a set Interval elapses while you are driving.

KM/H: Kilometers per Hour.

Lag: Controls the amount of Delay before the Anti-Lock Braking function Activates after reaching the Point setting.

Lap Indicator: Indicates on the TELEMETRY screen the position along the Telemetry Data Stream that a Lap Time was counted.

Lap Timer: Allows you to measure and record Lap Times for up to 250 Laps. The total number of Laps, the Current Lap Time, the Best Lap Time and the Average Lap Time are all displayed. Lap Times are displayed in the following format: 00:00".00 (Minutes : Seconds : 1/100th of a Second).

Latency: The Response Time between the transmitter and receiver. The lower the Latency value, the faster the Response Time and the more connected you feel to your Model.

LCD Screen: The heart of the programming and display features of the transmitter. All programming and transmitter display functions are shown on the LCD Screen. The LCD screen features adjustable backlighting, adjustable contrast and smooth scrolling.

LED 1: Displays the current RF signal output status of the transmitter. When illuminated, an RF signal is being transmitted. When extinguished, no RF signal is being transmitted. In addition, LED1 is used to indicate various transmitter conditions.

LED 2: Displays the current status of the Telemetry connection. When illuminated, no Telemetry connection is present. When extinguished, the Telemetry connection is Active. In addition, LED2 is used to indicate various transmitter conditions.

Low Voltage Alert Alarm: The Low Voltage Alert alarm will sound when the transmitter batteries reach the Low Voltage Alert alarm voltage value programmed in the SYSTEM - BATTERY menu. The alarm will sound each time the transmitter battery voltage decreases by 0.1 volt. To clear this alarm, press the BACK key or the ENTER key.

Low Voltage Limit Alarm: The Low Voltage Limit alarm will sound when the transmitter batteries reach the Low Voltage Limit alarm voltage value programmed in the SYSTEM - BATT menu. This alarm can only be cleared by turning the transmitter OFF and recharging or replacing the transmitter batteries.

Mode Display: Displays on the STATUS screen any special Programming Modes that are Active, such as Throttle Offset or Anti-Lock Braking.

Model Clear: Allows you to reset Model-specific Programming Data for the currently Selected Model back to the Factory Default settings.

Model Copy: Allows you to copy the Programming Data FROM the currently Selected Model TO another Model.

Model Naming: Allows you to name each of the 50 individual Models. This makes it easy to keep track of multiple Models. The Model Name can consist of up to 14 letters, numbers or symbols.

Model Select: Allows you to load the Programming Data for the particular Model you wish to drive. The transmitter can store Programming Data for up to 50 different Models.

Model Sort: Allows you to change how your Models are displayed in the Model Select List by allowing you to swap the currently Selected Model with other Models.

Modulation Type Indicator: Indicates on the LCD screen the current Modulation Type that the transmitter is set to.

Motor on Axle Mixing: Used to control either the Front and Rear motors together or independently, giving you Dig and Burn functions.

MPH: Miles Per Hour.

On-Time Indicator: Displays on the STATUS screen the current cumulative On-Time of the transmitter in Hours and Minutes.

Operating Voltage: The safe voltage that the transmitter or receiver can operate within. Exceeding the minimum operating voltage can result in loss of power to the device(s). Exceeding the maximum operating voltage can result in damage to the device(s).

Output Power: The power (in Milliwatts) that your transmitter transmits a signal.

Over Voltage Alarm: The Over Voltage Alarm will sound if the transmitter battery voltage is greater than 9.6 volts. To clear this alarm, turn the transmitter OFF and replace the transmitter battery with one that when fully charged does not exceed 9.6 volts.

Page Indicator: Indicates on the TELEMETRY screen the current Page within the Telemetry Data Stream that Telemetry Data is currently being displayed on.

Parallel Steering: Used with Four Wheel Steering, both Front and Rear wheels pivot right and left together.

Parallel Trim: A Trim technology that shifts the servo End Points toward the High Side or the Low Side automatically when you apply Trim. This maintains balanced servo travel without the need to manually readjust the servo End Points.

PC-Link Input: When used with an USB cable with a Mini USB connector (available separately), the PC-Link Input allows you to save Telemetry Data Logs and Model Programming Data to your PC. In addition, it also allows you to load saved Model Programming Data from your PC and update the transmitter's Firmware.

M12 2.4GHZ FH4T RADIO CONTROL SYSTEM USER'S GUIDE

GLOSSARY OF TERMS

REFERENCE

Point Auxiliary: Allows you to program the Auxiliary 1 or Auxiliary 2 channel servo to move up to 6 different Points along its travel, then cycle through those Points using one of the five Trim Switches or the Auxiliary Dial.

Point Setting: Locates the Point within the range of servo travel that you want a function to Start or Stop. This setting can vary depending on the actual function the Point setting is controlling.

Power Switch: Turns the transmitter ON and OFF.

Pre-Alarm: Used in conjunction with the Lap Timer, the Pre-Alarm is designed to alert you when you are nearing your Goal Time.

Push-Button Rotary Dial: Also referred to as the UP key, DOWN key and ENTER key, it is used along with the BACK key and the SELECT switch to facilitate transmitter programming. It allows you to quickly and easily navigate the various Programming Menus and switch between the STATUS screen, ASSIGN screen and TELEMETRY screen.

Push-Button Switches: The transmitter features three Push-Button Switches in different locations (Sw1, Sw2 and Sw3). Each Push-Button Switch is programmable and will perform a different function depending on what function is Assigned to it. Sw2 is a Rocker Switch that can be pressed from either the Front or the Back.

Racing Mode: Provides you with five separate Racing Modes that you can switch between while you're driving. For example, due to changing track conditions or other variables, such as tire wear, different Racing Modes can be Selected at any time to change your Model's setup. This ensures that your Model can operate with the best-suited setup for ever-changing track conditions throughout an entire race, giving you an advantage over other drivers.

Racing Mode Indicator: Indicates on the LCD screen which Racing Mode (R1 ~ R5) is Active.

Racing Mode LED: Displays which Racing Mode is currently Active. The color of the LED will vary depending on which of the 5 Racing Modes is Active. When extinguished, Racing Mode is Inhibited.

Receiver Battery Voltage Fail Safe: Used to set a custom voltage that the Receiver Battery Fail Safe function will Activate at to alert you when your receiver battery needs recharging. This ensures that your servos continued to operate optimally at all times.

Receiver Voltage Display: Displays on the TELEMETRY screen the current Voltage of the receiver battery. The tick mark indicates the current Voltage relative to the programmed Maximum Voltage value.

Release Setting: Determines how quickly the Brake moves from Neutral to the percentage value determined by the Stroke setting when the Anti-Lock Braking function is Active.

RF Indicator: Indicates whether the transmitter is sending an RF (Radio Frequency) signal or not.

RPM: Revolutions Per Minute.

RPM/Speed Gauge: Displays on the TELEMETRY screen the current RPM or speed in MPH or KM/H in graphical format. The needle indicates the current RPM or Speed relative to the programmed Maximum RPM or Speed value.

Safety Link: Allows to program a unique code to each receiver/Model pair, preventing the transmitter from controlling a Model that it's not currently programmed for. This helps prevent a runaway Model should you accidentally choose the wrong Programming Data for the intended Model.

Select Switch: Used along with the Push-Button Rotary Dial and the BACK key to facilitate transmitter programming. Use the SELECT switch to scroll through the STATUS screen's main menus, scroll through the TELEMETRY pages and make selections in many of the Programming Menus.

Servo Monitor: Displays the output levels of the four channels in bar graph form, allowing you to monitor servo operation in a virtual manner.

Servo Reversing: Used to electronically switch the direction of servo travel.

Servo Speed: Used to slow down the transit speed of the servos. Servo transit speed can be slowed in both the Forward and the Return to Neutral directions.

SHR Servo Mode: When used with Digital servos, this will increase the servo's response time, even above the manufacturer's stated specification. Do not use with Analog servos!

SSR Servo Mode: When used with Airtronics SRG Digital servos, this will provide the fastest response time. This results in the ultimate feel and response, making you feel more in control of your Model than ever. Use only with Airtronics SRG Digital servos!

Status Screen: Displays information about the transmitter and is the base from which you access other Programming Menus.

Steering Output Display: Displays on the TELEMETRY screen the current position of the Steering channel as a percentage of Steering Wheel travel.

Steering Spring Tension Adjustment Screw: Used to adjust the spring tension of the Steering Wheel to best suit the feel of the user.

Steering Trim Display: Displays on the STATUS screen the current position of Steering Trim.

Steering Wheel: Proportionally operates the Model's Right and Left Steering control. The Steering Wheel features a foam grip for increased comfort, control and feel. The Steering Wheel's position, angle and spring tension can all be adjusted.

Step Value: A preset amount that the servo will travel when a Trim Switch is pressed once. The Step value can be adjusted so that the servo either moves more or moves less when a Trim Switch is pressed.

M12 2.4GHZ FH4T RADIO CONTROL SYSTEM USER'S GUIDE

GLOSSARY OF TERMS

REFERENCE

Stroke: Determines the amount of Brake that's applied automatically when the Anti-Lock Braking function Activates.

Sub-Trim: Used to correct the Neutral Trim setting for the servos, making it possible to center the Trim Switches while ensuring the servo horns remain centered.

Suppression Capacitor: Primarily used on brushed electric motors, a suppression capacitor helps eliminate electrical noise that could interfere with the operation of your radio control system.

System Indicators: Indicates on the LCD screen transmitter status information.

Tandem Steering: Used with Four Wheel Steering, the Front wheels pivot opposite to the Rear wheels.

Telemetry: A connection between the transmitter and receiver that transfers Sensor Data from the receiver to the transmitter that can be viewed in real-time on the TELEMETRY screen.

Telemetry Screen: Displays Telemetry Data, such as RPM or Speed, Temperature, Receiver Voltage and more. Use the SELECT switch to switch between ALL and LAP, ST, TH, RPM, VOLT, TMP1 and TMP2 pages.

Telemetry Signal Indicator: Indicates on the LCD screen the current signal strength of the Telemetry connection between the transmitter and receiver.

Temperature 1 Display: Displays on the TELEMETRY screen the current temperature in Fahrenheit or Celsius of the object that the Temperature Sensor plugged into the TEMP1 Sensor Port in the receiver is connected to. The tick mark indicates the current temperature relative to the programmed Maximum and Minimum Temperature values.

Temperature 2 Display: Displays on the TELEMETRY screen the current temperature in Fahrenheit or Celsius of the object that the Temperature Sensor plugged into the TEMP2 Sensor Port in the receiver is connected to. The tick mark indicates the current temperature relative to the programmed Maximum and Minimum Temperature values.

Temperature Alert Alarm: The Temperature Alert alarm will sound when the Temperature 1 and/or Temperature 2 temperature reaches the programmed Alert Temperature value.

Throttle Bias: Allows you to change the ratio between Throttle High Side servo travel and Throttle Brake Side servo travel.

Throttle Hold: Moves the Throttle servo to a fixed position, either toward the High Side or the Brake Side, and is used primarily with glow- or gas-powered Models.

Throttle Offset: Allows you to shift the Neutral position of the throttle servo, either toward the High Side or the Brake Side.

Throttle Output Display: Displays on the TELEMETRY screen the current position of the Throttle channel as a percentage of Throttle Trigger travel.

Throttle Trigger: Controls the speed of the Model, both forward and backward, or the Model's Brake. The Throttle Trigger position, angle and spring tension can all be adjusted.

Throttle Trigger Adjustment Position Indicator: Indicates the current position of the Throttle Trigger. As the Throttle Trigger position is adjusted forward or backward, the Throttle Trigger Adjustment Position Indicator will move forward or backward.

Throttle Trim Display: Displays on the STATUS screen the current position of Throttle Trim.

Throttle Spring Tension Adjustment Screw: Used to adjust the spring tension of the Throttle Trigger to best suit the feel of the user.

Trim Step Resolution: Adjusts how far the servos travel when the Trim Switches are pressed. You can increase the resolution, so that the servos travel less when you press the Trim Switches. This makes it possible to fine-tune the settings extremely accurately.

Trim Switches: The transmitter features five separate Trim Switches - four positioned around the Steering Wheel (Trm1, Trm2, Trm3 and Trm4) and one positioned below the Auxiliary Lever (Trm5). Each Trim Switch is programmable and will perform a different function depending on what function is Assigned to it.

Tweak: Used in conjunction with the Steering Exponential function, allows you to make small Exponential adjustments to the Right and/or Left sides of the Steering channel Neutral Point to fine-tune the balance between the two sides. Also used to adjust the travel limits of the Auxiliary Lever.

User Name: Allows you to change the Name displayed above the M12 logo on the STATUS screen.

Variable Rate Adjustment: Allows you to calibrate the operation of the Steering, Throttle and Auxiliary Lever End Points and Neutral positions to ensure long term precise control operation.

Vibrator: Makes the transmitter vibrate like a cell phone to make you aware of different alerts and alarms that you might encounter during use. This is particularly useful if you've Muted any of these related audible alerts and alarms or to provide a level of tactile feedback while you're driving.

Voltage Indicator: Indicates on the LCD screen the current Voltage of the transmitter batteries.

Wrist Strap Anchor Slot: Used to attach the wrist strap anchor to the transmitter.

Z-Connector: The type of servo and battery connector used by Airtronics. The Z-Connector is a universal connector which is electronically compatible with the airborne components of other radio control system manufacturers.

M12 2.4GHZ FH4T RADIO CONTROL SYSTEM USER'S GUIDE

M12 2.4GHZ FH4T RADIO CONTROL SYSTEM USER'S GUIDE

M12 2.4GHZ FH4T RADIO CONTROL SYSTEM USER'S GUIDE

M12 2.4GHZ FH4T RADIO CONTROL SYSTEM USER'S GUIDE

M12 2.4GHZ FH4T RADIO CONTROL SYSTEM USER'S GUIDE

M12 2.4GHZ FH4T RADIO CONTROL SYSTEM USER'S GUIDE

M12 2.4GHZ FH4T RADIO CONTROL SYSTEM USER'S GUIDE

M12 2.4GHZ FH4T RADIO CONTROL SYSTEM USER'S GUIDE



Airtronics is Distributed Exclusively in North America by:

Global Hobby Distributors
18480 Bandilier Circle
Fountain Valley, CA 92708

Telephone: (714) 963-0329
Fax: (714) 964-6236

Email: service@airtronics.net
<http://globalservices.globalhobby.com>
<http://www.airtronics.net>

Features and Specifications are Subject to Change Without Notice.

All contents © 2012 Airtronics, Inc.
All Rights Reserved. Revision 1 07.26.2012

670A14431A