

## FCC Test Report (2.4GHz WLAN)

**Report No.:** RF170103D01

**FCC ID:** VZ9160001

**Test Model:** EAP737

**Received Date:** Jan. 3, 2017

**Test Date:** Jan. 4 ~ Feb. 15, 2017

**Issued Date:** Feb. 17, 2017

**Applicant:** 4IPNET, INC.

**Address:** 3F-3, No.369, Fusing N. Rd., Taipei City 105, Taiwan

**Issued By:** Bureau Veritas Consumer Products Services (H.K.) Ltd., Taoyuan Branch

**Lab Address:** No. 47-2, 14th Ling, Chia Pau Vil., Lin Kou Dist., New Taipei City, Taiwan (R.O.C.)



This report is for your exclusive use. Any copying or replication of this report to or for any other person or entity, or use of our name or trademark, is permitted only with our prior written permission. This report sets forth our findings solely with respect to the test samples identified herein. The results set forth in this report are not indicative or representative of the quality or characteristics of the lot from which a test sample was taken or any similar or identical product unless specifically and expressly noted. Our report includes all of the tests requested by you and the results thereof based upon the information that you provided to us. You have 60 days from date of issuance of this report to notify us of any material error or omission caused by our negligence, provided, however, that such notice shall be in writing and shall specifically address the issue you wish to raise. A failure to raise such issue within the prescribed time shall constitute your unqualified acceptance of the completeness of this report, the tests conducted and the correctness of the report contents. Unless specific mention, the uncertainty of measurement has been explicitly taken into account to declare the compliance or non-compliance to the specification. The report must not be used by the client to claim product certification, approval, or endorsement by TAF or any government agencies.

## Table of Contents

<b>Release Control Record</b> .....	<b>4</b>
<b>1 Certificate of Conformity</b> .....	<b>5</b>
<b>2 Summary of Test Results</b> .....	<b>6</b>
2.1 Measurement Uncertainty .....	6
2.2 Modification Record.....	6
<b>3 General Information</b> .....	<b>7</b>
3.1 General Description of EUT.....	7
3.2 Description of Test Modes .....	8
3.2.1 Test Mode Applicability and Tested Channel Detail.....	9
3.3 Duty Cycle of Test Signal.....	11
3.4 Description of Support Units.....	12
3.4.1 Configuration of System under Test .....	12
3.5 General Description of Applied Standards.....	13
<b>4 Test Types and Results</b> .....	<b>14</b>
4.1 Radiated Emission and Bandedge Measurement.....	14
4.1.1 Limits of Radiated Emission and Bandedge Measurement.....	14
4.1.2 Test Instruments.....	15
4.1.3 Test Procedures .....	16
4.1.4 Deviation from Test Standard.....	16
4.1.5 Test Setup .....	17
4.1.6 EUT Operating Conditions.....	18
4.1.7 Test Results.....	19
4.2 Conducted Emission Measurement .....	32
4.2.1 Limits of Conducted Emission Measurement.....	32
4.2.2 Test Instruments.....	32
4.2.3 Test Procedures .....	33
4.2.4 Deviation from Test Standard.....	33
4.2.5 Test Setup .....	33
4.2.6 EUT Operating Conditions.....	33
4.2.7 Test Results.....	34
4.3 6dB Bandwidth Measurement.....	38
4.3.1 Limits of 6dB Bandwidth Measurement.....	38
4.3.2 Test Setup .....	38
4.3.3 Test Instruments.....	38
4.3.4 Test Procedure .....	38
4.3.5 Deviation from Test Standard.....	38
4.3.6 EUT Operating Conditions.....	38
4.3.7 Test Result .....	39
4.4 Conducted Output Power Measurement.....	41
4.4.1 Limits of Conducted Output Power Measurement .....	41
4.4.2 Test Setup .....	41
4.4.3 Test Instruments.....	41
4.4.4 Test Procedures .....	41
4.4.5 Deviation from Test Standard.....	41
4.4.6 EUT Operating Conditions.....	41
4.4.7 Test Results.....	42
4.5 Power Spectral Density Measurement.....	44
4.5.1 Limits of Power Spectral Density Measurement .....	44
4.5.2 Test Setup .....	44
4.5.3 Test Instruments.....	44
4.5.4 Test Procedure .....	44
4.5.5 Deviation from Test Standard.....	44
4.5.6 EUT Operating Condition.....	44

4.5.7 Test Results.....	45
4.6 Conducted Out of Band Emission Measurement.....	47
4.6.1 Limits of Conducted Out of Band Emission Measurement.....	47
4.6.2 Test Setup.....	47
4.6.3 Test Instruments.....	47
4.6.4 Test Procedure.....	47
4.6.5 Deviation from Test Standard.....	47
4.6.6 EUT Operating Condition.....	47
4.6.7 Test Results.....	47
<b>5 Pictures of Test Arrangements.....</b>	<b>56</b>
<b>Appendix – Information on the Testing Laboratories.....</b>	<b>57</b>

### Release Control Record

Issue No.	Description	Date Issued
RF170103D01	Original release.	Feb. 17, 2017

## 1 Certificate of Conformity

**Product:** Enterprise Access Point

**Brand:** 4ipnet

**Test Model:** EAP737

**Sample Status:** Engineering sample

**Applicant:** 4IPNET, INC.

**Test Date:** Jan. 4 ~ Feb. 15, 2017

**Standards:** 47 CFR FCC Part 15, Subpart C (Section 15.247)  
ANSI C63.10: 2013

The above equipment has been tested by **Bureau Veritas Consumer Products Services (H.K.) Ltd., Taoyuan Branch**, and found compliance with the requirement of the above standards. The test record, data evaluation & Equipment Under Test (EUT) configurations represented herein are true and accurate accounts of the measurements of the sample's EMC characteristics under the conditions specified in this report.

Prepared by :



,

Date:

Feb. 17, 2017

Celia Chen / Supervisor

Approved by :



,

Date:

Feb. 17, 2017

Rex Lai / Assistant Manager

## 2 Summary of Test Results

47 CFR FCC Part 15, Subpart C (SECTION 15.247)			
FCC Clause	Test Item	Result	Remarks
15.207	AC Power Conducted Emission	PASS	Meet the requirement of limit. Minimum passing margin is -12.08dB at 0.25547MHz.
15.205 / 15.209 / 15.247(d)	Radiated Emissions and Band Edge Measurement	PASS	Meet the requirement of limit. Minimum passing margin is -1.06dB at 2390.00MHz.
15.247(d)	Antenna Port Emission	PASS	Meet the requirement of limit.
15.247(a)(2)	6dB bandwidth	PASS	Meet the requirement of limit.
15.247(b)	Conducted power	PASS	Meet the requirement of limit.
15.247(e)	Power Spectral Density	PASS	Meet the requirement of limit.
15.203	Antenna Requirement	PASS	Antenna connector is I-PEX not a standard connector.

### 2.1 Measurement Uncertainty

Where relevant, the following measurement uncertainty levels have been estimated for tests performed on the EUT as specified in CISPR 16-4-2:

Measurement	Frequency	Expanded Uncertainty (k=2) ( $\pm$ )
Conducted Emissions at mains ports	150kHz ~ 30MHz	2.77 dB
Radiated Emissions up to 1 GHz	9kHz ~ 30MHz	2.38 dB
	30MHz ~ 1000MHz	5.54 dB
Radiated Emissions above 1 GHz	1GHz ~ 6GHz	4.77 dB
	6GHz ~ 18GHz	5.48 dB

### 2.2 Modification Record

There were no modifications required for compliance.

### 3 General Information

#### 3.1 General Description of EUT

Product	Enterprise Access Point
Brand	4ipnet
Test Model	EAP737
Status of EUT	Engineering sample
Power Supply Rating	12Vdc from adapter or 56Vdc from PoE
Modulation Type	CCK, DQPSK, DBPSK for DSSS 64QAM, 16QAM, QPSK, BPSK for OFDM
Modulation Technology	DSSS, OFDM
Transfer Rate	802.11b: up to 11Mbps 802.11g: up to 54Mbps 802.11n: up to 300Mbps
Operating Frequency	2.412 ~ 2.462GHz
Number of Channel	11 for 802.11b, 802.11g, 802.11n (20MHz) 7 for 802.11n (40MHz)
Output Power	723.653mW
Antenna Type	<b>CDD MODE</b> PIFA antenna with 1.5dBi gain <b>Beamforming MODE</b> PIFA antenna with 2.93dBi gain
Antenna Connector	I-PEX
Accessory Device	Adapter
Data Cable Supplied	N/A

Note:

- The EUT incorporates a MIMO function. Physically, the EUT provides two completed transmitters and two receivers.

Modulation Mode	TX Function
802.11b	2TX
802.11g	2TX
802.11n (20MHz)	2TX
802.11n (40MHz)	2TX

- The EUT uses following adapter.

Brand	APD
Model	WB-18D12R
Input Power	100-240Vac, 0.5A, 50-60Hz (AC 2 Pin)
Output Power	12Vdc, 1.5A
Power Line	Non-shielded DC cable (1.5m)

- The above EUT information is declared by manufacturer and for more detailed features description, please refer to the manufacturer's specifications or user's manual.

### 3.2 Description of Test Modes

11 channels are provided for 802.11b, 802.11g and 802.11n (20MHz):

Channel	Frequency	Channel	Frequency
1	2412MHz	7	2442MHz
2	2417MHz	8	2447MHz
3	2422MHz	9	2452MHz
4	2427MHz	10	2457MHz
5	2432MHz	11	2462MHz
6	2437MHz		

7 channels are provided for 802.11n (40MHz):

Channel	Frequency	Channel	Frequency
3	2422MHz	7	2442MHz
4	2427MHz	8	2447MHz
5	2432MHz	9	2452MHz
6	2437MHz		



### 3.2.1 Test Mode Applicability and Tested Channel Detail

EUT CONFIGURE MODE	APPLICABLE TO				DESCRIPTION
	RE <sup>≥</sup> 1G	RE<1G	PLC	APCM	
A	√	√	√	√	EUT powered from adapter
B	-	-	√	-	EUT powered from PoE

Where RE<sup>≥</sup>1G: Radiated Emission above 1GHz & Bandedge Measurement  
 RE<1G: Radiated Emission below 1GHz  
 PLC: Power Line Conducted Emission  
 APCM: Antenna Port Conducted Measurement

**NOTE:** 1. The EUT had been pre-tested on the positioned of each 3 axis. The worst case was found when positioned on **Y-plane**.  
 2. "-" means no effect.

#### **Radiated Emission Test (Above 1GHz):**

- Pre-Scan has been conducted to determine the worst-case mode from all possible combinations between available modulations, data rates and antenna ports (if EUT with antenna diversity architecture).
- Following channel(s) was (were) selected for the final test as listed below.

CDD MODE						
EUT CONFIGURE MODE	MODE	AVAILABLE CHANNEL	TESTED CHANNEL	MODULATION TECHNOLOGY	MODULATION TYPE	DATA RATE (Mbps)
A	802.11b	1 to 11	1, 6, 11	DSSS	DBPSK	1
A	802.11g	1 to 11	1, 6, 11	OFDM	BPSK	6
Beamforming_NSS1 MODE						
EUT CONFIGURE MODE	MODE	AVAILABLE CHANNEL	TESTED CHANNEL	MODULATION TECHNOLOGY	MODULATION TYPE	DATA RATE (Mbps)
A	802.11n (20MHz)	1 to 11	1, 6, 11	OFDM	BPSK	6.5
A	802.11n (40MHz)	3 to 9	3, 6, 9	OFDM	BPSK	13.5

#### **Radiated Emission Test (Below 1GHz):**

- Pre-Scan has been conducted to determine the worst-case mode from all possible combinations between available modulations, data rates and antenna ports (if EUT with antenna diversity architecture).
- Following channel(s) was (were) selected for the final test as listed below.

CDD MODE						
EUT CONFIGURE MODE	MODE	AVAILABLE CHANNEL	TESTED CHANNEL	MODULATION TECHNOLOGY	MODULATION TYPE	DATA RATE (Mbps)
A	802.11b	1 to 11	6	DSSS	DBPSK	1

**Power Line Conducted Emission Test:**

- Pre-Scan has been conducted to determine the worst-case mode from all possible combinations between available modulations, data rates and antenna ports (if EUT with antenna diversity architecture).
- Following channel(s) was (were) selected for the final test as listed below.

<b>CDD MODE</b>						
<b>EUT CONFIGURE MODE</b>	<b>MODE</b>	<b>AVAILABLE CHANNEL</b>	<b>TESTED CHANNEL</b>	<b>MODULATION TECHNOLOGY</b>	<b>MODULATION TYPE</b>	<b>DATA RATE (Mbps)</b>
A	802.11b	1 to 11	1, 6, 11	DSSS	DBPSK	1
B	802.11b	1 to 11	1, 6, 11	DSSS	DBPSK	1

**Antenna Port Conducted Measurement:**

- This item includes all test value of each mode, but only includes spectrum plot of worst value of each mode.
- Pre-Scan has been conducted to determine the worst-case mode from all possible combinations between available modulations, data rates and antenna ports (if EUT with antenna diversity architecture).
- Following channel(s) was (were) selected for the final test as listed below.

<b>CDD MODE</b>						
<b>EUT CONFIGURE MODE</b>	<b>MODE</b>	<b>AVAILABLE CHANNEL</b>	<b>TESTED CHANNEL</b>	<b>MODULATION TECHNOLOGY</b>	<b>MODULATION TYPE</b>	<b>DATA RATE (Mbps)</b>
A	802.11b	1 to 11	1, 6, 11	DSSS	DBPSK	1
A	802.11g	1 to 11	1, 6, 11	OFDM	BPSK	6
A	802.11n (20MHz)	1 to 11	1, 6, 11	OFDM	BPSK	6.5
A	802.11n (40MHz)	3 to 9	3, 6, 9	OFDM	BPSK	13.5
<b>Beamforming_NSS1 MODE</b>						
<b>EUT CONFIGURE MODE</b>	<b>MODE</b>	<b>AVAILABLE CHANNEL</b>	<b>TESTED CHANNEL</b>	<b>MODULATION TECHNOLOGY</b>	<b>MODULATION TYPE</b>	<b>DATA RATE (Mbps)</b>
A	802.11n (20MHz)	1 to 11	1, 6, 11	OFDM	BPSK	6.5
A	802.11n (40MHz)	3 to 9	3, 6, 9	OFDM	BPSK	13.5

**Test Condition:**

<b>APPLICABLE TO</b>	<b>EUT CONFIGURE MODE</b>	<b>ENVIRONMENTAL CONDITIONS</b>	<b>INPUT POWER</b>	<b>TESTED BY</b>
<b>RE<sup>3</sup>1G</b>	A	26deg. C, 76%RH	120Vac, 60Hz (Adapter)	Ian Chang
<b>RE&lt;1G</b>	A	21deg. C, 71%RH	120Vac, 60Hz (Adapter)	Aaron You
<b>PLC</b>	A	21deg. C, 61%RH	120Vac, 60Hz (Adapter)	Aaron You
	B	21deg. C, 61%RH	120Vac, 60Hz (PoE)	Aaron You
<b>APCM</b>	A	25deg. C, 76%RH	120Vac, 60Hz (Adapter)	Saxon Lee

### 3.3 Duty Cycle of Test Signal

If duty cycle of test signal is 100 %, duty factor is not required.  
 If duty cycle of test signal is < 98%, duty factor shall be considered.

**802.11b:** Duty cycle of test signal is 100 %

**802.11g:** Duty cycle = 2.014/2.13 = 0.946, Duty factor =  $10 * \log(1/0.946) = 0.2$

**802.11n (20MHz):** Duty cycle = 4.913/5.087 = 0.966, Duty factor =  $10 * \log(1/0.966) = 0.2$

**802.11n (40MHz):** Duty cycle = 2.376/2.507 = 0.948, Duty factor =  $10 * \log(1/0.948) = 0.2$

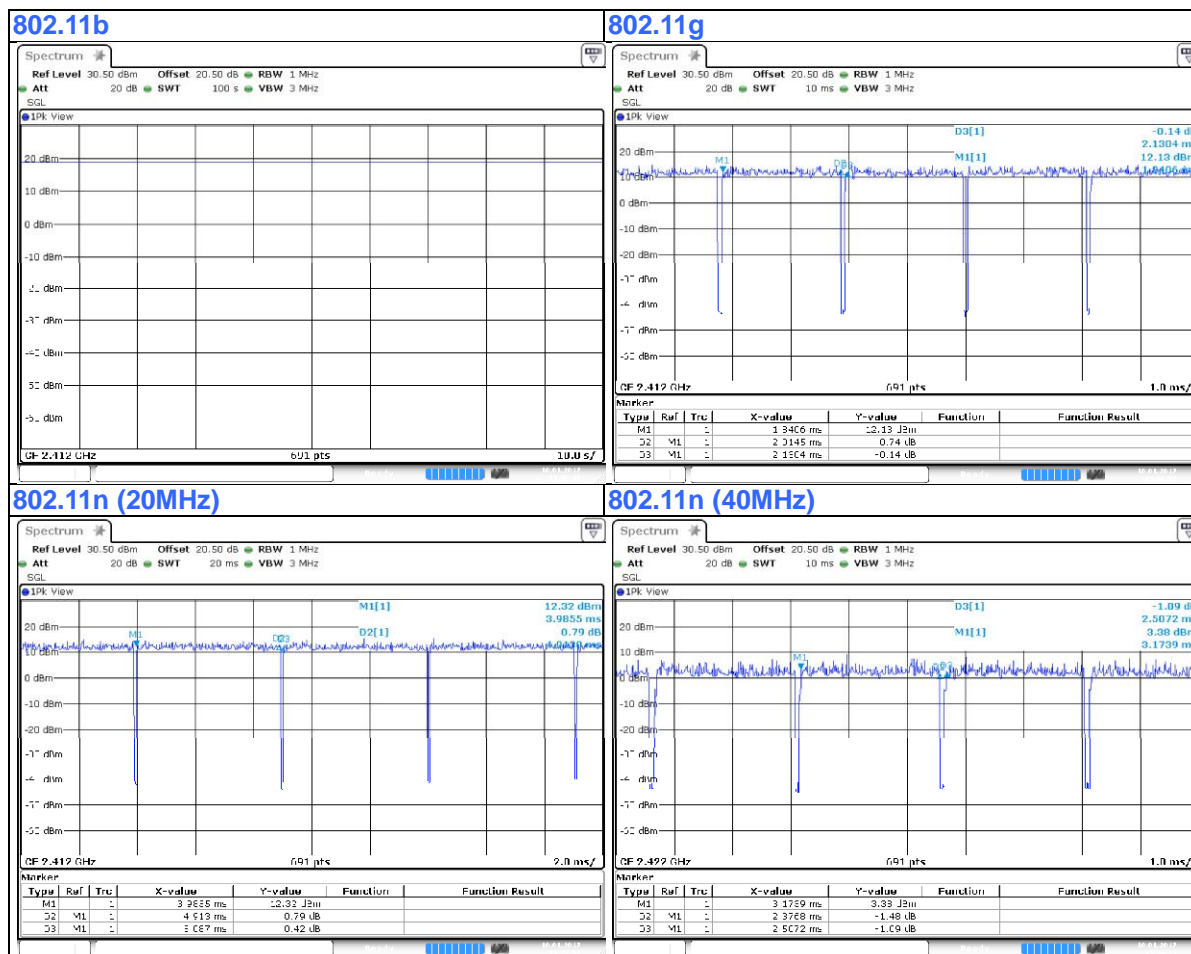

### 3.4 Description of Support Units

The EUT has been tested as an independent unit together with other necessary accessories or support units. The following support units or accessories were used to form a representative test configuration during the tests.

ID	Product	Brand	Model No.	Serial No.	FCC ID	Remarks
A.	LAN Load	N/A	N/A	N/A	N/A	Provided by Lab
B.	USB 3.0 Flash Drive	HP	v250w	N/A	FCC DoC Approved	Provided by Lab
C.	Notebook	DELL	E5410	BW33YM1	FCC DoC Approved	Provided by Lab
D.	PoE Adapter	PHIHONG	POE31U-1AT	N/A	N/A	Supplied by client

Note:

1. All power cords of the above support units are non-shielded (1.8m).
2. Item C acted as communication partners to transfer data.

ID	Descriptions	Qty.	Length (m)	Shielding (Yes/No)	Cores (Qty.)	Remarks
1.	LAN cable	2	1.5	N	0	Provided by Lab
2.	LAN cable	1	10	N	0	Provided by Lab
3.	DC cable	1	1.5	N	0	Supplied by client
4.	LAN cable	1	1.5	N	0	Supplied by client

Note: The core(s) is(are) originally attached to the cable(s).

#### 3.4.1 Configuration of System under Test

##### TEST CONFIGURATION – Mode A

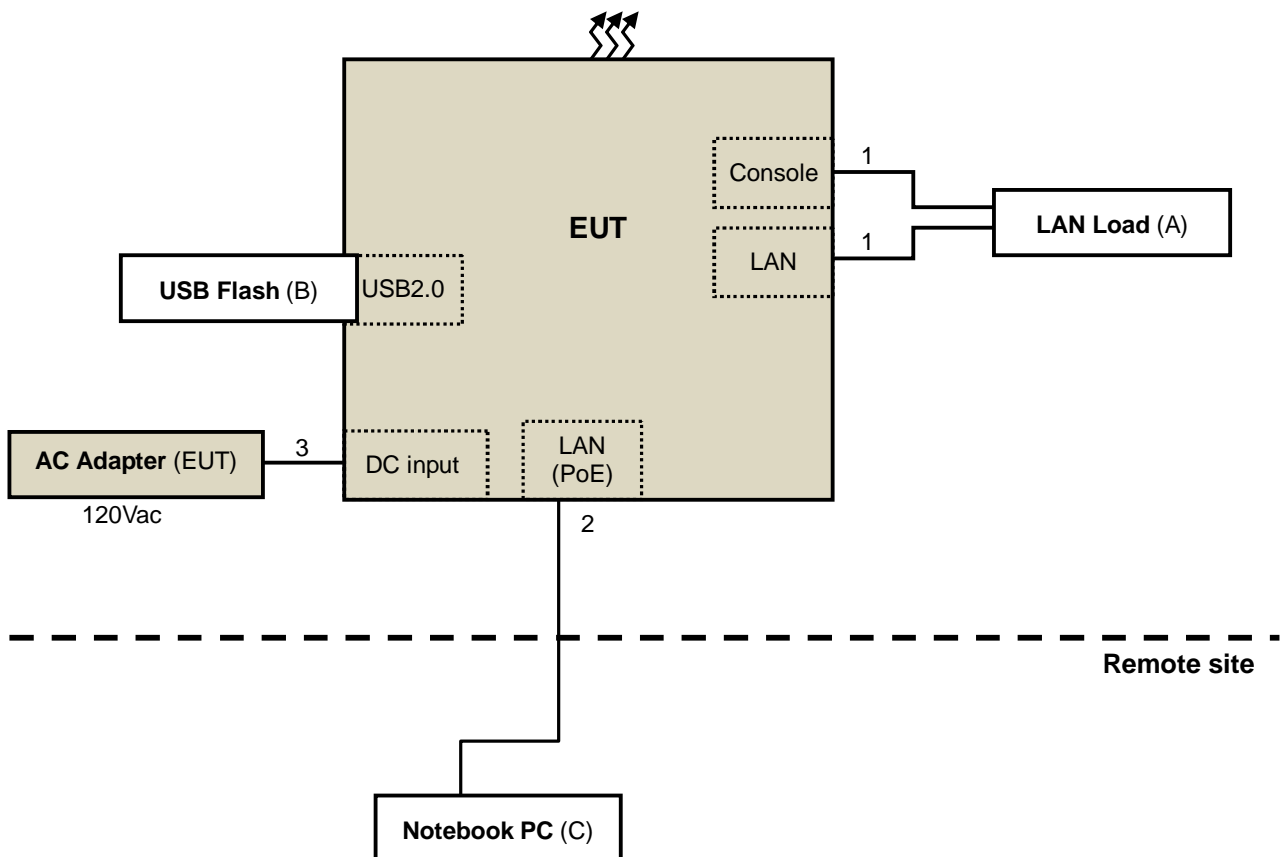

### TEST CONFIGURATION – Mode B

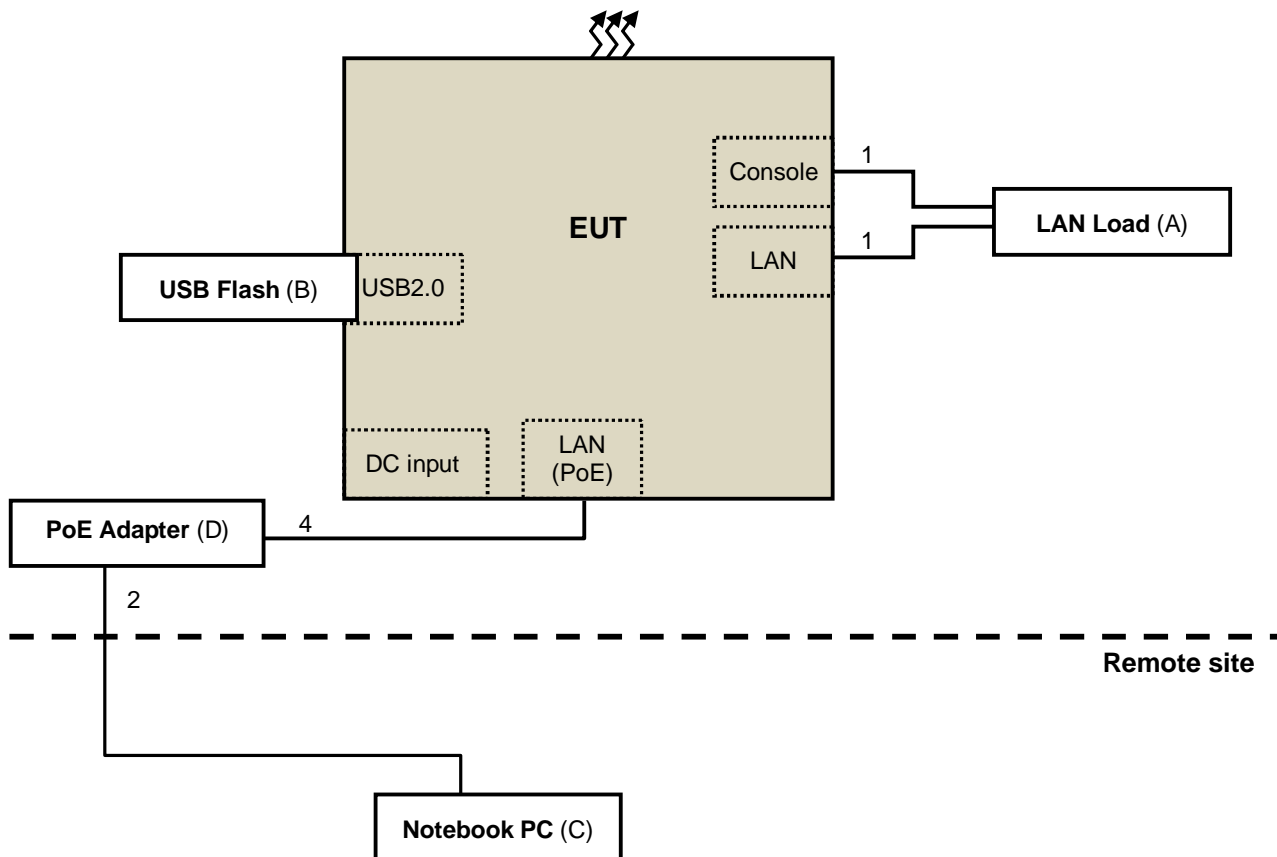

### 3.5 General Description of Applied Standards

The EUT is a RF Product. According to the specifications of the manufacturer, it must comply with the requirements of the following standards:

**FCC Part 15, Subpart C (15.247)**  
**KDB 558074 D01 DTS Meas Guidance v03r05**  
**KDB 662911 D01 Multiple Transmitter Output v02r01**  
**ANSI C63.10-2013**

All test items have been performed and recorded as per the above standards.

**NOTE:** The EUT has been verified to comply with the requirements of FCC Part 15, Subpart B, Class B (DoC). The test report has been issued separately.

## 4 Test Types and Results

### 4.1 Radiated Emission and Bandedge Measurement

#### 4.1.1 Limits of Radiated Emission and Bandedge Measurement

Radiated emissions which fall in the restricted bands must comply with the radiated emission limits specified as below table. Other emissions shall be at least 30dB below the highest level of the desired power:

Frequencies (MHz)	Field Strength (microvolts/meter)	Measurement Distance (meters)
0.009 ~ 0.490	2400/F(kHz)	300
0.490 ~ 1.705	24000/F(kHz)	30
1.705 ~ 30.0	30	30
30 ~ 88	100	3
88 ~ 216	150	3
216 ~ 960	200	3
Above 960	500	3

**NOTE:**

1. The lower limit shall apply at the transition frequencies.
2. Emission level (dBuV/m) = 20 log Emission level (uV/m).
3. For frequencies above 1000MHz, the field strength limits are based on average detector, however, the peak field strength of any emission shall not exceed the maximum permitted average limits, specified above by more than 30dB under any condition of modulation.

## 4.1.2 Test Instruments

DESCRIPTION & MANUFACTURER	MODEL NO.	SERIAL NO.	CALIBRATED DATE	CALIBRATED UNTIL
HP Preamplifier	8447D	2432A03504	Feb. 26, 2016	Feb. 25, 2017
HP Preamplifier	8449B	3008A01201	Feb. 26, 2016	Feb. 25, 2017
MITEQ Preamplifier	AMF-6F-260400-33-8P	892164	Mar. 01, 2016	Feb. 28, 2017
Agilent TEST RECEIVER	N9038A	MY50010158	Aug. 04, 2016	Aug. 03, 2017
Schwarzbeck Antenna	VULB 9168	139	Dec. 13, 2016	Dec. 12, 2017
Schwarzbeck Antenna	VHBA 9123	480	May 29, 2015	May 28, 2017
Schwarzbeck Horn Antenna	BBHA-9170	212	Dec. 30, 2016	Dec. 29, 2017
Schwarzbeck Horn Antenna	BBHA 9120-D1	D130	Dec. 27, 2016	Dec. 26, 2017
ADT. Turn Table	TT100	0306	NA	NA
ADT. Tower	AT100	0306	NA	NA
Software	Radiated_V7.6.15.9.5	NA	NA	NA
SUHNER RF cable With 4dB PAD	SF104	CABLE-CH6	Aug. 15, 2016	Aug. 14, 2017
SUHNER RF cable With 3dB PAD	SF102	Cable-CH8-3.6m	Aug. 15, 2016	Aug. 14, 2017
KEYSIGHT MIMO Powermeasurement Test set	U2021XA	U2021XA-001	May 25, 2016	May 24, 2017
KEYSIGHT Spectrum Analyzer	N9030A	MY54490260	Jul. 26, 2016	Jul. 25, 2017
Loop Antenna EMCI	LPA600	270	Aug. 20, 2015	Aug. 19, 2017
EMCO Horn Antenna	3115	00028257	Dec. 15, 2016	Dec. 14, 2017
Highpass filter Wainwright Instruments	WHK 3.1/18G-10SS	SN 8	NA	NA
ROHDE & SCHWARZ Spectrum Analyzer	FSV40	101042	Sep. 30, 2016	Sep. 29, 2017
Anritsu Power Sensor	MA2411B	0738404	Apr. 28, 2016	Apr. 27, 2017
Anritsu Power Meter	ML2495A	0842014	Apr. 28, 2016	Apr. 27, 2017

- NOTE:**
1. The calibration interval of the above test instruments is 12/24 months. And the calibrations are traceable to NML/ROC and NIST/USA.
  2. The horn antenna and HP preamplifier (model: 8449B) are used only for the measurement of emission frequency above 1GHz if tested.
  3. The test was performed in Chamber No. 6.
  4. The Industry Canada Reference No. IC 7450E-6.
  5. The FCC Site Registration No. is 447212.

#### 4.1.3 Test Procedures

##### **For Radiated emission below 30MHz**

- a. The EUT was placed on the top of a rotating table 0.8 meters above the ground at a 3 meter chamber room. The table was rotated 360 degrees to determine the position of the highest radiation.
- b. The EUT was set 3 meters away from the interference-receiving antenna, which was mounted on the top of a variable-height antenna tower.
- c. Both X and Y axes of the antenna are set to make the measurement.
- d. For each suspected emission, the EUT was arranged to its worst case and the rotatable table was turned from 0 degrees to 360 degrees to find the maximum reading.
- e. The test-receiver system was set to Quasi-Peak Detect Function and Specified Bandwidth with Maximum Hold Mode.

**NOTE:** The resolution bandwidth and video bandwidth of test receiver/spectrum analyzer is 9kHz at frequency below 30MHz.

##### **For Radiated emission above 30MHz**

- a. The EUT was placed on the top of a rotating table 0.8 meters (for 30MHz ~ 1GHz) / 1.5 meters (for above 1GHz) above the ground at 3 meter chamber room for test. The table was rotated 360 degrees to determine the position of the highest radiation.
- b. The EUT was set 3 meters away from the interference-receiving antenna, which was mounted on the top of a variable-height antenna tower.
- c. The height of antenna is varied from one meter to four meters above the ground to determine the maximum value of the field strength. Both horizontal and vertical polarizations of the antenna are set to make the measurement.
- d. For each suspected emission, the EUT was arranged to its worst case and then the antenna was tuned to heights from 1 meter to 4 meters and the rotatable table was turned from 0 degrees to 360 degrees to find the maximum reading.
- e. The test-receiver system was set to quasi-peak detect function and specified bandwidth with maximum hold mode when the test frequency is below 1 GHz.
- f. The test-receiver system was set to peak and average detect function and specified bandwidth with maximum hold mode when the test frequency is above 1 GHz. If the peak reading value also meets average limit, measurement with the average detector is unnecessary.

##### **Note:**

1. The resolution bandwidth and video bandwidth of test receiver/spectrum analyzer is 120kHz for Quasi-peak detection (QP) at frequency below 1GHz.
2. The resolution bandwidth of test receiver/spectrum analyzer is 1 MHz and the video bandwidth is 3 MHz for Peak detection (PK) at frequency above 1GHz.
3. The resolution bandwidth of test receiver/spectrum analyzer is 1MHz and the video bandwidth is  $\geq 1/T$  (Duty cycle < 98%) or 10Hz (Duty cycle  $\geq 98\%$ ) for Average detection (AV) at frequency above 1GHz.
4. All modes of operation were investigated and the worst-case emissions are reported.

#### 4.1.4 Deviation from Test Standard

No deviation.



#### 4.1.5 Test Setup

##### For Radiated emission below 30MHz

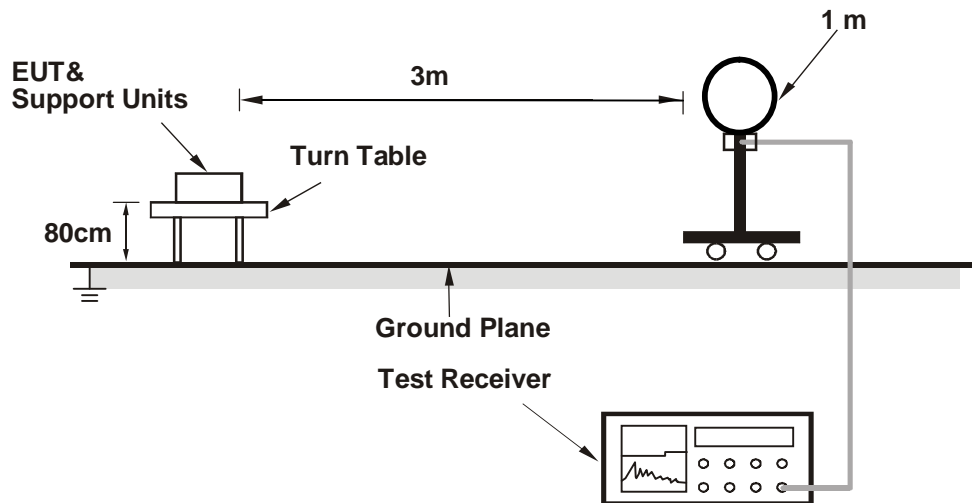

##### For Radiated emission 30MHz to 1GHz

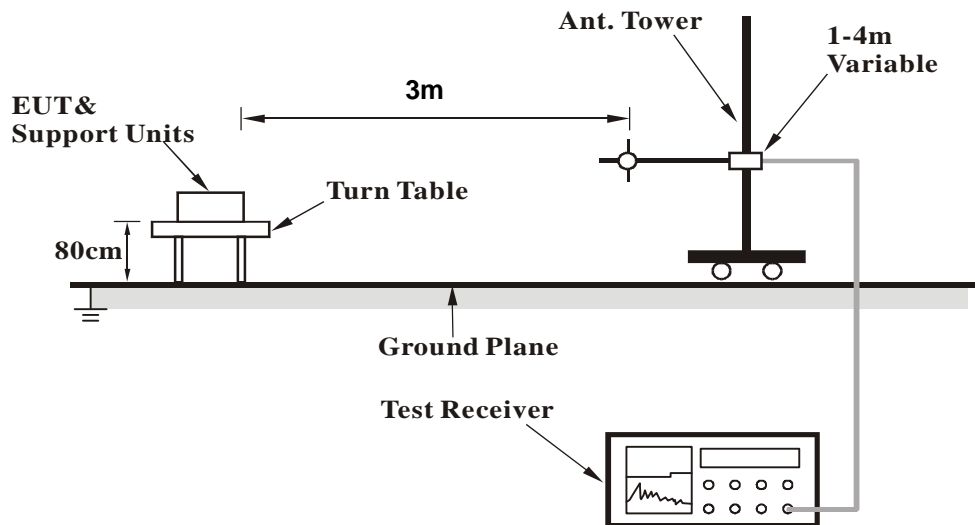

### For Radiated emission above 1GHz

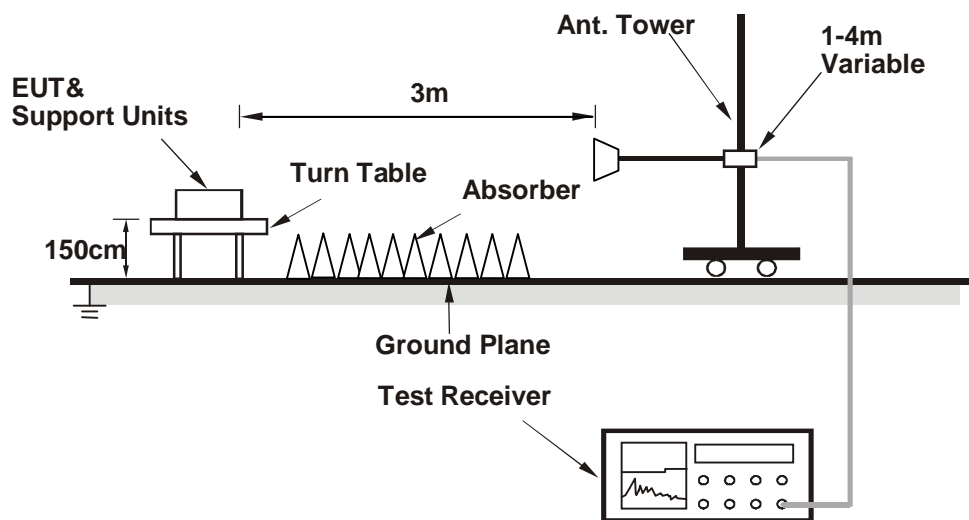

For the actual test configuration, please refer to the attached file (Test Setup Photo).

#### 4.1.6 EUT Operating Conditions

- Connected the EUT with AC adapter / PoE adapter placed on testing table.
- Prepared notebook to act as communication partner and placed it outside of testing area.
- The EUT perform R/W function with USB flash from notebook via LAN cable.
- The communication partner connected with EUT via a RJ45 cable and ran a test program (provided by manufacturer) to enable EUT under transmission condition continuously at specific channel frequency.

## 4.1.7 Test Results

**CDD MODE**
**ABOVE 1GHz DATA**
**802.11b**

<b>CHANNEL</b>	TX Channel 1	<b>DETECTOR FUNCTION</b>	Peak (PK)
<b>FREQUENCY RANGE</b>	1GHz ~ 25GHz		Average (AV)
<b>TEST MODE</b>	A		

**ANTENNA POLARITY & TEST DISTANCE: HORIZONTAL AT 3 M**

NO.	FREQ. (MHz)	EMISSION LEVEL (dBuV/m)	LIMIT (dBuV/m)	MARGIN (dB)	ANTENNA HEIGHT (m)	TABLE ANGLE (Degree)	RAW VALUE (dBuV)	CORRECTION FACTOR (dB/m)
1	2390.00	61.63 PK	74.00	-12.37	3.29 H	205	61.34	0.29
2	2390.00	52.93 AV	54.00	-1.07	3.29 H	205	52.64	0.29
3	*2412.00	118.51 PK			3.29 H	205	118.05	0.46
4	*2412.00	115.60 AV			3.29 H	205	115.14	0.46
5	4824.00	48.29 PK	74.00	-25.71	1.85 H	298	41.11	7.18
6	4824.00	39.25 AV	54.00	-14.75	1.85 H	298	32.07	7.18

**ANTENNA POLARITY & TEST DISTANCE: VERTICAL AT 3 M**

NO.	FREQ. (MHz)	EMISSION LEVEL (dBuV/m)	LIMIT (dBuV/m)	MARGIN (dB)	ANTENNA HEIGHT (m)	TABLE ANGLE (Degree)	RAW VALUE (dBuV)	CORRECTION FACTOR (dB/m)
1	2390.00	59.15 PK	74.00	-14.85	1.34 V	282	58.86	0.29
2	2390.00	49.73 AV	54.00	-4.27	1.34 V	282	49.44	0.29
3	*2412.00	114.71 PK			1.34 V	282	114.25	0.46
4	*2412.00	111.87 AV			1.34 V	282	111.41	0.46
5	4824.00	48.14 PK	74.00	-25.86	1.38 V	252	40.96	7.18
6	4824.00	39.07 AV	54.00	-14.93	1.38 V	252	31.89	7.18

**REMARKS:**

1. Emission Level(dBuV/m) = Raw Value(dBuV) + Correction Factor(dB/m)
2. Correction Factor(dB/m) = Antenna Factor(dB/m) + Cable Factor(dB) – Pre-Amplifier Factor(dB)
3. The other emission levels were very low against the limit.
4. Margin value = Emission Level – Limit value
5. " \* ": Fundamental frequency.

<b>CHANNEL</b>	TX Channel 6	<b>DETECTOR FUNCTION</b>	Peak (PK)
<b>FREQUENCY RANGE</b>	1GHz ~ 25GHz		Average (AV)
<b>TEST MODE</b>	A		

**ANTENNA POLARITY & TEST DISTANCE: HORIZONTAL AT 3 M**

NO.	FREQ. (MHz)	EMISSION LEVEL (dBuV/m)	LIMIT (dBuV/m)	MARGIN (dB)	ANTENNA HEIGHT (m)	TABLE ANGLE (Degree)	RAW VALUE (dBuV)	CORRECTION FACTOR (dB/m)
1	*2437.00	125.12 PK			1.25 H	217	124.46	0.66
2	*2437.00	120.26 AV			1.25 H	217	119.60	0.66
3	4874.00	54.76 PK	74.00	-19.24	1.34 H	233	47.54	7.22
4	4874.00	49.82 AV	54.00	-4.18	1.34 H	233	42.60	7.22

**ANTENNA POLARITY & TEST DISTANCE: VERTICAL AT 3 M**

NO.	FREQ. (MHz)	EMISSION LEVEL (dBuV/m)	LIMIT (dBuV/m)	MARGIN (dB)	ANTENNA HEIGHT (m)	TABLE ANGLE (Degree)	RAW VALUE (dBuV)	CORRECTION FACTOR (dB/m)
1	*2437.00	122.35 PK			1.43 V	263	121.69	0.66
2	*2437.00	118.29 AV			1.43 V	263	117.63	0.66
3	4874.00	52.50 PK	74.00	-21.50	1.22 V	248	45.28	7.22
4	4874.00	48.00 AV	54.00	-6.00	1.22 V	248	40.78	7.22

**REMARKS:**

1. Emission Level(dBuV/m) = Raw Value(dBuV) + Correction Factor(dB/m)
2. Correction Factor(dB/m) = Antenna Factor(dB/m) + Cable Factor(dB) – Pre-Amplifier Factor(dB)
3. The other emission levels were very low against the limit.
4. Margin value = Emission Level – Limit value
5. " \* ": Fundamental frequency.

<b>CHANNEL</b>	TX Channel 11	<b>DETECTOR FUNCTION</b>	Peak (PK)
<b>FREQUENCY RANGE</b>	1GHz ~ 25GHz		Average (AV)
<b>TEST MODE</b>	A		

**ANTENNA POLARITY & TEST DISTANCE: HORIZONTAL AT 3 M**

NO.	FREQ. (MHz)	EMISSION LEVEL (dBuV/m)	LIMIT (dBuV/m)	MARGIN (dB)	ANTENNA HEIGHT (m)	TABLE ANGLE (Degree)	RAW VALUE (dBuV)	CORRECTION FACTOR (dB/m)
1	*2462.00	119.19 PK			1.59 H	212	118.34	0.85
2	*2462.00	116.45 AV			1.59 H	212	115.60	0.85
3	2483.50	64.11 PK	74.00	-9.89	1.59 H	212	63.08	1.03
4	2483.50	52.54 AV	54.00	-1.46	1.59 H	212	51.51	1.03
5	4924.00	50.08 PK	74.00	-23.92	2.35 H	245	42.75	7.33
6	4924.00	43.67 AV	54.00	-10.33	2.35 H	245	36.34	7.33

**ANTENNA POLARITY & TEST DISTANCE: VERTICAL AT 3 M**

NO.	FREQ. (MHz)	EMISSION LEVEL (dBuV/m)	LIMIT (dBuV/m)	MARGIN (dB)	ANTENNA HEIGHT (m)	TABLE ANGLE (Degree)	RAW VALUE (dBuV)	CORRECTION FACTOR (dB/m)
1	*2462.00	116.02 PK			1.34 V	200	115.17	0.85
2	*2462.00	113.48 AV			1.34 V	200	112.63	0.85
3	2483.50	62.39 PK	74.00	-11.61	1.34 V	200	61.36	1.03
4	2483.50	49.70 AV	54.00	-4.30	1.34 V	200	48.67	1.03
5	4924.00	46.99 PK	74.00	-27.01	1.36 V	287	39.66	7.33
6	4924.00	40.85 AV	54.00	-13.15	1.36 V	287	33.52	7.33

**REMARKS:**

1. Emission Level(dBuV/m) = Raw Value(dBuV) + Correction Factor(dB/m)
2. Correction Factor(dB/m) = Antenna Factor(dB/m) + Cable Factor(dB) – Pre-Amplifier Factor(dB)
3. The other emission levels were very low against the limit.
4. Margin value = Emission Level – Limit value
5. " \* ": Fundamental frequency.

802.11g

<b>CHANNEL</b>	TX Channel 1	<b>DETECTOR FUNCTION</b>	Peak (PK)
<b>FREQUENCY RANGE</b>	1GHz ~ 25GHz		Average (AV)
<b>TEST MODE</b>	A		

**ANTENNA POLARITY & TEST DISTANCE: HORIZONTAL AT 3 M**

NO.	FREQ. (MHz)	EMISSION LEVEL (dBuV/m)	LIMIT (dBuV/m)	MARGIN (dB)	ANTENNA HEIGHT (m)	TABLE ANGLE (Degree)	RAW VALUE (dBuV)	CORRECTION FACTOR (dB/m)
1	2390.00	72.47 PK	74.00	-1.53	1.12 H	225	72.18	0.29
2	2390.00	52.76 AV	54.00	-1.24	1.12 H	225	52.47	0.29
3	*2412.00	117.56 PK			1.12 H	225	117.10	0.46
4	*2412.00	104.18 AV			1.12 H	225	103.72	0.46
5	4824.00	47.33 PK	74.00	-26.67	1.69 H	22	40.15	7.18
6	4824.00	33.51 AV	54.00	-20.49	1.69 H	22	26.33	7.18

**ANTENNA POLARITY & TEST DISTANCE: VERTICAL AT 3 M**

NO.	FREQ. (MHz)	EMISSION LEVEL (dBuV/m)	LIMIT (dBuV/m)	MARGIN (dB)	ANTENNA HEIGHT (m)	TABLE ANGLE (Degree)	RAW VALUE (dBuV)	CORRECTION FACTOR (dB/m)
1	2390.00	66.47 PK	74.00	-7.53	2.52 V	266	66.18	0.29
2	2390.00	48.09 AV	54.00	-5.91	2.52 V	266	47.80	0.29
3	*2412.00	112.28 PK			3.52 V	266	111.82	0.46
4	*2412.00	98.60 AV			3.52 V	266	98.14	0.46
5	4824.00	46.84 PK	74.00	-27.16	1.27 V	154	39.66	7.18
6	4824.00	32.99 AV	54.00	-21.01	1.27 V	154	25.81	7.18

**REMARKS:**

1. Emission Level(dBuV/m) = Raw Value(dBuV) + Correction Factor(dB/m)
2. Correction Factor(dB/m) = Antenna Factor(dB/m) + Cable Factor(dB) – Pre-Amplifier Factor(dB)
3. The other emission levels were very low against the limit.
4. Margin value = Emission Level – Limit value
5. " \* ": Fundamental frequency.

<b>CHANNEL</b>	TX Channel 6	<b>DETECTOR FUNCTION</b>	Peak (PK)
<b>FREQUENCY RANGE</b>	1GHz ~ 25GHz		Average (AV)
<b>TEST MODE</b>	A		

**ANTENNA POLARITY & TEST DISTANCE: HORIZONTAL AT 3 M**

NO.	FREQ. (MHz)	EMISSION LEVEL (dBuV/m)	LIMIT (dBuV/m)	MARGIN (dB)	ANTENNA HEIGHT (m)	TABLE ANGLE (Degree)	RAW VALUE (dBuV)	CORRECTION FACTOR (dB/m)
1	*2437.00	122.57 PK			1.10 H	215	121.91	0.66
2	*2437.00	109.01 AV			1.10 H	215	108.35	0.66
3	4874.00	47.80 PK	74.00	-26.20	1.58 H	220	40.58	7.22
4	4874.00	33.87 AV	54.00	-20.13	1.58 H	220	26.65	7.22

**ANTENNA POLARITY & TEST DISTANCE: VERTICAL AT 3 M**

NO.	FREQ. (MHz)	EMISSION LEVEL (dBuV/m)	LIMIT (dBuV/m)	MARGIN (dB)	ANTENNA HEIGHT (m)	TABLE ANGLE (Degree)	RAW VALUE (dBuV)	CORRECTION FACTOR (dB/m)
1	*2437.00	117.62 PK			3.26 V	252	116.96	0.66
2	*2437.00	104.50 AV			3.26 V	252	103.84	0.66
3	4874.00	46.67 PK	74.00	-27.33	1.88 V	99	39.45	7.22
4	4874.00	32.40 AV	54.00	-21.60	1.88 V	99	25.18	7.22

**REMARKS:**

1. Emission Level(dBuV/m) = Raw Value(dBuV) + Correction Factor(dB/m)
2. Correction Factor(dB/m) = Antenna Factor(dB/m) + Cable Factor(dB) – Pre-Amplifier Factor(dB)
3. The other emission levels were very low against the limit.
4. Margin value = Emission Level – Limit value
5. " \* ": Fundamental frequency.

<b>CHANNEL</b>	TX Channel 11	<b>DETECTOR FUNCTION</b>	Peak (PK)
<b>FREQUENCY RANGE</b>	1GHz ~ 25GHz		Average (AV)
<b>TEST MODE</b>	A		

**ANTENNA POLARITY & TEST DISTANCE: HORIZONTAL AT 3 M**

NO.	FREQ. (MHz)	EMISSION LEVEL (dBuV/m)	LIMIT (dBuV/m)	MARGIN (dB)	ANTENNA HEIGHT (m)	TABLE ANGLE (Degree)	RAW VALUE (dBuV)	CORRECTION FACTOR (dB/m)
1	*2462.00	117.78 PK			1.98 H	217	116.93	0.85
2	*2462.00	103.94 AV			1.98 H	217	103.09	0.85
3	2483.50	72.25 PK	74.00	-1.75	1.98 H	217	71.22	1.03
4	2483.50	50.06 AV	54.00	-3.94	1.98 H	217	49.03	1.03
5	4924.00	48.32 PK	74.00	-25.68	1.94 H	33	40.99	7.33
6	4924.00	33.93 AV	54.00	-20.07	1.94 H	33	26.60	7.33

**ANTENNA POLARITY & TEST DISTANCE: VERTICAL AT 3 M**

NO.	FREQ. (MHz)	EMISSION LEVEL (dBuV/m)	LIMIT (dBuV/m)	MARGIN (dB)	ANTENNA HEIGHT (m)	TABLE ANGLE (Degree)	RAW VALUE (dBuV)	CORRECTION FACTOR (dB/m)
1	*2462.00	112.70 PK			3.32 V	218	111.85	0.85
2	*2462.00	99.54 AV			3.32 V	218	98.69	0.85
3	2483.50	70.02 PK	74.00	-3.98	3.32 V	218	68.99	1.03
4	2483.50	47.34 AV	54.00	-6.66	3.32 V	218	46.31	1.03
5	4924.00	46.99 PK	74.00	-27.01	1.82 V	208	39.66	7.33
6	4924.00	32.51 AV	54.00	-21.49	1.82 V	208	25.18	7.33

**REMARKS:**

1. Emission Level(dBuV/m) = Raw Value(dBuV) + Correction Factor(dB/m)
2. Correction Factor(dB/m) = Antenna Factor(dB/m) + Cable Factor(dB) – Pre-Amplifier Factor(dB)
3. The other emission levels were very low against the limit.
4. Margin value = Emission Level – Limit value
5. " \* ": Fundamental frequency.



**Beamforming\_NSS1 MODE**

**802.11n (HT20)**

<b>CHANNEL</b>	TX Channel 1	<b>DETECTOR FUNCTION</b>	Peak (PK)
<b>FREQUENCY RANGE</b>	1GHz ~ 25GHz		Average (AV)
<b>TEST MODE</b>	A		

**ANTENNA POLARITY & TEST DISTANCE: HORIZONTAL AT 3 M**

NO.	FREQ. (MHz)	EMISSION LEVEL (dBuV/m)	LIMIT (dBuV/m)	MARGIN (dB)	ANTENNA HEIGHT (m)	TABLE ANGLE (Degree)	RAW VALUE (dBuV)	CORRECTION FACTOR (dB/m)
1	2390.00	72.35 PK	74.00	-1.65	1.29 H	224	72.06	0.29
2	2390.00	52.77 AV	54.00	-1.23	1.29 H	224	52.48	0.29
3	*2412.00	119.18 PK			1.29 H	224	118.72	0.46
4	*2412.00	104.79 AV			1.29 H	224	104.33	0.46
5	4824.00	47.21 PK	74.00	-26.79	1.46 H	158	40.03	7.18
6	4824.00	35.34 AV	54.00	-18.66	1.46 H	158	28.16	7.18

**ANTENNA POLARITY & TEST DISTANCE: VERTICAL AT 3 M**

NO.	FREQ. (MHz)	EMISSION LEVEL (dBuV/m)	LIMIT (dBuV/m)	MARGIN (dB)	ANTENNA HEIGHT (m)	TABLE ANGLE (Degree)	RAW VALUE (dBuV)	CORRECTION FACTOR (dB/m)
1	2390.00	68.80 PK	74.00	-5.20	1.50 V	282	68.51	0.29
2	2390.00	48.12 AV	54.00	-5.88	1.50 V	282	47.83	0.29
3	*2412.00	113.40 PK			1.50 V	282	112.94	0.46
4	*2412.00	98.51 AV			1.50 V	282	98.05	0.46
5	4824.00	46.69 PK	74.00	-27.31	1.73 V	227	39.51	7.18
6	4824.00	35.04 AV	54.00	-18.96	1.73 V	227	27.86	7.18

**REMARKS:**

1. Emission Level(dBuV/m) = Raw Value(dBuV) + Correction Factor(dB/m)
2. Correction Factor(dB/m) = Antenna Factor(dB/m) + Cable Factor(dB) – Pre-Amplifier Factor(dB)
3. The other emission levels were very low against the limit.
4. Margin value = Emission Level – Limit value
5. " \* ": Fundamental frequency.

<b>CHANNEL</b>	TX Channel 6	<b>DETECTOR FUNCTION</b>	Peak (PK)
<b>FREQUENCY RANGE</b>	1GHz ~ 25GHz		Average (AV)
<b>TEST MODE</b>	A		

**ANTENNA POLARITY & TEST DISTANCE: HORIZONTAL AT 3 M**

NO.	FREQ. (MHz)	EMISSION LEVEL (dBuV/m)	LIMIT (dBuV/m)	MARGIN (dB)	ANTENNA HEIGHT (m)	TABLE ANGLE (Degree)	RAW VALUE (dBuV)	CORRECTION FACTOR (dB/m)
1	*2437.00	119.57 PK			1.31 H	227	118.91	0.66
2	*2437.00	105.33 AV			1.31 H	227	104.67	0.66
3	4874.00	47.40 PK	74.00	-26.60	1.49 H	160	40.18	7.22
4	4874.00	35.84 AV	54.00	-18.16	1.49 H	160	28.62	7.22

**ANTENNA POLARITY & TEST DISTANCE: VERTICAL AT 3 M**

NO.	FREQ. (MHz)	EMISSION LEVEL (dBuV/m)	LIMIT (dBuV/m)	MARGIN (dB)	ANTENNA HEIGHT (m)	TABLE ANGLE (Degree)	RAW VALUE (dBuV)	CORRECTION FACTOR (dB/m)
1	*2437.00	114.18 PK			1.53 V	285	113.52	0.66
2	*2437.00	99.06 AV			1.53 V	285	98.40	0.66
3	4874.00	46.84 PK	74.00	-27.16	1.69 V	217	39.62	7.22
4	4874.00	35.10 AV	54.00	-18.90	1.69 V	217	27.88	7.22

**REMARKS:**

1. Emission Level(dBuV/m) = Raw Value(dBuV) + Correction Factor(dB/m)
2. Correction Factor(dB/m) = Antenna Factor(dB/m) + Cable Factor(dB) – Pre-Amplifier Factor(dB)
3. The other emission levels were very low against the limit.
4. Margin value = Emission Level – Limit value
5. " \* ": Fundamental frequency.

<b>CHANNEL</b>	TX Channel 11	<b>DETECTOR FUNCTION</b>	Peak (PK)
<b>FREQUENCY RANGE</b>	1GHz ~ 25GHz		Average (AV)
<b>TEST MODE</b>	A		

**ANTENNA POLARITY & TEST DISTANCE: HORIZONTAL AT 3 M**

NO.	FREQ. (MHz)	EMISSION LEVEL (dBuV/m)	LIMIT (dBuV/m)	MARGIN (dB)	ANTENNA HEIGHT (m)	TABLE ANGLE (Degree)	RAW VALUE (dBuV)	CORRECTION FACTOR (dB/m)
1	*2462.00	118.74 PK			1.27 H	218	117.89	0.85
2	*2462.00	104.26 AV			1.27 H	218	103.41	0.85
3	2483.50	72.72 PK	74.00	-1.28	1.27 H	218	71.69	1.03
4	2483.50	52.37 AV	54.00	-1.63	1.27 H	218	51.34	1.03
5	4924.00	47.06 PK	74.00	-26.94	1.47 H	155	39.73	7.33
6	4924.00	35.27 AV	54.00	-18.73	1.47 H	155	27.94	7.33

**ANTENNA POLARITY & TEST DISTANCE: VERTICAL AT 3 M**

NO.	FREQ. (MHz)	EMISSION LEVEL (dBuV/m)	LIMIT (dBuV/m)	MARGIN (dB)	ANTENNA HEIGHT (m)	TABLE ANGLE (Degree)	RAW VALUE (dBuV)	CORRECTION FACTOR (dB/m)
1	*2462.00	113.56 PK			1.54 V	291	112.71	0.85
2	*2462.00	98.37 AV			1.54 V	291	97.52	0.85
3	2483.50	69.56 PK	74.00	-4.44	1.54 V	291	68.53	1.03
4	2483.50	48.32 AV	54.00	-5.68	1.54 V	291	47.29	1.03
5	4924.00	46.45 PK	74.00	-27.55	1.70 V	221	39.12	7.33
6	4924.00	34.28 AV	54.00	-19.72	1.70 V	221	26.95	7.33

**REMARKS:**

1. Emission Level(dBuV/m) = Raw Value(dBuV) + Correction Factor(dB/m)
2. Correction Factor(dB/m) = Antenna Factor(dB/m) + Cable Factor(dB) – Pre-Amplifier Factor(dB)
3. The other emission levels were very low against the limit.
4. Margin value = Emission Level – Limit value
5. " \* ": Fundamental frequency.

802.11n (HT40)

<b>CHANNEL</b>	TX Channel 3	<b>DETECTOR FUNCTION</b>	Peak (PK)
<b>FREQUENCY RANGE</b>	1GHz ~ 25GHz		Average (AV)
<b>TEST MODE</b>	A		

**ANTENNA POLARITY & TEST DISTANCE: HORIZONTAL AT 3 M**

NO.	FREQ. (MHz)	EMISSION LEVEL (dBuV/m)	LIMIT (dBuV/m)	MARGIN (dB)	ANTENNA HEIGHT (m)	TABLE ANGLE (Degree)	RAW VALUE (dBuV)	CORRECTION FACTOR (dB/m)
1	2390.00	72.81 PK	74.00	-1.19	1.31 H	227	72.52	0.29
2	<b>2390.00</b>	<b>52.94 AV</b>	<b>54.00</b>	<b>-1.06</b>	<b>1.31 H</b>	<b>227</b>	<b>52.65</b>	<b>0.29</b>
3	*2422.00	116.21 PK			1.31 H	227	115.67	0.54
4	*2422.00	102.32 AV			1.31 H	227	101.78	0.54
5	4844.00	46.44 PK	74.00	-27.56	1.54 H	166	39.24	7.20
6	4844.00	34.49 AV	54.00	-19.51	1.54 H	166	27.29	7.20

**ANTENNA POLARITY & TEST DISTANCE: VERTICAL AT 3 M**

NO.	FREQ. (MHz)	EMISSION LEVEL (dBuV/m)	LIMIT (dBuV/m)	MARGIN (dB)	ANTENNA HEIGHT (m)	TABLE ANGLE (Degree)	RAW VALUE (dBuV)	CORRECTION FACTOR (dB/m)
1	2390.00	69.42 PK	74.00	-4.58	1.52 V	274	69.13	0.29
2	2390.00	48.79 AV	54.00	-5.21	1.52 V	274	48.50	0.29
3	*2422.00	109.92 PK			1.52 V	274	109.38	0.54
4	*2422.00	96.03 AV			1.52 V	274	95.49	0.54
5	4844.00	45.79 PK	74.00	-28.21	1.70 V	225	38.59	7.20
6	4844.00	33.95 AV	54.00	-20.05	1.70 V	225	26.75	7.20

**REMARKS:**

1. Emission Level(dBuV/m) = Raw Value(dBuV) + Correction Factor(dB/m)
2. Correction Factor(dB/m) = Antenna Factor(dB/m) + Cable Factor(dB) – Pre-Amplifier Factor(dB)
3. The other emission levels were very low against the limit.
4. Margin value = Emission Level – Limit value
5. " \* ": Fundamental frequency.

<b>CHANNEL</b>	TX Channel 6	<b>DETECTOR FUNCTION</b>	Peak (PK)
<b>FREQUENCY RANGE</b>	1GHz ~ 25GHz		Average (AV)
<b>TEST MODE</b>	A		

**ANTENNA POLARITY & TEST DISTANCE: HORIZONTAL AT 3 M**

NO.	FREQ. (MHz)	EMISSION LEVEL (dBuV/m)	LIMIT (dBuV/m)	MARGIN (dB)	ANTENNA HEIGHT (m)	TABLE ANGLE (Degree)	RAW VALUE (dBuV)	CORRECTION FACTOR (dB/m)
1	*2437.00	117.39 PK			1.27 H	223	116.73	0.66
2	*2437.00	103.47 AV			1.27 H	223	102.81	0.66
3	4874.00	46.57 PK	74.00	-27.43	1.50 H	158	39.35	7.22
4	4874.00	34.72 AV	54.00	-19.28	1.50 H	158	27.50	7.22

**ANTENNA POLARITY & TEST DISTANCE: VERTICAL AT 3 M**

NO.	FREQ. (MHz)	EMISSION LEVEL (dBuV/m)	LIMIT (dBuV/m)	MARGIN (dB)	ANTENNA HEIGHT (m)	TABLE ANGLE (Degree)	RAW VALUE (dBuV)	CORRECTION FACTOR (dB/m)
1	*2437.00	111.50 PK			1.58 V	277	110.84	0.66
2	*2437.00	97.61 AV			1.58 V	277	96.95	0.66
3	4874.00	45.88 PK	74.00	-28.12	1.72 V	225	38.66	7.22
4	4874.00	34.03 AV	54.00	-19.97	1.72 V	225	26.81	7.22

**REMARKS:**

1. Emission Level(dBuV/m) = Raw Value(dBuV) + Correction Factor(dB/m)
2. Correction Factor(dB/m) = Antenna Factor(dB/m) + Cable Factor(dB) – Pre-Amplifier Factor(dB)
3. The other emission levels were very low against the limit.
4. Margin value = Emission Level – Limit value
5. " \* ": Fundamental frequency.

<b>CHANNEL</b>	TX Channel 9	<b>DETECTOR FUNCTION</b>	Peak (PK)
<b>FREQUENCY RANGE</b>	1GHz ~ 25GHz		Average (AV)
<b>TEST MODE</b>	A		

**ANTENNA POLARITY & TEST DISTANCE: HORIZONTAL AT 3 M**

NO.	FREQ. (MHz)	EMISSION LEVEL (dBuV/m)	LIMIT (dBuV/m)	MARGIN (dB)	ANTENNA HEIGHT (m)	TABLE ANGLE (Degree)	RAW VALUE (dBuV)	CORRECTION FACTOR (dB/m)
1	*2452.00	115.74 PK			1.29 H	230	114.96	0.78
2	*2452.00	101.91 AV			1.29 H	230	101.13	0.78
3	2483.50	72.60 PK	74.00	-1.40	1.29 H	230	71.57	1.03
4	2483.50	50.39 AV	54.00	-3.61	1.29 H	230	49.36	1.03
5	4904.00	46.67 PK	74.00	-27.33	1.46 H	162	39.41	7.26
6	4904.00	34.64 AV	54.00	-19.36	1.46 H	162	27.38	7.26

**ANTENNA POLARITY & TEST DISTANCE: VERTICAL AT 3 M**

NO.	FREQ. (MHz)	EMISSION LEVEL (dBuV/m)	LIMIT (dBuV/m)	MARGIN (dB)	ANTENNA HEIGHT (m)	TABLE ANGLE (Degree)	RAW VALUE (dBuV)	CORRECTION FACTOR (dB/m)
1	*2452.00	109.71 PK			1.55 V	281	108.93	0.78
2	*2452.00	95.84 AV			1.55 V	281	95.06	0.78
3	2483.50	67.76 PK	74.00	-6.24	1.55 V	281	66.73	1.03
4	2483.50	44.24 AV	54.00	-9.76	1.55 V	281	43.21	1.03
5	4904.00	45.79 PK	74.00	-28.21	1.68 V	219	38.53	7.26
6	4904.00	34.05 AV	54.00	-19.95	1.68 V	219	26.79	7.26

**REMARKS:**

1. Emission Level(dBuV/m) = Raw Value(dBuV) + Correction Factor(dB/m)
2. Correction Factor(dB/m) = Antenna Factor(dB/m) + Cable Factor(dB) – Pre-Amplifier Factor(dB)
3. The other emission levels were very low against the limit.
4. Margin value = Emission Level – Limit value
5. " \* ": Fundamental frequency.

**CDD MODE**
**BELOW 1GHz WORST-CASE DATA**
**802.11b**

<b>CHANNEL</b>	TX Channel 6	<b>DETECTOR FUNCTION</b>	Quasi-Peak (QP)
<b>FREQUENCY RANGE</b>	9kHz ~ 1GHz		
<b>TEST MODE</b>	A		

**ANTENNA POLARITY & TEST DISTANCE: HORIZONTAL AT 3 M**

NO.	FREQ. (MHz)	EMISSION LEVEL (dBuV/m)	LIMIT (dBuV/m)	MARGIN (dB)	ANTENNA HEIGHT (m)	TABLE ANGLE (Degree)	RAW VALUE (dBuV)	CORRECTION FACTOR (dB/m)
1	77.19	21.08 QP	40.00	-18.92	4.00 H	274	34.47	-13.39
2	148.15	24.15 QP	43.50	-19.35	4.00 H	260	33.58	-9.43
3	459.86	24.47 QP	46.00	-21.53	3.21 H	85	28.87	-4.40
4	692.70	28.70 QP	46.00	-17.30	2.00 H	22	28.71	-0.01
5	917.45	32.31 QP	46.00	-13.69	1.07 H	167	28.42	3.89
6	984.04	33.17 QP	54.00	-20.83	1.00 H	245	28.39	4.78

**ANTENNA POLARITY & TEST DISTANCE: VERTICAL AT 3 M**

NO.	FREQ. (MHz)	EMISSION LEVEL (dBuV/m)	LIMIT (dBuV/m)	MARGIN (dB)	ANTENNA HEIGHT (m)	TABLE ANGLE (Degree)	RAW VALUE (dBuV)	CORRECTION FACTOR (dB/m)
1	34.66	32.21 QP	40.00	-7.79	1.38 V	174	43.40	-11.19
2	66.28	33.22 QP	40.00	-6.78	1.40 V	0	44.31	-11.09
3	155.62	24.08 QP	43.50	-19.42	1.00 V	99	33.20	-9.12
4	682.91	29.19 QP	46.00	-16.81	2.69 V	91	29.26	-0.07
5	818.71	30.91 QP	46.00	-15.09	2.71 V	155	28.70	2.21
6	998.21	33.25 QP	54.00	-20.75	2.03 V	185	28.35	4.90

**REMARKS:**

1. Emission Level(dBuV/m) = Raw Value(dBuV) + Correction Factor(dB/m)
2. Correction Factor(dB/m) = Antenna Factor(dB/m) + Cable Factor(dB) – Pre-Amplifier Factor(dB)
3. The other emission levels were very low against the limit.
4. Margin value = Emission Level – Limit value

## 4.2 Conducted Emission Measurement

### 4.2.1 Limits of Conducted Emission Measurement

Frequency (MHz)	Conducted Limit (dBuV)	
	Quasi-peak	Average
0.15 - 0.5	66 - 56	56 - 46
0.50 - 5.0	56	46
5.0 - 30.0	60	50

Note: 1. The lower limit shall apply at the transition frequencies.

2. The limit decreases in line with the logarithm of the frequency in the range of 0.15 to 0.50MHz.

### 4.2.2 Test Instruments

Description & Manufacturer	Model No.	Serial No.	Cal. Date	Cal. Due
ROHDE & SCHWARZ TEST RECEIVER	ESCS 30	100276	Apr. 12, 2016	Apr. 11, 2017
ROHDE & SCHWARZ Artificial Mains Network (for EUT)	ENV216	101197	May 04, 2016	May 03, 2017
LISN With Adapter (for EUT)	AD10	C10Ada-002	May 04, 2016	May 03, 2017
ROHDE & SCHWARZ Artificial Mains Network (for peripherals)	ESH3-Z5	100218	Nov. 23, 2016	Nov. 22, 2017
SCHWARZBECK Artificial Mains Network (For EUT)	NNLK8129	8129229	May 04, 2016	May 03, 2017
Software	Cond_V7.3.7.4	NA	NA	NA
RF cable (JYEBAO) With 10dB PAD	5D-FB	Cable-C10.01	Feb. 14, 2017	Feb. 13, 2018
SUHNER Terminator (For ROHDE & SCHWARZ LISN)	65BNC-5001	E1-011484	May 12, 2016	May 11, 2017
ROHDE & SCHWARZ Artificial Mains Network (For TV EUT)	ESH3-Z5	100220	Nov. 08, 2016	Nov. 07, 2017
LISN With Adapter (for TV EUT)	100220	N/A	Nov. 08, 2016	Nov. 07, 2017

Notes: 1. The calibration interval of the above test instruments is 12 months and the calibrations are traceable to NML/ROC and NIST/USA.

2. The test was performed in Shielded Room No. 10.

3. The VCCI Site Registration No. C-1852.

4. Tested Date: Feb. 15, 2017



#### 4.2.3 Test Procedures

- The EUT was placed 0.4 meters from the conducting wall of the shielded room with EUT being connected to the power mains through a line impedance stabilization network (LISN). Other support units were connected to the power mains through another LISN. The two LISNs provide 50 ohm/ 50uH of coupling impedance for the measuring instrument.
- Both lines of the power mains connected to the EUT were checked for maximum conducted interference.
- The frequency range from 150kHz to 30MHz was searched. Emission levels under (Limit - 20dB) was not recorded.

**NOTE:** The resolution bandwidth and video bandwidth of test receiver is 9kHz for quasi-peak detection (QP) and average detection (AV) at frequency 0.15MHz-30MHz.

#### 4.2.4 Deviation from Test Standard

No deviation.

#### 4.2.5 Test Setup

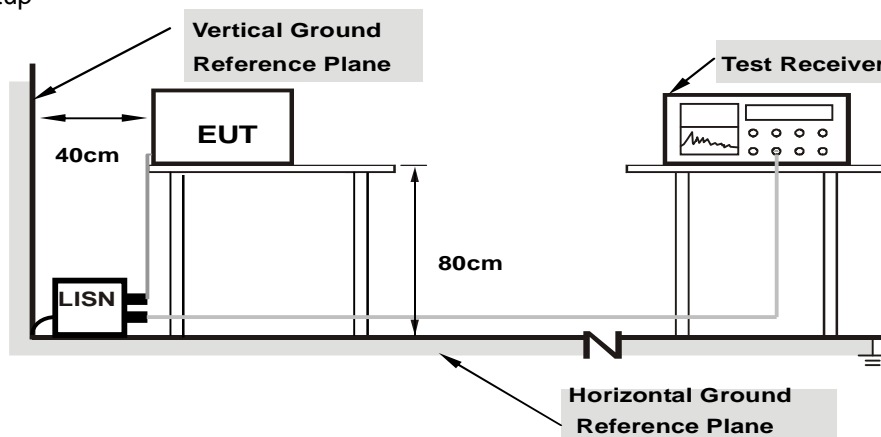

**Note:** 1.Support units were connected to second LISN.

For the actual test configuration, please refer to the attached file (Test Setup Photo).

#### 4.2.6 EUT Operating Conditions

Same as Item 4.1.6.

#### 4.2.7 Test Results

##### CDD MODE

Phase	Line (L)	Detector Function	Quasi-Peak (QP) / Average (AV)
Test Mode	A		

No	Frequency (MHz)	Correction Factor (dB)	Reading Value (dBuV)		Emission Level (dBuV)		Limit (dBuV)		Margin (dB)	
			Q.P.	AV.	Q.P.	AV.	Q.P.	AV.	Q.P.	AV.
1	0.15001	9.71	35.00	21.13	44.71	30.84	66.00	56.00	-21.29	-25.16
<b>2</b>	<b>0.25547</b>	<b>9.72</b>	<b>32.23</b>	<b>29.78</b>	<b>41.95</b>	<b>39.50</b>	<b>61.58</b>	<b>51.58</b>	<b>-19.63</b>	<b>-12.08</b>
3	0.51328	9.76	11.84	3.68	21.60	13.44	56.00	46.00	-34.40	-32.56
4	3.75391	10.08	11.73	8.10	21.81	18.18	56.00	46.00	-34.19	-27.82
5	11.27344	10.23	13.38	8.17	23.61	18.40	60.00	50.00	-36.39	-31.60
6	23.70313	10.38	11.20	7.51	21.58	17.89	60.00	50.00	-38.42	-32.11

##### Remarks:

1. Q.P. and AV. are abbreviations of quasi-peak and average individually.
2. The emission levels of other frequencies were very low against the limit.
3. Margin value = Emission level – Limit value
4. Correction factor = Insertion loss + Cable loss
5. Emission Level = Correction Factor + Reading Value

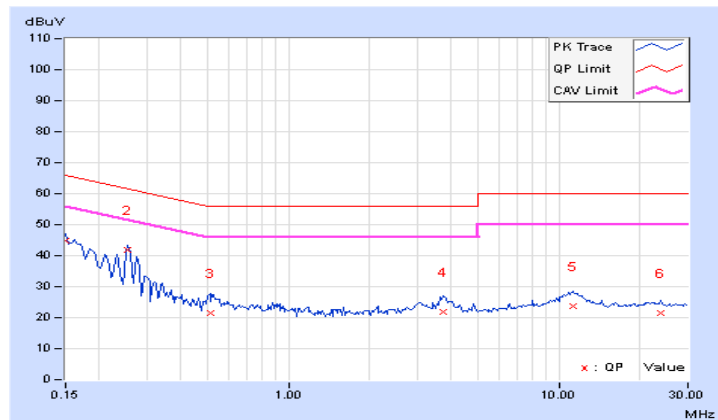

Phase	Neutral (N)	Detector Function	Quasi-Peak (QP) / Average (AV)
Test Mode	A		

No	Frequency (MHz)	Correction Factor (dB)	Reading Value (dBUV)		Emission Level (dBUV)		Limit (dBUV)		Margin (dB)	
			Q.P.	AV.	Q.P.	AV.	Q.P.	AV.	Q.P.	AV.
1	0.15001	9.72	34.69	21.31	44.41	31.03	66.00	56.00	-21.59	-24.97
2	0.25547	9.73	31.56	29.72	41.29	39.45	61.58	51.58	-20.29	-12.13
3	0.27500	9.73	27.77	25.95	37.50	35.68	60.97	50.97	-23.47	-15.29
4	0.53281	9.78	12.19	5.01	21.97	14.79	56.00	46.00	-34.03	-31.21
5	3.75000	10.15	13.79	6.97	23.94	17.12	56.00	46.00	-32.06	-28.88
6	11.92188	10.27	11.30	6.29	21.57	16.56	60.00	50.00	-38.43	-33.44

**Remarks:**

1. Q.P. and AV. are abbreviations of quasi-peak and average individually.
2. The emission levels of other frequencies were very low against the limit.
3. Margin value = Emission level – Limit value
4. Correction factor = Insertion loss + Cable loss
5. Emission Level = Correction Factor + Reading Value

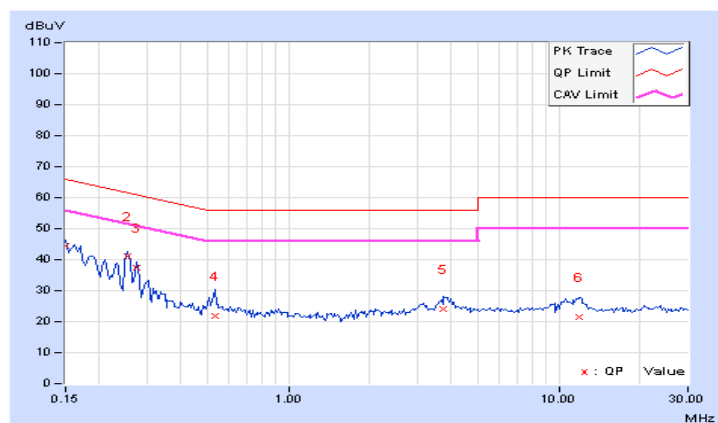

Phase	Line (L)	Detector Function	Quasi-Peak (QP) / Average (AV)
Test Mode	B		

No	Frequency (MHz)	Correction Factor (dB)	Reading Value (dBuV)		Emission Level (dBuV)		Limit (dBuV)		Margin (dB)	
			Q.P.	AV.	Q.P.	AV.	Q.P.	AV.	Q.P.	AV.
1	0.18125	9.71	38.93	15.87	48.64	25.58	64.43	54.43	-15.79	-28.85
2	0.25156	9.71	29.84	9.67	39.55	19.38	61.71	51.71	-22.16	-32.33
3	0.36094	9.71	31.08	17.60	40.79	27.31	58.71	48.71	-17.92	-21.40
4	0.91563	9.74	19.53	5.10	29.27	14.84	56.00	46.00	-26.73	-31.16
5	2.01563	9.79	21.73	9.30	31.52	19.09	56.00	46.00	-24.48	-26.91
6	7.26563	9.93	20.22	14.44	30.15	24.37	60.00	50.00	-29.85	-25.63
7	25.76563	9.99	18.38	13.05	28.37	23.04	60.00	50.00	-31.63	-26.96

**Remarks:**

1. Q.P. and AV. are abbreviations of quasi-peak and average individually.
2. The emission levels of other frequencies were very low against the limit.
3. Margin value = Emission level – Limit value
4. Correction factor = Insertion loss + Cable loss
5. Emission Level = Correction Factor + Reading Value

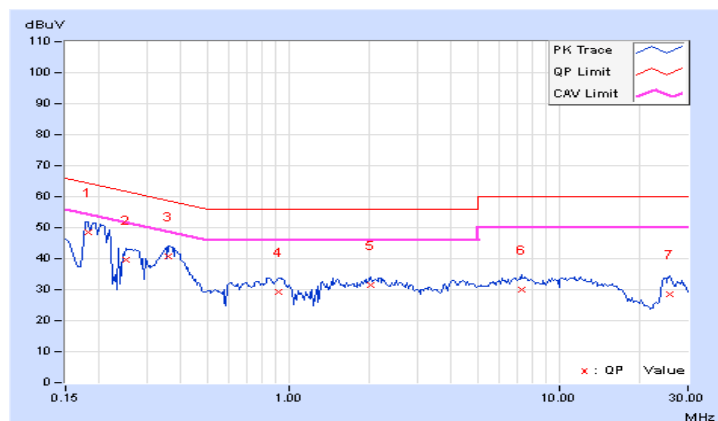

Phase	Neutral (N)	Detector Function	Quasi-Peak (QP) / Average (AV)
Test Mode	B		

No	Frequency (MHz)	Correction Factor (dB)	Reading Value (dBUV)		Emission Level (dBUV)		Limit (dBUV)		Margin (dB)	
			Q.P.	AV.	Q.P.	AV.	Q.P.	AV.	Q.P.	AV.
1	0.15001	9.70	33.42	12.81	43.12	22.51	66.00	56.00	-22.88	-33.49
2	0.18125	9.70	39.38	16.89	49.08	26.59	64.43	54.43	-15.35	-27.84
3	0.23984	9.70	31.50	14.18	41.20	23.88	62.10	52.10	-20.90	-28.22
4	0.37266	9.71	30.27	12.47	39.98	22.18	58.44	48.44	-18.46	-26.26
5	0.85313	9.73	21.24	7.90	30.97	17.63	56.00	46.00	-25.03	-28.37
6	4.30859	9.88	19.51	10.30	29.39	20.18	56.00	46.00	-26.61	-25.82
7	4.30859	9.88	19.47	10.30	29.35	20.18	56.00	46.00	-26.65	-25.82
8	10.94531	9.95	19.76	14.97	29.71	24.92	60.00	50.00	-30.29	-25.08
9	24.57422	9.96	20.43	14.47	30.39	24.43	60.00	50.00	-29.61	-25.57

**Remarks:**

1. Q.P. and AV. are abbreviations of quasi-peak and average individually.
2. The emission levels of other frequencies were very low against the limit.
3. Margin value = Emission level – Limit value
4. Correction factor = Insertion loss + Cable loss
5. Emission Level = Correction Factor + Reading Value

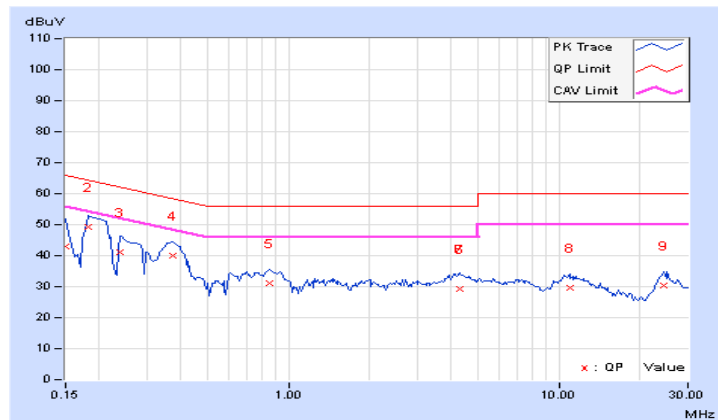

### 4.3 6dB Bandwidth Measurement

#### 4.3.1 Limits of 6dB Bandwidth Measurement

The minimum of 6dB Bandwidth Measurement is 0.5 MHz.

#### 4.3.2 Test Setup

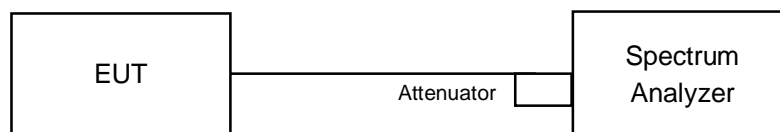

#### 4.3.3 Test Instruments

Refer to section 4.1.2 to get information of above instrument.

#### 4.3.4 Test Procedure

- a. Set resolution bandwidth (RBW) = 100kHz
- b. Set the video bandwidth (VBW)  $\geq 3 \times$  RBW, Detector = Peak.
- c. Trace mode = max hold.
- d. Sweep = auto couple.
- e. Measure the maximum width of the emission that is constrained by the frequencies associated with the two amplitude points (upper and lower) that are attenuated by 6 dB relative to the maximum level measured in the fundamental emission

#### 4.3.5 Deviation from Test Standard

No deviation.

#### 4.3.6 EUT Operating Conditions

The software provided by client to enable the EUT under transmission condition continuously at lowest, middle and highest channel frequencies individually.

#### 4.3.7 Test Result

#### Mode A

#### CDD MODE

#### 802.11b

Channel	Frequency (MHz)	6dB Bandwidth (MHz)		Minimum Limit (MHz)	Pass / Fail
		Chain 0	Chain 1		
1	2412	8.58	8.10	0.5	PASS
6	2437	9.06	9.04	0.5	PASS
11	2462	8.08	8.09	0.5	PASS

#### 802.11g

Channel	Frequency (MHz)	6dB Bandwidth (MHz)		Minimum Limit (MHz)	Pass / Fail
		Chain 0	Chain 1		
1	2412	16.36	16.37	0.5	PASS
6	2437	16.35	16.35	0.5	PASS
11	2462	16.38	16.38	0.5	PASS

#### Beamforming\_NSS1 MODE

#### 802.11n (20MHz)

Channel	Frequency (MHz)	6dB Bandwidth (MHz)		Minimum Limit (MHz)	Pass / Fail
		Chain 0	Chain 1		
1	2412	17.59	17.60	0.5	Pass
6	2437	17.59	17.60	0.5	Pass
11	2462	17.60	17.60	0.5	Pass

#### 802.11n (40MHz)

Channel	Frequency (MHz)	6dB Bandwidth (MHz)		Minimum Limit (MHz)	Pass / Fail
		Chain 0	Chain 1		
3	2422	35.18	35.18	0.5	Pass
6	2437	35.17	35.24	0.5	Pass
9	2452	35.18	35.26	0.5	Pass

Spectrum Plot of Worst Value

802.11b / Chain 0 : CH6

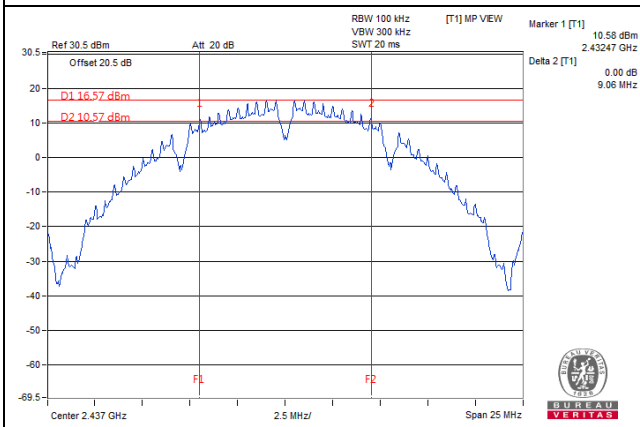

802.11g / Chain 0 : CH11

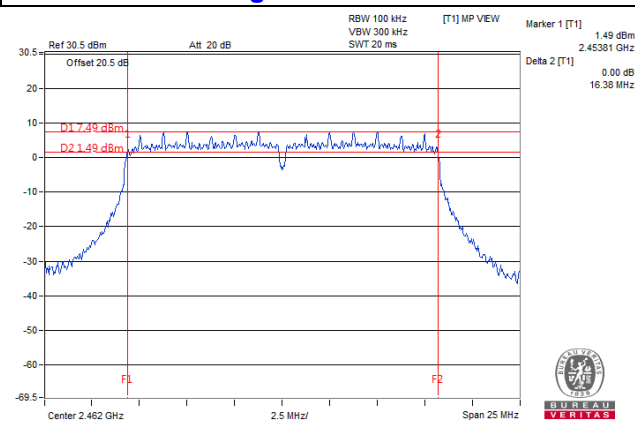

802.11n (20MHz) / Chain 0 : CH11

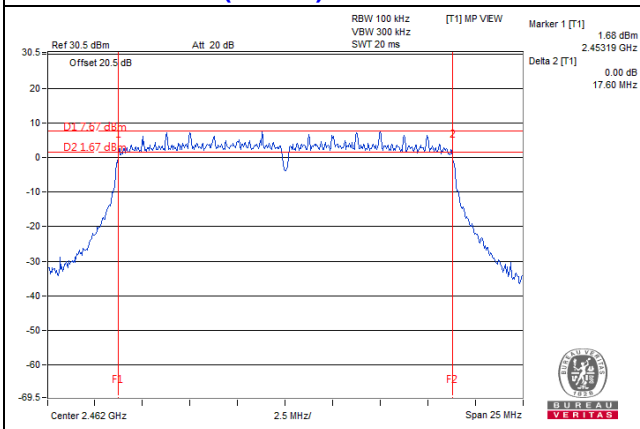

802.11n (40MHz) / Chain 1 : CH9

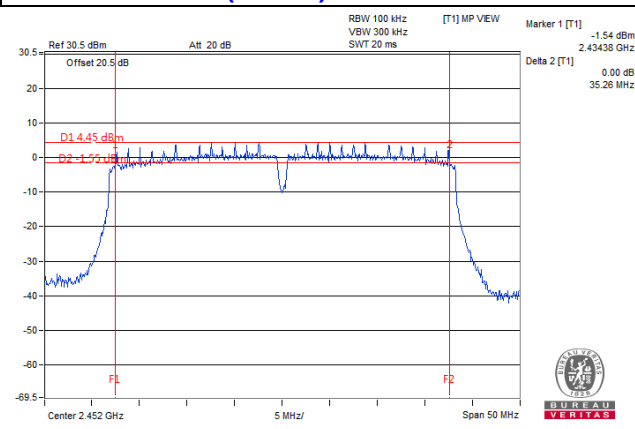



## 4.4 Conducted Output Power Measurement

### 4.4.1 Limits of Conducted Output Power Measurement

For systems using digital modulation in the 2400–2483.5 MHz bands: 1 Watt (30dBm)

Per KDB 662911 D01 Multiple Transmitter Output Method of conducted output power measurement on IEEE 802.11 devices,

Array Gain = 0 dB (i.e., no array gain) for  $N_{ANT} \leq 4$ ;

Array Gain = 0 dB (i.e., no array gain) for channel widths  $\geq 40$  MHz for any  $N_{ANT}$ ;

Array Gain =  $5 \log(N_{ANT}/N_{SS})$  dB or 3 dB, whichever is less for 20-MHz channel widths with  $N_{ANT} \geq 5$ .

For power measurements on all other devices: Array Gain =  $10 \log(N_{ANT}/N_{SS})$  dB.

### 4.4.2 Test Setup

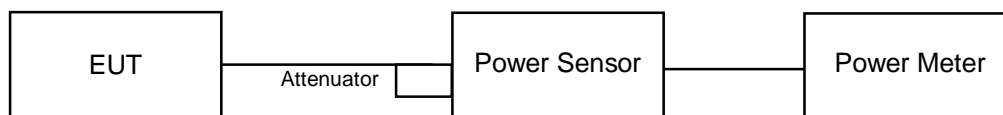

### 4.4.3 Test Instruments

Refer to section 4.1.2 to get information of above instrument.

### 4.4.4 Test Procedures

An average power sensor was used on the output port of the EUT. A power meter was used to read the response of the average power sensor. Record the power level.

### 4.4.5 Deviation from Test Standard

No deviation.

### 4.4.6 EUT Operating Conditions

Same as Item 4.3.6.

#### 4.4.7 Test Results

##### Mode A

##### CDD MODE

##### 802.11b

Chan.	Freq. (MHz)	Average Power (dBm)		Total Power (mW)	Total Power (dBm)	Limit (dBm)	Pass / Fail
		Chain 0	Chain 1				
1	2412	24.43	24.47	557.230	27.46	30	Pass
6	2437	25.58	25.59	<b>723.653</b>	28.60	30	Pass
11	2462	23.39	23.53	443.697	26.47	30	Pass

##### 802.11g

Chan.	Freq. (MHz)	Average Power (dBm)		Total Power (mW)	Total Power (dBm)	Limit (dBm)	Pass / Fail
		Chain 0	Chain 1				
1	2412	19.81	19.63	187.552	22.73	30	Pass
6	2437	23.78	23.73	474.829	26.77	30	Pass
11	2462	19.45	19.28	172.828	22.38	30	Pass

##### 802.11n (20MHz)

Chan.	Freq. (MHz)	Average Power (dBm)		Total Power (mW)	Total Power (dBm)	Limit (dBm)	Pass / Fail
		Chain 0	Chain 1				
1	2412	19.72	19.48	182.472	22.61	30	Pass
6	2437	23.83	23.74	478.138	26.80	30	Pass
11	2462	19.41	19.12	168.955	22.28	30	Pass

##### 802.11n (40MHz)

Chan.	Freq. (MHz)	Average Power (dBm)		Total Power (mW)	Total Power (dBm)	Limit (dBm)	Pass / Fail
		Chain 0	Chain 1				
3	2422	16.50	16.55	89.854	19.54	30	Pass
6	2437	21.49	21.51	282.508	24.51	30	Pass
9	2452	18.81	18.92	154.016	21.88	30	Pass

### Beamforming\_NSS1 MODE

#### 802.11n (20MHz)

Chan.	Freq. (MHz)	Average Power (dBm)		Total Power (mW)	Total Power (dBm)	Limit (dBm)	Pass / Fail
		Chain 0	Chain 1				
1	2412	21.77	21.58	294.194	24.69	30	Pass
6	2437	23.83	23.74	478.138	26.80	30	Pass
11	2462	21.83	21.56	295.624	24.71	30	Pass

#### 802.11n (40MHz)

Chan.	Freq. (MHz)	Average Power (dBm)		Total Power (mW)	Total Power (dBm)	Limit (dBm)	Pass / Fail
		Chain 0	Chain 1				
3	2422	20.49	20.57	225.969	23.54	30	Pass
6	2437	24.34	24.41	547.702	27.39	30	Pass
9	2452	21.42	21.54	281.237	24.49	30	Pass

## 4.5 Power Spectral Density Measurement

### 4.5.1 Limits of Power Spectral Density Measurement

The Maximum of Power Spectral Density Measurement is 8dBm.

### 4.5.2 Test Setup

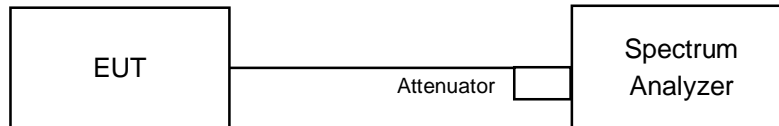

### 4.5.3 Test Instruments

Refer to section 4.1.2 to get information of above instrument.

### 4.5.4 Test Procedure

- a. Set analyzer center frequency to DTS channel center frequency.
- b. Set the span to 1.5 times the DTS bandwidth.
- c. Set the RBW to:  $3 \text{ kHz} \leq \text{RBW} \leq 100 \text{ kHz}$ .
- d. Set the VBW  $\geq 3 \times \text{RBW}$ .
- e. Detector = peak.
- f. Sweep time = auto couple.
- g. Trace mode = max hold.
- h. Allow trace to fully stabilize.
- i. Use the peak marker function to determine the maximum amplitude level within the RBW.

### 4.5.5 Deviation from Test Standard

No deviation.

### 4.5.6 EUT Operating Condition

Same as Item 4.3.6

#### 4.5.7 Test Results

##### Mode A

##### CDD MODE

##### 802.11b

TX chain	Channel	Freq. (MHz)	PSD (dBm/3kHz)	10 log (N=2) dB	Total PSD (dBm/3kHz)	Limit (dBm/3kHz)	Pass /Fail
0	1	2412	2.59	3.01	5.60	8	Pass
	6	2437	2.46	3.01	5.47	8	Pass
	11	2462	0.98	3.01	3.99	8	Pass
1	1	2412	1.56	3.01	4.57	8	Pass
	6	2437	2.68	3.01	5.69	8	Pass
	11	2462	1.52	3.01	4.53	8	Pass

**NOTE:** Directional gain =  $1.5\text{dBi} + 10\log(2) = 4.51\text{dBi} < 6\text{dBi}$  , so the power spectral density limit is not reduced.

##### 802.11g

TX chain	Channel	Freq. (MHz)	PSD (dBm/3kHz)	10 log (N=2) dB	Total PSD (dBm/3kHz)	Limit (dBm/3kHz)	Pass /Fail
0	1	2412	-5.56	3.01	-2.55	8	Pass
	6	2437	-1.86	3.01	1.15	8	Pass
	11	2462	-7.01	3.01	-4.00	8	Pass
1	1	2412	-5.50	3.01	-2.49	8	Pass
	6	2437	-1.09	3.01	1.92	8	Pass
	11	2462	-5.80	3.01	-2.79	8	Pass

**NOTE:** Directional gain =  $1.5\text{dBi} + 10\log(2) = 4.51\text{dBi} < 6\text{dBi}$  , so the power spectral density limit is not reduced.

##### Beamforming\_NSS1 MODE

##### 802.11n (20MHz)

TX chain	Channel	Freq. (MHz)	PSD (dBm/3kHz)	10 log (N=2) dB	Total PSD (dBm/3kHz)	Limit (dBm/3kHz)	Pass /Fail
0	1	2412	-5.81	3.01	-2.80	8	Pass
	6	2437	-1.34	3.01	1.67	8	Pass
	11	2462	-6.41	3.01	-3.40	8	Pass
1	1	2412	-5.13	3.01	-2.12	8	Pass
	6	2437	-1.46	3.01	1.55	8	Pass
	11	2462	-6.43	3.01	-3.42	8	Pass

**NOTE:** Directional gain =  $2.93\text{dBi} + 10\log(2) = 5.94\text{dBi} < 6\text{dBi}$  , so the power spectral density limit is not reduced.

### 802.11n (40MHz)

TX chain	Channel	Freq. (MHz)	PSD (dBm/3kHz)	10 log (N=2) dB	Total PSD (dBm/3kHz)	Limit (dBm/3kHz)	Pass /Fail
0	3	2422	-11.61	3.01	-8.60	8	Pass
	6	2437	-9.32	3.01	-6.31	8	Pass
	9	2452	-10.93	3.01	-7.92	8	Pass
1	3	2422	-11.37	3.01	-8.36	8	Pass
	6	2437	-9.14	3.01	-6.13	8	Pass
	9	2452	-10.67	3.01	-7.66	8	Pass

**NOTE:** Directional gain =  $2.93\text{dBi} + 10\log(2) = 5.94\text{dBi} < 6\text{dBi}$  , so the power spectral density limit is not reduced.

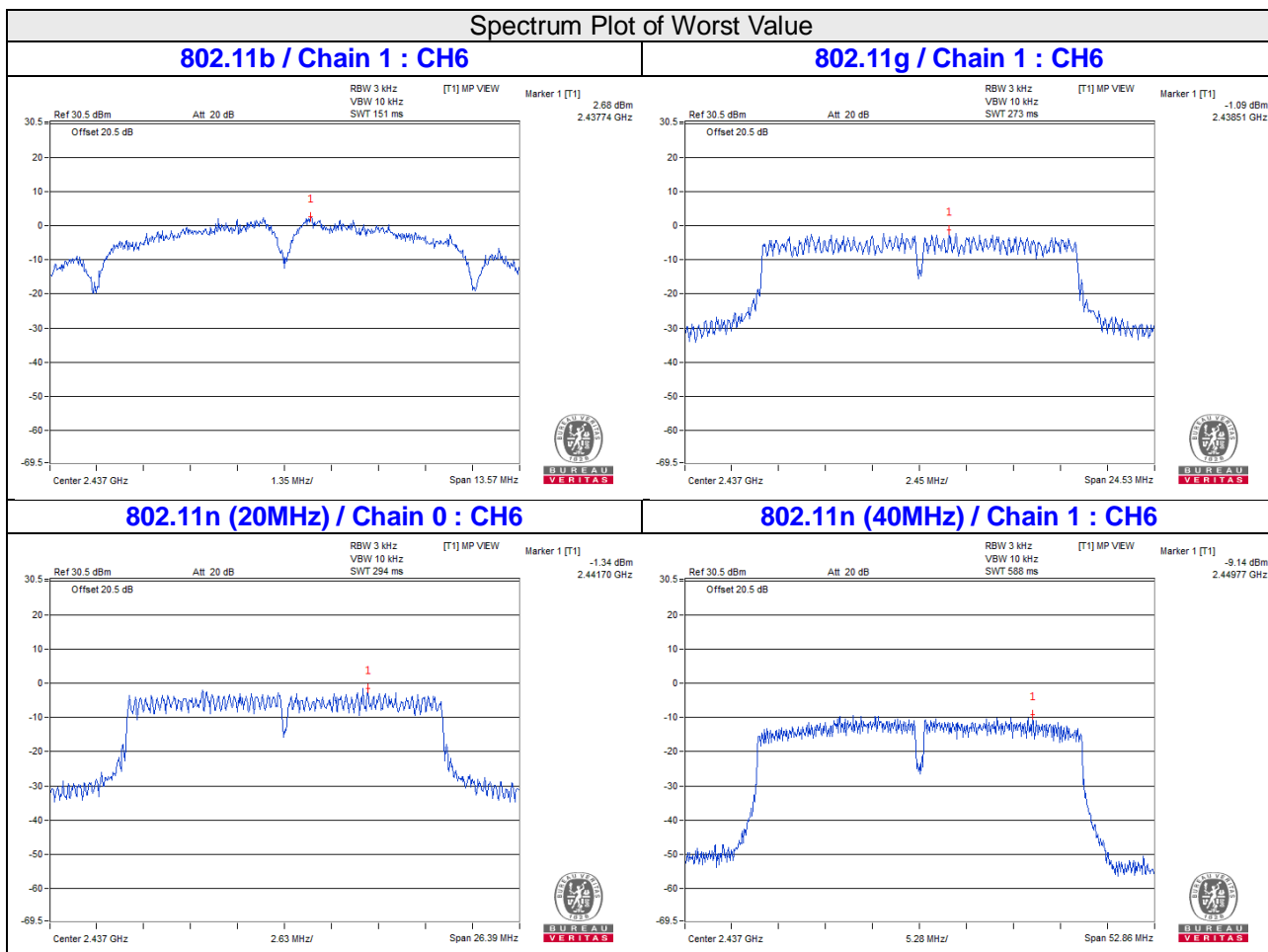

## 4.6 Conducted Out of Band Emission Measurement

### 4.6.1 Limits of Conducted Out of Band Emission Measurement

Below 30dB of the highest emission level of operating band (in 100kHz Resolution Bandwidth).

### 4.6.2 Test Setup

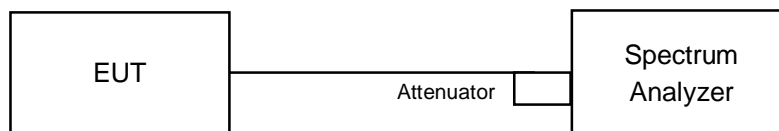

### 4.6.3 Test Instruments

Refer to section 4.1.2 to get information of above instrument.

### 4.6.4 Test Procedure

#### MEASUREMENT PROCEDURE REF

1. Set the RBW = 100 kHz.
2. Set the VBW  $\geq$  300 kHz.
3. Detector = peak.
4. Sweep time = auto couple.
5. Trace mode = max hold.
6. Allow trace to fully stabilize.
7. Use the peak marker function to determine the maximum power level in any 100 kHz band segment within the fundamental EBW.

#### MEASUREMENT PROCEDURE OOB

1. Set RBW = 100 kHz.
2. Set VBW  $\geq$  300 kHz.
3. Detector = peak.
4. Sweep = auto couple.
5. Trace Mode = max hold.
6. Allow trace to fully stabilize.
7. Use the peak marker function to determine the maximum amplitude level.

### 4.6.5 Deviation from Test Standard

No deviation.

### 4.6.6 EUT Operating Condition

Same as Item 4.3.6

### 4.6.7 Test Results

The spectrum plots are attached on the following pages. D1 line indicates the highest level, and D2 line indicates the 30dB offset below D1. It shows compliance with the requirement.

**Mode A**  
**CDD MODE**  
**802.11b: CHAIN 0**

**CH 1**

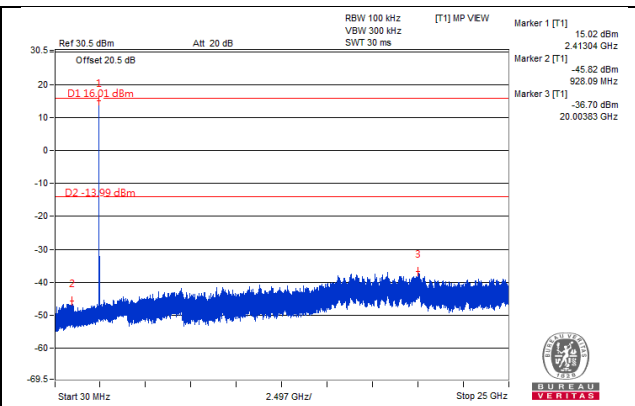
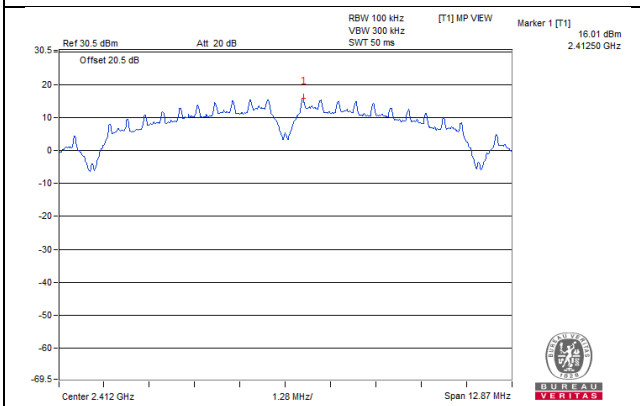

**CH 6**

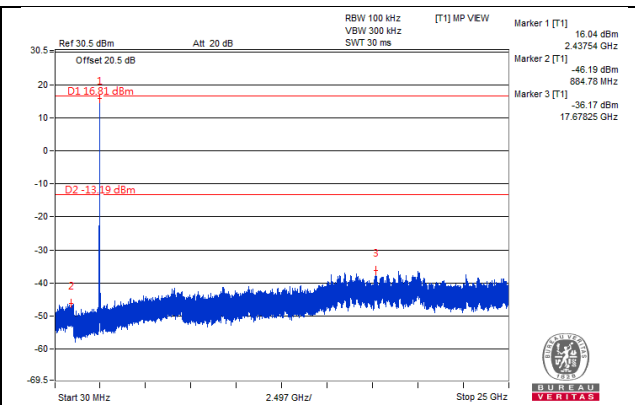
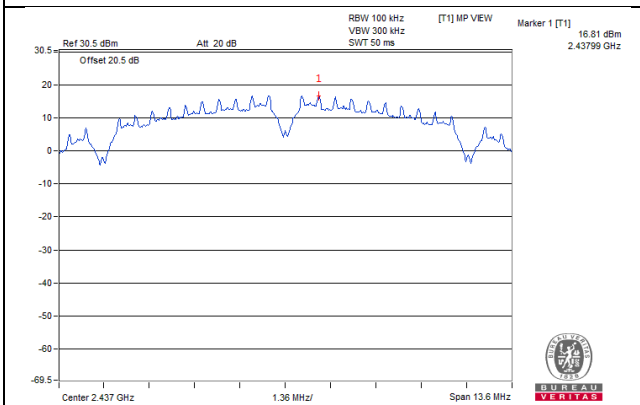

**CH 11**

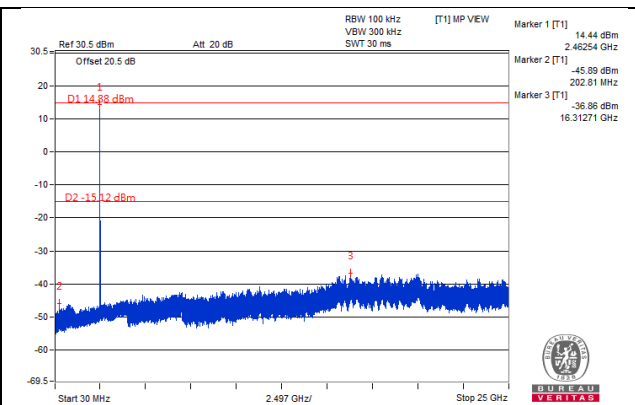
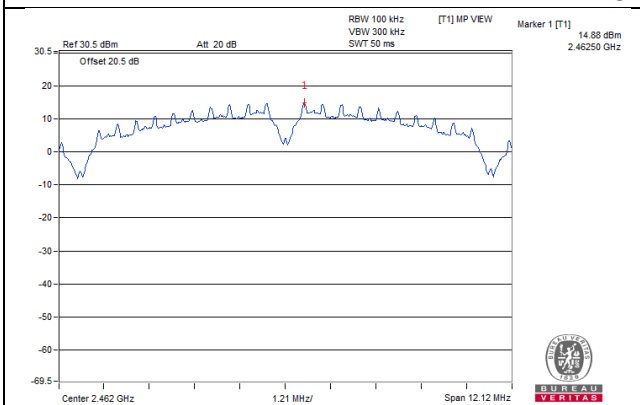

**CH 1 Band edge**

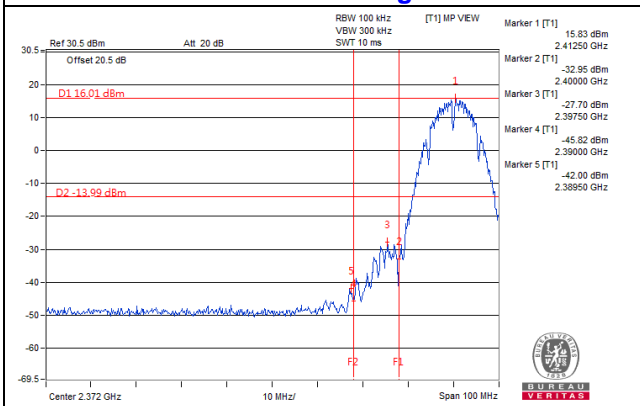

**CH 11 Band edge**

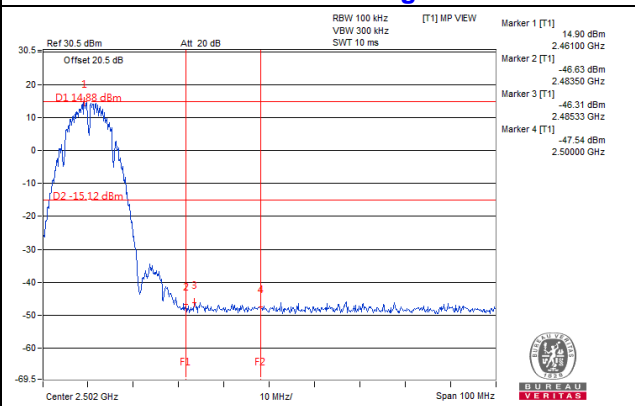



CHAIN 1

CH 1

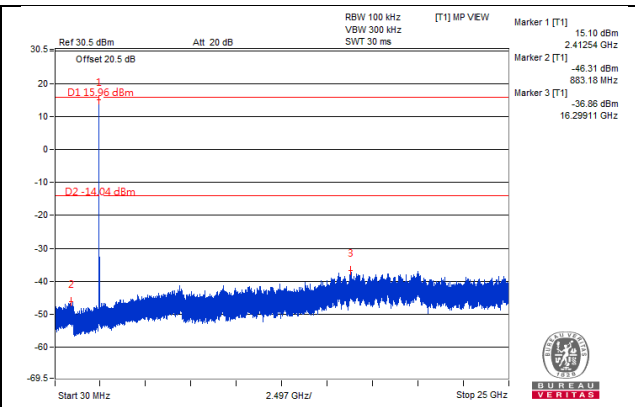
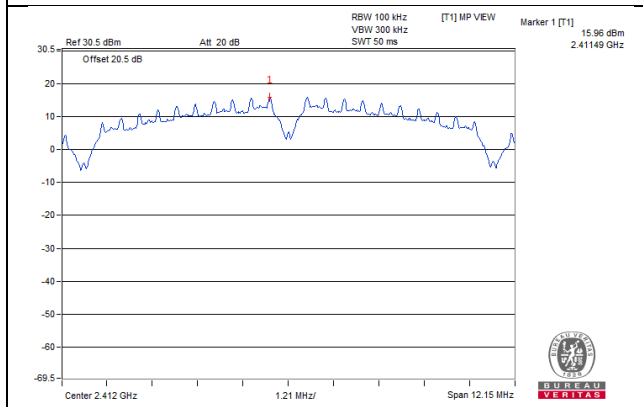

CH 6

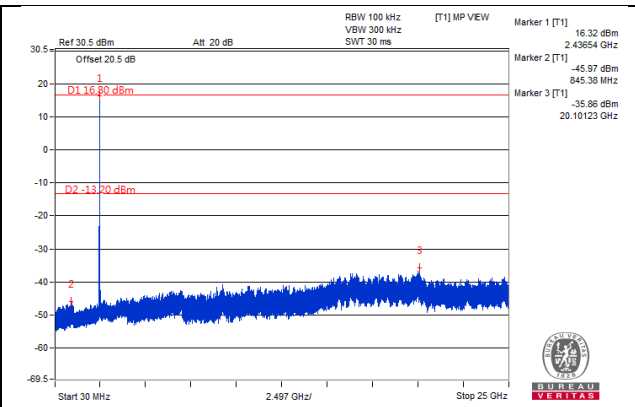
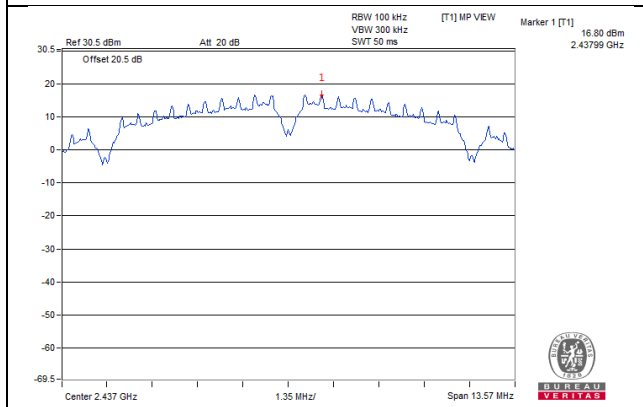

CH 11

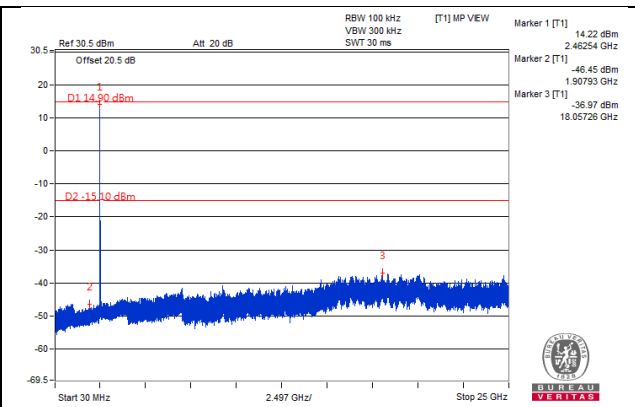
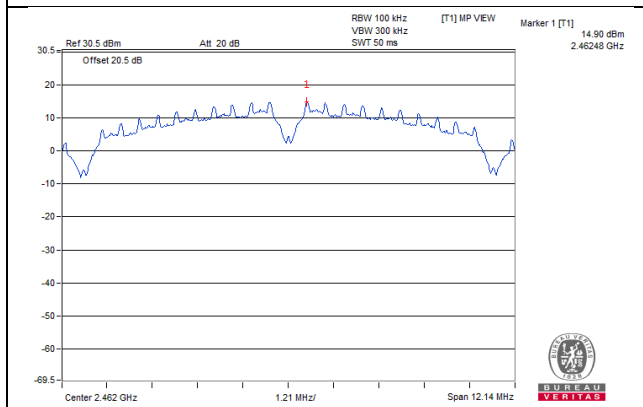

CH 1 Band edge

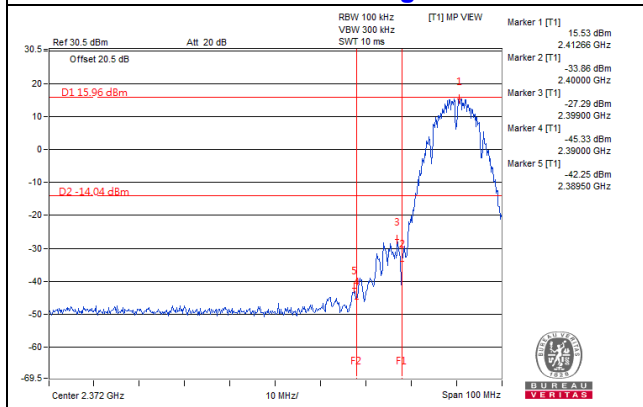

CH 11 Band edge

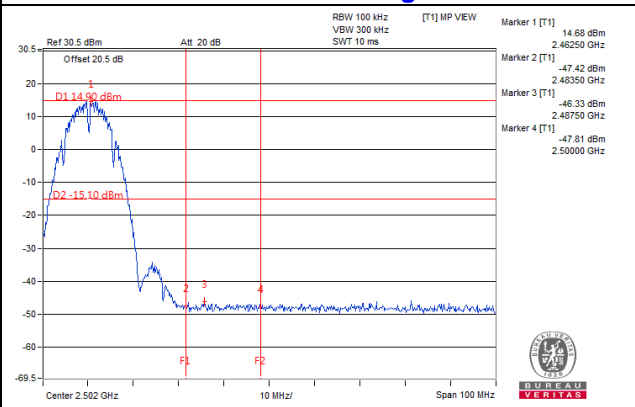

# 802.11g: CHAIN 0

## CH 1

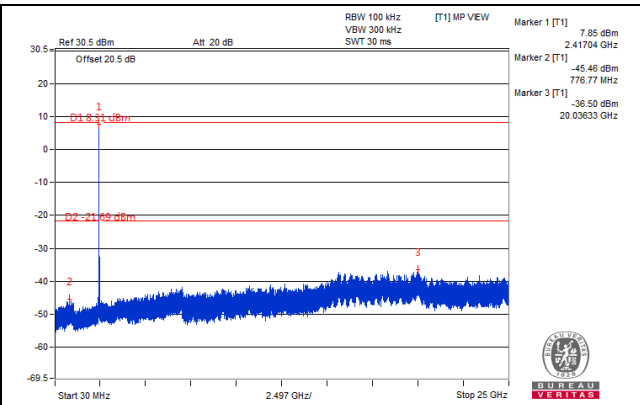
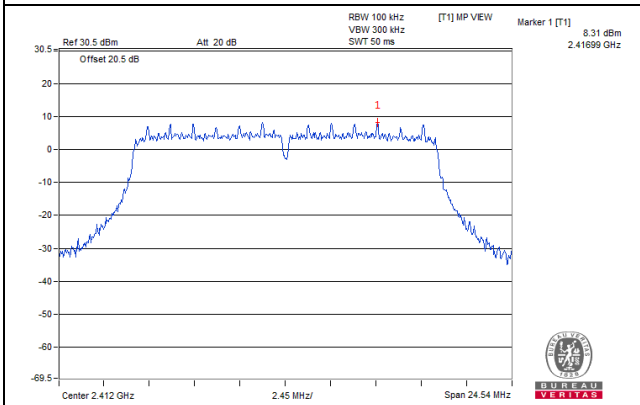

## CH 6

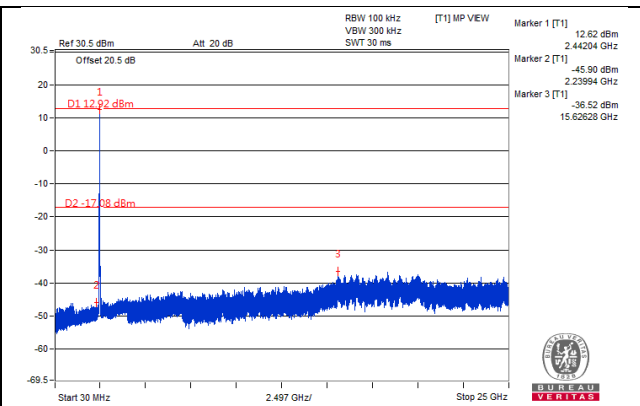
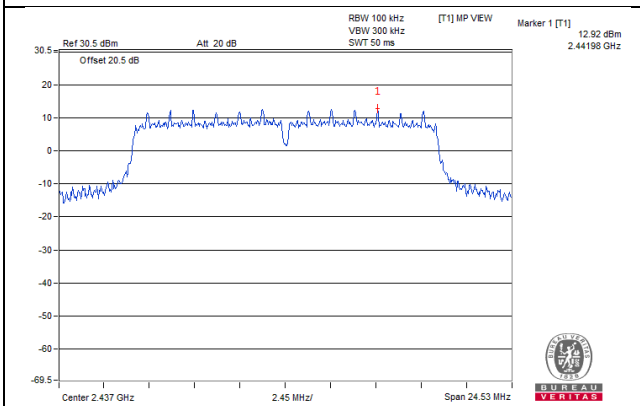

## CH 11

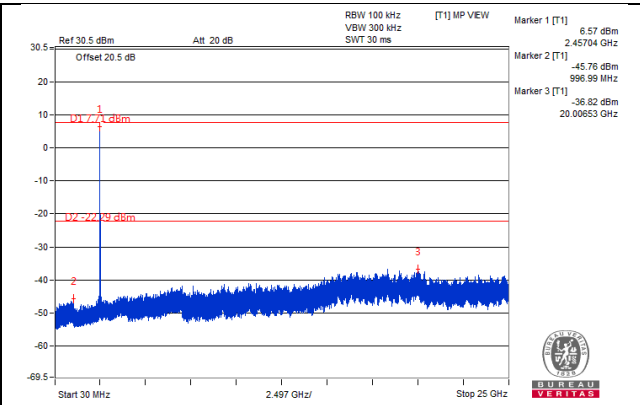
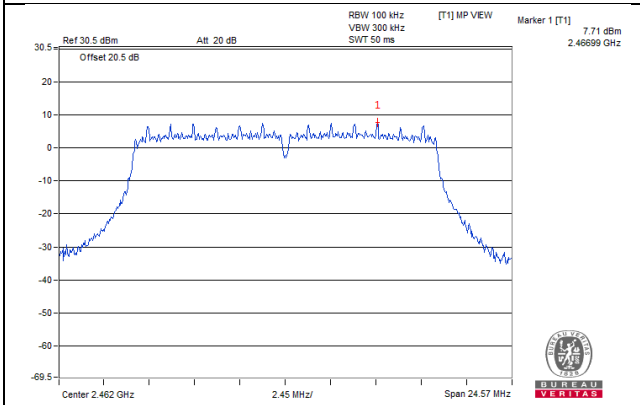

## CH 1 Band edge

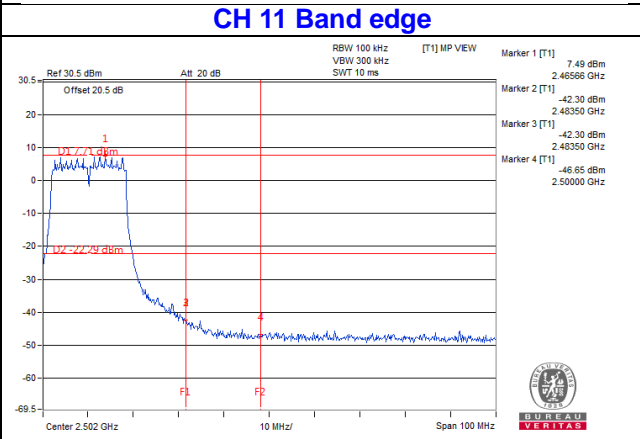
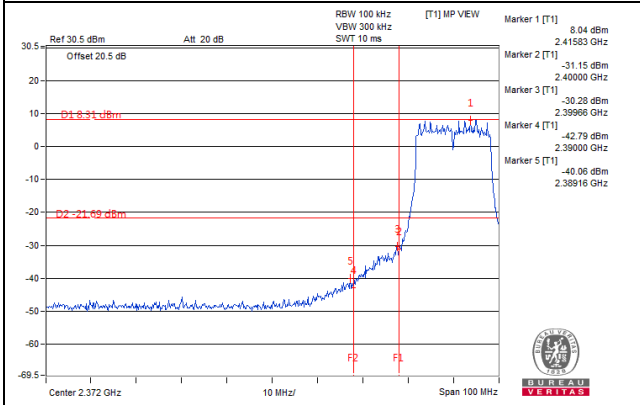

CHAIN 1

CH 1

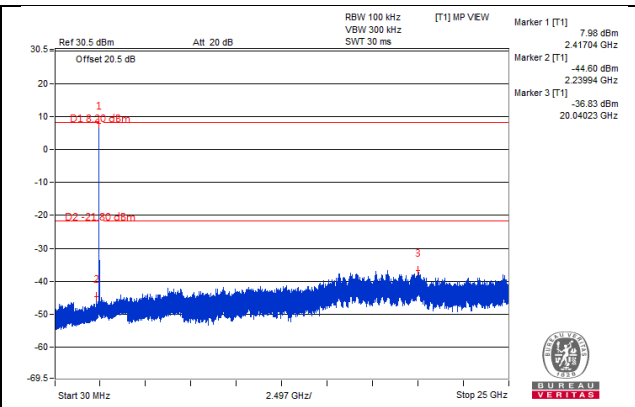
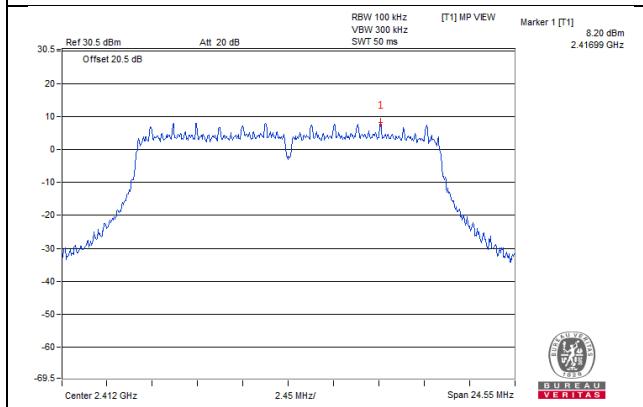

CH 6

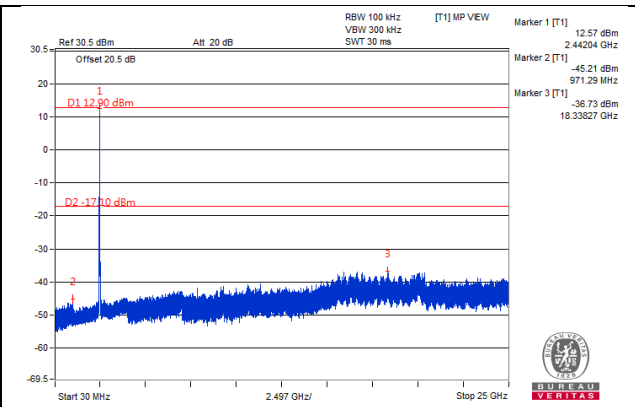
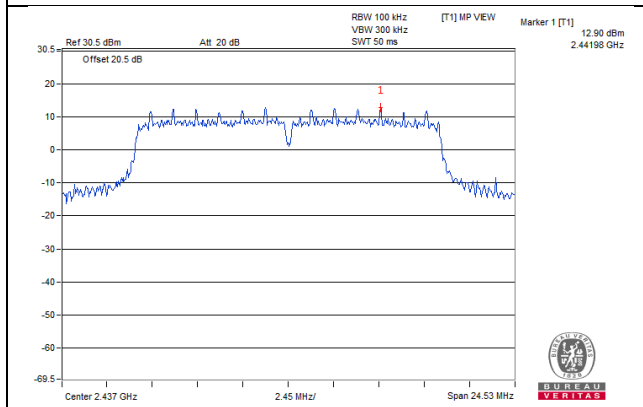

CH 11

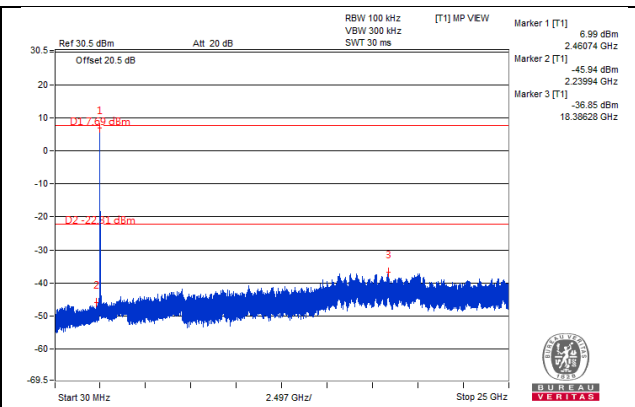
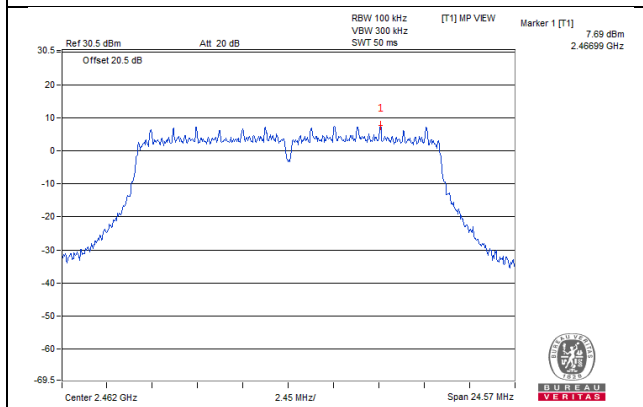

CH 1 Band edge

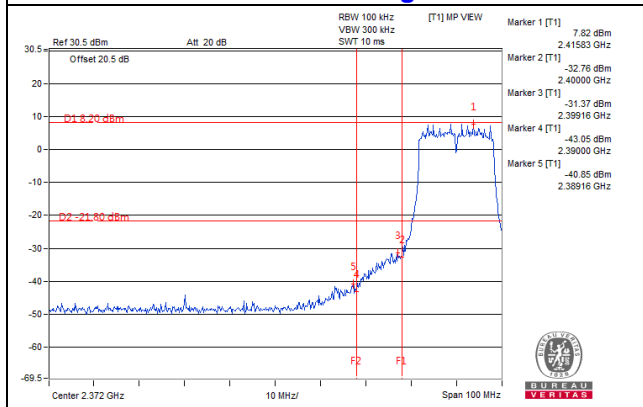

CH 11 Band edge

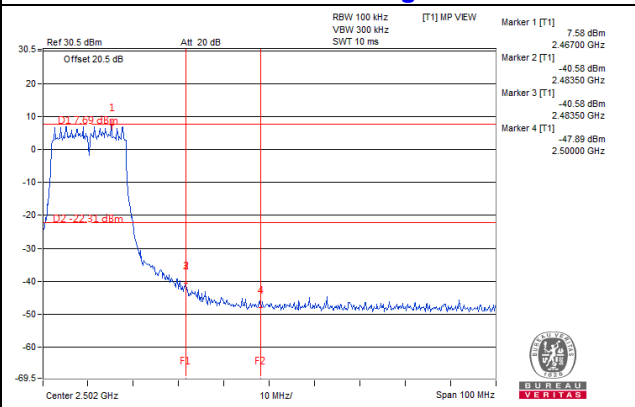

# Beamforming\_NSS1 MODE

## 802.11n (20MHz): CHAIN 0

### CH 1

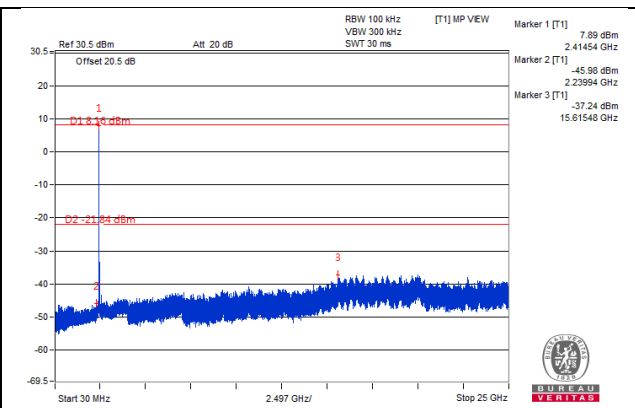
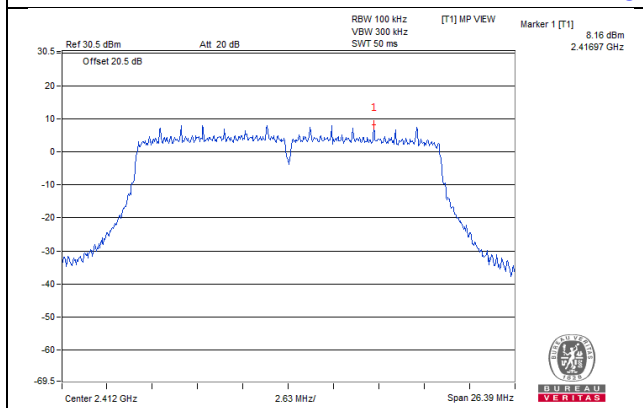

### CH 6

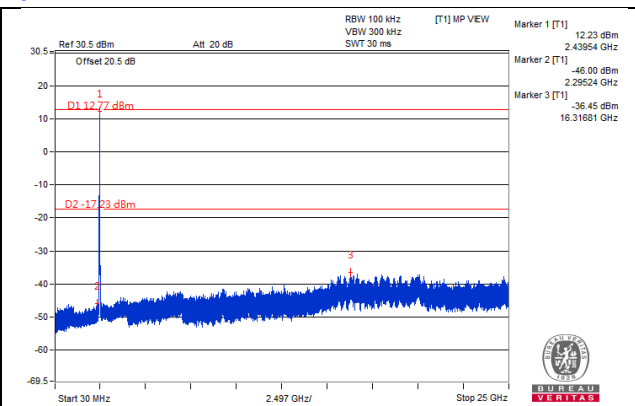
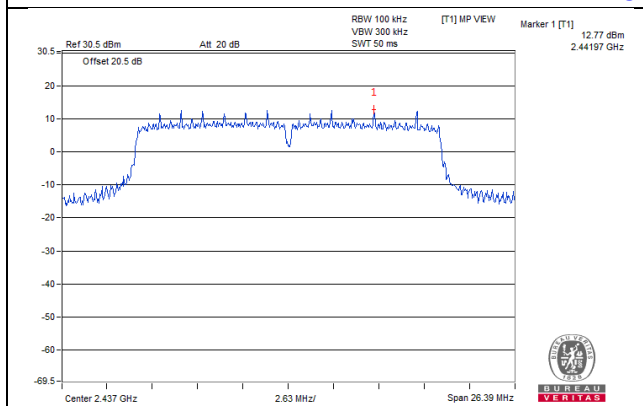

### CH 11

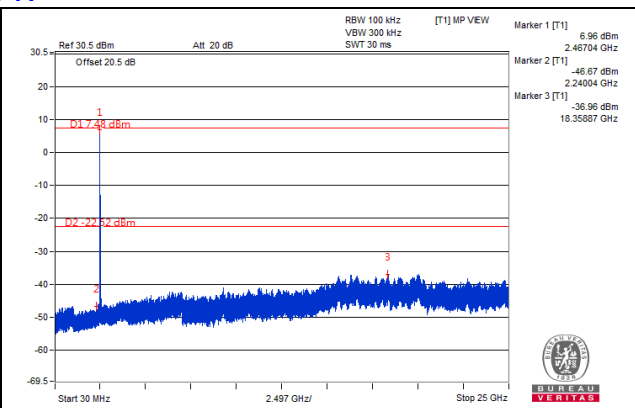
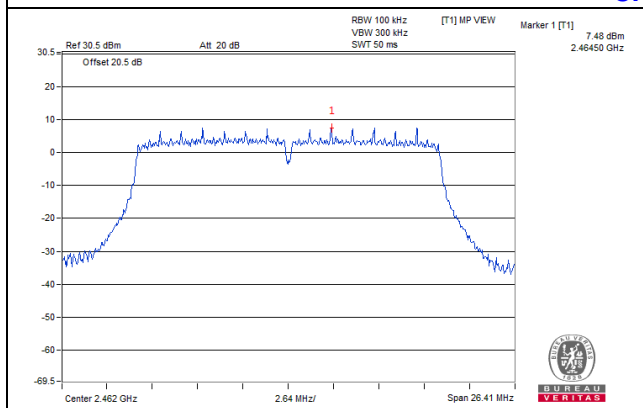

### CH 1 Band edge

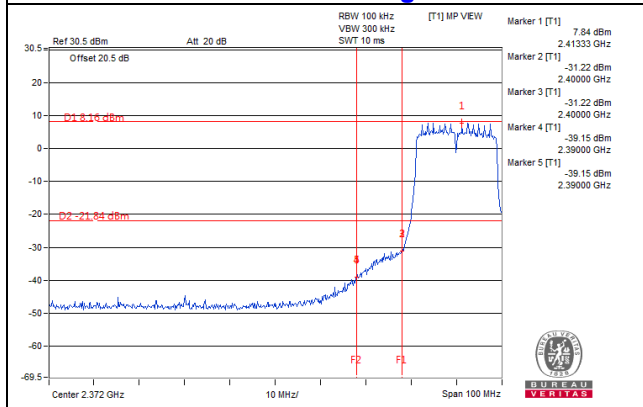

### CH 11 Band edge

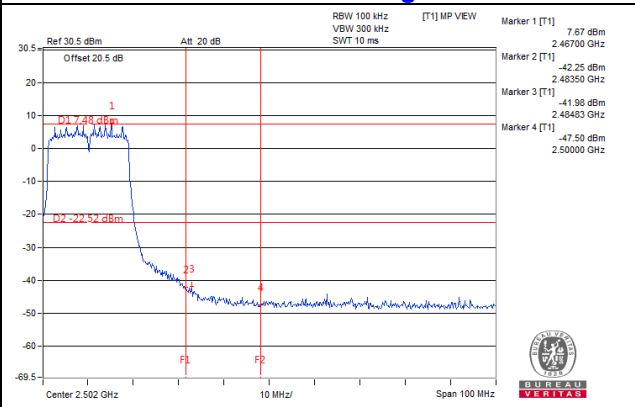

### CHAIN 1

#### CH 1

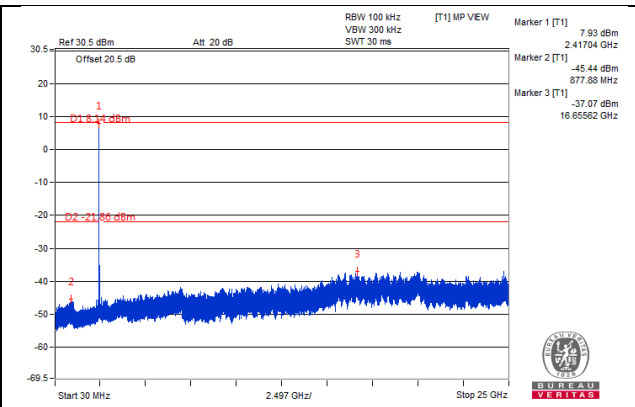
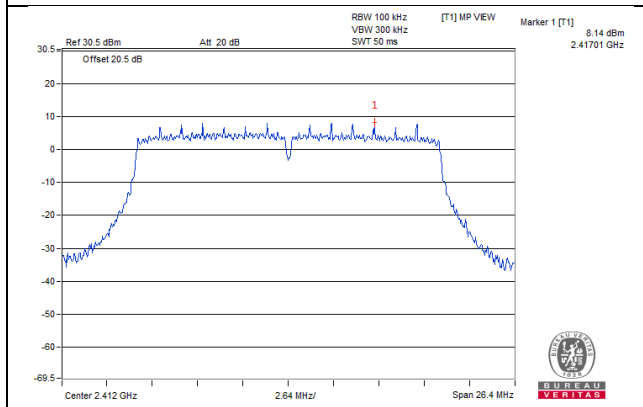

#### CH 6

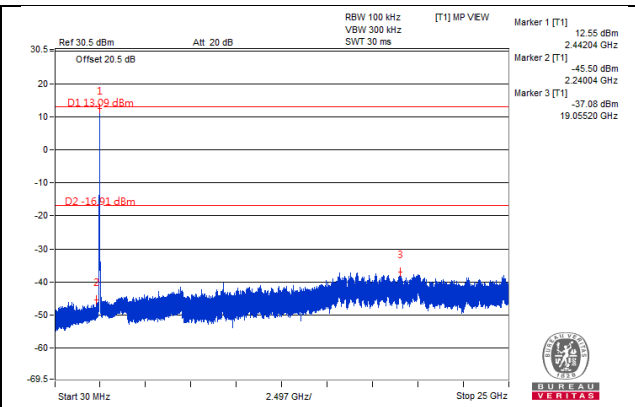
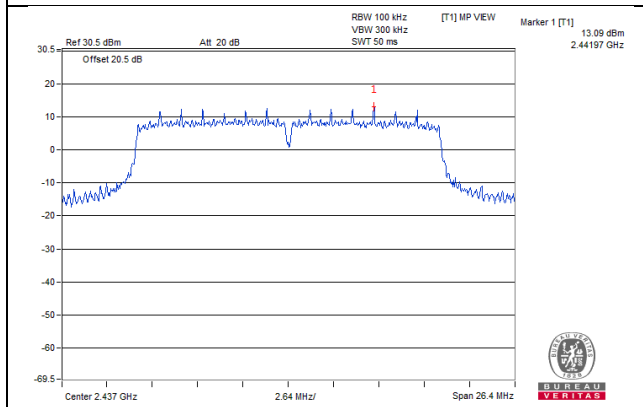

#### CH 11

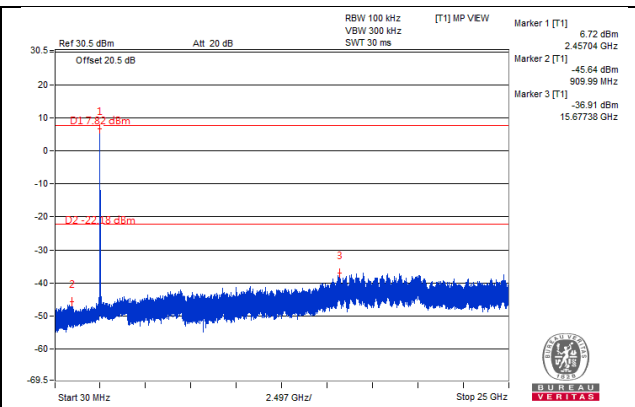
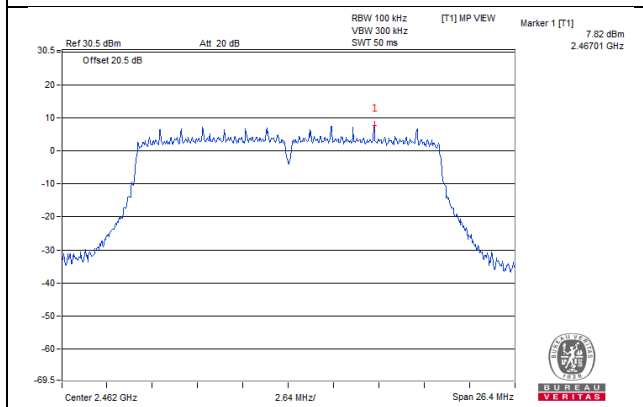

#### CH 1 Band edge

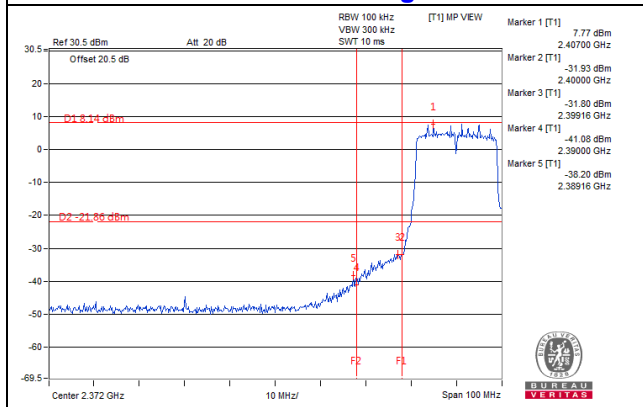

#### CH 11 Band edge

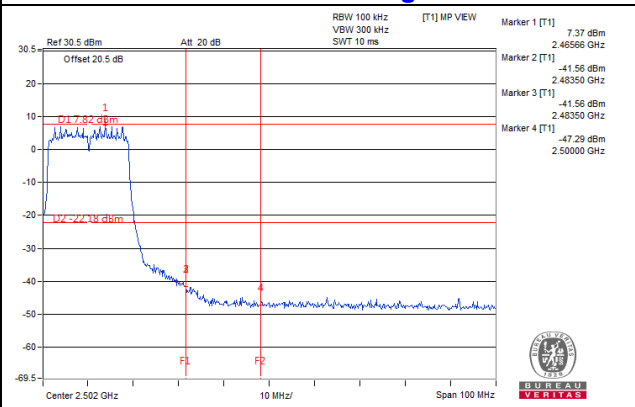

802.11n (40MHz): Chain 0

CH 3

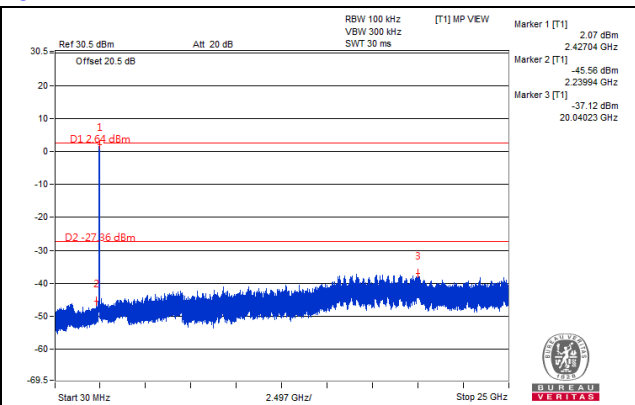
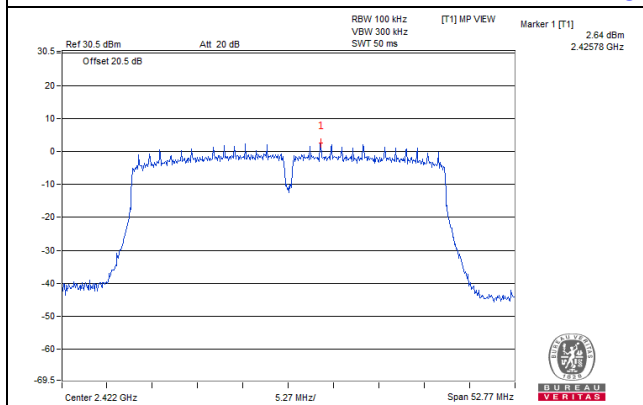

CH 6

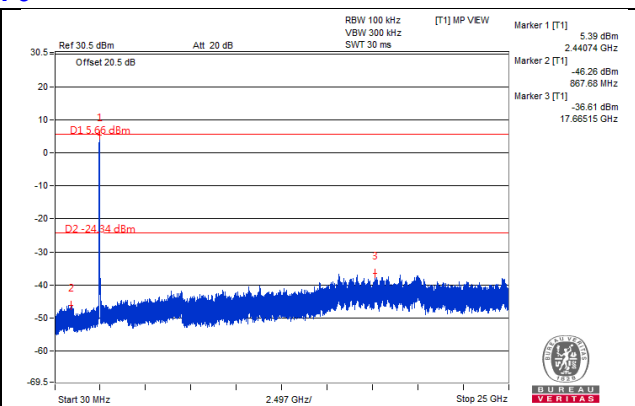
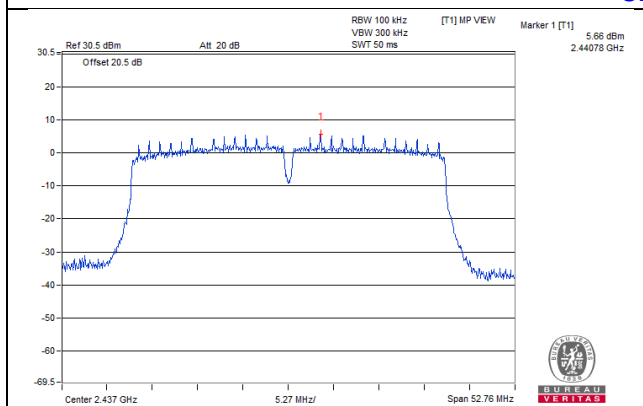

CH 9

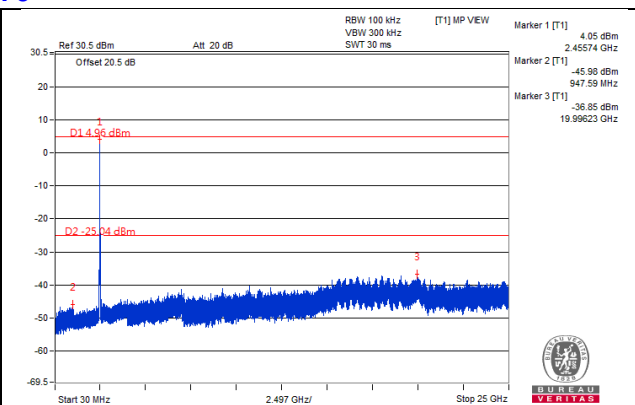
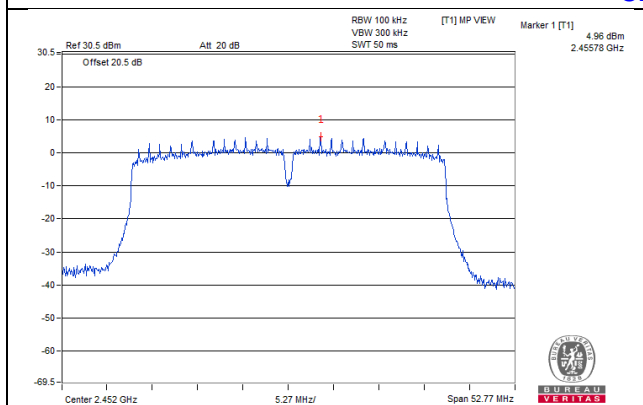

CH 3 Band edge

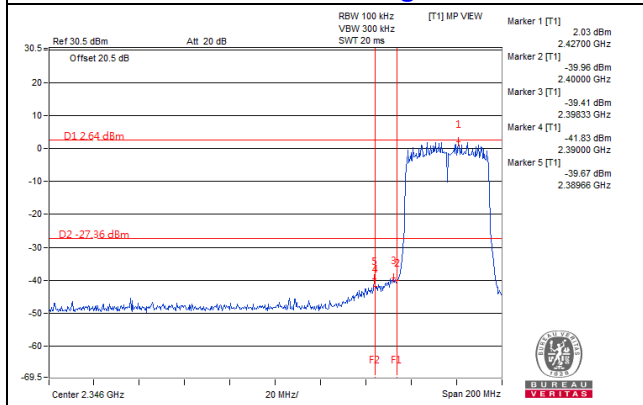

CH 9 Band edge

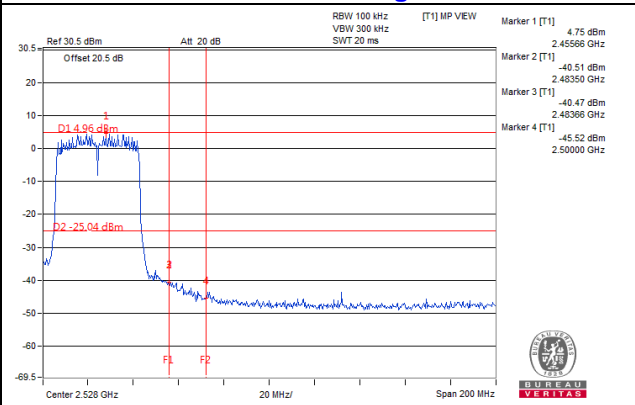

Chain 1

CH 3

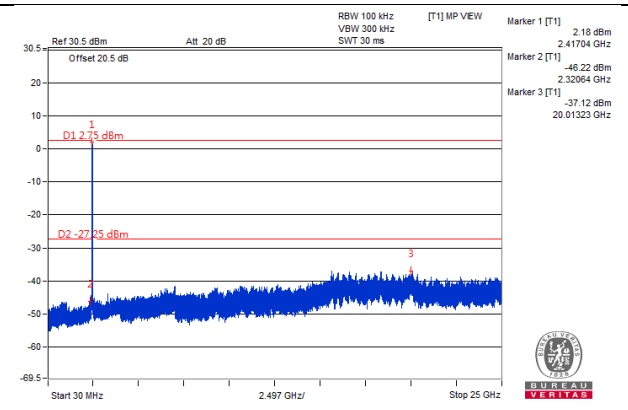
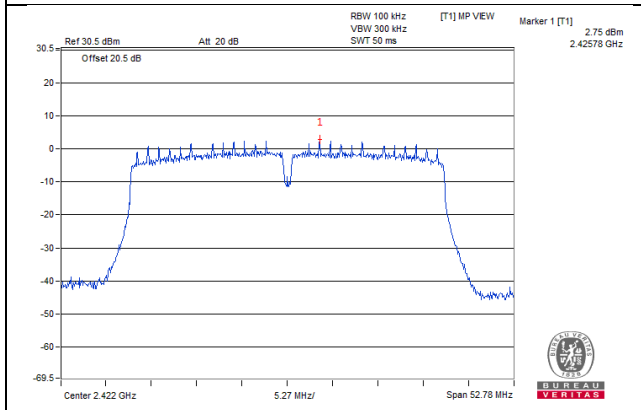

CH 6

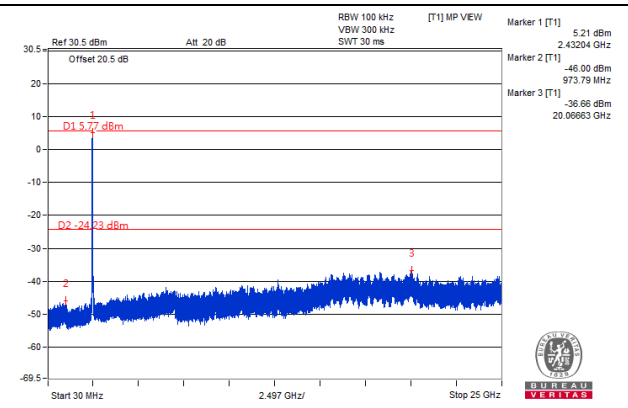
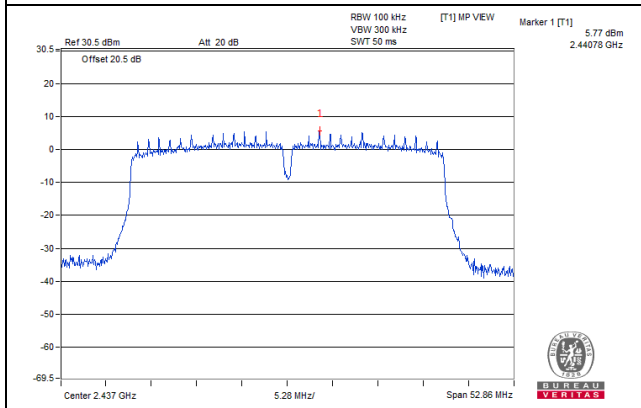

CH 9

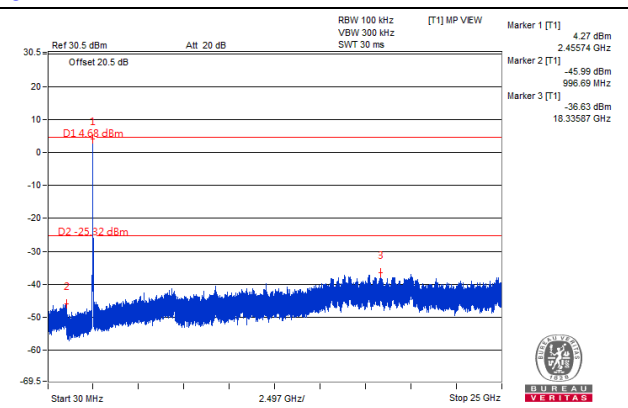
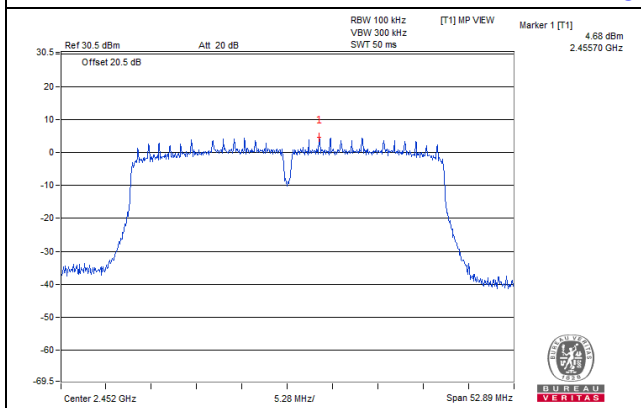

CH 3 Band edge

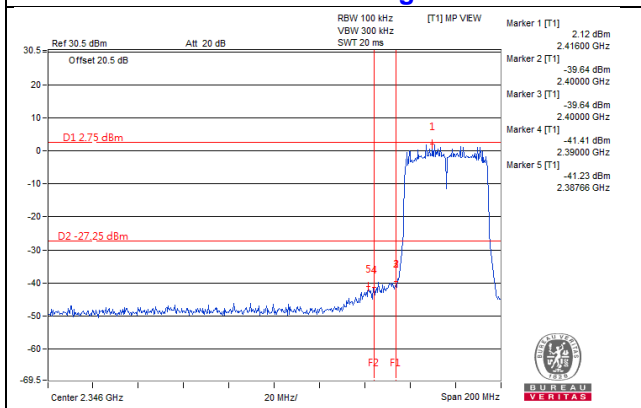

CH 9 Band edge

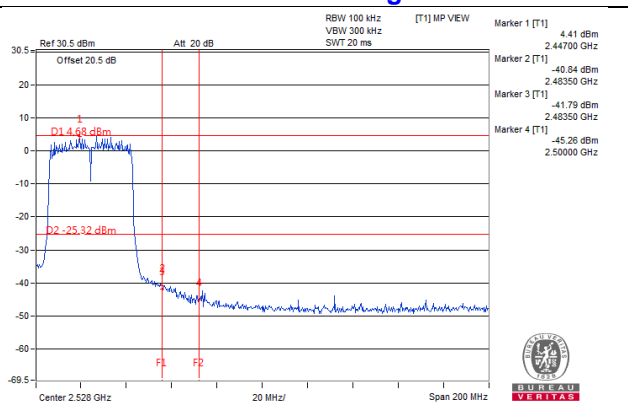

## 5 Pictures of Test Arrangements

Please refer to the attached file (Test Setup Photo).



## Appendix – Information on the Testing Laboratories

We, Bureau Veritas Consumer Products Services (H.K.) Ltd., Taoyuan Branch, were founded in 1988 to provide our best service in EMC, Radio, Telecom and Safety consultation. Our laboratories are accredited and approved according to ISO/IEC 17025.

If you have any comments, please feel free to contact us at the following:

**Linko EMC/RF Lab**

Tel: 886-2-26052180

Fax: 886-2-26051924

**Hsin Chu EMC/RF/Telecom Lab**

Tel: 886-3-6668565

Fax: 886-3-6668323

**Hwa Ya EMC/RF/Safety Lab**

Tel: 886-3-3183232

Fax: 886-3-3270892

**Email:** [service.adt@tw.bureauveritas.com](mailto:service.adt@tw.bureauveritas.com)

**Web Site:** [www.bureauveritas-adt.com](http://www.bureauveritas-adt.com)

The address and road map of all our labs can be found in our web site also.

--- END ---