



FCC 47 CFR PART 15 SUBPART C

TEST REPORT

For

Wireless Hotspot Gateway / Enterprise Access Point

Trade Name / Model:

Brand	Model	Product Description
4ipnet	EAP300	Enterprise Access Point
4ipnet	EAP305	Enterprise Access Point
4ipnet	EAP306	Enterprise Access Point
4ipnet	HSG300	Wireless Hotspot Gateway
Cipherium	A600	Enterprise Access Point
Cipherium	W1160	Wireless Hotspot Gateway
USC	A600	Enterprise Access Point
USC	W1160	Wireless Hotspot Gateway

Issued to

4IPNET, INC.  
3F-3, No. 369, Fusing N. Rd., Taipei 105,  
Taiwan, R.O.C.

Issued by

Compliance Certification Services Inc.  
No. 11, Wu-Gong 6<sup>th</sup> Rd., Wugu Industrial Park,  
Taipei Hsien 248, Taiwan (R.O.C.)  
<http://www.ccsrf.com>  
[service@ccsrf.com](mailto:service@ccsrf.com)



*Note: This report shall not be reproduced except in full, without the written approval of Compliance Certification Services Inc. This document may be altered or revised by Compliance Certification Services Inc. personnel only, and shall be noted in the revision section of the document.*



## **TABLE OF CONTENTS**

<b>1. TEST RESULT CERTIFICATION.....</b>	<b>3</b>
<b>2. EUT DESCRIPTION .....</b>	<b>4</b>
<b>3. TEST METHODOLOGY .....</b>	<b>5</b>
3.1 EUT CONFIGURATION .....	5
3.2 EUT EXERCISE.....	5
3.3 GENERAL TEST PROCEDURES.....	5
3.4 FCC PART 15.205 RESTRICTED BANDS OF OPERATIONS.....	6
3.5 DESCRIPTION OF TEST MODES .....	7
<b>4. INSTRUMENT CALIBRATION.....</b>	<b>8</b>
4.1 MEASURING INSTRUMENT CALIBRATION .....	8
4.2 MEASUREMENT EQUIPMENT USED .....	8
4.3 MEASUREMENT UNCERTAINTY .....	9
<b>5. FACILITIES AND ACCREDITATIONS .....</b>	<b>10</b>
5.1 FACILITIES .....	10
5.2 EQUIPMENT.....	10
5.3 TABLE OF ACCREDITATIONS AND LISTINGS.....	11
<b>6. SETUP OF EQUIPMENT UNDER TEST .....</b>	<b>12</b>
6.1 SETUP CONFIGURATION OF EUT.....	12
6.2 SUPPORT EQUIPMENT .....	12
<b>7. FCC PART 15.247 REQUIREMENTS.....</b>	<b>13</b>
7.1 6DB BANDWIDTH.....	13
7.2 PEAK POWER.....	25
7.3 AVERAGE POWER .....	27
7.4 BAND EDGES MEASUREMENT .....	29
7.5 PEAK POWER SPECTRAL DENSITY.....	31
7.6 SPURIOUS EMISSIONS.....	45
7.7 POWERLINE CONDUCTED EMISSIONS.....	72
<b>APPENDIX I RADIO FREQUENCY EXPOSURE .....</b>	<b>75</b>
<b>APPENDIX II PHOTOGRAPHS OF TEST SETUP .....</b>	<b>78</b>
<b>APPENDIX 1 - PHOTOGRAPHS OF EUT</b>	



# 1. TEST RESULT CERTIFICATION

**Applicant:** 4IPNET, INC.  
3F-3, No. 369, Fusing N. Rd., Taipei 105, Taiwan, R.O.C.

**Equipment Under Test:** Wireless Hotspot Gateway / Enterprise Access Point

**Trade Name / Model:**

Brand	Model	Product Description
4ipnet	EAP300	Enterprise Access Point
4ipnet	EAP305	Enterprise Access Point
4ipnet	EAP306	Enterprise Access Point
4ipnet	HSG300	Wireless Hotspot Gateway
Cipherium	A600	Enterprise Access Point
Cipherium	W1160	Wireless Hotspot Gateway
USC	A600	Enterprise Access Point
USC	W1160	Wireless Hotspot Gateway

**Date of Test:** January 24 ~ March 3, 2011

APPLICABLE STANDARDS	
STANDARD	TEST RESULT
FCC 47 CFR Part 15 Subpart C	No non-compliance noted

### We hereby certify that:

The above equipment was tested by Compliance Certification Services Inc. The test data, data evaluation, test procedures, and equipment configurations shown in this report were made in accordance with the procedures given in ANSI C63.4: 2003 and the energy emitted by the sample EUT tested as described in this report is in compliance with the requirements of FCC Rules Part 15.207, 15.209, 15.247.

The test results of this report relate only to the tested sample EUT identified in this report.

Approved by:

Reviewed by:

Rex Lai  
Section Manager  
Compliance Certification Services Inc.

Gina Lo  
Section Manager  
Compliance Certification Services Inc.



## 2. EUT DESCRIPTION

<b>Product</b>	Wireless Hotspot Gateway / Enterprise Access Point		
<b>Trade Name / Model Name</b>	<b>Brand</b>	<b>Model</b>	<b>Product Description</b>
	4ipnet	EAP300	Enterprise Access Point
	4ipnet	EAP305	Enterprise Access Point
	4ipnet	EAP306	Enterprise Access Point
	4ipnet	HSG300	Wireless Hotspot Gateway
	Cipherium	A600	Enterprise Access Point
	Cipherium	W1160	Wireless Hotspot Gateway
	USC	A600	Enterprise Access Point
USC	W1160	Wireless Hotspot Gateway	
<b>Model Difference</b>	All the specification and layout are identical except they come with different model numbers for marketing purposes.		
<b>Power Adapter</b>	APD / WA-24E12 I/P: 100-240V, 50-60Hz, 0.65A O/P: 12V, 2A		
<b>Frequency Range</b>	5.725~5.850 GHz		
<b>Transmit Power</b>	IEEE 802.11a mode: 23.97 dBm IEEE 802.11n HT 20 MHz mode: 25.12 dBm IEEE 802.11n HT 40 MHz mode: 25.24 dBm		
<b>Modulation Technique &amp; Transmit Data Rate</b>	IEEE 802.11a: OFDM (54, 48, 36, 24, 18, 12, 9, 6 Mbps) IEEE 802.11n HT 20 MHz mode: OFDM (6.50, 13.00, 19.50, 26.00, 39.00, 52.00, 58.50, 65.00, 78.00, 104.0, 117.0, 130.0, 156.0, 175.5, 195.0 Mbps) IEEE 802.11n HT 40 MHz mode: OFDM (13.50, 27.00, 40.50, 54.00, 81.00, 108.0, 121.5, 135.0, 162.0, 216.0, 243.0, 270.0, 324.0, 364.5, 405.0 Mbps)		
<b>Number of Channels</b>	IEEE 802.11a mode: 5 Channels IEEE 802.11n HT 20 MHz mode: 5 Channels IEEE 802.11n HT 40 MHz mode: 2 Channels		
<b>Antenna Specification</b>	Antenna Type: Omni Antenna Antenna Gain: 5 dBi		
	Antenna Calculation for MIMO Mode: $5 \text{ dBi} + 10 \log(3) = 9.7 \text{ dBi}$ (Numeric gain: 9.3)		

**Remark:**

1. The sample selected for test was production product and was provided by manufacturer.
2. This submittal(s) (test report) is intended for FCC ID: **VZ9110001** filing to comply with Section 15.207, 15.209 and 15.247 of the FCC Part 15, Subpart C Rules.



### **3. TEST METHODOLOGY**

The tests documented in this report were performed in accordance with ANSI C63.4 and FCC CFR 47 2.1046, 2.1047, 2.1049, 2.1051, 2.1053, 2.1055, 2.1057, 15.207, 15.209 and 15.247.

#### **3.1 EUT CONFIGURATION**

The EUT configuration for testing is installed on RF field strength measurement to meet the Commissions requirement and operating in a manner that intends to maximize its emission characteristics in a continuous normal application.

#### **3.2 EUT EXERCISE**

The EUT was operated in the engineering mode to fix the TX frequency that was for the purpose of the measurements.

According to its specifications, the EUT must comply with the requirements of the Section 15.207, 15.209 and 15.247 under the FCC Rules Part 15 Subpart C.

#### **3.3 GENERAL TEST PROCEDURES**

##### **Conducted Emissions**

The EUT is placed on the turntable, which is 0.8 m above ground plane. According to the requirements in Section 13.1.4.1 of ANSI C63.4 Conducted emissions from the EUT measured in the frequency range between 0.15 MHz and 30MHz using CISPR Quasi-peak and average detector modes.

##### **Radiated Emissions**

The EUT is placed on a turn table, which is 0.8 m above ground plane. The turntable shall rotate 360 degrees to determine the position of maximum emission level. EUT is set 3m away from the receiving antenna, which varied from 1m to 4m to find out the highest emission. And also, each emission was to be maximized by changing the polarization of receiving antenna both horizontal and vertical. In order to find out the maximum emissions, exploratory radiated emission measurements were made according to the requirements in Section 13.1.4.1 of ANSI C63.4.



### 3.4 FCC PART 15.205 RESTRICTED BANDS OF OPERATIONS

(a) Except as shown in paragraph (d) of this section, only spurious emissions are permitted in any of the frequency bands listed below:

MHz	MHz	MHz	GHz
0.090 - 0.110	16.42 - 16.423	399.9 - 410	4.5 - 5.15
<sup>1</sup> 0.495 - 0.505	16.69475 - 16.69525	608 - 614	5.35 - 5.46
2.1735 - 2.1905	16.80425 - 16.80475	960 - 1240	7.25 - 7.75
4.125 - 4.128	25.5 - 25.67	1300 - 1427	8.025 - 8.5
4.17725 - 4.17775	37.5 - 38.25	1435 - 1626.5	9.0 - 9.2
4.20725 - 4.20775	73 - 74.6	1645.5 - 1646.5	9.3 - 9.5
6.215 - 6.218	74.8 - 75.2	1660 - 1710	10.6 - 12.7
6.26775 - 6.26825	108 - 121.94	1718.8 - 1722.2	13.25 - 13.4
6.31175 - 6.31225	123 - 138	2200 - 2300	14.47 - 14.5
8.291 - 8.294	149.9 - 150.05	2310 - 2390	15.35 - 16.2
8.362 - 8.366	156.52475 - 156.52525	2483.5 - 2500	17.7 - 21.4
8.37625 - 8.38675	156.7 - 156.9	2655 - 2900	22.01 - 23.12
8.41425 - 8.41475	162.0125 - 167.17	3260 - 3267	23.6 - 24.0
12.29 - 12.293	167.72 - 173.2	3332 - 3339	31.2 - 31.8
12.51975 - 12.52025	240 - 285	3345.8 - 3358	36.43 - 36.5
12.57675 - 12.57725	322 - 335.4	3600 - 4400	( <sup>2</sup> )
13.36 - 13.41			

<sup>1</sup> Until February 1, 1999, this restricted band shall be 0.490-0.510 MHz.

<sup>2</sup> Above 38.6

(b) Except as provided in paragraphs (d) and (e), the field strength of emissions appearing within these frequency bands shall not exceed the limits shown in Section 15.209. At frequencies equal to or less than 1000 MHz, compliance with the limits in Section 15.209 shall be demonstrated using measurement instrumentation employing a CISPR quasi-peak detector. Above 1000 MHz, compliance with the emission limits in Section 15.209 shall be demonstrated based on the average value of the measured emissions. The provisions in Section 15.35 apply to these measurements.



### **3.5 DESCRIPTION OF TEST MODES**

The EUT (model: HSG300) had been tested under operating condition.

The EUT is a 3x3 configuration spatial MIMO (3Tx & 3Rx) without beam forming function that operate in triple TX chains and triple RX chains. The 3x3 configuration is implemented with three outside TX & RX chains (Chain 0, Chain 1 and Chain 2).

Software used to control the EUT for staying in continuous transmitting mode was programmed. The worst case data rate is determined as the data rate with highest output power.

After verification, all tests were carried out with the worst case test modes as shown below except radiated spurious emission below 1GHz and power line conducted emissions below 30MHz, which worst case was in normal link mode only.

**IEEE 802.11a mode:**

Channel Low (5745MHz), Channel Mid (5785MHz) and Channel High (5825MHz) with 6Mbps data rate and cyclic delay diversity were chosen for full testing.

**IEEE 802.11n HT 20 MHz mode:**

Channel Low(5745MHz), Channel Mid(5785MHz) and Channel High(5825MHz) with 6.5Mbps data rate were chosen for full testing.

**IEEE 802.11n HT 40 MHz mode:**

Channel Low(5755MHz) and Channel High(5795MHz) with 13.5Mbps data rate were chosen for full testing.



## 4. INSTRUMENT CALIBRATION

### 4.1 MEASURING INSTRUMENT CALIBRATION

The measuring equipment, which was utilized in performing the tests documented herein, has been calibrated in accordance with the manufacturer's recommendations for utilizing calibration equipment, which is traceable to recognized national standards.

### 4.2 MEASUREMENT EQUIPMENT USED

#### Equipment Used for Emissions Measurement

*Remark: Each piece of equipment is scheduled for calibration once a year and Loop Antenna is scheduled for calibration once three years.*

Conducted Emissions Test Site				
Name of Equipment	Manufacturer	Model	Serial Number	Calibration Due
Spectrum Analyzer	Agilent	E4446A	MY43360131	03/02/2012
Power Meter	Anritsu	ML2495A	1012009	03/28/2011
Power Sensor	Anritsu	MA2411B	0917072	03/08/2012

Wugu 966 Chamber A				
Name of Equipment	Manufacturer	Model	Serial Number	Calibration Due
Spectrum Analyzer	Agilent	E4446A	US42510252	11/03/2011
EMI Test Receiver	R&S	ESCI	100064	02/03/2012
Pre-Amplifier	Mini-Circuits	ZFL-1000LN	SF350700823	01/12/2012
Pre-Amplifier	MITEQ	AFS44-00102650-42-10P-44	1415367	11/19/2011
Bilog Antenna	Sunol Sciences	JB3	A030105	10/06/2011
Horn Antenna	EMCO	3117	00055165	01/12/2012
Loop Antenna	EMCO	6502	8905/2356	06/10/2013
Turn Table	CCS	CC-T-1F	N/A	N.C.R
Antenna Tower	CCS	CC-A-1F	N/A	N.C.R
Controller	CCS	CC-C-1F	N/A	N.C.R
Site NSA	CCS	N/A	N/A	12/26/2011
Test S/W	EZ-EMC (CCS-3A1RE)			

Conducted Emission room #1				
Name of Equipment	Manufacturer	Model	Serial Number	Calibration Due
L.I.S.N.	SCHWARZBECK	NNLK 8121	8121-308	MAR. 08, 2012
TEST RECEIVER	Rohde & Schwarz	ESCS 30	100348	JUL. 13, 2011
BNC COAXIAL CABLE	CCS	BNC50	11	OCT. 04, 2011
Test S/W	e-3 (5.04211c) R&S (2.27)			





### 4.3 MEASUREMENT UNCERTAINTY

PARAMETER	UNCERTAINTY
Powerline Conducted Emission	+/- 2.01
3M Semi Anechoic Chamber / 30M~200M	+/- 4.0606
3M Semi Anechoic Chamber / 200M~1000M	+/- 3.9979
3M Semi Anechoic Chamber / 1G~8G	+/- 2.5790
3M Semi Anechoic Chamber / 8G~18G	+/- 2.5928
3M Semi Anechoic Chamber / 18G~26G	+/- 2.7212
3M Semi Anechoic Chamber / 26G~40G	+/- 2.9520

**Remark:** This uncertainty represents an expanded uncertainty expressed at approximately the 95% confidence level using a coverage factor of  $k=2$ .



## 5. FACILITIES AND ACCREDITATIONS

### 5.1 FACILITIES

All measurement facilities used to collect the measurement data are located at

- No.199, Chunghsen Road, Hsintien City, Taipei Hsien, Taiwan, R.O.C.  
Tel: 886-2-2217-0894 / Fax: 886-2-2217-1029
- No.11, Wugong 6th Rd., Wugu Industrial Park, Taipei Hsien 248, Taiwan  
Tel: 886-2-2299-9720 / Fax: 886-2-2298-4045
- No.81-1, Lane 210, Bade 2nd Rd., Luchu Hsiang, Taoyuan Hsien 338, Taiwan  
Tel: 886-3-324-0332 / Fax: 886-3-324-5235
- No. 8, Jiu Ceng Ling, Jiaokeng Village, Sinhua Township, Tainan Hsien 712, Taiwan (R.O.C.)  
Tel: 886-6-580-2201 / Fax: 886-6-580-2202

*Remark: The powerline emissions test items was tested at Compliance Certification Services Inc. (Sinhua u Lab.)  
The test equipments were listed in page 8 and the test data, please refer page 73-74.*

The sites are constructed in conformance with the requirements of ANSI C63.7, ANSI C63.4 and CISPR Publication 22.

### 5.2 EQUIPMENT

Radiated emissions are measured with one or more of the following types of linearly polarized antennas: tuned dipole, biconical, log periodic, bi-log, and/or ridged waveguide, horn. Spectrum analyzers with pre-selectors and quasi-peak detectors are used to perform radiated measurements.



Conducted emissions are measured with Line Impedance Stabilization Networks and EMI Test Receivers.

Calibrated wideband preamplifiers, coaxial cables, and coaxial attenuators are also used for making measurements.

All receiving equipment conforms to CISPR Publication 16-1, "Radio Interference Measuring Apparatus and Measurement Methods."



### 5.3 TABLE OF ACCREDITATIONS AND LISTINGS

Country	Agency	Scope of Accreditation	Logo
USA	FCC	3M Semi Anechoic Chamber (FCC MRA: TW1039) to perform FCC Part 15 measurements	 FCC MRA: TW1039
Taiwan	TAF	LP0002, RTTE01, FCC Method-47 CFR Part 15 Subpart C, D, E, RSS-210, RSS-310 IDA TS SRD, AS/NZS 4268, AS/NZS 4771, TS 12.1 & 12.2, ETSI EN 300 440-1, ETSI EN 300 440-2, ETSI EN 300 328, ETSI EN 300 220-1, ETSI EN 300 220-2, ETSI EN 301 893, ETSI EN 301 489-1/3/7/17 FCC OET Bulletin 65 + Supplement C, EN 50360, EN 50361, EN 50371, RSS 102, EN 50383, EN 50385, EN 50392, IEC 62209, CNS 14958-1, CNS 14959 FCC Method -47 CFR Part 15 Subpart B IEC / EN 61000-3-2, IEC / EN 61000-3-3, IEC / EN 61000-4-2/3/4/5/6/8/11	 Testing Laboratory 1309
Canada	Industry Canada	3M Semi Anechoic Chamber (IC 2324G-1 / IC 2324G-2) to perform	 IC 2324G-1 IC 2324G-2

\* No part of this report may be used to claim or imply product endorsement by A2LA or any agency of the US Government.



## 6. SETUP OF EQUIPMENT UNDER TEST

### 6.1 SETUP CONFIGURATION OF EUT

See test photographs attached in Appendix 1 for the actual connections between EUT and support equipment.

### 6.2 SUPPORT EQUIPMENT

#### Wugu Lab.

No.	Device Type	Brand	Model	Series No.	FCC ID	Data Cable	Power Cord
1.	Notebook PC	DELL	PP19L	GK102 A00	QDS-BRCM1021	LAN Cable: Unshielded, 10m	AC I/P: Unshielded, 1.8m DC O/P: Unshielded, 1.8m with a core
2.	USB Dongle	Transcend	JF V85	N/A	N/A	N/A	N/A

#### Tainan Lab.

No.	Product	Manufacturer	Model No.	Certify No.	Signal cable
1	Note Book	IBM	R51	R33026	Power cable, unshd, 1.6m
2	Note Book	IBM	T43	DoC	Power cable, unshd, 1.6m
3	Flash Disk	Kingston	DTI/512	DoC	N/A
4	HUB	BARRICAD	SMC7008BR	DoC	Power cable, unshd, 1.6m

#### Remark:

1. All the equipment/cables were placed in the worst-case configuration to maximize the emission during the test.
2. Grounding was established in accordance with the manufacturer's requirements and conditions for the intended use.



## 7. FCC PART 15.247 REQUIREMENTS

### 7.1 6dB BANDWIDTH

#### LIMIT

According to §15.247(a)(2), systems using digital modulation techniques may operate in the 902 - 928 MHz, 2400 - 2483.5 MHz, and 5725 - 5850 MHz bands. The minimum 6dB bandwidth shall be at least 500 kHz.

#### Test Configuration

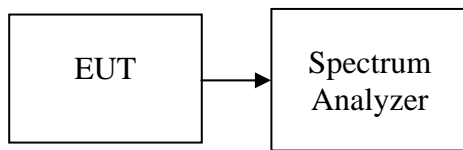

#### TEST PROCEDURE

1. Place the EUT on the table and set it in the transmitting mode.
2. Remove the antenna from the EUT and then connect a low loss RF cable from the antenna port to the spectrum analyzer.
3. Set the spectrum analyzer as RBW = 100kHz, VBW = RBW, Span = 50MHz, Sweep = auto.
4. Mark the peak frequency and -6dB (upper and lower) frequency.
5. Repeat until all the rest channels are investigated.

#### TEST RESULTS

*No non-compliance noted*



**Test Data**

**Test mode: IEEE 802.11a mode**

Channel	Frequency (MHz)	6dB Bandwidth (MHz)	Limit (kHz)	Result
Low	5745	16.42	>500	PASS
Mid	5785	16.33		PASS
High	5825	16.25		PASS

**Test mode: IEEE 802.11n HT 20 MHz Channel mode / Chain 0**

Channel	Frequency (MHz)	6dB Bandwidth (MHz)	Limit (kHz)	Result
Low	5745	17.67	>500	PASS
Mid	5785	17.67		PASS
High	5825	17.75		PASS

**Test mode: IEEE 802.11n HT 20 MHz Channel mode / Chain 1**

Channel	Frequency (MHz)	6dB Bandwidth (MHz)	Limit (kHz)	Result
Low	5745	17.50	>500	PASS
Mid	5785	17.75		PASS
High	5825	17.67		PASS

**Test mode: IEEE 802.11n HT 20 MHz Channel mode / Chain 2**

Channel	Frequency (MHz)	6dB Bandwidth (MHz)	Limit (kHz)	Result
Low	5745	17.67	>500	PASS
Mid	5785	17.75		PASS
High	5825	17.50		PASS

**Test mode: IEEE 802.11n HT 40 MHz mode / Chain 0**

Channel	Frequency (MHz)	6dB Bandwidth (MHz)	Limit (kHz)	Result
Low	5755	36.42	>500	PASS
High	5795	36.42		PASS

**Test mode: IEEE 802.11n HT 40 MHz mode / Chain 1**

Channel	Frequency (MHz)	6dB Bandwidth (MHz)	Limit (kHz)	Result
Low	5755	36.33	>500	PASS
High	5795	36.50		PASS

**Test mode: IEEE 802.11n HT 40 MHz mode / Chain 2**

Channel	Frequency (MHz)	6dB Bandwidth (MHz)	Limit (kHz)	Result
Low	5755	36.50	>500	PASS
High	5795	36.42		PASS



### Test Plot

#### IEEE 802.11a mode 6dB Bandwidth (CH Low)

Agilent 14:33:19 Mar 2, 2011

R L

Δ Mkr1 16.42 MHz  
0.64 dB

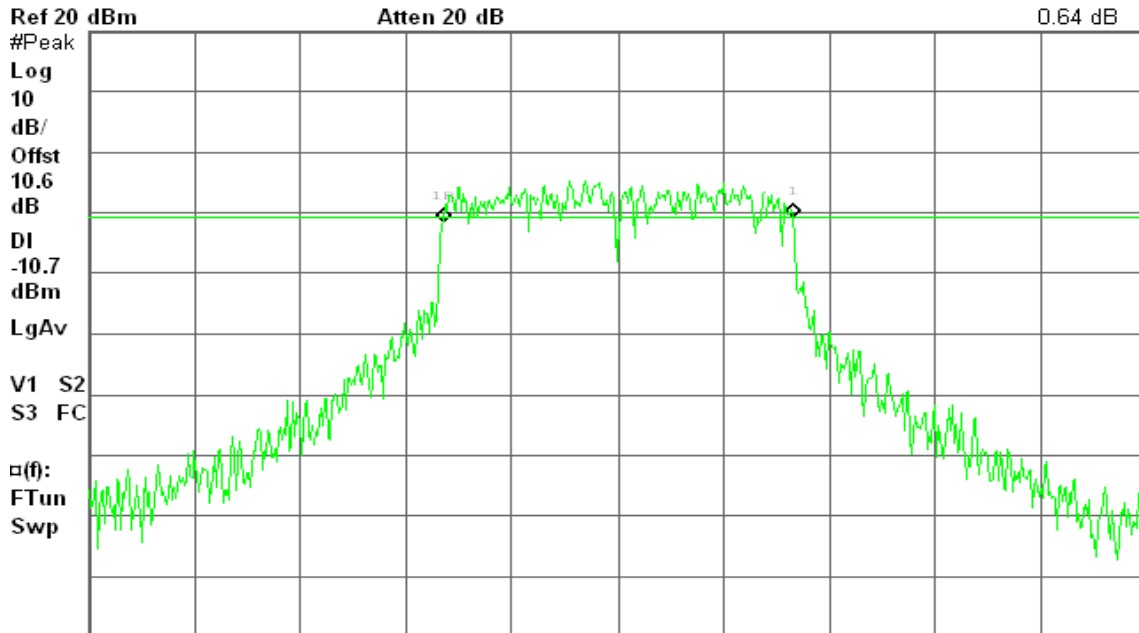

Center 5.745 00 GHz

#Res BW 100 kHz

#VBW 100 kHz

Span 50 MHz  
Sweep 6.04 ms (601 pts)

#### 6dB Bandwidth (CH Mid)

Agilent 14:41:04 Mar 2, 2011

R T

Δ Mkr1 16.33 MHz  
0.36 dB

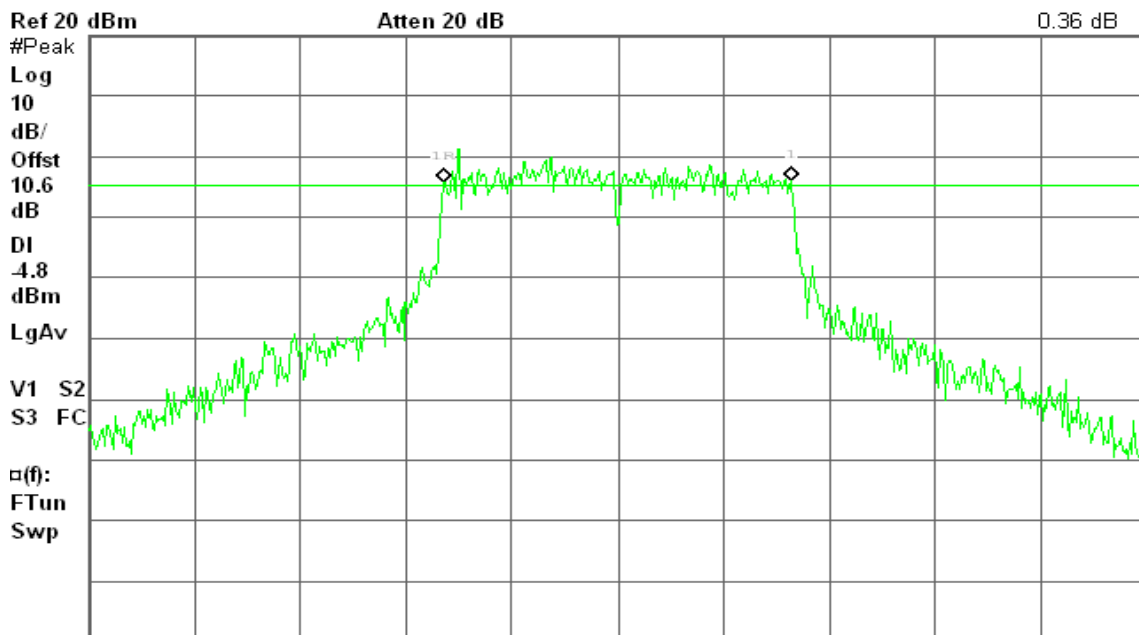

Center 5.785 00 GHz

#Res BW 100 kHz

#VBW 100 kHz

Span 50 MHz  
Sweep 6.04 ms (601 pts)



### 6dB Bandwidth (CH High)

Agilent 14:45:43 Mar 2, 2011

R T

Δ Mkr1 16.25 MHz  
-2.94 dB

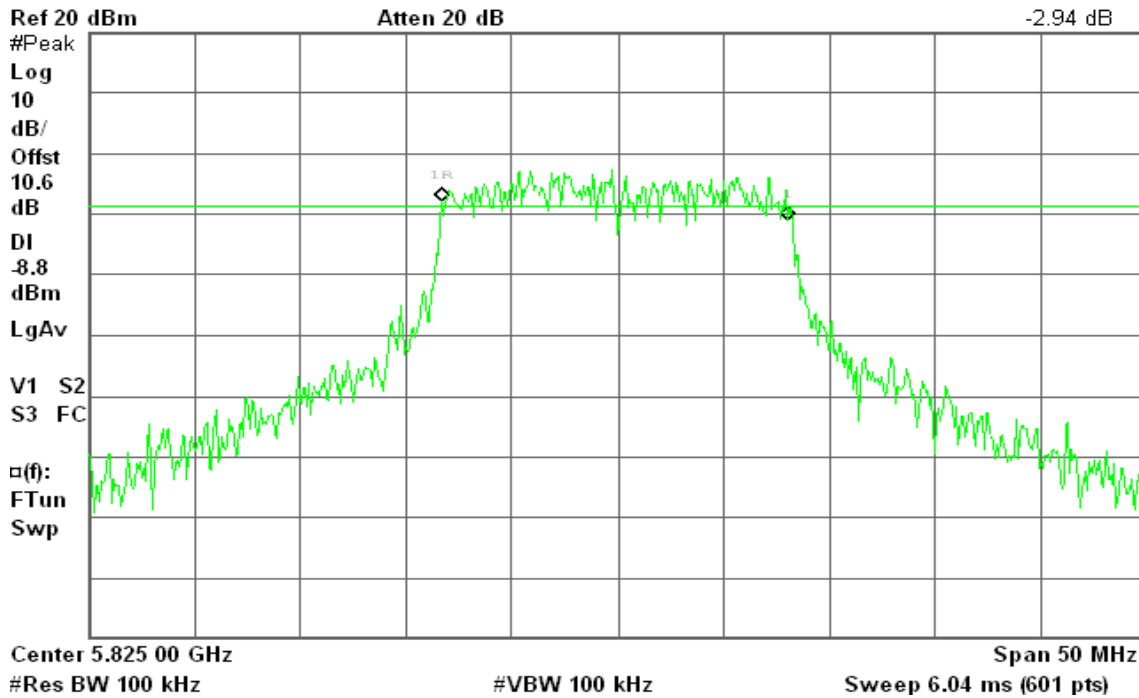

### IEEE 802.11n HT 20 MHz Channel mode / Chain 0

### 6dB Bandwidth (CH Low)

Agilent 15:10:35 Mar 2, 2011

R T

Δ Mkr1 17.67 MHz  
0.31 dB

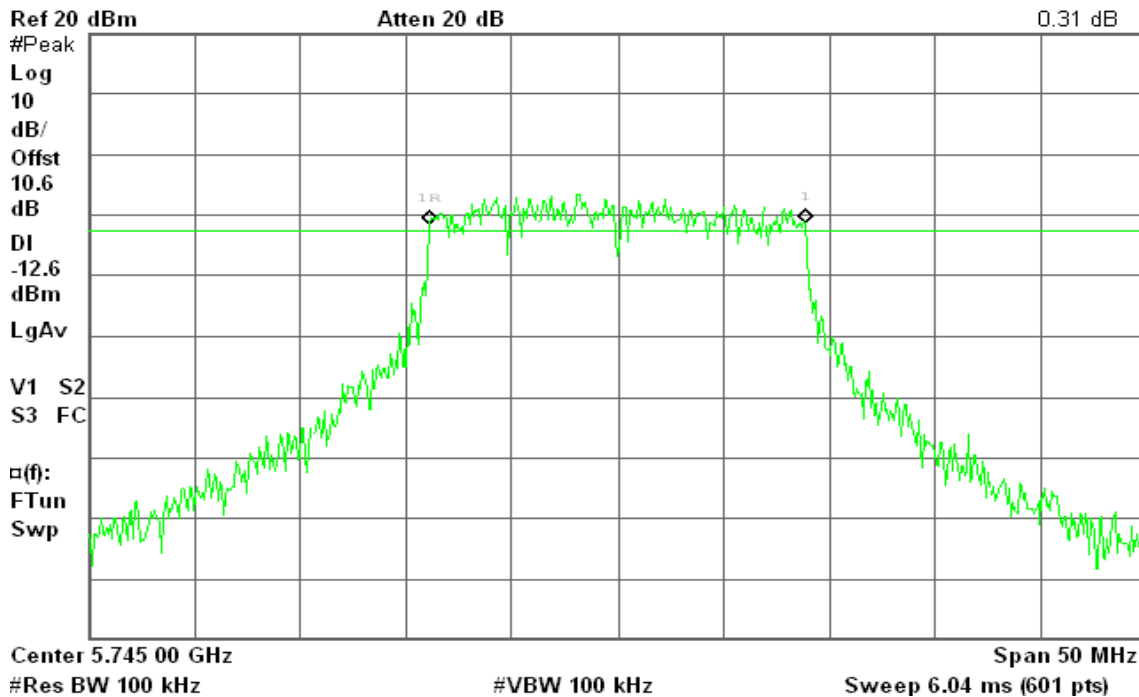





### 6dB Bandwidth (CH Mid)

Agilent 14:59:26 Mar 2, 2011

R T

Δ Mkr1 17.67 MHz  
-2.00 dB

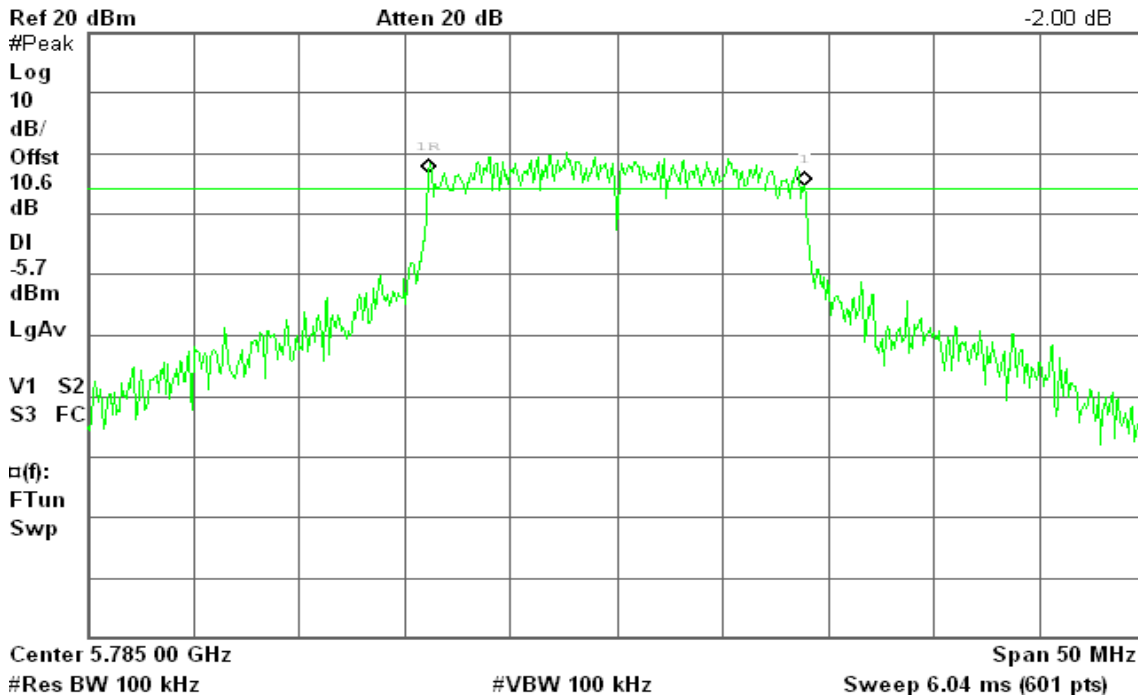

### 6dB Bandwidth (CH High)

Agilent 14:52:54 Mar 2, 2011

R T

Δ Mkr1 17.75 MHz  
-0.54 dB

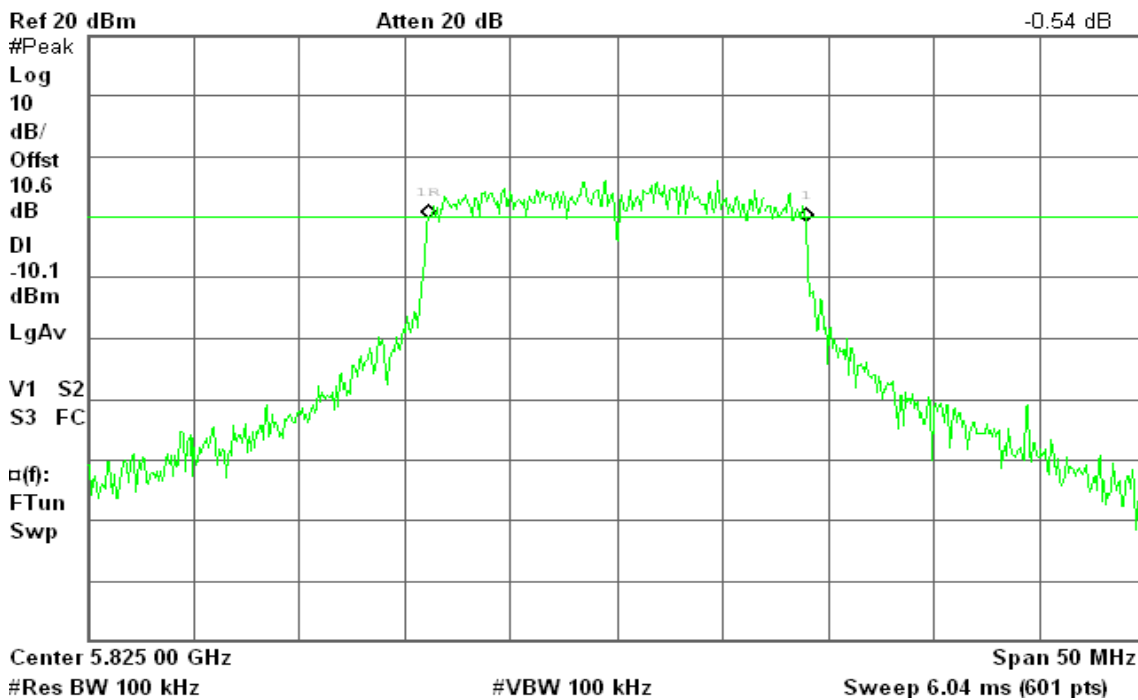



### IEEE 802.11n HT 20 MHz Channel mode / Chain 1

#### 6dB Bandwidth (CH Low)

Agilent 20:42:01 Mar 2, 2011

R T

Δ Mkr1 17.50 MHz  
0.00 dB

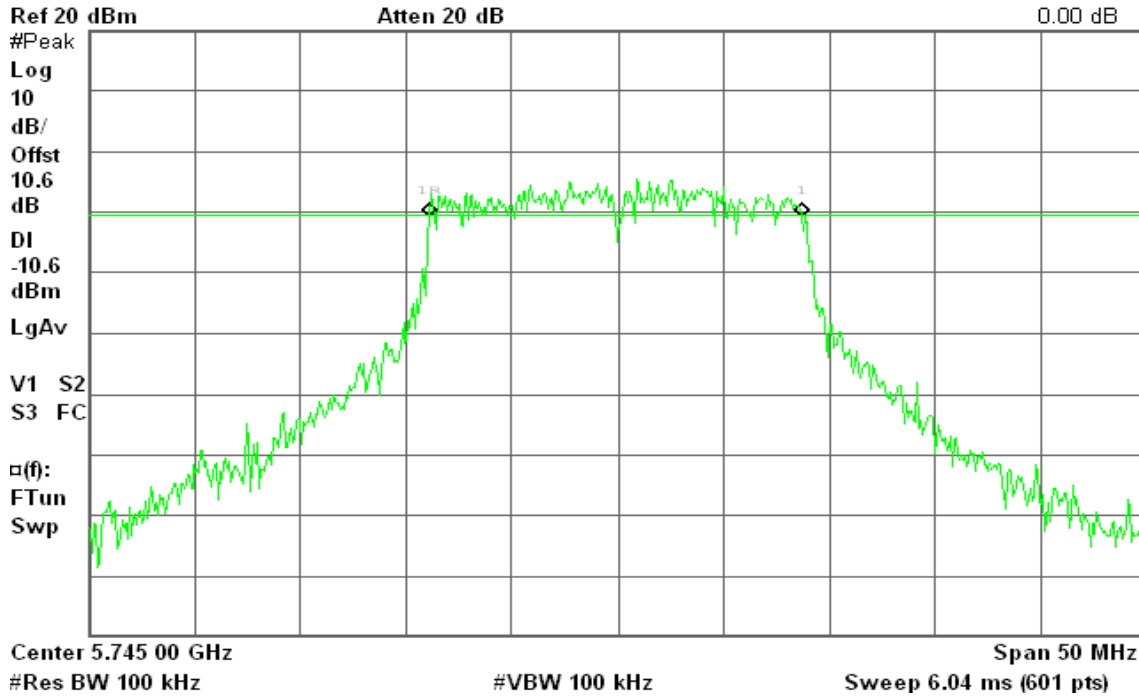

#### 6dB Bandwidth (CH Mid)

Agilent 20:46:36 Mar 2, 2011

R T

Δ Mkr1 17.75 MHz  
-3.16 dB

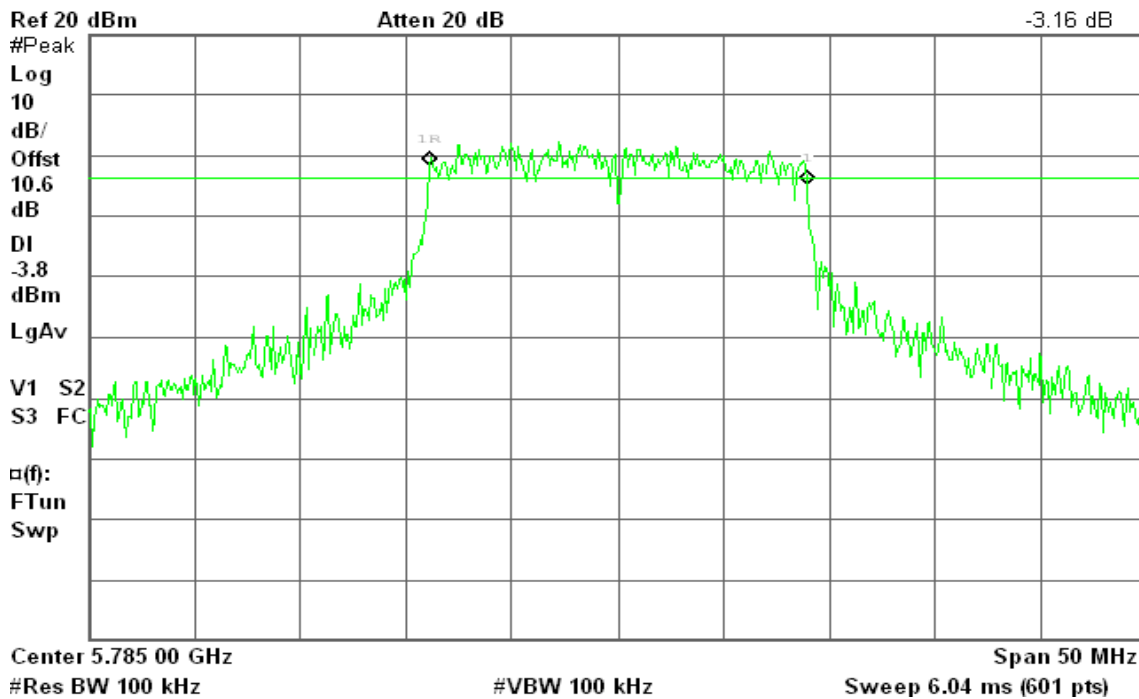



### 6dB Bandwidth (CH High)

Agilent 20:58:00 Mar 2, 2011

R T

Δ Mkr1 17.67 MHz

1.29 dB

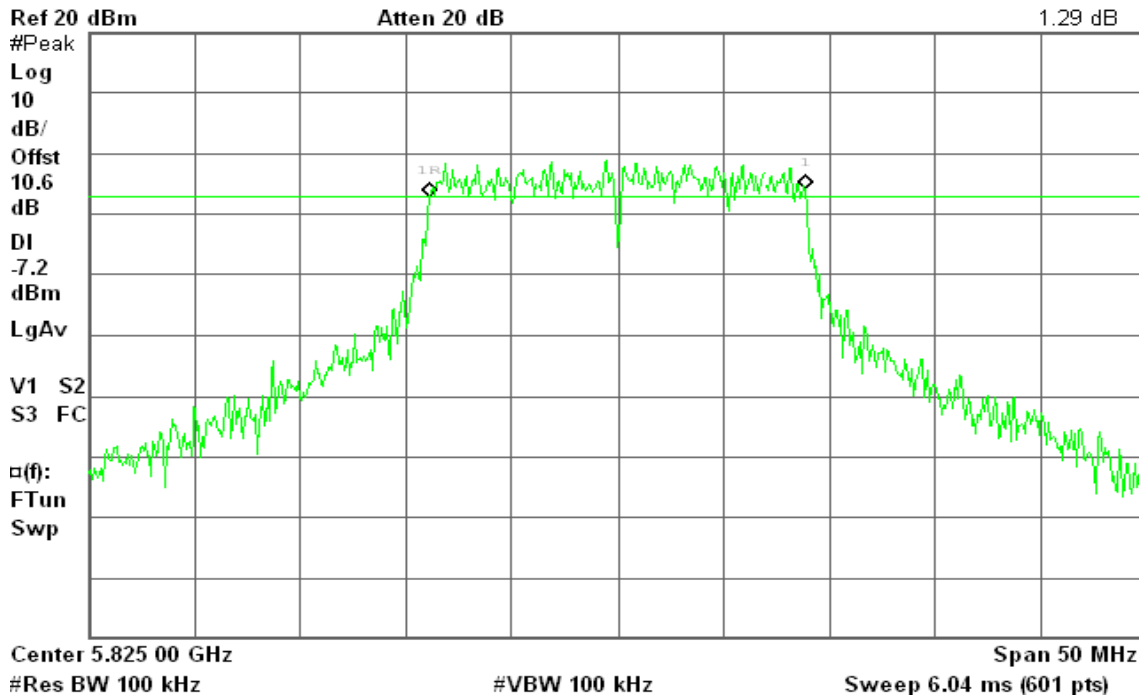



### IEEE 802.11n HT 20 MHz Channel mode / Chain 2

#### 6dB Bandwidth (CH Low)

Agilent 20:37:47 Mar 2, 2011

R T

Δ Mkr1 17.67 MHz  
1.63 dB

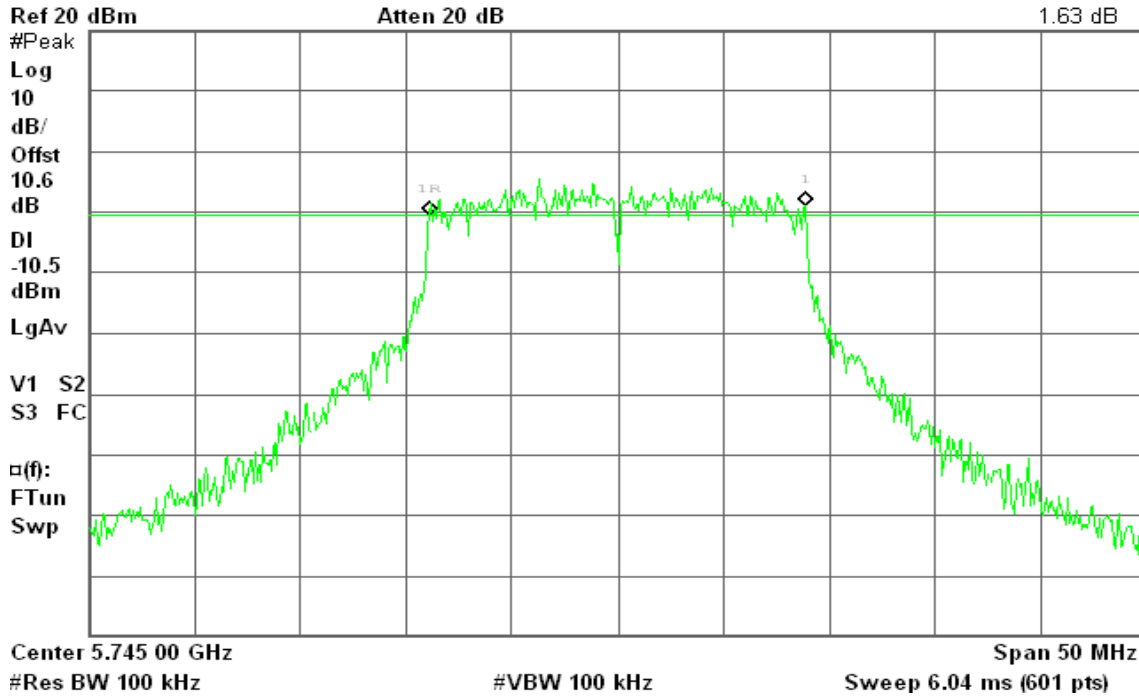

#### 6dB Bandwidth (CH Mid)

Agilent 20:50:14 Mar 2, 2011

R T

Δ Mkr1 17.75 MHz  
-1.41 dB

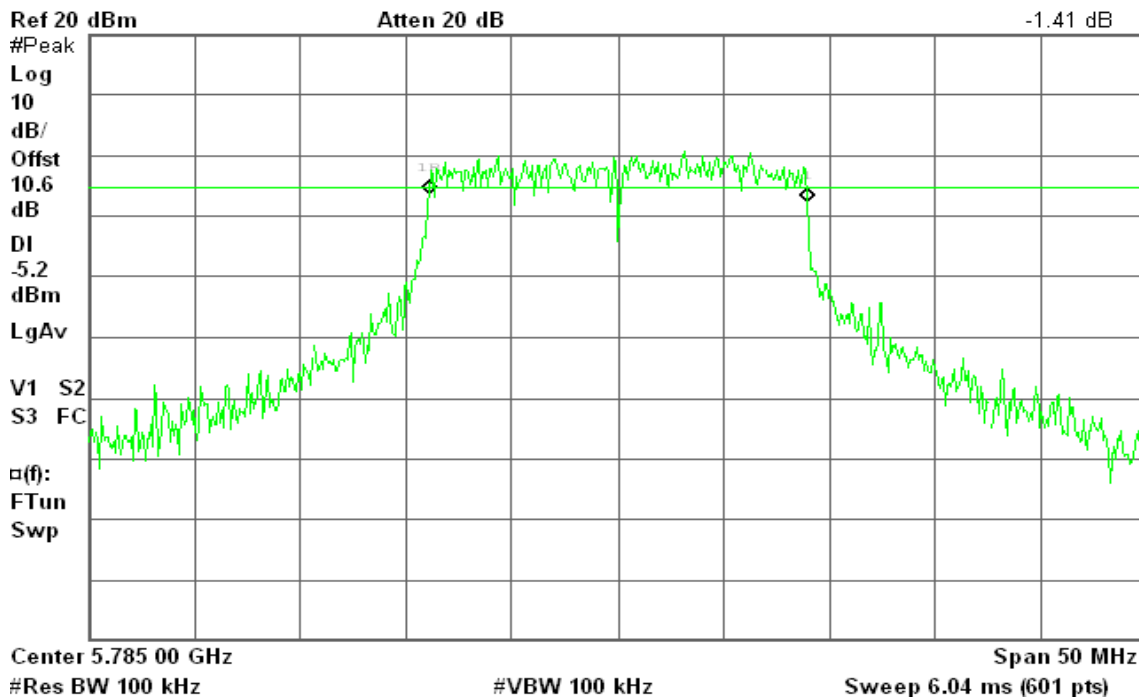



### 6dB Bandwidth (CH High)

Agilent 20:54:25 Mar 2, 2011

R T

Δ Mkr1 17.50 MHz  
-1.55 dB

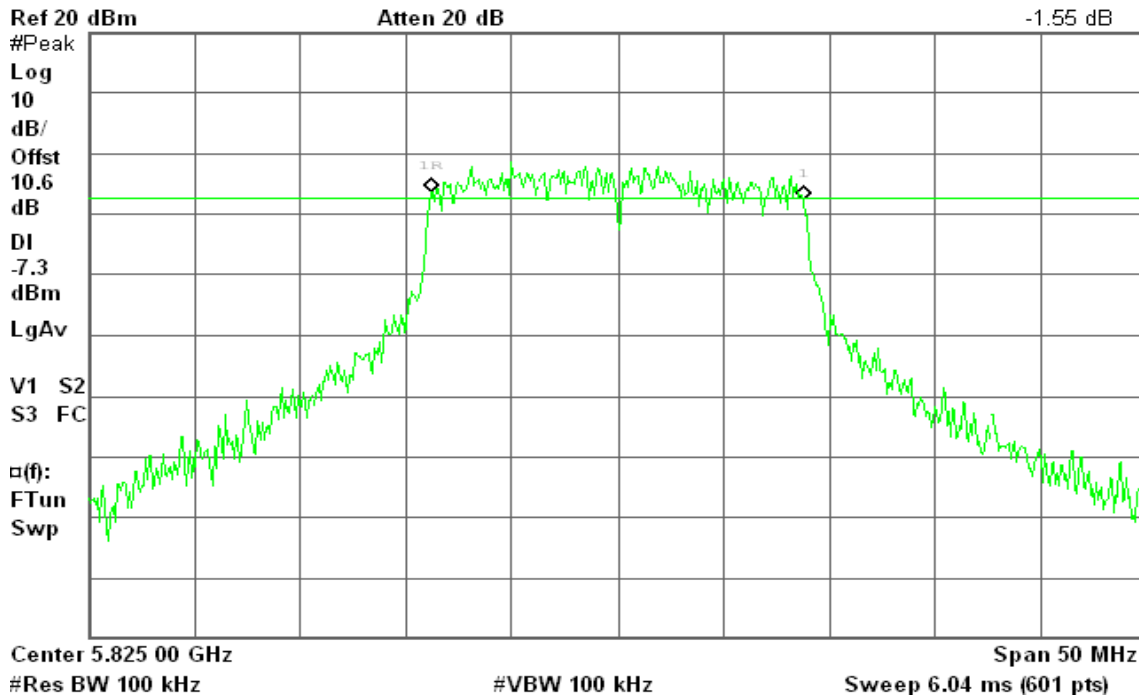



### IEEE 802.11n HT 40 MHz mode / Chain 0

#### 6dB Bandwidth (CH Low)

Agilent 21:04:48 Mar 2, 2011

R T

Δ Mkr1 36.42 MHz  
-1.26 dB

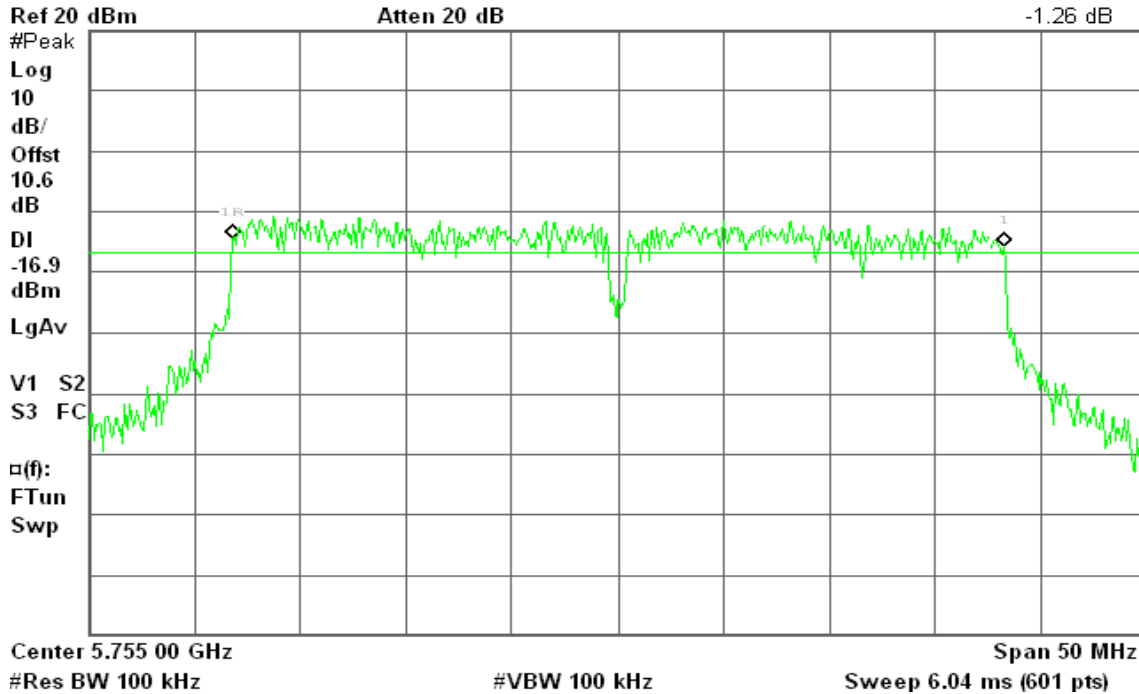

#### 6dB Bandwidth (CH High)

Agilent 22:24:46 Mar 2, 2011

R T

Δ Mkr1 36.42 MHz  
-0.44 dB

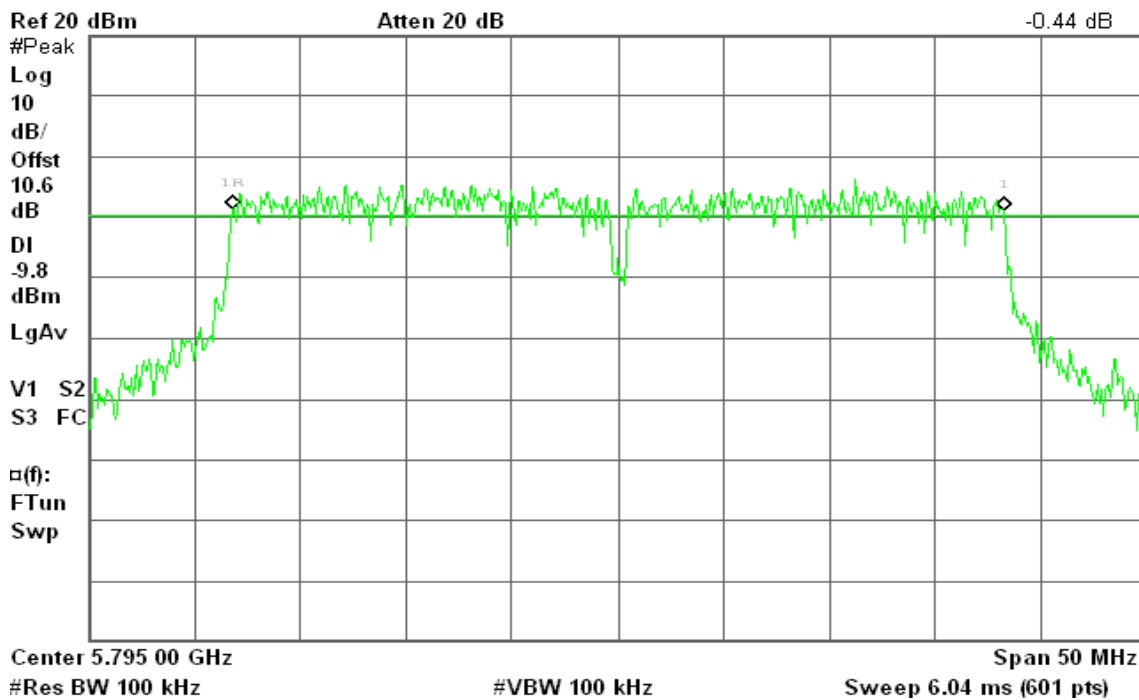



### IEEE 802.11n HT 40 MHz mode / Chain 1

#### 6dB Bandwidth (CH Low)

Agilent 21:08:26 Mar 2, 2011

R T

Δ Mkr1 36.33 MHz  
0.83 dB

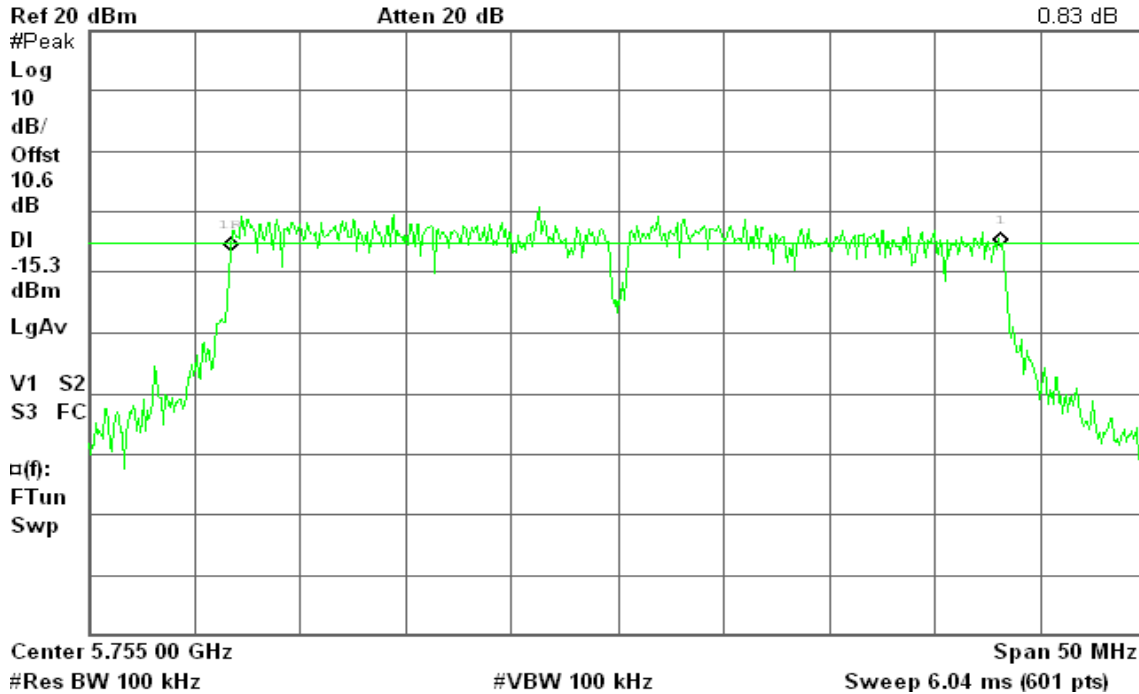

#### 6dB Bandwidth (CH High)

Agilent 22:20:52 Mar 2, 2011

R T

Δ Mkr1 36.50 MHz  
-0.08 dB

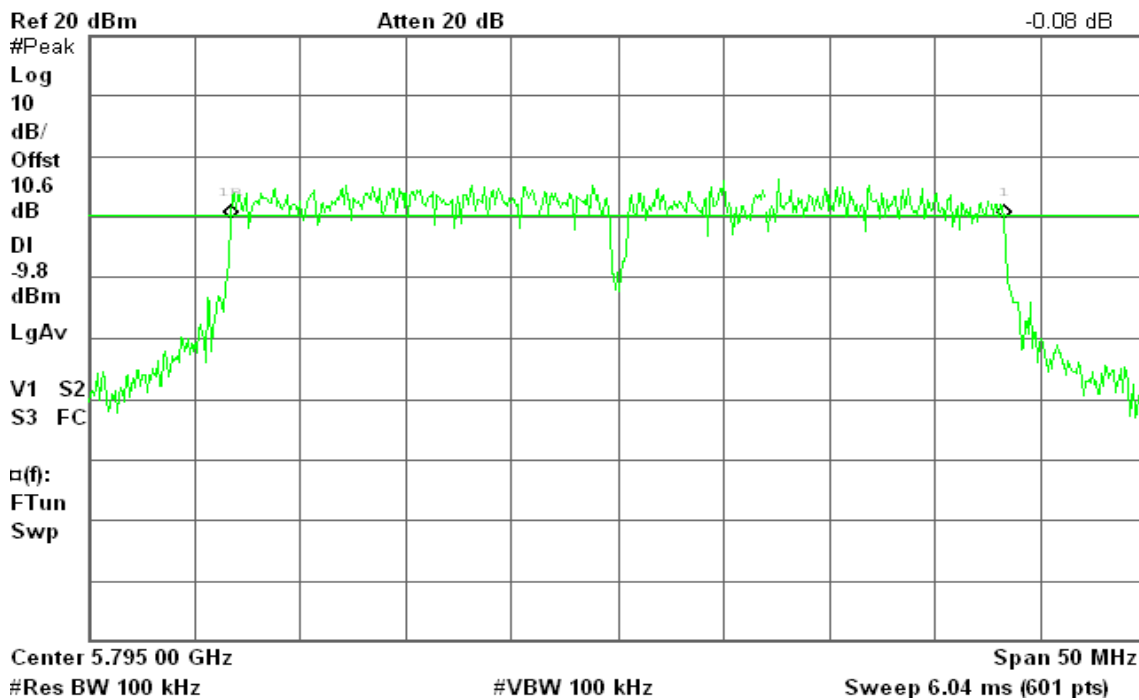



### IEEE 802.11n HT 40 MHz mode / Chain 2

#### 6dB Bandwidth (CH Low)

Agilent 21:12:21 Mar 2, 2011

R T

Δ Mkr1 36.50 MHz  
2.58 dB

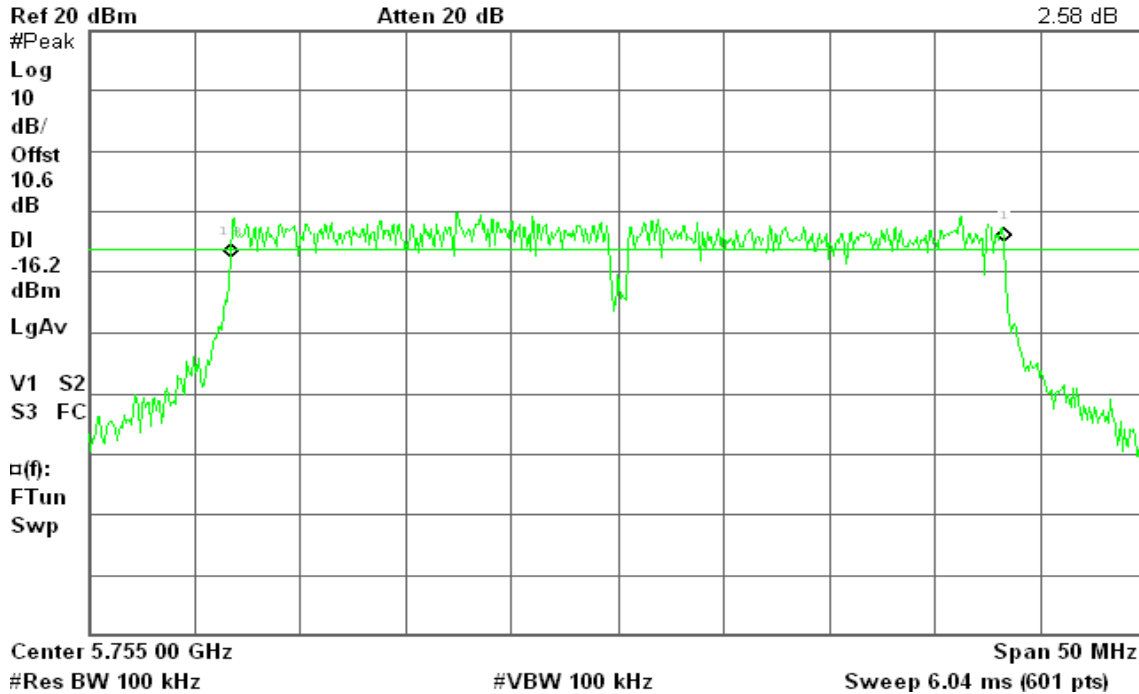

#### 6dB Bandwidth (CH High)

Agilent 22:17:12 Mar 2, 2011

R T

Δ Mkr1 36.42 MHz  
1.43 dB

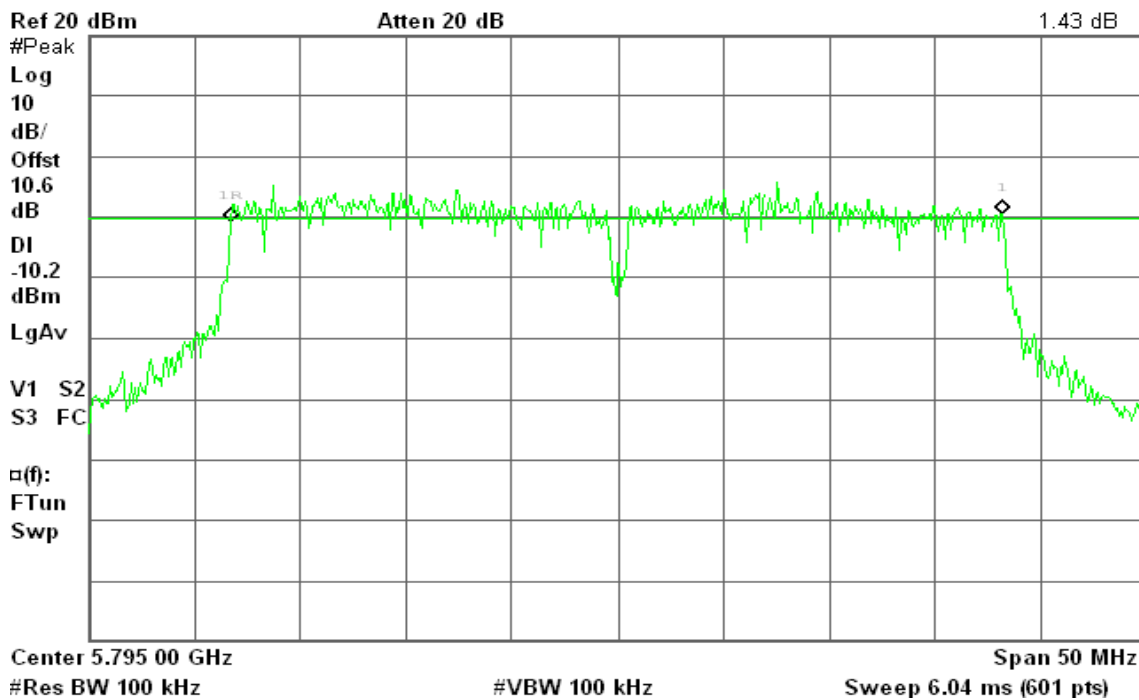





## 7.2 PEAK POWER

### LIMIT

The maximum peak output power of the intentional radiator shall not exceed the following:

1. According to §15.247(b)(3), for systems using digital modulation in the bands of 902-928 MHz, 2400-2483.5 MHz, and 5725-5850 MHz: 1 Watt.
2. According to §15.247(b)(4), the conducted output power limit specified in paragraph (b) of this section is based on the use of antennas with directional gains that do not exceed 6 dBi. Except as shown in paragraph (c) of this section, if transmitting antennas of directional gain greater than 6 dBi are used, the conducted output power from the intentional radiator shall be reduced below the stated values in paragraphs (b)(1), (b)(2), and (b)(3) of this section, as appropriate, by the amount in dB that the directional gain of the antenna exceeds 6 dBi.

### Test Configuration

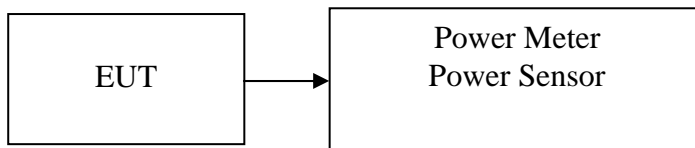

### TEST PROCEDURE

The transmitter output is connected to the Power Meter. The Power Meter is set to the peak power detection.

### TEST RESULTS

*No non-compliance noted.*



**Test Data**

**Test mode: IEEE 802.11a mode**

Channel	Frequency (MHz)	Output Power (dBm)	Output Power (W)	Limit (W)	Result
Low	5745	21.46	0.1400	1.00	PASS
Mid	5785	23.97	0.2495		PASS
High	5825	23.36	0.2168		PASS

**Test mode: IEEE 802.11n HT 20 MHz Channel mode**

Channel	Frequency (MHz)	Chain 0 Output Power (dBm)	Chain 1 Output Power (dBm)	Chain 2 Output Power (dBm)	Total Output Power (dBm)	Output Power (W)	Limit (W)	Result
Low	5745	19.37	19.31	19.31	24.10	0.2571	0.4266	PASS
Mid	5785	20.33	20.54	20.16	25.12	0.3249		PASS
High	5825	20.16	20.34	20.08	24.97	0.3138		PASS

**Test mode: IEEE 802.11n HT 40 MHz mode**

Channel	Frequency (MHz)	Chain 0 Output Power (dBm)	Chain 1 Output Power (dBm)	Chain 2 Output Power (dBm)	Total Output Power (dBm)	Output Power (W)	Limit (W)	Result
Low	5755	20.16	19.48	19.87	24.62	0.2895	0.4266	PASS
High	5795	20.42	20.13	20.84	25.24	0.3345		PASS

**Remark:**

1. Total Output Power (w) = Chain 0 (10<sup>^(Output Power /10)/1000</sup>) + Chain 1 (10<sup>^(Output Power /10)/1000</sup>) + Chain 2 (10<sup>^(Output Power /10)/1000</sup>)
2. The maximum antenna gain is 9.7dBi; therefore the reduction due to antenna gain is 3.7dBi, so the limit is 26.3dBm.



## 7.3 AVERAGE POWER

### LIMIT

None; for reporting purposes only.

### Test Configuration

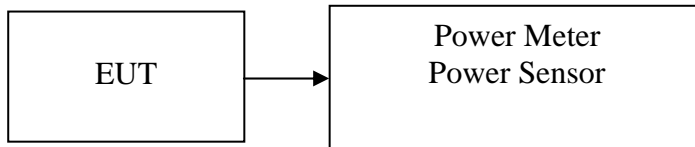

### TEST PROCEDURE

The transmitter output is connected to the Power Meter. The Power Meter is set to the peak power detection.

### TEST RESULTS

*No non-compliance noted.*



**Test Data**

**Test mode: IEEE 802.11a mode**

Channel	Frequency (MHz)	Output Power (dBm)	Output Power (W)
Low	5745	12.26	0.0168
Mid	5785	16.77	0.0475
High	5825	15.28	0.0337

**Test mode: IEEE 802.11n HT 20 MHz Channel mode**

Channel	Frequency (MHz)	Chain 0 Output Power (dBm)	Chain 1 Output Power (dBm)	Chain 2 Output Power (dBm)	Total Output Power (dBm)	Output Power (W)
Low	5745	10.08	9.92	9.41	14.58	0.0287
Mid	5785	12.16	12.84	11.85	17.07	0.0510
High	5825	11.58	11.67	11.22	16.27	0.0423

**Test mode: IEEE 802.11n HT 40 MHz mode**

Channel	Frequency (MHz)	Chain 0 Output Power (dBm)	Chain 1 Output Power (dBm)	Chain 2 Output Power (dBm)	Total Output Power (dBm)	Output Power (W)
Low	5755	8.12	7.32	7.08	12.30	0.0170
High	5795	8.51	8.16	8.67	13.22	0.0210

**Remark:**

1. Total Output Power (w) = Chain 0 ( $10^{(Output\ Power / 10) / 1000}$ ) + Chain 1 ( $10^{(Output\ Power / 10) / 1000}$ ) + Chain 2 ( $10^{(Output\ Power / 10) / 1000}$ )



## 7.4 BAND EDGES MEASUREMENT

### LIMIT

According to §15.247(d), in any 100 kHz bandwidth outside the frequency bands in which the spread spectrum intentional radiator is operating, the radio frequency power that is produced by the intentional radiator shall be at least 20 dB below that in the 100 kHz bandwidth within the band that contains the highest level of the desired power, based on either an RF conducted or a radiated measurement, provided the transmitter demonstrates compliance with the peak conducted power limits. In addition, radiated emissions which fall in the restricted bands, as defined in §15.205(a), must also comply with the radiated emission limits specified in 15.209(a) (see Section 15.205(c)).

### Test Configuration

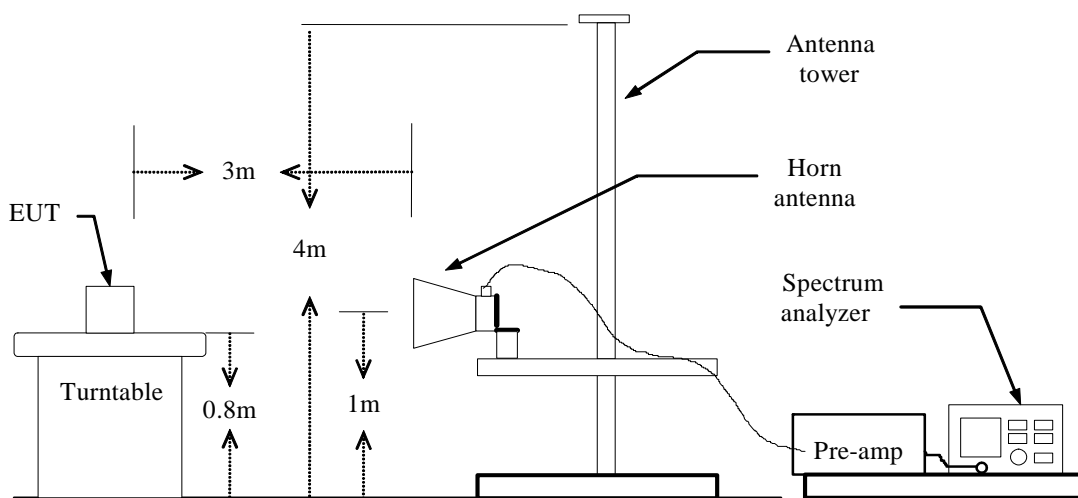

### TEST PROCEDURE

1. The EUT is placed on a turntable, which is 0.8m above the ground plane.
2. The turntable shall be rotated for 360 degrees to determine the position of maximum emission level.
3. EUT is set 3m away from the receiving antenna, which is varied from 1m to 4m to find out the highest emission.
4. Set the spectrum analyzer in the following setting in order to capture the lower and upper band-edges of the emission:
  - (a) PEAK: RBW=VBW=1MHz / Sweep=AUTO
  - (b) AVERAGE: RBW=1MHz / VBW=10Hz / Sweep=AUTO
5. Repeat the procedures until all the PEAK and AVERAGE versus POLARIZATION are measured.

### TEST RESULTS

Refer to attach spectrum analyzer data chart.



**802.11a Mode**

1. Operating Frequency: 5745-5825MHz
2. CH Low: 5745MHz, CH High: 5825MHz
3. 6dB bandwidth: CH Low: 16.42 MHz, CH High: 16.25MHz

Because the mentioned conditions, the operating frequency is in frequency bands 5725-5875MHz, the test is not applicable.



## 7.5 PEAK POWER SPECTRAL DENSITY

### LIMIT

1. According to §15.247(e), for digitally modulated systems, the power spectral density conducted from the intentional radiator to the antenna shall not be greater than 8 dBm in any 3 kHz band during any time interval of continuous transmission.
2. According to §15.247(f), the digital modulation operation of the hybrid system, with the frequency hopping turned off, shall comply with the power density requirements of paragraph (d) of this section.

### Test Configuration

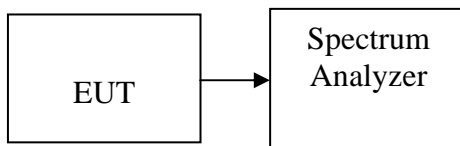

### TEST PROCEDURE

1. Place the EUT on the table and set it in transmitting mode.  
Remove the antenna from the EUT and then connect a low loss RF cable from the antenna port to the spectrum analyzer.
2. Set the spectrum analyzer as RBW = 3kHz, VBW = 10kHz, Span = 300kHz, Sweep=100s.
3. Record the max. reading.
4. Repeat the above procedure until the measurements for all frequencies are completed.

### TEST RESULTS

*No non-compliance noted*

**Test Data****Test mode: IEEE 802.11a mode**

Channel	Frequency (MHz)	PPSD (dBm)	Limit (dBm)	Result
Low	5745	-13.73	8.00	PASS
Mid	5785	-10.33		PASS
High	5825	-12.86		PASS

**Test mode: IEEE 802.11n HT 20 MHz Channel mode**

Channel	Frequency (MHz)	Chain 0 PPSD (dBm)	Chain 1 PPSD (dBm)	Chain 2 PPSD (dBm)	PPSD (dBm)	Limit (dBm)	Result
Low	5745	-15.81	-14.00	-14.05	-9.77	4.30	PASS
Mid	5785	-9.45	-8.03	-8.61	-3.89		PASS
High	5825	-13.03	-9.85	-10.85	-6.28		PASS

**Test mode: IEEE 802.11n HT 40 MHz mode**

Channel	Frequency (MHz)	Chain 0 PPSD (dBm)	Chain 1 PPSD (dBm)	Chain 2 PPSD (dBm)	PPSD (dBm)	Limit (dBm)	Result
Low	5755	-20.22	-19.99	-19.75	-15.21	4.30	PASS
High	5795	-14.55	-13.56	-15.73	-9.75		PASS

**Test mode: IEEE 802.11n HT 20 MHz Channel mode with combiner**

Channel	Frequency (MHz)	PPSD (dBm)	Limit (dBm)	Result
Low	5745	-9.47	4.30	PASS
Mid	5785	-2.15		PASS
High	5825	-4.92		PASS

**Test mode: IEEE 802.11n HT 40 MHz mode with combiner**

Channel	Frequency (MHz)	PPSD (dBm)	Limit (dBm)	Result
Low	5755	-16.78	4.30	PASS
High	5795	-9.23		PASS

**Remark:**

1. Total PPSD (dBm) =  $10 * \text{LOG}(10^{(\text{Chain 0 PPSD} / 10)} + 10^{(\text{Chain 1 PPSD} / 10)} + 10^{(\text{Chain 2 PPSD} / 10)})$
2. The maximum antenna gain is 9.7 dBi; therefore the reduction due to antenna gain is 3.7 dBi, so the limit is 4.3dBm.





**Test Plot**

**IEEE 802.11a mode**

**PPSD (CH Low)**

Agilent 14:37:48 Mar 2, 2011

R T

Mkr1 5.740 639 5 GHz  
-13.73 dBm

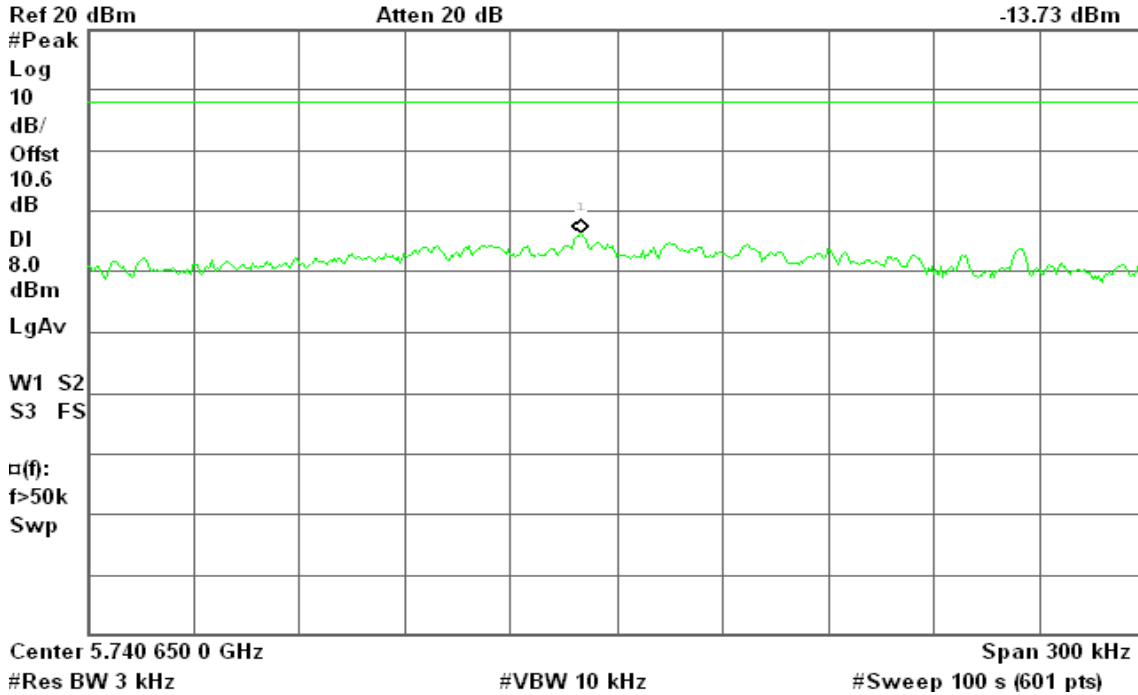

**PPSD (CH Mid)**

Agilent 14:44:04 Mar 2, 2011

R T

Mkr1 5.786 245 0 GHz  
-10.33 dBm

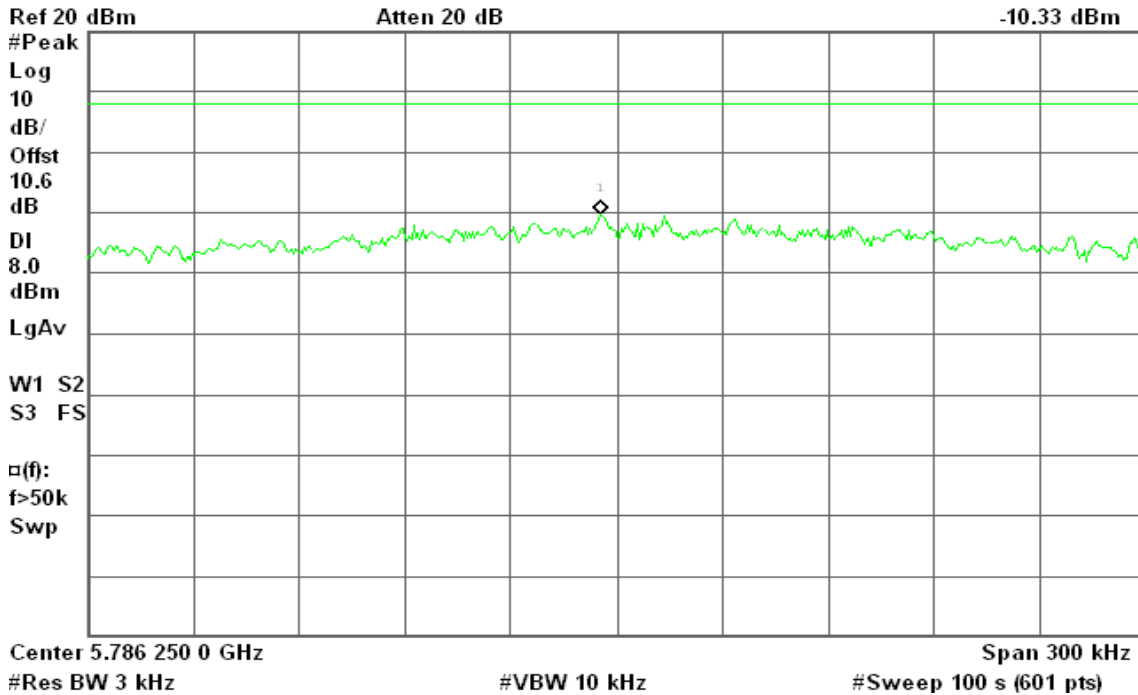



### PPSD (CH High)

Agilent 14:49:07 Mar 2, 2011

R T

Mkr1 5.820 264 0 GHz  
-12.86 dBm

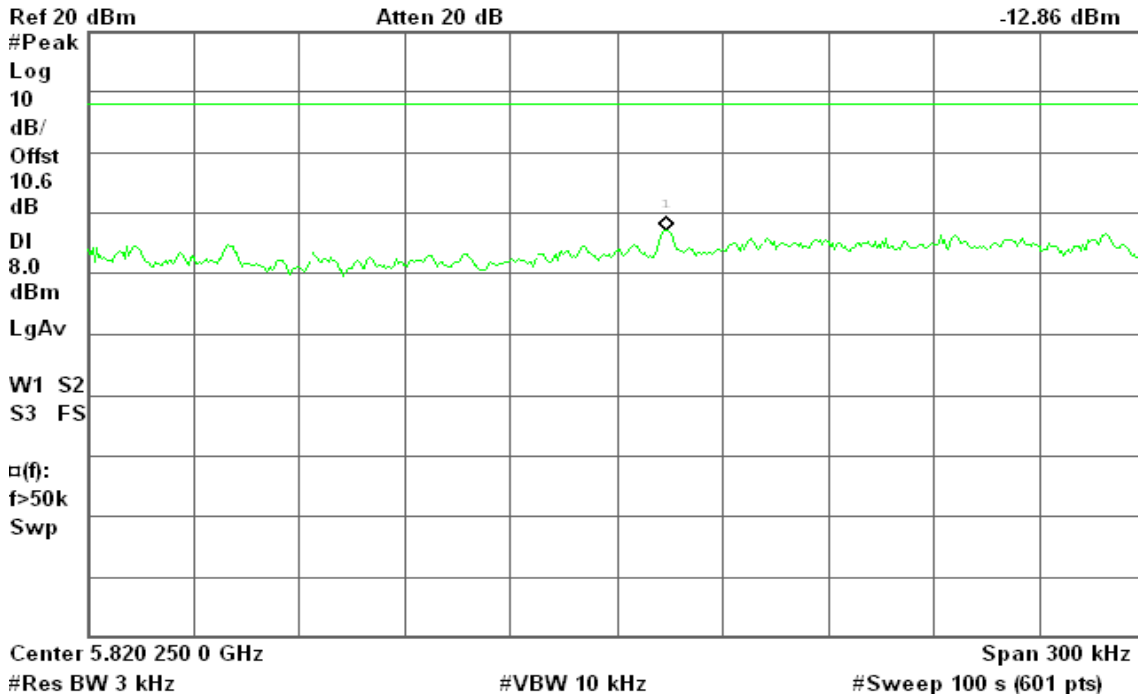

### IEEE 802.11n HT 20 MHz Channel mode / Chain 0

### PPSD (CH Low)

Agilent 15:15:21 Mar 2, 2011

R T

Mkr1 5.741 889 5 GHz  
-15.81 dBm

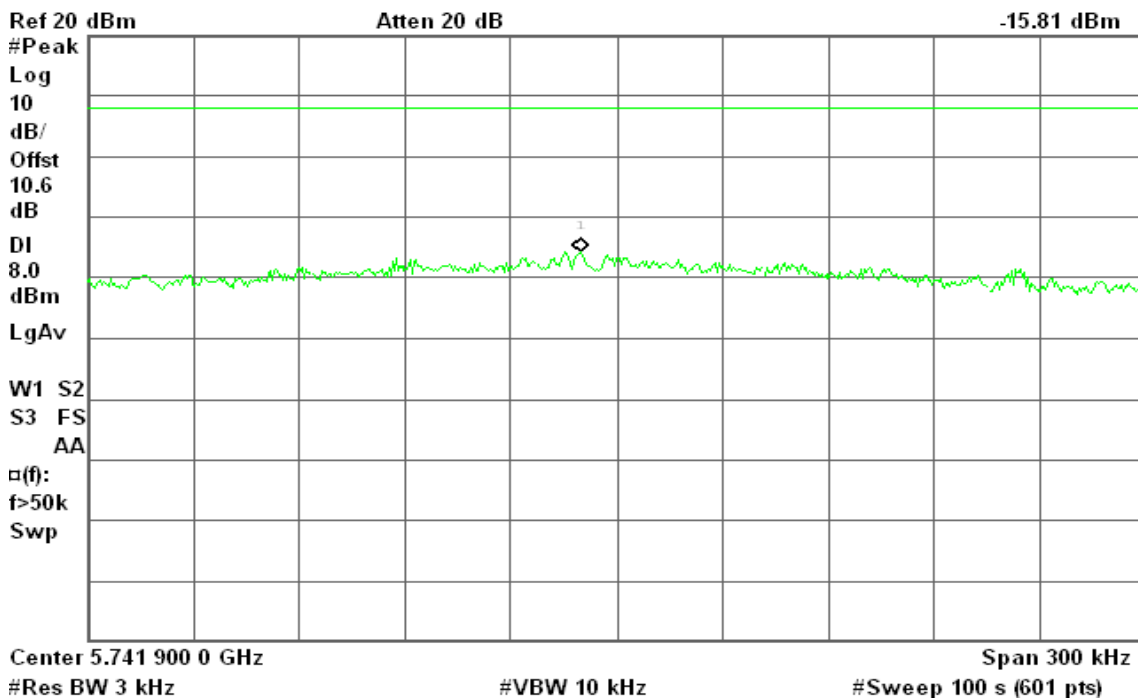



### PPSD (CH Mid)

Agilent 15:03:14 Mar 2, 2011

R T

Mkr1 5.785 307 0 GHz  
-9.45 dBm

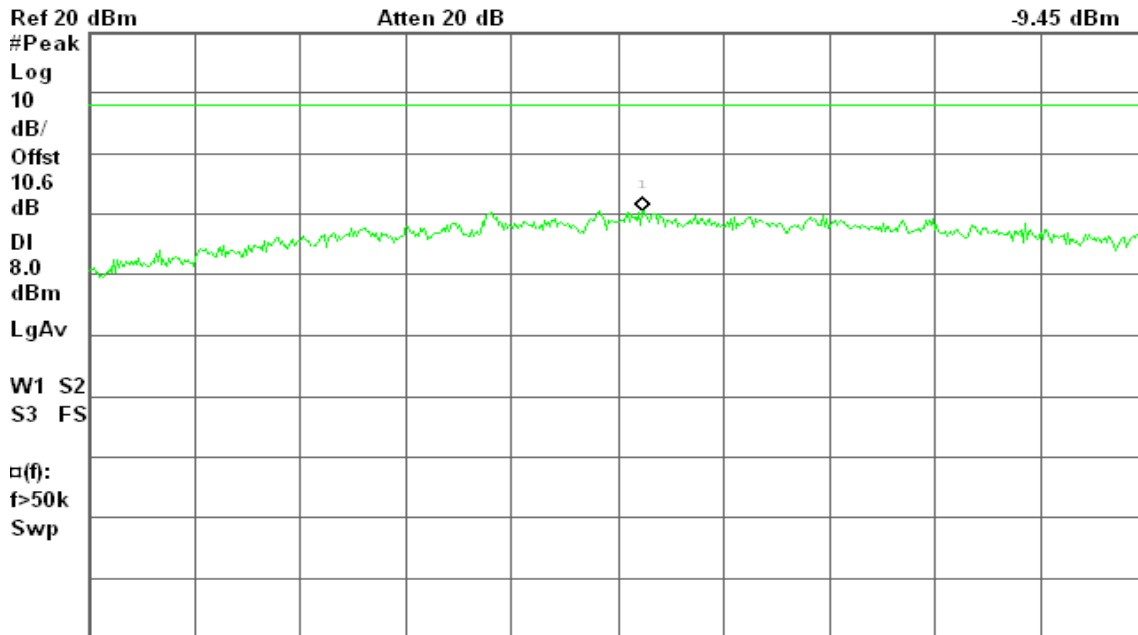

Center 5.785 300 0 GHz      Span 300 kHz  
#Res BW 3 kHz      #VBW 10 kHz      #Sweep 100 s (601 pts)

### PPSD (CH High)

Agilent 14:55:27 Mar 2, 2011

R T

Mkr1 5.825 639 1 GHz  
-13.03 dBm

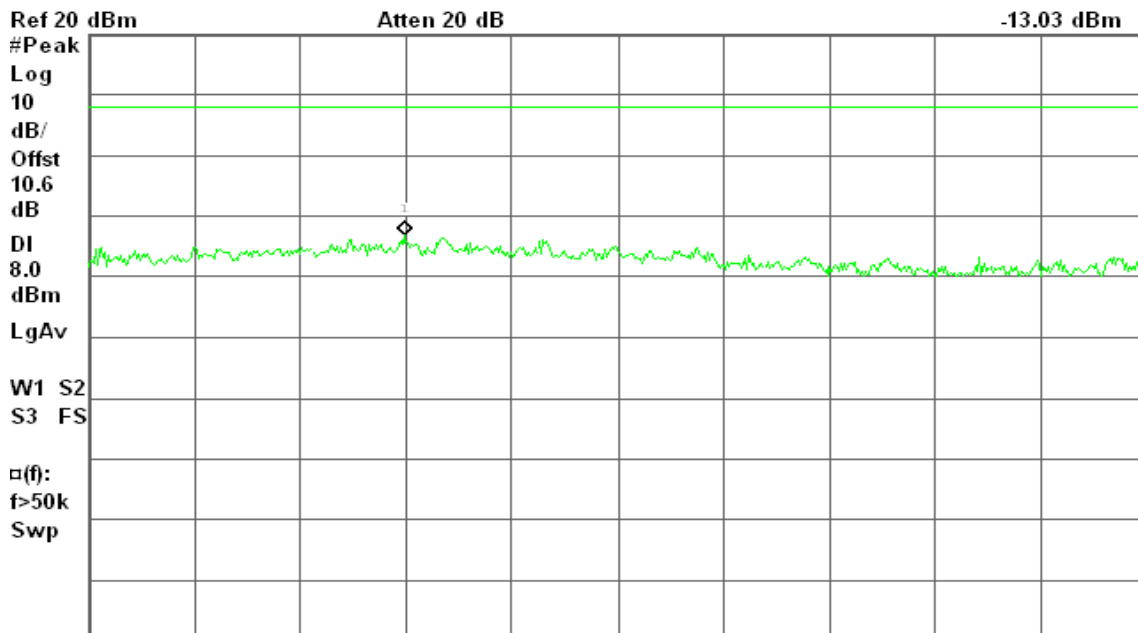

Center 5.825 700 0 GHz      Span 300 kHz  
#Res BW 3 kHz      #VBW 10 kHz      #Sweep 100 s (601 pts)



### IEEE 802.11n HT 20 MHz Channel mode / Chain 1

#### PPSD (CH Low)

Agilent 20:44:32 Mar 2, 2011

R T

Mkr1 5.749 138 5 GHz

-14.00 dBm

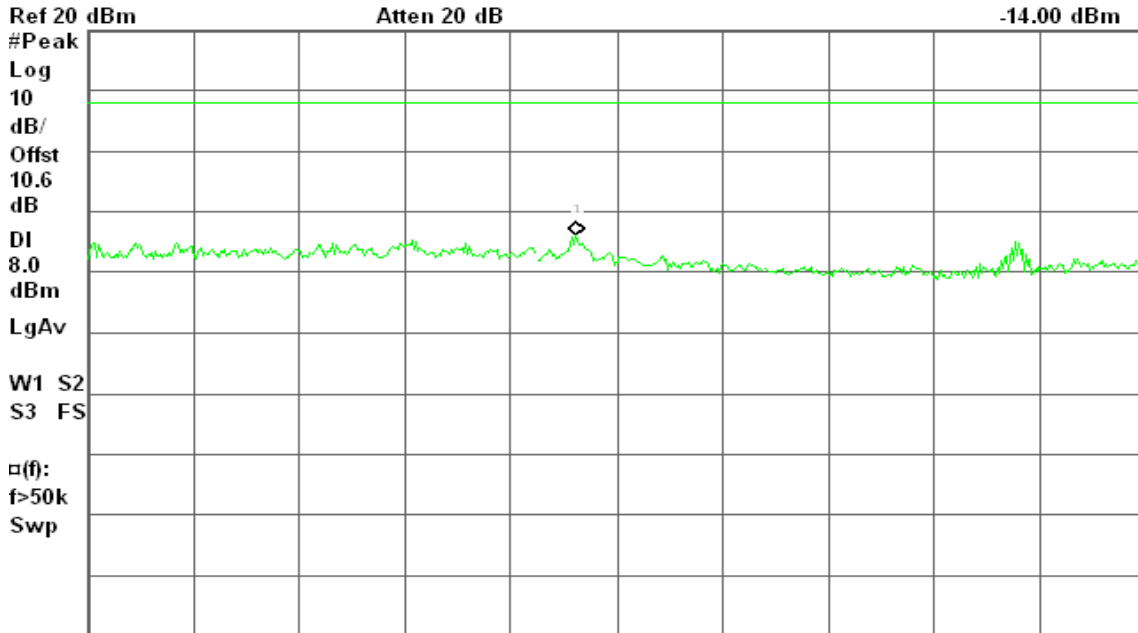

Center 5.749 150 0 GHz

Span 300 kHz

#Res BW 3 kHz

#VBW 10 kHz

#Sweep 100 s (601 pts)

#### PPSD (CH Mid)

Agilent 20:49:09 Mar 2, 2011

R T

Mkr1 5.787 888 5 GHz

-8.03 dBm

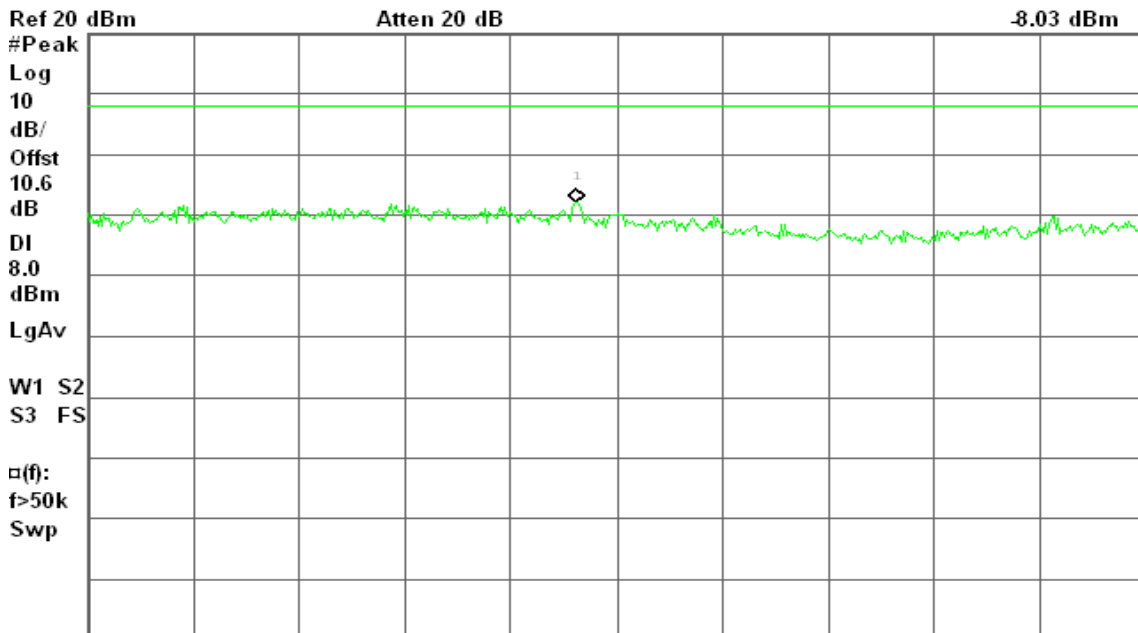

Center 5.787 900 0 GHz

Span 300 kHz

#Res BW 3 kHz

#VBW 10 kHz

#Sweep 100 s (601 pts)



### PPSD (CH High)

Agilent 21:00:32 Mar 2, 2011

R T

Mkr1 5.830 025 6 GHz  
-9.85 dBm

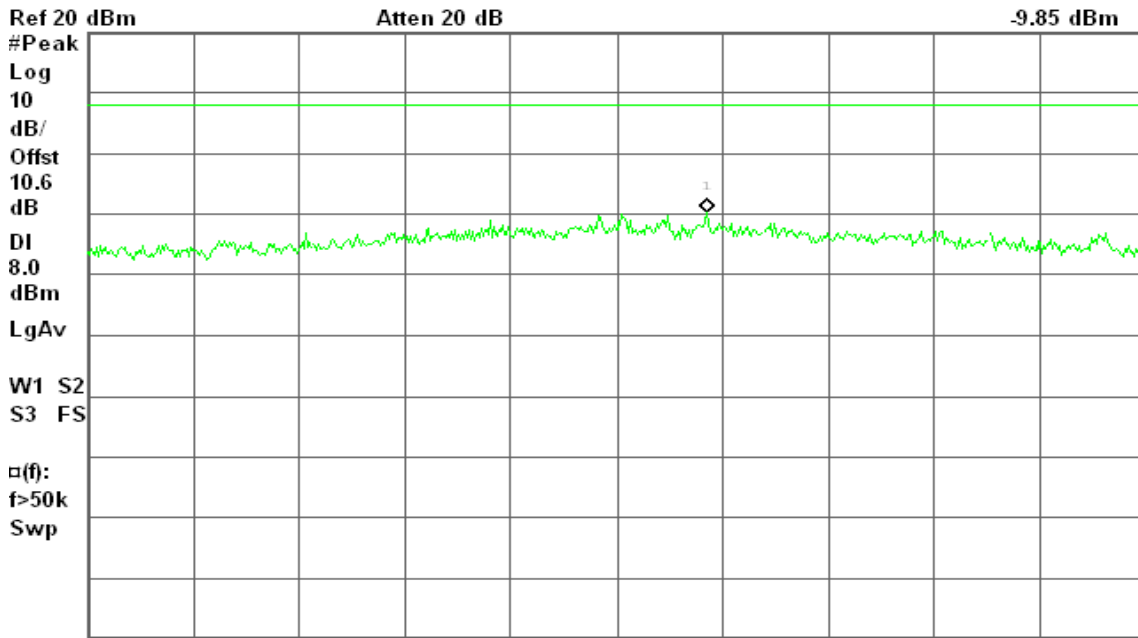

Center 5.830 000 0 GHz

Span 300 kHz

#Res BW 3 kHz

#VBW 10 kHz

#Sweep 100 s (601 pts)

### IEEE 802.11n HT 20 MHz Channel mode / Chain 2

### PPSD (CH Low)

Agilent 20:40:19 Mar 2, 2011

R T

Mkr1 5.746 263 4 GHz  
-14.05 dBm

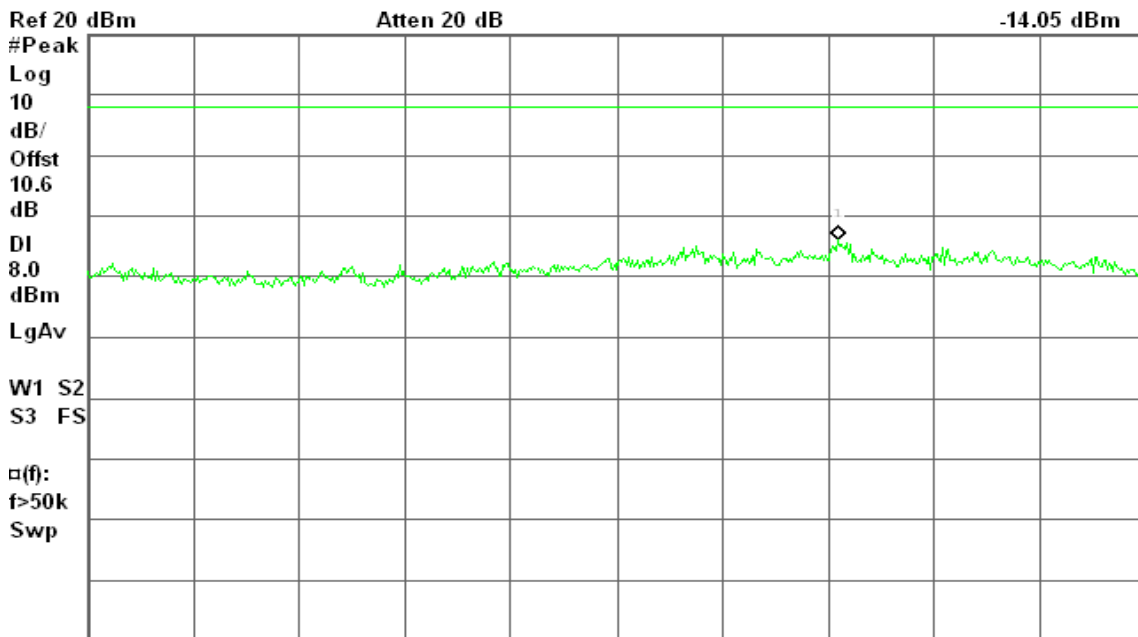

Center 5.746 200 0 GHz

Span 300 kHz

#Res BW 3 kHz

#VBW 10 kHz

#Sweep 100 s (601 pts)



### PPSD (CH Mid)

Agilent 20:52:42 Mar 2, 2011

R T

Mkr1 5.788 139 0 GHz  
-8.61 dBm

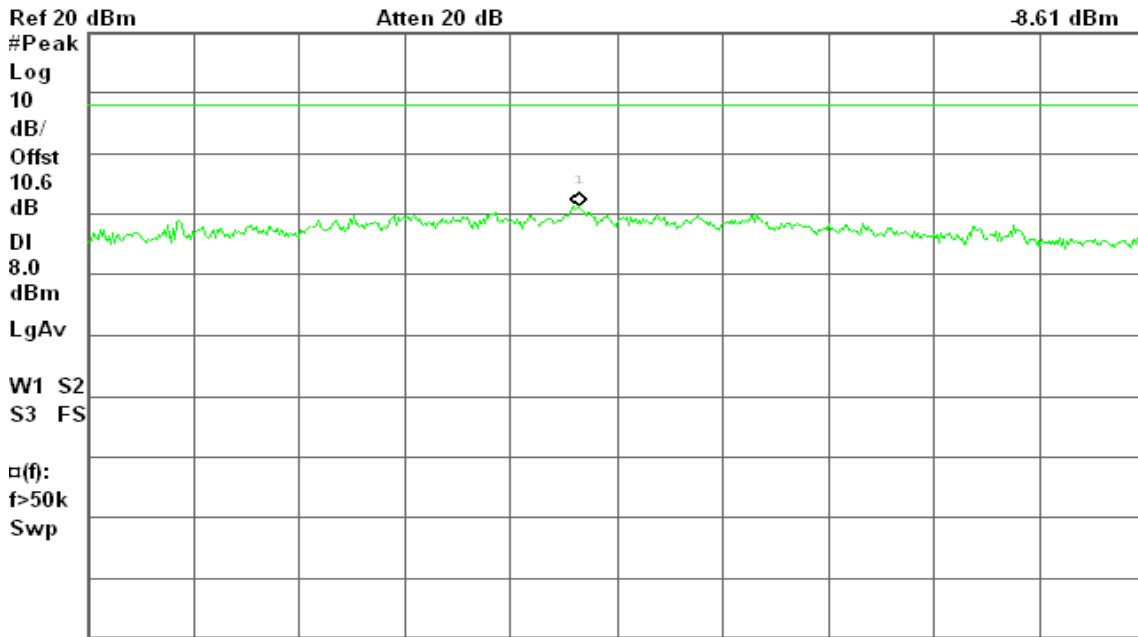

Center 5.788 150 0 GHz

Span 300 kHz

#Res BW 3 kHz

#VBW 10 kHz

#Sweep 100 s (601 pts)

### PPSD (CH High)

Agilent 20:56:53 Mar 2, 2011

R T

Mkr1 5.823 760 5 GHz  
-10.85 dBm

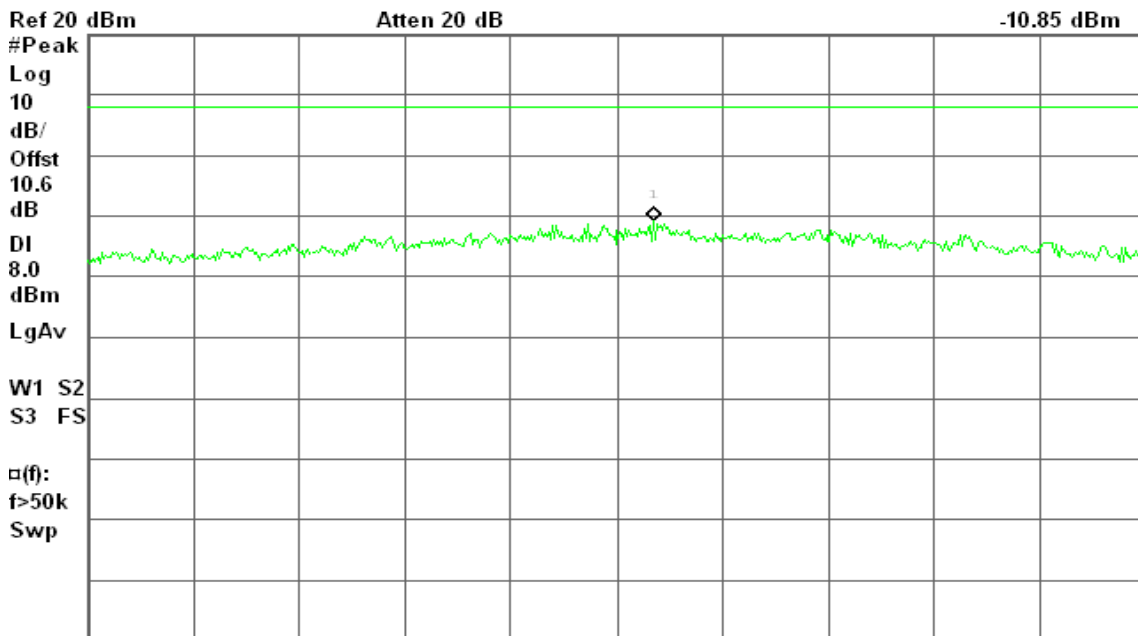

Center 5.823 750 0 GHz

Span 300 kHz

#Res BW 3 kHz

#VBW 10 kHz

#Sweep 100 s (601 pts)



### IEEE 802.11n HT 40 MHz mode / Chain 0

#### PPSD (CH Low)

Agilent 21:07:18 Mar 2, 2011

R L

Mkr1 5.746 888 5 GHz

-20.22 dBm

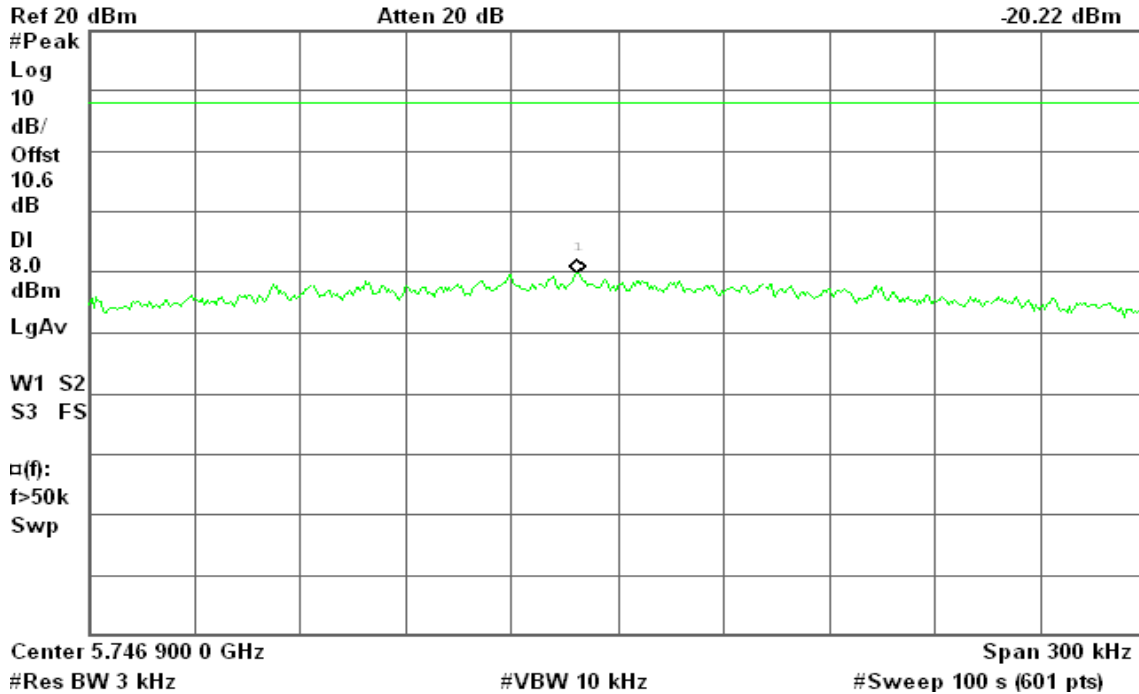

#### PPSD (CH High)

Agilent 22:27:22 Mar 2, 2011

R T

Mkr1 5.790 619 9 GHz

-14.55 dBm

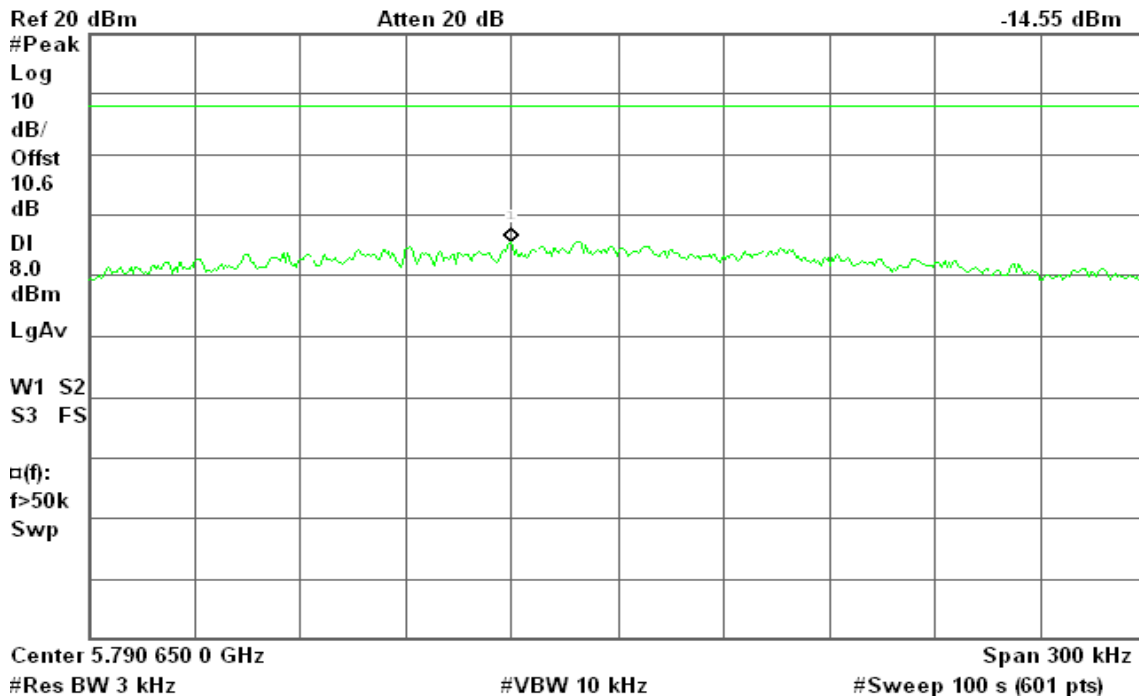



### IEEE 802.11n HT 40 MHz mode / Chain 1

#### PPSD (CH Low)

Agilent 21:10:55 Mar 2, 2011

R T

Mkr1 5.746 889 0 GHz

-19.99 dBm

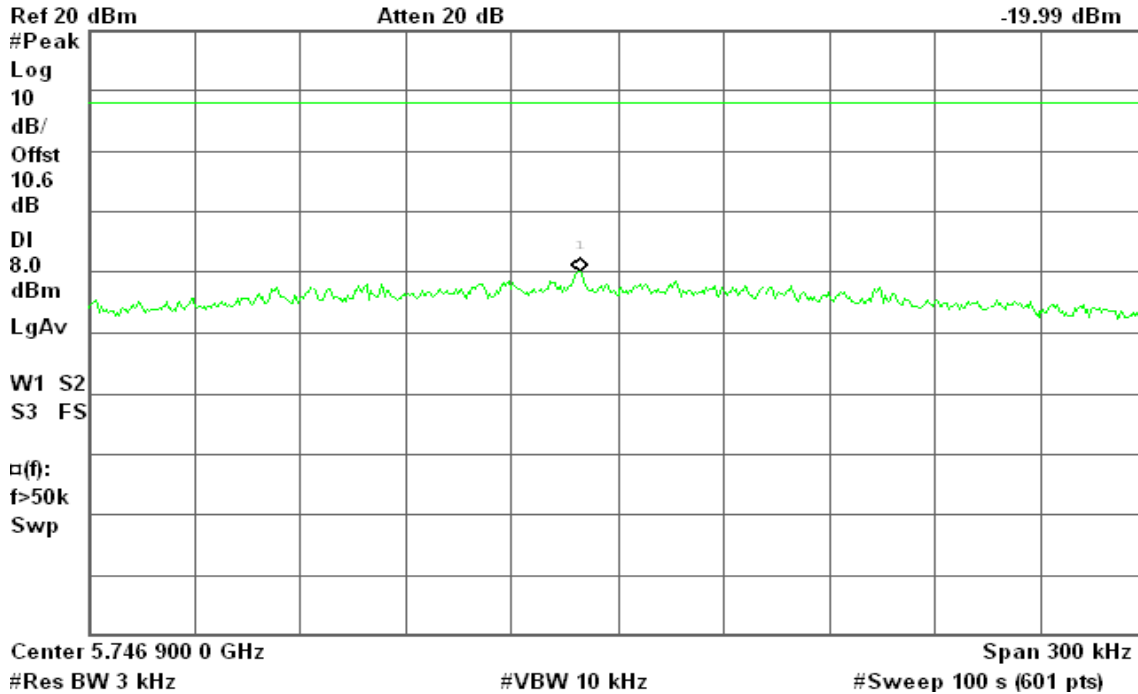

#### PPSD (CH High)

Agilent 22:23:27 Mar 2, 2011

R T

Mkr1 5.792 763 0 GHz

-13.56 dBm

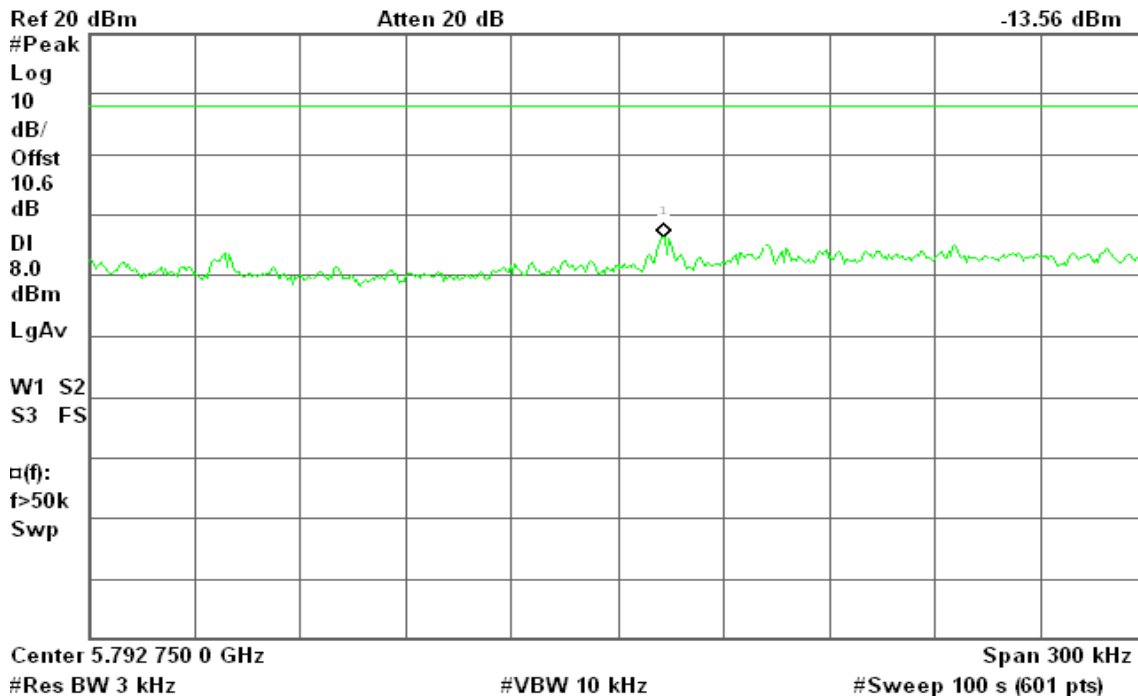





### IEEE 802.11n HT 40 MHz mode / Chain 2

#### PPSD (CH Low)

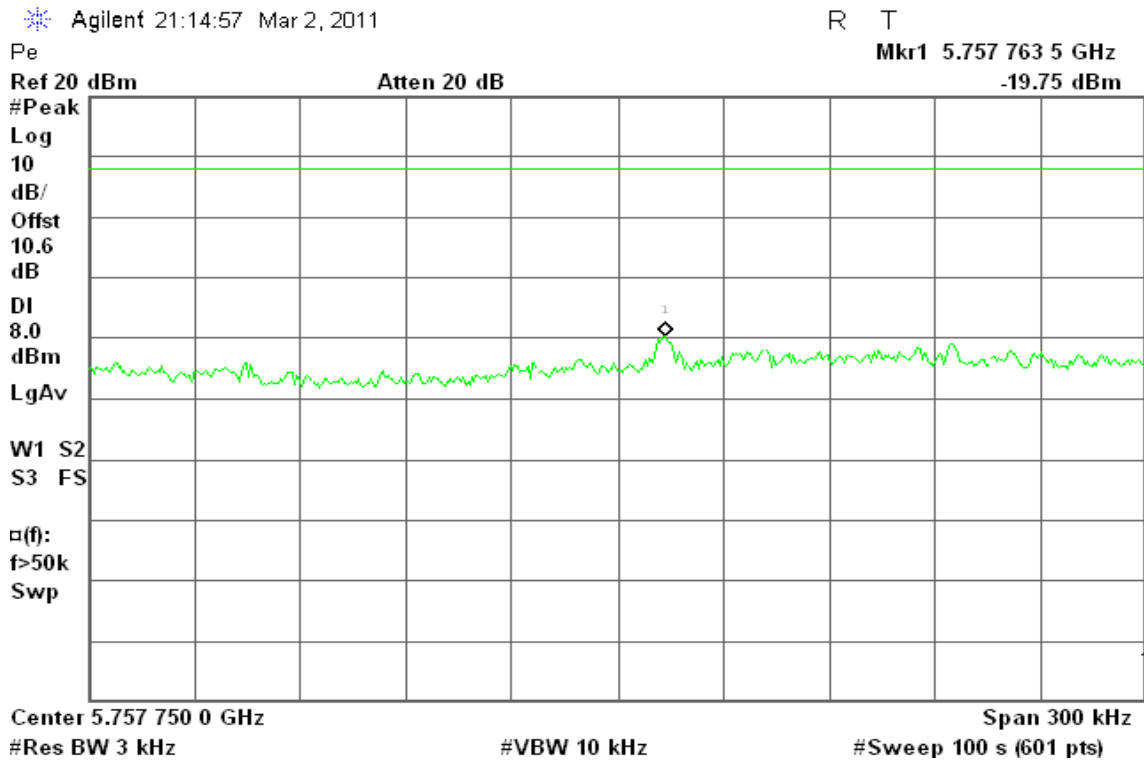

#### PPSD (CH High)

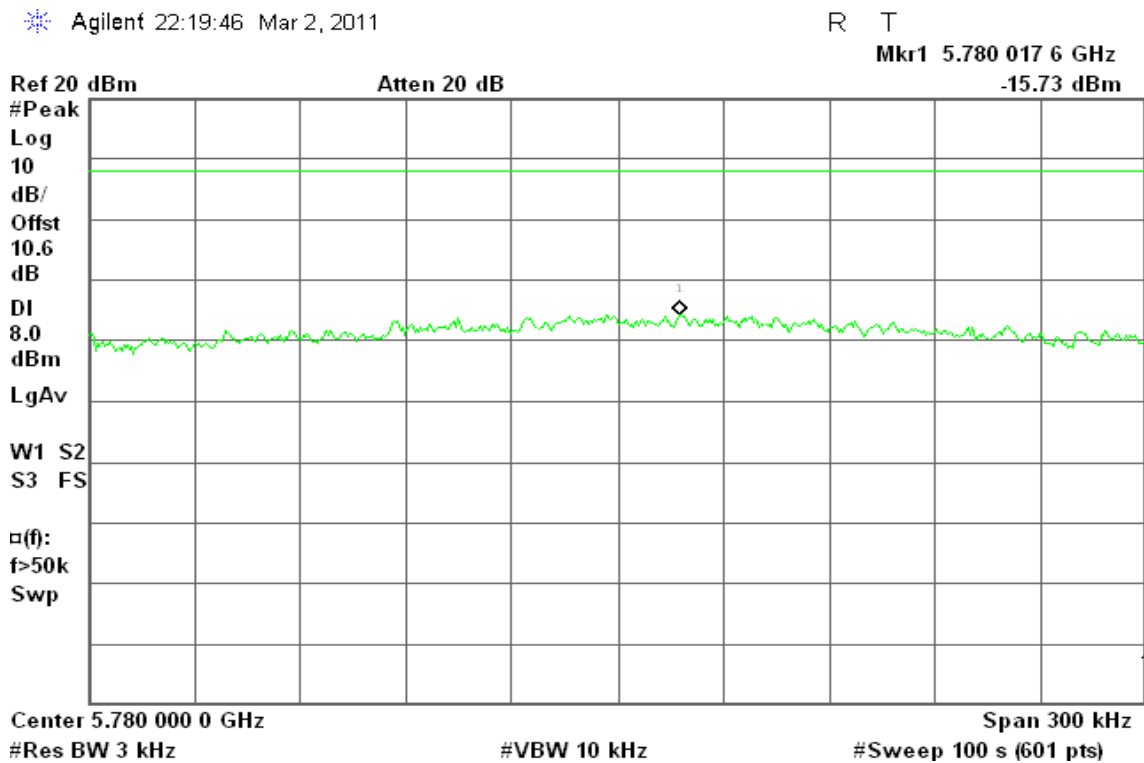



### IEEE 802.11n HT 20 MHz Channel mode with combiner

#### PPSD (CH Low)

Agilent 00:36:41 Mar 3, 2011

R T

Mkr1 5.743 138 1 GHz  
-9.47 dBm

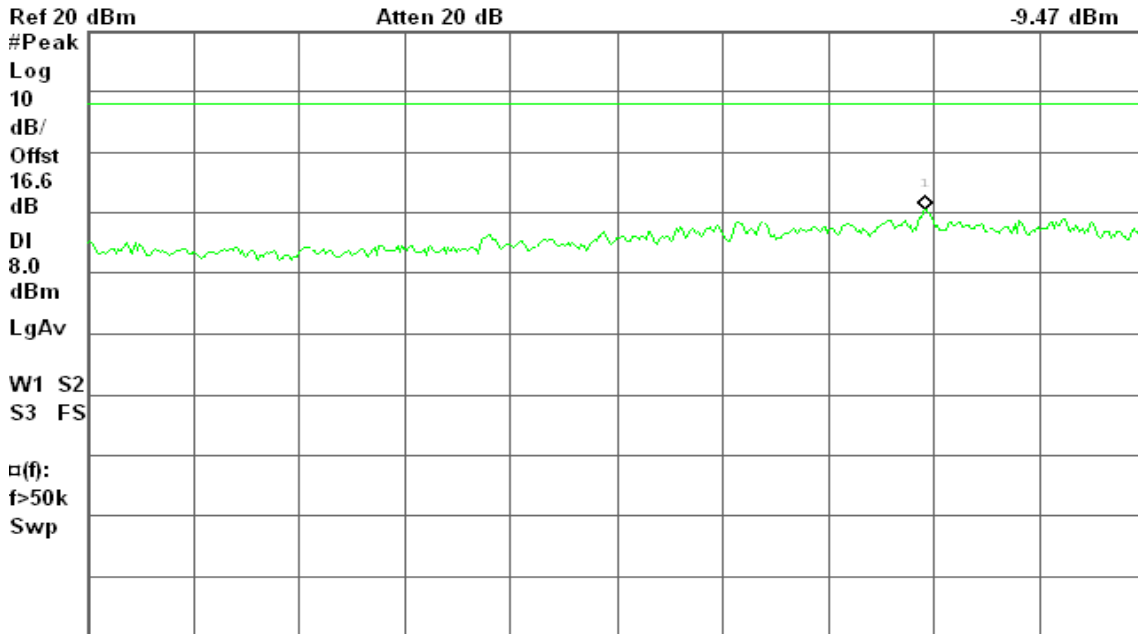

Center 5.743 050 0 GHz

Span 300 kHz

#Res BW 3 kHz

#VBW 10 kHz

#Sweep 100 s (601 pts)

#### PPSD (CH Mid)

Agilent 00:33:06 Mar 3, 2011

R T

Mkr1 5.788 139 0 GHz  
-2.15 dBm

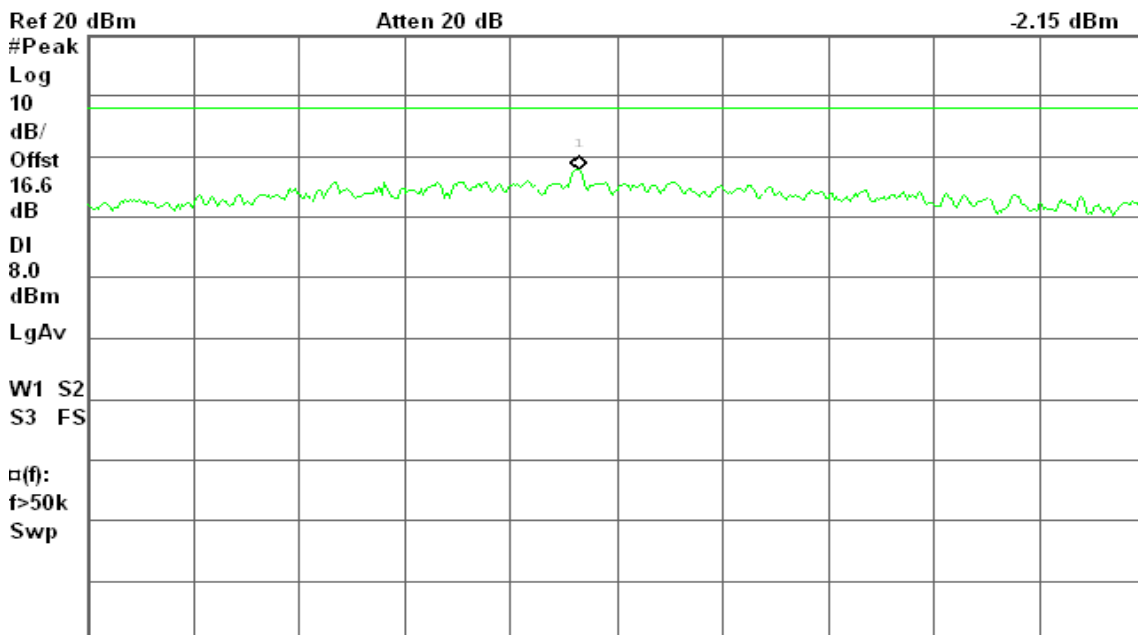

Center 5.788 150 0 GHz

Span 300 kHz

#Res BW 3 kHz

#VBW 10 kHz

#Sweep 100 s (601 pts)



### PPSD (CH High)

Agilent 00:29:41 Mar 3, 2011

R T

Mkr1 5.824 013 5 GHz

-4.92 dBm

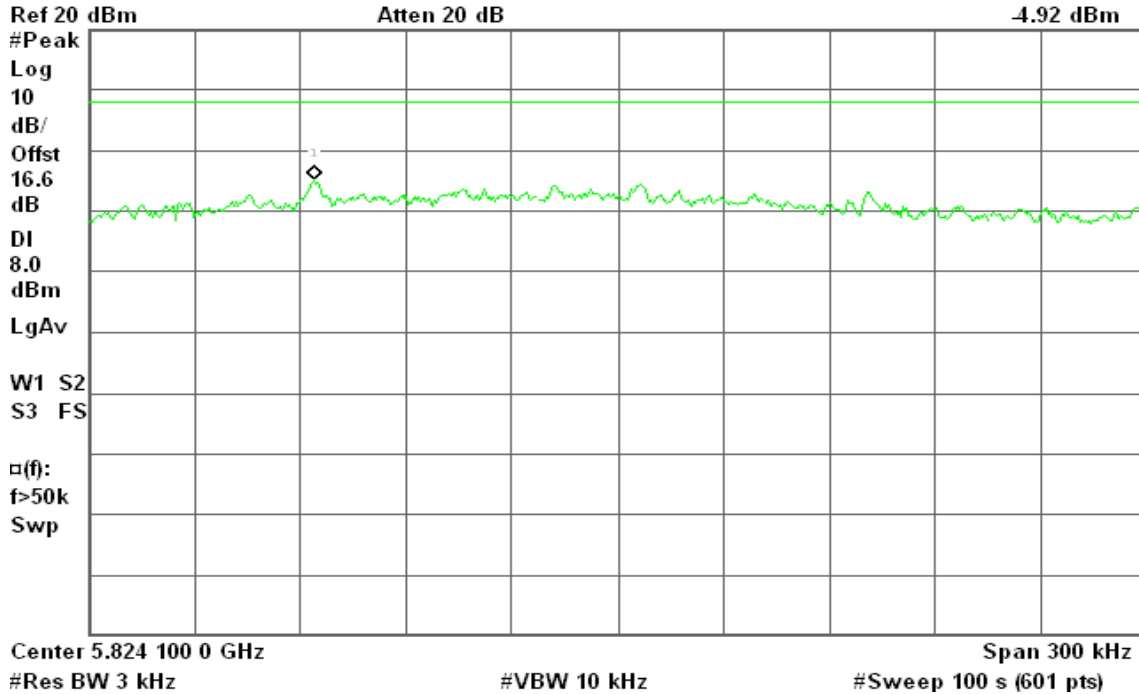

### IEEE 802.11n HT 40 MHz mode with combiner

### PPSD (CH Low)

Agilent 00:17:52 Mar 3, 2011

R T

Mkr1 5.762 205 6 GHz

-16.78 dBm

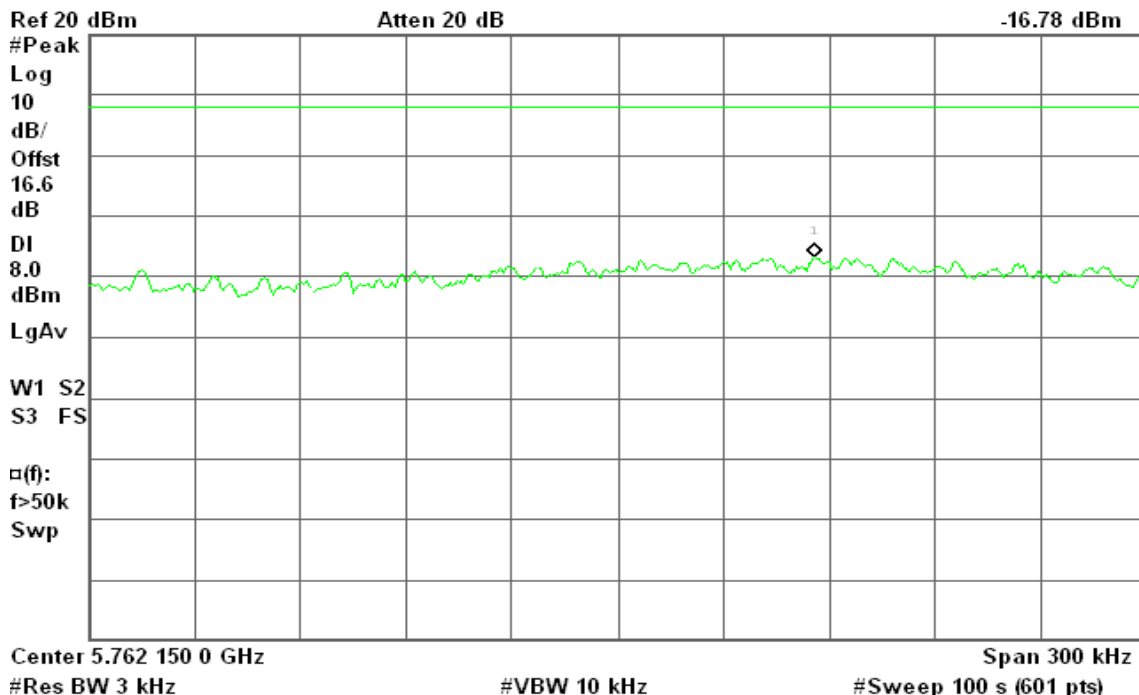



### PPSD (CH High)

Agilent 00:21:53 Mar 3, 2011

R L

Mkr1 5.800 303 3 GHz  
-9.23 dBm

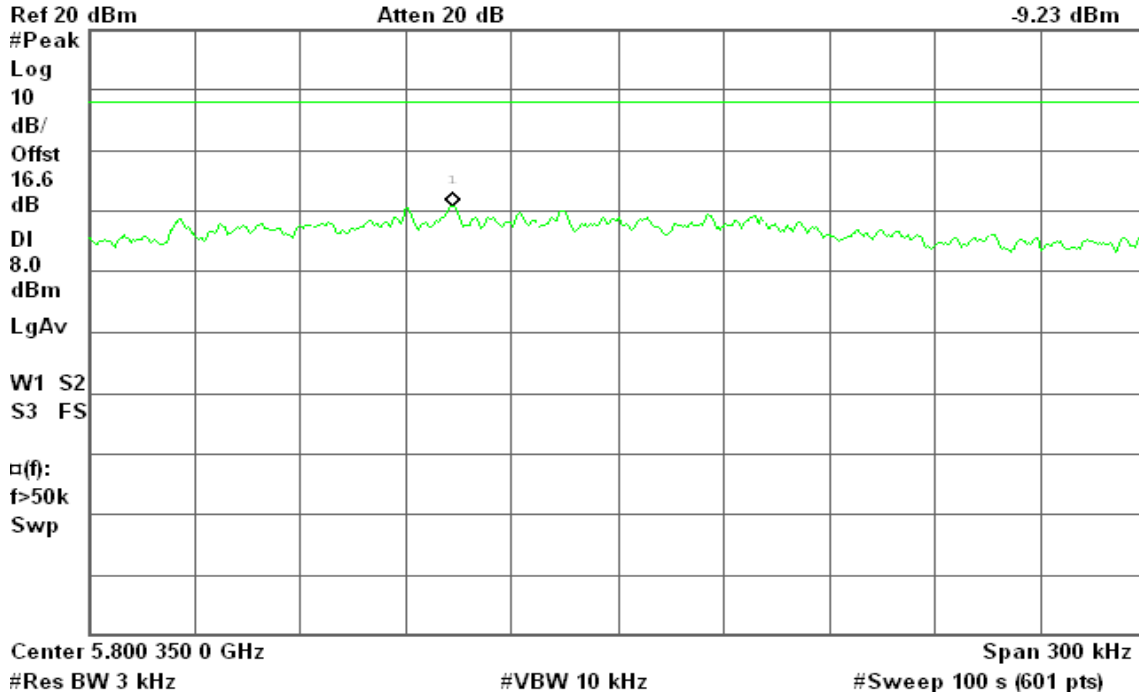



## 7.6 SPURIOUS EMISSIONS

### 7.6.1 CONDUCTED MEASUREMENT

#### LIMIT

According to §15.247(d), in any 100 kHz bandwidth outside the frequency bands in which the spread spectrum intentional radiator is operating, the radio frequency power that is produced by the intentional radiator shall be at least 20 dB below that in the 100 kHz bandwidth within the band that contains the highest level of the desired power, based on either an RF conducted or a radiated measurement, provided the transmitter demonstrates compliance with the peak conducted power limits. In addition, radiated emissions which fall in the restricted bands, as defined in §15.205(a), must also comply with the radiated emission limits specified in 15.209(a) (see Section 15.205(c)).

#### Test Configuration

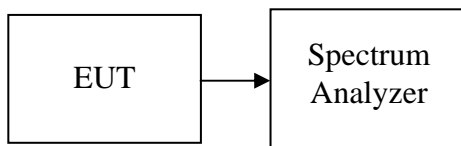

#### TEST PROCEDURE

Conducted RF measurements of the transmitter output were made to confirm that the EUT antenna port conducted emissions meet the specified limit and to identify any spurious signals that require further investigation or measurements on the radiated emissions site.

The transmitter output is connected to the spectrum analyzer. The resolution bandwidth is set to 100 kHz. The video bandwidth is set to 100 kHz.

Measurements are made over the 20GHz to 40GHz range with the transmitter set to the lowest, middle, and highest channels.

#### TEST RESULTS

*No non-compliance noted.*





### CH High

Agilent 14:50:05 Mar 2, 2011

R L

Mkr1 5.83 GHz  
-0.91 dBm

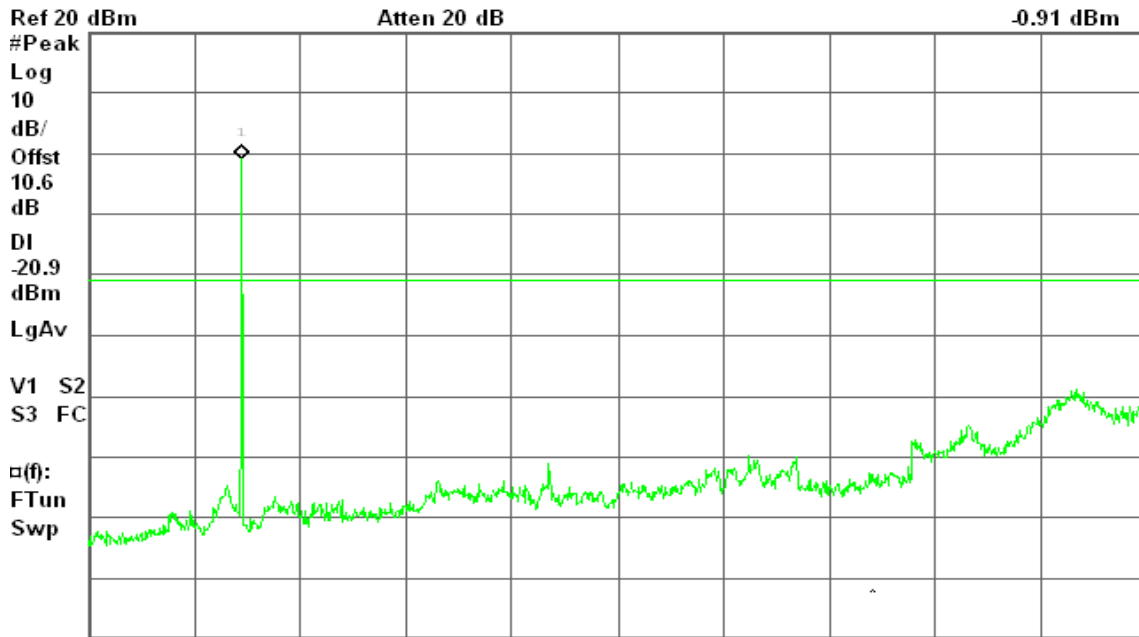

Center 20.02 GHz      Span 39.97 GHz  
#Res BW 100 kHz      #VBW 100 kHz      Sweep 4.819 s (1001 pts)

### IEEE 802.11n HT 20 MHz Channel mode / Chain 0

### CH Low

Agilent 15:17:46 Mar 2, 2011

R T

Mkr1 5.75 GHz  
-7.21 dBm

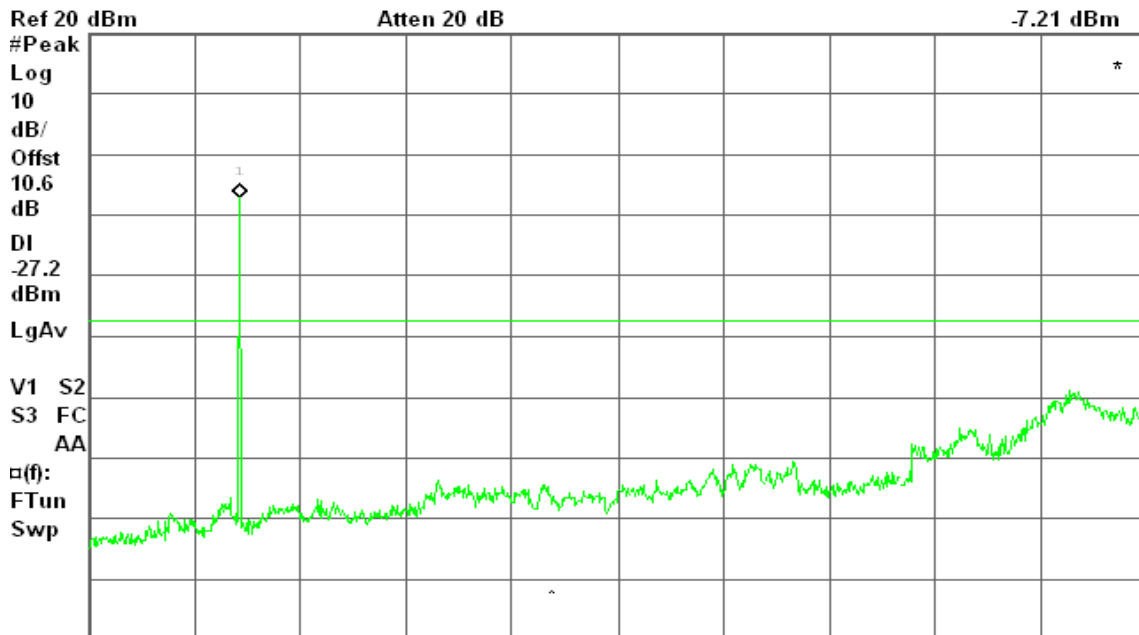

Center 20.02 GHz      Span 39.97 GHz  
#Res BW 100 kHz      #VBW 100 kHz      Sweep 4.819 s (1001 pts)



### CH Mid

Agilent 15:06:47 Mar 2, 2011

R T

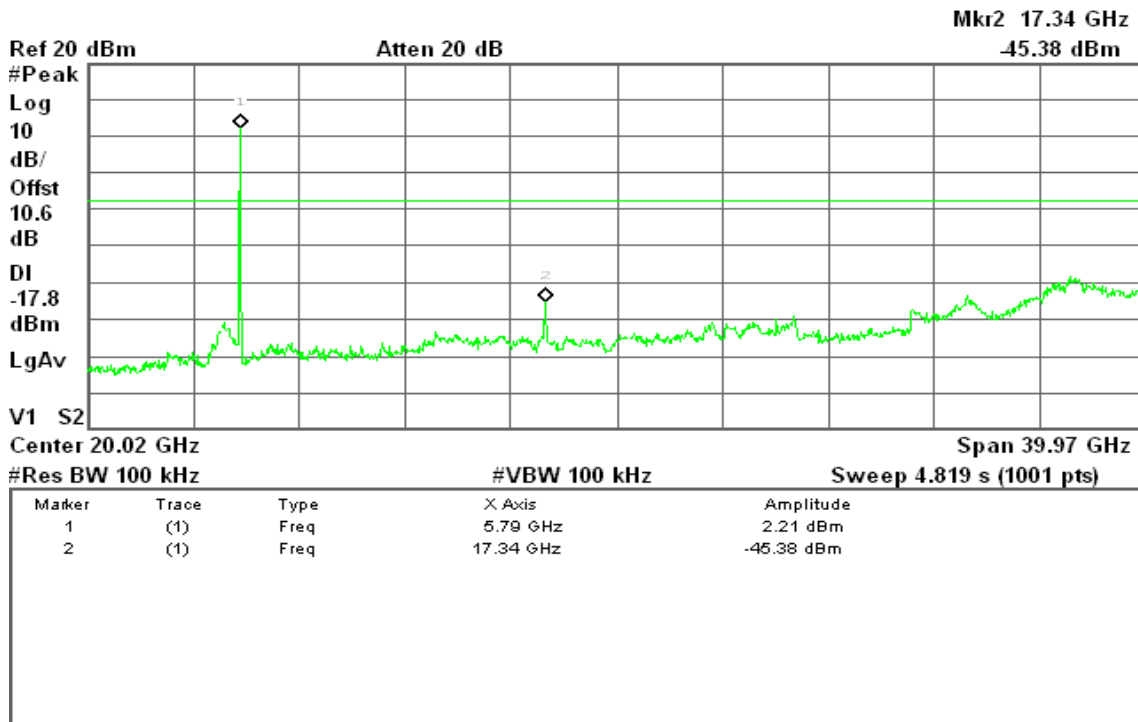

### CH High

Agilent 14:56:11 Mar 2, 2011

R T

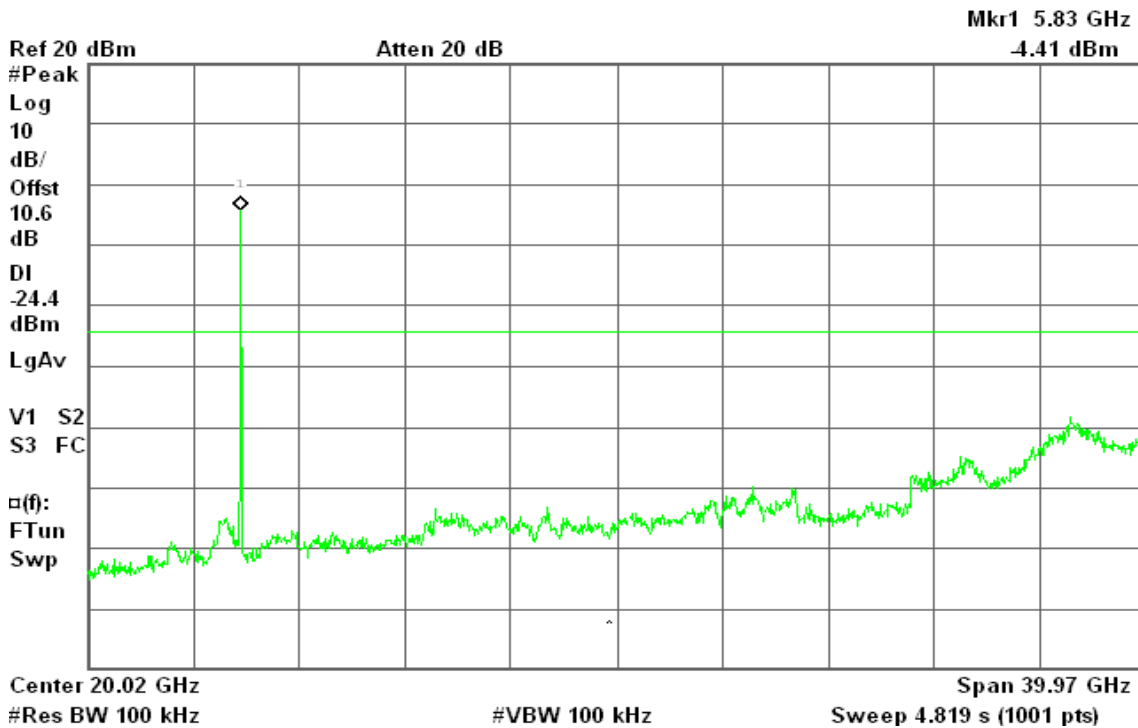







### CH High

Agilent 21:01:13 Mar 2, 2011

R T

Mkr1 5.83 GHz  
0.28 dBm

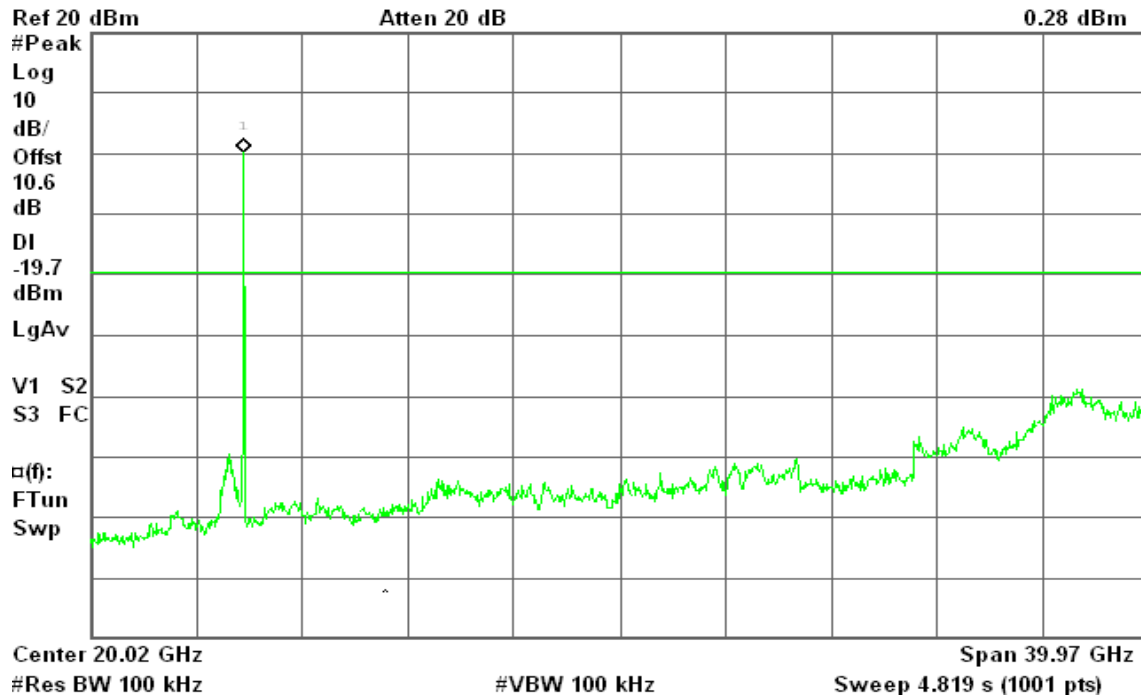



### IEEE 802.11n HT 20 MHz Channel mode / Chain 2

#### CH Low

Agilent 20:41:02 Mar 2, 2011

R T

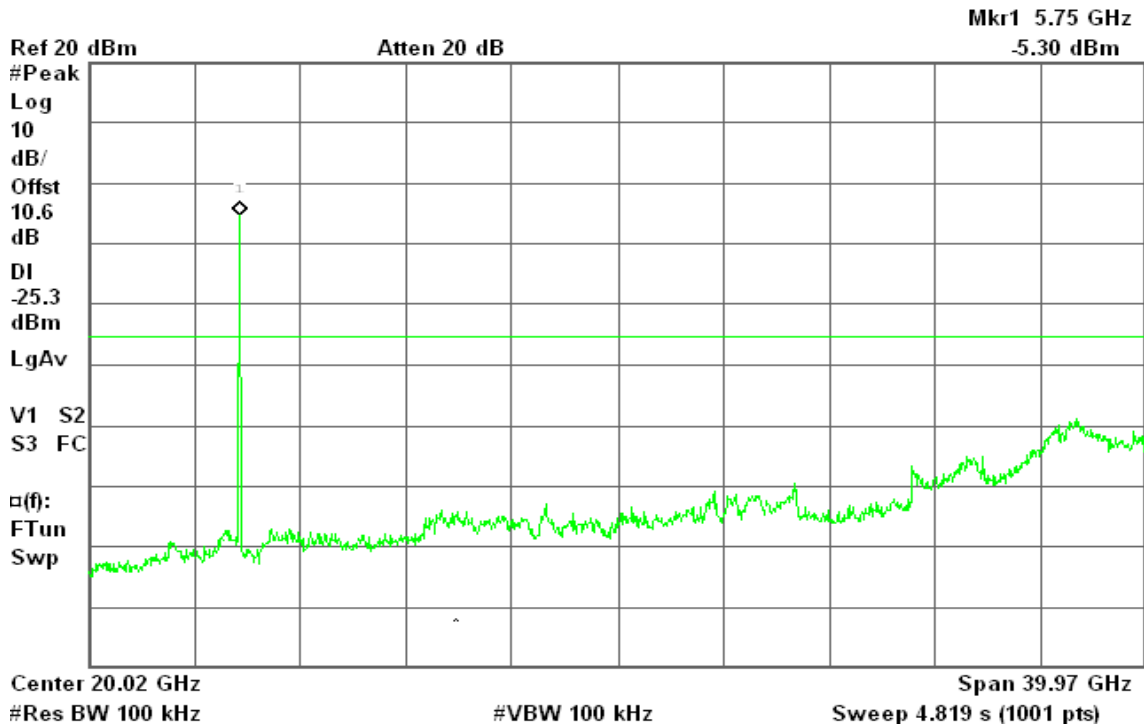

#### CH Mid

Agilent 20:53:25 Mar 2, 2011

R L

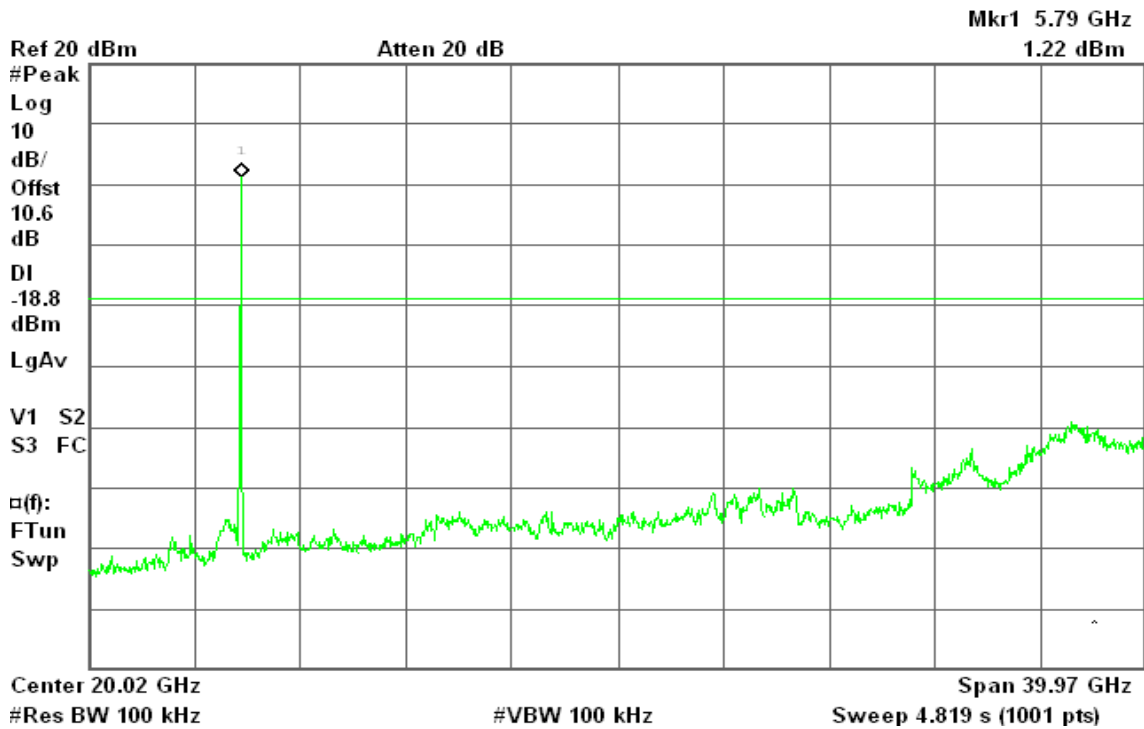



### CH High

Agilent 20:57:34 Mar 2, 2011

R L

Mkr1 5.83 GHz  
-1.49 dBm

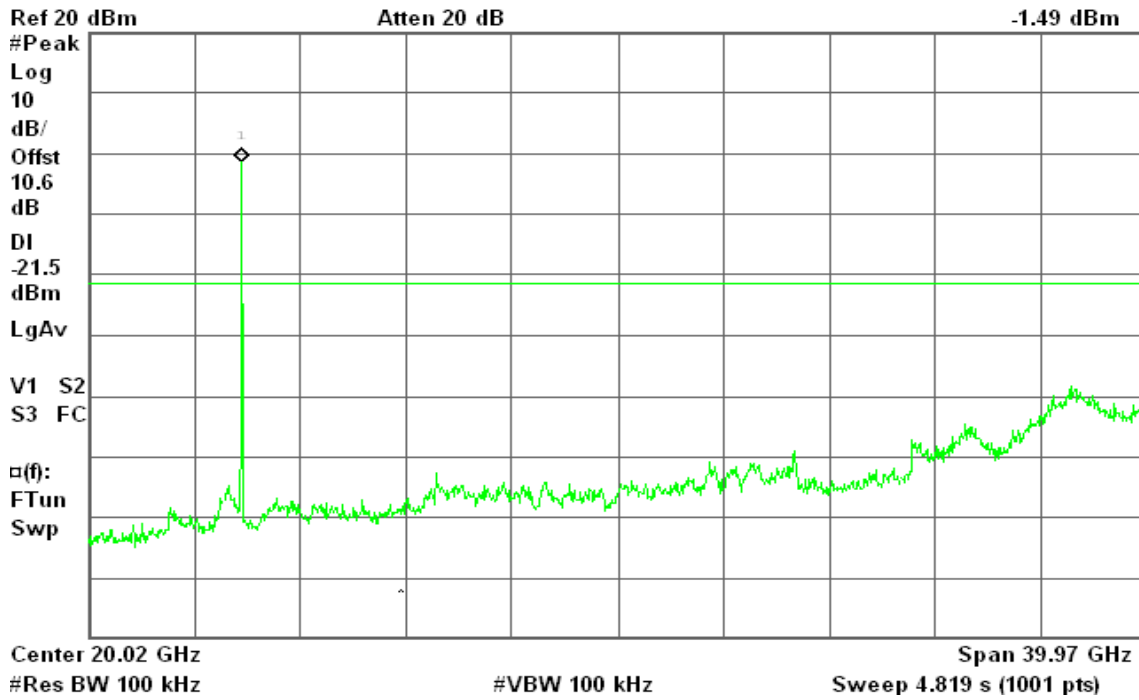



### IEEE 802.11n HT 40 MHz mode / Chain 0

#### CH Low

Agilent 21:08:01 Mar 2, 2011

R T

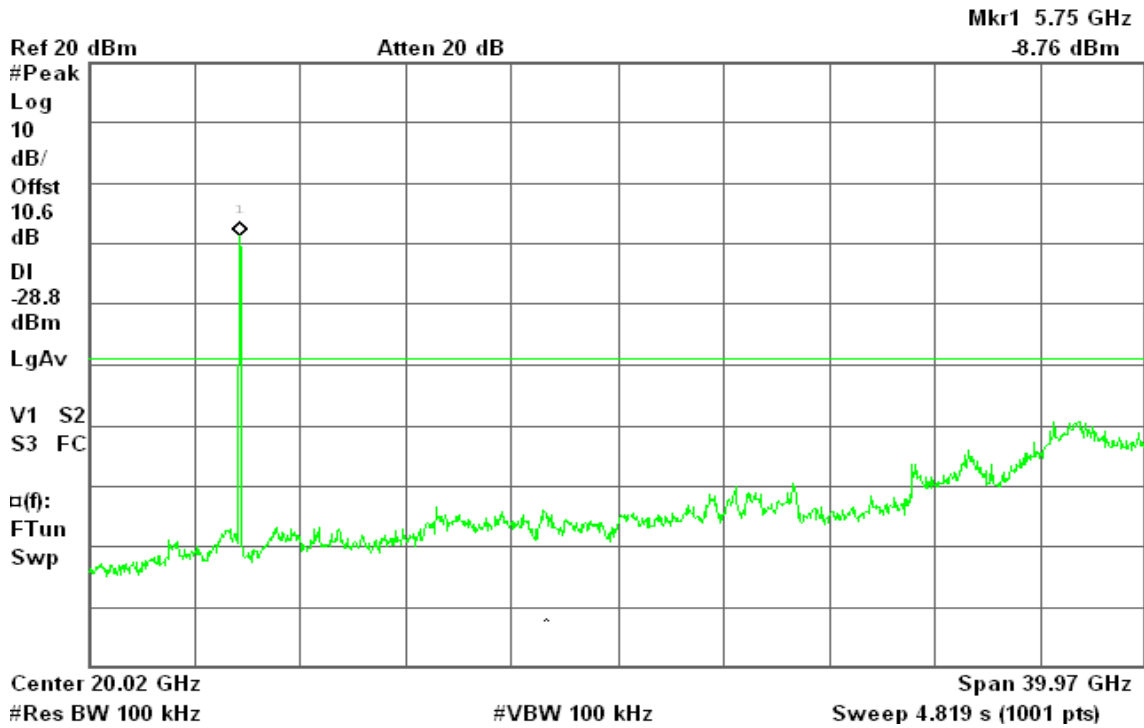

#### CH High

Agilent 22:28:00 Mar 2, 2011

R T

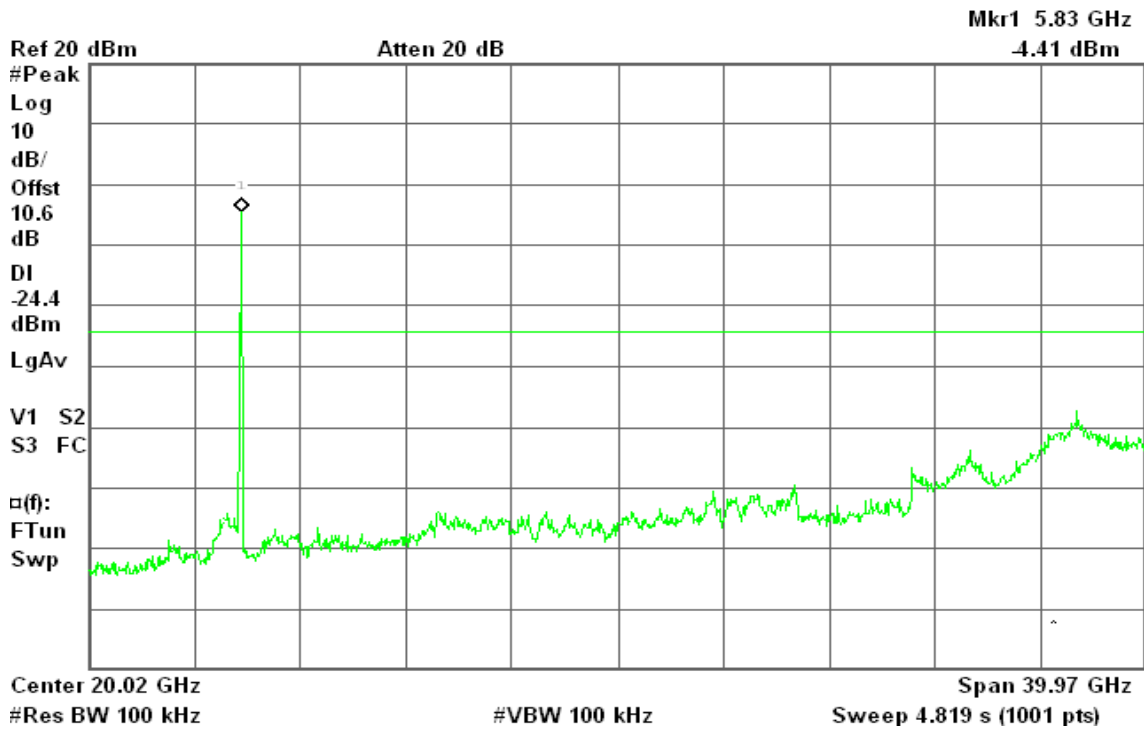



### IEEE 802.11n HT 40 MHz mode / Chain 1

#### CH Low

Agilent 21:11:38 Mar 2, 2011

R T

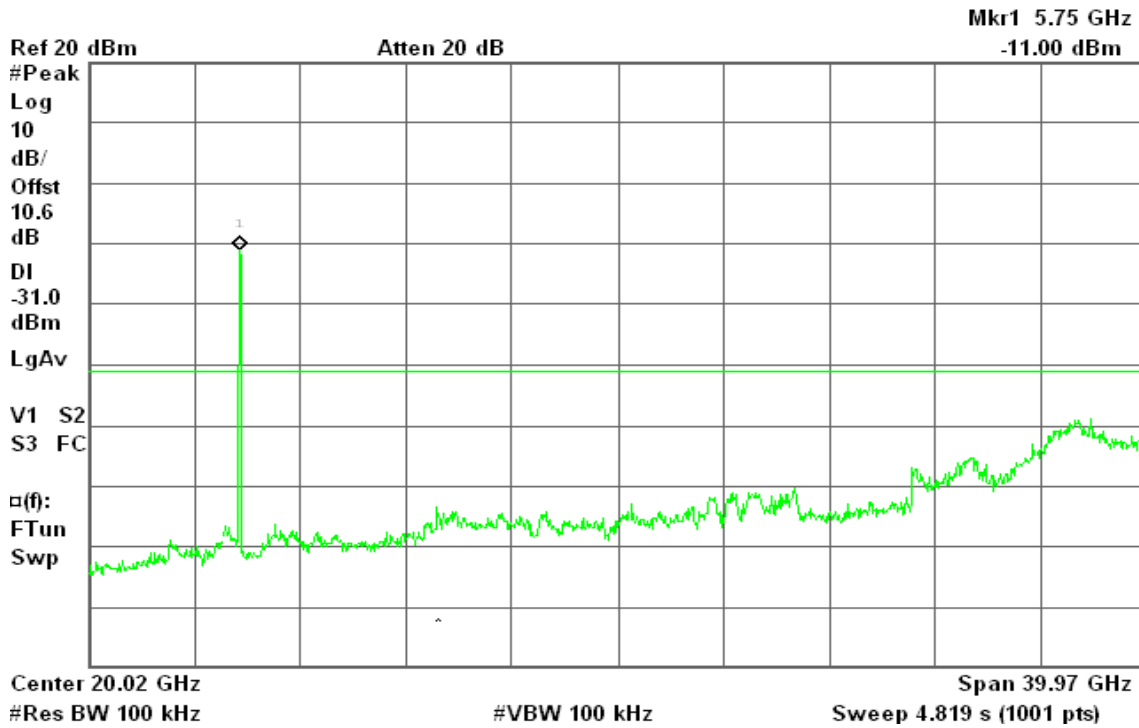

#### CH High

Agilent 22:24:21 Mar 2, 2011

R T

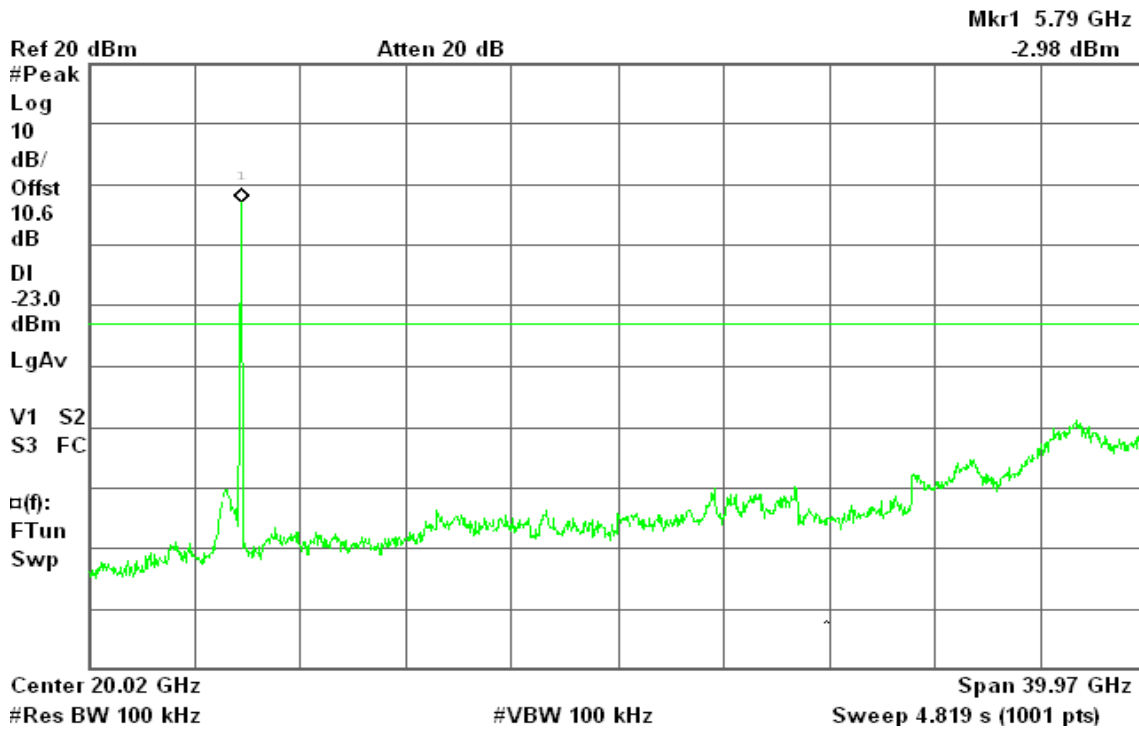





### IEEE 802.11n HT 20 MHz Channel mode with combiner

#### CH Low

Agilent 00:37:25 Mar 3, 2011

R T

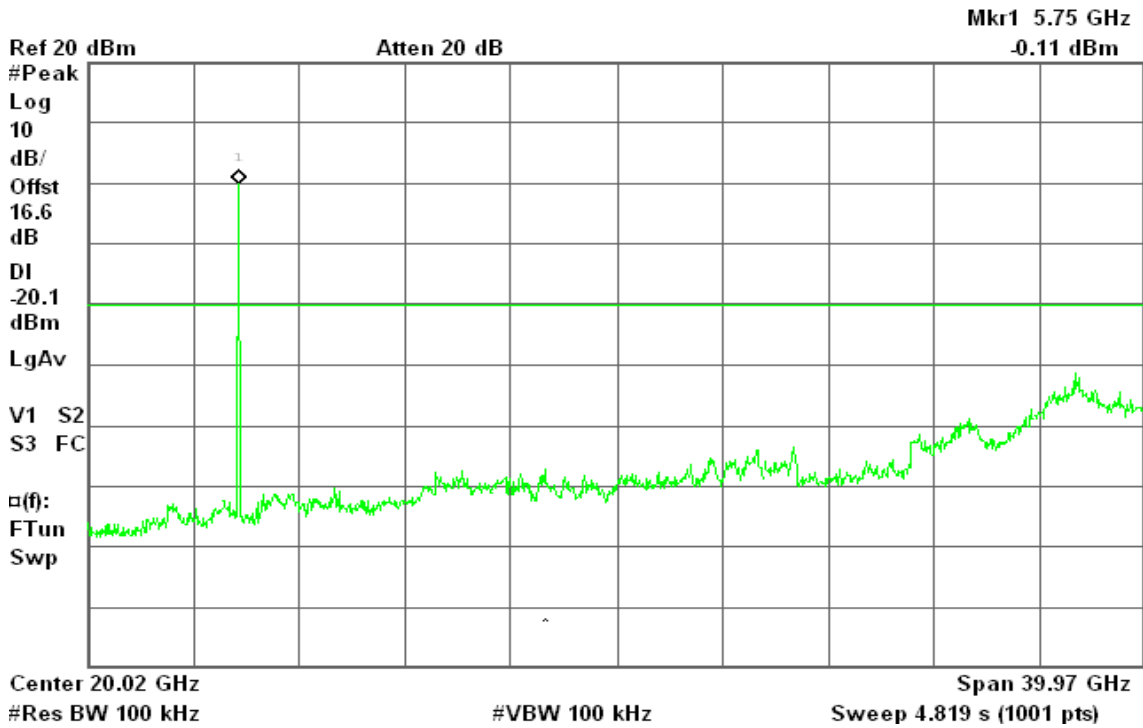

#### CH Mid

Agilent 00:33:46 Mar 3, 2011

R T

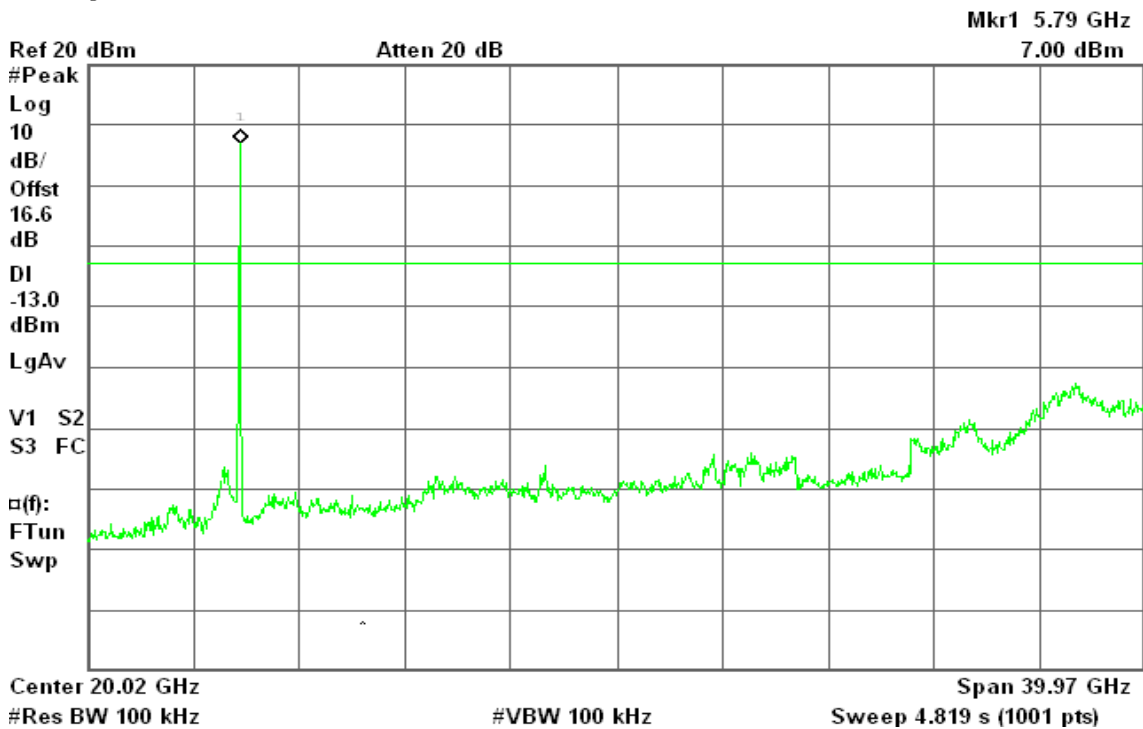





### CH High

Agilent 00:30:21 Mar 3, 2011

R T

Mkr1 5.83 GHz  
4.79 dBm

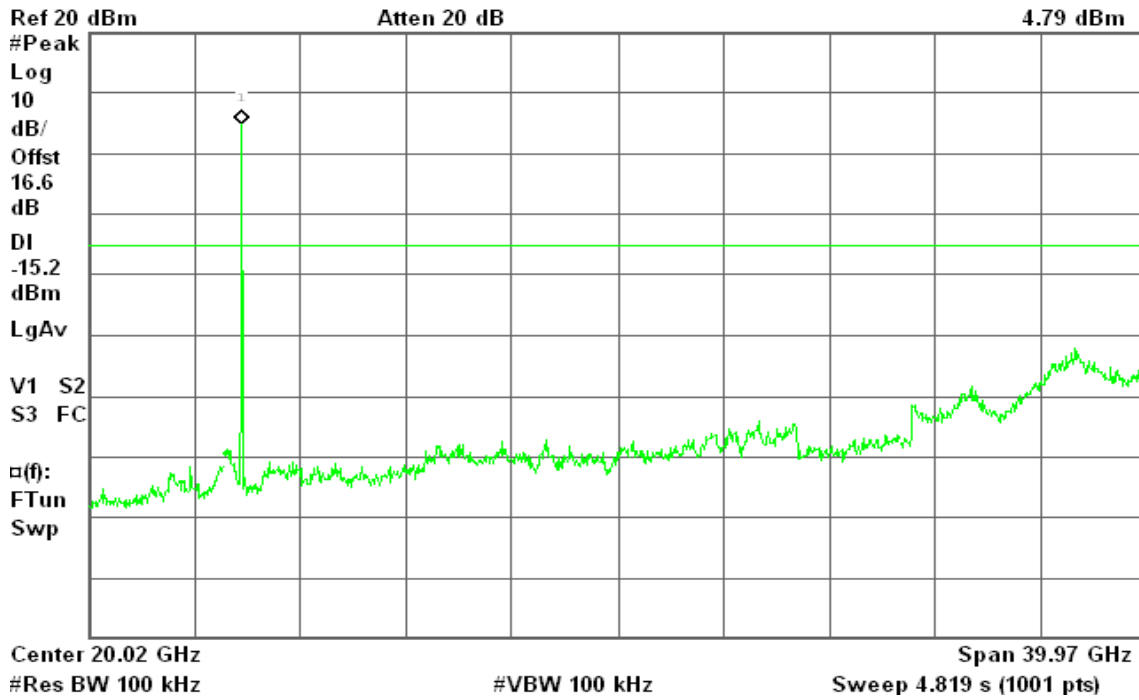



### IEEE 802.11n HT 40 MHz mode with combiner

#### CH Low

Agilent 00:18:37 Mar 3, 2011

R T

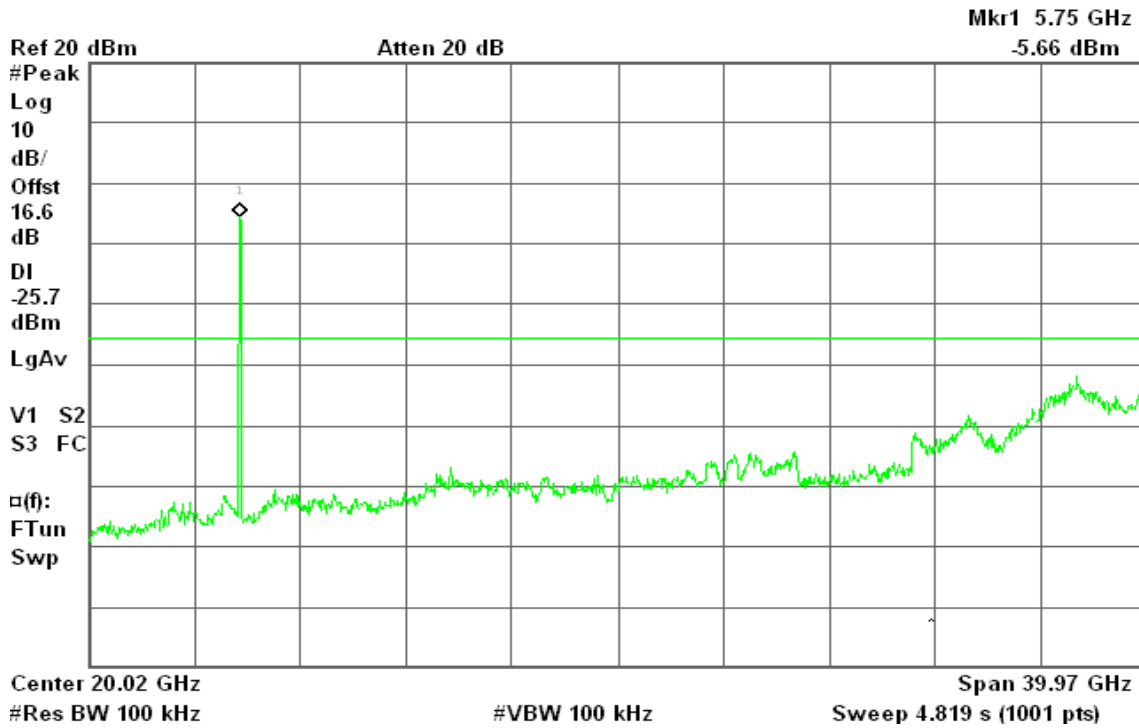

#### CH High

Agilent 00:22:32 Mar 3, 2011

R T

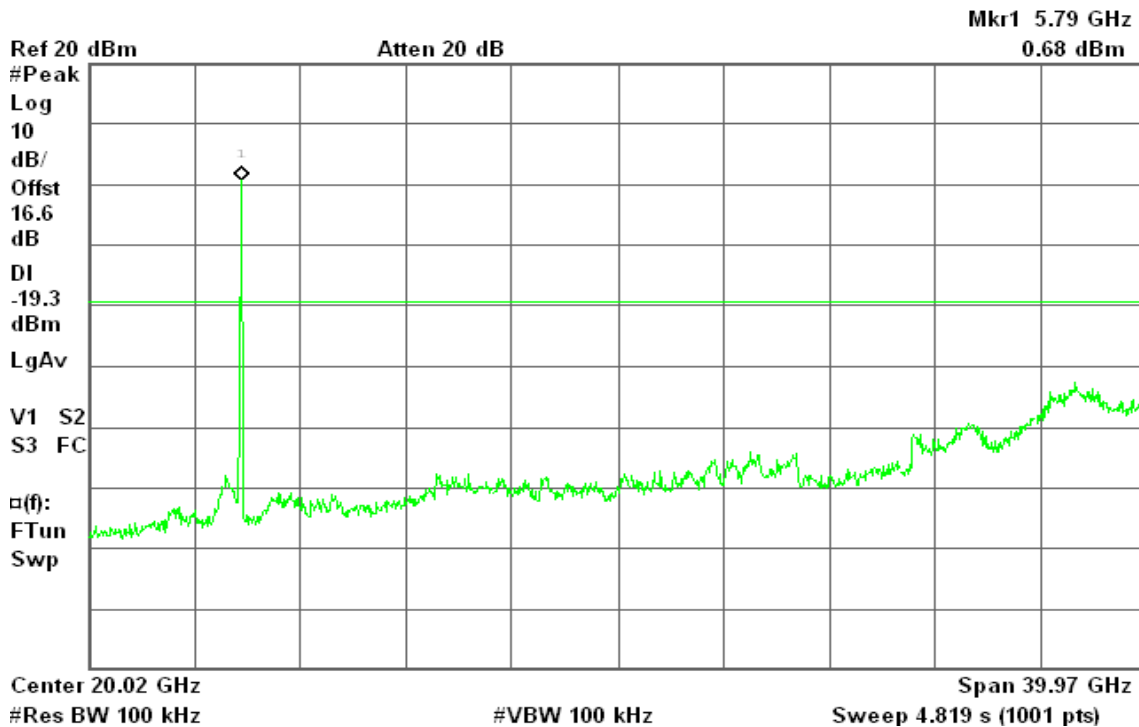



## 7.6.2 Radiated Emissions

### LIMIT

1. Except as provided elsewhere in this Subpart, the emissions from an intentional radiator shall not exceed the field strength levels specified in the following table:

Frequency (MHz)	Field Strength ( $\mu\text{V/m}$ )	Measurement Distance (m)
30-88	100*	3
88-216	150*	3
216-960	200*	3
Above 960	500	3

**Remark:** Except as provided in paragraph (g), fundamental emissions from intentional radiators operating under this Section shall not be located in the frequency bands 54-72 MHz, 76-88 MHz, 174-216 MHz or 470-806 MHz. However, operation within these frequency bands is permitted under other sections of this Part, e.g., Sections 15.231 and 15.241.

2. In the above emission table, the tighter limit applies at the band edges.

Frequency (MHz)	Field Strength ( $\mu\text{V/m}$ at 3-meter)	Field Strength (dB $\mu\text{V/m}$ at 3-meter)
30-88	100	40
88-216	150	43.5
216-960	200	46
Above 960	500	54



### Test Configuration

#### 9kHz ~ 30MHz

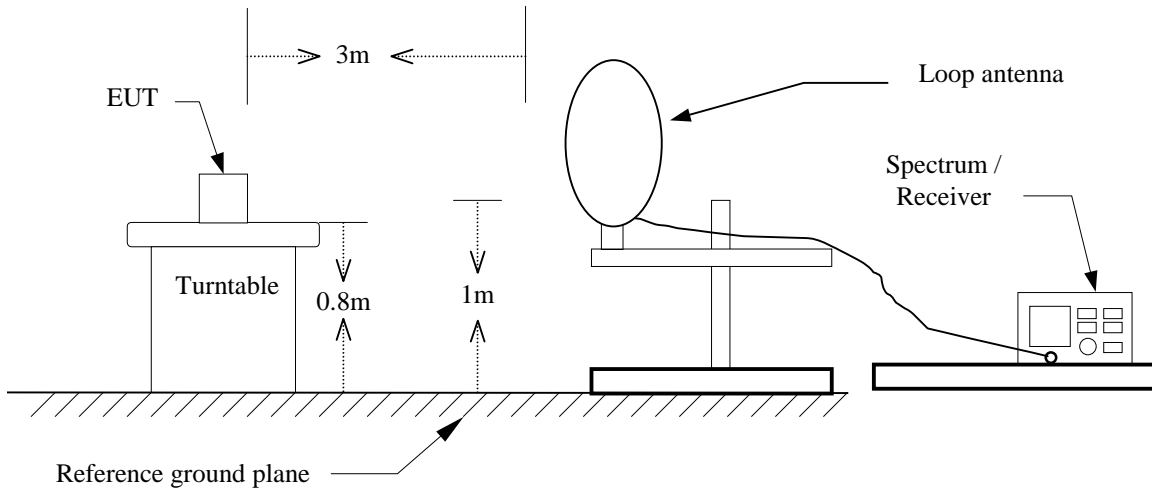

#### 30MHz ~ 1 GHz

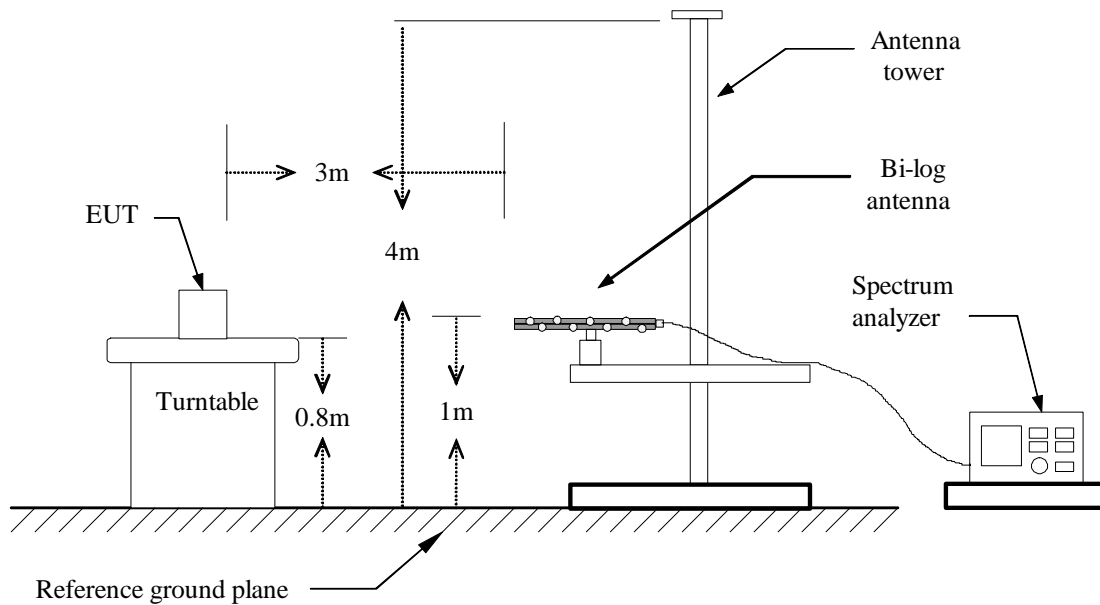



Above 1 GHz

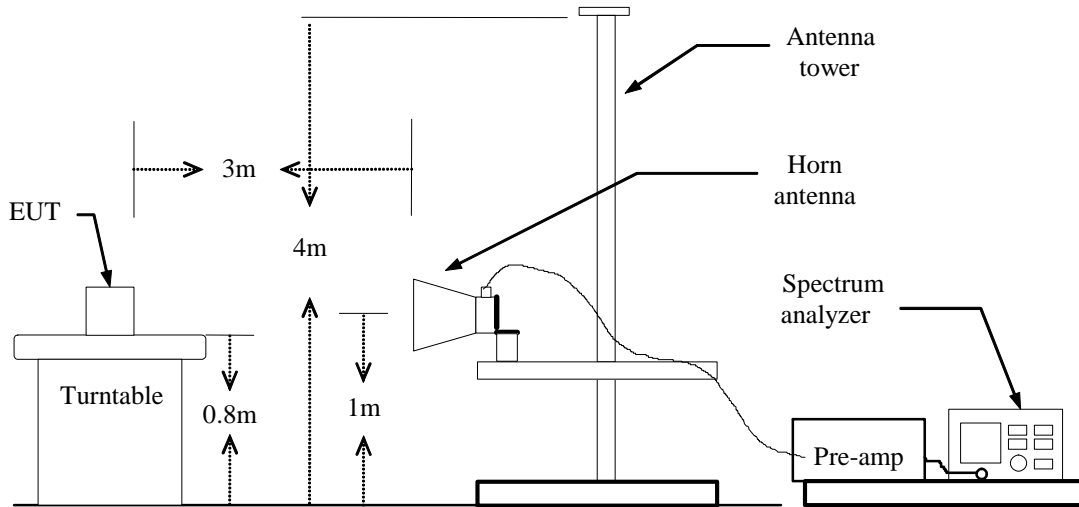



## **TEST PROCEDURE**

1. The EUT is placed on a turntable, which is 0.8m above ground plane.
2. The turntable shall be rotated for 360 degrees to determine the position of maximum emission level.
3. EUT is set 3m away from the receiving antenna, which is varied from 1m to 4m to find out the highest emissions.
4. Maximum procedure was performed on the six highest emissions to ensure EUT compliance.
5. And also, each emission was to be maximized by changing the polarization of receiving antenna both horizontal and vertical.
6. Set the spectrum analyzer in the following setting as:  
Below 1GHz:  
RBW=100kHz / VBW=300kHz / Sweep=AUTO  
Above 1GHz:  
(a) PEAK: RBW=VBW=1MHz / Sweep=AUTO  
(b) AVERAGE: RBW=1MHz / VBW=10Hz / Sweep=AUTO
7. Repeat above procedures until the measurements for all frequencies are complete.



**Below 1 GHz**

**Operation Mode:** Normal Link

**Test Date:** March 21, 2011

**Temperature:** 24°C

**Tested by:** Ali Shu

**Humidity:** 48% RH

**Polarity:** Ver. / Hor.

Frequency (MHz)	Reading (dBuV)	Correction Factor (dB/m)	Result (dBuV/m)	Limit (dBuV/m)	Margin (dB)	Remark	Ant.Pol. (H/V)
374.35	39.73	-7.58	32.15	46.00	-13.85	Peak	V
500.45	39.35	-5.14	34.21	46.00	-11.79	Peak	V
574.82	37.81	-4.27	33.54	46.00	-12.46	Peak	V
624.93	40.73	-3.48	37.26	46.00	-8.74	Peak	V
725.17	34.81	-2.18	32.63	46.00	-13.37	Peak	V
875.52	37.77	-0.73	37.03	46.00	-8.97	Peak	V
374.35	43.96	-7.58	36.37	46.00	-9.63	Peak	H
574.82	36.48	-4.27	32.21	46.00	-13.79	Peak	H
624.93	42.09	-3.48	38.61	46.00	-7.39	Peak	H
675.05	39.08	-2.71	36.36	46.00	-9.64	Peak	H
725.17	37.57	-2.18	35.39	46.00	-10.61	Peak	H
875.52	34.69	-0.73	33.95	46.00	-12.05	Peak	H

**Remark:**

1. Measuring frequencies from 30 MHz to the 1GHz.
2. Radiated emissions measured in frequency range from 30 MHz to 1000MHz were made with an instrument using peak/quasi-peak detector mode.
3. Quasi-peak test would be performed if the peak result were greater than the quasi-peak limit or as required by the applicant.
4. Data of measurement within this frequency range shown “ --- ” in the table above means the reading of emissions are attenuated more than 20dB below the permissible limits or the field strength is too small to be measured.
5. Measurements above show only up to 6 maximum emissions noted, or would be lesser, with “ N/A ” remark, if no specific emissions from the EUT are recorded (ie: margin>20dB from the applicable limit) and considered that's already beyond the background noise floor.
6. Margin (dB) = Remark result (dBuV/m) – Quasi-peak limit (dBuV/m).



**Above 1 GHz**

**Operation Mode:** Tx / IEEE 802.11a mode/ CH Low

**Test Date:** March 1, 2011

**Temperature:** 24°C

**Tested by:** Ali Shu

**Humidity:** 48% RH

**Polarity:** Ver. / Hor.

Frequency (MHz)	Reading (Peak) (dBuV)	Reading (Average) (dBuV)	Correction Factor (dB/m)	Result (Peak) (dBuV/m)	Result (Average) (dBuV/m)	Limit (Peak) (dBuV/m)	Limit (Average) (dBuV/m)	Margin (dB)	Remark	Ant. Pol. (H/V)
1060.00	60.16	---	-11.01	49.15	---	74.00	54.00	-4.85	Peak	V
1663.33	57.26	---	-8.89	48.37	---	74.00	54.00	-5.63	Peak	V
1996.67	54.20	---	-5.50	48.69	---	74.00	54.00	-5.31	Peak	V
2330.00	55.04	---	-4.57	50.47	---	74.00	54.00	-3.53	Peak	V
2496.67	54.97	---	-3.88	51.09	---	74.00	54.00	-2.91	Peak	V
2666.67	54.32	---	-3.30	51.02	---	74.00	54.00	-2.98	Peak	V
1306.67	57.76	---	-10.75	47.01	---	74.00	54.00	-6.99	Peak	H
1380.00	58.15	---	-10.67	47.47	---	74.00	54.00	-6.53	Peak	H
1666.67	54.85	---	-8.86	45.99	---	74.00	54.00	-8.01	Peak	H
2496.67	54.54	---	-3.88	50.66	---	74.00	54.00	-3.34	Peak	H
N/A										

**Remark:**

1. Measuring frequencies from 1 GHz to the 10th harmonic of highest fundamental frequency.
2. Radiated emissions measured in frequency above 1000MHz were made with an instrument using peak/average detector mode.
3. Average test would be performed if the peak result were greater than the average limit or as required by the applicant.
4. Data of measurement within this frequency range shown " --- " in the table above means the reading of emissions are attenuated more than 20dB below the permissible limits or the field strength is too small to be measured.
5. Measurements above show only up to 6 maximum emissions noted, or would be lesser, with " N/A " remark, if no specific emissions from the EUT are recorded (ie: margin>20dB from the applicable limit) and considered that's already beyond the background noise floor.
6. Margin (dB) = Remark result (dBuV/m) – Average limit (dBuV/m).





Operation Mode: Tx / IEEE 802.11a mode/ CH Mid

Test Date: March 1, 2011

Temperature: 24°C

Tested by: Ali Shu

Humidity: 48% RH

Polarity: Ver. / Hor.

Frequency (MHz)	Reading (Peak) (dBuV)	Reading (Average) (dBuV)	Correction Factor (dB/m)	Result (Peak) (dBuV/m)	Result (Average) (dBuV/m)	Limit (Peak) (dBuV/m)	Limit (Average) (dBuV/m)	Margin (dB)	Remark	Ant. Pol. (H/V)
1176.67	58.78	---	-10.89	47.89	---	74.00	54.00	-6.11	Peak	V
1380.00	59.56	---	-10.67	48.88	---	74.00	54.00	-5.12	Peak	V
1576.67	59.14	---	-9.77	49.37	---	74.00	54.00	-4.63	Peak	V
1666.67	58.90	---	-8.86	50.05	---	74.00	54.00	-3.95	Peak	V
2330.00	54.47	---	-4.57	49.91	---	74.00	54.00	-4.09	Peak	V
2666.67	54.60	---	-3.30	51.30	---	74.00	54.00	-2.70	Peak	V
1250.00	57.64	---	-10.81	46.83	---	74.00	54.00	-7.17	Peak	H
1500.00	58.55	---	-10.55	48.00	---	74.00	54.00	-6.00	Peak	H
1663.33	56.96	---	-8.89	48.07	---	74.00	54.00	-5.93	Peak	H
N/A										

**Remark:**

1. Measuring frequencies from 1 GHz to the 10th harmonic of highest fundamental frequency.
2. Radiated emissions measured in frequency above 1000MHz were made with an instrument using peak/average detector mode.
3. Average test would be performed if the peak result were greater than the average limit or as required by the applicant.
4. Data of measurement within this frequency range shown " --- " in the table above means the reading of emissions are attenuated more than 20dB below the permissible limits or the field strength is too small to be measured.
5. Measurements above show only up to 6 maximum emissions noted, or would be lesser, with " N/A " remark, if no specific emissions from the EUT are recorded (ie: margin > 20dB from the applicable limit) and considered that's already beyond the background noise floor.
6. Margin (dB) = Remark result (dBuV/m) – Average limit (dBuV/m).



Operation Mode: Tx / IEEE 802.11a mode/ CH High

Test Date: March 1, 2011

Temperature: 24°C

Tested by: Ali Shu

Humidity: 48% RH

Polarity: Ver. / Hor.

Frequency (MHz)	Reading (Peak) (dBuV)	Reading (Average) (dBuV)	Correction Factor (dB/m)	Result (Peak) (dBuV/m)	Result (Average) (dBuV/m)	Limit (Peak) (dBuV/m)	Limit (Average) (dBuV/m)	Margin (dB)	Remark	Ant. Pol. (H/V)
1333.33	58.80	---	-10.72	48.08	---	74.00	54.00	-5.92	Peak	V
1450.00	59.90	---	-10.60	49.30	---	74.00	54.00	-4.70	Peak	V
1500.00	56.44	---	-10.55	45.89	---	74.00	54.00	-8.11	Peak	V
1663.33	56.87	---	-8.89	47.98	---	74.00	54.00	-6.02	Peak	V
2330.00	53.53	---	-4.57	48.96	---	74.00	54.00	-5.04	Peak	V
2666.67	54.47	---	-3.30	51.17	---	74.00	54.00	-2.83	Peak	V
1330.00	58.86	---	-10.73	48.14	---	74.00	54.00	-5.86	Peak	H
1500.00	57.28	---	-10.55	46.73	---	74.00	54.00	-7.27	Peak	H
1663.33	55.83	---	-8.89	46.94	---	74.00	54.00	-7.06	Peak	H
N/A										

**Remark:**

1. Measuring frequencies from 1 GHz to the 10th harmonic of highest fundamental frequency.
2. Radiated emissions measured in frequency above 1000MHz were made with an instrument using peak/average detector mode.
3. Average test would be performed if the peak result were greater than the average limit or as required by the applicant.
4. Data of measurement within this frequency range shown " --- " in the table above means the reading of emissions are attenuated more than 20dB below the permissible limits or the field strength is too small to be measured.
5. Measurements above show only up to 6 maximum emissions noted, or would be lesser, with " N/A " remark, if no specific emissions from the EUT are recorded (ie: margin > 20dB from the applicable limit) and considered that's already beyond the background noise floor.
6. Margin (dB) = Remark result (dBuV/m) – Average limit (dBuV/m).



Operation Mode: TX / IEEE 802.11n HT 20 MHz Channel mode / CH Low

Test Date: March 1, 2011

Temperature: 24°C

Tested by: Ali Shu

Humidity: 48% RH

Polarity: Ver. / Hor.

Frequency (MHz)	Reading (Peak) (dBuV)	Reading (Average) (dBuV)	Correction Factor (dB/m)	Result (Peak) (dBuV/m)	Result (Average) (dBuV/m)	Limit (Peak) (dBuV/m)	Limit (Average) (dBuV/m)	Margin (dB)	Remark	Ant. Pol. (H/V)
1283.33	60.85	---	-10.78	50.08	---	74.00	54.00	-3.92	Peak	V
1380.00	58.84	---	-10.67	48.16	---	74.00	54.00	-5.84	Peak	V
1666.67	58.37	---	-8.86	49.51	---	74.00	54.00	-4.49	Peak	V
2663.33	54.21	---	-3.31	50.89	---	74.00	54.00	-3.11	Peak	V
N/A										
1250.00	57.85	---	-10.81	47.04	---	74.00	54.00	-6.96	Peak	H
1496.67	57.32	---	-10.55	46.76	---	74.00	54.00	-7.24	Peak	H
1663.33	57.30	---	-8.89	48.41	---	74.00	54.00	-5.59	Peak	H
N/A										

**Remark:**

1. Measuring frequencies from 1 GHz to the 10th harmonic of highest fundamental frequency.
2. Radiated emissions measured in frequency above 1000MHz were made with an instrument using peak/average detector mode.
3. Average test would be performed if the peak result were greater than the average limit or as required by the applicant.
4. Data of measurement within this frequency range shown " --- " in the table above means the reading of emissions are attenuated more than 20dB below the permissible limits or the field strength is too small to be measured.
5. Measurements above show only up to 6 maximum emissions noted, or would be lesser; with " N/A " remark, if no specific emissions from the EUT are recorded (ie: margin>20dB from the applicable limit) and considered that's already beyond the background noise floor.
6. Margin (dB) = Remark result (dBuV/m) – Average limit (dBuV/m).



**Operation Mode:** TX / IEEE 802.11n HT 20 MHz Channel mode / CH Mid  
**Temperature:** 24°C  
**Humidity:** 48% RH

**Test Date:** March 1, 2011  
**Tested by:** Ali Shu  
**Polarity:** Ver. / Hor.

Frequency (MHz)	Reading (Peak) (dBuV)	Reading (Average) (dBuV)	Correction Factor (dB/m)	Result (Peak) (dBuV/m)	Result (Average) (dBuV/m)	Limit (Peak) (dBuV/m)	Limit (Average) (dBuV/m)	Margin (dB)	Remark	Ant. Pol. (H/V)
1173.33	58.51	---	-10.89	47.62	---	74.00	54.00	-6.38	Peak	V
1330.00	60.50	---	-10.73	49.77	---	74.00	54.00	-4.23	Peak	V
1663.33	58.66	---	-8.89	49.77	---	74.00	54.00	-4.23	Peak	V
2330.00	54.06	---	-4.57	49.49	---	74.00	54.00	-4.51	Peak	V
2500.00	52.99	---	-3.87	49.12	---	74.00	54.00	-4.88	Peak	V
2663.33	54.21	---	-3.31	50.89	---	74.00	54.00	-3.11	Peak	V
1250.00	57.46	---	-10.81	46.65	---	74.00	54.00	-7.35	Peak	H
1310.00	60.31	---	-10.75	49.56	---	74.00	54.00	-4.44	Peak	H
1500.00	56.63	---	-10.55	46.08	---	74.00	54.00	-7.92	Peak	H
1663.33	57.06	---	-8.89	48.17	---	74.00	54.00	-5.83	Peak	H
N/A										

**Remark:**

1. Measuring frequencies from 1 GHz to the 10th harmonic of highest fundamental frequency.
2. Radiated emissions measured in frequency above 1000MHz were made with an instrument using peak/average detector mode.
3. Average test would be performed if the peak result were greater than the average limit or as required by the applicant.
4. Data of measurement within this frequency range shown " --- " in the table above means the reading of emissions are attenuated more than 20dB below the permissible limits or the field strength is too small to be measured.
5. Measurements above show only up to 6 maximum emissions noted, or would be lesser, with " N/A " remark, if no specific emissions from the EUT are recorded (ie: margin>20dB from the applicable limit) and considered that's already beyond the background noise floor.
6. Margin (dB) = Remark result (dBuV/m) – Average limit (dBuV/m).



Operation Mode: TX / IEEE 802.11n HT 20 MHz Channel mode / CH High

Test Date: March 1, 2011

Temperature: 24°C

Tested by: Ali Shu

Humidity: 48% RH

Polarity: Ver. / Hor.

Frequency (MHz)	Reading (Peak) (dBuV)	Reading (Average) (dBuV)	Correction Factor (dB/m)	Result (Peak) (dBuV/m)	Result (Average) (dBuV/m)	Limit (Peak) (dBuV/m)	Limit (Average) (dBuV/m)	Margin (dB)	Remark	Ant. Pol. (H/V)
1213.33	59.79	---	-10.85	48.94	---	74.00	54.00	-5.06	Peak	V
1283.33	59.29	---	-10.78	48.52	---	74.00	54.00	-5.48	Peak	V
1586.67	59.16	---	-9.67	49.49	---	74.00	54.00	-4.51	Peak	V
1663.33	59.16	---	-8.89	50.27	---	74.00	54.00	-3.73	Peak	V
2666.67	53.97	---	-3.30	50.67	---	74.00	54.00	-3.33	Peak	V
1126.67	55.68	---	-10.94	44.74	---	74.00	54.00	-9.26	Peak	H
1250.00	58.01	---	-10.81	47.20	---	74.00	54.00	-6.80	Peak	H
1663.33	56.58	---	-8.89	47.69	---	74.00	54.00	-6.31	Peak	H
N/A										

**Remark:**

1. Measuring frequencies from 1 GHz to the 10th harmonic of highest fundamental frequency.
2. Radiated emissions measured in frequency above 1000MHz were made with an instrument using peak/average detector mode.
3. Average test would be performed if the peak result were greater than the average limit or as required by the applicant.
4. Data of measurement within this frequency range shown " --- " in the table above means the reading of emissions are attenuated more than 20dB below the permissible limits or the field strength is too small to be measured.
5. Measurements above show only up to 6 maximum emissions noted, or would be lesser; with " N/A " remark, if no specific emissions from the EUT are recorded (ie: margin>20dB from the applicable limit) and considered that's already beyond the background noise floor.
6. Margin (dB) = Remark result (dBuV/m) – Average limit (dBuV/m).



**Operation Mode:** TX / IEEE 802.11n HT 40 MHz mode  
/ CH Low

**Temperature:** 24°C

**Humidity:** 48% RH

**Test Date:** March 1, 2011

**Tested by:** Ali Shu

**Polarity:** Ver. / Hor.

Frequency (MHz)	Reading (Peak) (dBuV)	Reading (Average) (dBuV)	Correction Factor (dB/m)	Result (Peak) (dBuV/m)	Result (Average) (dBuV/m)	Limit (Peak) (dBuV/m)	Limit (Average) (dBuV/m)	Margin (dB)	Remark	Ant. Pol. (H/V)
1306.67	61.46	---	-10.75	50.71	---	74.00	54.00	-3.29	Peak	V
1376.67	60.50	---	-10.68	49.82	---	74.00	54.00	-4.18	Peak	V
1666.67	57.43	---	-8.86	48.57	---	74.00	54.00	-5.43	Peak	V
2326.67	54.57	---	-4.58	49.99	---	74.00	54.00	-4.01	Peak	V
2666.67	53.76	---	-3.30	50.46	---	74.00	54.00	-3.54	Peak	V
N/A										
1250.00	58.28	---	-10.81	47.47	---	74.00	54.00	-6.53	Peak	H
1500.00	57.07	---	-10.55	46.52	---	74.00	54.00	-7.48	Peak	H
1663.33	56.63	---	-8.89	47.74	---	74.00	54.00	-6.26	Peak	H
2326.67	53.72	---	-4.58	49.14	---	74.00	54.00	-4.86	Peak	H
N/A										

**Remark:**

1. Measuring frequencies from 1 GHz to the 10th harmonic of highest fundamental frequency.
2. Radiated emissions measured in frequency above 1000MHz were made with an instrument using peak/average detector mode.
3. Average test would be performed if the peak result were greater than the average limit or as required by the applicant.
4. Data of measurement within this frequency range shown " --- " in the table above means the reading of emissions are attenuated more than 20dB below the permissible limits or the field strength is too small to be measured.
5. Measurements above show only up to 6 maximum emissions noted, or would be lesser; with " N/A " remark, if no specific emissions from the EUT are recorded (ie: margin > 20dB from the applicable limit) and considered that's already beyond the background noise floor.
6. Margin (dB) = Remark result (dBuV/m) – Average limit (dBuV/m).



Operation Mode: TX / IEEE 802.11n HT 40 MHz mode / CH High

Test Date: March 1, 2011

Temperature: 24°C

Tested by: Ali Shu

Humidity: 48% RH

Polarity: Ver. / Hor.

Frequency (MHz)	Reading (Peak) (dBuV)	Reading (Average) (dBuV)	Correction Factor (dB/m)	Result (Peak) (dBuV/m)	Result (Average) (dBuV/m)	Limit (Peak) (dBuV/m)	Limit (Average) (dBuV/m)	Margin (dB)	Remark	Ant. Pol. (H/V)
1303.33	58.49	---	-10.75	47.74	---	74.00	54.00	-6.26	Peak	V
1376.67	60.21	---	-10.68	49.54	---	74.00	54.00	-4.46	Peak	V
1560.00	58.85	---	-9.94	48.91	---	74.00	54.00	-5.09	Peak	V
1666.67	58.47	---	-8.86	49.62	---	74.00	54.00	-4.38	Peak	V
2330.00	54.52	---	-4.57	49.96	---	74.00	54.00	-4.04	Peak	V
2663.33	54.10	---	-3.31	50.78	---	74.00	54.00	-3.22	Peak	V
1263.33	59.43	---	-10.80	48.63	---	74.00	54.00	-5.37	Peak	H
1496.67	58.23	---	-10.55	47.68	---	74.00	54.00	-6.32	Peak	H
1666.67	57.50	---	-8.86	48.64	---	74.00	54.00	-5.36	Peak	H
N/A										

**Remark:**

1. Measuring frequencies from 1 GHz to the 10th harmonic of highest fundamental frequency.
2. Radiated emissions measured in frequency above 1000MHz were made with an instrument using peak/average detector mode.
3. Average test would be performed if the peak result were greater than the average limit or as required by the applicant.
4. Data of measurement within this frequency range shown " --- " in the table above means the reading of emissions are attenuated more than 20dB below the permissible limits or the field strength is too small to be measured.
5. Measurements above show only up to 6 maximum emissions noted, or would be lesser; with " N/A " remark, if no specific emissions from the EUT are recorded (ie: margin>20dB from the applicable limit) and considered that's already beyond the background noise floor.
6. Margin (dB) = Remark result (dBuV/m) – Average limit (dBuV/m).



## 7.7 POWERLINE CONDUCTED EMISSIONS

### LIMIT

According to §15.207(a), except as shown in paragraphs (b) and (c) of this section, for an intentional radiator that is designed to be connected to the public utility (AC) power line, the radio frequency voltage that is conducted back onto the AC power line on any frequency or frequencies within the band 150 kHz to 30 MHz shall not exceed the limits in the following table, as measured using a 50  $\mu$ H/50 ohms line impedance stabilization network (LISN). Compliance with the provisions of this paragraph shall be based on the measurement of the radio frequency voltage between each power line and ground at the power terminal. The lower limit applies at the boundary between the frequency ranges.

Frequency Range (MHz)	Limits (dB $\mu$ V)	
	Quasi-peak	Average
0.15 to 0.50	66 to 56*	56 to 46*
0.50 to 5	56	46
5 to 30	60	50

\* Decreases with the logarithm of the frequency.

### Test Configuration

See test photographs attached in Appendix 1 for the actual connections between EUT and support equipment.

### TEST PROCEDURE

1. The EUT was placed on a table, which is 0.8m above ground plane.
2. Maximum procedure was performed on the six highest emissions to ensure EUT compliance.
3. Repeat above procedures until all frequency measured were complete.

### TEST RESULTS

The initial step in collecting conducted data is a spectrum analyzer peak scan of the measurement range. Significant peaks are then marked as shown on the following data page, and these signals are then quasi-peaked.





**Test Data**

EUT:802.11a/b/g/n Router & Access Point

Power: 120V/60Hz

M/N:BR51N1

Test mode: Normal Operation

POL: NEUTRAL

Temp.: 22

Humidity: 55%

ENGINEER : Shiang.Su

REMARK1:

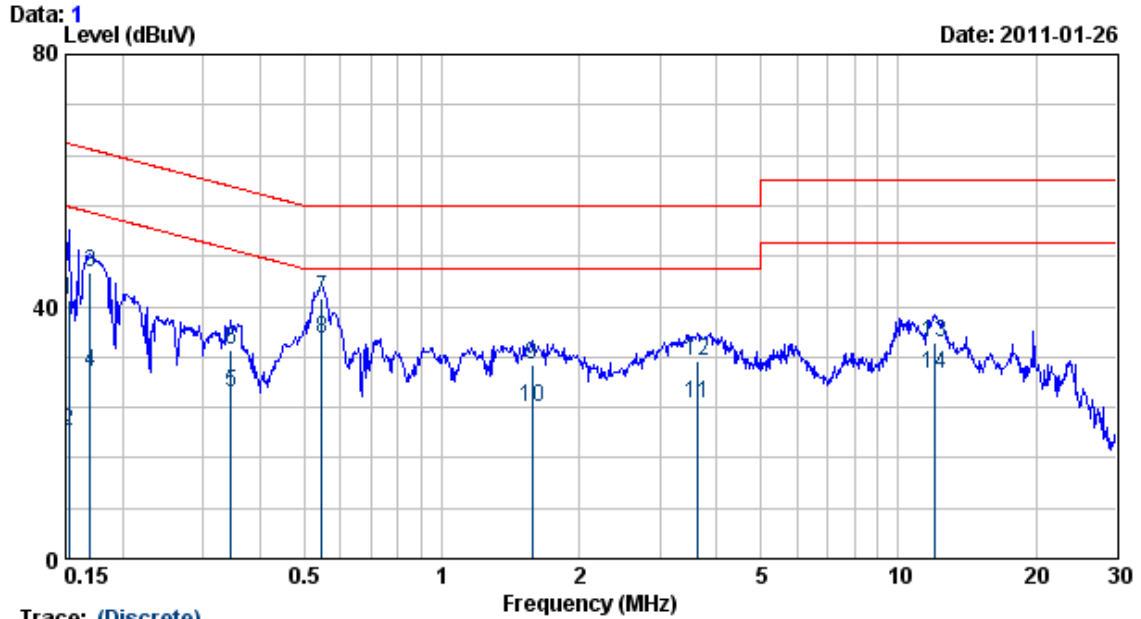

Trace: (Discrete)

Freq. MHz	LISN Factor dB	Cable Loss dB	Meter Reading dBuV	Measured Level dBuV	Limits dBuV	Over Limits dBuV	Detector
0.152	8.64	0.01	32.49	41.14	65.87	-24.73	QP
0.152	8.64	0.01	11.55	20.20	55.87	-35.67	AVERAGE
0.169	8.64	0.01	36.65	45.30	64.99	-19.68	QP
0.169	8.64	0.01	20.81	29.46	54.99	-25.52	AVERAGE
0.345	8.65	0.01	17.65	26.31	49.09	-22.78	AVERAGE
0.345	8.65	0.01	24.35	33.01	59.09	-26.08	QP
0.546	8.65	0.02	32.62	41.29	56.00	-14.71	QP
0.546	8.65	0.02	26.22	34.89	46.00	-11.11	AVERAGE
1.577	8.63	0.02	22.13	30.78	56.00	-25.22	QP
1.577	8.63	0.02	15.24	23.89	46.00	-22.11	AVERAGE
3.642	8.69	0.02	15.91	24.62	46.00	-21.38	AVERAGE
3.642	8.69	0.02	22.59	31.30	56.00	-24.70	QP
12.060	8.86	0.09	25.44	34.40	60.00	-25.60	QP
12.060	8.86	0.09	20.23	29.19	50.00	-20.81	AVERAGE

REMARKS: 1. Level(dBuV)=Read Level(dBuV)+LISN Factor(dB)+Cable loss(dB)  
 2. Over Limit value(dB)=Level(dBuV)-Limit Line(dBuV)



EUT:802.11a/b/g/n Router & Access Point

Power: 120V/60Hz

M/N:BR51N1

Test mode: Normal Operation

POL: LINE

Temp.: 22

Humidity: 55%

ENGINEER : Shiang.Su

REMARK1:

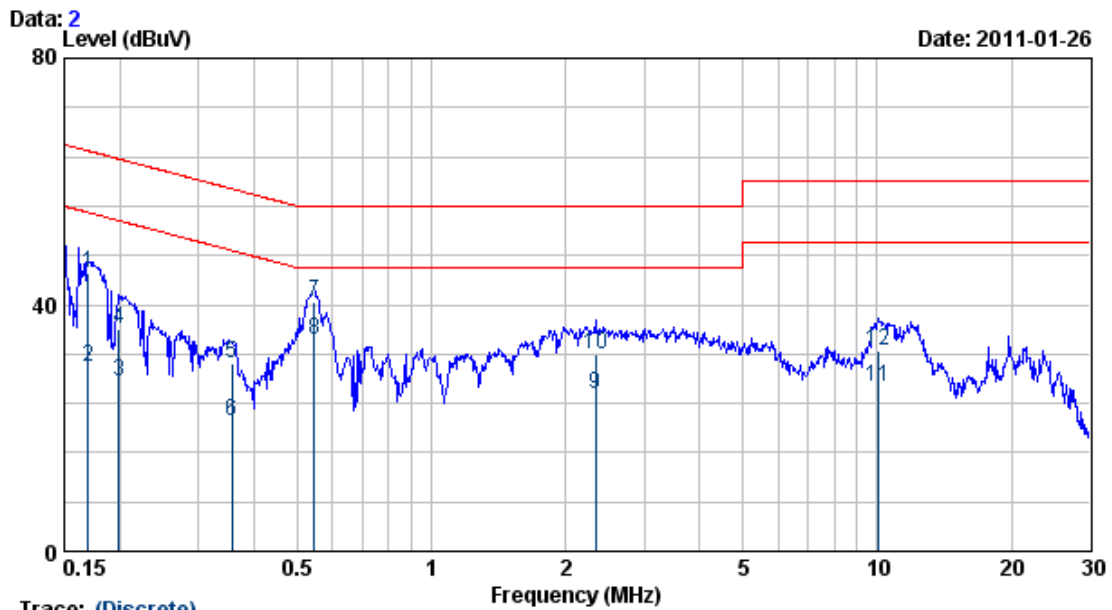

Freq. MHz	LISN Factor dB	Cable Loss dB	Meter Reading dBuV	Measured Level dBuV	Limits dBuV	Over Limits dBuV	Detector
0.169	8.64	0.01	36.62	45.27	64.99	-19.71	QP
0.169	8.64	0.01	21.11	29.76	54.99	-25.22	AVERAGE
0.199	8.65	0.01	18.81	27.47	53.67	-26.20	AVERAGE
0.199	8.65	0.01	27.28	35.94	63.67	-27.73	QP
0.358	8.65	0.01	21.68	30.34	58.78	-28.44	QP
0.358	8.65	0.01	12.51	21.17	48.78	-27.61	AVERAGE
0.546	8.65	0.02	31.84	40.51	56.00	-15.49	QP
0.546	8.65	0.02	25.70	34.37	46.00	-11.63	AVERAGE
2.334	8.64	0.02	16.94	25.60	46.00	-20.40	AVERAGE
2.334	8.64	0.02	23.39	32.05	56.00	-23.95	QP
10.019	8.91	0.06	17.57	26.54	50.00	-23.46	AVERAGE
10.019	8.91	0.06	23.57	32.54	60.00	-27.46	QP

REMARKS: 1.Level(dBuV)=Read Level(dBuV)+LISN Factor(dB)+Cable loss(dB)  
 2.Over Limit value(dB)=Level(dBuV)-Limit Line(dBuV)



# APPENDIX I RADIO FREQUENCY EXPOSURE

## LIMIT

According to §15.247(i), systems operating under the provisions of this section shall be operated in a manner that ensures that the public is not exposed to radio frequency energy levels in excess of the Commission's guidelines. See § 1.1307(b)(1) of this chapter.

## EUT Specification

<b>EUT</b>	Wireless Hotspot Gateway / Enterprise Access Point
<b>Frequency band (Operating)</b>	<input type="checkbox"/> WLAN: 2.412GHz ~ 2.462GHz <input checked="" type="checkbox"/> WLAN: 5.725GHz ~ 5.850GHz <input type="checkbox"/> Others: <u>Bluetooth: 2.402GHz ~ 2.480GHz</u>
<b>Device category</b>	<input type="checkbox"/> Portable (<20cm separation) <input checked="" type="checkbox"/> Mobile (>20cm separation) <input type="checkbox"/> Others
<b>Exposure classification</b>	<input type="checkbox"/> Occupational/Controlled exposure (S = 5mW/cm2) <input checked="" type="checkbox"/> General Population/Uncontrolled exposure (S=1mW/cm2)
<b>Antenna diversity</b>	<input type="checkbox"/> Single antenna <input checked="" type="checkbox"/> Multiple antennas <input type="checkbox"/> Tx diversity <input type="checkbox"/> Rx diversity <input checked="" type="checkbox"/> Tx/Rx diversity
<b>Max. output power</b>	IEEE 802.11a mode: 23.97 dBm (249.45 mW) IEEE 802.11n HT 20 MHz mode: 25.12 dBm (325.08 mW) IEEE 802.11n HT 40 MHz mode: 25.24 dBm (334.19 mW)
<b>Antenna gain (Max)</b>	5 dBi (Numeric gain: 3.16)
	MIMO Mode: 5 dBi + 10 log (3) = 9.7 dBi (Numeric gain: 9.3)
<b>Evaluation applied</b>	<input checked="" type="checkbox"/> MPE Evaluation* <input type="checkbox"/> SAR Evaluation <input type="checkbox"/> N/A
<b>Remark:</b>	
1. The maximum output power is <u>25.24dBm (33.45mW)</u> at <u>5795MHz</u> (with <u>9.3 numeric antenna gain.</u> ) 2. DTS device is not subject to routine RF evaluation; MPE estimate is used to justify the compliance.	

## TEST RESULTS

No non-compliance noted.



**Calculation**

Given  $E = \frac{\sqrt{30 \times P \times G}}{d}$  &  $S = \frac{E^2}{3770}$

Where  $E =$  Field strength in Volts / meter

$P =$  Power in Watts

$G =$  Numeric antenna gain

$d =$  Distance in meters

$S =$  Power density in milliwatts / square centimeter

Combining equations and re-arranging the terms to express the distance as a function of the remaining variables yields:

$$S = \frac{30 \times P \times G}{3770d^2}$$

Changing to units of mW and cm, using:

$$P (mW) = P (W) / 1000 \text{ and}$$

$$d (cm) = d(m) / 100$$

Yields

$$S = \frac{30 \times (P/1000) \times G}{3770 \times (d/100)^2} = 0.0796 \times \frac{P \times G}{d^2} \quad \text{Equation 1}$$

Where  $d =$  Distance in cm

$P =$  Power in mW

$G =$  Numeric antenna gain

$S =$  Power density in mW / cm<sup>2</sup>



### Maximum Permissible Exposure

#### **IEEE 802.11a mode:**

EUT output power = 249.45mW

Numeric Antenna gain = 3.16

Substituting the MPE safe distance using  $d = 20$  cm into Equation 1:

Yields

$$S = 0.000199 \times P \times G$$

Where  $P =$  Power in mW

$G =$  Numeric antenna gain

$S =$  Power density in mW / cm<sup>2</sup>

→ Power density = 0.156864 mW / cm<sup>2</sup>

#### **IEEE 802.11n HT 20 MHz mode:**

EUT output power = 325.08mW

Numeric Antenna gain = 9.3

Substituting the MPE safe distance using  $d = 20$  cm into Equation 1:

Yields

$$S = 0.000199 \times P \times G$$

Where  $P =$  Power in mW

$G =$  Numeric antenna gain

$S =$  Power density in mW / cm<sup>2</sup>

→ Power density = 0.6016mW / cm<sup>2</sup>

#### **IEEE 802.11n HT 40 MHz mode:**

EUT output power = 334.19mW

Numeric Antenna gain = 9.3

Substituting the MPE safe distance using  $d = 20$  cm into Equation 1:

Yields

$$S = 0.000199 \times P \times G$$

Where  $P =$  Power in mW

$G =$  Numeric antenna gain

$S =$  Power density in mW / cm<sup>2</sup>

→ Power density = 0.6185 mW / cm<sup>2</sup>

(For mobile or fixed location transmitters, the maximum power density is 1.0 mW/cm<sup>2</sup> even if the calculation indicates that the power density would be larger.)