



FCC 47 CFR PART 15 SUBPART C AND ANSI C63.4: 2003

TEST REPORT

For

Wireless Hotspot Gateway / Enterprise Access Point

Trade Name / Model:

Brand	Model	Product Description
4ipnet	EAP300	Enterprise Access Point
4ipnet	EAP305	Enterprise Access Point
4ipnet	EAP306	Enterprise Access Point
4ipnet	HSG300	Wireless Hotspot Gateway
Cipherium	A600	Enterprise Access Point
Cipherium	W1160	Wireless Hotspot Gateway
USC	A600	Enterprise Access Point
USC	W1160	Wireless Hotspot Gateway

Issued for

4IPNET, INC.

3F-3, No. 369, Fusing N. Rd., Taipei 105, Taiwan, R.O.C.

Issued by

Compliance Certification Services Inc.

Tainan Lab.

No. 8, Jiu Ceng Ling, Jiaokeng Village, Sinhua Township, Tainan Hsien 712, Taiwan (R.O.C.)

TEL: 886-6-580-2201

FAX: 886-6-580-2202

Date of Issue: March 14, 2011



Note: This report shall not be reproduced except in full, without the written approval of Compliance Certification Services Inc. Ltd. This document may be altered or revised by Compliance Certification Services Inc. personnel only, and shall be noted in the revision section of the document.



REVISION HISTORY

Rev.	Issue Date	Revisions	Effect Page	Revised By
00	March 14, 2011	Initial Issue	ALL	Sunny.Chang



TABLE OF CONTENTS

1. TEST REPORT CERTIFICATION4

2. EUT DESCRIPTION5

 2.1 DESCRIPTION OF EUT & POWER 5

3. DESCRIPTION OF TEST MODES7

4. TEST METHODOLOGY8

5. FACILITIES AND ACCREDITATIONS.....8

 5.1 FACILITIES..... 8

 5.2 EQUIPMENT..... 8

 5.3 LABORATORY ACCREDITATIONS LISTINGS 8

 5.4 TABLE OF ACCREDITATIONS AND LISTINGS 9

6. CALIBRATION AND UNCERTAINTY 10

 6.1 MEASURING INSTRUMENT CALIBRATION..... 10

 6.2 MEASUREMENT UNCERTAINTY 10

7. SETUP OF EQUIPMENT UNDER TEST..... 11

 7.1 SETUP CONFIGURATION OF EUT..... 11

 7.2 SUPPORT EQUIPMENT 12

 7.3 EUT OPERATING CONDITION 13

8. APPLICABLE LIMITS AND TEST RESULTS..... 14

 8.1 6DB BANDWIDTH 14

 8.2 MAXIMUM PEAK OUTPUT POWER..... 29

 8.3 MAXIMUM PERMISSIBLE EXPOSURE..... 37

 8.4 POWER SPECTRAL DENSITY 39

 8.5 CONDUCTED SPURIOUS EMISSION..... 62

 8.6 RADIATED EMISSIONS 99

 8.7 POWERLINE CONDUCTED EMISSIONS 145

9. ANTENNA REQUIREMENT 149

 9.1 STANDARD APPLICABLE 149

 9.2 ANTENNA CONNECTED CONSTRUCTION 149

APPENDIX I SETUP PHOTOS 150

APPENDIX II PHOTOGRAPHS OF EUT.....A1



1. TEST REPORT CERTIFICATION

Applicant : 4IPNET, INC.

Address : 3F-3, No. 369, Fusing N. Rd., Taipei 105, Taiwan, R.O.C.

Equipment Under Test : Wireless Hotspot Gateway / Enterprise Access Point

Trade Name / Model :

Brand	Model	Product Description
4ipnet	EAP300	Enterprise Access Point
4ipnet	EAP305	Enterprise Access Point
4ipnet	EAP308	Enterprise Access Point
4ipnet	HSG300	Wireless Hotspot Gateway
Cipherium	A800	Enterprise Access Point
Cipherium	W1160	Wireless Hotspot Gateway
USC	A800	Enterprise Access Point
USC	W1160	Wireless Hotspot Gateway

Date of Test : September 20, 2010 ~ March 03, 2011

APPLICABLE STANDARD	
STANDARD	TEST RESULT
FCC Part 15 Subpart C AND ANSI C63.4 : 2003	No non-compliance noted

Approved by:

Jeter Wu
Assistant Manager

Reviewed by:

Eric Huang
Assistant Section Manager



2. EUT DESCRIPTION

2.1 DESCRIPTION OF EUT & POWER

Product Name	Wireless Hotspot Gateway / Enterprise Access Point		
Brand Name / Model Name	Brand	Model	Product Description
	4ipnet	EAP300	Enterprise Access Point
	4ipnet	EAP305	Enterprise Access Point
	4ipnet	EAP306	Enterprise Access Point
	4ipnet	HSG300	Wireless Hotspot Gateway
	Cipherium	A600	Enterprise Access Point
	Cipherium	W1160	Wireless Hotspot Gateway
	USC	A600	Enterprise Access Point
	USC	W1160	Wireless Hotspot Gateway
Frequency Range	IEEE 802.11b/g, 802.11n HT20 (DTS Band):2412MHz ~ 2462MHz IEEE 802.11n HT40 (DTS Band):2422MHz ~ 2452MHz		
Transmit Power	IEEE 802.11b Mode : 16.57dBm (DTS Band) (45.3942 mW) IEEE 802.11g Mode : 22.43dBm (DTS Band) (174.985 mW) IEEE 802.11n HT20 Mode : 22.74dBm (DTS Band) (187.771 mW) IEEE 802.11n HT40 Mode : 22.54dBm (DTS Band) (179.318 mW)		
Channel Spacing	IEEE 802.11b/g, 802.11n HT20/HT40: 5MHz		
Channel Number	IEEE 802.11b/g, 802.11n HT20:11 Channels IEEE 802.11n HT40 :7 Channels		
Transmit Data Rate	IEEE 802.11b : 11, 5.5, 2, 1 Mbps		
	IEEE 802.11g : 54, 48, 36, 24, 18, 12, 9, 6 Mbps		
	IEEE 802.11n HT20 : 130, 117, 104, 78, 52, 39, 26, 13 Mbps		
	IEEE 802.11n HT40 : 300, 270, 243, 216, 162, 108, 81, 54, 27 Mbps		
Type of Modulation	IEEE 802.11b : DSSS (CCK, DQPSK, DBPSK)		
	IEEE 802.11g : OFDM (64QAM, 16QAM, QPSK, BPSK)		
	IEEE 802.11n HT20/40 : OFDM (64QAM, 16QAM, QPSK, BPSK)		
Frequency Selection	By software / firmware		



Antenna Type	Three antennas (3T3R) Connector: R SMA PLUG Manufacturer: ARISTOTLE ENTERPRISES INC. Model: RFA-25-T42-02 Type: Dipole Gain: 3 dBi
Power Source	Powered from adapter Adapter : Brand: APD Model: WA-24E12 Input: 100-240Vac, 50/60Hz, 0.65A Output: 12Vdc, 2.0A
Temperature Range	0 ~ +55°C

REMARK:

1. The sample selected for test was engineering sample that approximated to production product and was provided by manufacturer.
2. This submittal(s) (test report) is intended for FCC ID: **VZ9110001** filing to comply with Section 15.207, 15.209 and 15.247 of the FCC Part 15, Subpart C Rules.
3. For more details, please refer to the User's manual of the EUT.
4. The difference model number (EAP305; EAP306; HSG300; A600; W1160) is for marketing purpose.
5. The EUT with two external types :

External-1	1*WAN+4*LAN
External-2	1*WAN+1*LAN



3. DESCRIPTION OF TEST MODES

The EUT is a 11n router. It has three transmitter chains and three receive chains (3X3 configurations). The 3x3 configuration is implemented with three outside chains (Chain 0, Chain 1, and Chain 2).

The RF chipset is manufactured by Ralink Technology, Corp.

The antenna peak gain 3dBi (highest gain) were chosen for full testing.

IEEE 802.11 b ,802.11g ,802.11n HT20 mode (DTS Band)

The EUT had been tested under operating condition.

There are three channels have been tested as following:

Channel	Frequency (MHz)
Low	2412
Middle	2437
High	2462

IEEE 802.11b mode: 11Mbps data rate (worst case) were chosen for full testing.

IEEE 802.11g mode: 6Mbps data rate (worst case) were chosen for full testing.

IEEE 802.11n HT20 mode: 13Mbps data rate (worst case) were chosen for full testing.

IEEE 802.11n HT40 mode (DTS Band)

The EUT had been tested under operating condition.

There are three channels have been tested as following:

Channel	Frequency (MHz)
Low	2422
Middle	2437
High	2452

IEEE 802.11n HT40 mode: 27Mbps data rate (worst case) were chosen for full testing.

The worst-case data rates are determined according to the description above, based on the investigations by measuring the PSD, peak power and average power across all the data rates, bandwidths, modulations and spatial stream modes.

The worst-case channel is determined as the channel with the highest output power. The highest measured output power was at 2462 MHz.



4. TEST METHODOLOGY

The tests documented in this report were performed in accordance with ANSI C63.4 and FCC CFR 47 2.1046, 2046, 2.1047, 2.1049, 2.1051, 2.1053, 2.1055, 2.1057, 15.207, 15.209 and 15.247.

5. FACILITIES AND ACCREDITATIONS

5.1 FACILITIES

All measurement facilities used to collect the measurement data are located at No. 8, Jiu Ceng Ling, Jiaokeng Village, Sinhua Township, Tainan Hsien 712, Taiwan (R.O.C.)

The sites are constructed in conformance with the requirements of ANSI C63.7, ANSI C63.4 and CISPR Publication 22.

5.2 EQUIPMENT

Radiated emissions are measured with one or more of the following types of linearly polarized antennas: tuned dipole, biconical, log periodic, bi-log, and/or ridged waveguide, horn. Spectrum analyzers with preselectors and quasi-peak detectors are used to perform radiated measurements.

Conducted emissions are measured with Line Impedance Stabilization Networks and EMI Test Receivers.

Calibrated wideband preamplifiers, coaxial cables, and coaxial attenuators are also used for making measurements.





All receiving equipment conforms to CISPR Publication 16-1, "Radio Interference Measuring Apparatus and Measurement Methods."

5.3 LABORATORY ACCREDITATIONS LISTINGS

The test facilities used to perform radiated and conducted emissions tests are accredited by Taiwan Accreditation Foundation for the specific scope of accreditation under Lab Code: 1109 to perform Electromagnetic Interference tests according to FCC PART 15 AND CISPR 22 requirements. No part of this report may be used to claim or imply product endorsement by TAF or any agency of the Government. In addition, the test facilities are listed with Federal Communications Commission (registration no: TW-1037).



5.4 TABLE OF ACCREDITATIONS AND LISTINGS

Country	Agency	Scope of Accreditation	Logo
USA	FCC	3/10 meter Open Area Test Sites to perform FCC Part 15/18 measurements	 TW-1037
Taiwan	TAF	CISPR 11, FCC METHOD-47 CFR Part 18, EN 55011, EN 60601-1-2, CISPR 22, CNS 13438, EN 55022, EN 55024, AS/NZS CISPR 22 CISPR 14, EN 55014-1, EN 55014-2, CNS 13783-1, CISPR 22, CNS 13439, EN 55013, FCC Method-47 CFR Part 15 Subpart B, IC ICES-003, VCCI V-3 & V-4 FCC Method-47 CFR Part 15 Subpart C and ANSI C63.4, LP 0002 EN / IEC 61000-4-2 / -3 / -4 / -5 / -6 / -8 / -11 EN 61000-3-2, EN 61000-3-3 EN 61000-6-3, EN 61000-6-1, AS/NZS 4251.1, EN 61000-6-4, EN 61000-6-2, AS/NZS 4251.2, EN 61204-3, EN 50130-4, EN 62040-2, EN 50371, EN 50385, AS/NZS 4268, ETSI EN 300 386 ETSI EN 300 328, ETSI EN 301 489-1/-3/-9/-17 ETSI EN 301 893, ETSI EN 300 220-2/-1 ETSI EN 300 440-2/-1 ETSI EN 301 357-2/-1 RSS-310, RSS-210 Issue 7, RSS-Gen Issue 2	
Taiwan	BSMI	CNS 13438, CNS 13783-1, CNS13439	 SL2-IN-E-0039 SL2-R1/R2-0039 SL2-A1-E-0039
Canada	Industry Canada	RSS210, Issue 8	 IC 2324H-1

* No part of this report may be used to claim or imply product endorsement by TAF or any agency of the US Government.



6. CALIBRATION AND UNCERTAINTY

6.1 MEASURING INSTRUMENT CALIBRATION

The measuring equipment utilized to perform the tests documented in this report has been calibrated in accordance with the manufacturer's recommendations, and is traceable to recognized national standards.

6.2 MEASUREMENT UNCERTAINTY

Where relevant, the following measurement uncertainty levels have been estimated for tests performed on the apparatus:

PARAMETER	UNCERTAINTY
Radiated Emission, 30 to 200 MHz Test Site : OATS-6	±3.59dB
Radiated Emission, 200 to 1000 MHz Test Site : OATS-6	±3.27dB
Radiated Emission, 1 to 26.5 GHz	± 3.20dB
Power Line Conducted Emission	± 2.90dB

Uncertainty figures are valid to a confidence level of 95%, K=2



7. SETUP OF EQUIPMENT UNDER TEST

7.1 SETUP CONFIGURATION OF EUT

For RF test

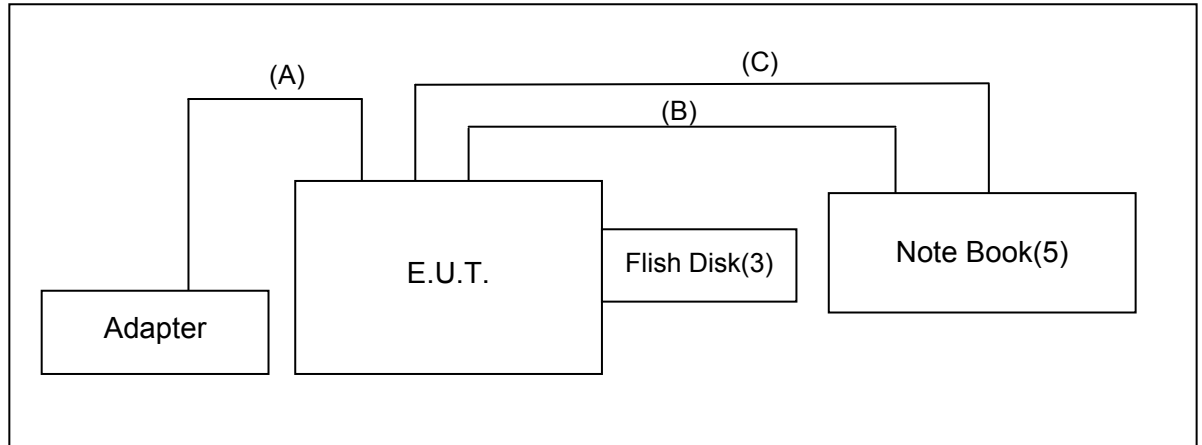

For EMI test

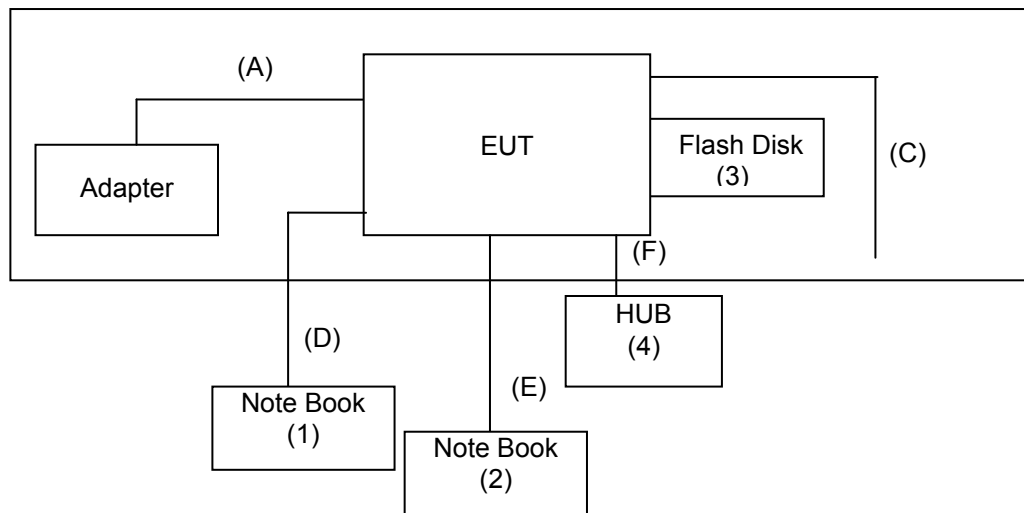



7.2 SUPPORT EQUIPMENT

No.	Product	Manufacturer	Model No.	Certify No.	Signal cable
1	Note Book	IBM	R51	R33026	Power cable, unshd, 1.6m
2	Note Book	IBM	T43	DoC	Power cable, unshd, 1.6m
3	Flash Disk	Kingston	DTI/512	DoC	N/A
4	HUB	BARRICAD	SMC7008BR	DoC	Power cable, unshd, 1.6m
5	Note Book	Ben Q	Joybook	DoC	Power cable, unshd, 1.4m

No.	Signal cable description	
A	Power	Unshielded, 1.7m 1 pcs
B	LAN	Unshielded, 1.6m 1 pcs
C	RS232	Shielded, 1.8m 1 pcs
D	LAN	Unshielded, 10m 1 pcs
E	LAN	Unshielded, 10m 1 pcs
F	LAN	Unshielded, 1.8m 3 pcs

REMARK:

1. All the above equipment/cables were placed in worse case positions to maximize emission signals during emission test.
2. Grounding was established in accordance with the manufacturer's requirements and conditions for the intended use.



7.3 EUT OPERATING CONDITION

RF Setup

1. Set up all computers like the setup diagram.
2. Insert USB disk with the program "ap83test.sh"
2. Start hyper terminal with N.B.
3. Turn on the EUT power.
4. Send command "cd /ramdisk/usb/br51n" and "sh ap83test.sh" to hyper terminal.
5. The software "DUT" was used for testing.

TX Mode:

- ⇒ **Tx Mode:CCK 、 OFDM、 HT MixMode** (Bandwidth: 20、 40)
- ⇒ **Tx Data Rate: 11Mbps long** (IEEE 802.11b mode)
 - 6Mbps** (IEEE 802.11g mode)
 - 13Mbps** (IEEE 802.11n HT20 mode ,chain 0, chain 1, chain 2 TX)
 - 27Mbps** (IEEE 802.11n HT40 mode, chain 0, chain 1, chain 2 TX)

Power control mode

- Target Power:** IEEE 802.11b Channel Low (2412MHz) = **14**
 - IEEE 802.11b Channel Middle (2437MHz) = **14**
 - IEEE 802.11b Channel High (2462MHz) = **14**
- Target Power:** IEEE 802.11g Channel Low (2412MHz) = **14**
 - IEEE 802.11g Channel Middle (2437MHz) = **14**
 - IEEE 802.11g Channel High (2462MHz) = **14**
- Target Power:** IEEE 802.11n HT20 Channel Low (2412MHz) = **9 (Chain 0)**
 - IEEE 802.11 n HT20 Channel Middle (2437MHz) = **9 (Chain 0)**
 - IEEE 802.11 n HT20 Channel High (2462MHz) = **9 (Chain 0)**
 - IEEE 802.11n HT20 Channel Low (2412MHz) = **9 (Chain 1)**
 - IEEE 802.11 n HT20 Channel Middle (2437MHz) = **9 (Chain 1)**
 - IEEE 802.11 n HT20 Channel High (2462MHz) = **9 (Chain 1)**
 - IEEE 802.11n HT20 Channel Low (2412MHz) = **9 (Chain 2)**
 - IEEE 802.11 n HT20 Channel Middle (2437MHz) = **9 (Chain 2)**
 - IEEE 802.11 n HT20 Channel High (2462MHz) = **9 (Chain 2)**
- Target Power:** IEEE 802.11n HT40 Channel Low (2422MHz) = **9 (Chain 0)**
 - IEEE 802.11 n HT40 Channel Middle (2437MHz) = **9 (Chain 0)**
 - IEEE 802.11 n HT40 Channel High (2452MHz) = **9 (Chain 0)**
 - IEEE 802.11n HT40 Channel Low (2422MHz) = **9 (Chain 1)**
 - IEEE 802.11 n HT40 Channel Middle (2437MHz) = **9 (Chain 1)**
 - IEEE 802.11 n HT40 Channel High (2452MHz) = **9 (Chain 1)**
 - IEEE 802.11n HT40 Channel Low (2422MHz) = **9 (Chain 2)**
 - IEEE 802.11 n HT40 Channel Middle (2437MHz) = **9 (Chain 2)**
 - IEEE 802.11 n HT40 Channel High (2452MHz) = **9 (Chain 2)**

(2) RX Mode :

Start RX

3. All of the function are under run.
4. Start test.

Normal Link Setup

1. Set up all computers like the setup diagram.
 2. All of the function are under run.
 3. Notebook PC (2) ping 192.168.0.10 -t to Notebook PC (1).
 4. Notebook PC (1) ping 192.168.0.20 -t to Notebook PC (2).
 5. Notebook PC (1) ping 192.168.0.50 -t to Wireless Access Point (3).
- Start test.



8. APPLICABLE LIMITS AND TEST RESULTS

8.1 6DB BANDWIDTH

LIMIT

§ 15.247(a) (2) For direct sequence systems, the minimum 6dB bandwidth shall be at least 500kHz

TEST EQUIPMENTS

Name of Equipment	Manufacturer	Model	Serial Number	Calibration Due
Spectrum Analyzer	R&S	FSEK 30	835253/002	JUL. 14, 2011

TEST SETUP

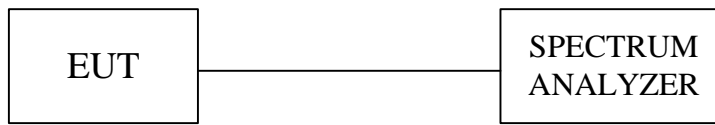

TEST PROCEDURE

The transmitter output was connected to a spectrum analyzer. The bandwidth of the fundamental frequency was measured by spectrum analyzer with 100 KHz RBW and 100 KHz VBW. The 6dB bandwidth is defined as the total spectrum the power of which is higher than peak power minus 6dB.



TEST RESULTS

No non-compliance noted.

IEEE 802.11b mode (Three TX)

Channel	Channel Frequency (MHz)	6dB Bandwidth (kHz)	Minimum Limit (kHz)	Pass / Fail
Low	2412	11924	500	PASS
Middle	2437	11423	500	PASS
High	2462	11423	500	PASS

NOTE :

1. At final test to get the worst-case emission at 11Mbps.
2. The cable assembly insertion loss of 11.7dB (including 10 dB pad and 1.7 dB cable) was entered as an offset in the spectrum analyzer to allow for direct reading of power.

IEEE 802.11g mode (Three TX)

Channel	Channel Frequency (MHz)	6dB Bandwidth (kHz)	Minimum Limit (kHz)	Pass / Fail
Low	2412	16633	500	PASS
Middle	2437	16733	500	PASS
High	2462	16633	500	PASS

NOTE :

1. At final test to get the worst-case emission at 6Mbps.
2. The cable assembly insertion loss of 11.7dB (including 10 dB pad and 1.7 dB cable) was entered as an offset in the spectrum analyzer to allow for direct reading of power.



IEEE 802.11n HT20 mode (Three TX)

Channel	Channel Frequency (MHz)	6dB Bandwidth (kHz)			Minimum Limit (kHz)	Pass / Fail
		Chain 0	Chain1	Chain2		
Low	2412	17936	17936	17936	500	PASS
Middle	2437	17836	17836	17836	500	PASS
High	2462	17936	17936	17936	500	PASS

NOTE :

1. At final test to get the worst-case emission at 13Mbps.
2. The cable assembly insertion loss of 11.7dB (including 10 dB pad and 1.7 dB cable) was entered as an offset in the spectrum analyzer to allow for direct reading of power.

IEEE 802.11n HT40 mode (Three TX)

Channel	Channel Frequency (MHz)	6dB Bandwidth (kHz)			Minimum Limit (kHz)	Pass / Fail
		Chain 0	Chain1	Chain2		
Low	2422	37074	36874	36673	500	PASS
Middle	2437	37074	37074	36673	500	PASS
High	2452	37074	37074	36874	500	PASS

NOTE :

1. At final test to get the worst-case emission at 27Mbps.
2. The cable assembly insertion loss of 11.7dB (including 10 dB pad and 1.7 dB cable) was entered as an offset in the spectrum analyzer to allow for direct reading of power.



6dB BANDWIDTH (802.11b MODE)

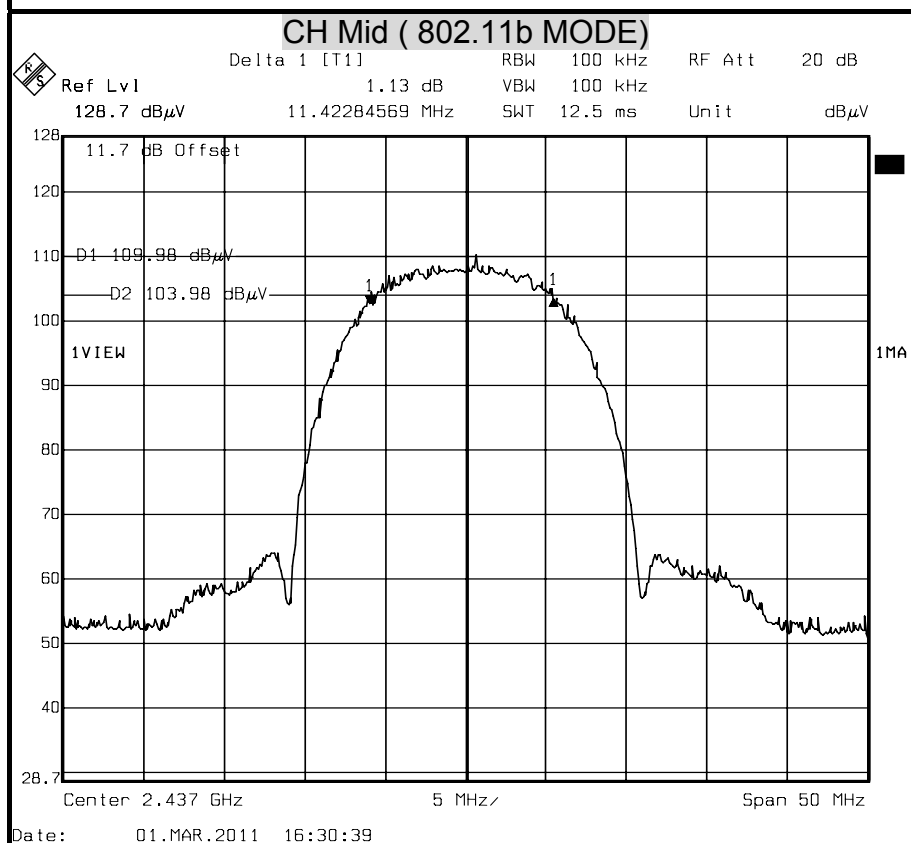
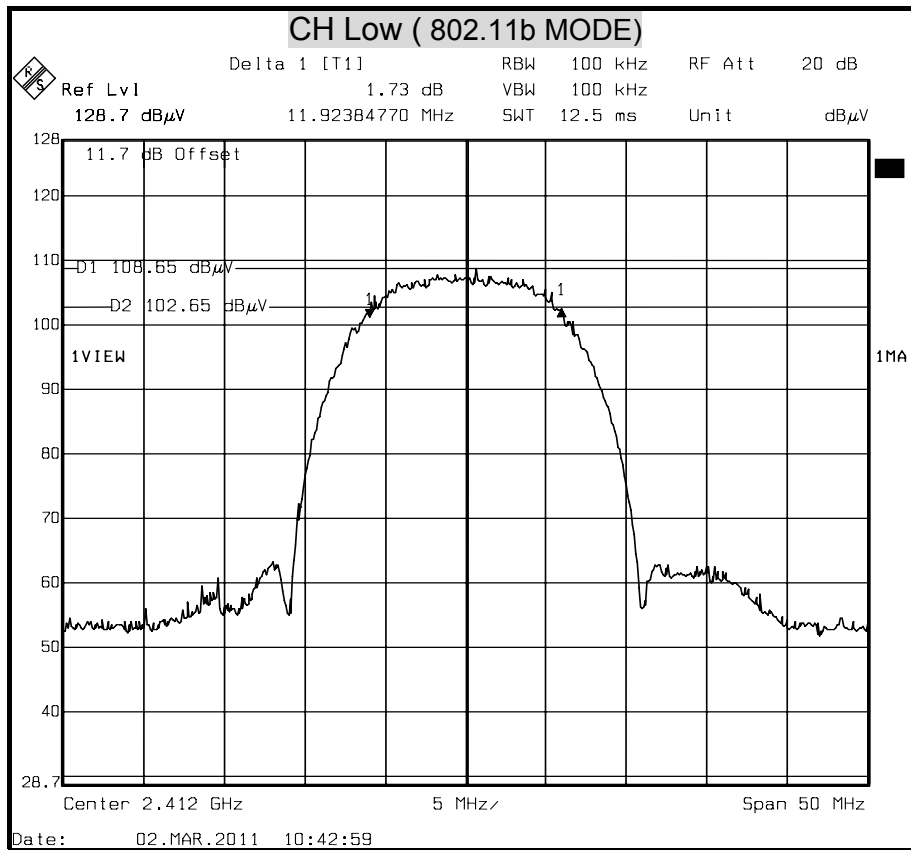

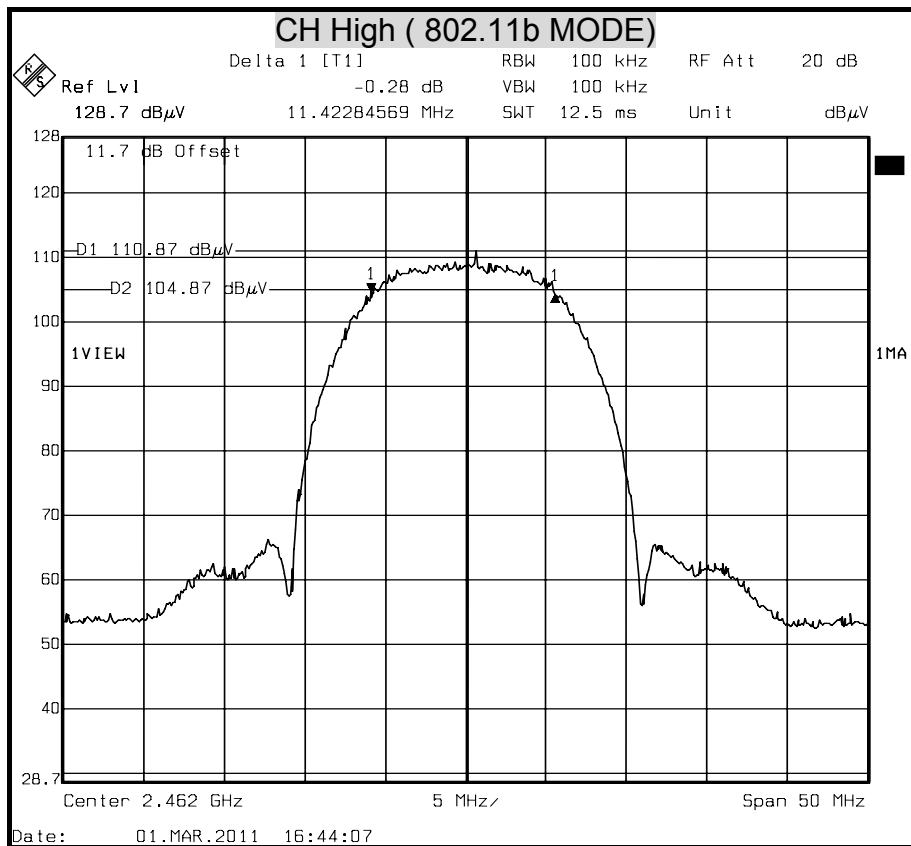



6dB BANDWIDTH (802.11g MODE)

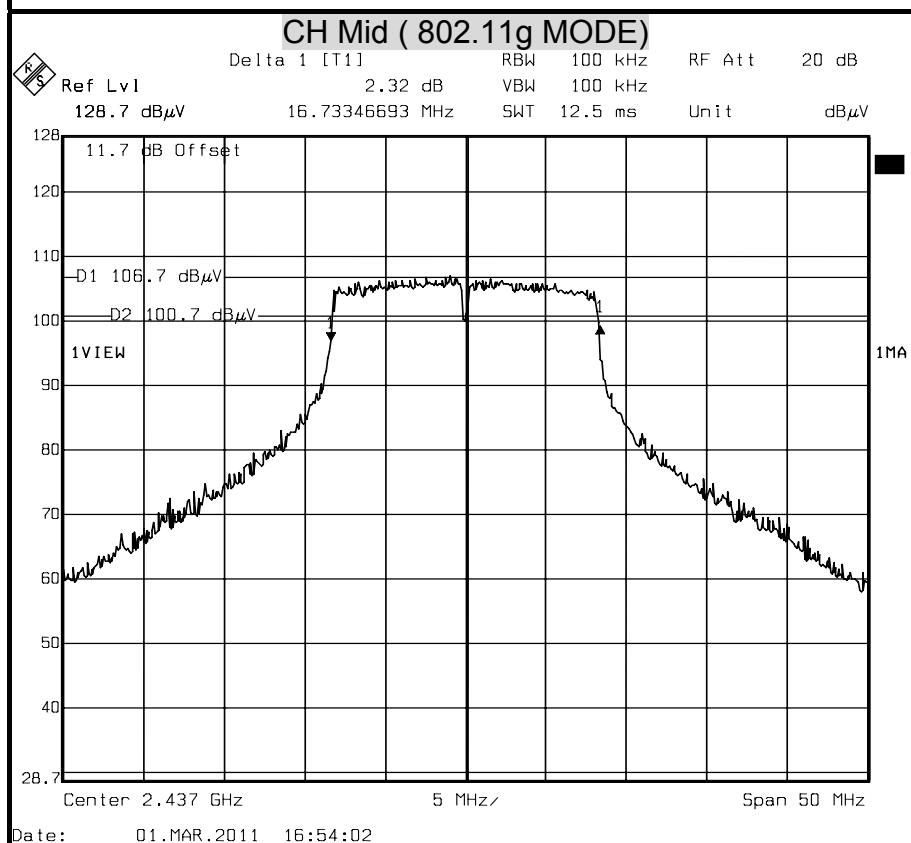
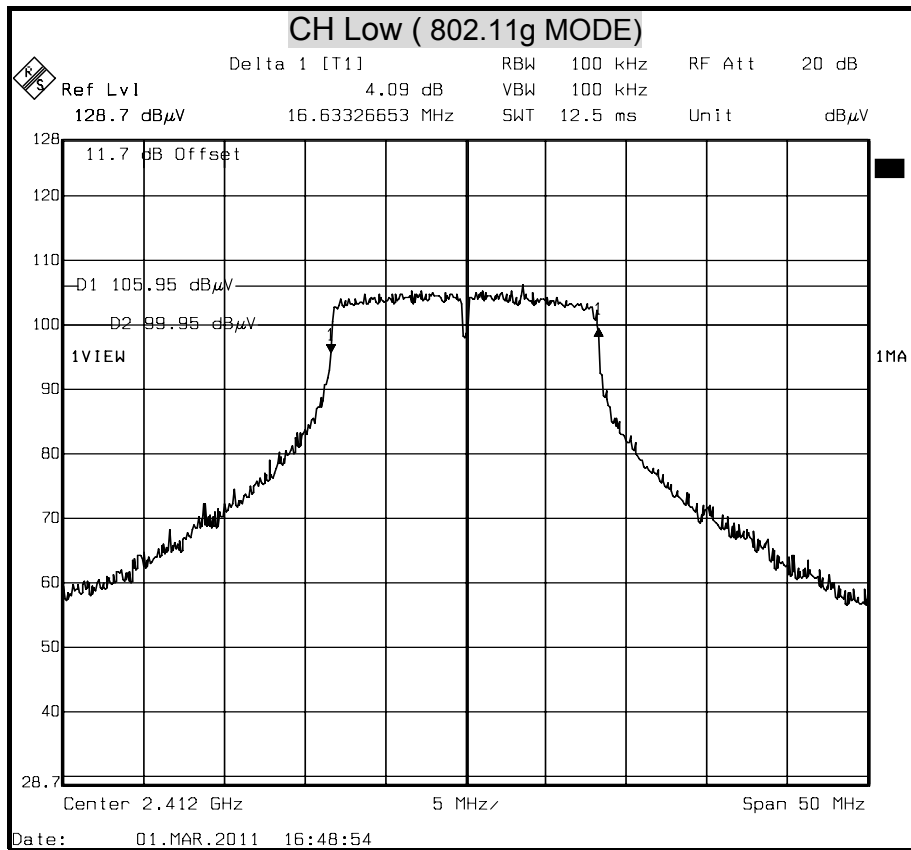

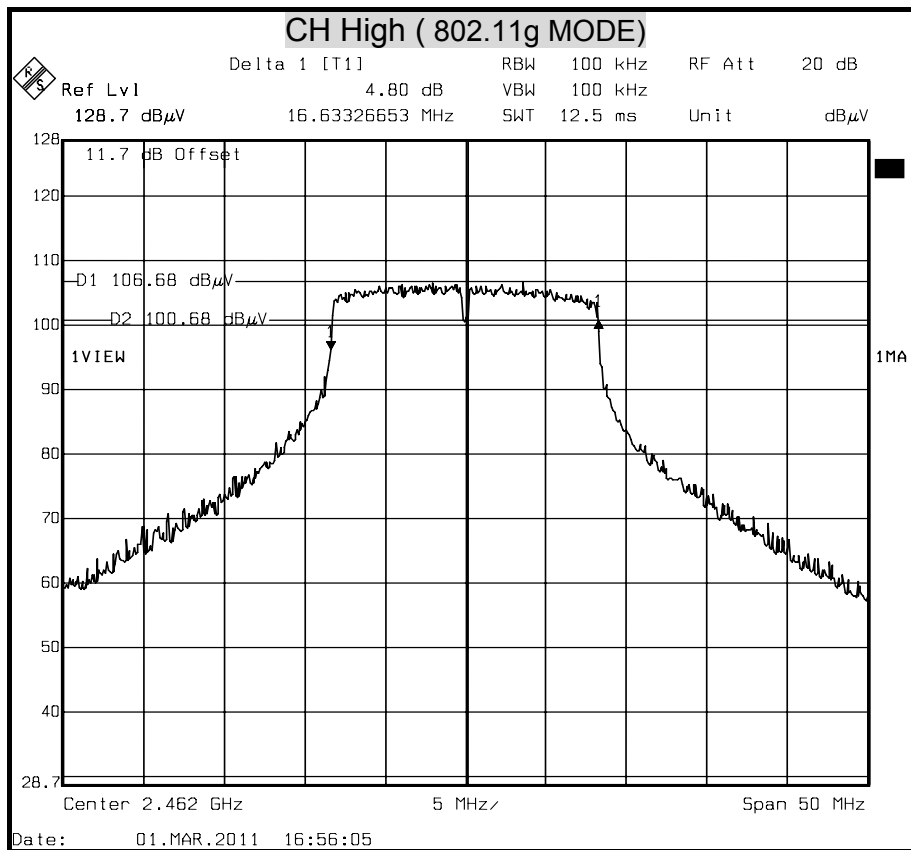



6dB BANDWIDTH (802.11n HT20 MODE) Chain 0

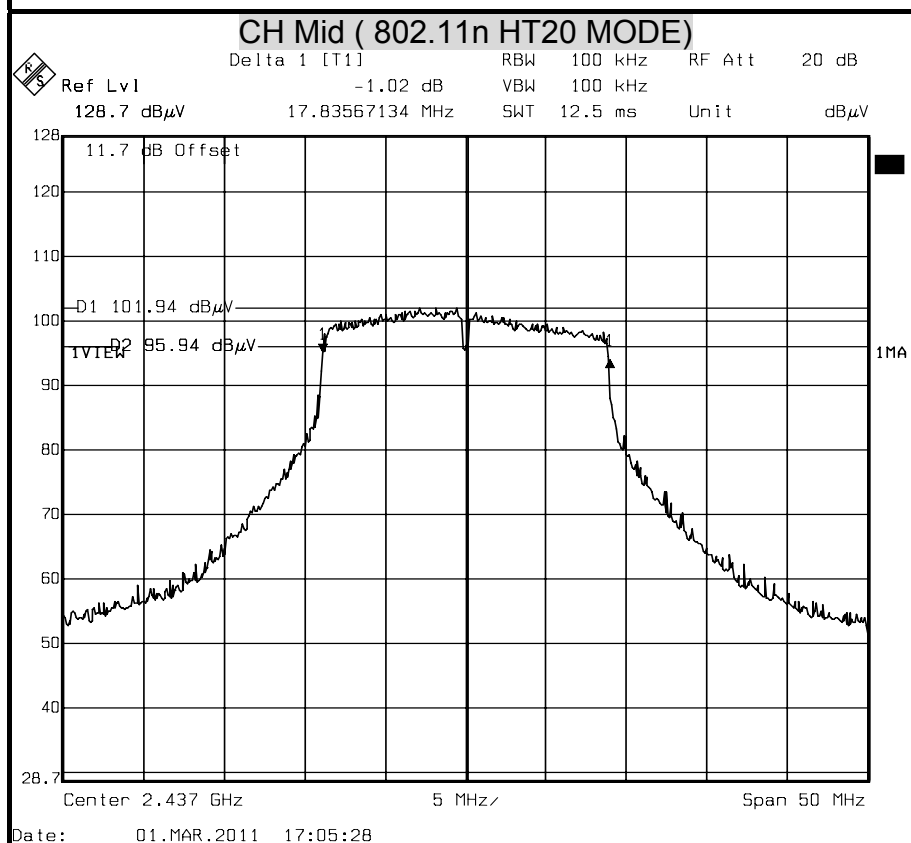
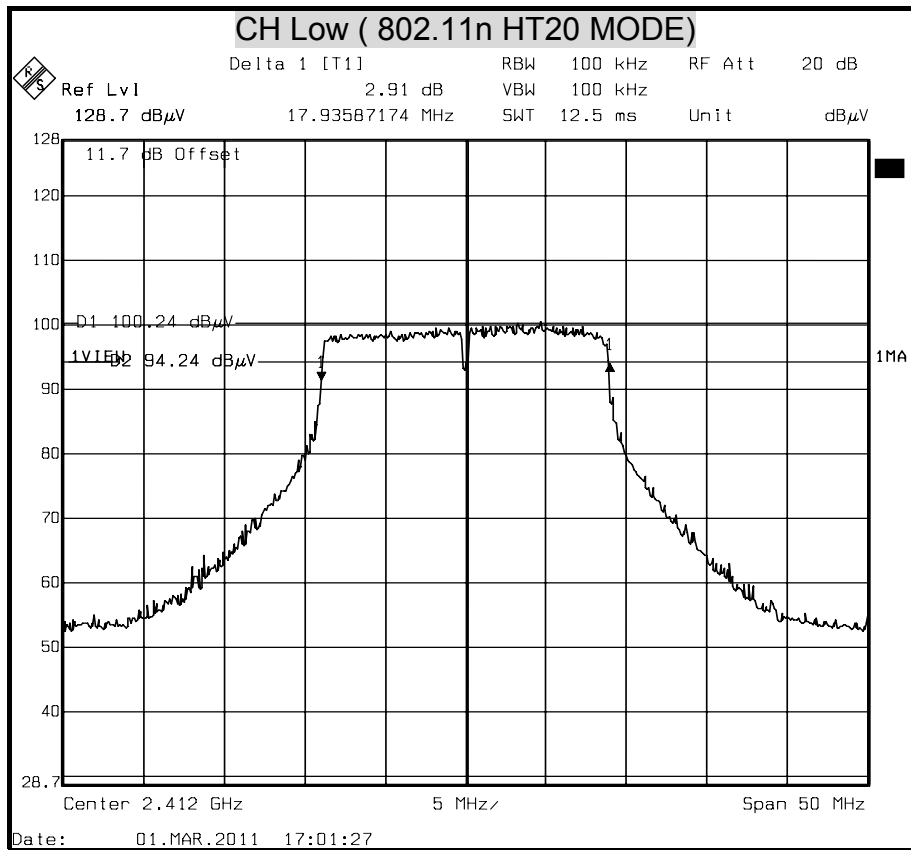

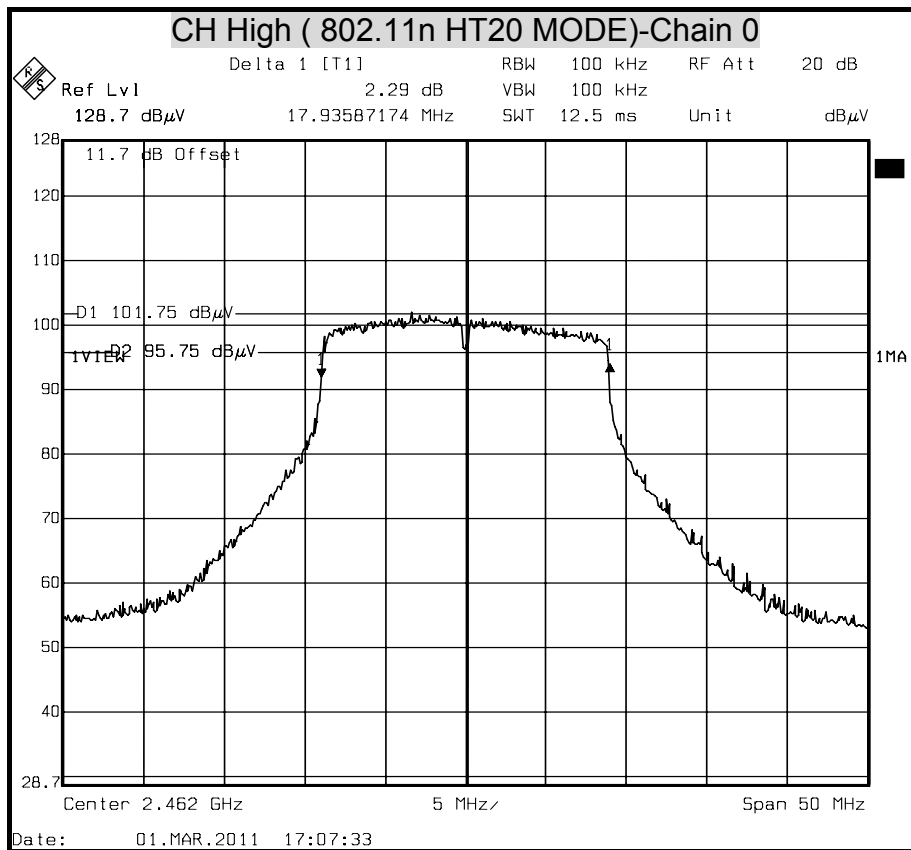



6dB BANDWIDTH (802.11n HT20 MODE) Chain 1

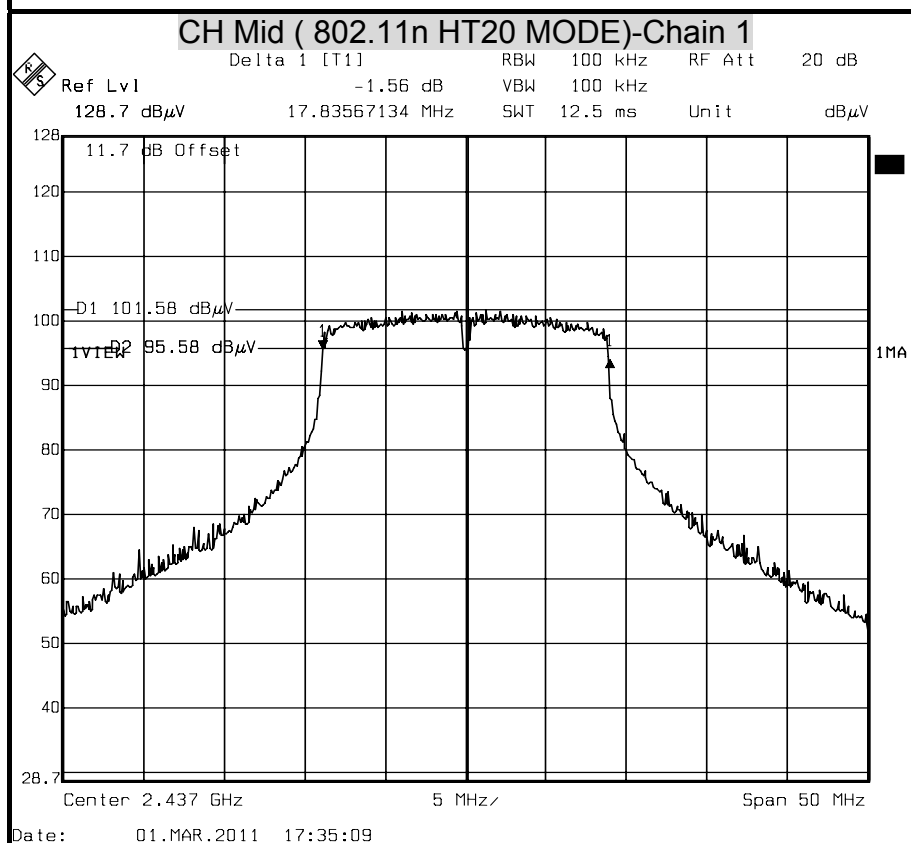
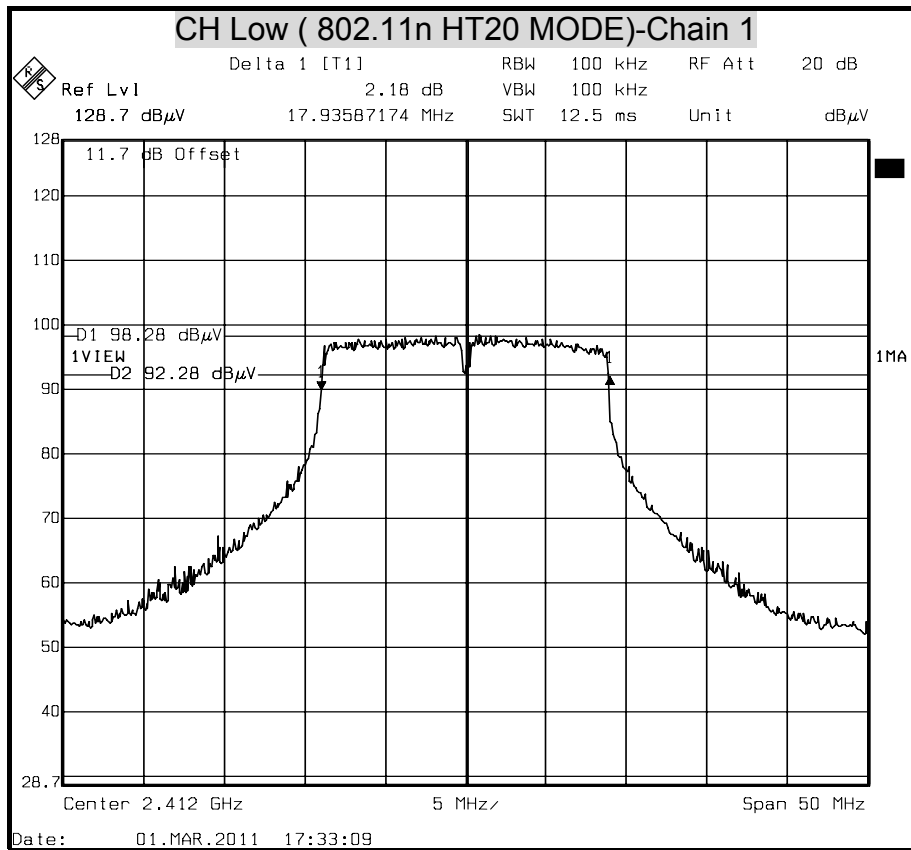

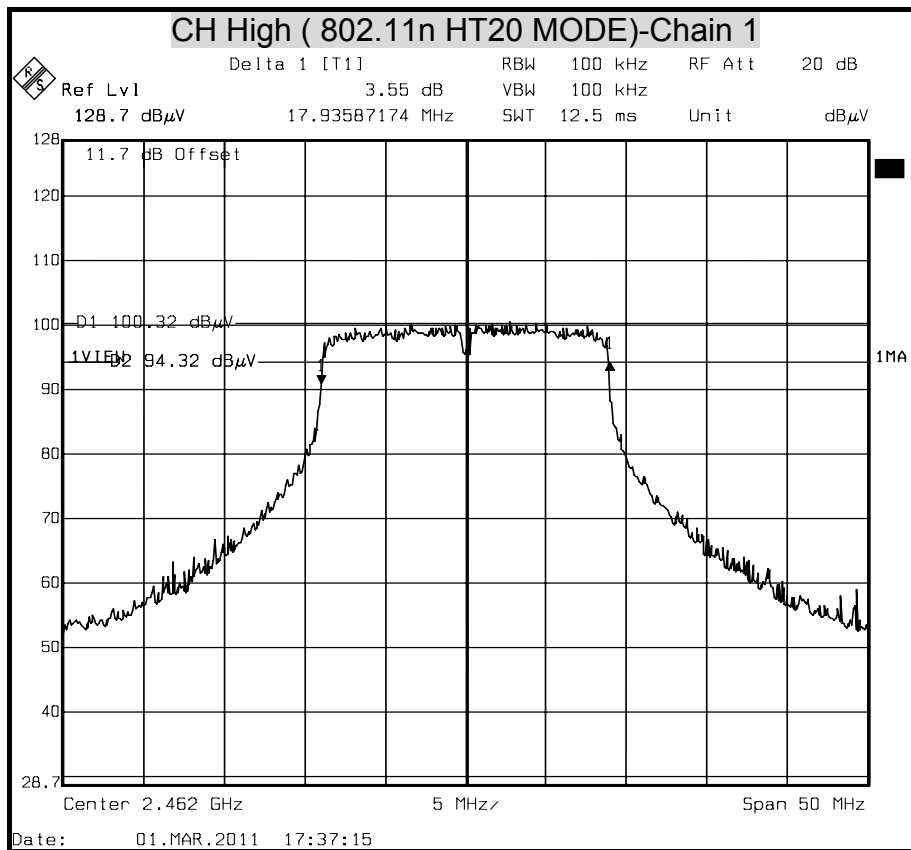



6dB BANDWIDTH (802.11n HT20 MODE) Chain 2

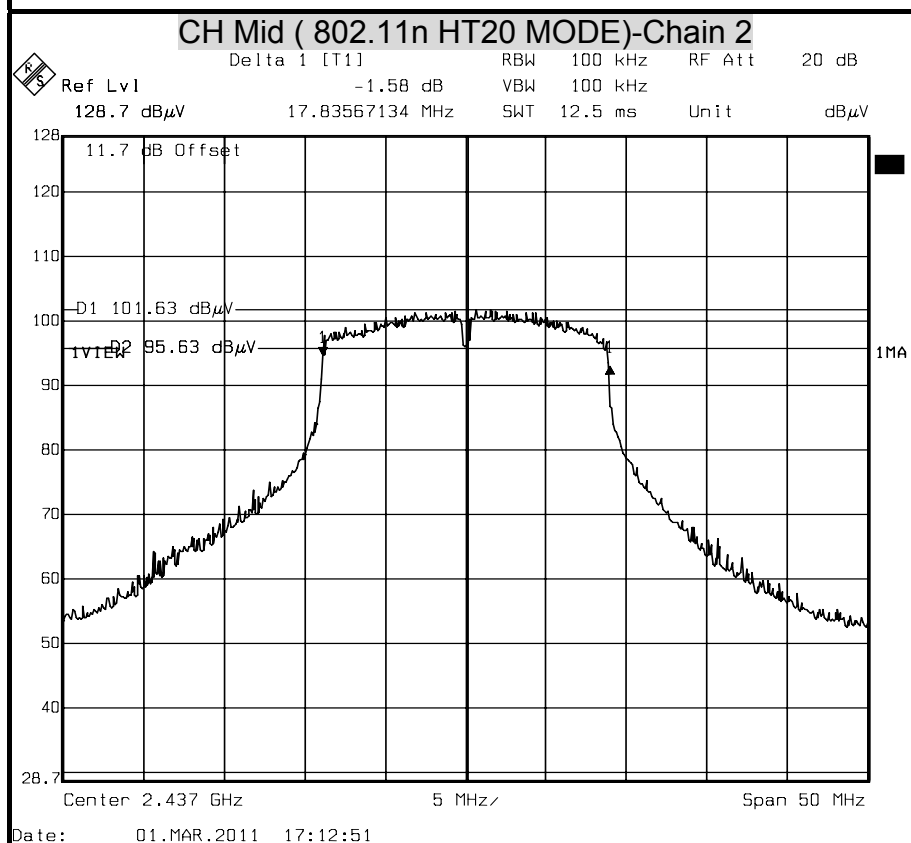
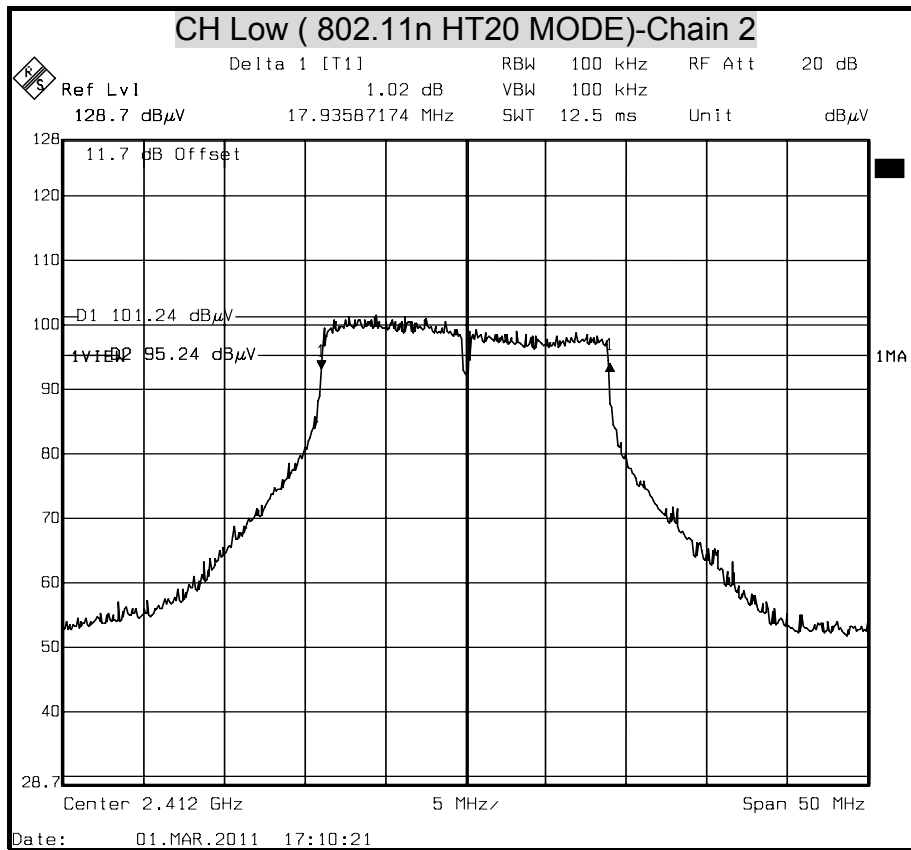

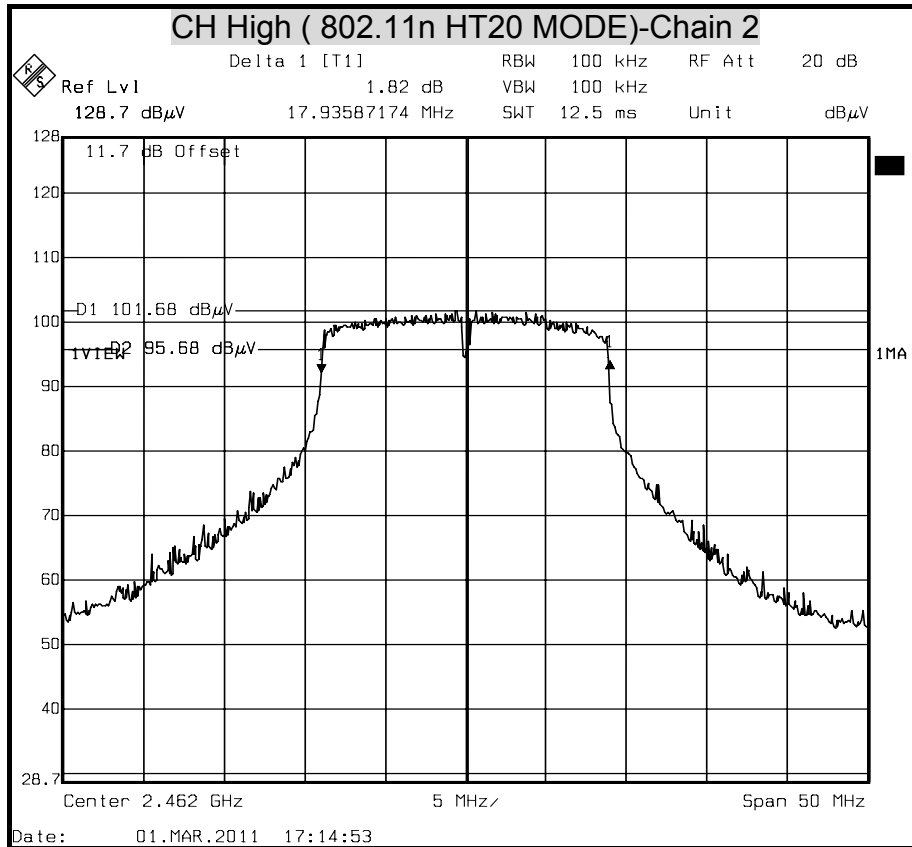



6dB BANDWIDTH (802.11n HT40 MODE) Chain 0

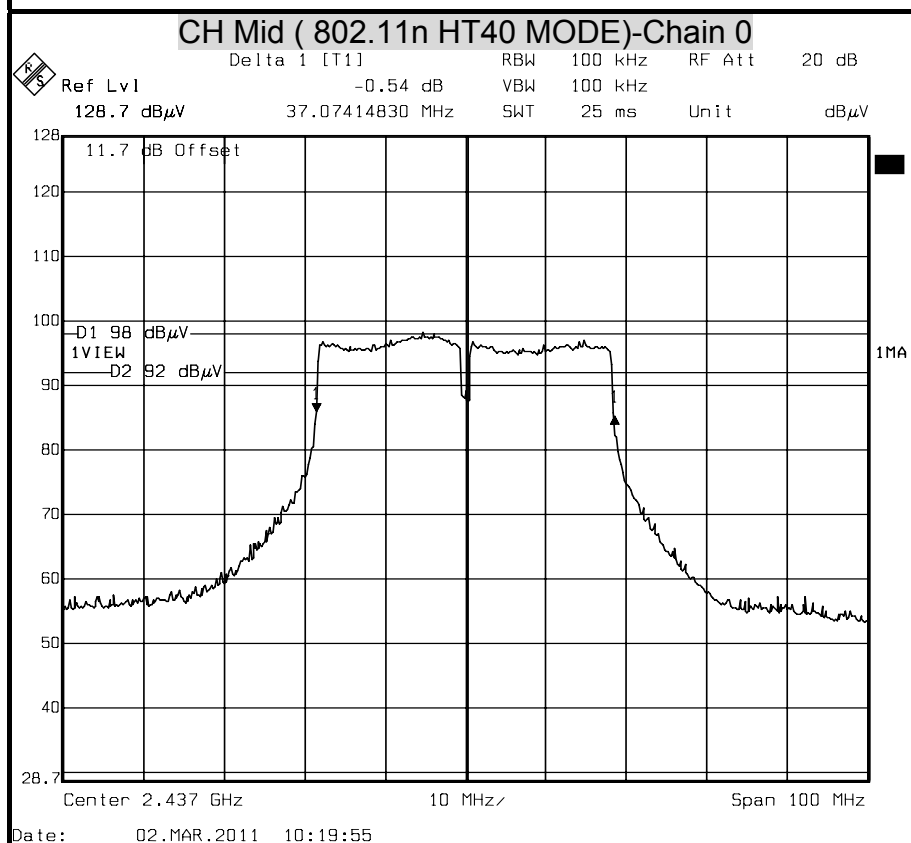
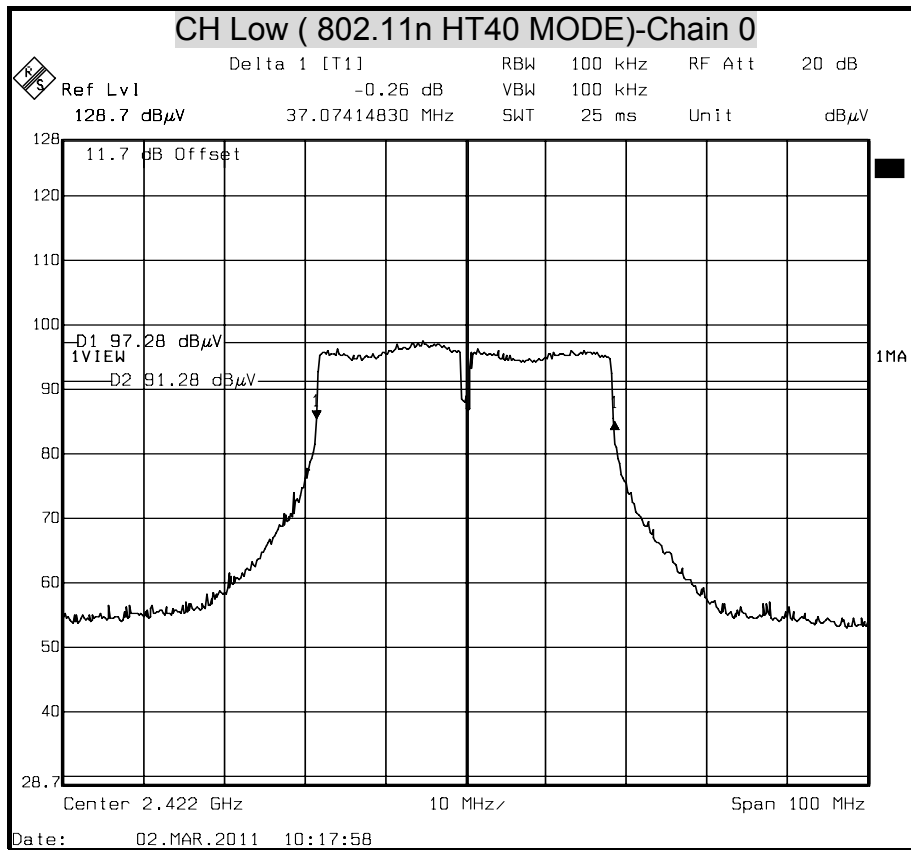

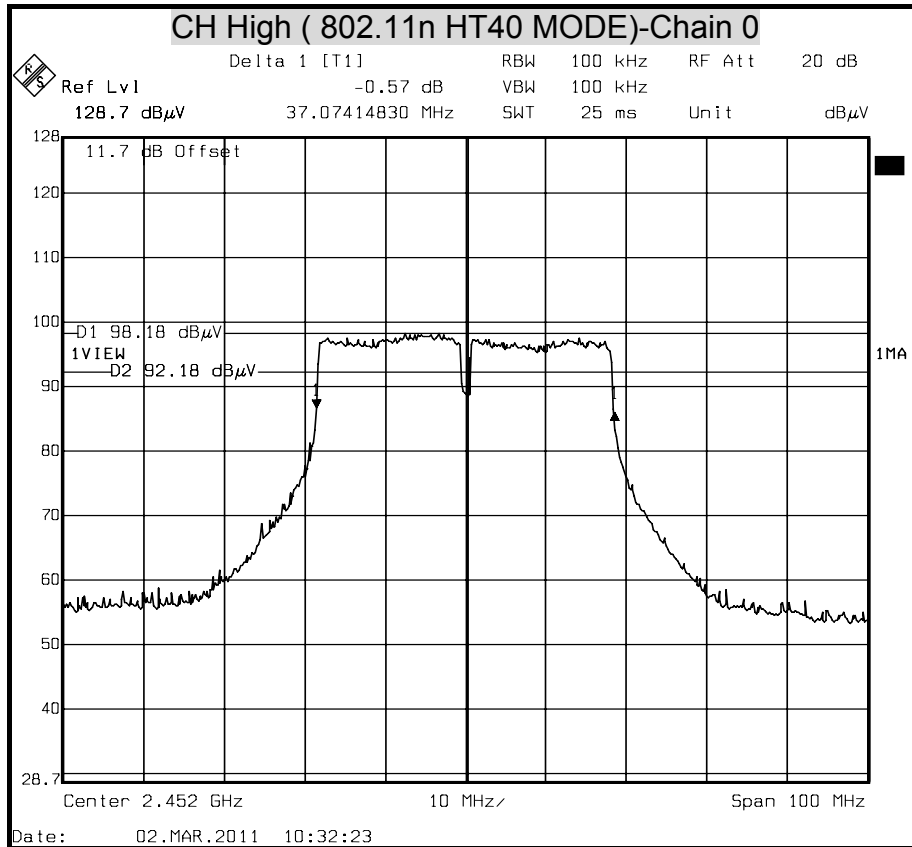



6dB BANDWIDTH (802.11n HT40 MODE) Chain 1

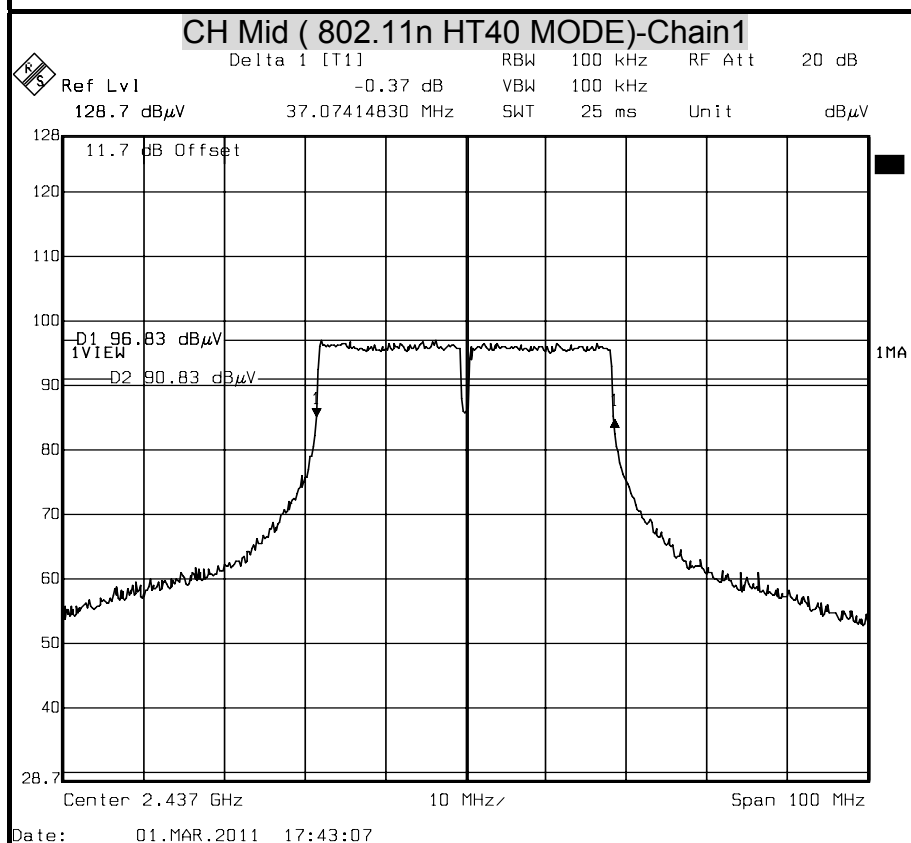

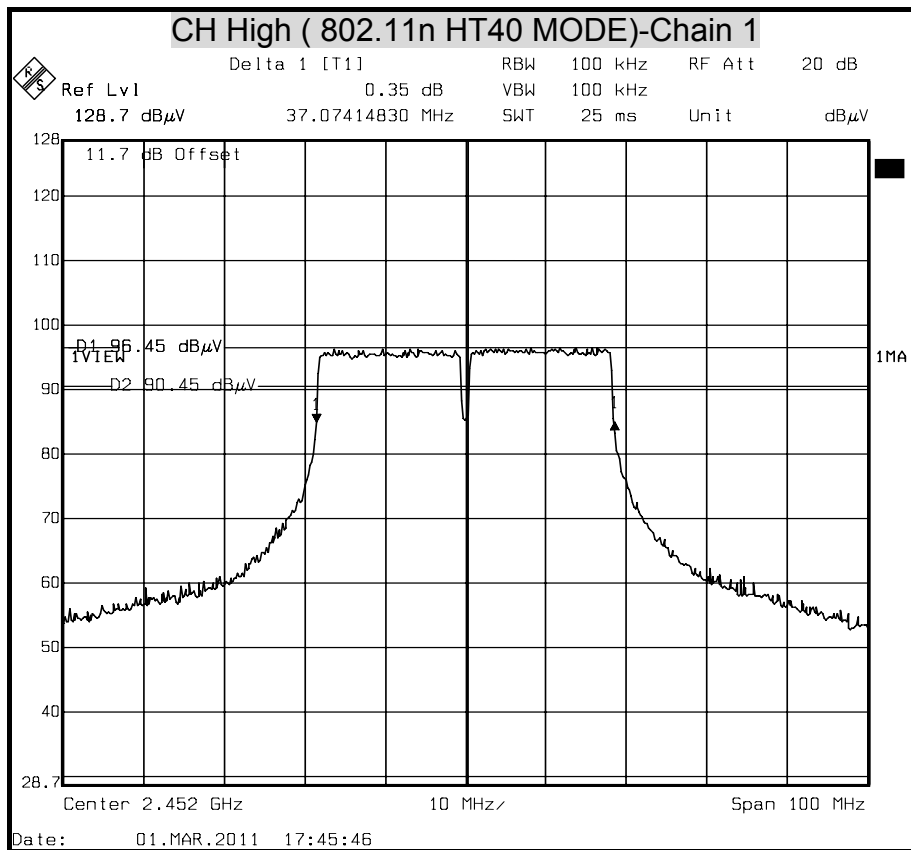



6dB BANDWIDTH (802.11n HT40 MODE) Chain 2

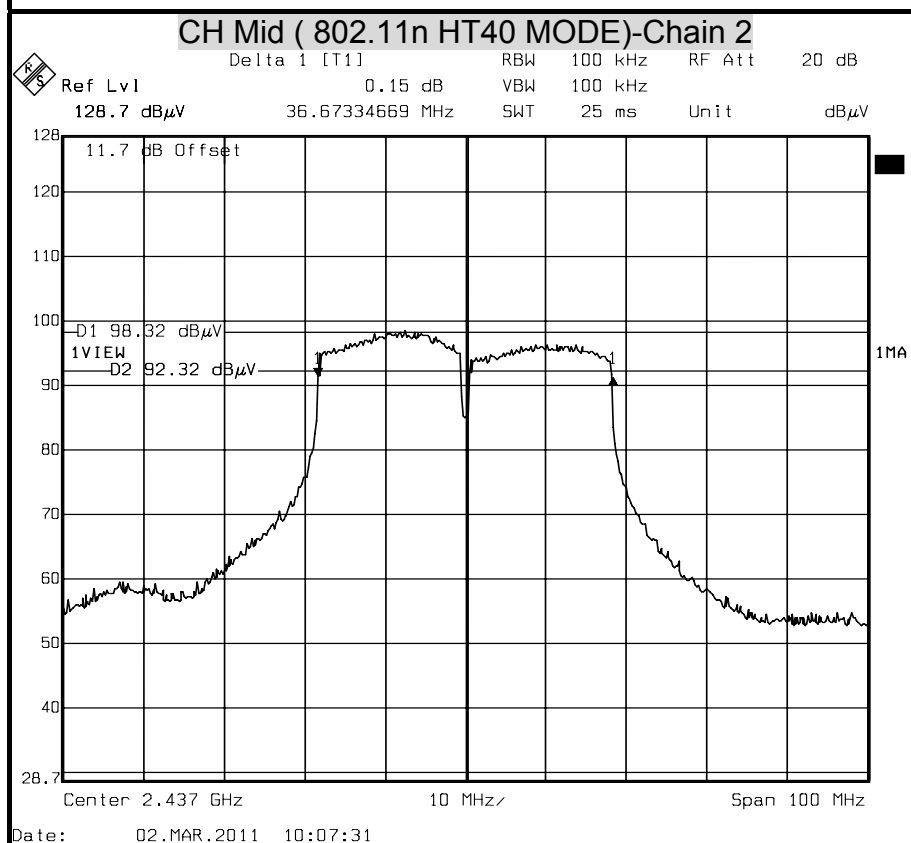
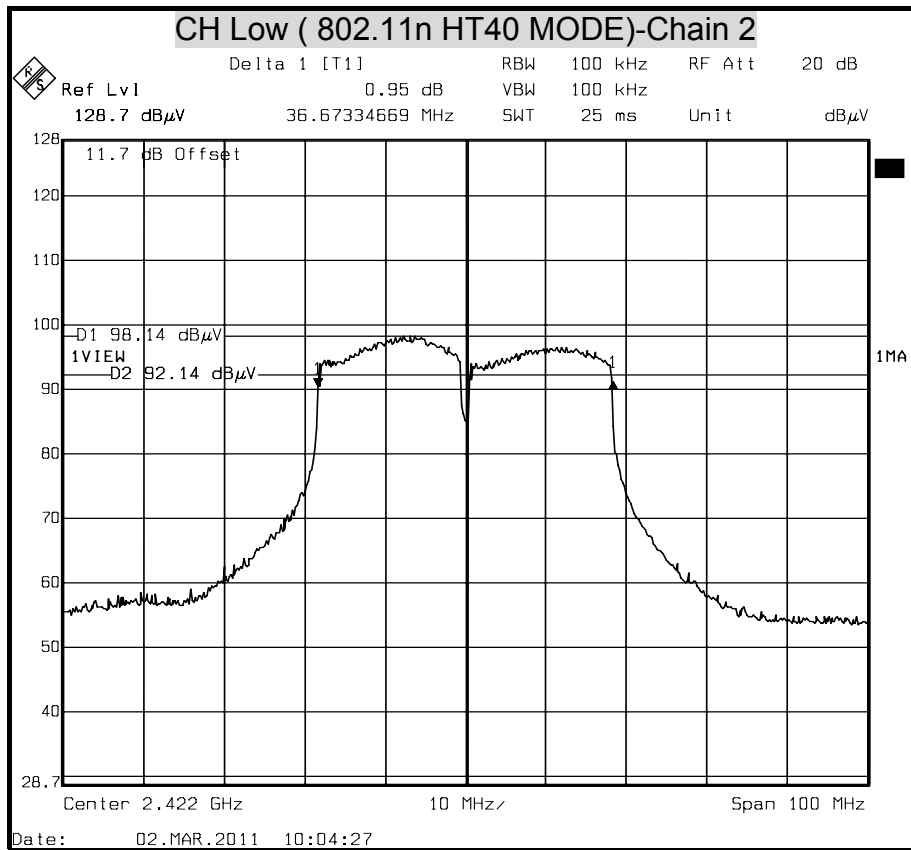

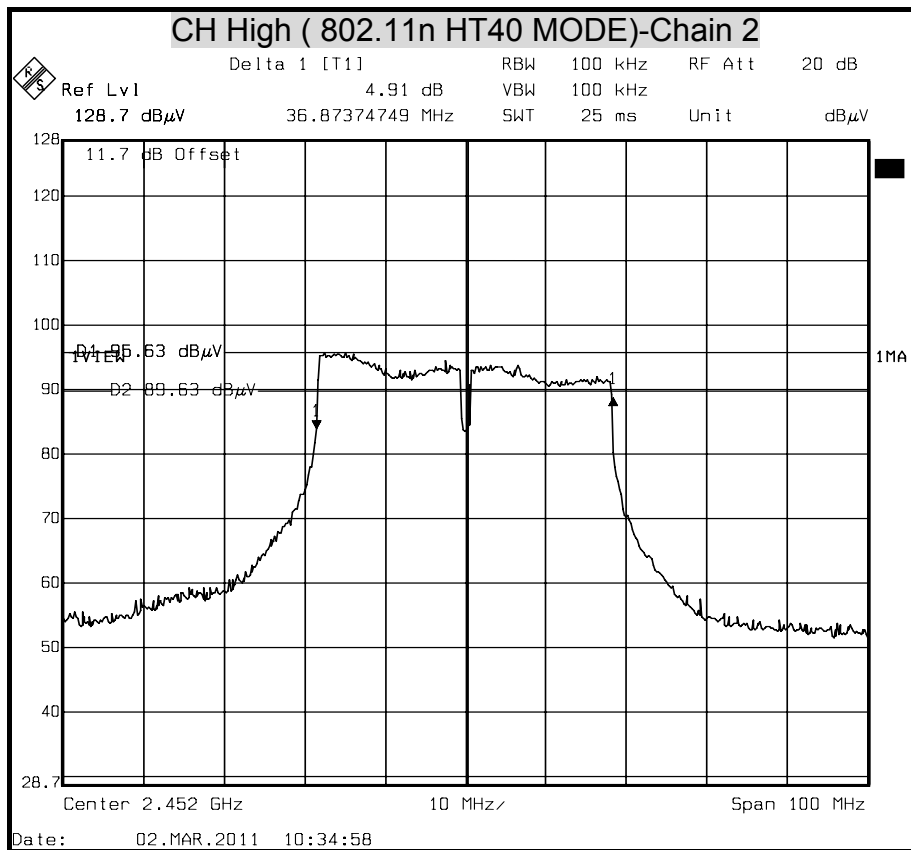



8.2 MAXIMUM PEAK OUTPUT POWER

LIMIT

§ 15.247(b) The maximum peak output power of the intentional radiator shall not exceed the following :

§ 15.247(b) (3) For systems using digital modulation in the 902-928 MHz, 2400-2483.5 MHz, and 5725-5850 MHz bands : 1 watt.

§ 15.247(b) (4) Except as shown in paragraphs (c) of this section , if transmitting antennas of directional gain greater than 6 dBi are used the peak output power from the intentional radiator shall be reduced below the stated values in paragraphs (b)(1) or (b)(2), and (b)(3) of this section , as appropriate, by the amount in dB that the directional gain of the antenna exceeds 6 dBi.

TEST EQUIPMENTS

Name of Equipment	Manufacturer	Model	Serial Number	Calibration Due
Power Meter	Anritsu	ML2487A	6K00003888	MAY 11, 2011

TEST SETUP

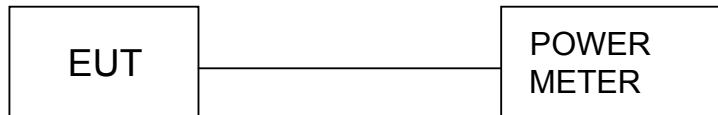

TEST PROCEDURE

Connect the EUT to spectrum analyzer, set the center frequency of the spectrum analyzer to the channel center frequency. Set the RBW to 1MHz and VBW to 3MHz.

Set sweep time=auto

Use detector max peak mode

Measurement of Digital Transmission Systems Operating under Section 15.247

TEST RESULTS

No non-compliance noted



IEEE 802.11b mode (Three TX)

Channel	Channel Frequency (MHz)	Peak Power (dBm)	Peak Power Limit (dBm)	Pass / Fail
		Chain 0		
Low	2412	15.59	30	PASS
Middle	2437	16.45	30	PASS
High	2462	16.57	30	PASS

NOTE : 1. At final test to get the worst-case emission at 11Mbps.
 2. The cable assembly insertion loss of 11.7dB (including 10 dB pad and 1.7 dB cable) was
 Entered as an offset in the power meter to allow for direct reading of power.

IEEE 802.11g mode (Three TX)

Channel	Channel Frequency (MHz)	Peak Power (dBm)	Peak Power Limit (dBm)	Pass / Fail
		Chain 0		
Low	2412	21.68	30	PASS
Middle	2437	22.42	30	PASS
High	2462	22.43	30	PASS

NOTE : 1. At final test to get the worst-case emission at 6Mbps.
 2. The cable assembly insertion loss of 11.7dB (including 10 dB pad and 1.7 dB cable) was
 Entered as an offset in the power meter to allow for direct reading of power.



Array Gain= $10 \cdot \log_{10}(10^{(ANTENNA\ 0/10)} + 10^{(ANTENNA\ 1/10)} + 10^{(ANTENNA\ 2/10)}) = 7.77$
 Limit= $30 - (7.77 - 6) = 28.23$ dBm
 IEEE 802.11n HT20 mode(Three TX)

Channel	Channel Frequency (MHz)	Peak Power (dBm)			Peak Power Total (dBm)	Peak Power Limit (dBm)	Pass / Fail
		Chain 0	Chain 1	Chain 2			
Low	2412	16.78	16.74	17.85	21.93	28.23	PASS
Middle	2437	17.79	18.07	18.03	22.74	28.23	PASS
High	2462	17.92	17.60	17.80	22.55	28.23	PASS

NOTE : 1. At final test to get the worst-case emission at 13Mbps.
 2. The cable assembly insertion loss of 11.7dB (including 10 dB pad and 1.7 dB cable) was
 Entered as an offset in the power meter to allow for direct reading of power.

Array Gain= $10 \cdot \log_{10}(10^{(ANTENNA\ 0/10)} + 10^{(ANTENNA\ 1/10)} + 10^{(ANTENNA\ 2/10)}) = 7.77$
 Limit= $30 - (7.77 - 6) = 28.23$ dBm
 IEEE 802.11n HT40 mode (Three TX)

Channel	Channel Frequency (MHz)	Peak Power (dBm)			Peak Power Total (dBm)	Peak Power Limit (dBm)	Pass / Fail
		Chain 0	Chain 1	Chain 2			
Low	2422	17.49	17.27	17.24	22.11	28.23	PASS
Middle	2437	17.76	17.75	17.41	22.41	28.23	PASS
High	2452	17.95	17.30	18.01	22.54	28.23	PASS

NOTE : 1. At final test to get the worst-case emission at 27Mbps.
 2. The cable assembly insertion loss of 11.7dB (including 10 dB pad and 1.7 dB cable) was
 Entered as an offset in the power meter to allow for direct reading of power.



802.11b

Mode

Channel	Frequency (MHz)	Average Power Chain0 (dBm)
Low	2412	13.58
Middle	2437	14.43
High	2462	14.59

802.11g Normal Mode

Channel	Frequency (MHz)	Average Power Chain0 (dBm)
Low	2412	13.68
Middle	2437	14.68
High	2462	14.61

802.11n HT-20 Mode

Channel	Frequency (MHz)	Average Power Chain0 (dBm)	Average Power Chain1 (dBm)	Average Power Chain2 (dBm)
Low	2412	8.65	8.22	8.57
Middle	2437	9.33	10.13	9.74
High	2462	9.54	9.49	9.55

802.11n HT-40 Mode

Channel	Frequency (MHz)	Average Power Chain0 (dBm)	Average Power Chain1 (dBm)	Average Power Chain2 (dBm)
Low	2412	8.32	8.05	7.95
Middle	2437	8.63	8.80	8.35
High	2462	8.50	8.58	8.76



8.3 MAXIMUM PERMISSIBLE EXPOSURE

According to FCC 1.1310 : The criteria listed in the following table shall be used to evaluate the environment impact of human exposure to radio frequency (RF) radiation as specified in 1.1307(b)LIMITS FOR MAXIMUM PERMISSIBLE EXPOSURE (MPE)

Frequency Range (MHz)	Electric Field Strength (V/m)	Magnetic Field Strength (A/m)	Power Density (mW/cm ²)	Average Time
(A) Limits for Occupational / Control Exposures				
300-1,500	--	--	F/300	6
1,500-100,000	--	--	5	6
(B) Limits for General Population / Uncontrol Exposures				
300-1,500	--	--	F/1500	6
1,500-100,000	--	--	1	30

CALCULATIONS

Given $E = \frac{\sqrt{30 \times P \times G}}{d}$ & $S = \frac{E^2}{3770}$

Where $E =$ Field strength in Volts / meter

$P =$ Power in Watts

$G =$ Numeric antenna gain

$d =$ Distance in meters

$S =$ Power density in milliwatts / square centimeter

Combining equations and re-arranging the terms to express the distance as a function of the remaining variables yields:

$$S = \frac{30 \times P \times G}{3770d^2}$$

Changing to units of mW and cm, using:

$$P (mW) = P (W) / 1000 \text{ and}$$

$$d (cm) = d(m) / 100$$

Yields

$$S = \frac{30 \times (P/1000) \times G}{3770 \times (d/100)^2} = 0.0796 \times \frac{P \times G}{d^2}$$

Where $d =$ Distance in cm

$P =$ Power in mW

$G =$ Numeric antenna gain

$S =$ Power density in mW / cm²



LIMIT

Power Density Limit, S=1.0mW/cm²

TEST RESULTS

No non-compliance noted.

$$S = \frac{30 \times (P/1000) \times G}{3770 \times (d/100)^2} = 0.0796 \times \frac{P \times G}{d^2}$$

G=3dBi=1.9952623mW

IEEE 802.11b =0.0796*45.39416*1.99526231/400=0.018024

IEEE 802.11g =0.0796*174.9847*1.99526231/400=0.069479

IEEE 802.11n HT20 =0.0796*187.7714*1.99526231/400=0.074556

IEEE 802.11n HT40 =0.0796*179.3178*1.99526231/400=0.071199

Mode	Minimum separation distance (cm)	Output Power (dBm)	Output Power (mw)	Antenna Gain (dBi)	Power Density Limit (mW/cm ²)	Power Density at 20cm (mW/cm ²)
IEEE 802.11b	20.0	16.57	45.39	3.00	1.00	0.018024
IEEE 802.11g	20.0	22.43	174.98	3.00	1.00	0.069479
IEEE 802.11n HT20	20.0	22.74	187.77	3.00	1.00	0.074556
IEEE 802.11n HT40	20.0	22.54	179.32	3.00	1.00	0.071199

REMARK: For mobile or fixed location transmitters, the maximum power density is 1.0 mW/cm² even if the calculation indicates that the power density would be larger.



8.4 POWER SPECTRAL DENSITY

LIMIT

§ 15.247(e) For digitally modulated systems, the power spectral density conducted from the intentional radiator to the antenna shall not greater than 8 dBm in any 3 kHz band during any time interval of continuous transmission.

TEST EQUIPMENTS

Name of Equipment	Manufacturer	Model	Serial Number	Calibration Due
Spectrum Analyzer	R&S	FSEK 30	835253/002	JUL. 14, 2011

TEST SETUP

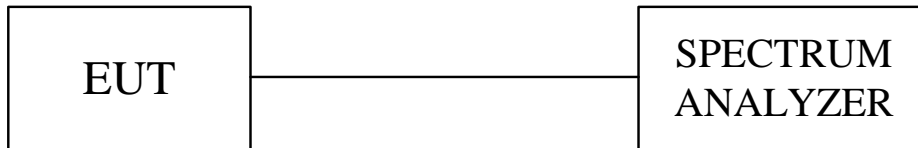

TEST PROCEDURE

The transmitter output was connected to the spectrum analyzer, the bandwidth of the fundamental frequency was measured with the spectrum analyzer using RBW=3KHz and VBW RBW, set sweep time=span / 3KHz.

The power spectral density was measured and recorded.

The sweep time is allowed to be longer than span / 3KHz for a full response of the mixer in the spectrum analyzer.

TEST RESULTS

Total peak power calculation formula:
 $10 \log (10^{\text{Chain 0 PPSD}} / 10)$.

No non-compliance noted.



IEEE 802.11b mode

Channel	Channel Frequency (MHz)	PPSD Chain 0 (dBm)	Maximum Limit (dBm)	Pass / Fail
Low	2412	-13.38	8	PASS
Middle	2437	-10.89	8	PASS
High	2462	-10.49	8	PASS

NOTE : 1. At final test to get the worst-case emission at 11Mbps.
 2. The cable assembly insertion loss of 11.7dB (including 10 dB pad and 1.7 dB cable) was Entered as an offset in the spectrum analyzer to allow for direct reading of power.

IEEE 802.11g mode

Channel	Channel Frequency (MHz)	PPSD Chain 0 (dBm)	Maximum Limit (dBm)	Pass / Fail
Low	2412	-12.87	8	PASS
Middle	2437	-12.64	8	PASS
High	2462	-13.06	8	PASS

NOTE : 1. At final test to get the worst-case emission at 6Mbps.
 2. The cable assembly insertion loss of 11.7dB (including 10 dB pad and 1.7 dB cable) was Entered as an offset in the spectrum analyzer to allow for direct reading of power.

Array Gain=10*LOG((10^(ANTENNA 0/10)+10^(ANTENNA 1/10)+ 10^(ANTENNA 2/10)))=7.77
 Limit=8-(7.77-6)=6.23 dBm

IEEE 802.11n HT20 mode

Channel	Channel Frequency (MHz)	PPSD(dBm)				Maximum Limit (dBm)	Pass / Fail
		Chain 0	Chain 1	Chain 2	Total		
Low	2412	-18.62	-18.53	-19.64	-14.13	6.23	PASS
Middle	2437	-16.48	-16.71	-20.02	-12.69	6.23	PASS
High	2462	-16.61	-18.07	-16.67	-12.30	6.23	PASS

NOTE : 1. At final test to get the worst-case emission at 13Mbps.
 2. The cable assembly insertion loss of 11.7dB (including 10 dB pad and 1.7 dB cable) was Entered as an offset in the spectrum analyzer to allow for direct reading of power.



Array Gain=10*LOG((10^(ANTENNA 0/10)+10^(ANTENNA 1/10)+ 10^(ANTENNA 2/10)))=7.77
Limit=8-(7.77-6)=6.23 dBm

IEEE 802.11n HT40 mode

Channel	Channel Frequency (MHz)	PPSD(dBm)				Maximum Limit (dBm)	Pass / Fail
		Chain 0	Chain 1	Chain 2	Total		
Low	2422	-24.11	-22.50	-23.80	-18.64	6.23	PASS
Middle	2437	-21.91	-21.34	-21.26	-16.72	6.23	PASS
High	2452	-20.71	-18.12	-22.61	-15.32	6.23	PASS

NOTE : 1. At final test to get the worst-case emission at 27Mbps.
2. The cable assembly insertion loss of 11.7dB (including 10 dB pad and 1.7 dB cable) was Entered as an offset in the spectrum analyzer to allow for direct reading of power.

Array Gain=10*LOG((10^(ANTENNA 0/10)+10^(ANTENNA 1/10)+ 10^(ANTENNA 2/10)))=7.77
Limit=8-(7.77-6)=6.23 dBm

Combined mode

Channel	Channel Frequency (MHz)	PPSD(dBm)	Maximum Limit (dBm)	Pass / Fail
802.11n HT20 Combined mode	CH Low	2412	-9.73	6.23 PASS
	CH Middle	2437	-13.49	
	CH High	2462	-9.30	
802.11n HT40 Combined mode	CH Low	2422	-13.46	6.23 PASS
	CH Middle	2437	-15.35	
	CH High	2452	-14.09	



POWER SPECTRAL DENSITY (IEEE 802.11b MODE)

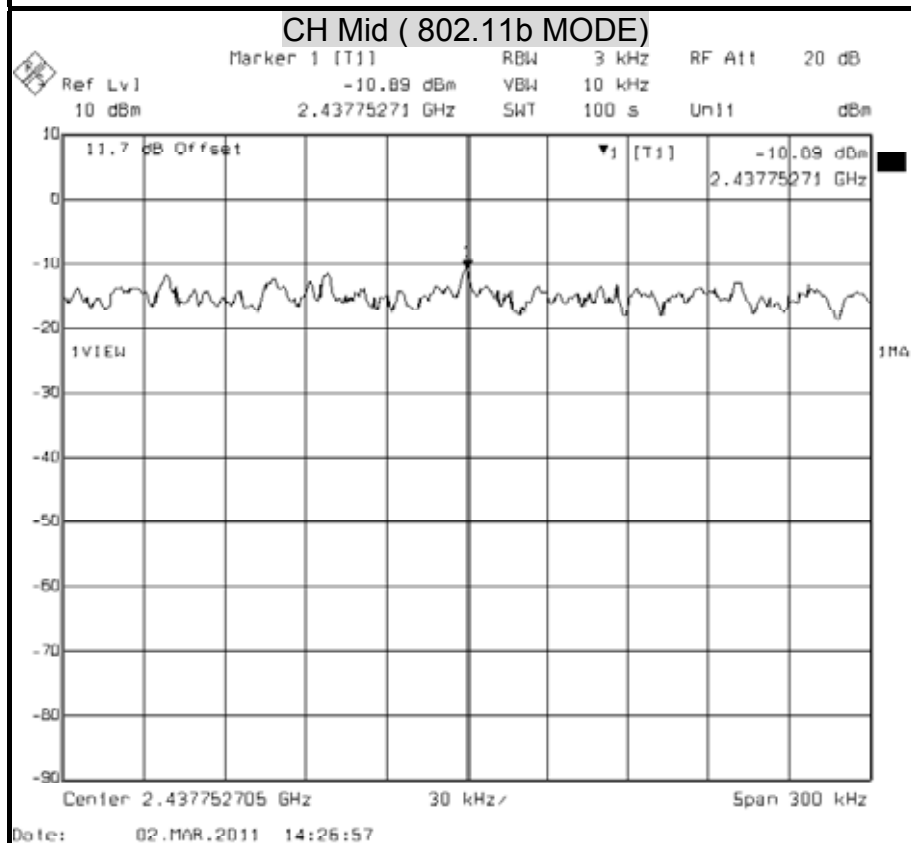
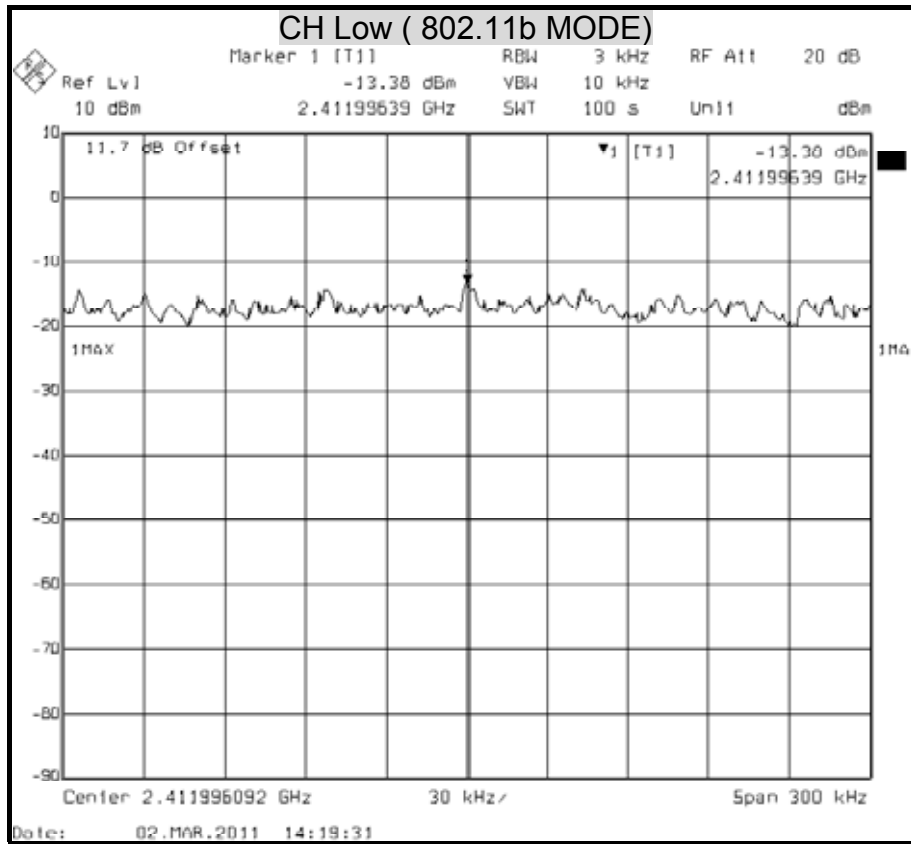

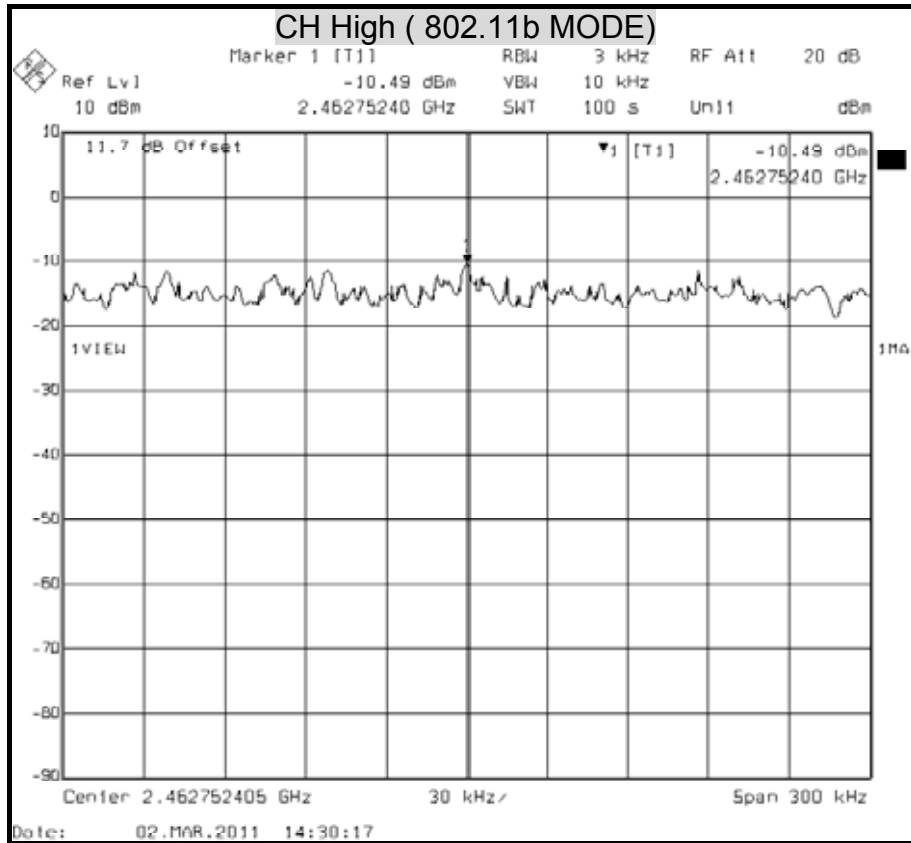



POWER SPECTRAL DENSITY (IEEE 802.11g MODE)

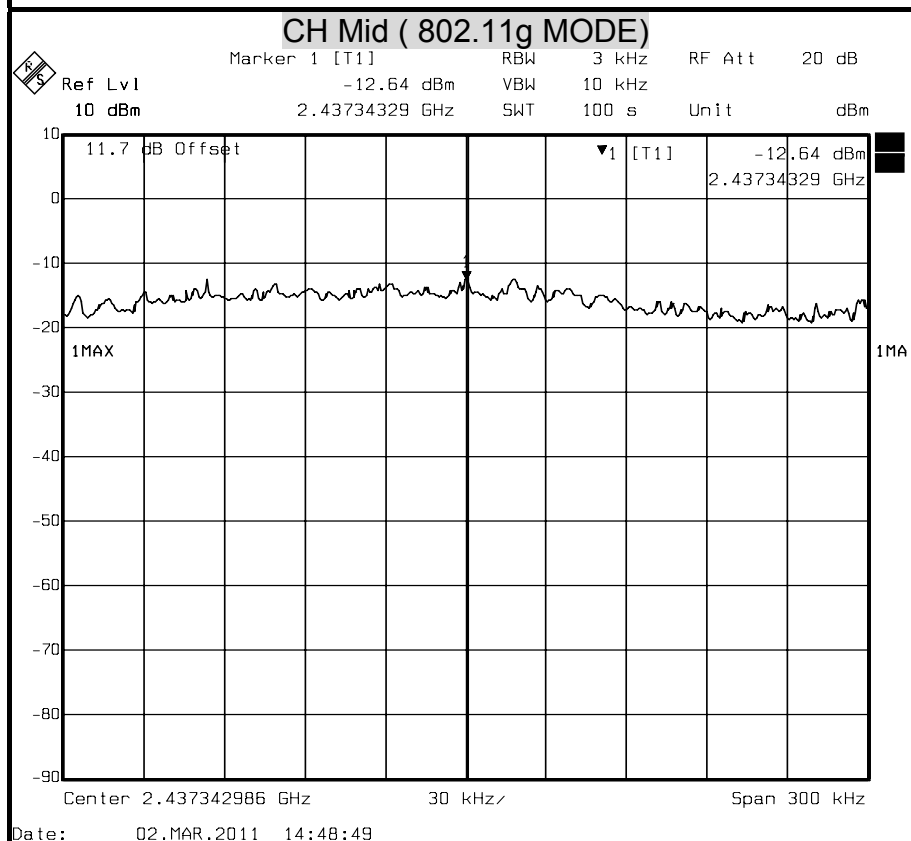
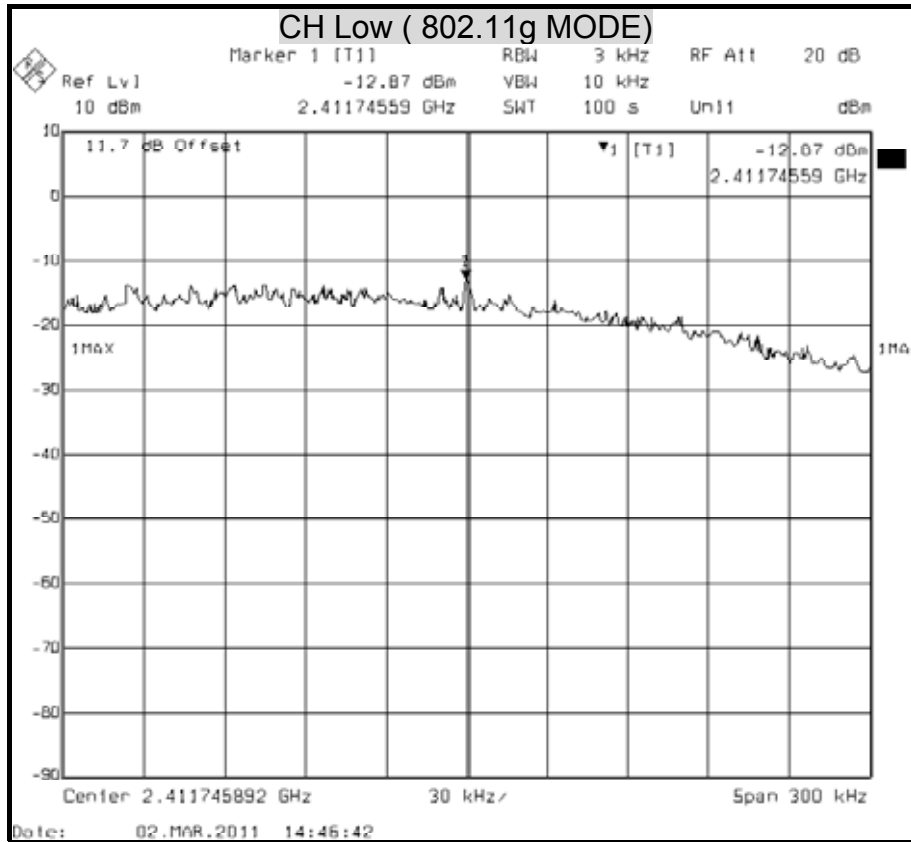

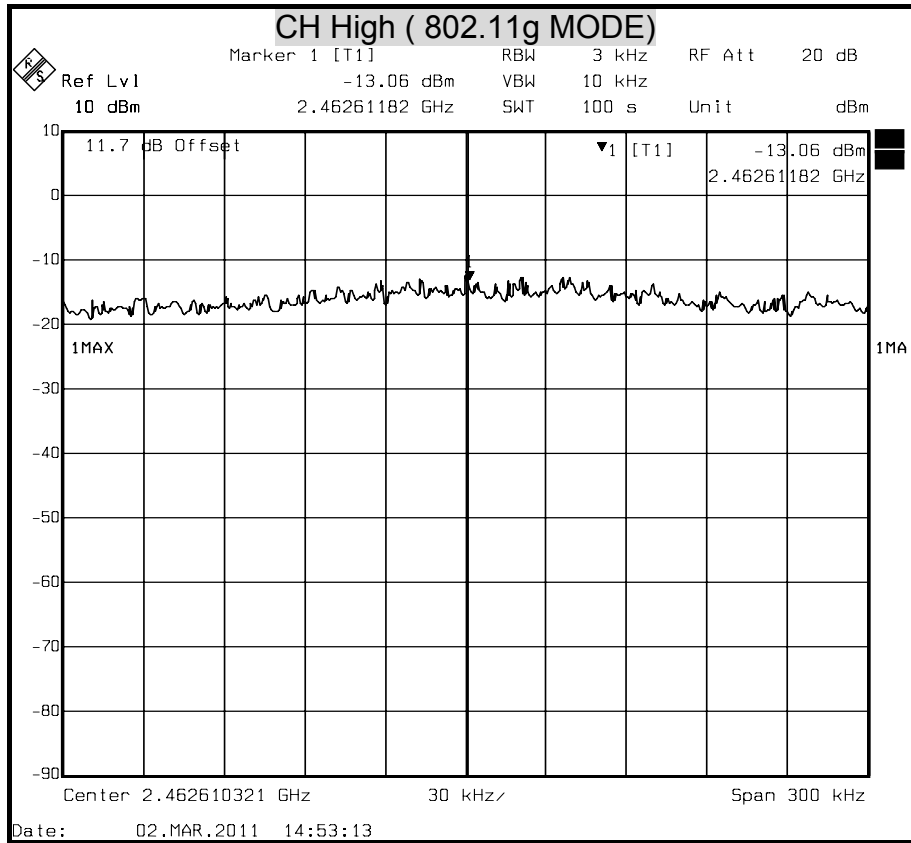



POWER SPECTRAL DENSITY (802.11n HT20 MODE)

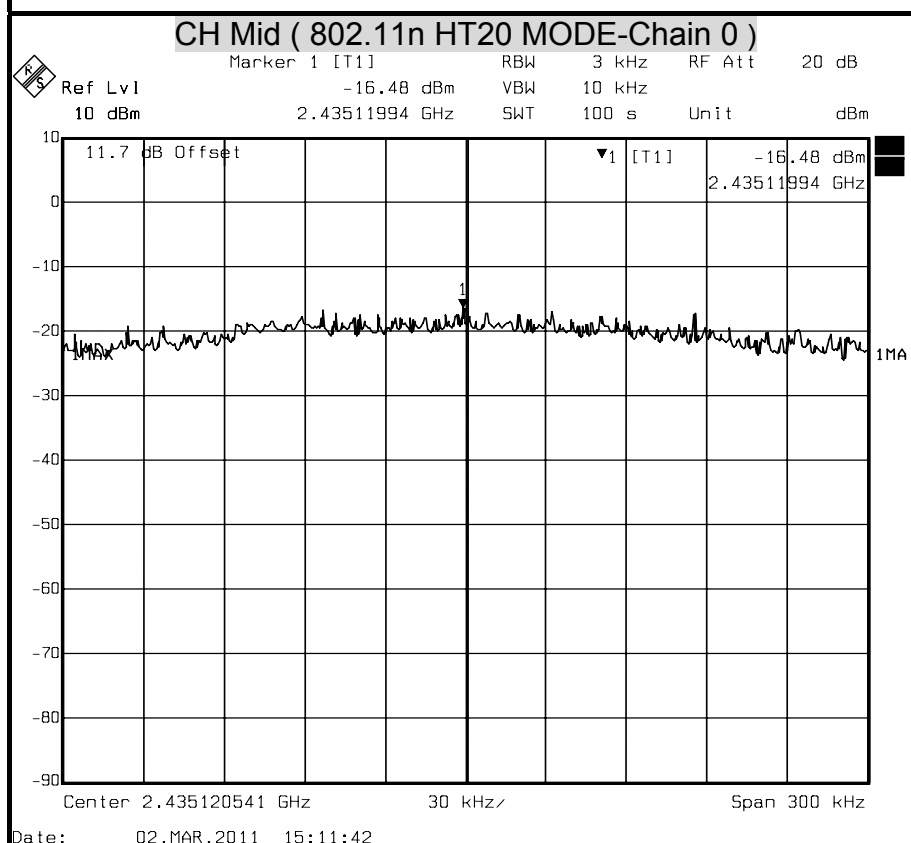
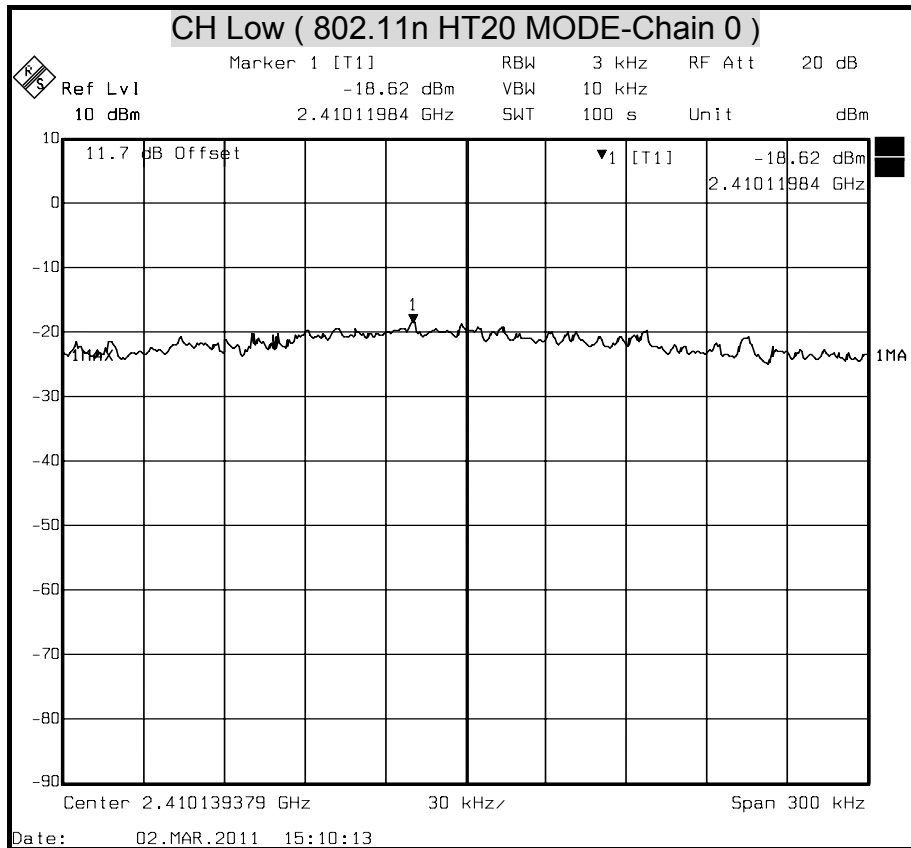

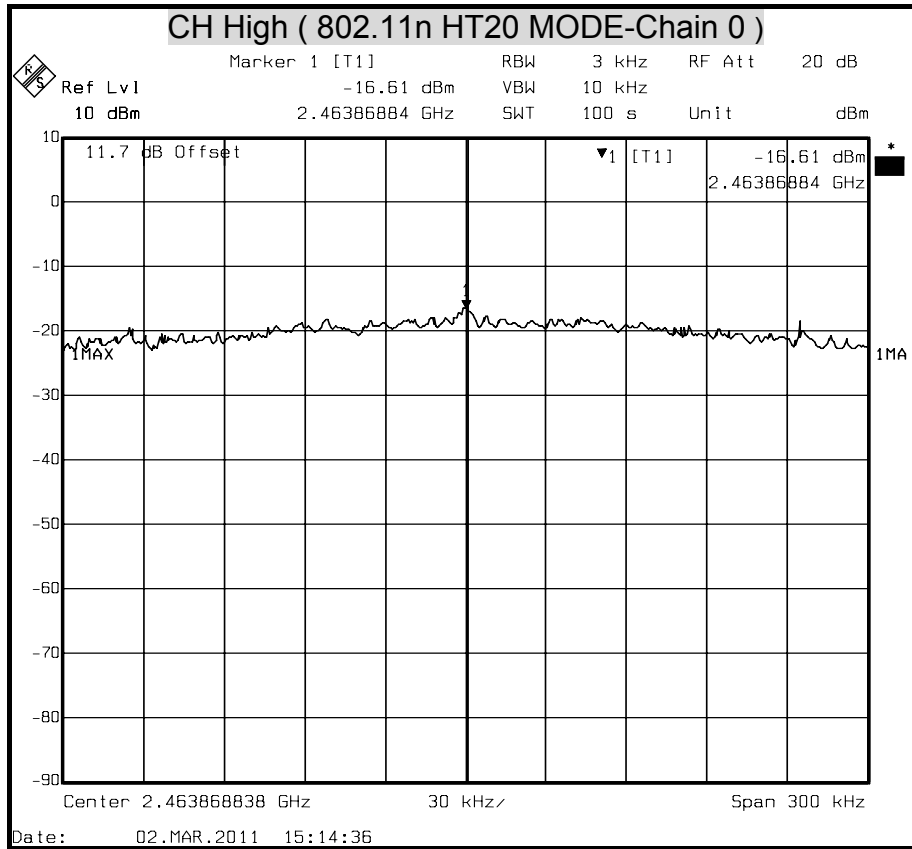



POWER SPECTRAL DENSITY (802.11n HT20 MODE)

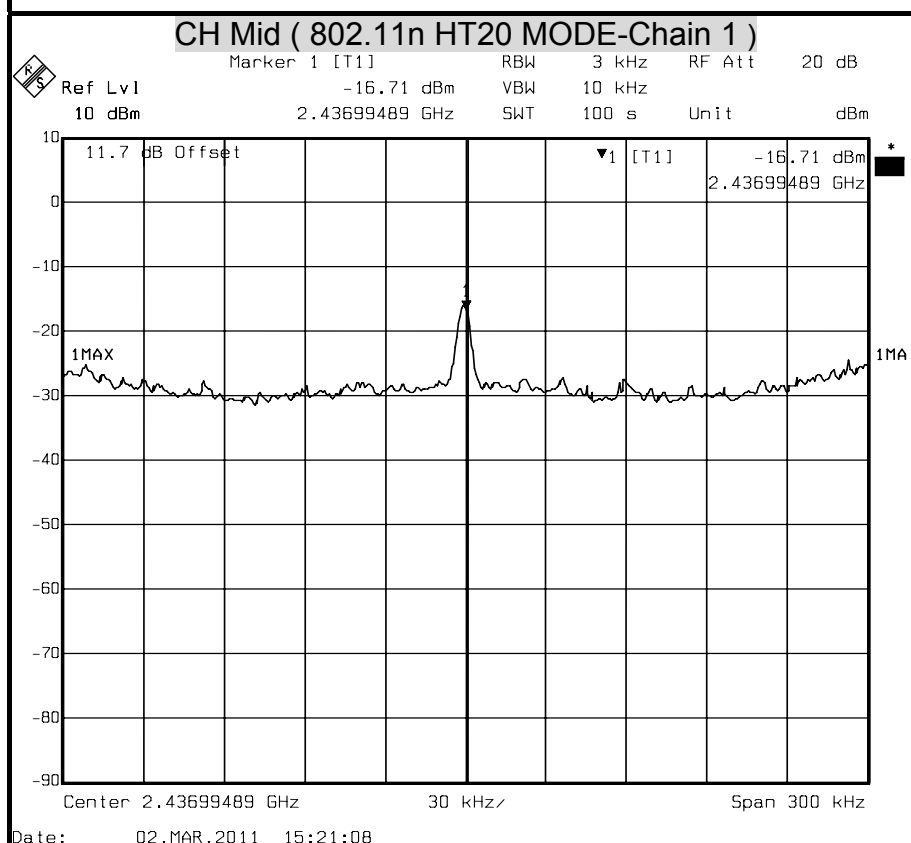
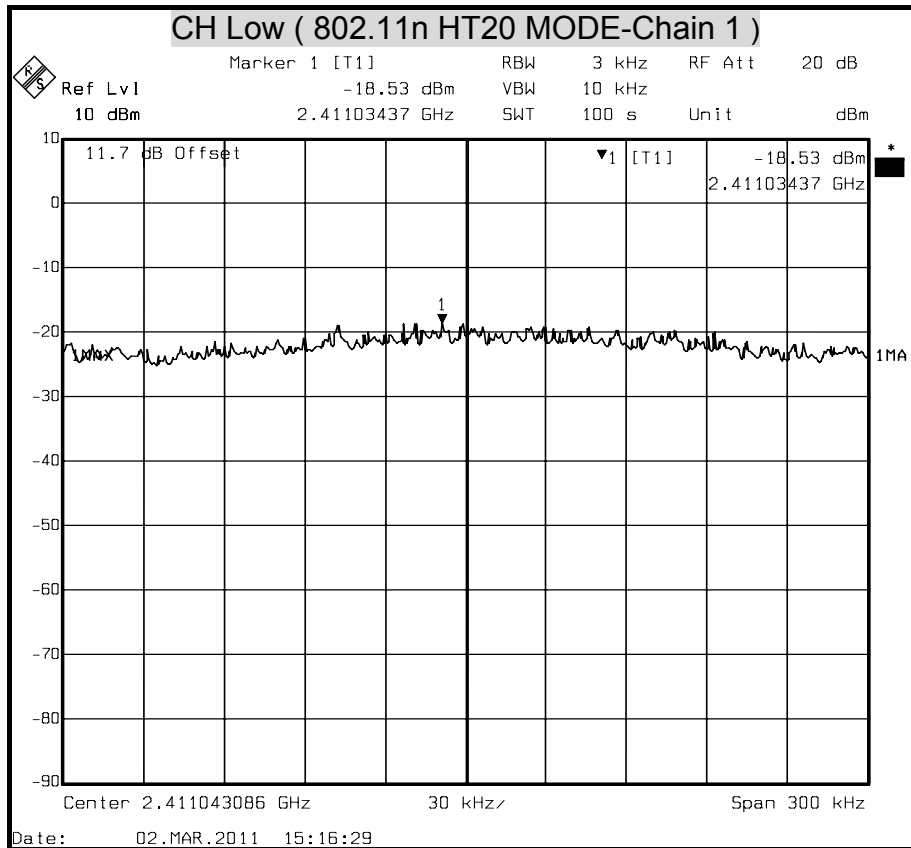

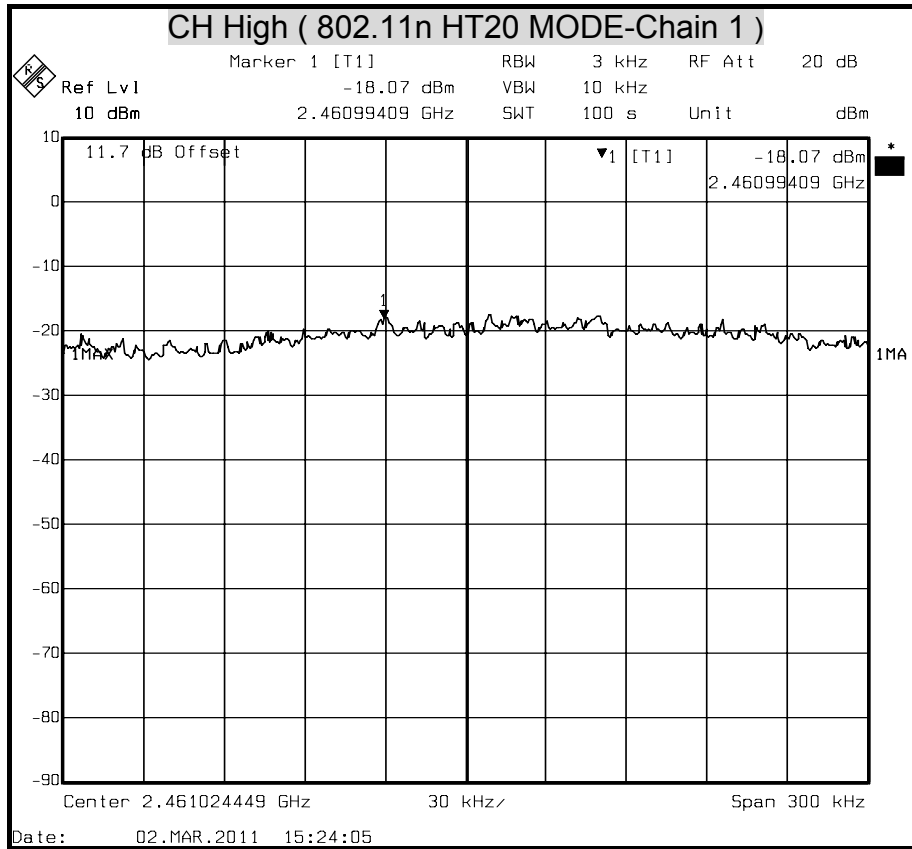



POWER SPECTRAL DENSITY (802.11n HT20 MODE)

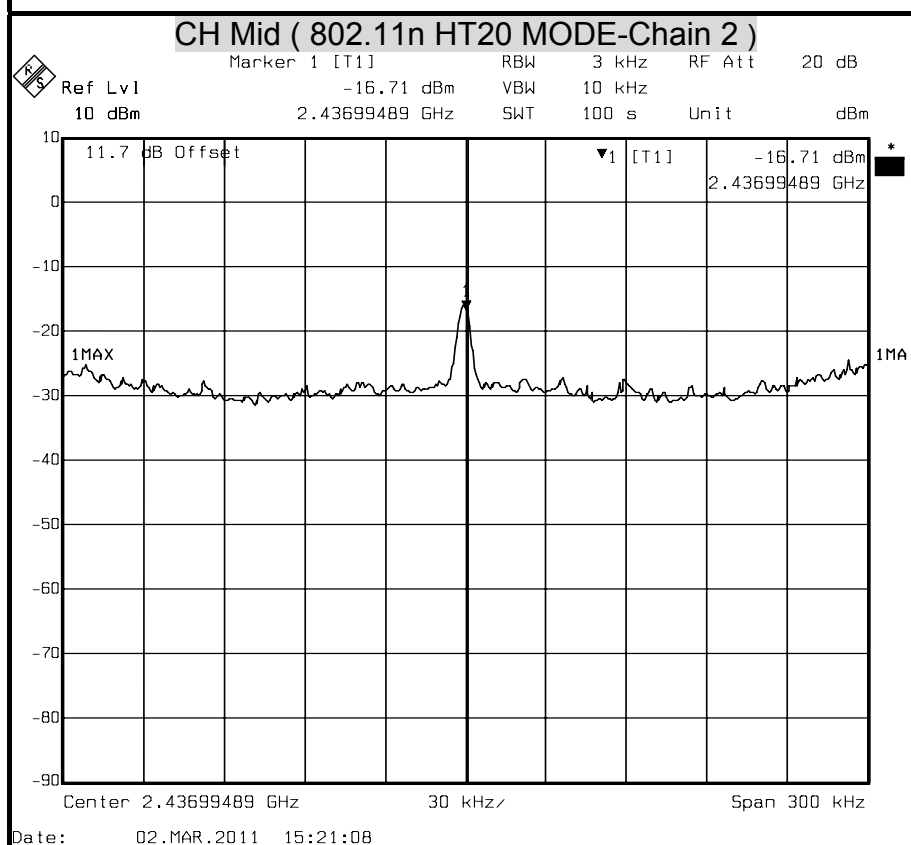
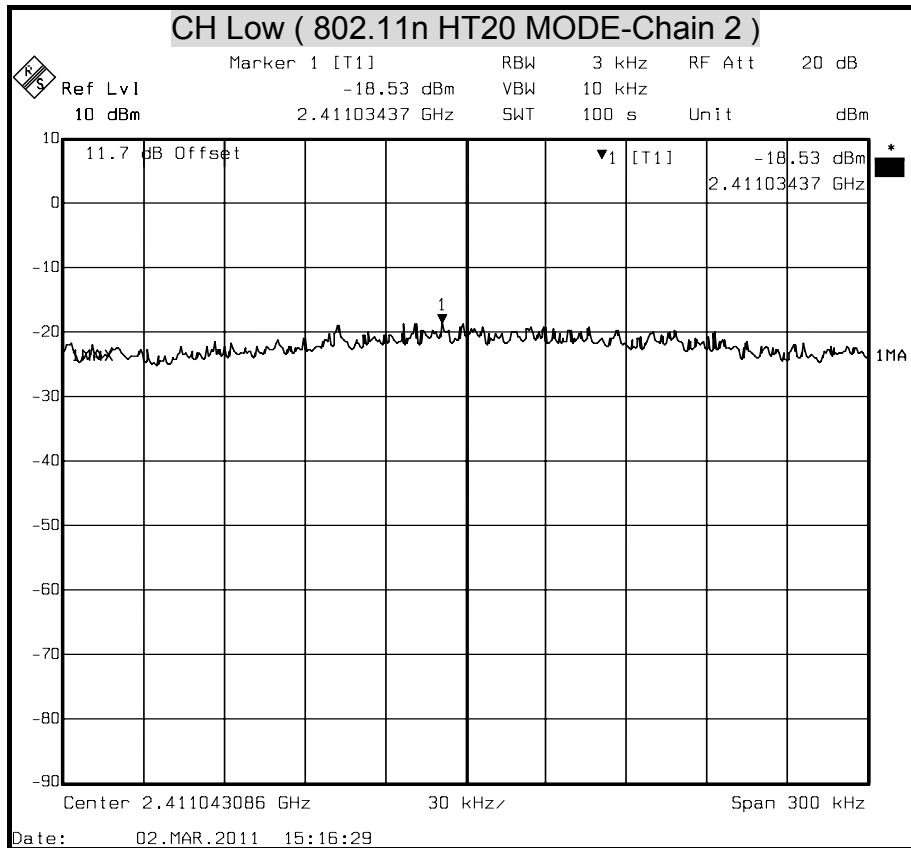

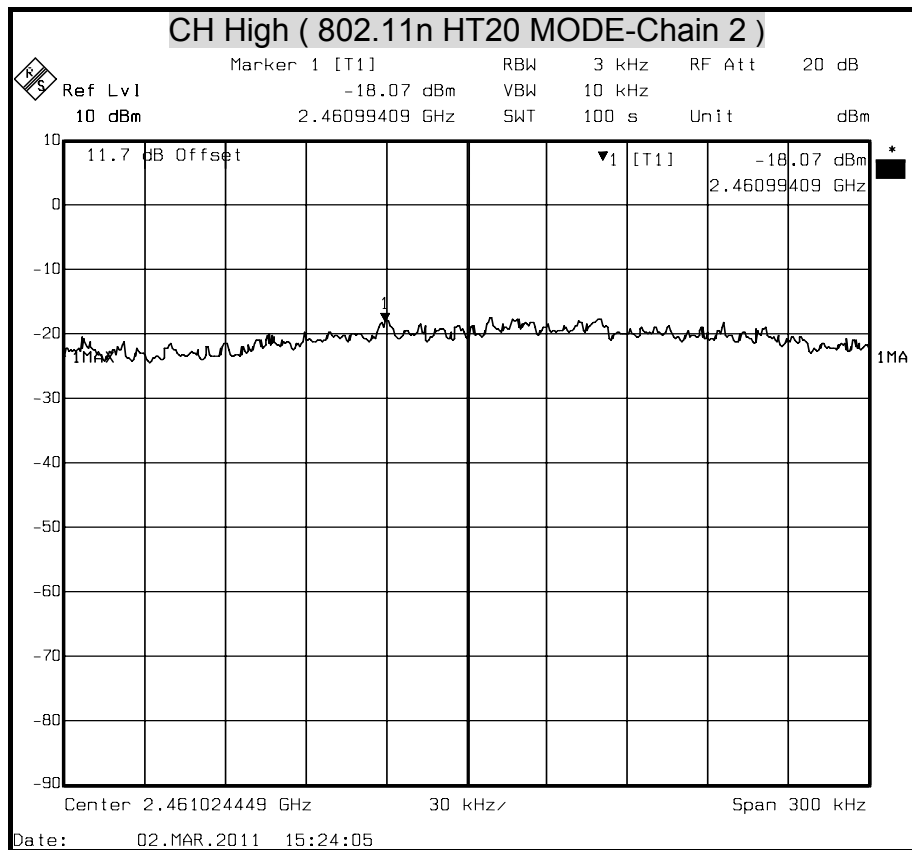



POWER SPECTRAL DENSITY (802.11n HT40 MODE)

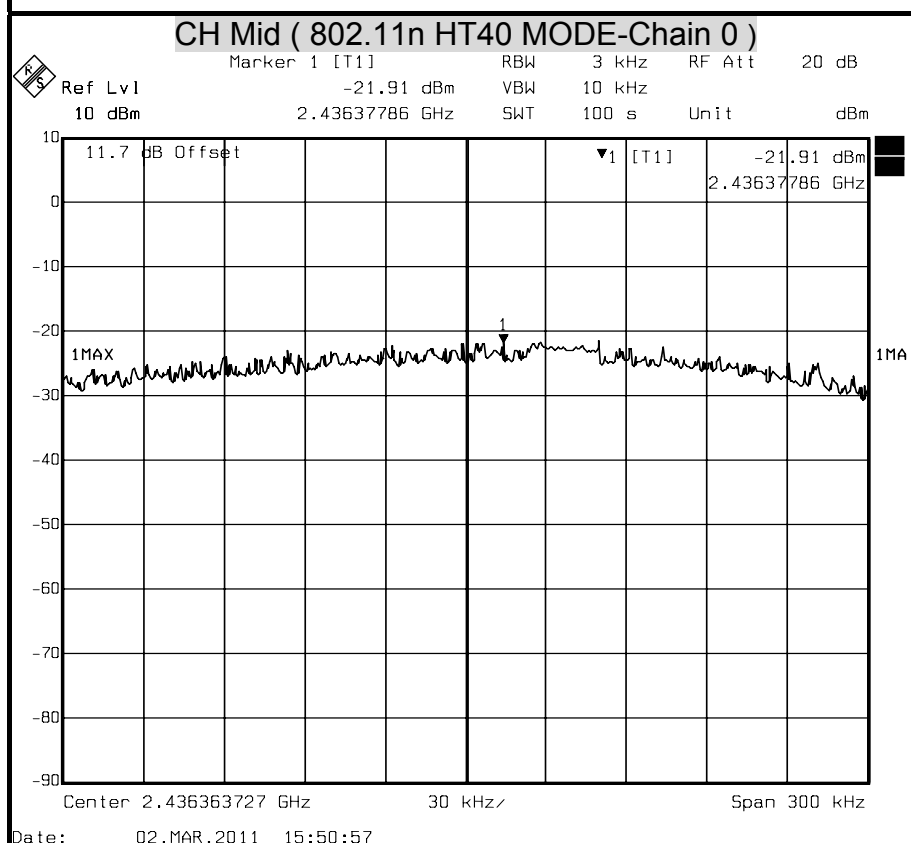
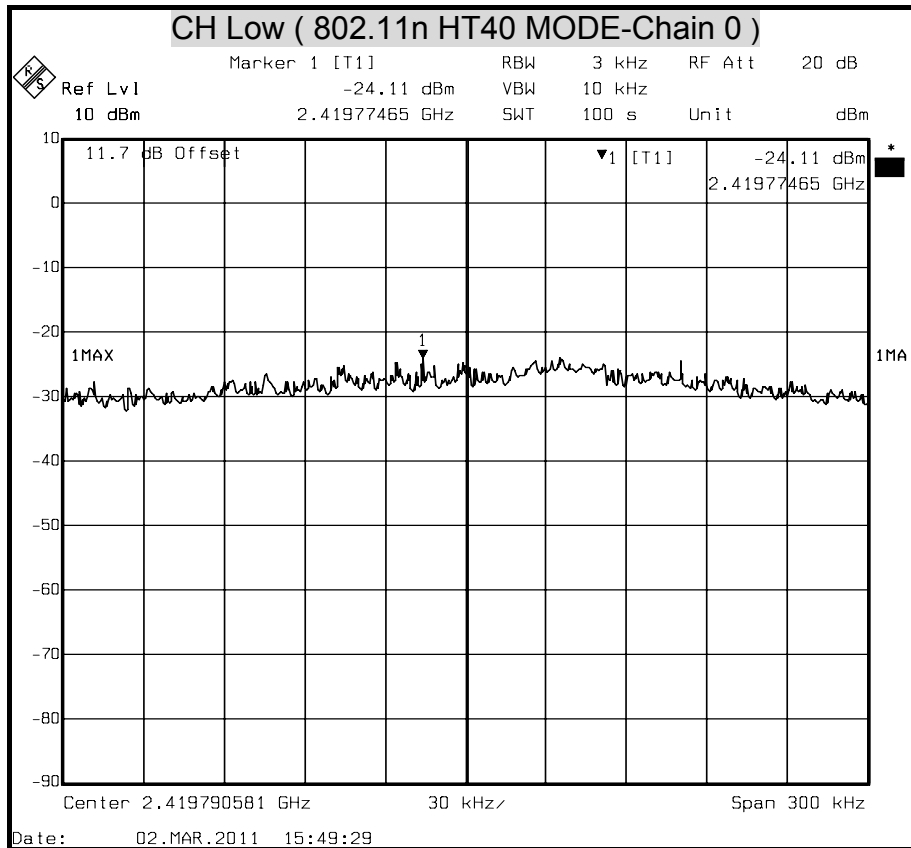

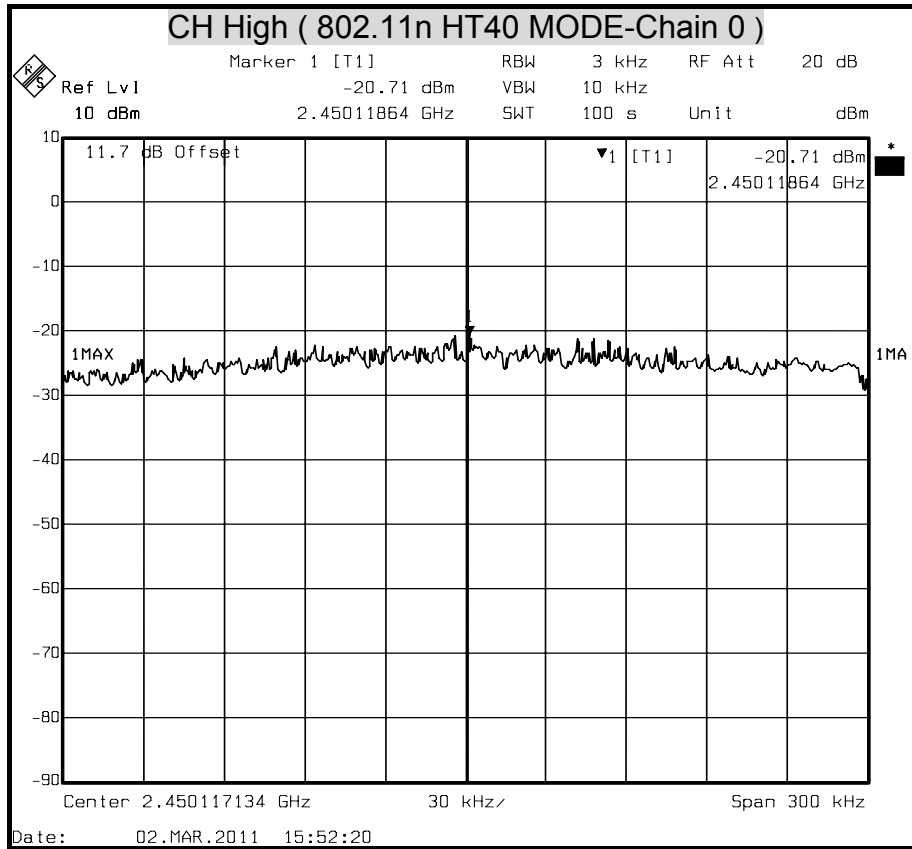



POWER SPECTRAL DENSITY (802.11n HT40 MODE)

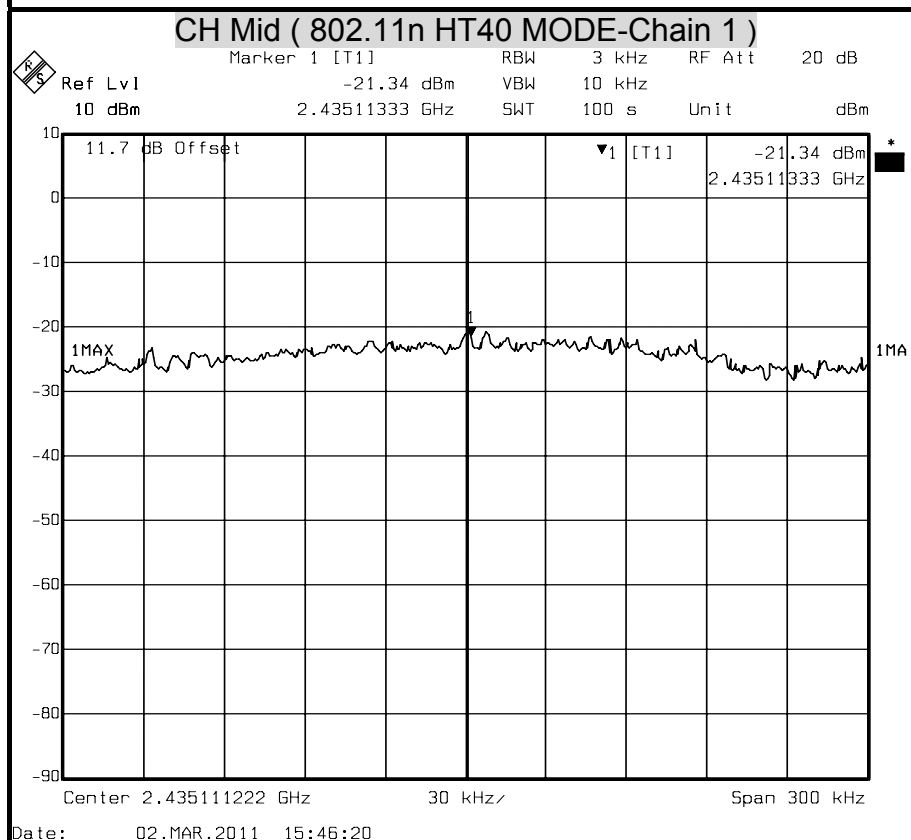
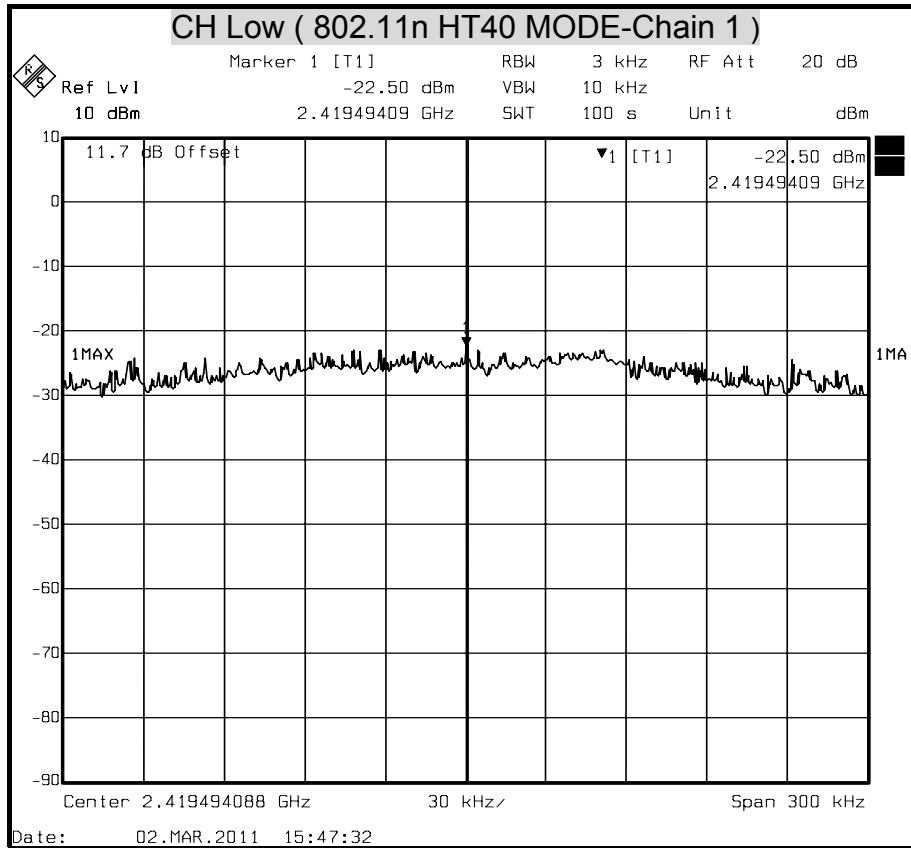

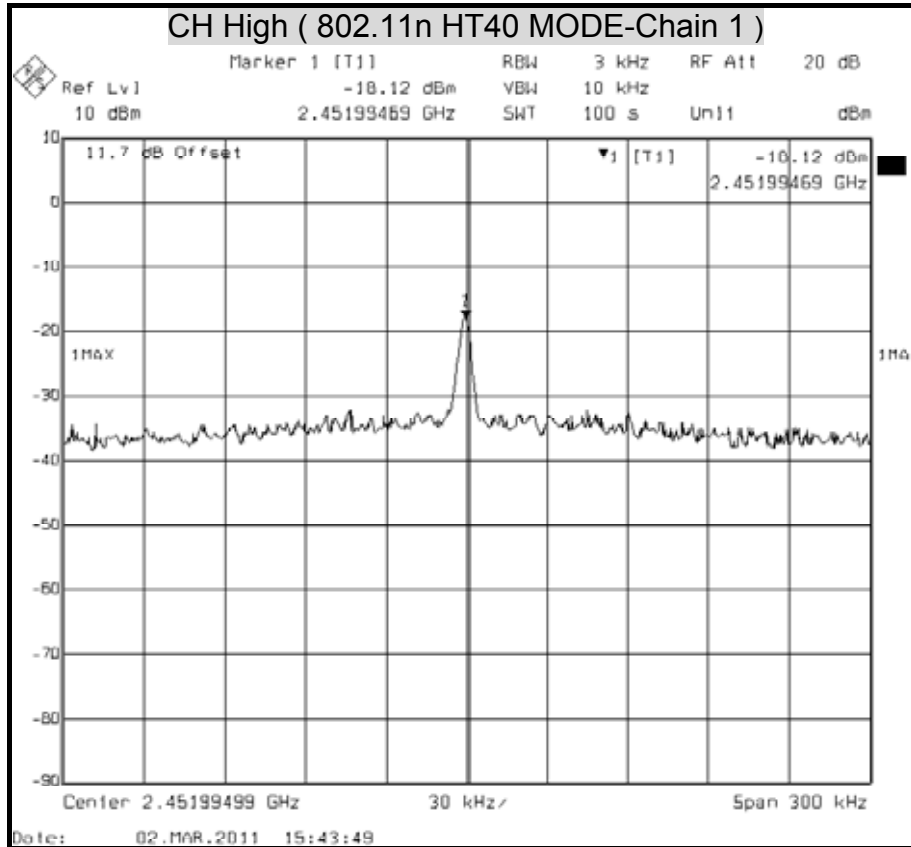



POWER SPECTRAL DENSITY (802.11n HT40 MODE)

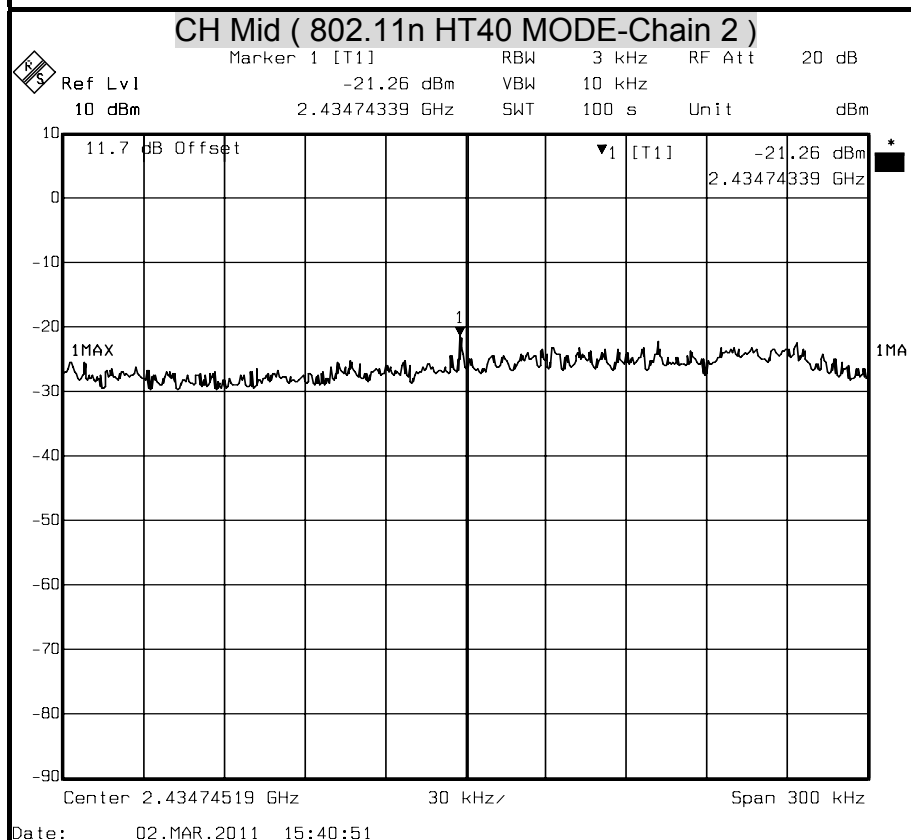
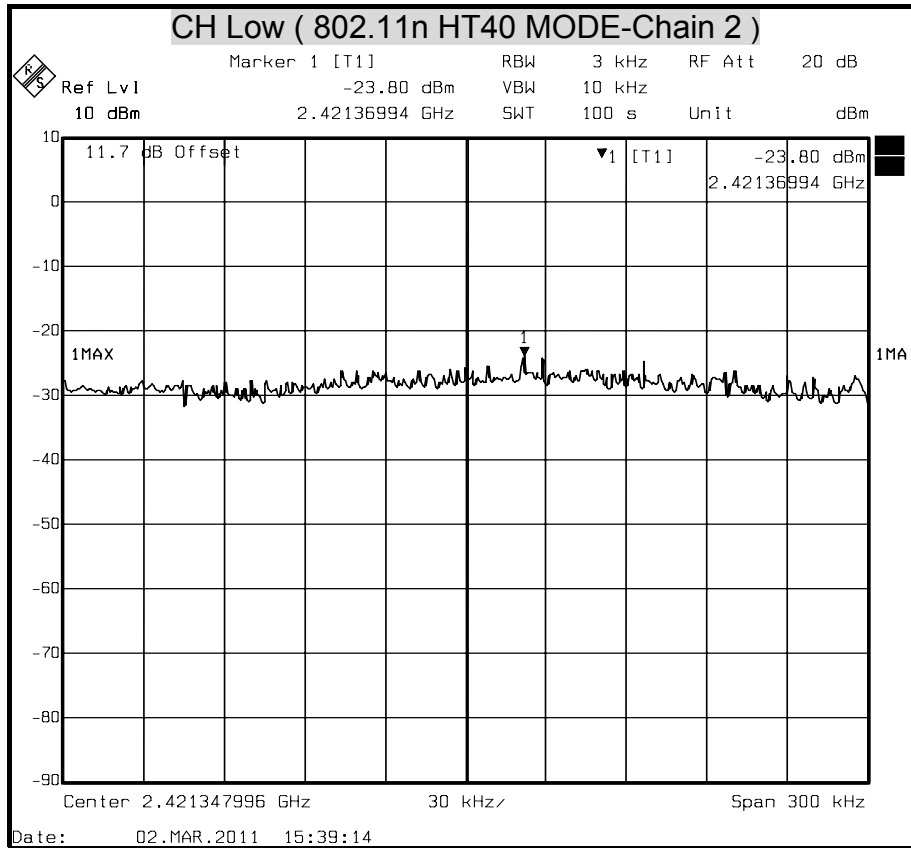

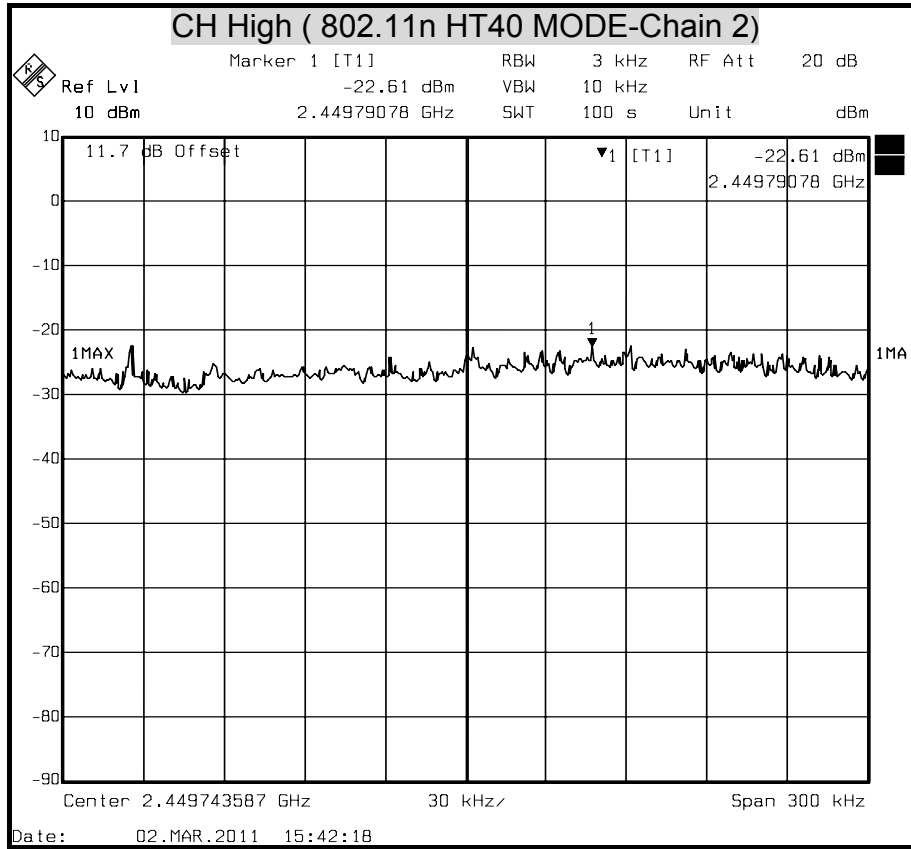



POWER SPECTRAL DENSITY (802.11n HT20 Combined MODE)

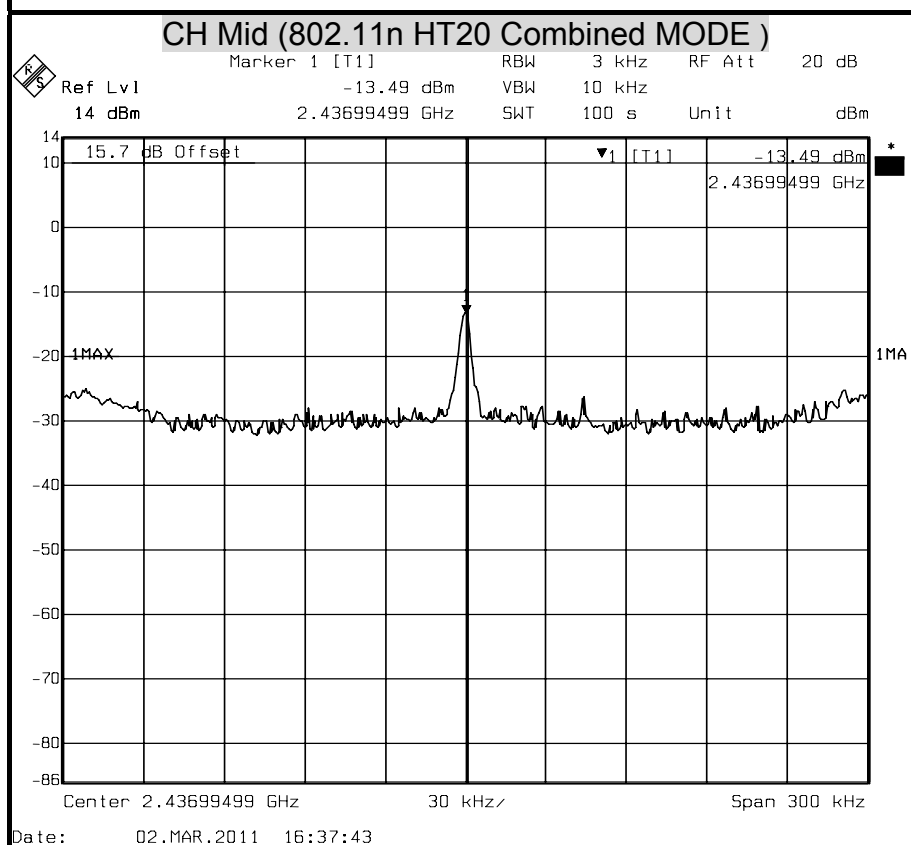
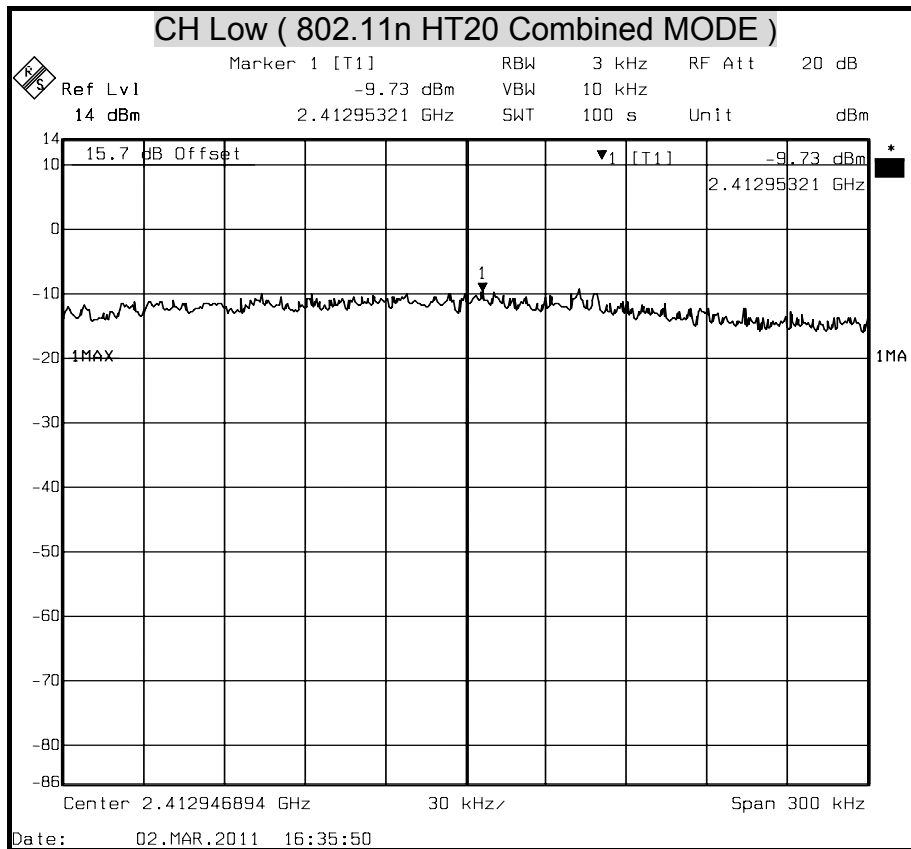

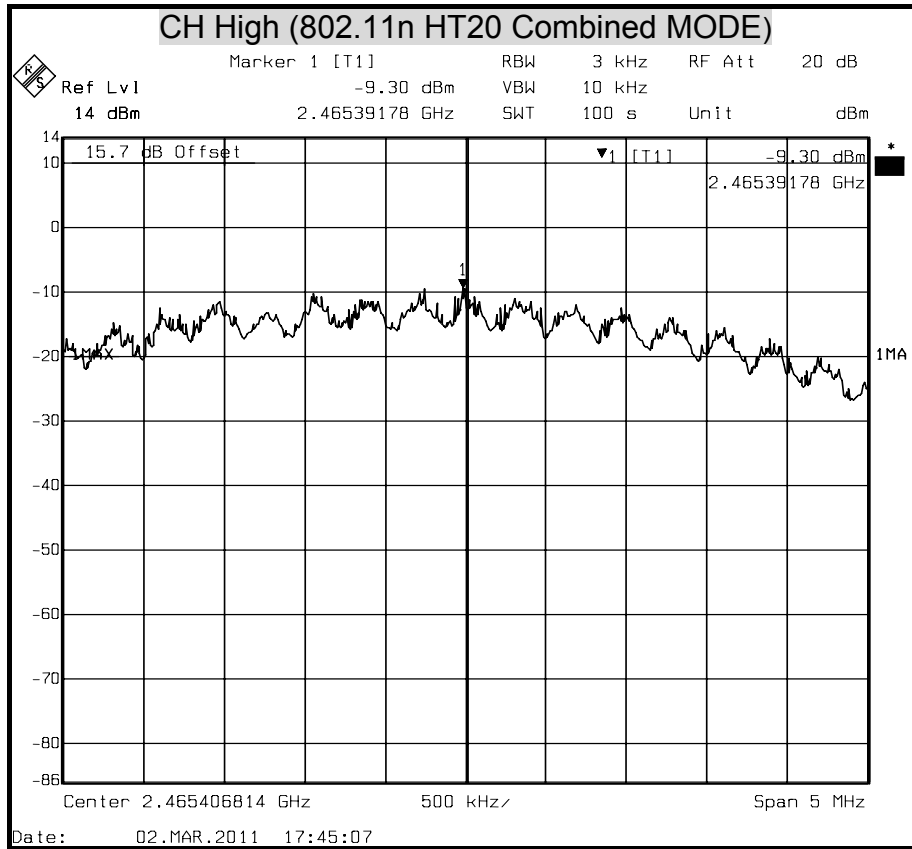



POWER SPECTRAL DENSITY (802.11n HT40 Combined MODE)

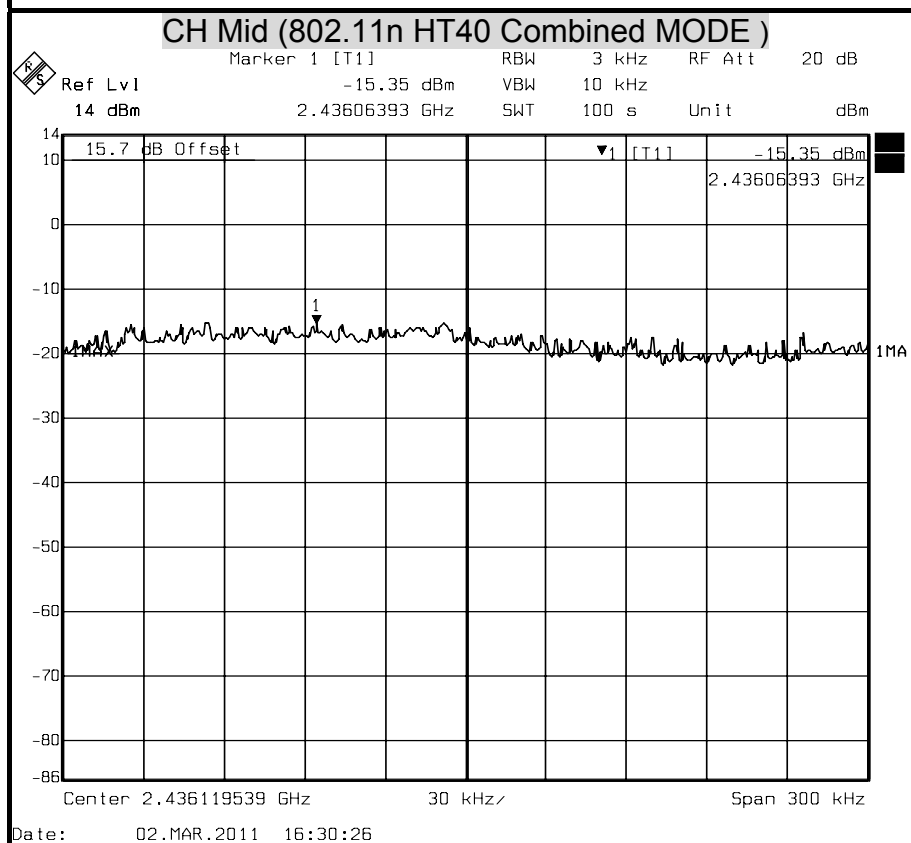
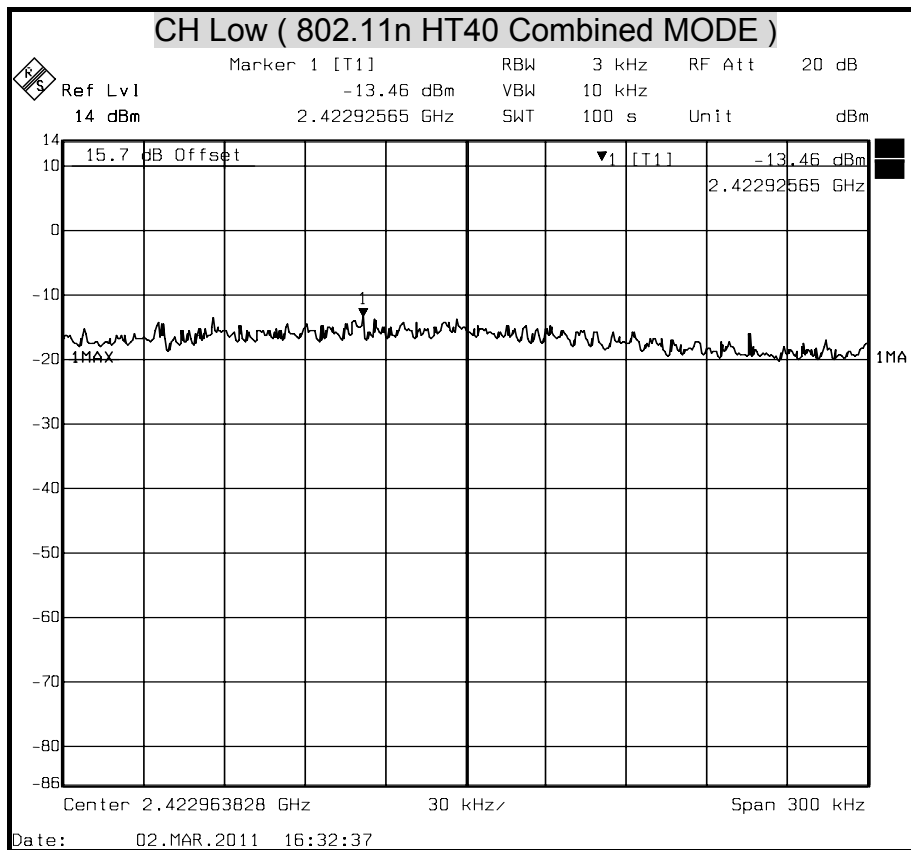

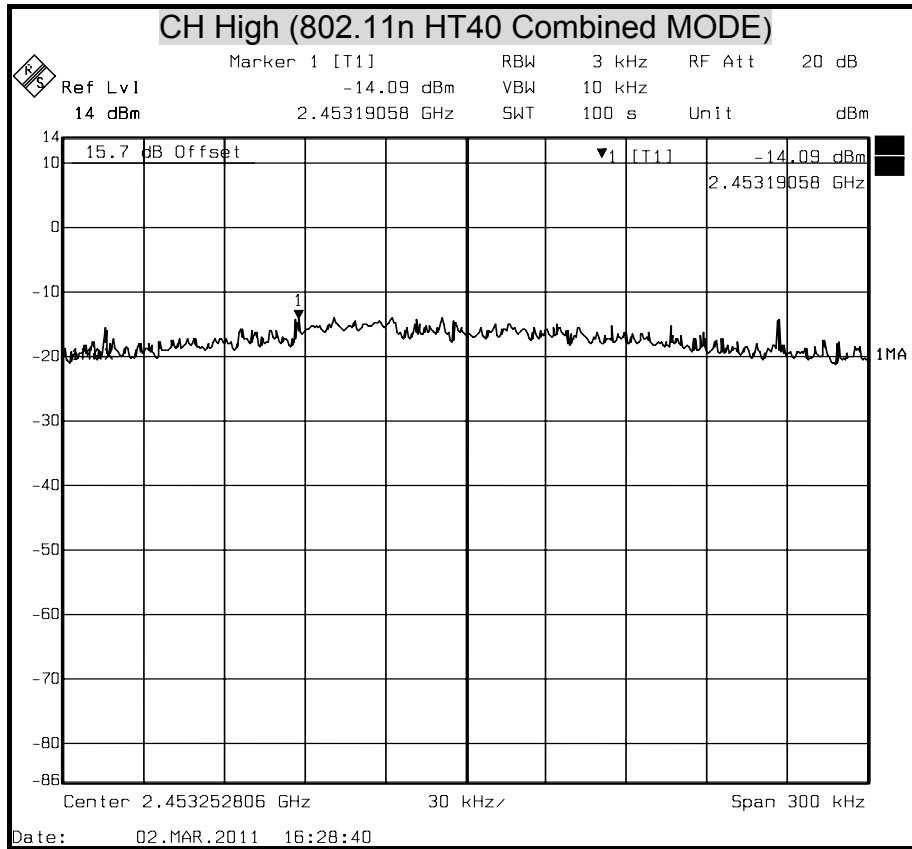



8.5 CONDUCTED SPURIOUS EMISSION

LIMITS

§ 15.247(d) In any 100 kHz bandwidth outside the frequency band in which the spread spectrum intentional radiator is operating, the radio frequency power that is produced by the intentional radiator shall be at least 20 dB below that in the 100 kHz bandwidth within the band that contains the highest level of the desired power, based on either an RF conducted or a radiated measurement. Attenuation below the general limits specified in § 15.209(a) is not required. In addition, radiated emissions which fall in the restricted bands, as defined in § 15.205(a), must also comply with the radiated emission limits specified in § 15.209(a) (see § 15.205(c)).

TEST PROCEDURE

The transmitter output is connected to a spectrum analyzer. The resolution bandwidth is set to 100 kHz. The video bandwidth is set to 100 kHz.

The spectrum from 30 MHz to 26.5 GHz is investigated with the transmitter set to the lowest, middle, and highest channels in the 2.4 GHz band.

TEST SETUP

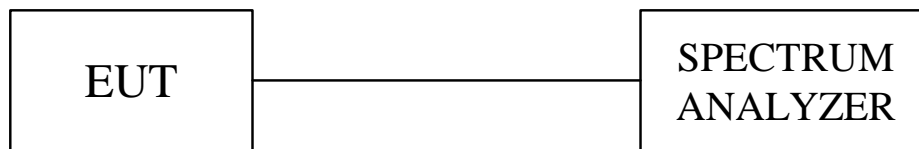

TEST RESULTS

No non-compliance noted.



802.11b Mode

CH Low

Frequency (MHz)	Offset (dB)	Reading (dBuV)	Level (dBuV)	Limit (dBuV)	Margin (dB)
2412	11.7	95.90	107.6	N/A	N/A
2400	11.7	49.14	60.84	87.60	-26.76
2630.98196	11.7	41.13	52.83	87.60	-34.77
6955.91182	11.7	45.19	56.89	87.60	-30.71

CH Mid

Frequency (MHz)	Offset (dB)	Reading (dBuV)	Level (dBuV)	Limit (dBuV)	Margin (dB)
2437	11.7	97.47	109.17	N/A	N/A
2400	11.7	41.15	52.85	89.17	-36.32
2369.0982	11.7	42.90	54.6	89.17	-34.57
6908.81764	11.7	44.02	55.72	89.17	-33.45

CH High

Frequency (MHz)	Offset (dB)	Reading (dBuV)	Level (dBuV)	Limit (dBuV)	Margin (dB)
2462	11.7	96.84	108.54	N/A	N/A
2400	11.7	40.74	52.44	88.54	-36.10
1553.68737	11.7	38.37	50.07	88.54	-38.47
6748.69739	11.7	43.57	55.27	88.54	-33.27

802.11g Mode

CH Low

Frequency (MHz)	Offset (dB)	Reading (dBuV)	Level (dBuV)	Limit (dBuV)	Margin (dB)
2412	11.7	93.47	105.17	N/A	N/A
2400	11.7	65.21	76.91	85.17	-8.26
1756.0521	11.7	42.30	54	85.17	-31.17
3188.37675	11.7	45.27	56.97	85.17	-28.20

CH Mid

Frequency (MHz)	Offset (dB)	Reading (dBuV)	Level (dBuV)	Limit (dBuV)	Margin (dB)
2437	11.7	94.44	106.14	N/A	N/A
2400	11.7	45.97	57.67	86.14	-28.47
1642.96593	11.7	40.00	51.7	86.14	-34.44
3235.47094	11.7	47.22	58.92	86.14	-27.22

CH High

Frequency (MHz)	Offset (dB)	Reading (dBuV)	Level (dBuV)	Limit (dBuV)	Margin (dB)
2462	11.7	94.20	105.9	N/A	N/A
2400	11.7	45.57	57.27	85.90	-28.63
1517.97595	11.7	39.83	51.53	85.90	-34.37
3282.56513	11.7	47.02	58.72	85.90	-27.18



802.11n HT20 Mode Chain 0

CH Low

Frequency (MHz)	Offset (dB)	Reading (dBuV)	Level (dBuV)	Limit (dBuV)	Margin (dB)
2412	11.7	89.28	100.98	N/A	N/A
2400	11.7	59.86	71.56	80.98	-9.42
2630.98196	11.7	41.24	52.94	80.98	-28.04
6955.91182	11.7	45.58	57.28	80.98	-23.70

CH Mid

Frequency (MHz)	Offset (dB)	Reading (dBuV)	Level (dBuV)	Limit (dBuV)	Margin (dB)
2437	11.7	87.61	99.31	N/A	N/A
2400	11.7	42.75	54.45	79.31	-24.86
1660.92164	11.7	40.53	52.23	79.31	-27.08
3235.47094	11.7	44.23	55.93	79.31	-23.38

CH High

Frequency (MHz)	Offset (dB)	Reading (dBuV)	Level (dBuV)	Limit (dBuV)	Margin (dB)
2462	11.7	90.13	101.83	N/A	N/A
2400	11.7	43.56	55.26	81.83	-26.57
1714.38878	11.7	41.54	53.24	81.83	-28.59
6579.15832	11.7	44.83	56.53	81.83	-25.30

802.11n HT20 Mode Chain 1

CH Low

Frequency (MHz)	Offset (dB)	Reading (dBuV)	Level (dBuV)	Limit (dBuV)	Margin (dB)
2412	11.7	87.94	99.64	N/A	N/A
2400	11.7	59.46	71.16	79.64	-8.48
2154.92966	11.7	41.52	53.22	79.64	-26.42
6955.91182	11.7	44.42	56.12	79.64	-23.52

CH Mid

Frequency (MHz)	Offset (dB)	Reading (dBuV)	Level (dBuV)	Limit (dBuV)	Margin (dB)
2437	11.7	93.45	105.15	N/A	N/A
2400	11.7	43.88	55.58	85.15	-29.57
2327.43487	11.7	44.61	56.31	85.15	-28.84
3235.47094	11.7	47.95	59.65	85.15	-25.50

CH High

Frequency (MHz)	Offset (dB)	Reading (dBuV)	Level (dBuV)	Limit (dBuV)	Margin (dB)
2462	11.7	88.88	100.58	N/A	N/A
2400	11.7	42.44	54.14	80.58	-26.44
2351.24248	11.7	43.74	55.44	80.58	-25.14
3282.56513	11.7	48.85	60.55	80.58	-20.03



802.11n HT20 Mode Chain 2

CH Low

Frequency (MHz)	Offset (dB)	Reading (dBuV)	Level (dBuV)	Limit (dBuV)	Margin (dB)
2412	11.7	87.89	99.59	N/A	N/A
2400	11.7	59.15	70.85	79.59	-8.74
1119.1984	11.7	40.27	51.97	79.59	-27.62
6955.91182	11.7	44.94	56.64	79.59	-22.95

CH Mid

Frequency (MHz)	Offset (dB)	Reading (dBuV)	Level (dBuV)	Limit (dBuV)	Margin (dB)
2437	11.7	87.84	99.54	N/A	N/A
2400	11.7	43.38	55.08	79.54	-24.46
2333.38677	11.7	41.82	53.52	79.54	-26.02
3235.47094	11.7	44.80	56.5	79.54	-23.04

CH High

Frequency (MHz)	Offset (dB)	Reading (dBuV)	Level (dBuV)	Limit (dBuV)	Margin (dB)
2462	11.7	90.38	102.08	N/A	N/A
2400	11.7	43.99	55.69	82.08	-26.39
2321.48297	11.7	43.63	55.33	82.08	-26.75
3282.56513	11.7	46.37	58.07	82.08	-24.01



802.11n HT40 Mode Chain 0

CH Low

Frequency (MHz)	Offset (dB)	Reading (dBuV)	Level (dBuV)	Limit (dBuV)	Margin (dB)
2422	11.7	83.91	95.61	N/A	N/A
2400	11.7	59.47	71.17	75.61	-4.44
2321.48297	11.7	41.88	53.58	75.61	-22.03
6955.91182	11.7	44.67	56.37	75.61	-19.24

CH Mid

Frequency (MHz)	Offset (dB)	Reading (dBuV)	Level (dBuV)	Limit (dBuV)	Margin (dB)
2437	11.7	84.93	96.63	N/A	N/A
2400	11.7	44.16	55.86	76.63	-20.77
1738.19639	11.7	40.55	52.25	35.86	16.39
6955.91182	11.7	45.52	57.22	76.63	-19.41

CH High

Frequency (MHz)	Offset (dB)	Reading (dBuV)	Level (dBuV)	Limit (dBuV)	Margin (dB)
2452	11.7	84.49	96.19	N/A	N/A
2400	11.7	43.77	55.47	76.19	-20.72
1797.71543	11.7	41.48	53.18	76.19	-23.01
6955.91182	11.7	45.25	56.95	76.19	-19.24

802.11n HT40 Mode Chain 1

CH Low

Frequency (MHz)	Offset (dB)	Reading (dBuV)	Level (dBuV)	Limit (dBuV)	Margin (dB)
2422	11.7	85.12	96.82	N/A	N/A
2400	11.7	58.67	70.37	76.82	-6.45
1821.52305	11.7	41.01	52.71	76.82	-24.11
3188.37675	11.7	48.59	60.29	76.82	-16.53

CH Mid

Frequency (MHz)	Offset (dB)	Reading (dBuV)	Level (dBuV)	Limit (dBuV)	Margin (dB)
2437	11.7	85.54	97.24	N/A	N/A
2400	11.7	49.93	61.63	77.24	-15.61
1702.48497	11.7	40.54	52.24	77.24	-25.00
3235.47094	11.7	46.53	58.23	77.24	-19.01

CH High

Frequency (MHz)	Offset (dB)	Reading (dBuV)	Level (dBuV)	Limit (dBuV)	Margin (dB)
2452	11.7	83.95	95.65	N/A	N/A
2400	11.7	41.96	53.66	75.65	-21.99
2351.24248	11.7	44.01	55.71	75.65	-19.94
3235.47094	11.7	46.38	58.08	75.65	-17.57



802.11n HT40 Mode Chain 2

CH Low

Frequency (MHz)	Offset (dB)	Reading (dBuV)	Level (dBuV)	Limit (dBuV)	Margin (dB)
2422	11.7	85.05	96.75	N/A	N/A
2400	11.7	57.84	69.54	76.75	-7.21
2327.43487	11.7	44.04	55.74	76.75	-21.01
3188.37675	11.7	49.53	61.23	76.75	-15.52

CH Mid

Frequency (MHz)	Offset (dB)	Reading (dBuV)	Level (dBuV)	Limit (dBuV)	Margin (dB)
2437	11.7	85.01	96.71	N/A	N/A
2400	11.7	48.49	60.19	76.71	-16.52
1726.29259	11.7	40.88	52.58	76.71	-24.13
3235.47094	11.7	46.83	58.53	76.71	-18.18

CH High

Frequency (MHz)	Offset (dB)	Reading (dBuV)	Level (dBuV)	Limit (dBuV)	Margin (dB)
2452	11.7	84.17	95.87	N/A	N/A
2400	11.7	42.55	54.25	75.87	-21.62
1964.36874	11.7	41.38	53.08	75.87	-22.79
3235.47094	11.7	46.40	58.1	75.87	-17.77



802.11n HT20 Combined Mode

CH Low

Frequency (MHz)	Offset (dB)	Reading (dBuV)	Level (dBuV)	Limit (dBuV)	Margin (dB)
2412	15.7	89.17	104.87	N/A	N/A
2400	15.7	63.64	79.34	84.87	-5.53
1815.57114	15.7	40.71	56.41	84.87	-28.46
3188.37675	15.7	46.00	61.7	84.87	-23.17

CH Mid

Frequency (MHz)	Offset (dB)	Reading (dBuV)	Level (dBuV)	Limit (dBuV)	Margin (dB)
2437	15.7	92.77	108.47	N/A	N/A
2400	15.7	44.09	59.79	88.47	-28.68
2565.51102	15.7	42.94	58.64	88.47	-29.83
3235.47094	15.7	48.83	64.53	88.47	-23.94

CH High

Frequency (MHz)	Offset (dB)	Reading (dBuV)	Level (dBuV)	Limit (dBuV)	Margin (dB)
2462	15.7	92.22	107.92	N/A	N/A
2400	15.7	43.39	59.09	87.92	-28.83
2339.33868	15.7	43.58	59.28	87.92	-28.64
3282.56513	15.7	49.51	65.21	87.92	-22.71

802.11n HT40 Combined Mode

CH Low

Frequency (MHz)	Offset (dB)	Reading (dBuV)	Level (dBuV)	Limit (dBuV)	Margin (dB)
2422	15.7	88.54	104.24	N/A	N/A
2400	15.7	60.88	76.58	84.24	-7.66
1678.67735	15.7	41.01	56.71	84.24	-27.53
3188.37675	15.7	49.77	65.47	84.24	-18.77

CH Mid

Frequency (MHz)	Offset (dB)	Reading (dBuV)	Level (dBuV)	Limit (dBuV)	Margin (dB)
2437	15.7	88.93	104.63	N/A	N/A
2400	15.7	44.99	60.69	84.63	-23.94
1714.38878	15.7	41.55	57.25	84.63	-27.38
3235.47094	15.7	49.23	64.93	84.63	-19.70

CH High

Frequency (MHz)	Offset (dB)	Reading (dBuV)	Level (dBuV)	Limit (dBuV)	Margin (dB)
2452	15.7	88.52	104.22	N/A	N/A
2400	15.7	43.66	59.36	84.22	-24.86
1738.19639	15.7	40.80	56.5	84.22	-27.72
3235.47094	15.7	49.05	64.75	84.22	-19.47



OUT-OF-BAND SPURIOUS EMISSIONS-CONDUCTED MEASUREMENT (IEEE 802.11b MODE)

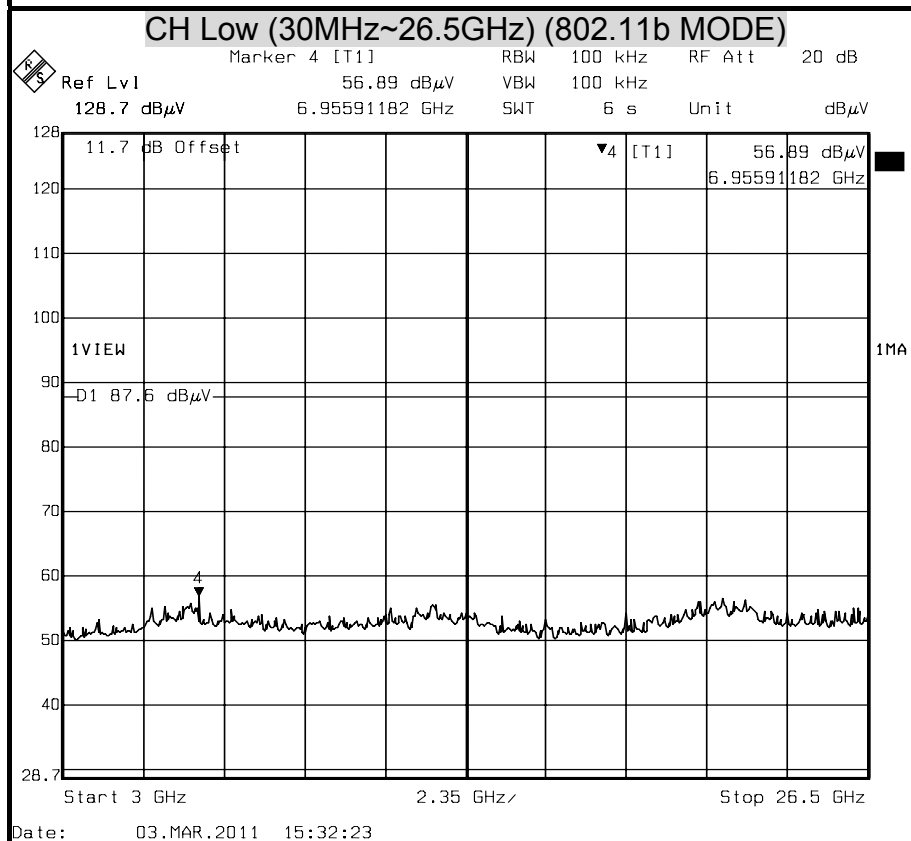
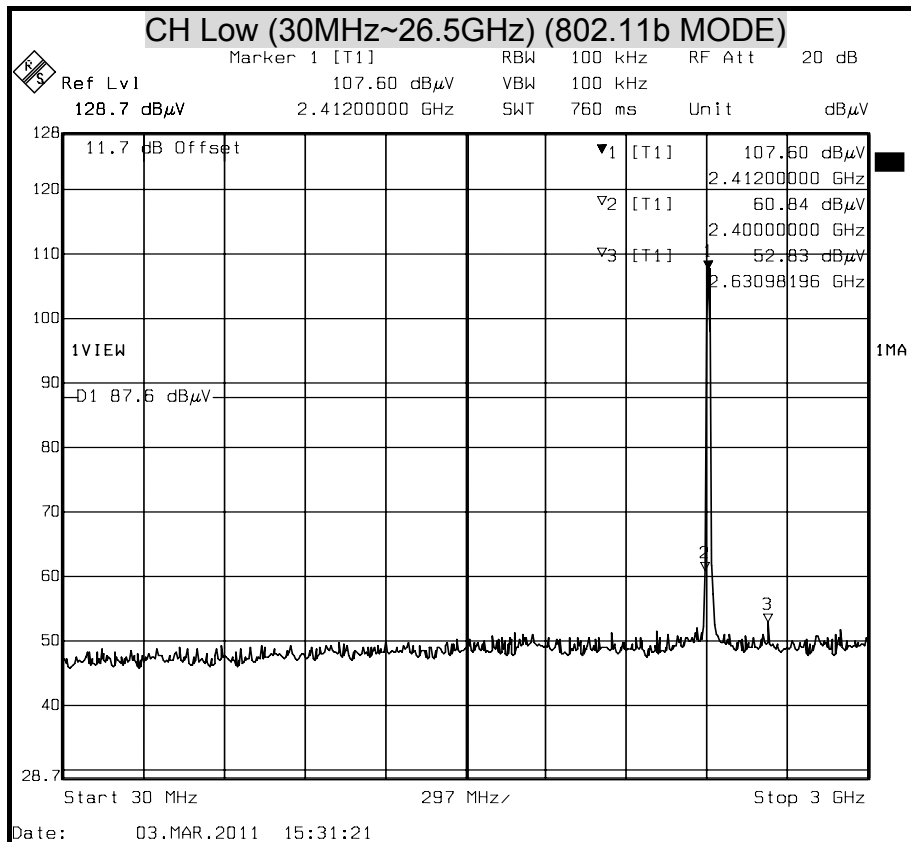

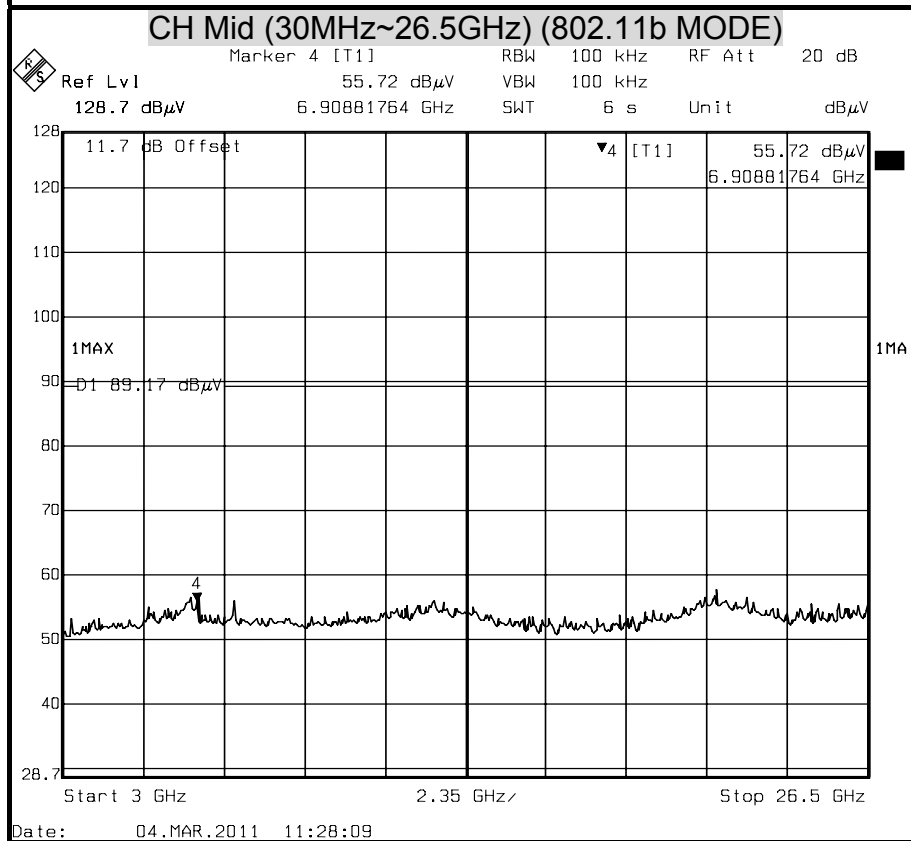
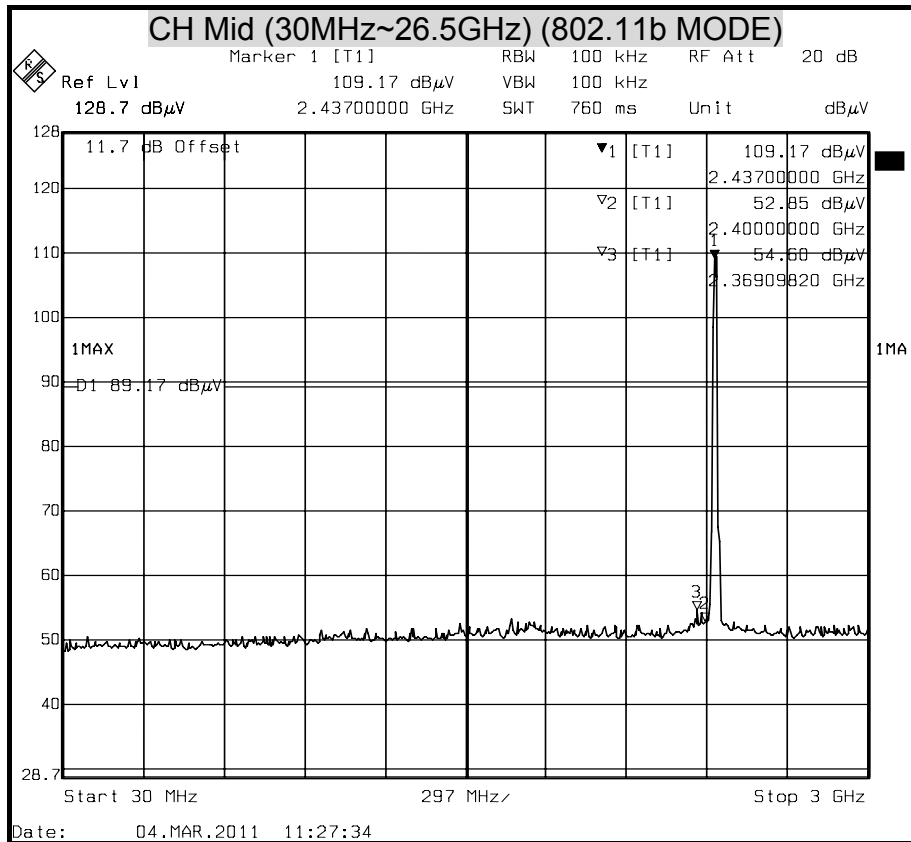

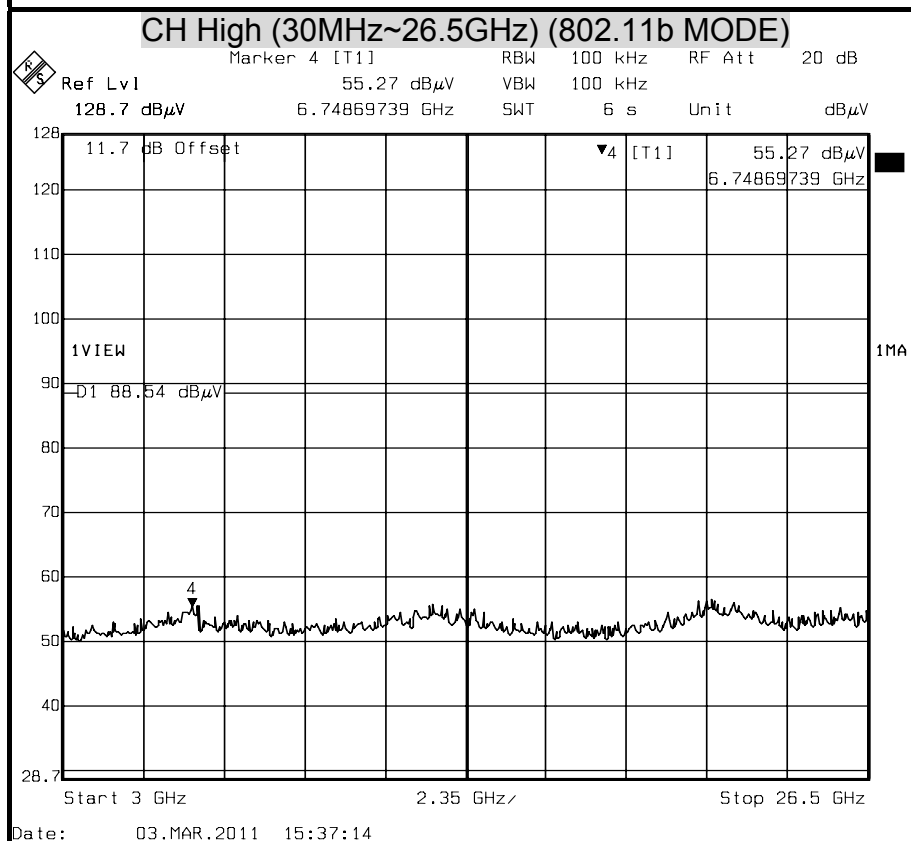
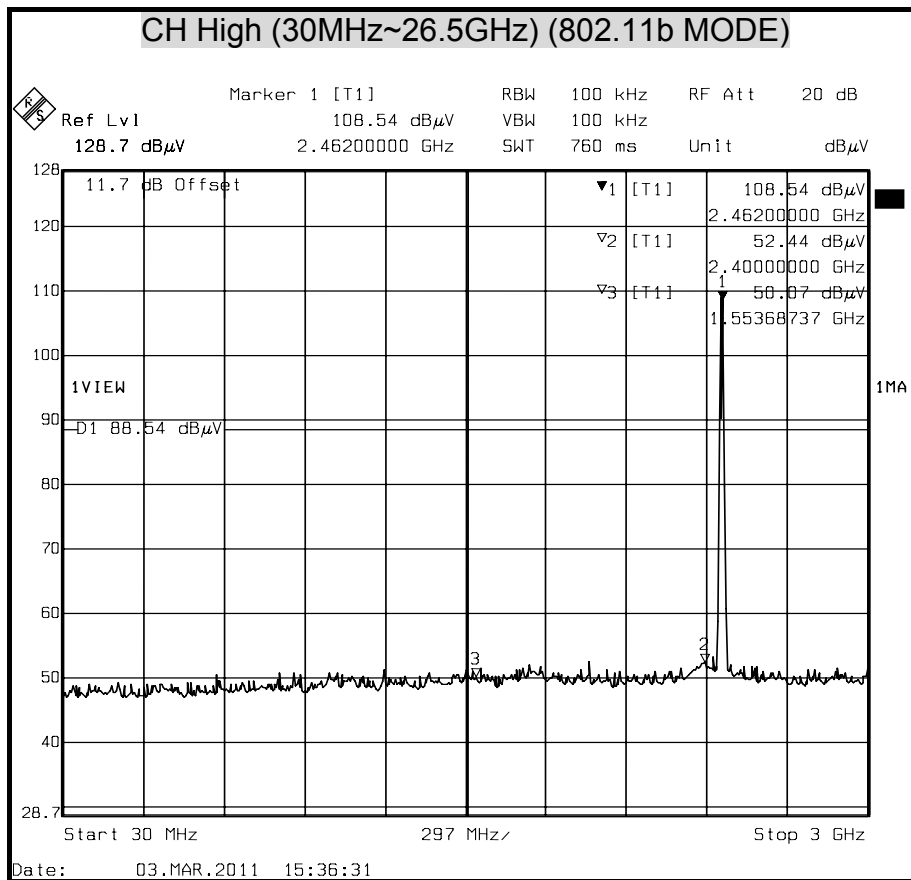



OUT-OF-BAND SPURIOUS EMISSIONS-CONDUCTED MEASUREMENT

(802.11g MODE)

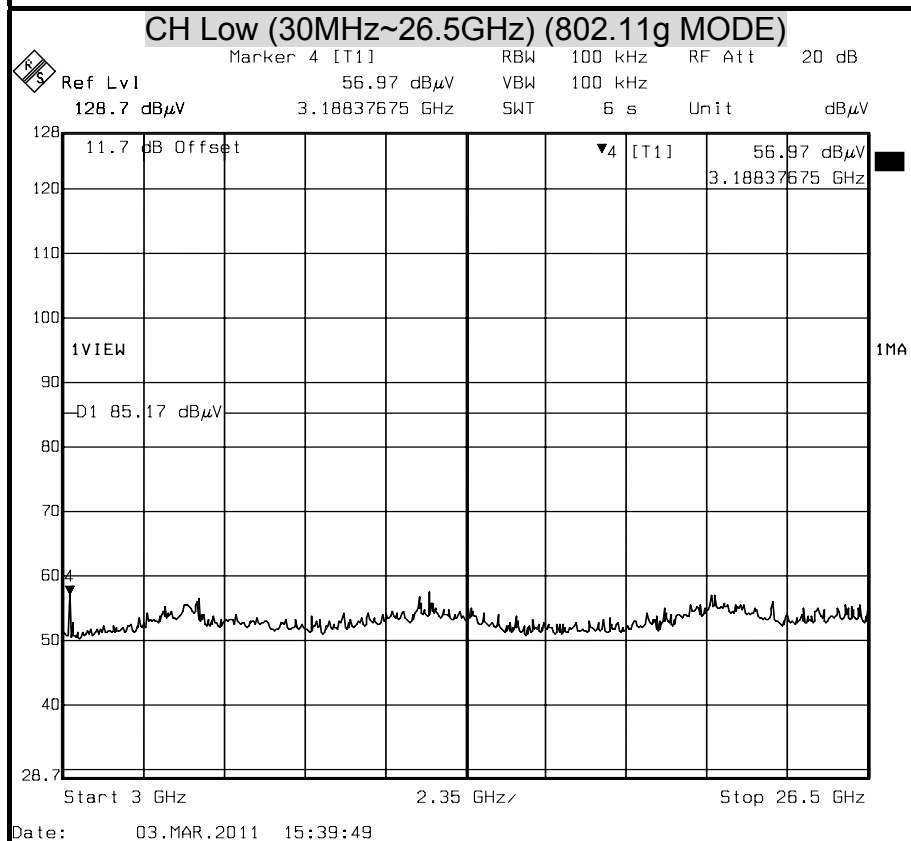
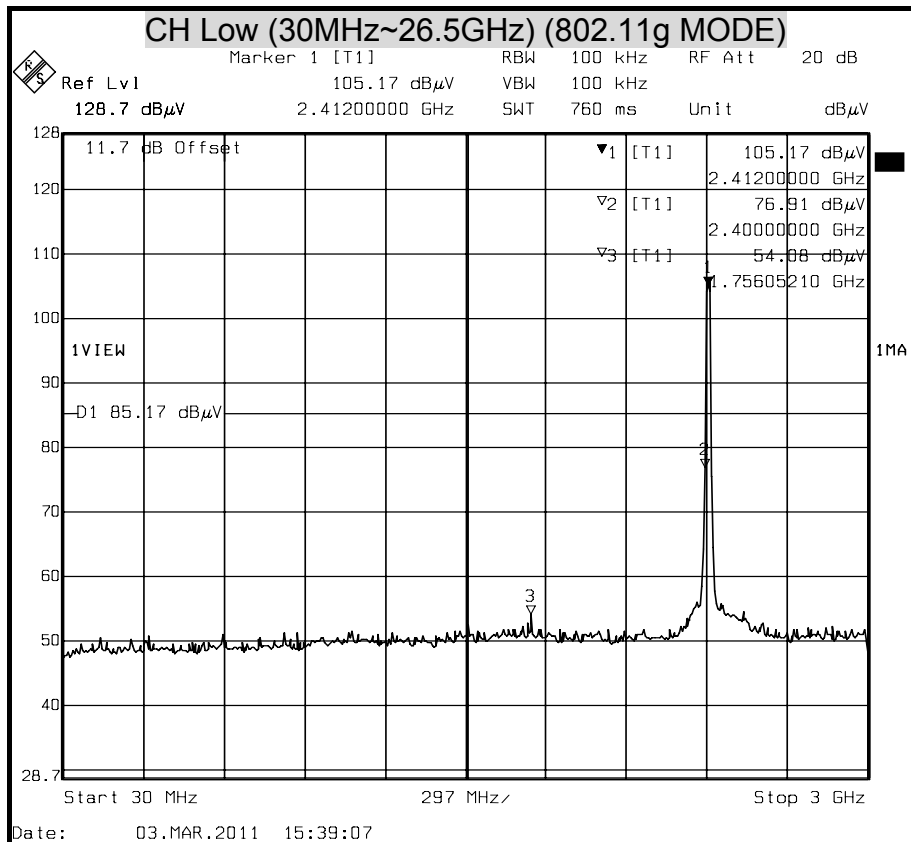

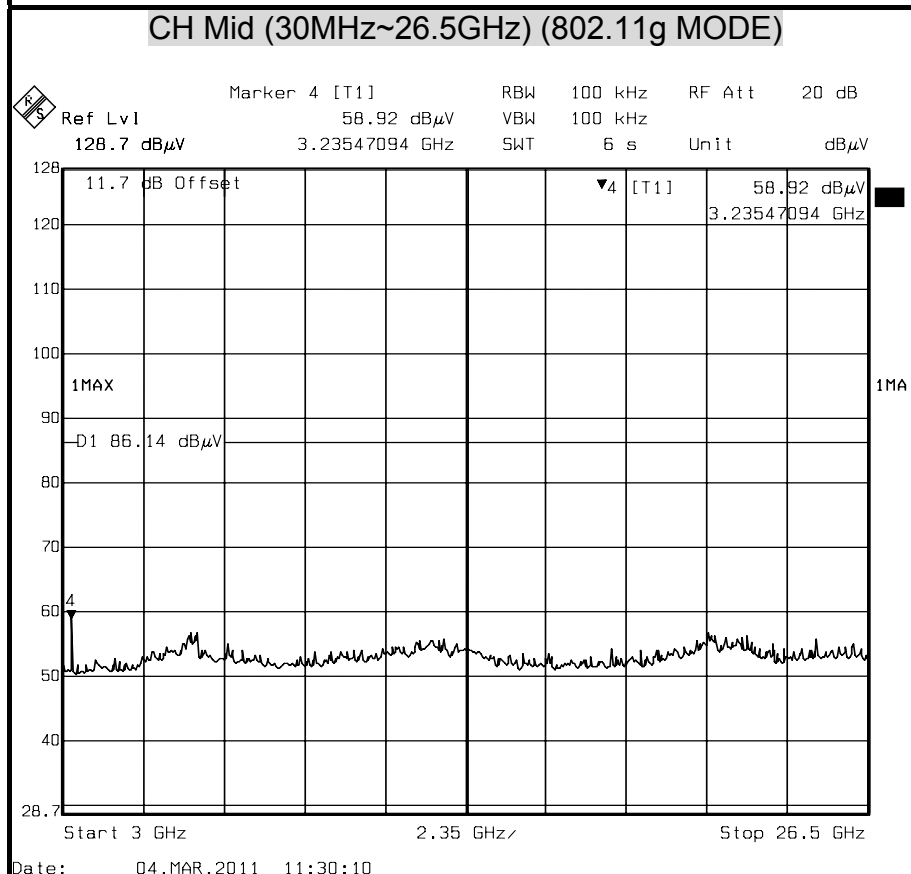
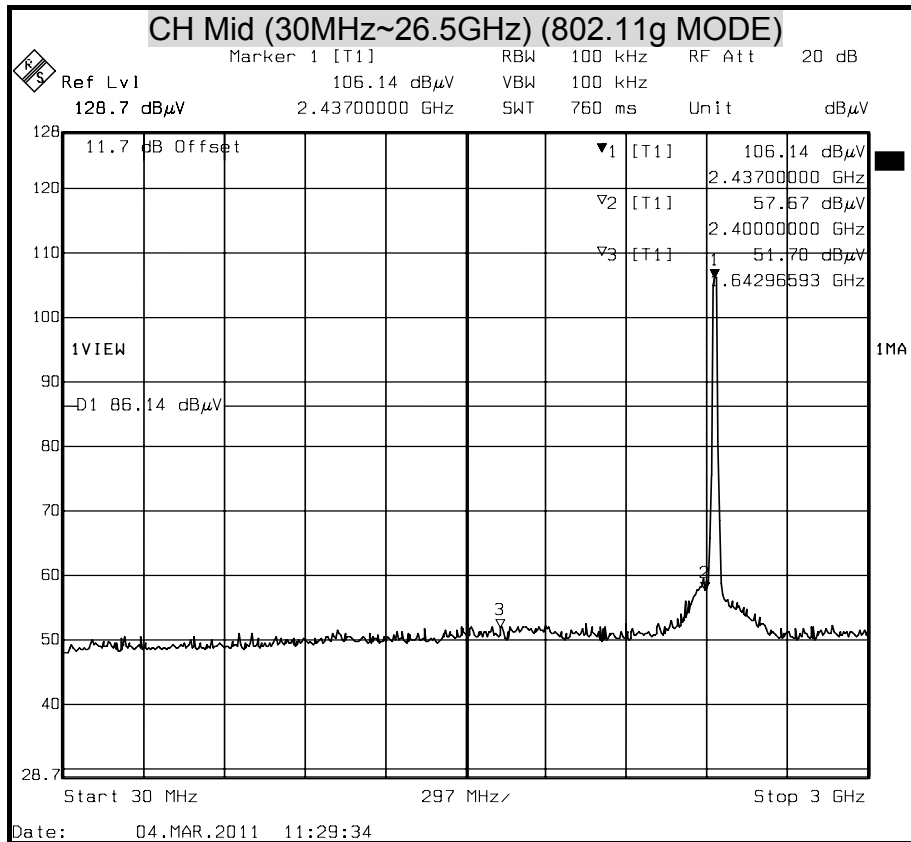

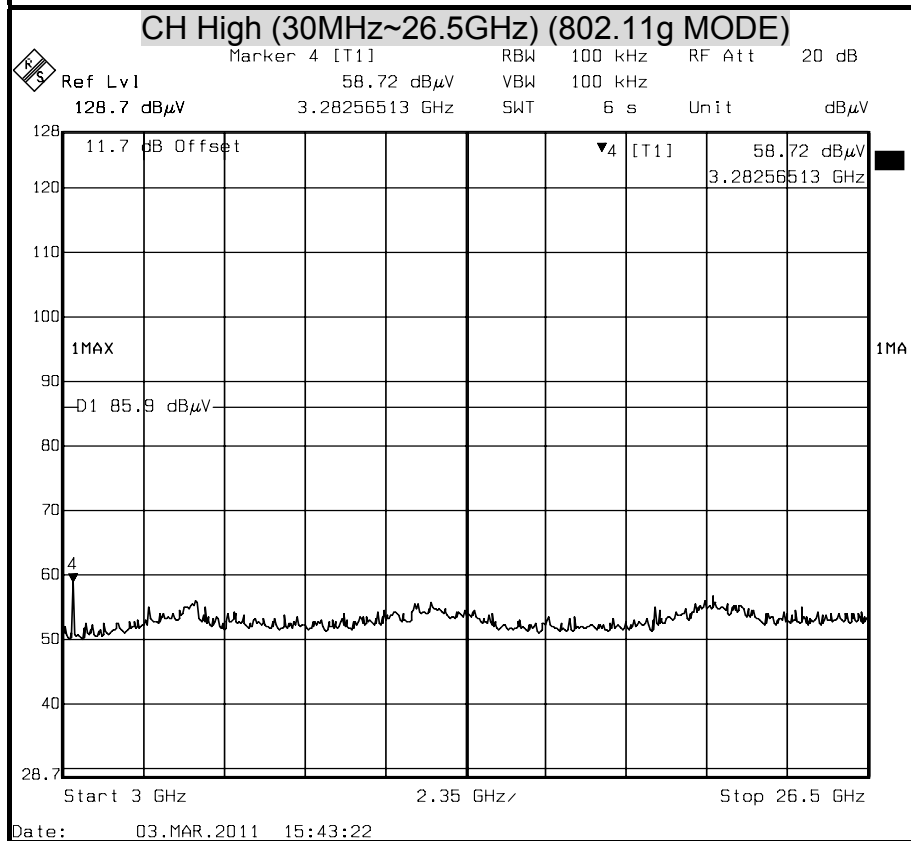
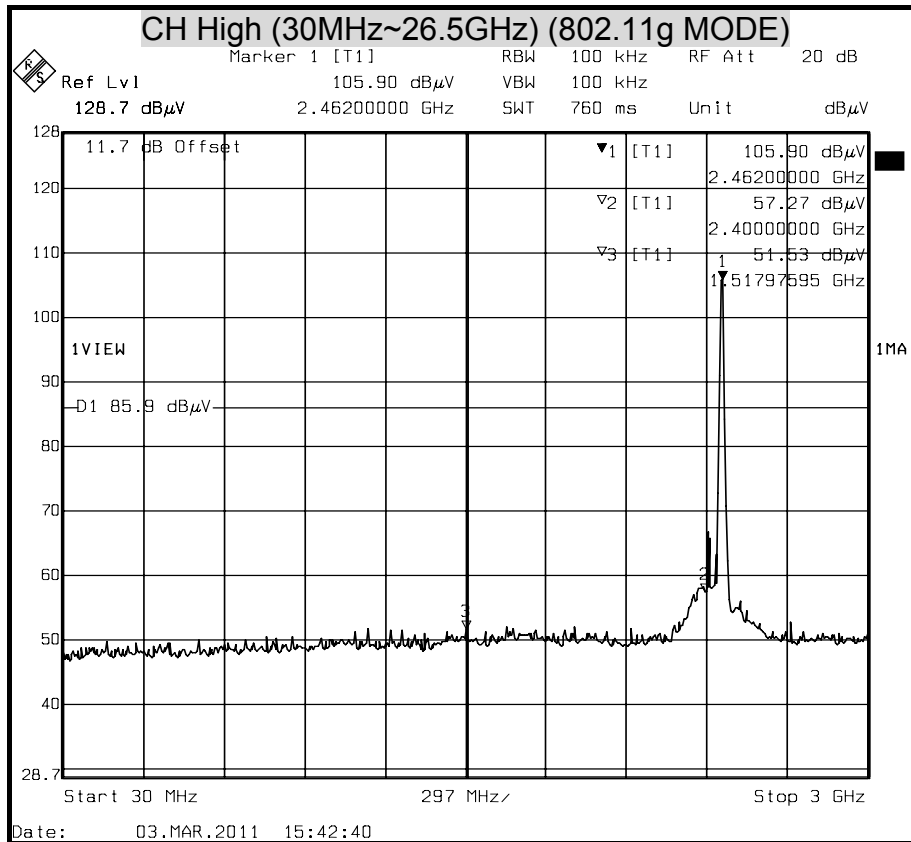



OUT-OF-BAND SPURIOUS EMISSIONS-CONDUCTED MEASUREMENT (802.11n HT20 MODE)

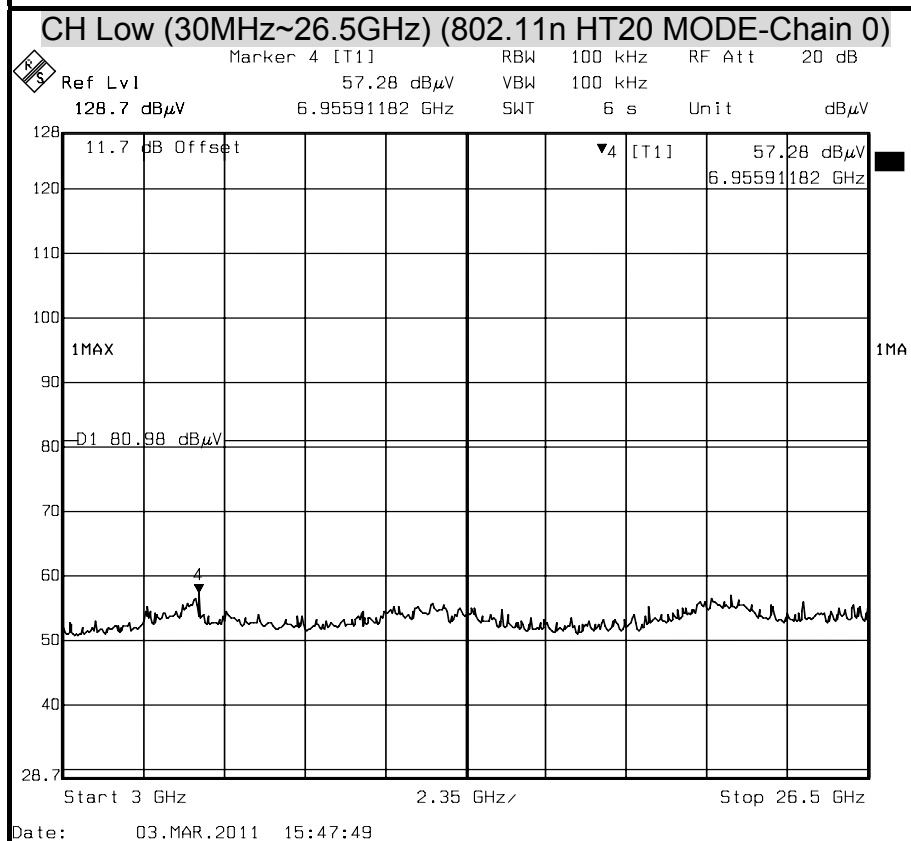
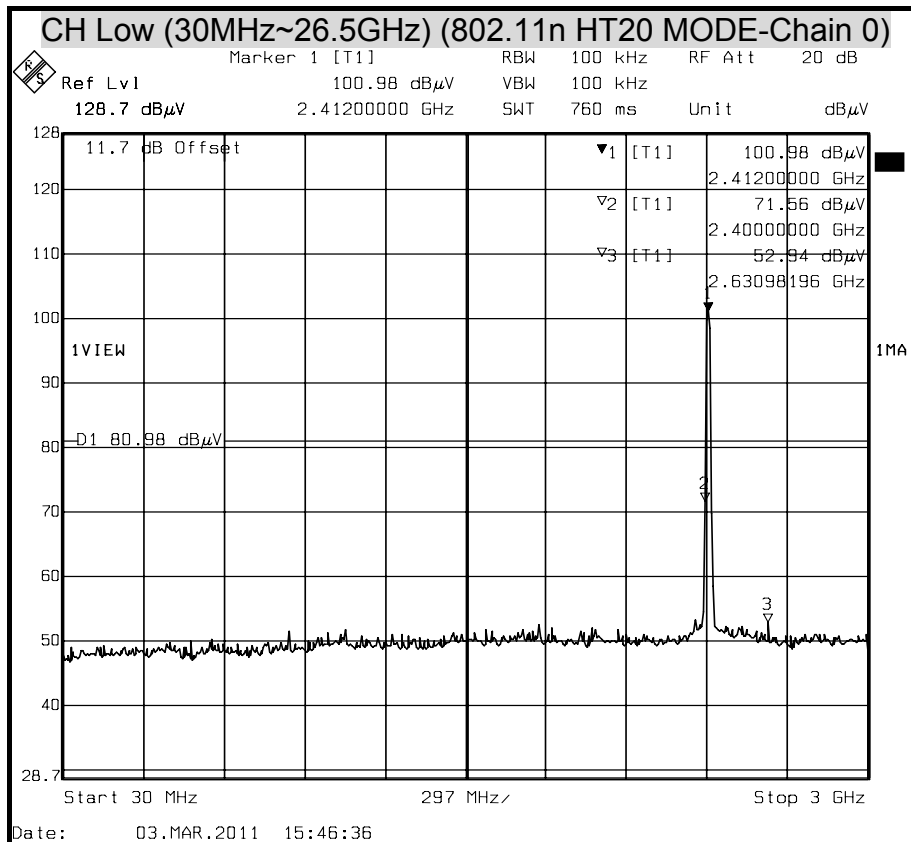

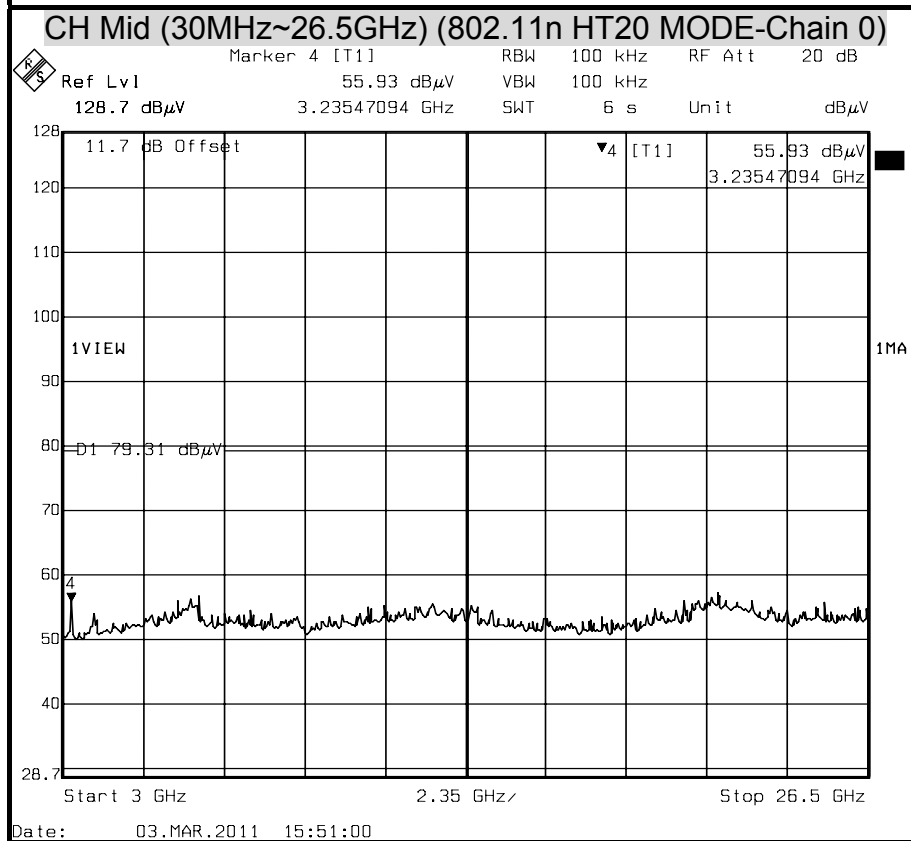
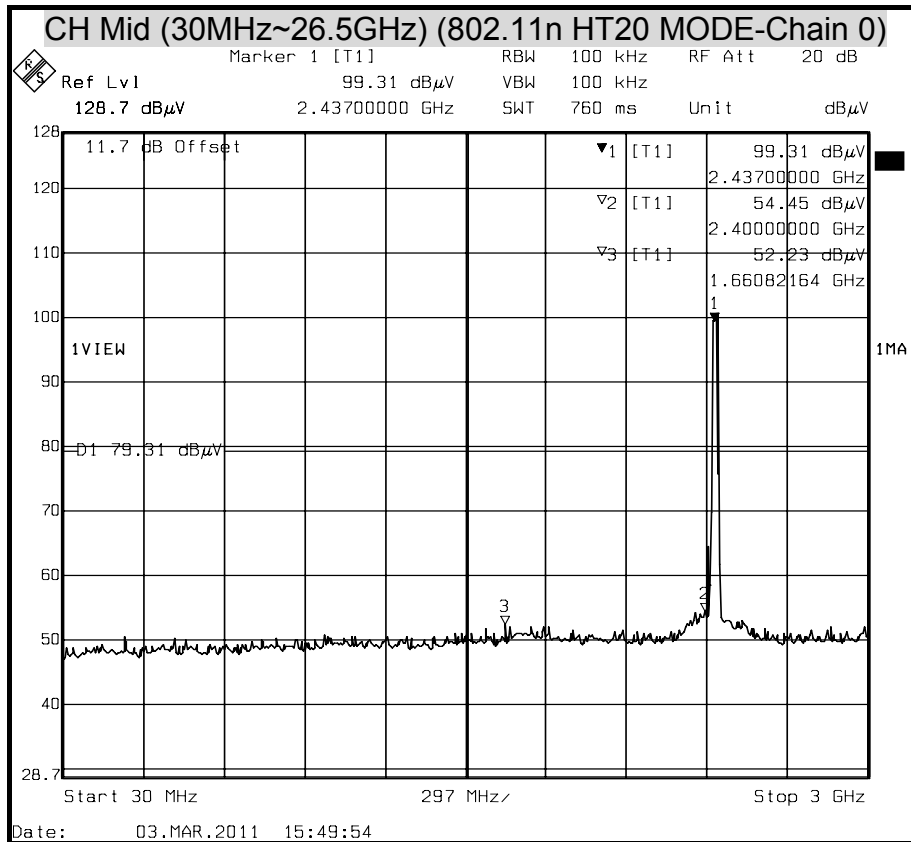

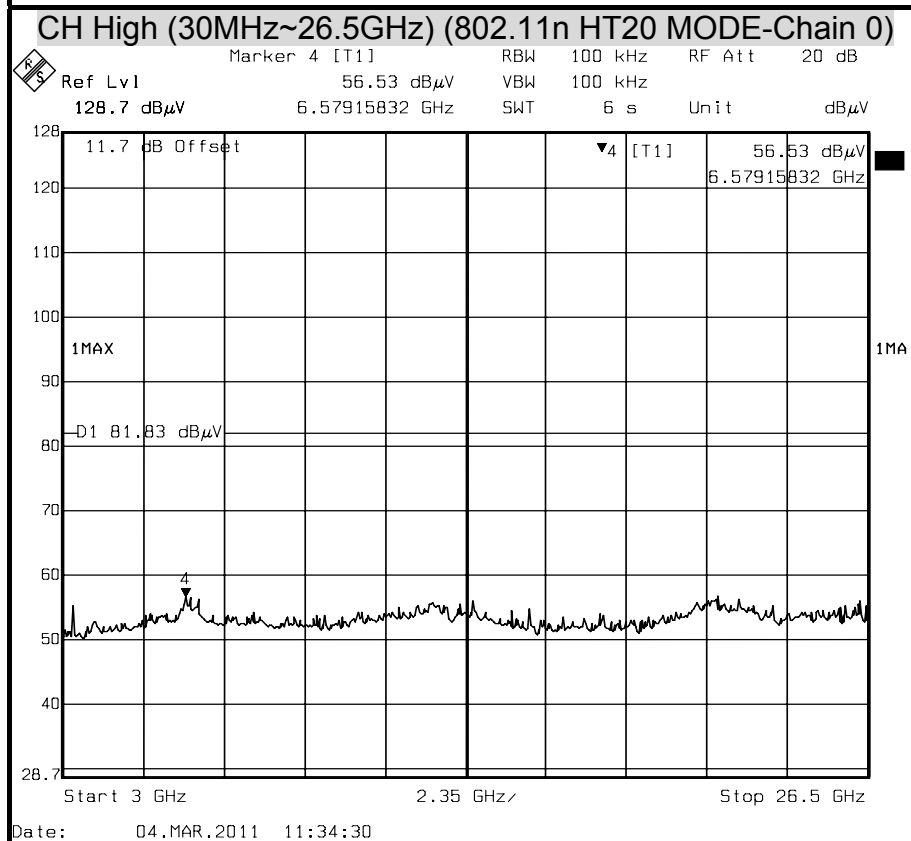
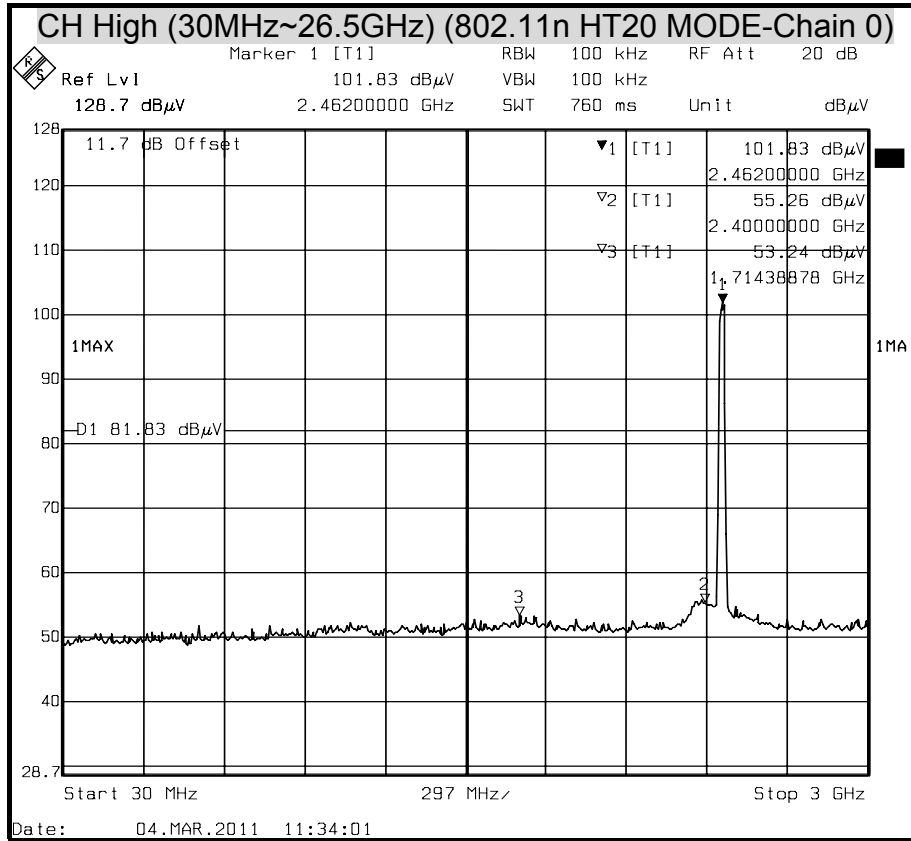



OUT-OF-BAND SPURIOUS EMISSIONS-CONDUCTED MEASUREMENT

(802.11n HT20 MODE)

