

**FCC&IC TEST REPORT for DTS Device (2.4G Band)**  
**No. 160801355SHA-001**

Applicant : NINGBO DOOYA MECHANIC & ELECTRONIC  
TECHNOLOGY CO., LTD.  
No.168 Shengguang Road, Luotuo, Zhenhai, Ningbo,  
ZHEJIANG, China

Manufacturer : NINGBO DOOYA MECHANIC & ELECTRONIC  
TECHNOLOGY CO., LTD.  
No.168 Shengguang Road, Luotuo, Zhenhai, Ningbo,  
ZHEJIANG, China

Product Name : Wifi BOX

Type/Model : DD7001

**TEST RESULT : PASS**

**SUMMARY**

The equipment complies with the requirements according to the following standard(s):

**47CFR Part 15 (2018):** Radio Frequency Devices (Subpart C)

**ANSI C63.10 (2013):** American National Standard of Procedures for Compliance Testing of Unlicensed Wireless Devices

**RSS-247 Issue 2 (February 2017):** Digital Transmission Systems (DTSSs), Frequency Hopping Systems (FHSs) and Licence-Exempt Local Area Network (LE-LAN) Devices

**RSS-Gen Issue 5 (April 2018):** General Requirements for Compliance of Radio Apparatus

Date of issue: May 15, 2019

Prepared by:

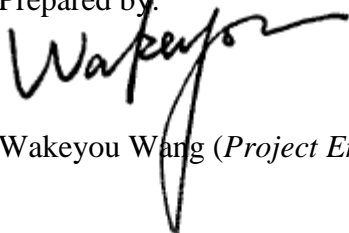

Wakeyou Wang (*Project Engineer*)

Reviewed by:

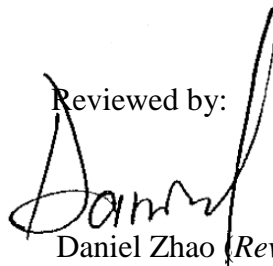

Daniel Zhao (*Reviewer*)

## Description of Test Facility

Name: Intertek Testing Service Shanghai  
Address: Building No.86, 1198 Qinzhou Road(North), Shanghai 200233, P.R. China

FCC Accredited Lab Designation Number: CN1175  
IC Assigned Code: 2042B-1

Name of contact: Jonny Jing  
Tel: 86 21 61278271  
Fax: 86 21 54262353

## Content

<b>SUMMARY</b> .....	<b>1</b>
<b>1. GENERAL INFORMATION</b> .....	<b>4</b>
1.1 Applicant Information.....	4
1.2 Identification of the EUT .....	4
1.3 Technical specification .....	5
1.4 Mode of operation during the test / Test peripherals used.....	6
<b>2. TEST SPECIFICATION</b> .....	<b>6</b>
2.1 Instrument list .....	7
2.2 Test Standard .....	7
2.3 Test Summary .....	8
<b>3. MINIMUM 6DB BANDWIDTH</b> .....	<b>9</b>
3.1 Limit.....	9
3.2 Test Configuration .....	9
3.3 Test Procedure and test setup.....	9
3.4 Test Protocol .....	10
<b>4. MAXIMUM PEAK OUTPUT POWER</b> .....	<b>17</b>
4.1 Test limit .....	17
4.2 Test Configuration .....	17
4.3 Test procedure and test setup.....	17
4.4 Test protocol .....	18
<b>5. POWER SPECTRUM DENSITY</b> .....	<b>19</b>
5.1 Test limit .....	19
5.2 Test Configuration .....	19
5.3 Test procedure and test setup.....	19
5.4 Test Protocol .....	20
<b>6. RADIATED EMISSION</b> .....	<b>27</b>
6.1 Test limit .....	27
6.2 Test Configuration .....	27
6.3 Test procedure and test setup.....	28
6.4 Test protocol .....	29
<b>7. EMISSION OUTSIDE THE FREQUENCY BAND</b> .....	<b>35</b>
7.1 Limit.....	35
7.2 Test Configuration .....	35
7.3 Test procedure and test setup.....	35
7.4 Test protocol .....	36
<b>8. POWER LINE CONDUCTED EMISSION</b> .....	<b>47</b>
8.1 Limit.....	47
8.2 Test configuration .....	47
8.3 Test procedure and test set up.....	48
8.4 Test protocol .....	49
<b>9. OCCUPIED BANDWIDTH</b> .....	<b>51</b>
9.1 Test limit .....	51
9.2 Test Configuration .....	51
9.3 Test procedure and test setup.....	51
9.4 Test protocol .....	52

## 1. General Information

### 1.1 Applicant Information

Applicant: NINGBO DOOYA MECHANIC & ELECTRONIC TECHNOLOGY CO., LTD.  
No.168 Shengguang Road, Luotuo, Zhenhai, Ningbo, ZHEJIANG, China

Name of contact: Xiaofang Liao

Tel: +86 13429291066

Fax: /

Manufacturer: NINGBO DOOYA MECHANIC & ELECTRONIC TECHNOLOGY CO., LTD.  
No.168 Shengguang Road, Luotuo, Zhenhai, Ningbo, ZHEJIANG, China

Sample received date: Sep 20, 2016

Sample Identification No: /

Date of test: Sep 20, 2016 ~ May 10, 2019

### 1.2 Identification of the EUT

Equipment: Wifi BOX

Type/model for FCC: DD7001

FCC ID: VYYDD7001

IC: 21396-DD7001

### 1.3 Technical specification

Frequency Range:	2400 – 2483.5 MHz, 433.925MHz
Modulation:	DBPSK, DQPSK, CCK, BPSK QPSK, 16-QAM, 64-QAM; GFSK
Gain of Antenna:	2.0dBi; 1.2dBi
Rating:	DC 5V powered by USB port
Description of EUT:	There is one model only. The device supports both wi-fi and 433MHz SRD. Among this report, only wi-fi was tested.
Channel Description:	2.4GHz band: Channel spacing 5MHz 11 channels for 2412~2462MHz; 7 channels for 2422~2452MHz for 11n HT40; 433.925MHz band: 1 channel only.

### 1.4 Mode of operation during the test / Test peripherals used

While testing transmitting mode of EUT, the internal modulation and continuously transmission was applied.

Freq. Band	Modulation	Lowest(MHz)	Middle(MHz)	Highest(MHz)
2400 – 2483.5MHz	802.11b	2412	2437	2462
	802.11g	2412	2437	2462
	802.11n HT20	2412	2437	2462
	802.11n HT40	2422	2437	2452

Peripherals	Brand	Model No.	Serial No.	Description of Data Cable
USB adaptor	PHIHONG	PSAI10R-050Q	N/A	USB shielded × 1 (1m)
RS485 to RS232 adapter	UTEK	UT-2201	N/A	RJ-21 unshielded × 1 (6m)
Notebook PC	DELL	Latitude D610	1YWZK1S	NA

### Data rate VS Power

The pre-scan for the conducted power with all rates in each modulation and bands was used, and the worst case was found and used in all test cases.

After this pre-scan, we choose the following table of the data rata as the worst case.

Mode	Worst case data rate
802.11b	1Mbps
802.11g	6Mbps
802.11 n20	MCS7
802.11 n40	MCS7

## 2. Test Specification

### 2.1 Instrument list

PXA Signal Analyzer	Keysight	N9030A	EC 5338	2020-03-04
Power sensor	Agilent	U2021XA	EC 5338-1	2020-03-04
Vector Signal Generator	Agilent	N5182B	EC 5175	2020-03-04
Universal Radio Communication Tester	R&S	CMW500	EC5944	2019-12-22
MXG Analog Signal Generator	Agilent	N5181A	EC 5338-2	2020-03-04
Test Receiver	R&S	ESCI 7	EC 4501	2019-09-12
Climate chamber	GWS	MT3065	EC 6021	2019-07-03
Spectrum Analyzer	Keysight	N9030A	EC 6078	2020-06-11
Semi-anechoic chamber	Albatross project	-	EC 3048	2019-07-31
Test Receiver	R&S	ESIB 26	EC 3045	2019-09-12
Bilog Antenna	TESEQ	CBL 6112D	EC 4206	2019-12-10
Pre-amplifier	R&S	AFS42-00101800-25-S-42	EC5262	2020-06-11
Test Receiver	R&S	ESCS 30	EC 2107	2019-07-15
A.M.N.	R&S	ESH2-Z5	EC 3119	2019-11-29

### 2.2 Test Standard

47CFR Part 15 (2018)  
ANSI C63.10 (2013)  
KDB 558074 (v05)  
RSS-247 Issue 2 (February 2017)  
RSS-Gen Issue 5 (April 2018)

### 2.3 Test Summary

**This report applies to tested sample only. This report shall not be reproduced in part without written approval of Intertek Testing Service Shanghai Limited.**

TEST ITEM	FCC REFERANCE	IC REFERANCE	RESULT
Minimum 6dB Bandwidth	15.247(a)(2)	RSS-247 Issue 2 Clause 5.2	Pass
Maximum peak output power	15.247(b)(3)	RSS-247 Issue 2 Clause 5.4	Pass
Power spectrum density	15.247(e)	RSS-247 Issue 2 Clause 5.2	Pass
Radiated emission	15.247(d), 15.205&15.209	RSS-Gen Issue 5 Clause 8.9&8.10	Pass
Emission outside the frequency band	15.247(d)	RSS-247 Issue 2 Clause 5.5	Pass
Power line conducted emission	15.207(a)	RSS-Gen Issue 5 Clause 8.8	Pass
Occupied bandwidth	-	RSS-Gen Issue 5 Clause 6.6	Tested



### 3. Minimum 6dB Bandwidth

**Test result: PASS**

#### 3.1 Limit

For systems using digital modulation techniques that may operate in the 902 - 928 MHz, 2400 - 2483.5 MHz and 5725 - 5850 MHz bands, the minimum 6 dB bandwidth shall be at least 500 kHz.

#### 3.2 Test Configuration

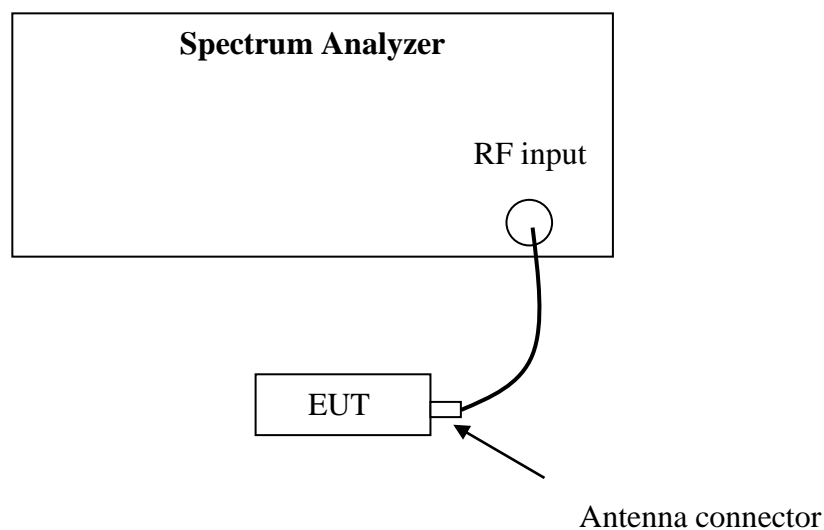

#### 3.3 Test Procedure and test setup

This test is conducted according to DTS test procedure of “KDB 558074 (v05)”:

- a) Set RBW = 100 kHz.
- b) Set the video bandwidth (VBW)  $\geq 3 \times$  RBW.
- c) Detector = Peak.
- d) Trace mode = max hold.
- e) Sweep = auto couple.
- f) Allow the trace to stabilize.
- g) The automatic bandwidth measurement capability of an instrument is employed using the X dB bandwidth mode with X set to 6 dB.

**3.4 Test Protocol**

Temperature : 25°C  
Relative Humidity : 55%

Mode	CH	Bandwidth (MHz)	Limit (MHz)
b	L	9.02	≥0.5
	M	9.08	
	H	9.02	
g	L	16.38	
	M	16.32	
	H	16.42	
n20	L	16.44	
	M	16.92	
	H	16.68	
n40	L	35.92	≥0.5
	M	35.92	
	H	36.04	

Mode b, Channel L

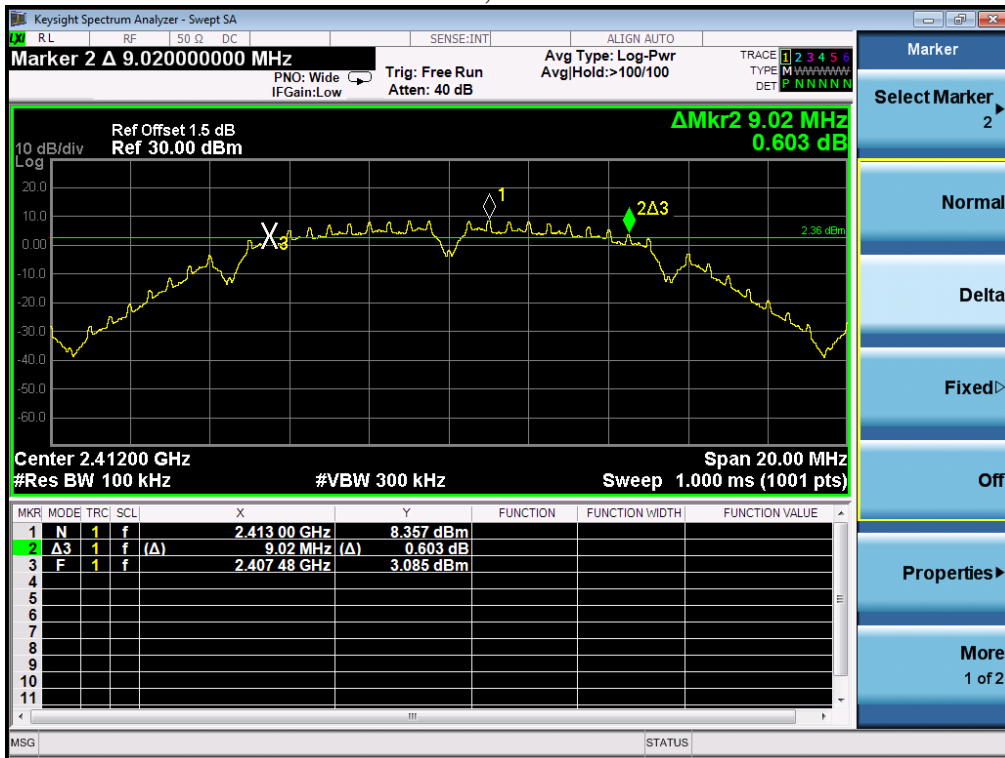

Mode b, Channel M

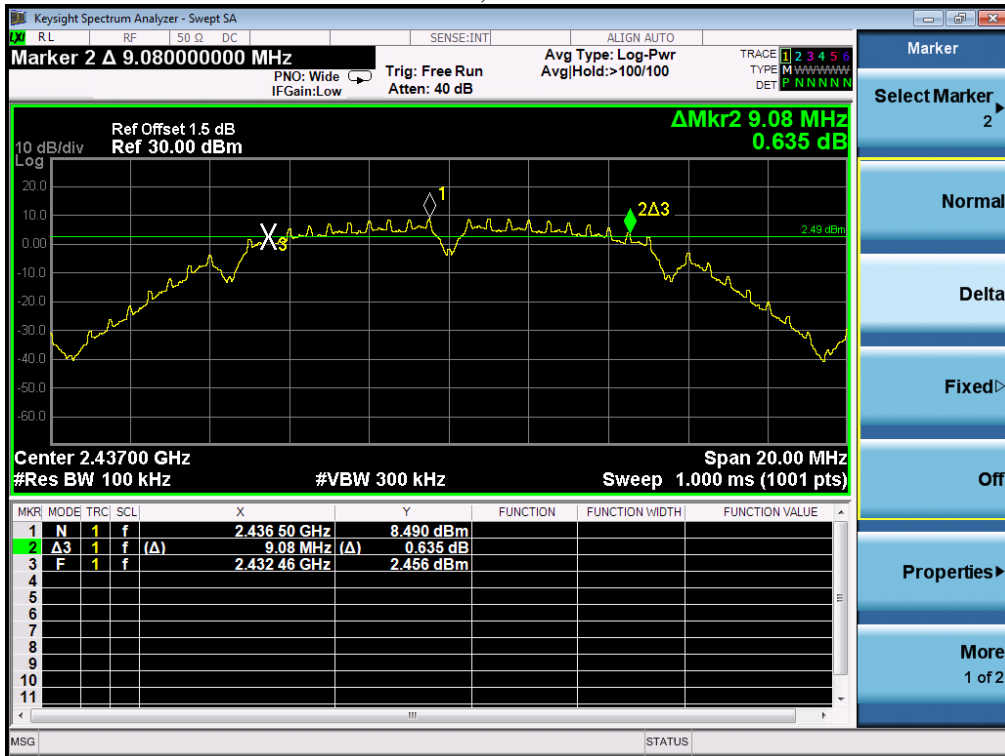

Mode b, Channel H

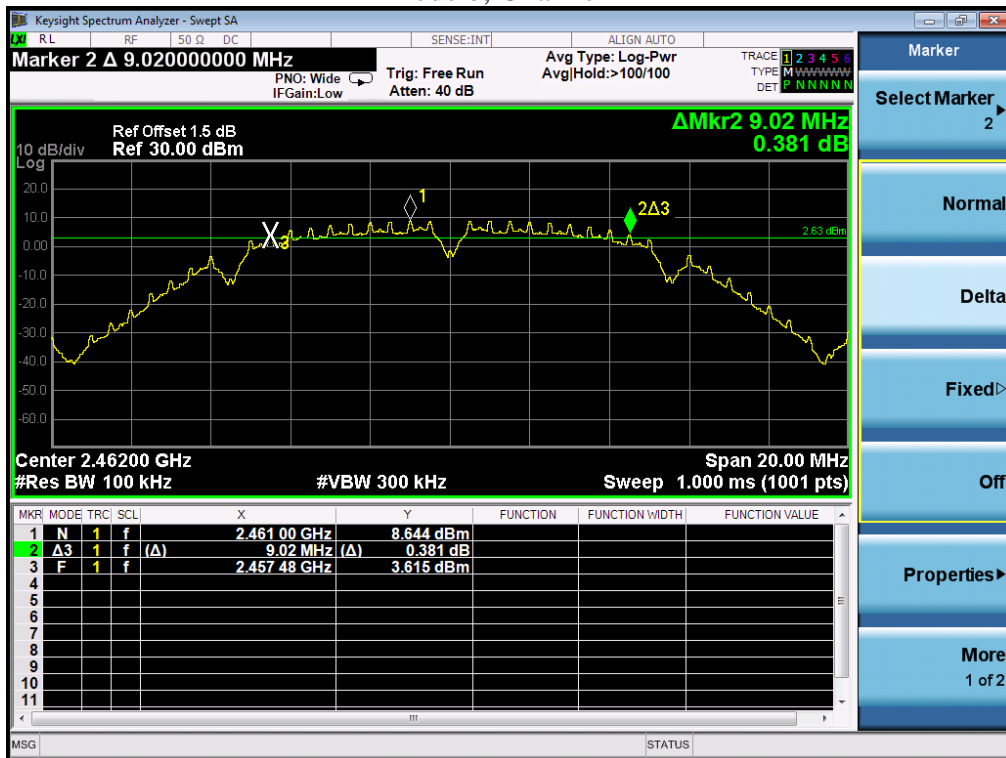

Mode g, Channel L

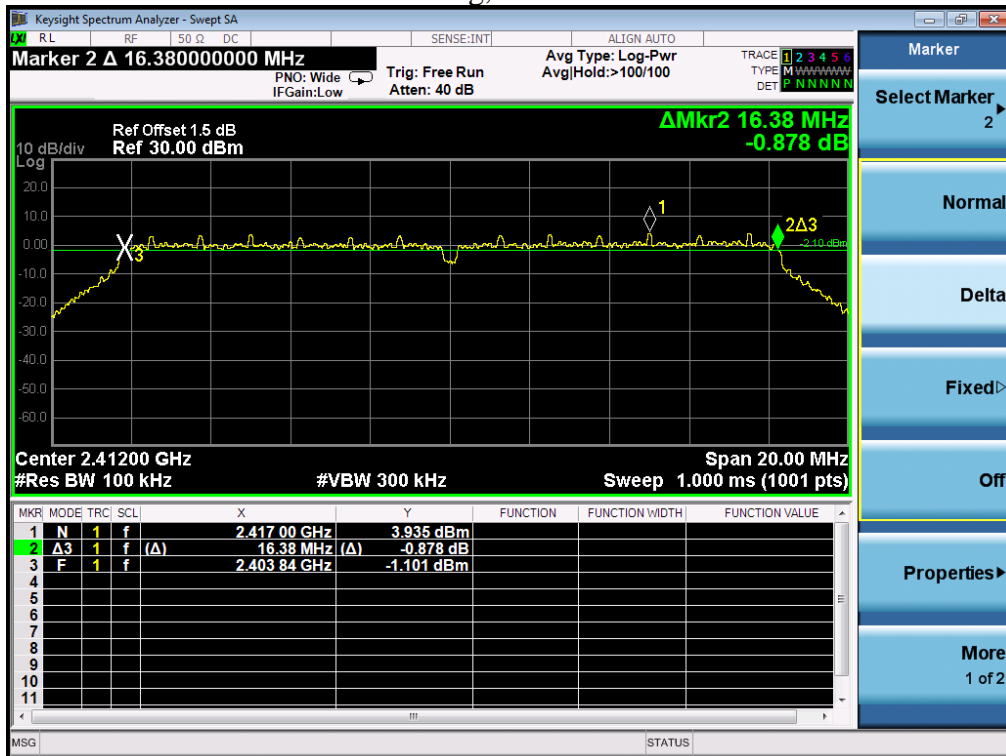

Mode g, Channel M

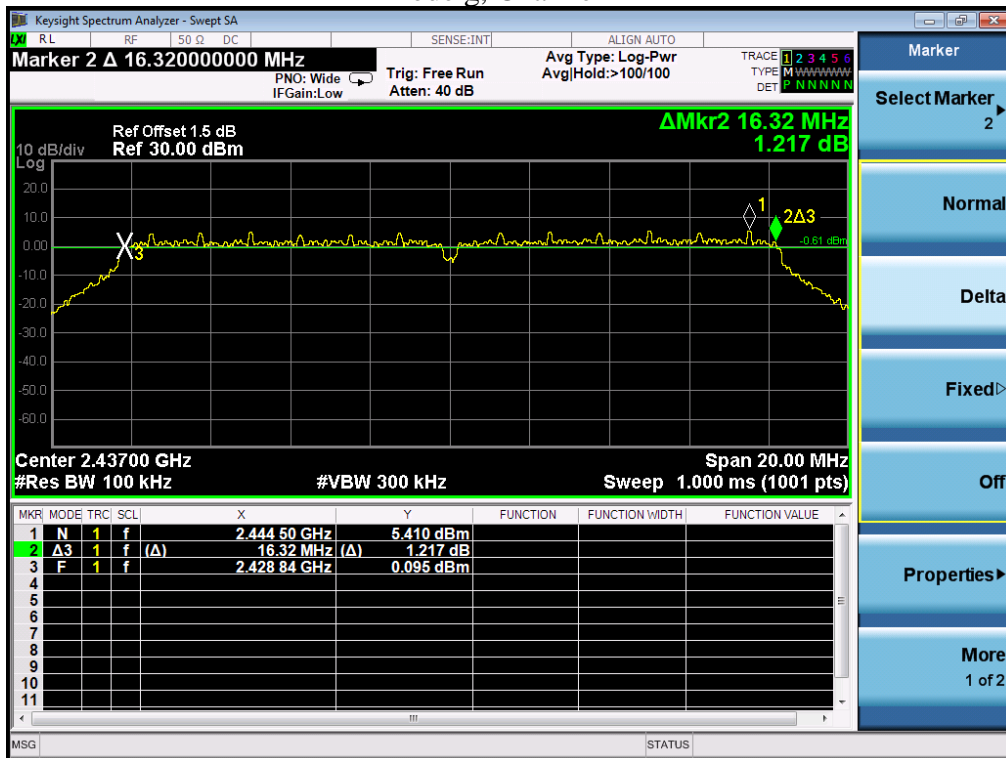

Mode g, Channel H

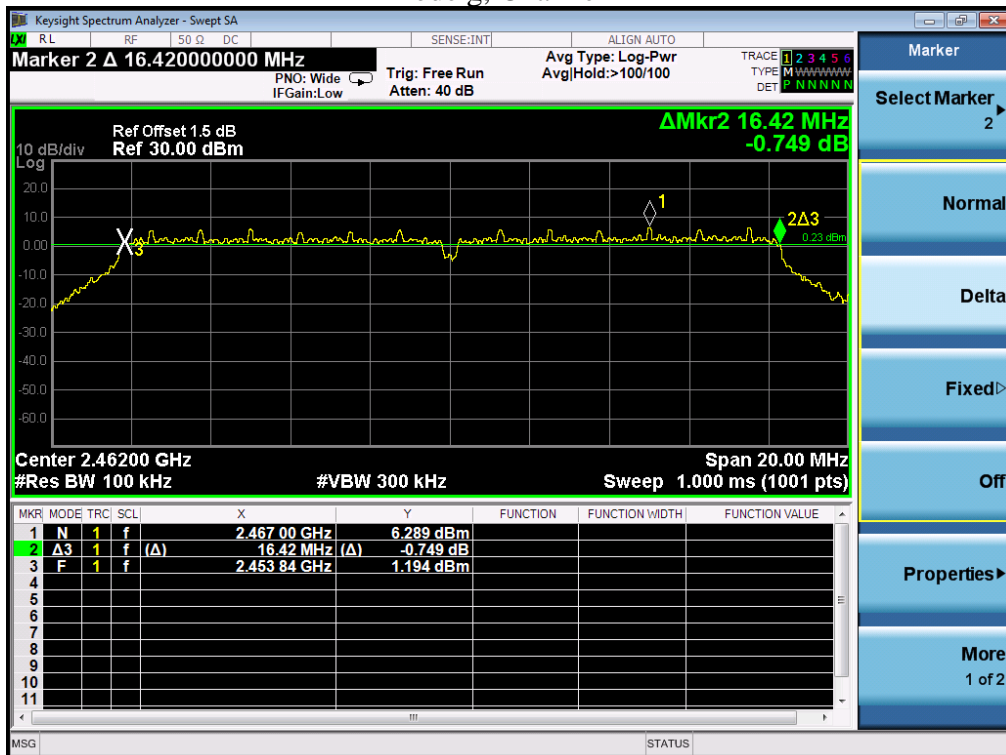

Mode n20, Channel L

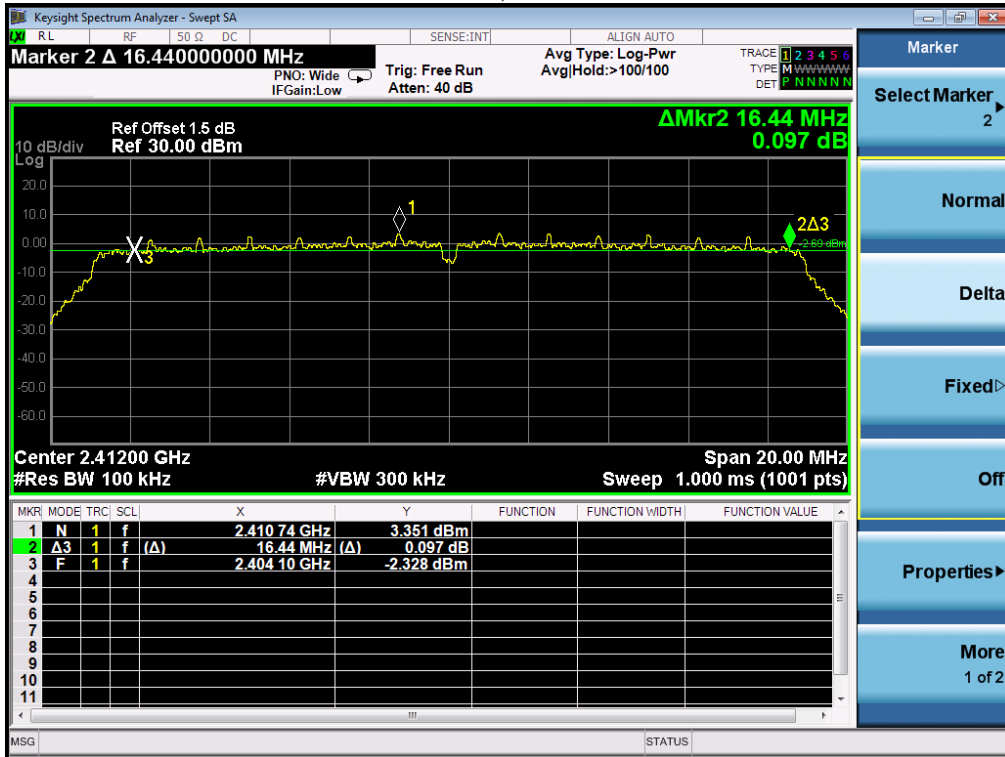

Mode n20, Channel M

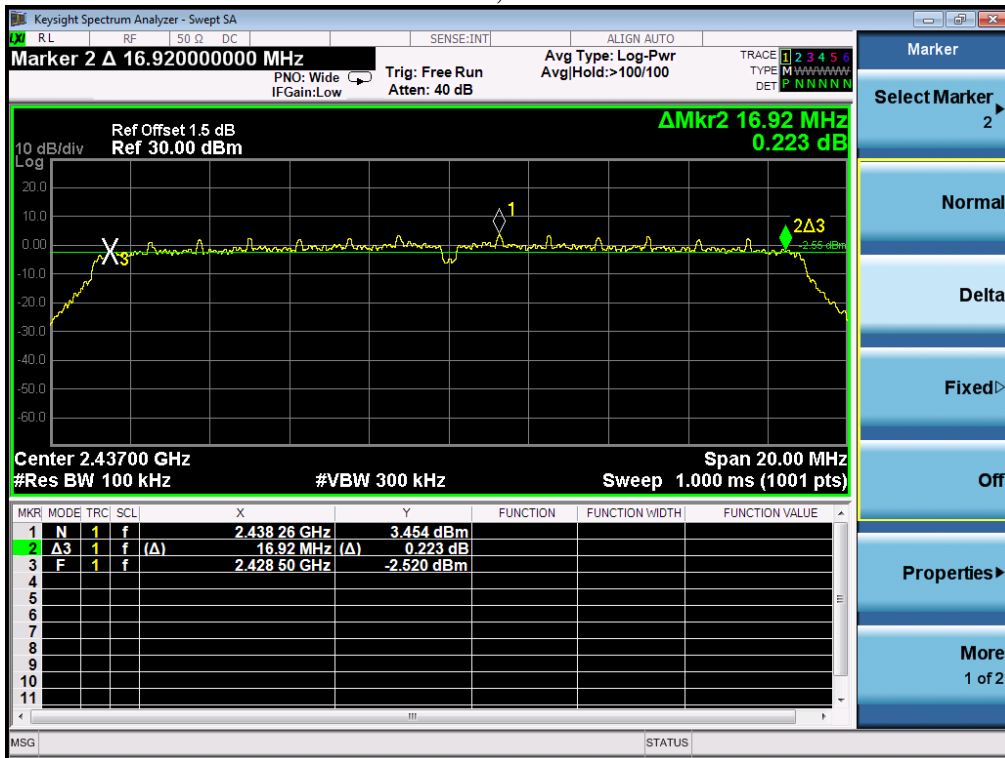

Mode n20, Channel H

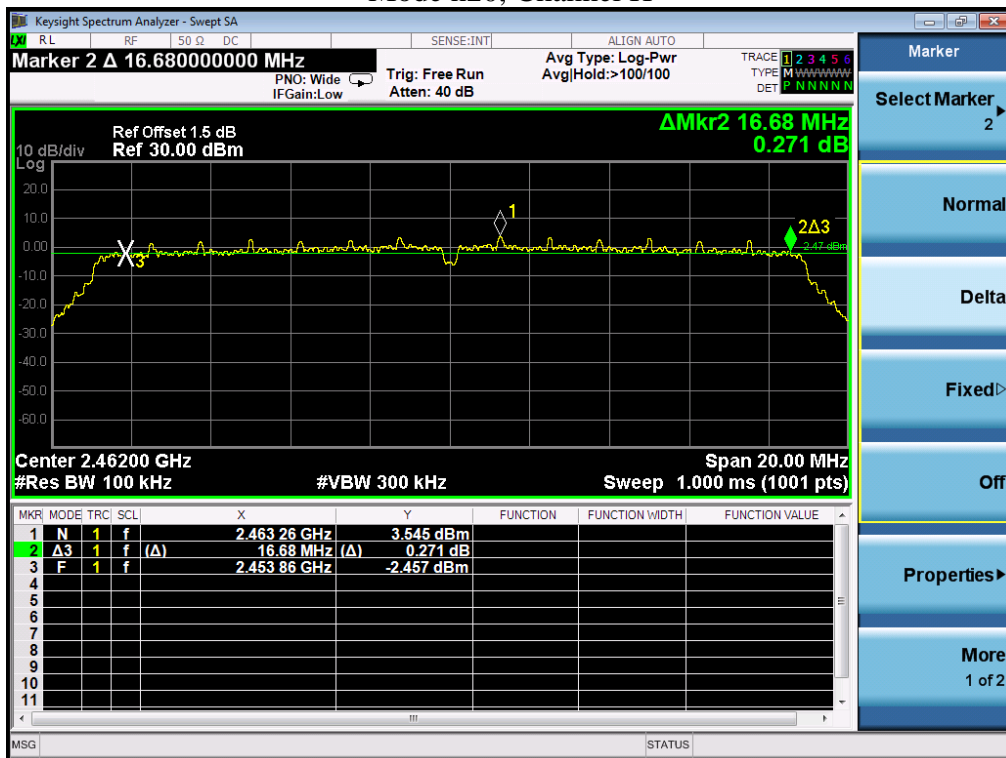

Mode n40, Channel L

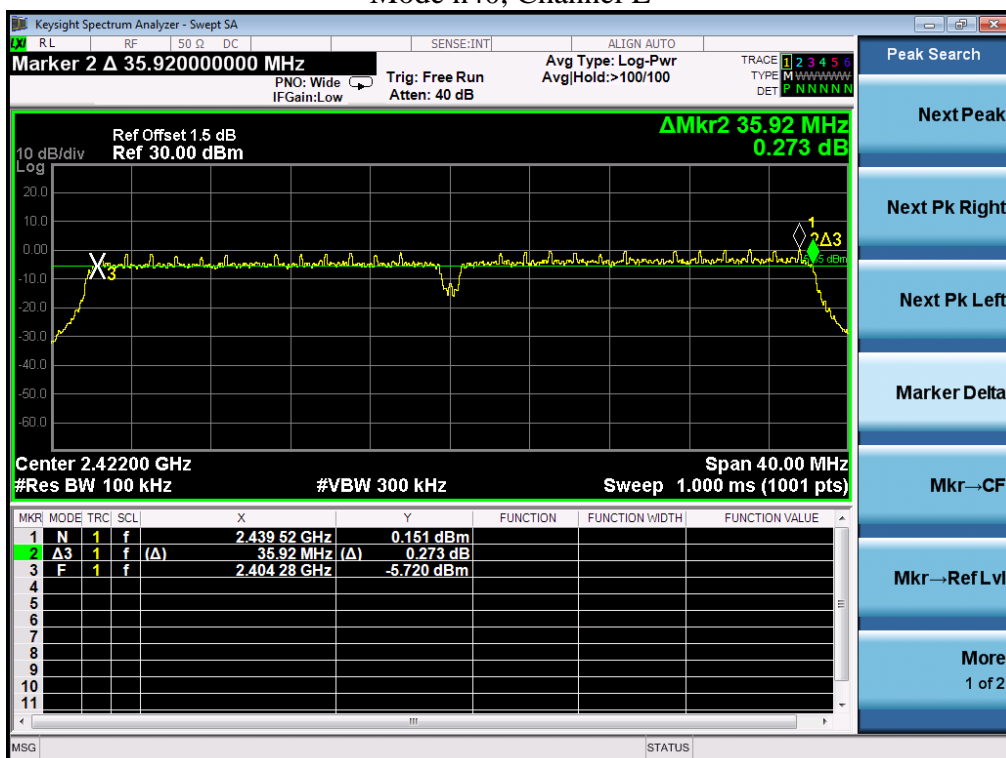

Mode n40, Channel M

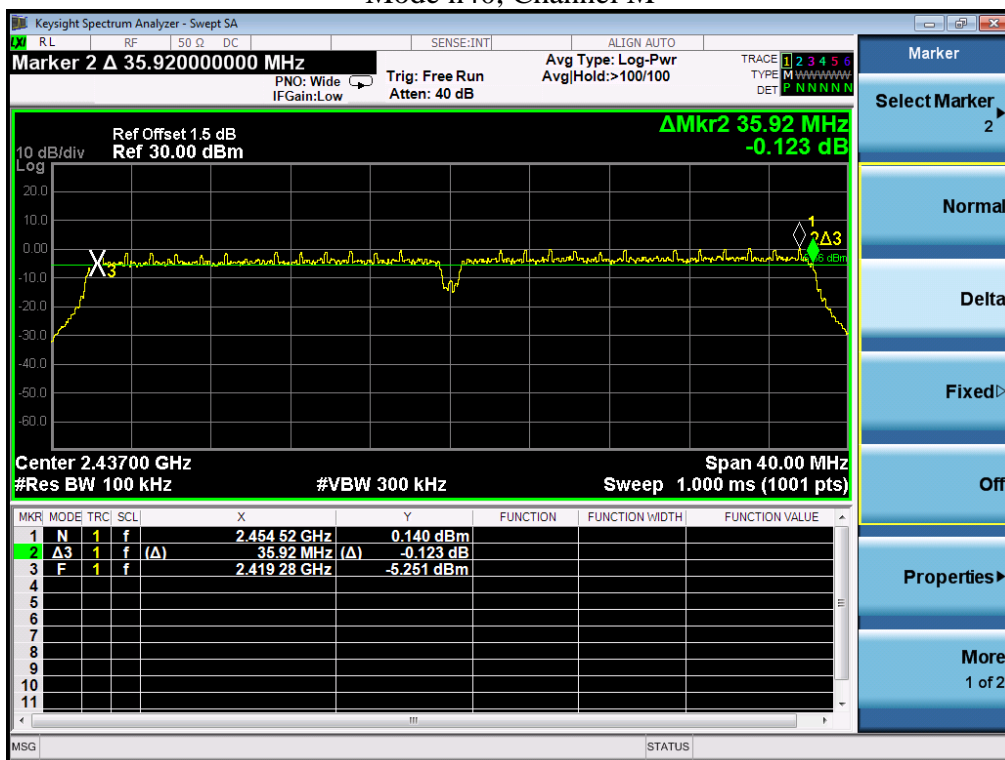

Mode n40, Channel H

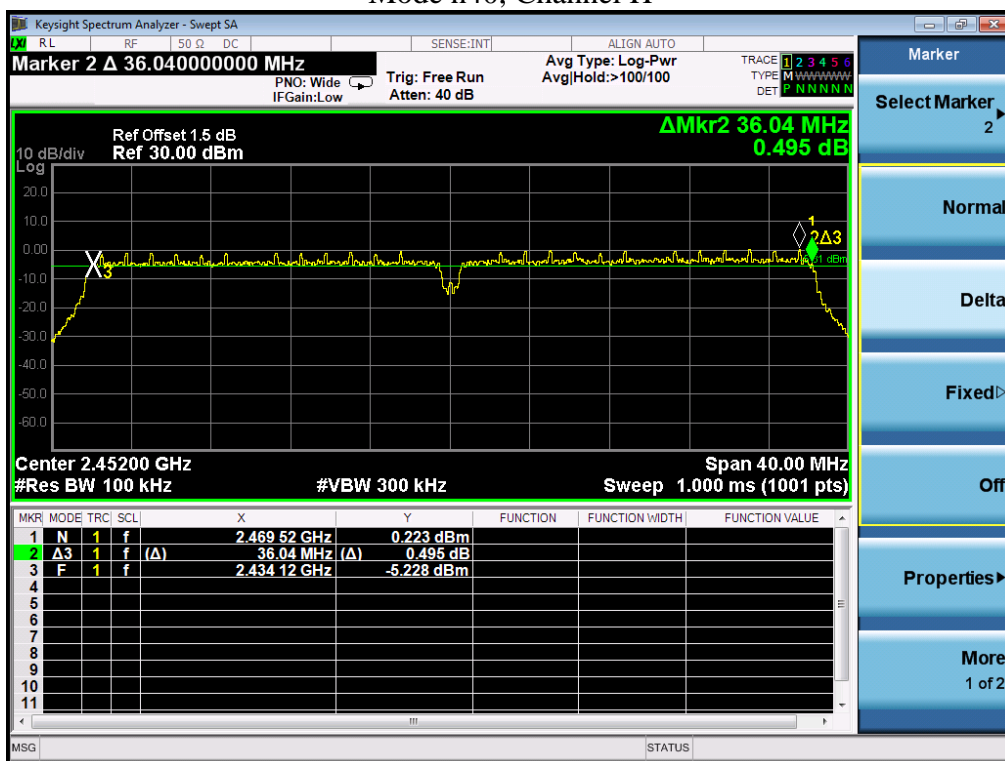



## 4. Maximum peak output power

**Test result: Pass**

### 4.1 Test limit

- For frequency hopping systems operating in the 2400-2483.5 MHz band employing at least 75 non-overlapping hopping channels, and all frequency hopping systems in the 5725-5850 MHz band: 1 watt
- For all other frequency hopping systems in the 2400-2483.5 MHz band: 0.125 watts
- For systems using digital modulation in the 902-928 MHz, 2400-2483.5 MHz, and 5725-5850 MHz bands: 1 Watt.

If the transmitting antenna of directional gain greater than 6dBi is used, the power shall be reduced by the amount in dB that the directional gain of the antenna exceeds 6dBi.

### 4.2 Test Configuration

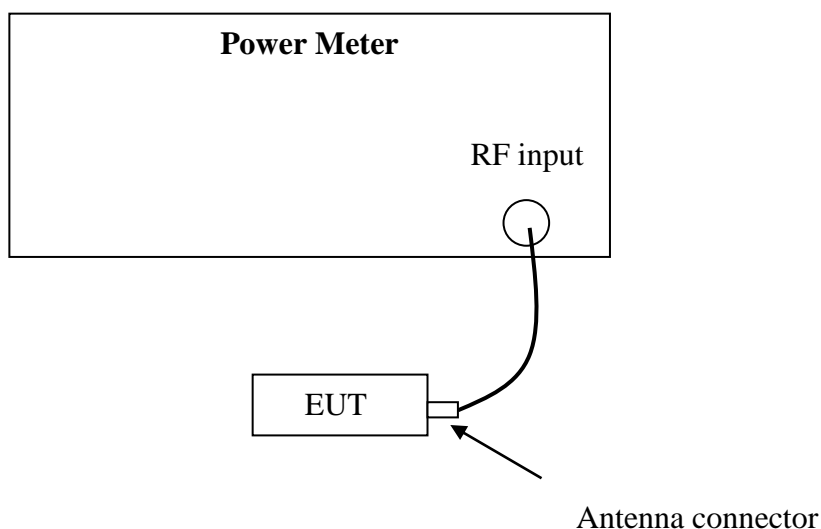

### 4.3 Test procedure and test setup

This test is conducted according to DTS test procedure of "KDB 558074 (v05)":  
PKPM1 Peak power meter method: The maximum peak conducted output power is measured using a broadband peak RF power meter.

**4.4 Test protocol**

Temperature : 25 °C

Relative Humidity : 55 %

Mode	CH	Conducted Power (dBm)	Limit (dBm)
b	L	16.30	≤30
	M	16.50	
	H	16.20	
g	L	19.90	
	M	20.70	
	H	20.50	
n20	L	21.20	
	M	21.40	
	H	21.50	
n40	L	21.60	
	M	21.80	
	H	21.70	

Maximum EIRP = 21.80dBm + 2.0dBi = 23.80dBm < IC EIRP limit of 36dBm

## 5. Power spectrum density

**Test result: Pass**

### 5.1 Test limit

For digitally modulated systems, the power spectral density conducted from the intentional radiator to the antenna shall not be greater than 8dBm in any 3 kHz band during any time interval of continuous transmission.

### 5.2 Test Configuration

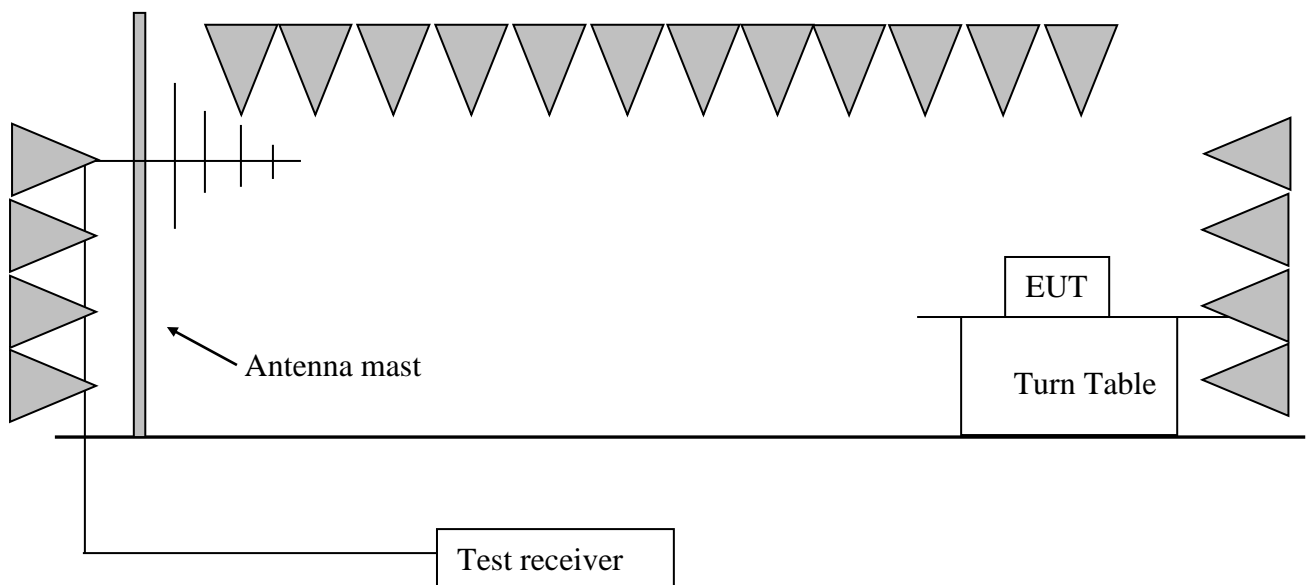

### 5.3 Test procedure and test setup

This test is conducted according to DTS test procedure of “KDB 558074 (v05)”:

- Set analyzer center frequency to DTS channel center frequency.
- Set the span to 1.5 times the DTS bandwidth.
- Set the RBW to:  $3 \text{ kHz} \leq \text{RBW} \leq 100 \text{ kHz}$ .
- Set the VBW  $\geq 3 \times \text{RBW}$ .
- Detector = peak.
- Sweep time = auto couple.
- Trace mode = max hold.
- Allow trace to fully stabilize.
- Use the peak marker function to determine the maximum amplitude level within the RBW.
- If measured value exceeds limit, reduce RBW (no less than 3 kHz) and repeat.

**5.4 Test Protocol**

Temperature : 25 °C

Relative Humidity: 55 %

Mode	CH	Original Reading (dBm/3kHz)	Limit (dBm/3kHz)
b	L	0.62	≤8.00
	M	-0.52	
	H	-2.54	
g	L	-15.02	
	M	-16.06	
	H	-15.46	
n20	L	-14.67	
	M	-14.90	
	H	-15.69	
n40	L	-14.07	
	M	-14.84	
	H	-15.94	

Mode b, Channel L

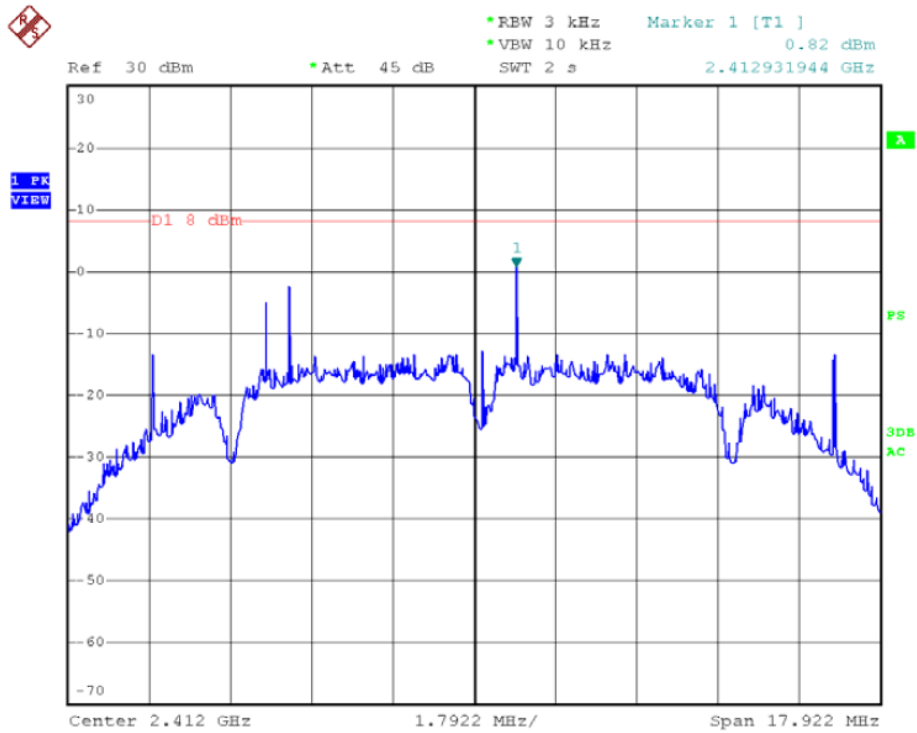

Mode b, Channel M

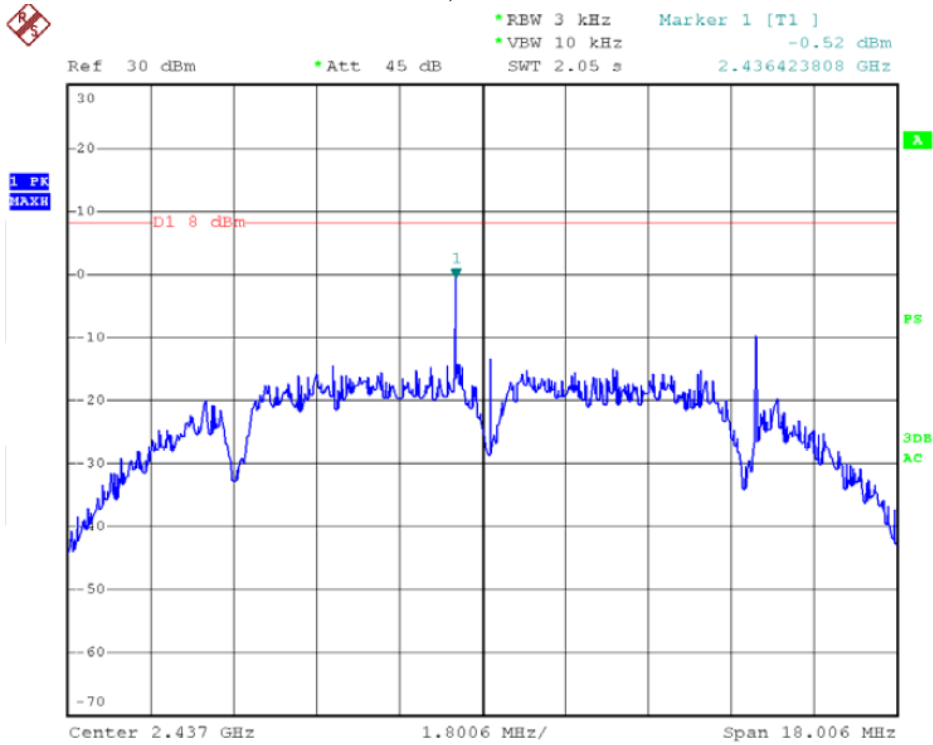

Mode b, Channel H

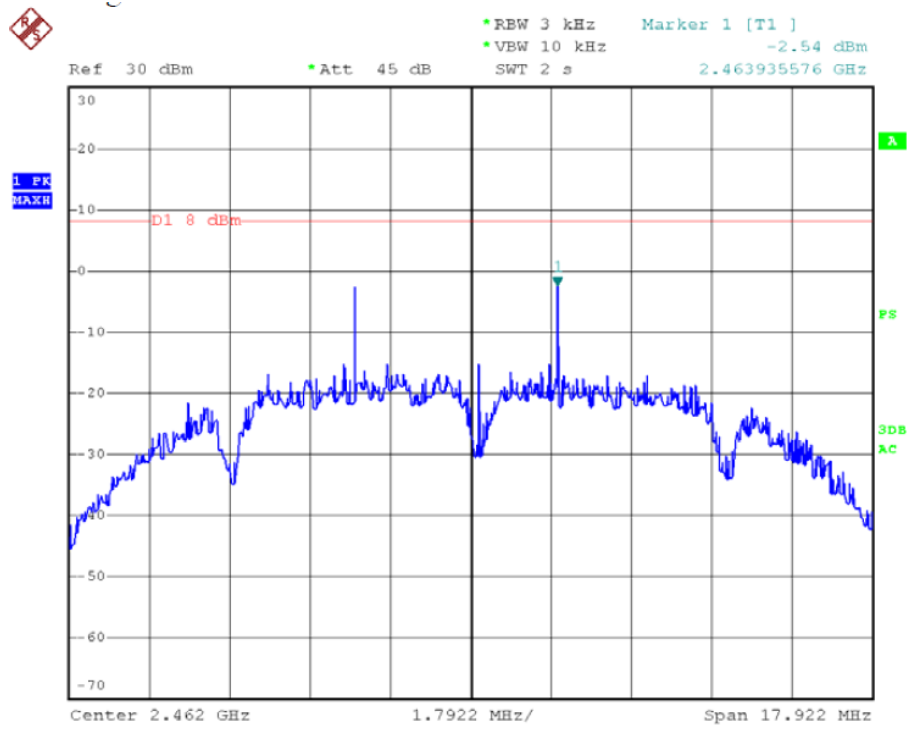

Mode g, Channel L

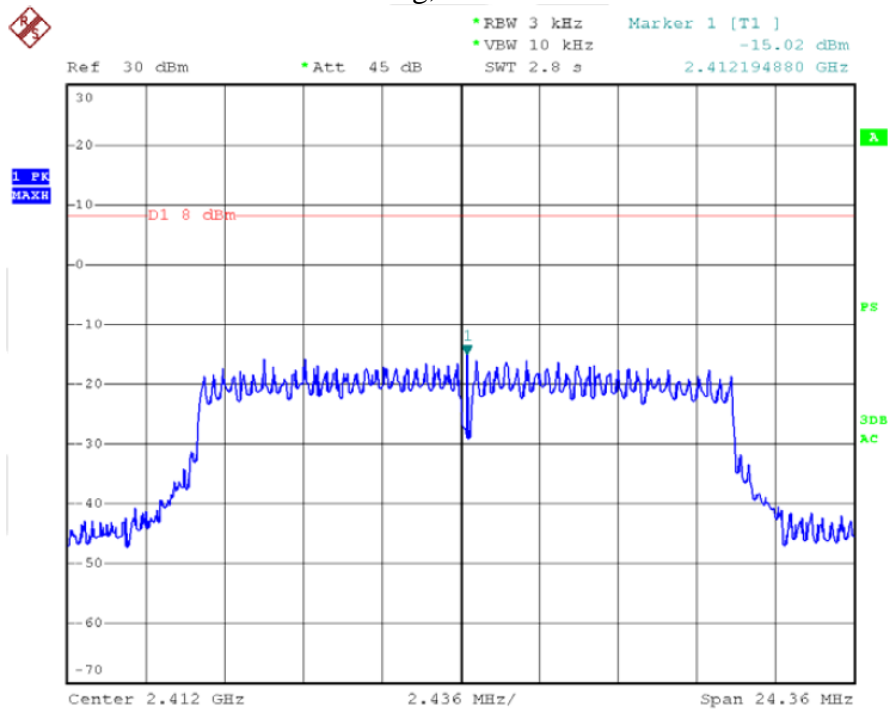

Mode g, Channel M

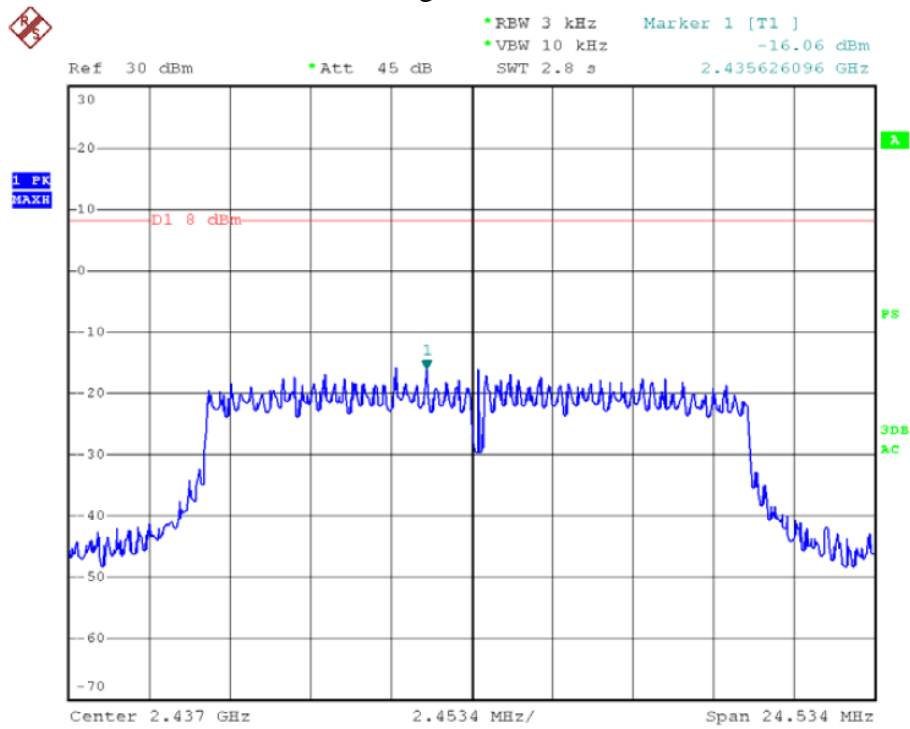

Mode g, Channel H

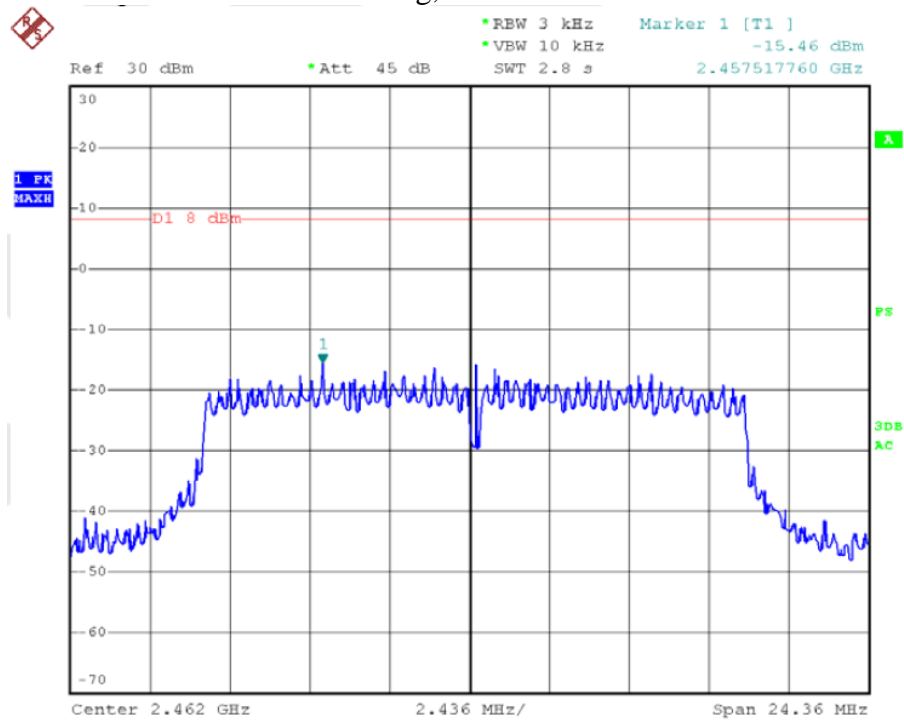

Mode n20, Channel L

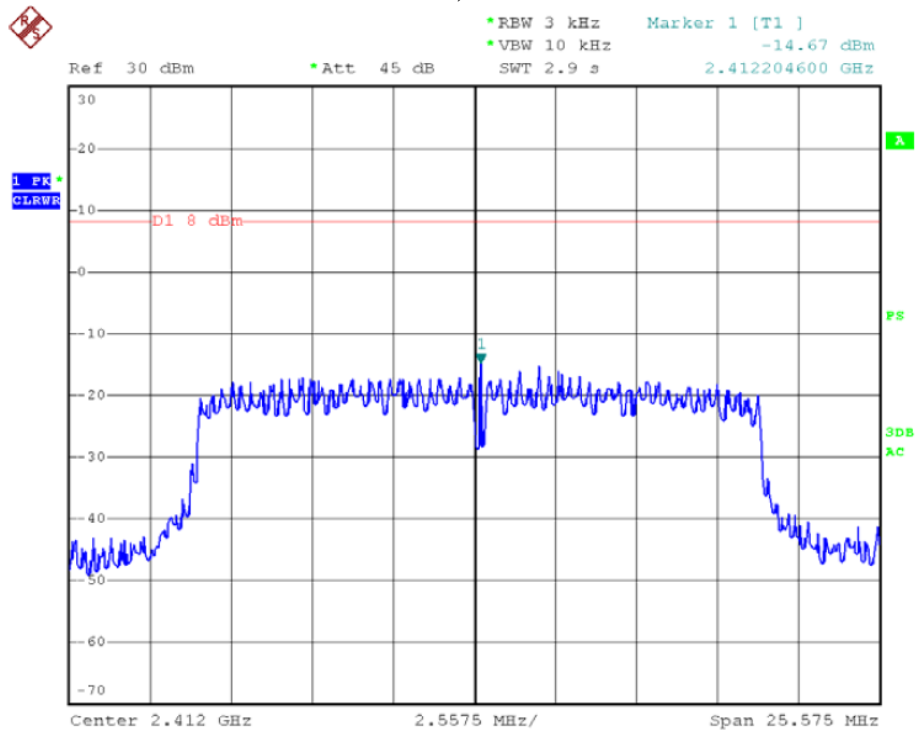

Mode n20, Channel M

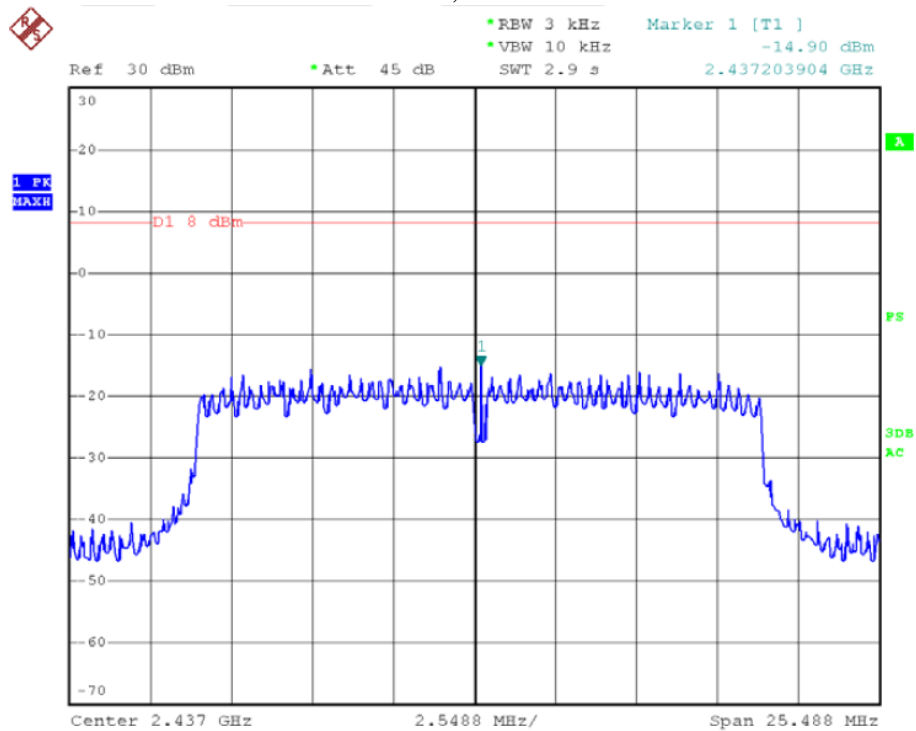



Mode n20, Channel H

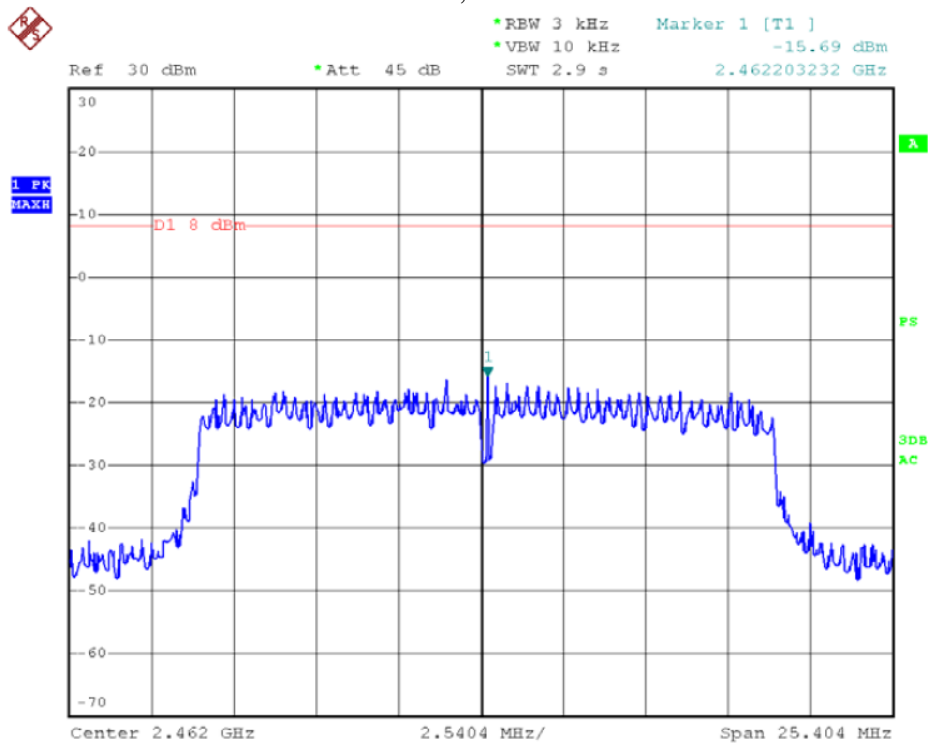

Mode n40, Channel L

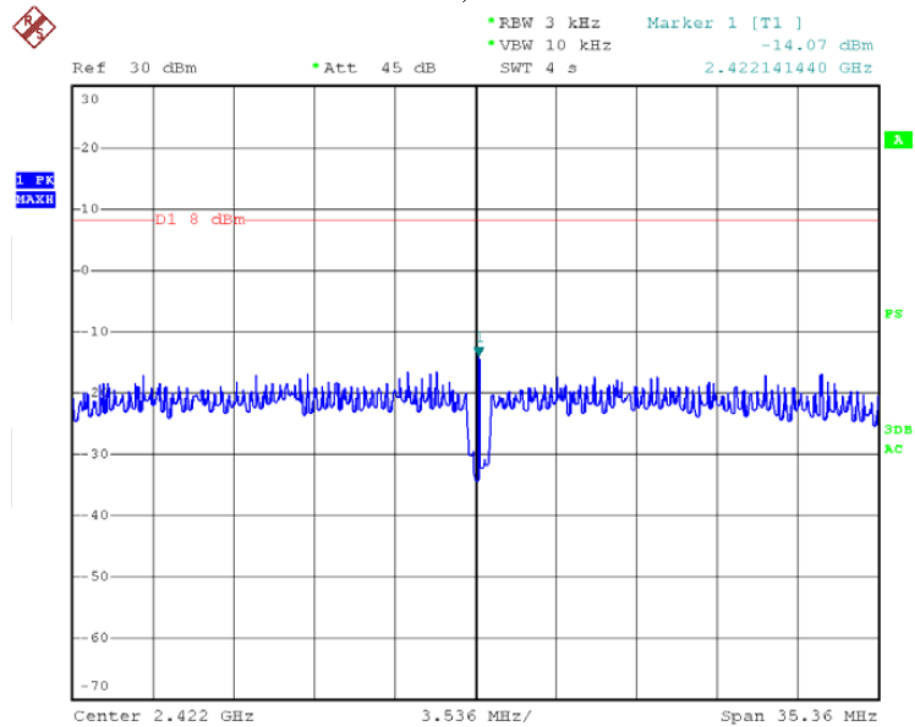

### Mode n40, Channel M

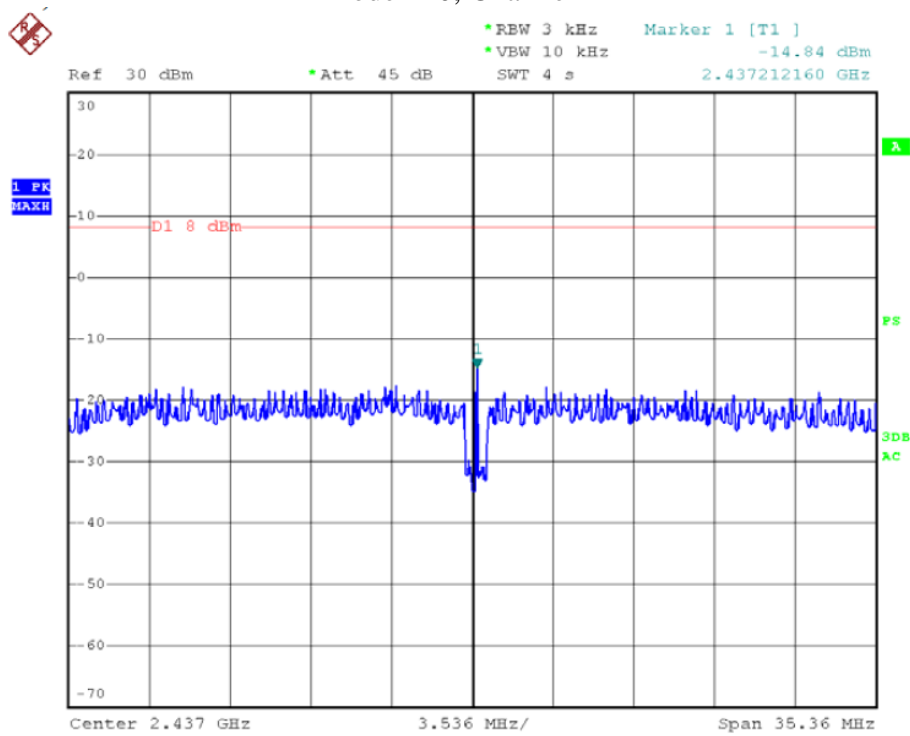

### Mode n40, Channel H

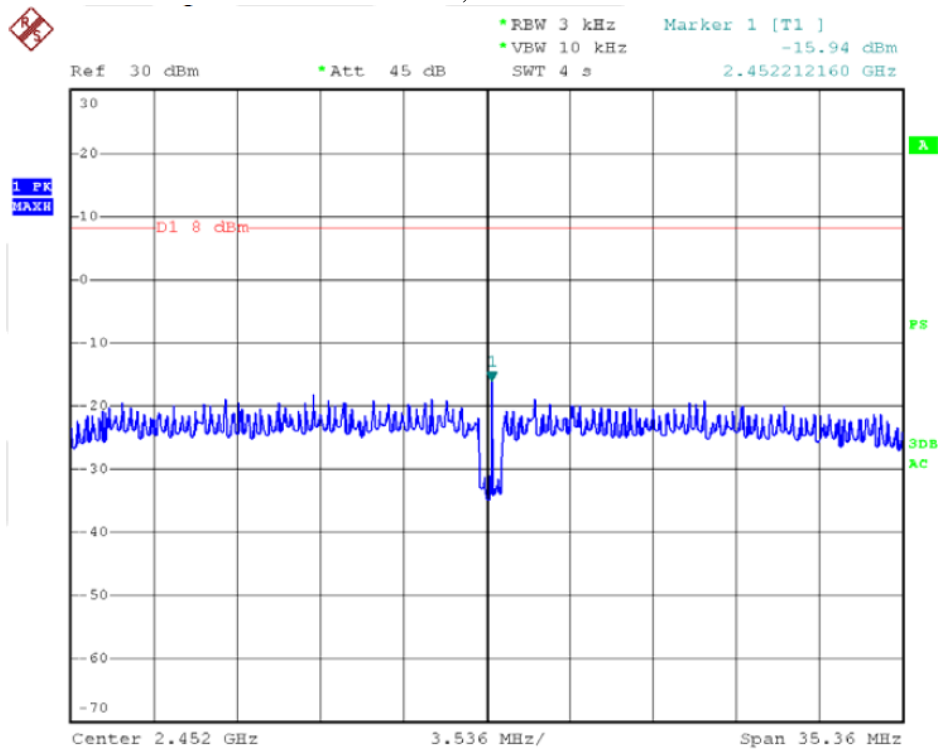

## 6. Radiated emission

**Test result: PASS**

### 6.1 Test limit

The radiated emissions which fall in the restricted bands, as defined in §15.205(a), must also comply with the radiated emission limits specified in §15.209(a) showed as below:

Frequency (MHz)	Field Strength (dBuV/m)	Measurement Distance (m)
30 - 88	40.0	3
88 - 216	43.5	3
216 - 960	46.0	3
Above 960	54.0	3

### 6.2 Test Configuration

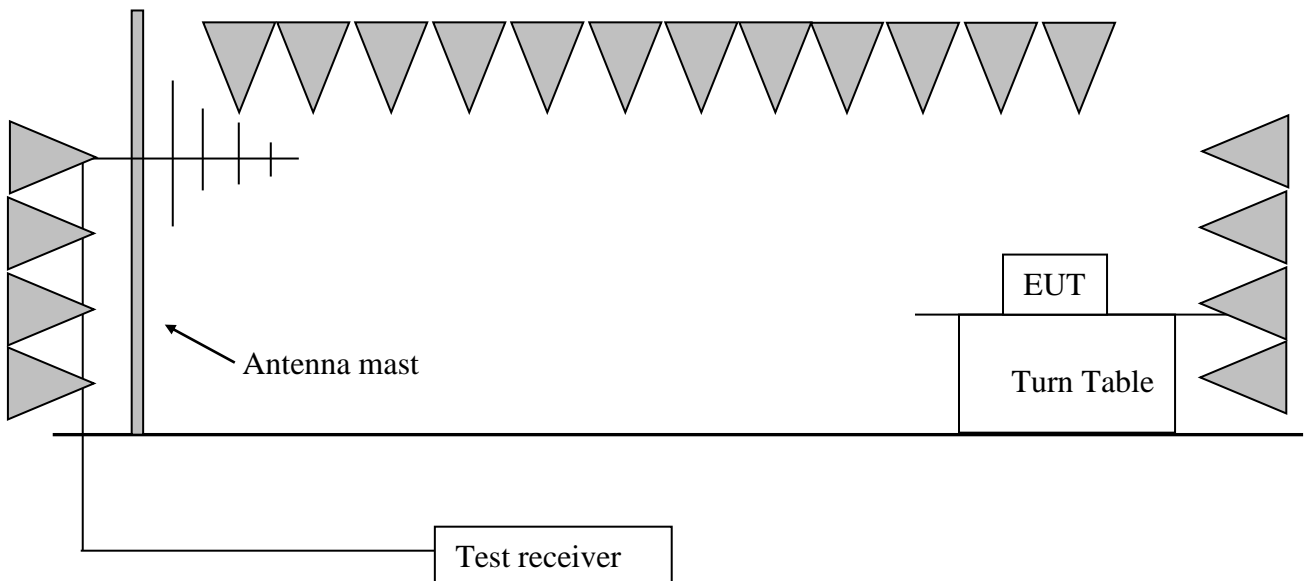

### 6.3 Test procedure and test setup

The measurement was applied in a semi-anechoic chamber. While testing for spurious emission higher than 1GHz, if applied, the pre-amplifier would be equipped just at the output terminal of the antenna.

The EUT and simulators were placed on a 0.8m high wooden turntable above the horizontal metal ground plane. The turn table rotated 360 degrees to determine the position of the maximum emission level. The EUT was set 3 meters away from the receiving antenna which was mounted on an antenna mast. The antenna moved up and down between from 1meter to 4 meters to find out the maximum emission level.

The EUT was tested according to DTS test procedure of KDB558074 D01 DTS “Meas Guidance v03r03” for compliance to FCC 47CFR 15.247 requirements.

The radiated emission was measured using the Spectrum Analyzer with the resolutions bandwidth set as:

RBW = 300 Hz, VBW = 1 kHz (9 kHz~150 kHz);  
RBW = 10 kHz, VBW = 30 kHz (150 kHz~30MHz);  
RBW = 100 kHz, VBW = 300 kHz (30MHz~1GHz for PK)  
RBW = 1MHz, VBW = 3MHz (>1GHz for PK);  
RBW = 1MHz, VBW = 10Hz (>1GHz for AV);

Remark:

1. Factor= Antenna Factor + Cable Loss (-Amplifier, is employed)
2. Measured level= Original Receiver Reading + Factor
3. Margin = Limit – Measured level
4. If the PK measured level is lower than AV limit, the AV test can be elided.

Example:

Assuming Antenna Factor = 30.20dB/m, Cable Loss = 2.00dB,  
Gain of Preamplifier = 32.00dB, Original Receiver Reading = 10dBuV.  
Then Factor = 30.20 + 2.00 – 32.00 = 0.20dB/m;  
Measured level = 10dBuV + 0.20dB/m = 10.20dBuV/m  
Assuming limit = 54dBuV/m,  
Measured level = 10.20dBuV/m, then Margin = 54 - 10.20 = 43.80dBuV/m.

**6.4 Test protocol**

Mode b

CH	Polarization	Frequency (MHz)	Correct Factor (dB/m)	Corrected Reading (dBuV/m)	Limit (dBuV/m)	Margin (dB)	Detector
L	V	2412.36	34.30	105.30	Fundamental	/	PK
	V	46.85	17.82	26.10	40.00	13.90	PK
	V	450.98	26.04	31.20	46.00	14.80	PK
	H	500.45	26.94	31.10	46.00	14.90	PK
	H	842.86	32.36	35.70	46.00	10.30	PK
	V	2386.39	-2.52	53.00	54.00	1.00	PK
	V	2390.00	-2.51	51.00	54.00	3.00	PK
	V	4825.00	3.34	71.70	74.00	2.30	PK
	V	4825.00	3.34	51.10	54.00	2.90	AV
	V	7238.46	5.31	61.20	74.00	12.80	PK
	V	7238.46	5.31	39.80	54.00	14.20	AV
	V	9650.72	6.29	50.10	54.00	3.90	PK
M	V	2437.50	34.50	105.50	Fundamental	/	PK
	V	46.85	17.82	26.10	40.00	13.90	PK
	V	450.98	26.04	31.20	46.00	14.80	PK
	H	500.45	26.94	31.10	46.00	14.90	PK
	H	842.86	32.36	35.70	46.00	10.30	PK
	V	4867.50	3.41	70.30	74.00	3.70	PK
	V	4867.50	3.41	51.40	54.00	2.60	AV
	V	7314.56	5.39	61.90	74.00	12.10	PK
	V	7314.56	5.39	40.20	54.00	13.80	AV
	V	9751.44	6.31	50.30	54.00	3.70	PK
H	V	2462.06	34.60	105.80	Fundamental	/	PK
	V	46.85	17.82	26.10	40.00	13.90	PK
	V	450.98	26.04	31.20	46.00	14.80	PK
	H	500.45	26.94	31.10	46.00	14.90	PK

	H	842.86	32.36	35.70	46.00	10.30	PK
	V	2483.50	-2.30	53.10	54.00	0.90	PK
	V	4910.00	3.49	70.80	74.00	3.20	PK
	V	4949.90	3.49	51.00	54.00	3.00	AV
	V	7387.93	5.46	61.60	74.00	12.40	PK
	V	7387.93	5.46	40.00	54.00	14.00	AV
	V	9850.91	6.42	50.10	54.00	3.90	PK

Mode g

CH	Polarization	Frequency (MHz)	Correct Factor (dB/m)	Corrected Reading (dBuV/m)	Limit (dBuV/m)	Margin (dB)	Detector
L	V	2412.36	34.30	105.70	Fundamental	/	PK
	V	46.85	17.82	26.10	40.00	13.90	PK
	V	450.98	26.04	31.20	46.00	14.80	PK
	H	500.45	26.94	31.10	46.00	14.90	PK
	H	842.86	32.36	35.70	46.00	10.30	PK
	V	2390.00	-2.51	50.20	54.00	3.80	PK
	V	4825.00	3.34	70.20	74.00	3.80	PK
	V	4825.00	3.34	50.40	54.00	3.60	AV
	V	7238.46	5.31	60.00	74.00	14.00	PK
	V	7238.46	5.31	39.30	54.00	14.70	AV
	V	9650.72	6.29	49.40	54.00	4.60	PK
M	V	2437.50	34.50	105.80	Fundamental	/	PK
	V	46.85	17.82	26.10	40.00	13.90	PK
	V	450.98	26.04	31.20	46.00	14.80	PK
	H	500.45	26.94	31.10	46.00	14.90	PK
	H	842.86	32.36	35.70	46.00	10.30	PK
	V	4867.50	3.41	70.30	74.00	3.70	PK
	V	4867.50	3.41	51.40	54.00	2.60	AV
	V	7314.56	5.39	61.20	74.00	12.80	PK

	V	7314.56	5.39	40.00	54.00	14.00	AV
	V	9751.44	6.31	50.60	54.00	3.40	PK
H	V	2462.06	34.60	106.30	Fundamental	/	PK
	V	46.85	17.82	26.10	40.00	13.90	PK
	V	450.98	26.04	31.20	46.00	14.80	PK
	H	500.45	26.94	31.10	46.00	14.90	PK
	H	842.86	32.36	35.70	46.00	10.30	PK
	V	2483.50	-2.30	52.40	54.00	1.60	PK
	V	4910.00	3.49	70.30	74.00	3.70	PK
	V	4949.90	3.49	50.50	54.00	3.50	AV
	V	7387.93	5.46	61.10	74.00	12.90	PK
	V	7387.93	5.46	40.10	54.00	13.90	AV
	V	9850.91	6.42	50.20	54.00	3.80	PK

Mode n20

CH	Polarization	Frequency (MHz)	Correct Factor (dB/m)	Corrected Reading (dBuV/m)	Limit (dBuV/m)	Margin (dB)	Detector
L	V	2412.36	34.30	105.50	Fundamental	/	PK
	V	46.85	17.82	26.10	40.00	13.90	PK
	V	450.98	26.04	31.20	46.00	14.80	PK
	H	500.45	26.94	31.10	46.00	14.90	PK
	H	842.86	32.36	35.70	46.00	10.30	PK
	V	2390.00	-2.51	50.30	54.00	3.70	PK
	V	4825.00	3.34	70.00	74.00	4.00	PK
	V	4825.00	3.34	50.20	54.00	3.80	AV
	V	7238.46	5.31	60.10	74.00	13.90	PK
	V	7238.46	5.31	39.50	54.00	14.50	AV
	V	9650.72	6.29	49.60	54.00	4.40	PK
M	V	2437.50	34.50	105.60	Fundamental	/	PK
	V	46.85	17.82	26.10	40.00	13.90	PK

	V	450.98	26.04	31.20	46.00	14.80	PK
	H	500.45	26.94	31.10	46.00	14.90	PK
	H	842.86	32.36	35.70	46.00	10.30	PK
	V	4867.50	3.41	70.50	74.00	3.50	PK
	V	4867.50	3.41	51.50	54.00	2.50	AV
	V	7314.56	5.39	61.00	74.00	13.00	PK
	V	7314.56	5.39	40.10	54.00	13.90	AV
	V	9751.44	6.31	50.40	54.00	3.60	PK
H	V	2462.06	34.60	106.00	Fundamental	/	PK
	V	46.85	17.82	26.10	40.00	13.90	PK
	V	450.98	26.04	31.20	46.00	14.80	PK
	H	500.45	26.94	31.10	46.00	14.90	PK
	H	842.86	32.36	35.70	46.00	10.30	PK
	V	2483.50	-2.30	52.40	54.00	1.60	PK
	V	4910.00	3.49	70.10	74.00	3.90	PK
	V	4949.90	3.49	50.00	54.00	4.00	AV
	V	7387.93	5.46	61.40	74.00	12.60	PK
	V	7387.93	5.46	40.10	54.00	13.90	AV
	V	9850.91	6.42	49.70	54.00	4.30	PK

Mode n40

CH	Polarization	Frequency (MHz)	Correct Factor (dB/m)	Corrected Reading (dBuV/m)	Limit (dBuV/m)	Margin (dB)	Detector
L	V	2425.37	34.40	103.20	Fundamental	/	PK
	V	46.85	17.82	26.10	40.00	13.90	PK
	V	450.98	26.04	31.20	46.00	14.80	PK
	H	500.45	26.94	31.10	46.00	14.90	PK
	H	842.86	32.36	35.70	46.00	10.30	PK
	V	2390.00	-2.51	49.60	54.00	4.40	PK
	V	4845.63	3.36	67.10	74.00	6.90	PK



	V	4845.63	3.36	46.70	54.00	7.30	AV
	V	7266.03	5.35	51.20	54.00	2.80	PK
	V	9686.16	6.32	49.60	54.00	4.40	PK
M	V	2439.62	34.50	103.40	Fundamental	/	PK
	V	46.85	17.82	26.10	40.00	13.90	PK
	V	450.98	26.04	31.20	46.00	14.80	PK
	H	500.45	26.94	31.10	46.00	14.90	PK
	H	842.86	32.36	35.70	46.00	10.30	PK
	V	4868.06	3.41	67.30	74.00	6.70	PK
	V	4868.06	3.41	46.80	54.00	7.20	AV
	V	7314.82	5.39	51.50	54.00	2.50	PK
	V	9751.86	6.36	50.40	54.00	3.60	PK
H	V	2450.67	34.60	103.70	Fundamental	/	PK
	V	46.85	17.82	26.10	40.00	13.90	PK
	V	450.98	26.04	31.20	46.00	14.80	PK
	H	500.45	26.94	31.10	46.00	14.90	PK
	H	842.86	32.36	35.70	46.00	10.30	PK
	V	2483.50	-2.30	52.40	54.00	1.60	PK
	V	4904.09	3.47	67.30	74.00	6.70	PK
	V	4904.09	3.47	46.90	54.00	7.10	AV
	V	7358.91	5.44	51.50	54.00	2.50	PK
	V	9810.72	6.40	49.70	54.00	4.30	PK

Simultaneously transmission for 802.11b channel M and 433.925MHz:

Polarization	Frequency (MHz)	Correct Factor (dB/m)	Corrected Reading (dBuV/m)	Limit (dBuV/m)	Margin (dB)	Detector
V	46.85	17.82	26.10	40.00	13.90	PK
V	450.98	26.04	31.20	46.00	14.80	PK
H	500.45	26.94	31.10	46.00	14.90	PK
H	842.86	32.36	35.70	46.00	10.30	PK
V	867.98	24.00	44.90	46.00	1.10	QP
H	1296.59	-12.20	50.40	74.00	23.60	PK
V	4867.50	3.41	70.50	74.00	3.50	PK
V	4867.50	3.41	51.50	54.00	2.50	AV
V	7314.56	5.39	61.70	74.00	12.30	PK
V	7314.56	5.39	40.10	54.00	13.90	AV

## 7. Emission outside the frequency Band

**Test result: PASS**

### 7.1 Limit

If the maximum peak conducted output power procedure was used to demonstrate compliance, then the peak output power measured in any 100 kHz bandwidth outside of the authorized frequency band shall be attenuated by at least 20 dB relative to the maximum in-band peak PSD level in 100 kHz (i.e., 20 dBc).

If maximum conducted (average) output power was used to demonstrate compliance, then the peak power in any 100 kHz bandwidth outside of the authorized frequency band shall be attenuated by at least 30 dB relative to the maximum in-band peak PSD level in 100 kHz (i.e., 30 dBc).

### 7.2 Test Configuration

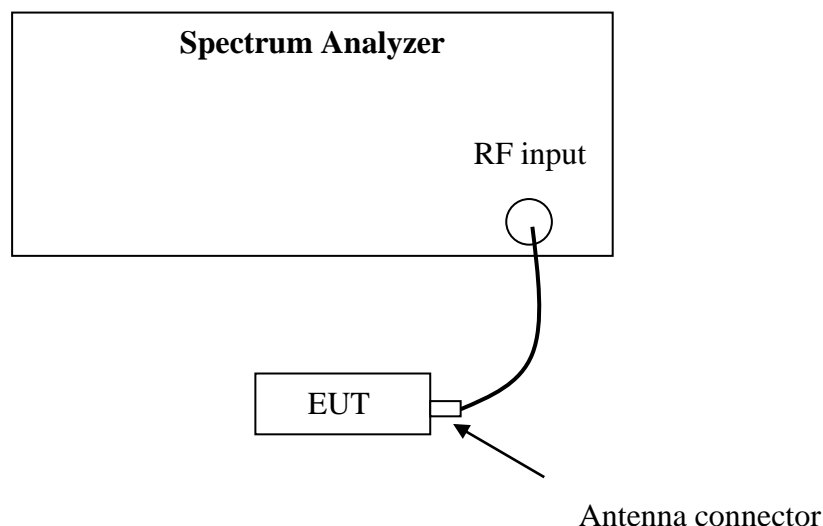

### 7.3 Test procedure and test setup

- a) Set the center frequency and span to encompass frequency range to be measured.
- b) Set the RBW = 100 kHz.
- c) Set the VBW  $\geq 3 \times$  RBW.
- d) Detector = peak.
- e) Sweep time = auto couple.
- f) Trace mode = max hold.
- g) Allow trace to fully stabilize.
- h) Use the peak marker function to determine the maximum amplitude level.

**7.4 Test protocol**

<b>Mode</b>	<b>CH</b>	<b>Out of band Emission (dB)</b>	<b>Limit (dB)</b>
b	L	>20	≥20
	M	>20	
	H	>20	
g	L	>20	
	M	>20	
	H	>20	
n20	L	>20	
	M	>20	
	H	>20	
n40	L	>20	
	M	>20	
	H	>20	

Mode b, Channel L

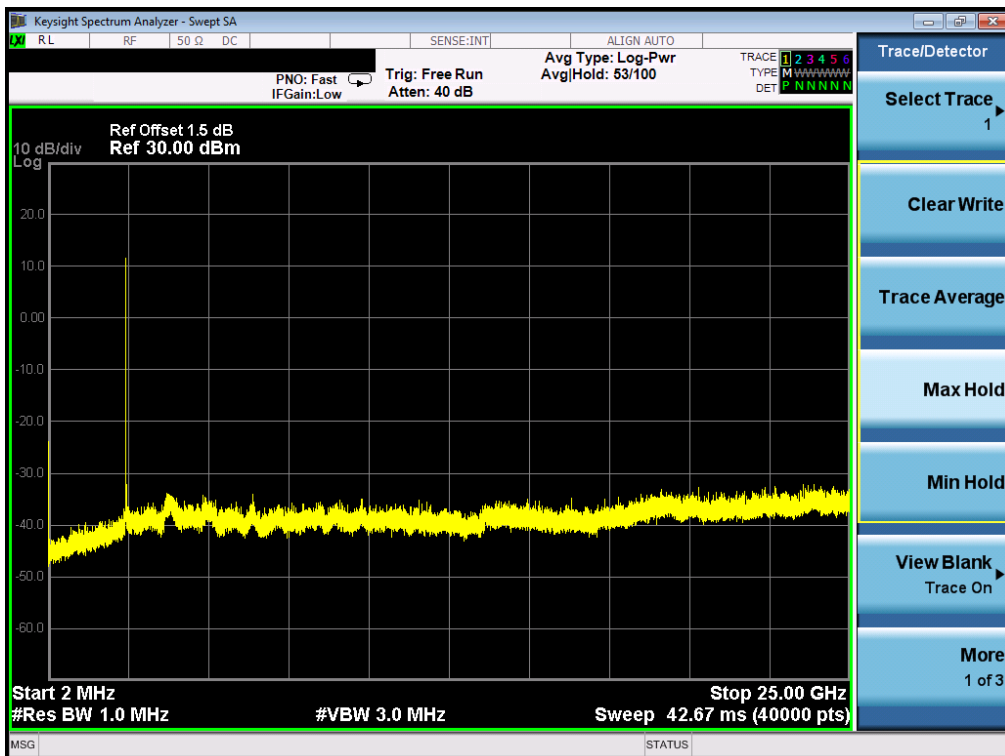
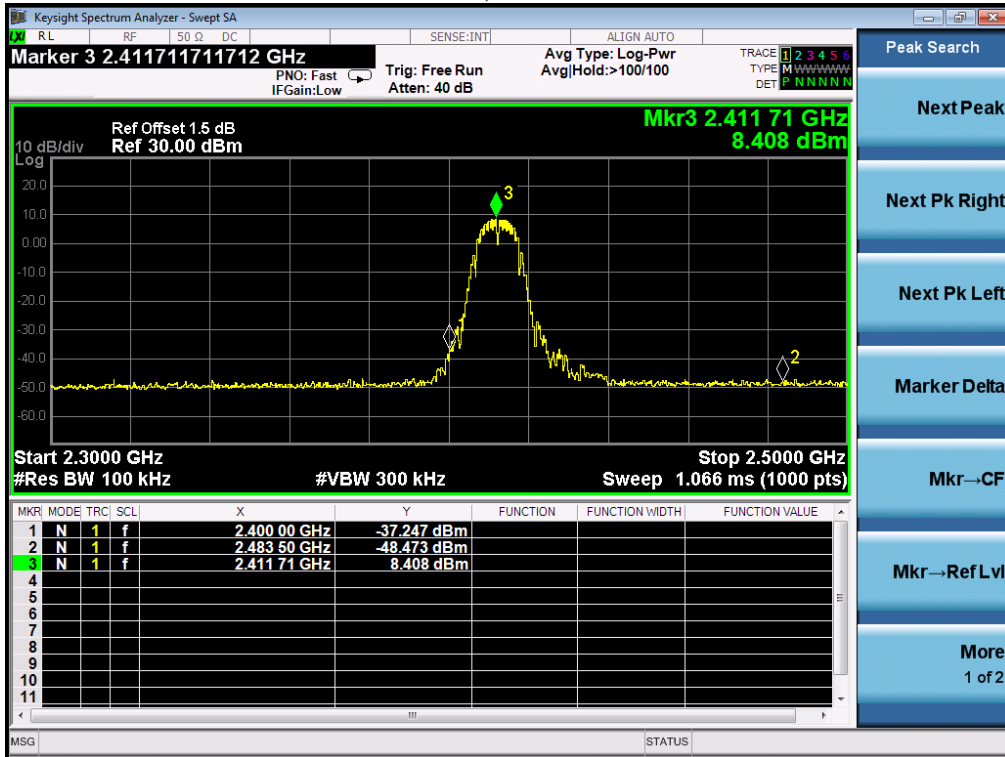

Mode b, Channel M

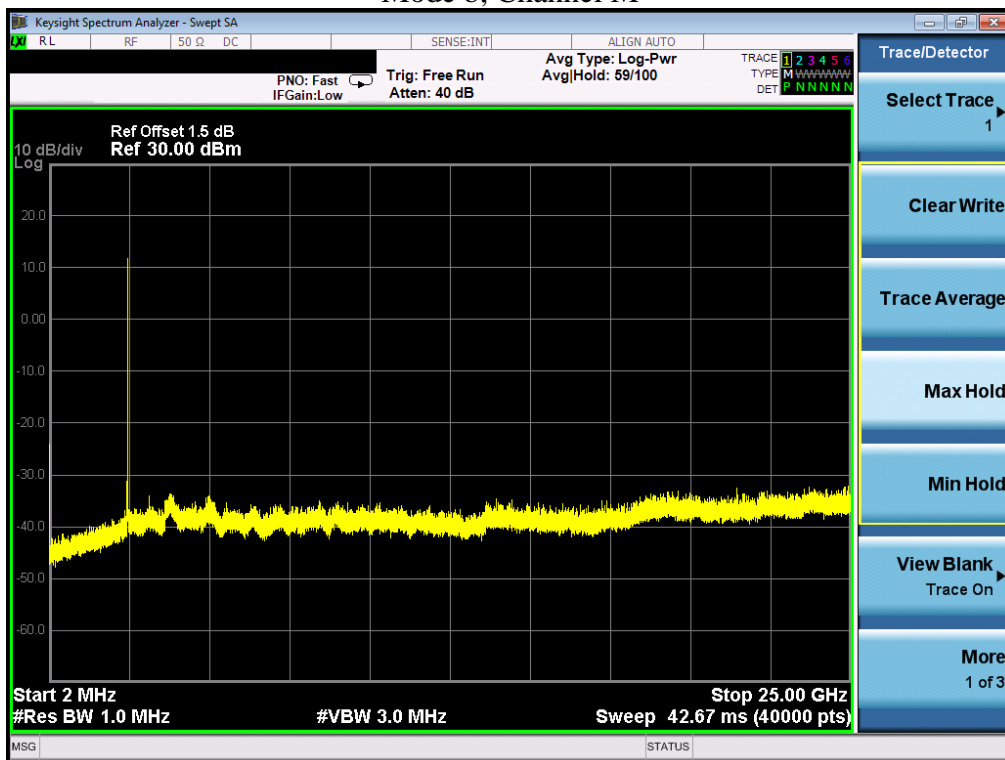

Mode b, Channel H

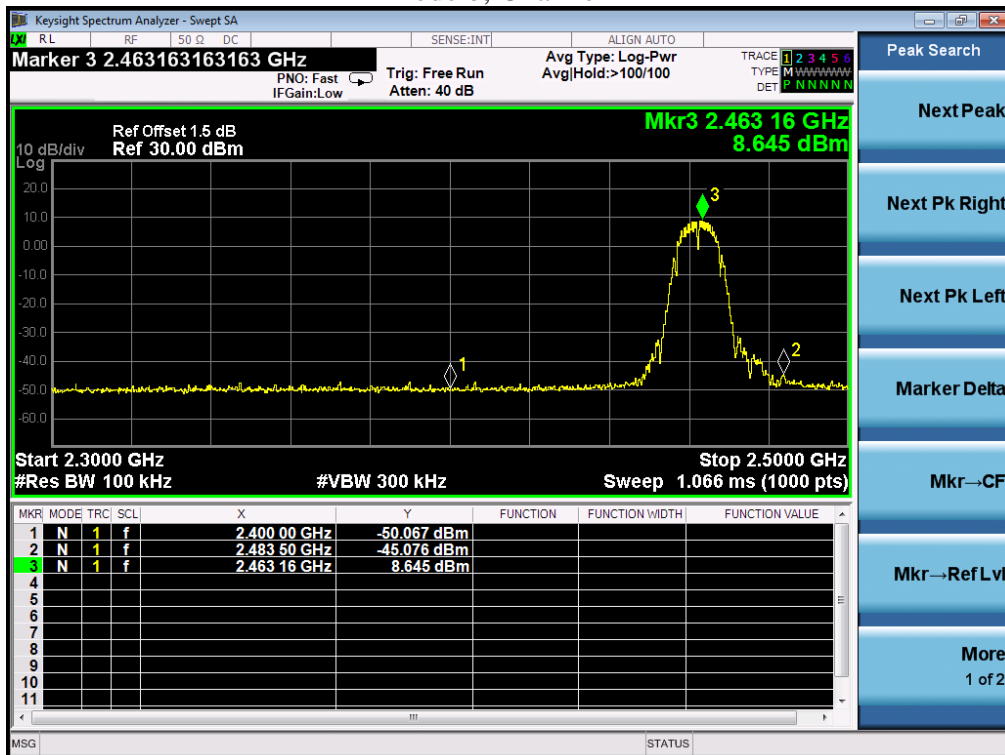

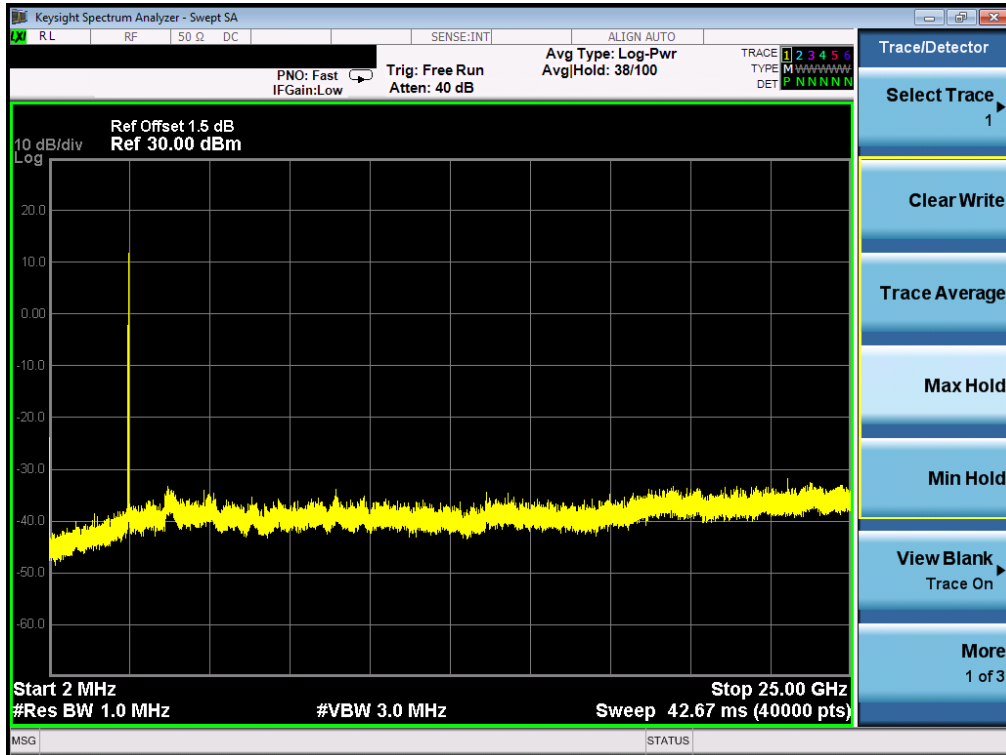

Mode g, Channel L

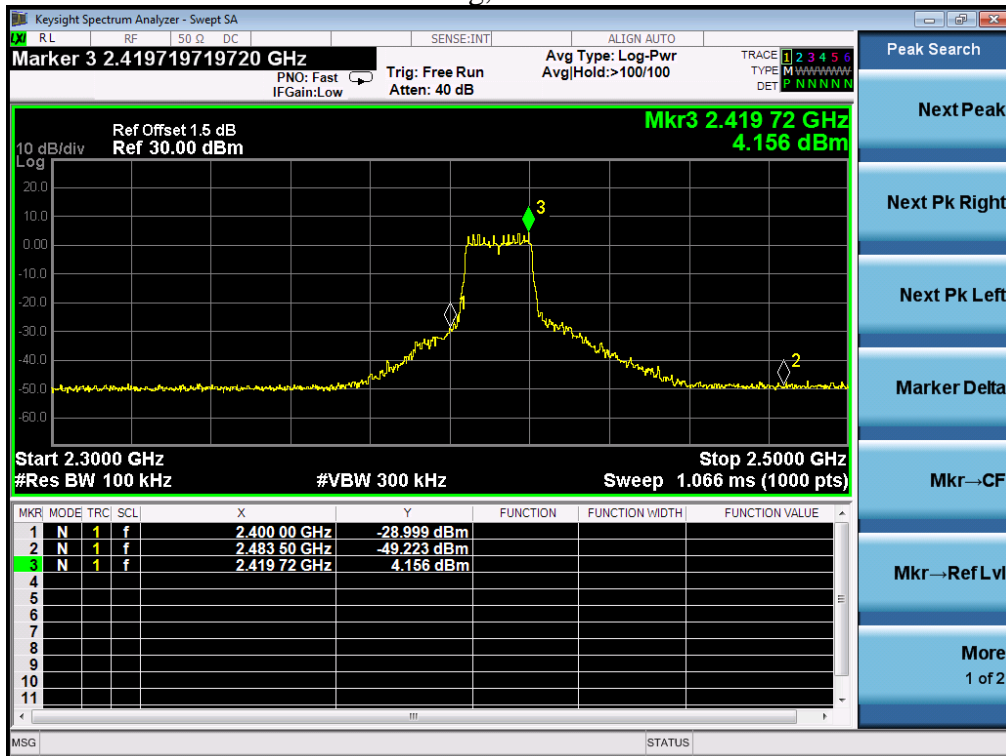

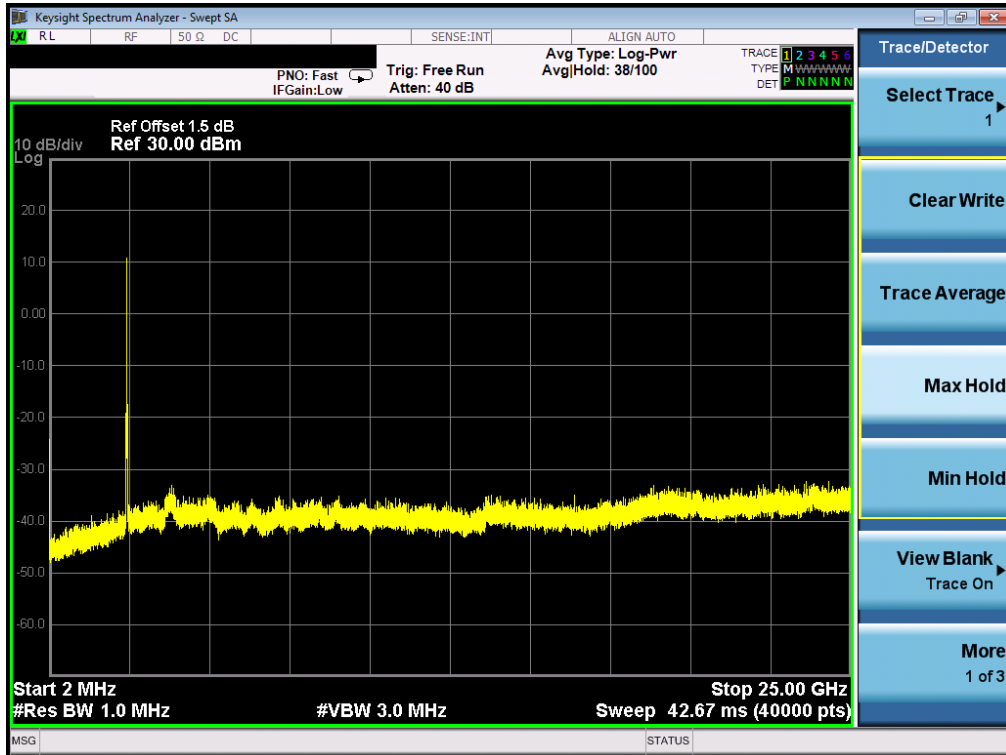

Mode g, Channel M

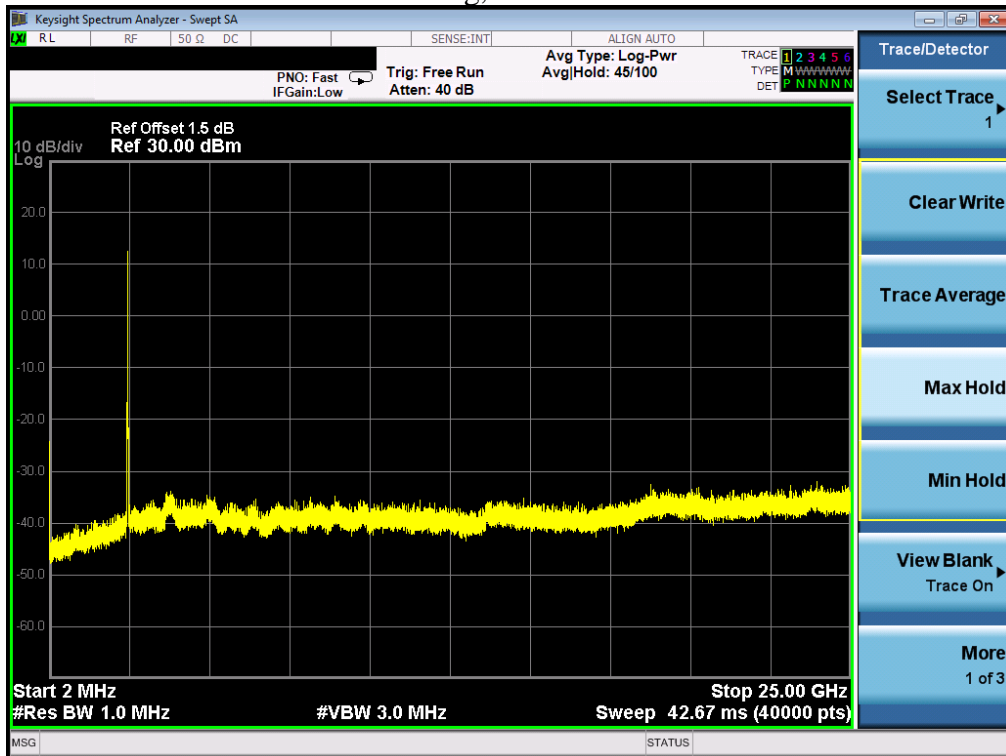



Mode g, Channel H

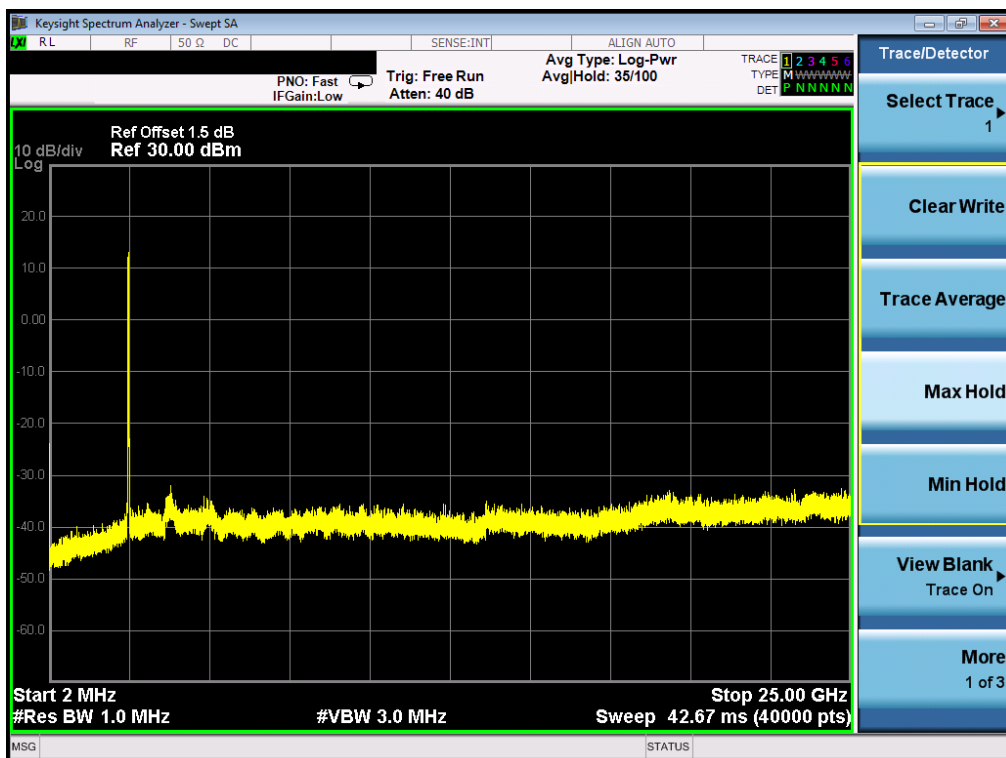
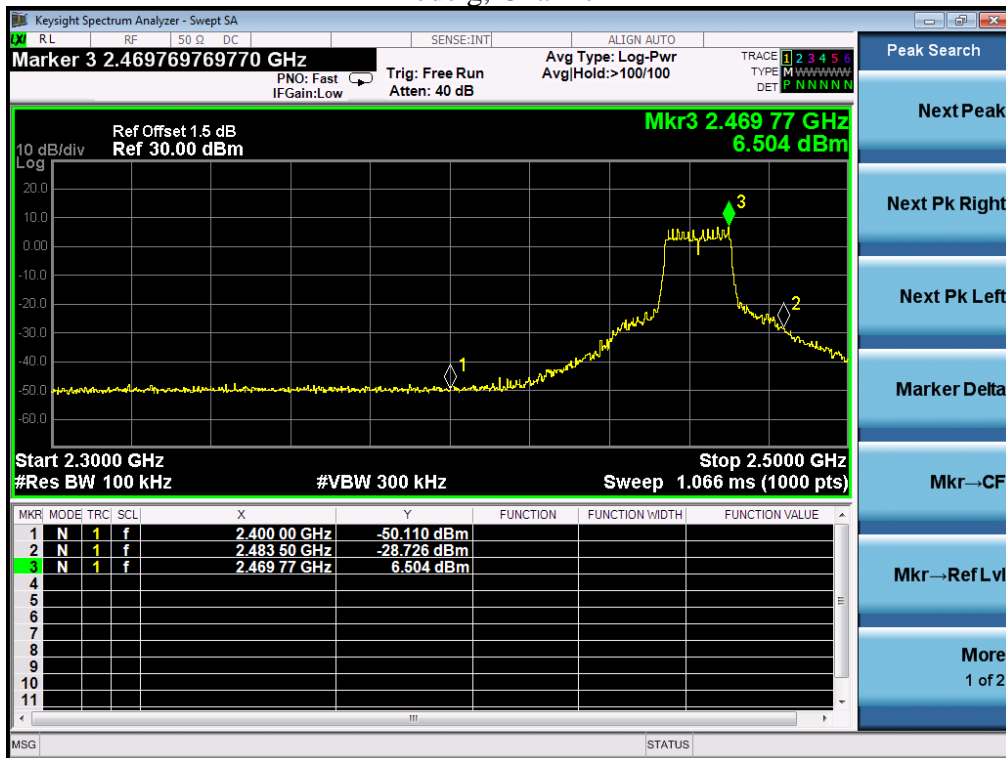

Mode n20, Channel L

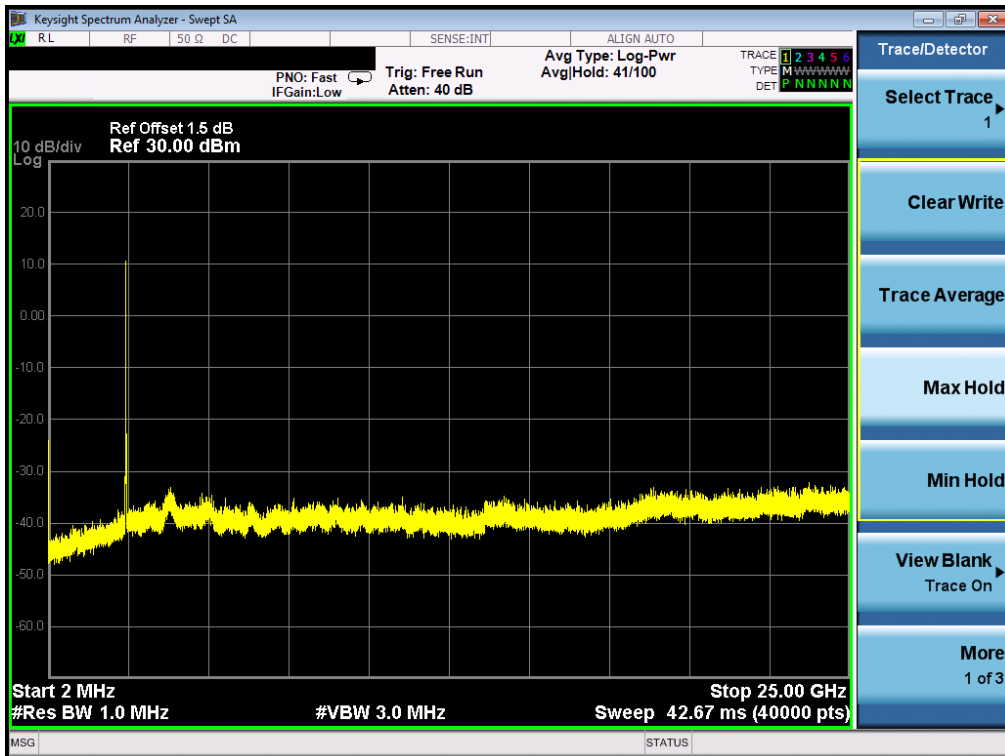
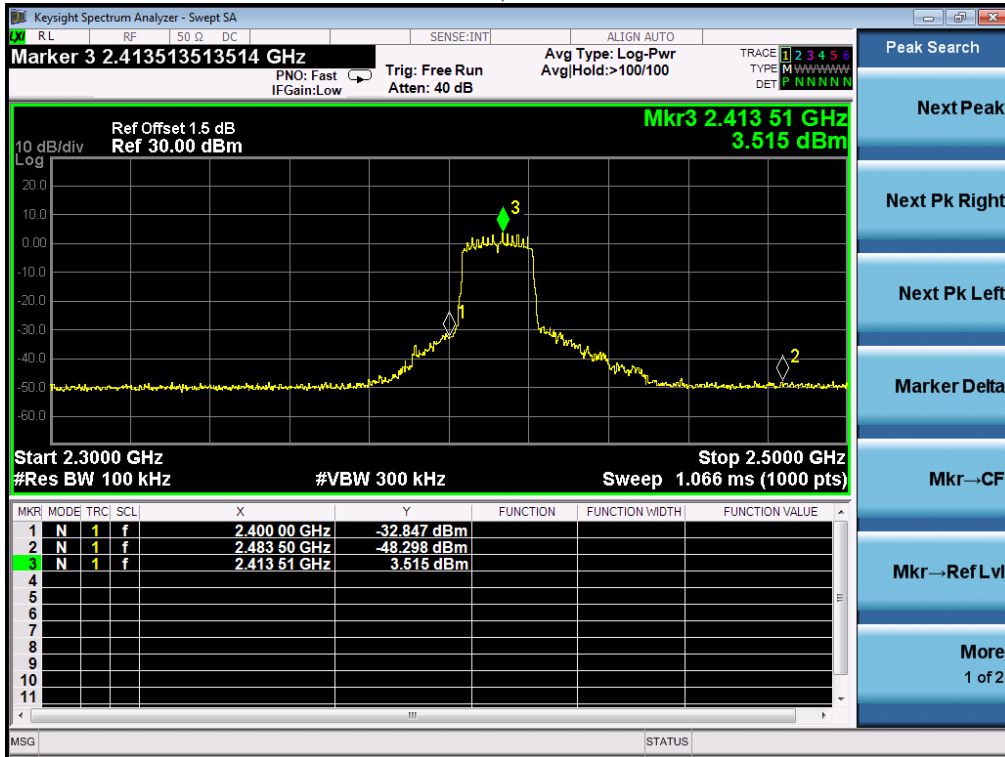

Mode n20, Channel M

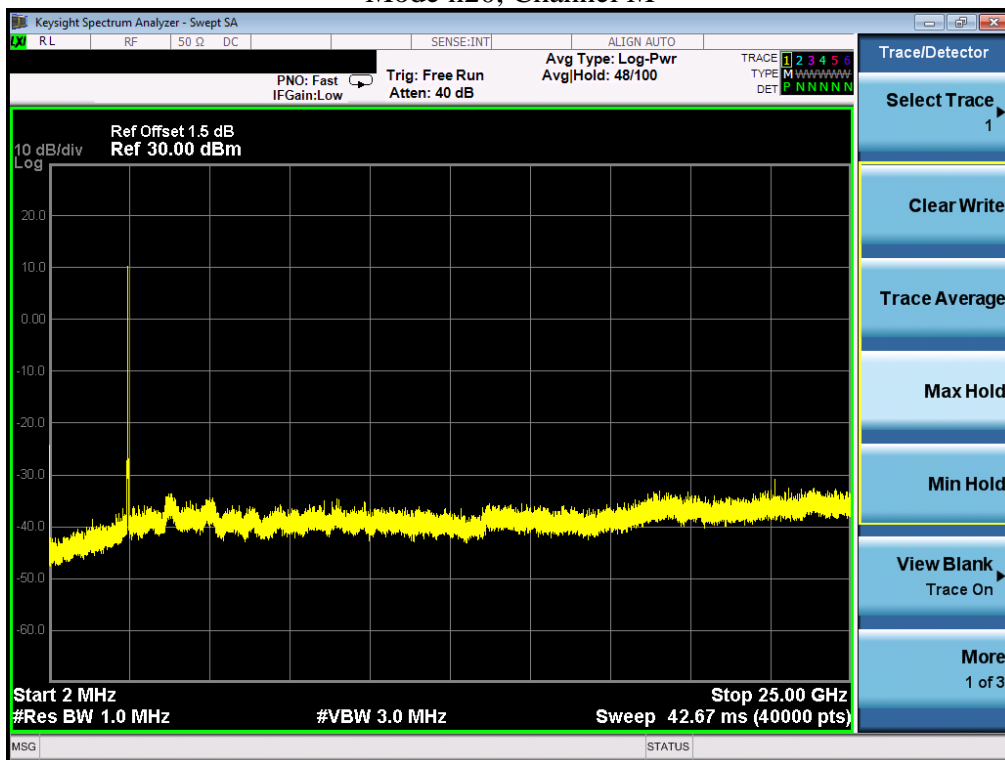

Mode n20, Channel H

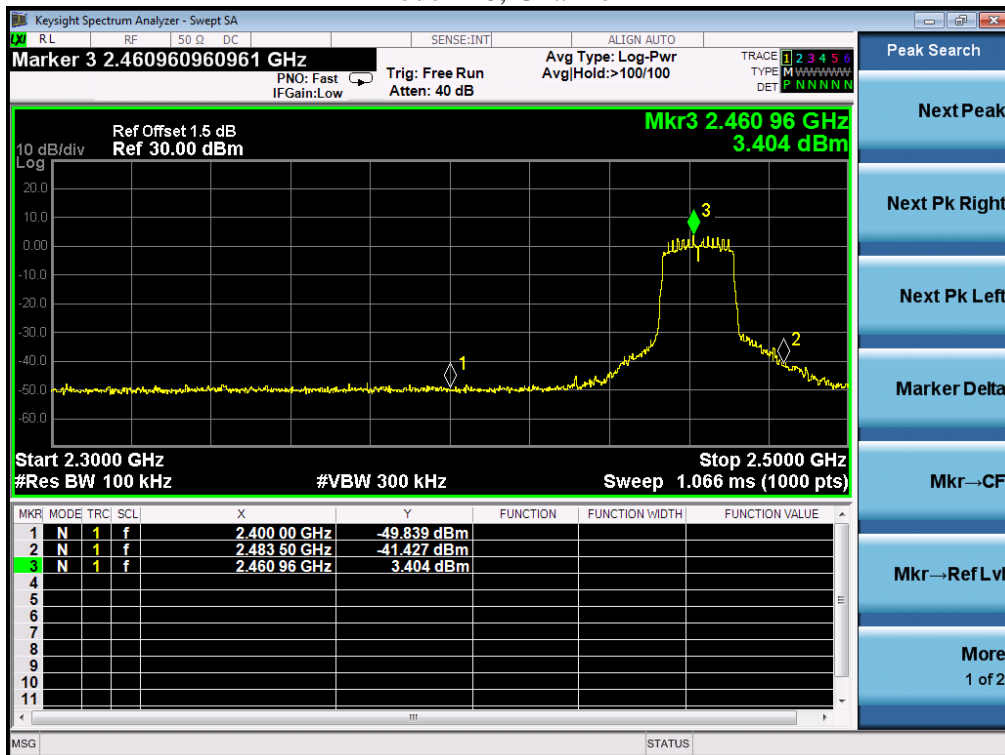





Mode n40, Channel H

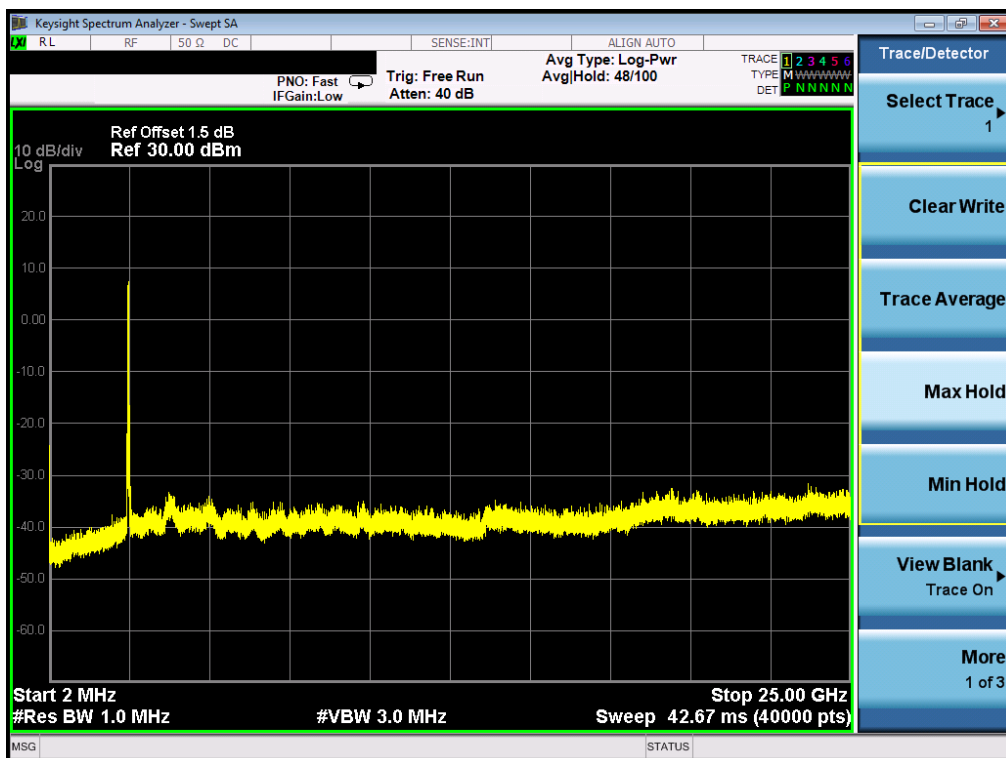
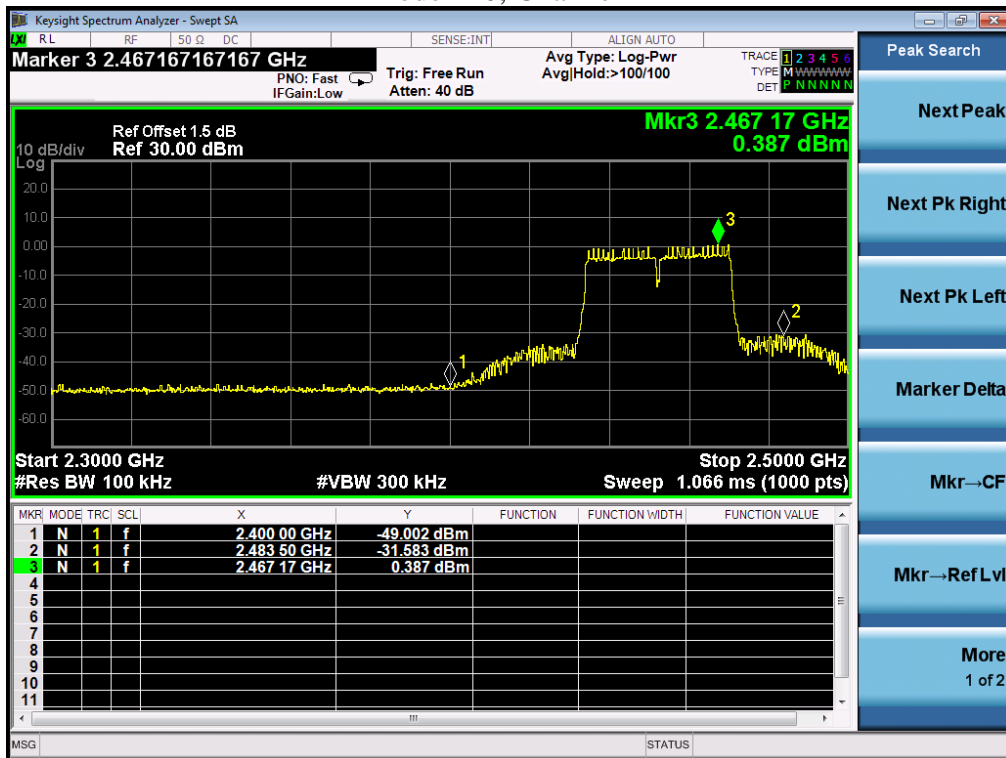

## 8. Power line conducted emission

**Test result: Pass**

### 8.1 Limit

Frequency of Emission (MHz)	Conducted Limit (dBuV)	
	QP	AV
0.15-0.5	66 to 56*	56 to 46 *
0.5-5	56	46
5-30	60	50

\* Decreases with the logarithm of the frequency.

### 8.2 Test configuration

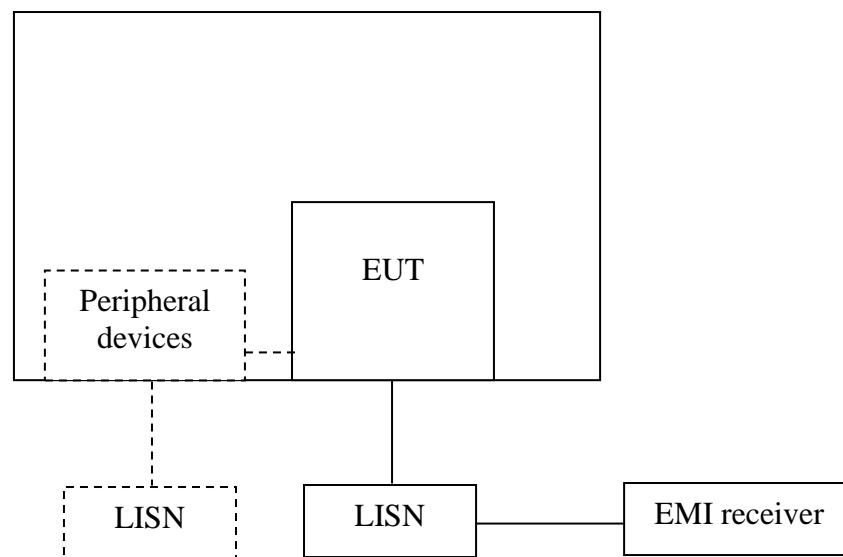

For table top equipment, wooden support is 0.8m height table

For floor standing equipment, wooden support is 0.1m height rack.

### **8.3 Test procedure and test set up**

The EUT are connected to the main power through a line impedance stabilization network (LISN). This provides a  $50\Omega/50\mu\text{H}$  coupling impedance for the measuring equipment. The peripheral devices are also connected to the main power through a LISN that provides a  $50\Omega/50\mu\text{H}$  coupling impedance with  $50\Omega$  termination.

Both sides (Line and Neutral) of AC line are checked for maximum conducted interference. In order to find the maximum emission, the relative positions of equipment and all of the interface cables must be changed according to ANSI C63.4 on conducted measurement. The bandwidth of the test receiver is set at 9 kHz.



**8.4 Test protocol**

Line L

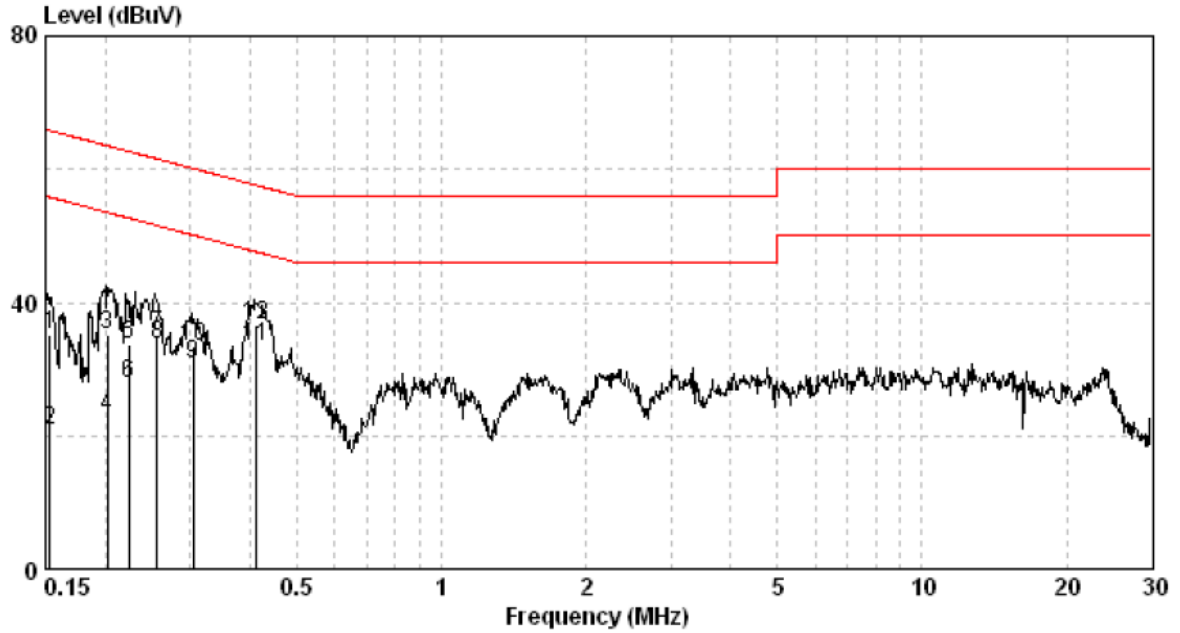

Frequency (MHz)	Corr. Factor (dB)	Level Qp (dBUV)	Limit Qp (dBUV)	Level Av (dBUV)	Limit Av (dBUV)	Margin (dB)	
						Qp	Av
0.153	9.74	35.05	65.82	20.79	55.82	-30.77	-35.03
0.202	9.74	35.27	63.54	22.75	53.54	-28.27	-30.79
0.223	9.74	33.82	62.70	27.92	52.70	-28.87	-24.77
0.256	9.75	35.23	61.56	33.59	51.56	-26.33	-17.97
0.305	9.76	33.43	60.10	30.64	50.10	-26.68	-19.47
0.413	9.77	36.59	57.59	33.45	47.59	-21.01	-14.15

Line N

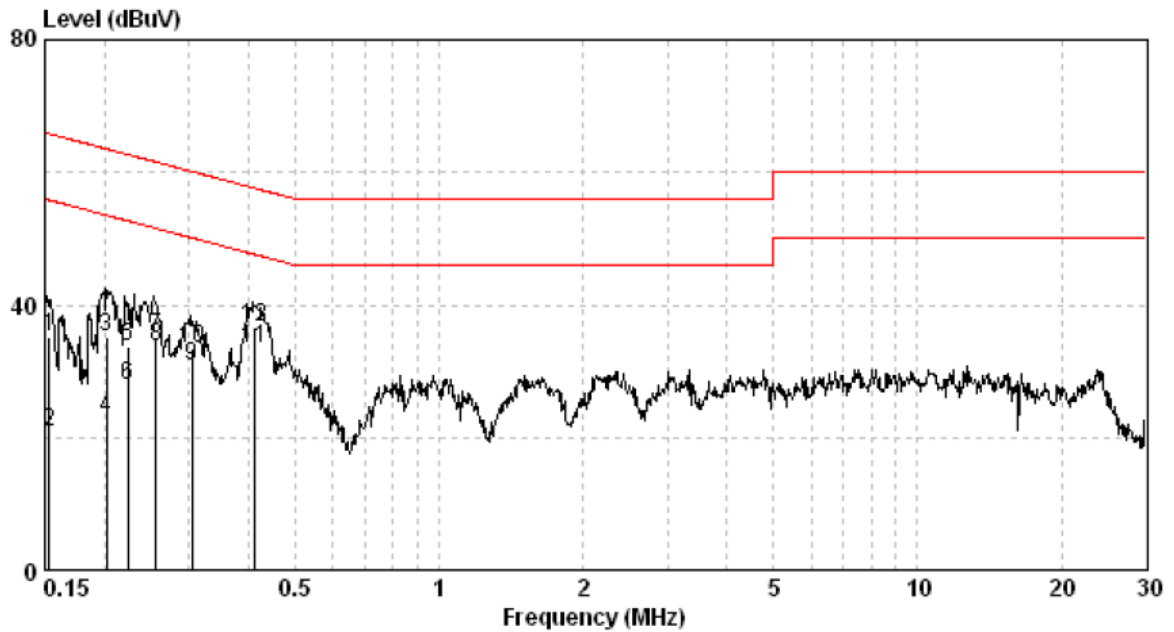

Frequency (MHz)	Corr. Factor (dB)	Level Qp (dBUV)	Limit Qp (dBUV)	Level Av (dBUV)	Limit Av (dBUV)	Margin (dB) Qp	Av
0.156	9.74	36.58	65.65	29.99	55.65	-29.07	-25.66
0.182	9.74	37.83	64.42	30.99	54.42	-26.59	-23.43
0.207	9.74	29.44	63.32	25.96	53.32	-33.87	-27.35
0.246	9.75	27.76	61.91	23.27	51.91	-34.15	-28.64
0.410	9.77	33.44	57.64	27.16	47.64	-24.20	-20.48
1.338	9.87	29.08	56.00	24.39	46.00	-26.92	-21.61

Remark:

1. Corr. Factor (dB) = LISN Factor (dB) + Cable Loss (dB)
2. Margin (dB) = Level (dBUV) – Limit (dBUV)

## 9. Occupied Bandwidth

Test Status: Pass

### 9.1 Test limit

None

### 9.2 Test Configuration

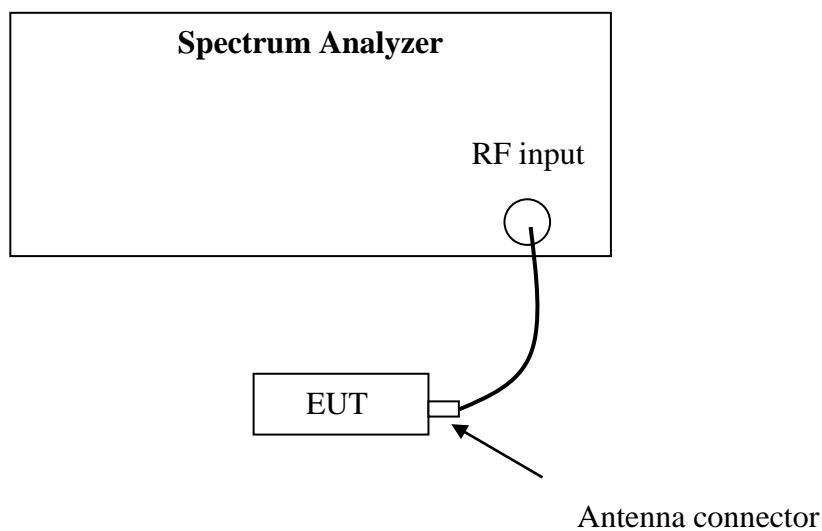

### 9.3 Test procedure and test setup

The trace data points are recovered and are directly summed in linear power level terms. The recovered amplitude data points, beginning at the lowest frequency, are placed in a running sum until 0.5% of the total is reached and that frequency recorded. The process is repeated for the highest frequency data points (starting at the highest frequency, at the right side of the span, and going down in frequency). This frequency is then recorded.

The difference between the two recorded frequencies is the 99% occupied bandwidth.

**9.4 Test protocol**

Temperature : 22°C  
Relative Humidity : 43 %

<b>Mode</b>	<b>CH</b>	<b>Bandwidth (MHz)</b>
b	L	12.15
	M	12.11
	H	12.02
g	L	16.69
	M	16.72
	H	16.71
n20	L	17.69
	M	17.71
	H	17.69
n40	L	36.37
	M	36.37
	H	36.37