

**ELECTROMAGNETIC EMISSIONS COMPLIANCE REPORT
INTENTIONAL RADIATOR CERTIFICATION TO
FCC PART 15 SUBPART C
REQUIREMENT T**

OF

Emitter

MODEL No.: DC6010

Trademark: N/A

FCC ID: VYY-DC6010

REPORT NO: ES171128001E

ISSUE DATE: December 08, 2017

Prepared for

NINGBO DOOYA MECHANIC & ELECTRONIC TECHNOLOGY CO., LTD.

No.168 Shengguang Road, Luotuo, Zhenhai, Ningbo, Zhejiang, China

Prepared by

EMTEK (SHENZHEN) CO., LTD

Bldg 69, Majialong Industry Zone, Nanshan District,
Shenzhen, Guangdong, China

TEL: 86-755-26954280

FAX: 86-755-26954282

VERIFICATION OF COMPLIANCE

Applicant	:	NINGBO DOOYA MECHANIC & ELECTRONIC TECHNOLOGY CO., LTD. No.168 Shengguang Road, Luotuo, Zhenhai, Ningbo, Zhejiang, China
Manufacturer	:	NINGBO DOOYA MECHANIC & ELECTRONIC TECHNOLOGY CO., LTD. No.168 Shengguang Road, Luotuo, Zhenhai, Ningbo, Zhejiang, China
Product Description	:	Emitter
Model Number	:	DC6010
Serial Number	:	N/A
File Number	:	ES171128001E
Date of Test	:	November 20, 2017 to December 06, 2017

We hereby certify that:

The above equipment was tested by EMTEK (SHENZHEN) CO., LTD. The test data, data evaluation, test procedures, and equipment configurations shown in this report were made in accordance with the procedures given in ANSI C63.10 (2013) and the energy emitted by the sample EUT tested as described in this report is in compliance with radiated emission limits of FCC Rules Part 15.231-2016.

The test results of this report relate only to the tested sample identified in this report.

Date of Test : November 20, 2017 to December 06, 2017

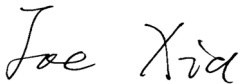
Prepared by : 
Joe Xia/Editor

Reviewer : 
Yaping Shen /Supervisor

Approve & Authorized Signer : 
Lisa Wang/Manager



TABLE OF CONTENTS

1.	GENERAL INFORMATION	4
1.1.	PRODUCT DESCRIPTION.....	4
1.2.	RELATED SUBMITTAL(S) / GRANT (S)	4
1.3.	TEST METHODOLOGY	4
1.4.	SPECIAL ACCESSORIES.....	4
1.5.	EQUIPMENT MODIFICATIONS.....	4
1.6.	MEASUREMENT UNCERTAINTY	5
1.7.	TEST FACILITY	5
2.	SYSTEM TEST CONFIGURATION.....	6
2.1.	EUT CONFIGURATION	6
2.2.	EUT EXERCISE	6
2.3.	TEST PROCEDURE	6
2.4.	DESCRIPTION OF TEST MODES.....	7
2.5.	SUMMARY OF TEST RESULTS	7
2.6.	DESCRIPTION OF SUPPORT UNITS	7
3.	RADIATED SPURIOUS EMISSION	8
3.1.	RADIO FREQUENCY TEST SETUP	8
3.2.	TEST CONFIGURATION	8
3.3.	TEST SET-UP (BLOCK DIAGRAM OF CONFIGURATION).....	8
3.4.	MEASUREMENT EQUIPMENT USED:.....	9
3.5.	RADIATED EMISSION LIMIT	10
3.6.	CALCULATION OF AVERAGE FACTOR.....	11
3.7.	MEASUREMENT RESULT.....	15
4.	TRANSMISSION REQUIREMENT	19
4.1.	REQUIREMENT	19
4.2.	TEST SET-UP.....	19
4.3.	MEASUREMENT EQUIPMENT USED:.....	19
4.4.	TEST PROCEDURE.....	19
4.5.	TEST DATA	20
5.	BANDWIDTH TEST	21
5.1.	MEASUREMENT PROCEDURE.....	21
5.2.	TEST SET-UP (BLOCK DIAGRAM OF CONFIGURATION).....	21
5.3.	MEASUREMENT EQUIPMENT USED:.....	21
5.4.	MEASUREMENT RESULTS:	21
6.	ANTENNA APPLICATION.....	23
6.1.	ANTENNA REQUIREMENT	23
6.2.	RESULT	23

1. GENERAL INFORMATION

1.1. Product Description

Emitter (referred to as the EUT in this report), it is designed by way of utilizing the FSK modulation achieves the system operating.

A major technical descriptions of EUT is described as following:

- A). Operation Frequency: 433.92MHz
- B). Modulation: FSK
- C)Channel Number:5
- D). Antenna Type: PCB antenna
- E). Antenna Gain:1dBi
- F).Power Supply: DC 3V

1.2. Related Submittal(s) / Grant (s)

This submittal(s) (test report) is intended for FCC ID: VYY-DC6010 filing to comply with Section 15.231 of the FCC Part 15, Subpart C Rules.

1.3. Test Methodology

The radiated testing was performed according to the procedures in ANSI C63.10 (2013). Radiated testing was performed at an antenna to EUT distance 3 meters.

1.4. Special Accessories

Not available for this EUT intended for grant.

1.5. Equipment Modifications

Not available for this EUT intended for grant.

1.6. Measurement Uncertainty

Measurement Type	Range	Confidence Level (%)	Calculated Uncertainty
Fundamental Fieldstrength	Not Applicable	95%	±2.94dB
Transmitter 20 dB Bandwidth	Not Applicable	95%	±0.92PPm
Radiated Spurious Emissions	30 MHz to 40 GHz	95%	±3.00dB
Conducted Emission	0.15MHz to 0.50MHz	95%	±2.0dB

1.7. Test Facility

Site Description

EMC Lab.

: Accredited by CNAS, 2016.10.24
 The certificate is valid until 2022.10.28
 The Laboratory has been assessed and proved to be in compliance with CNAS-CL01:2006 (identical to ISO/IEC 17025:2005)
 The Certificate Registration Number is L2291.

Accredited by TUV Rheinland Shenzhen 2016.5.19
 The Laboratory has been assessed according to the requirements ISO/IEC 17025.

Accredited by FCC, August 03, 2017
 Designation Number: CN1204
 Test Firm Registration Number: 882943

Accredited by Industry Canada, November 24, 2015
 The Certificate Registration Number is 4480A.

Name of Firm

: EMTEK (SHENZHEN) CO., LTD

Site Location

: Bldg 69, Majialong Industry Zone,
 Nanshan District, Shenzhen, Guangdong, China

2. SYSTEM TEST CONFIGURATION

2.1. EUT Configuration

The EUT configuration for testing is installed on RF field strength measurement to meet the Commissions requirement and operating in a manner which intends to maximize its emission characteristics in a continuous normal application.

2.2. EUT Exercise

The Transmitter was operated in the normal operating mode. The TX frequency was fixed which was for the purpose of the measurements.

2.3. Test Procedure

a. Below 30MHz:

The EUT is placed on a turntable 0.8 meters above the ground in the chamber, 3 meter away from the antenna (loop antenna). The Antenna should be positioned with its plane vertical at the specified distance from the EUT and rotated about its vertical axis for maximum response at each azimuth about the EUT. The center of the loop shall be 1 m above the ground. For certain applications, the loop antenna plane may also need to be positioned horizontally at the specified distance from the EUT.

b. Above 30MHz:

The EUT is placed on a turntable 0.8 meters above the ground in the chamber, 3 meter away from the antenna. The maximal emission value is acquired by adjusting the antenna height, polarisation and turntable azimuth. Normally, the height range of antenna is 1 m to 4 m, the azimuth range of turntable is 0° to 360°, and the receive antenna has two polarizations Vertical (V) and Horizontal (H).

c. Above 1GHz:

The EUT is placed on a turntable 1.5 meters above the ground in the chamber, 3 meter away from the antenna. The maximal emission value is acquired by adjusting the antenna height, polarisation and turntable azimuth. Normally, the height range of antenna is 1 m to 4 m, the azimuth range of turntable is 0° to 360°, and the receive antenna has two polarizations Vertical (V) and Horizontal (H).

Detector: For Peak:

RBW = 1 MHz for $f \geq 1$ GHz,

200 Hz for 9 kHz to 150 kHz

9 kHz for 150 kHz to 30 MHz

100 kHz for 30 MHz to 1GHz

VBW \geq RBW

Sweep = auto

Detector function = peak for $f \geq 1$ GHz, QP for $f < 1$ GHz

Trace = max hold

For AV value:

Average = Peak value + 20log (Duty cycle)

Follow the guidelines in ANSI C63.10-2013 with respect to maximizing the emission by rotating the EUT, measuring the emission while the EUT is situated in three orthogonal planes (if appropriate), adjusting the measurement antenna height and polarization, etc. A pre-amp and a high pass filter are required for this test, in order to provide the measuring system with sufficient sensitivity. Allow the trace to stabilize. The peak reading of the emission, after being corrected by the antenna factor, cable loss, pre-amp gain, etc., is the peak field strength, which must comply with the limit specified in Section 15.35(b). Submit this data.

Now set the VBW to 10 Hz, while maintaining all of the other instrument settings. This peak level,

once corrected, must comply with the limit specified in Section 15.209. If the dwell time per channel of the hopping signal is less than 100 ms, then the reading obtained with the 10 Hz VBW may be further adjusted by a “duty cycle correction factor”, derived from $20\log(\text{dwell time}/100 \text{ ms})$, in an effort to demonstrate compliance with the 15.209 limit. Submit this data.

2.4. Description of test modes

The EUT (Emitter) has been tested under normal operating condition. Let EUT transmit during test, and the result was reported.

2.5. Summary of Test Results

FCC Part15, Subpart C		
Standard Section FCC	Test Item	Result
15.231(a)(1)	Transmission Requirement	Pass
15.231(b)	Radiated Emission	Pass
15.231(c)	20dB Bandwidth	Pass
15.203	Antenna Requirement	Pass
15.207(a)	Conducted Emission	N/A

Note: (1)“N/A” denotes test is not applicable in this test report.

2.6. Description of Support Units

Equipment	Mfr/Brand	Model/Type No.	FCC ID / IC	Series No.	Note
/	/	/	/	/	/

3. RADIATED SPURIOUS EMISSION

3.1. RADIO FREQUENCY TEST SETUP

The component's antenna port(s) of the EUT are connected to the measurement instrument per an appropriate attenuator. The EUT is controlled by PC/software to emit the specified signals for the purpose of measurements.

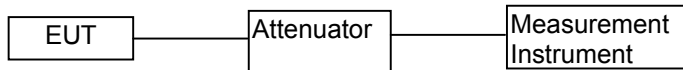

3.2. Test Configuration

Test according to clause 2.3

3.3. Test SET-UP (Block Diagram of Configuration)

a. BLOCK DIAGRAM CONFIGURATION OF TEST SYSTEM

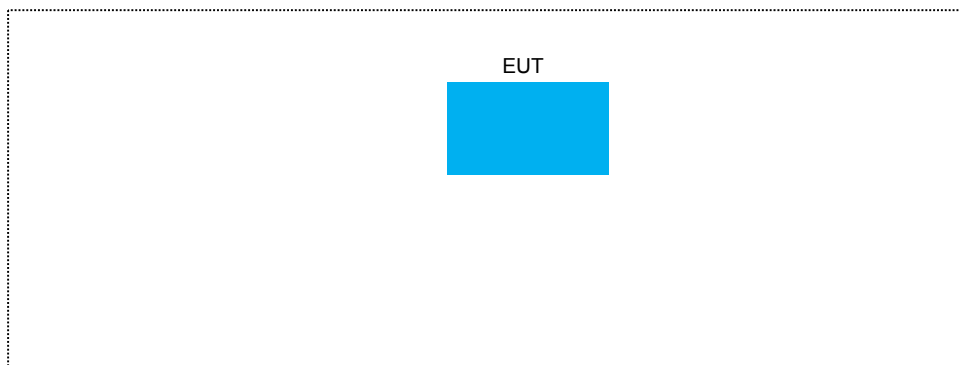

b. Radiated Emission Test Set-Up, Frequency Below 30MHz

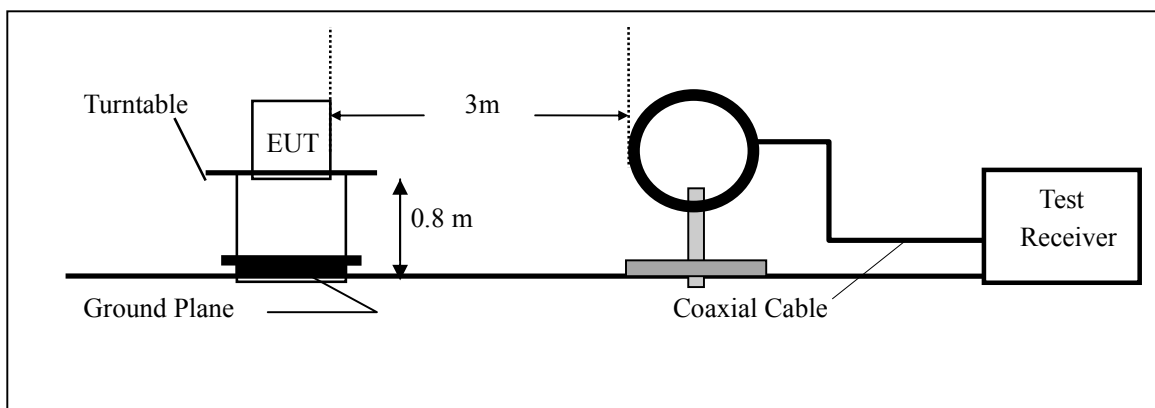

c. Radiated Emission Test Set-Up, Frequency Below 1000MHz

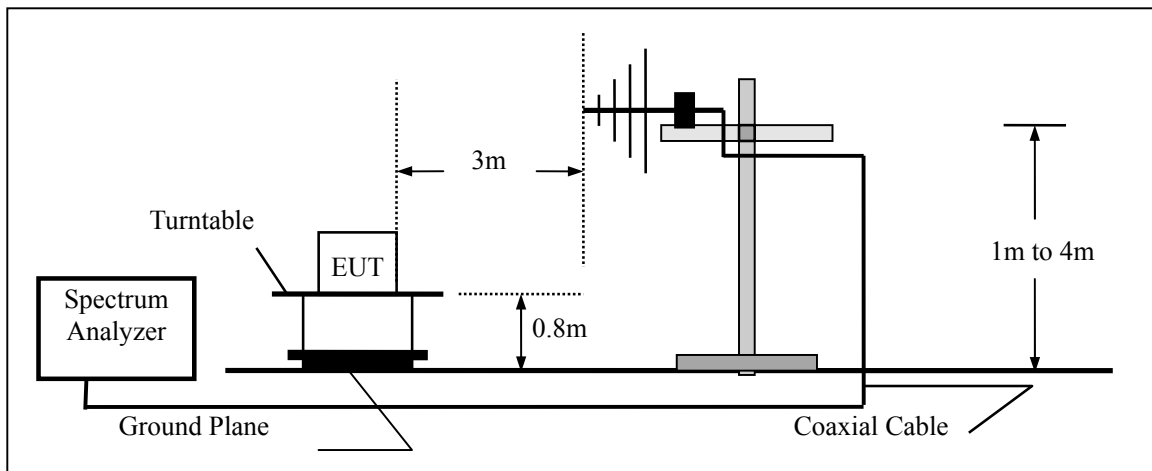

d. Radiated Emission Test Set-Up, Frequency above 1000MHz

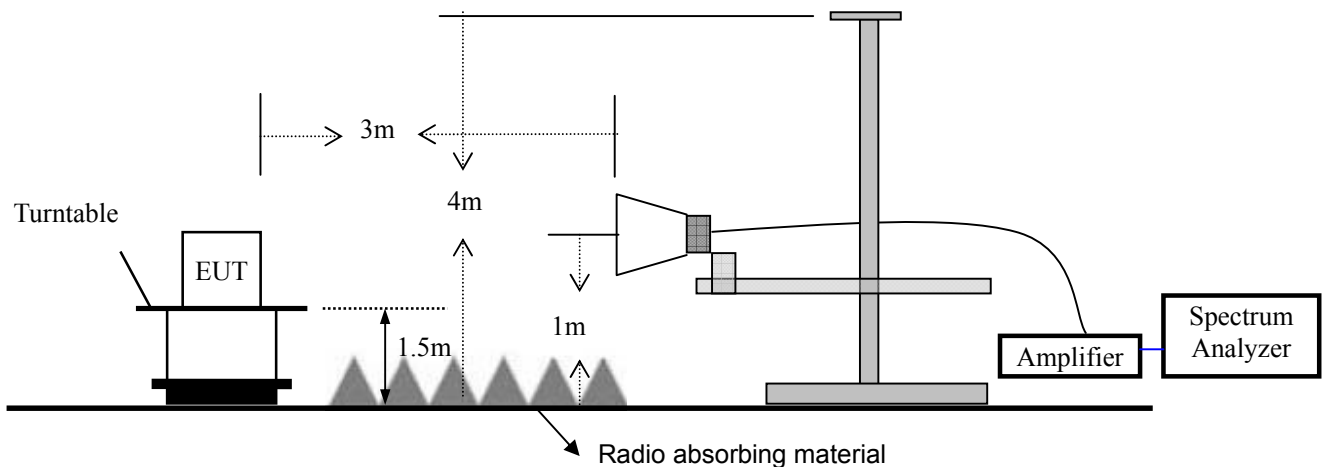

3.4. Measurement Equipment Used:

EQUIPMENT TYPE	MFR	MODEL NUMBER	SERIAL NUMBER	LAST CAL.
EMI Test Receiver	Rohde & Schwarz	ESU	1302.6005.26	May 20, 2017
Pre-Amplifier	HP	8447D	2944A07999	May 20, 2017
Bilog Antenna	Schwarzbeck	VULB9163	142	May 20, 2017
Loop Antenna	ARA	PLA-1030/B	1029	May 20, 2017
Horn Antenna	Schwarzbeck	BBHA 9170	BBHA9170399	May 20, 2017
Horn Antenna	Schwarzbeck	BBHA 9120	D143	May 20, 2017
Cable	Schwarzbeck	AK9513	ACRX1	May 20, 2017
Cable	Rosenberger	N/A	FP2RX2	May 20, 2017
Cable	Schwarzbeck	AK9513	CRPX1	May 20, 2017
Cable	Schwarzbeck	AK9513	CRRX2	May 20, 2017

Remark: Each piece of equipment is scheduled for calibration once a year.

3.5. Radiated Emission Limit

FCC 15.205 Restricted frequency band

MHz	MHz	MHz	GHz
0.090 - 0.110	16.42 - 16.423	399.9 - 410	4.5 - 5.15
¹ 0.495 - 0.505	16.69475 - 16.69525	608 - 614	5.35 - 5.46
2.1735 - 2.1905	16.80425 - 16.80475	960 - 1240	7.25 - 7.75
4.125 - 4.128	25.5 - 25.67	1300 - 1427	8.025 - 8.5
4.17725 - 4.17775	37.5 - 38.25	1435 - 1626.5	9.0 - 9.2
4.20725 - 4.20775	73 - 74.6	1645.5 - 1646.5	9.3 - 9.5
6.215 - 6.218	74.8 - 75.2	1660 - 1710	10.6 - 12.7
6.26775 - 6.26825	108 - 121.94	1718.8 - 1722.2	13.25 - 13.4
6.31175 - 6.31225	123 - 138	2200 - 2300	14.47 - 14.5
8.291 - 8.294	149.9 - 150.05	2310 - 2390	15.35 - 16.2
8.362 - 8.366	156.52475 - 156.52525	2483.5 - 2500	17.7 - 21.4
8.37625 - 8.38675	156.7 - 156.9	2690 - 2900	22.01 - 23.12
8.41425 - 8.41475	162.0125 - 167.17	3260 - 3267	23.6 - 24.0
12.29 - 12.293	167.72 - 173.2	3332 - 3339	31.2 - 31.8
12.51975 - 12.52025	240 - 285	3345.8 - 3358	36.43 - 36.5
12.57675 - 12.57725	322 - 335.4	3600 - 4400	(²)

FCC 15.209 Limited

Frequencies (MHz)	Field Strength (micorvolts/meter)	Measurement Distance (meters)
0.009~0.490	2400/F(KHz)	300
0.490~1.705	24000/F(KHz)	30
1.705~30.0	30	30
30~88	100	3
88~216	150	3
216~960	200	3
960~1000	500	3
Above 1GHz	74 dBuV/m (PEAK) 54 dBuV/m (AVERAGE)	

15.231 Limited

Fundamental Frequency (MHz)	Field Strength of Fundamental (microvolts/meter)	Field Strength of Spurious Emissions (microvolts/meter)
40.66 - 40.70	2,250	225
70 - 130	1,250	125
130 - 174	1,250 to 3,750 **	125 to 375 **
174 - 260	3,750	375
260 - 470	3,750 to 12,500 **	375 to 1,250 **
Above 470	12,500	1,250

** linear interpolations

[Where F is the frequency in MHz, the formulas for calculating the maximum permitted fundamental field strengths are as follows: for the band 130-174 MHz, uV/m at 3 meters = 56.81818(F) - 6136.3636; for the band 260-470 MHz, uV/m at 3 meters = 41.6667(F) - 7083.3333. The maximum permitted unwanted emission level is 20 dB below the maximum permitted fundamental level.]

The fundamental frequency of the EUT is 433.92MHz

The limit for average field strength dBuV/m for the fundamental emission= 80.82 dBuV/m

No fundamental is allowed in the restricted bands.

Spurious Emissions do not fall in the restricted bands must be less than 60.82 dBuV/m or limits shown in Section 15.209, whichever limit permits a higher field strength.

Spurious Emissions appear within the restricted bands shall not exceed the limits shown in Section 15.209.

FCC Part15 (15.231) , Subpart C		
Fundamental Frequency	Field Strength Of Fundamental	Field Strength of Spurious Emissions
433.92 MHz	AV:80.82 dBuV/m at 3m distance	AV:60.82 dBuV/m at 3m distance
	PK:100.82dBuV/m at 3m distance	PK:80.82 dBuV/m at 3m distance

3.6. Calculation of Average factor

The output field strengths of specification in accordance with the FCC rules specify measurements with an average detector. During the test, a spectrum analyzer incorporating a peak detector was used. Therefore, a reduction factor can be applied to the resultant peak signal level and compared to the limit for measurement instrumentation incorporating an average detector.

The duty cycle is measured in 100ms or the repetition cycle period, whichever is a shorter time frame, the duty cycle is measured by placing the spectrum analyzer to set zero span at 100kHz resolution bandwidth.

Averaging factor in dB=20log(duty cycle)

Where the duty factor is calculated from following formula:

$$20\log(\text{Duty cycle})= 20\log((0.08+4.64+0.4*20+0.72*20)/70)=-8.24\text{dB}$$

Therefore, the averaging factor is -8.24dB.

Pulse Width(PW)=0.08, 2/PW=2/0.08=25KHz, RBW=100KHz>25KHz, Therefore PDCF is not needed.

Please see the diagrams below:

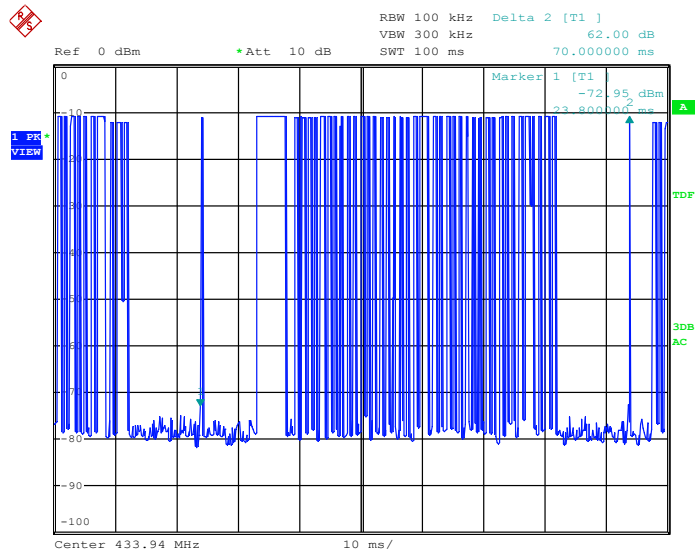

Date: 24.NOV.2017 16:40:51

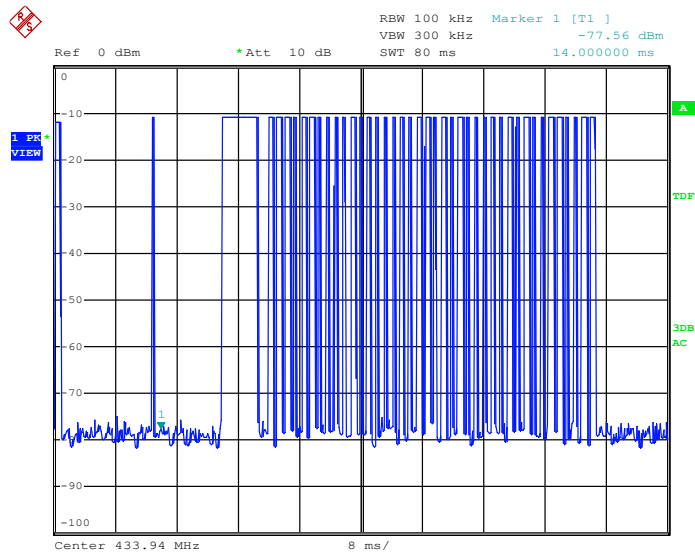

Date: 24.NOV.2017 16:39:23

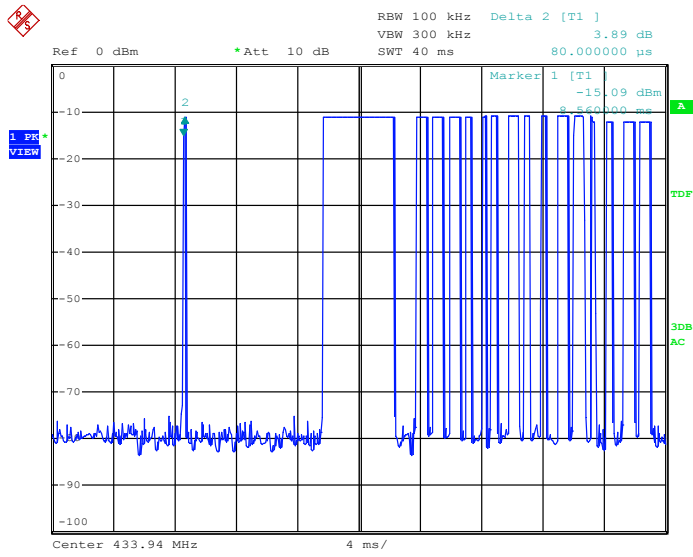

Date: 24.NOV.2017 16:41:29

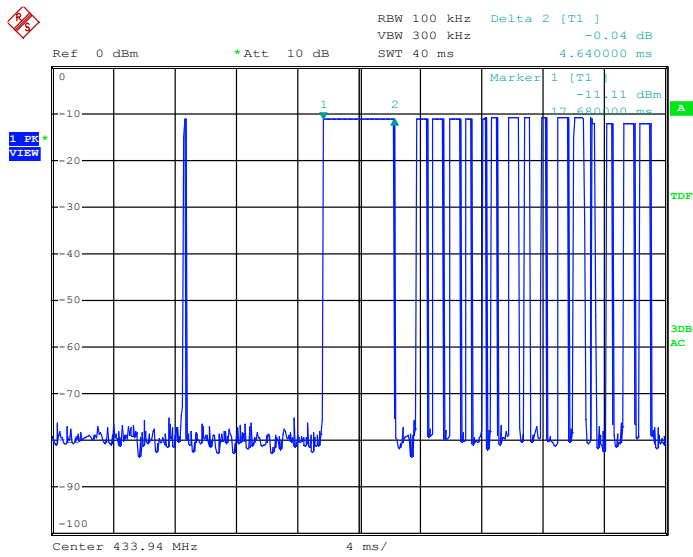

Date: 24.NOV.2017 16:41:44

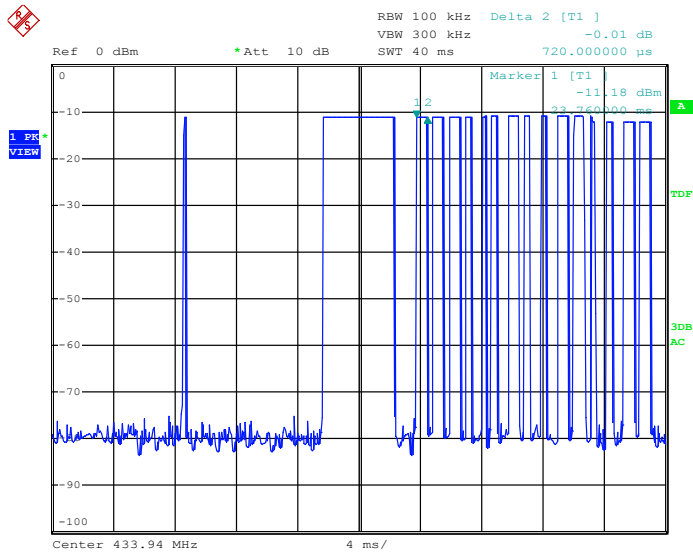

Date: 24.NOV.2017 16:42:11

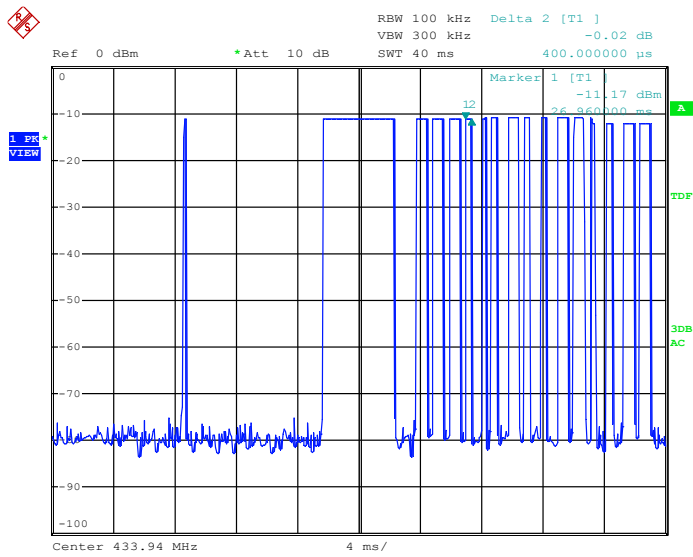

Date: 24.NOV.2017 16:42:23

Measurement Result

1. Fundamental emission:

Antenna polarization: Horizontal:

Freq. (MHz)	Reading Level(dBuV)	Correct Factor(dB)	Level (dBuV/m)	Limit Line (dBuV/m)	Margin (dB)	Remark
433.92	100.66	-16.78	83.88	100.82	-16.94	Peak
433.92	83.88	-8.24	75.64	80.82	-5.18	Average

Antenna polarization: Vertical

Freq. (MHz)	Reading Level(dBuV)	Correct Factor(dB)	Level (dBuV/m)	Limit Line (dBuV/m)	Margin (dB)	Remark
433.92	85.31	-16.78	68.53	100.82	-32.29	Peak
433.92	68.53	-8.24	60.29	80.82	-20.53	Average

Note: (1) Correct Factor= Antenna Factor +Cable Loss- Amplifier Gain
 (2) Emission Level= Reading Level+Probe Factor +Cable Loss
 (3) True Value = Emission Level + Duty Cycle Correction Factor
 (4) DF= Duty Cycle Correction Factor
 (5) average results= peak results + DF

2. Spurious Emission below 30MHz (9KHz to30MHz)

Freq. (MHz)	Ant. Pol. H/V	Emission Level(dBuV/m)		Limit 3m(dBuV/m)		Over(dB)	
		PK	AV	PK	AV	PK	AV
--	--	--	--	--	--	--	--

Note: the amplitude of spurious emission that is attenuated by more than 20dB below the permissible limit has no need to be reported.

Distance extrapolation factor = $40\log(\text{Specific distance/ test distance})$ (dB);

Limit line=Specific limits(dBuV) + distance extrapolation factor

3. Other emissions

The receiver was scanned from the lowest frequency generated within the EUT to 4.5 GHz.

The field strength is calculated by adding the Antenna Factor, Cable Factor & Peramplifier.

The basic equation with a sample calculation is as follows:

Final Test Level =Receiver Reading + Antenna Factor + Cable Factor –Peramplifier Factor.

The following test results were performed on the EUT.

Horizontal:

Freq. (MHz)	Reading Level(dBuV)	Correct Factor(dB)	Level (dBuV/m)	Limit Line (dBuV/m)	Margin (dB)	Remark
867.840	55.34	-7.49	47.85	80.82	-32.97	Peak
867.840	47.85	-8.24	39.61	60.82	-21.21	Average
1301.000	68.76	-21.88	46.88	74.00	-27.12	Peak
1301.000	46.88	-8.24	38.64	54.00	-15.36	Average
1735.000	67.93	-21.57	46.36	80.82	-34.46	Peak
1735.000	46.36	-8.24	38.12	60.82	-22.70	Average
2170.000	73.82	-21.18	52.64	80.82	-28.18	Peak
2170.000	52.64	-8.24	44.40	60.82	-16.42	Average
2605.000	68.93	-20.71	48.22	80.82	-32.60	Peak
2605.000	48.22	-8.24	39.98	60.82	-20.84	Average
3855.000	63.31	-18.08	45.23	74.00	-28.77	Peak
3855.000	45.23	-8.24	36.99	54.00	-17.01	Average

Vertical:

Freq. (MHz)	Reading Level(dBuV)	Correct Factor(dB)	Level (dBuV/m)	Limit Line (dBuV/m)	Margin (dB)	Remark
867.840	46.83	-7.49	39.34	80.82	-41.48	Peak
867.840	39.34	-8.24	31.10	60.82	-29.72	Average
1735.000	64.83	-21.56	43.27	74.00	-30.73	Peak
1735.000	43.27	-8.24	35.03	54.00	-18.97	Average
2170.000	70.36	-21.18	49.18	80.82	-31.64	Peak
2170.000	49.18	-8.24	40.94	60.82	-19.88	Average
3185.000	61.33	-19.85	41.48	80.82	-39.34	Peak
3185.000	41.48	-8.24	33.24	60.82	-27.58	Average
3905.000	61.86	-17.94	43.92	74.00	-30.08	Peak
3905.000	43.92	-8.24	35.68	54.00	-18.32	Average

Remark:

According to 15.35 (b) When average radiated emission measurements are specified in the regulations, including emission measurements below 1000 MHz, there is also a limit on the radio frequency emissions, as measured using instrumentation with a peak detector function, corresponding to 20 dB above the maximum permitted average limit for the frequency being investigated unless a different peak emission limit is otherwise specified in the rules, e.g., see Section 15.255.

Radiated spurious emission below 1GHz

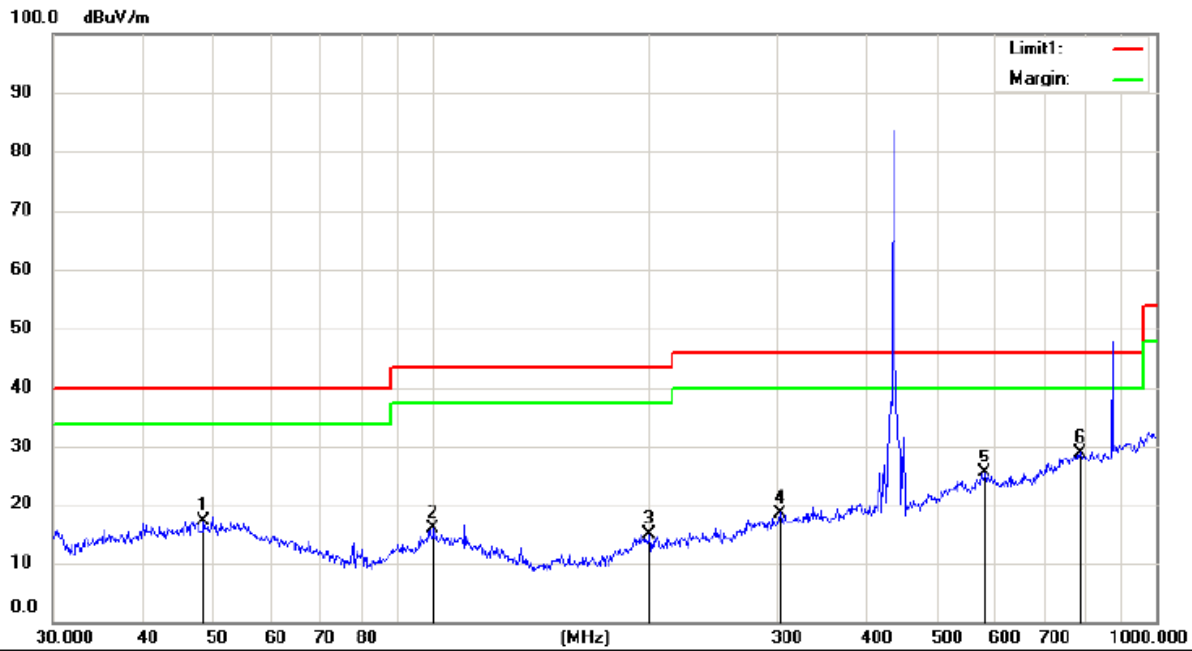

Site site #1 Polarization: *Horizontal* Temperature: 25 C
 Limit: FCC Part15 Class B 3M Radiation Power: DC 3V Humidity: 52 %
 Mode:ON
 Note:

No.	Mk.	Freq. MHz	Reading Level dBuV	Correct Factor dB	Measure- ment dBuV/m	Limit dBuV/m	Over dB	Antenna Height cm	Table Degree	Detector	Comment
1		48.5015	36.94	-19.74	17.20	40.00	-22.80			QP	
2		100.5806	36.84	-20.94	15.90	43.50	-27.60			QP	
3		199.9855	37.37	-22.57	14.80	43.50	-28.70			QP	
4		302.4811	37.41	-18.91	18.50	46.00	-27.50			QP	
5		580.7026	36.79	-11.49	25.30	46.00	-20.70			QP	
6	*	785.0934	37.09	-8.09	29.00	46.00	-17.00			QP	

*:Maximum data x:Over limit !:over margin

Operator:KK

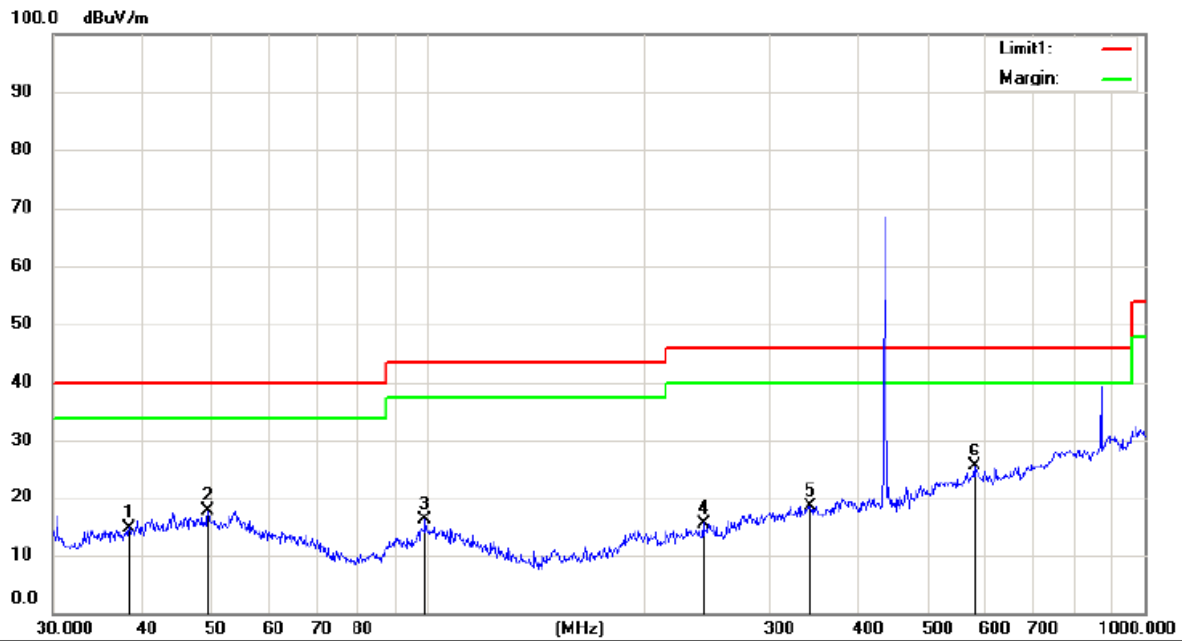

Site site #1 Polarization: *Vertical* Temperature: 25 C
 Limit: FCC Part15 Class B 3M Radiation Power: DC 3V Humidity: 52 %
 Mode:ON
 Note:

No.	Mk.	Freq.	Reading Level	Correct Factor	Measurement	Limit	Over	Antenna Height	Table Degree	
		MHz	dBuV	dB	dBuV/m	dBuV/m	dB	cm	degree	Comment
1		38.3462	35.90	-21.20	14.70	40.00	-25.30			QP
2		49.3594	37.08	-19.48	17.60	40.00	-22.40			QP
3		99.1797	37.37	-21.27	16.10	43.50	-27.40			QP
4		242.5252	36.89	-21.39	15.50	46.00	-30.50			QP
5		341.9786	36.00	-17.70	18.30	46.00	-27.70			QP
6	*	578.6700	36.85	-11.55	25.30	46.00	-20.70			QP

*:Maximum data x:Over limit !:over margin

Operator:KK

4. TRANSMISSION REQUIREMENT

4.1. Requirement

1. The provisions of this Section are restricted to periodic operation within the band 40.66 40.70 MHz and above 70 MHz. Except as shown in paragraph (e) of this Section, the intentional radiator is restricted to the transmission of a control signal such as those used with alarm systems, door openers, remote switches, etc. Radio control of toys is not permitted. Continuous transmissions, such as voice or video, and data transmissions are not permitted. The prohibition against data transmissions does not preclude the use of recognition codes. Those codes are used to identify the sensor that is activated or to identify the particular component as being part of the system.
2. A manually operated transmitter shall employ a switch that will automatically deactivate the transmitter within not more than 5 seconds of being released.

4.2. Test SET-UP

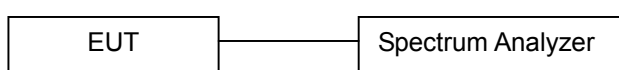

4.3. Measurement Equipment Used:

Name of Equipment	Manufacturer	Model	Serial Number	Last Cal.	CAL DUE.
Spectrum Analyzer	Rohde & Schwarz	ESU	1302.6005.26	May 20, 2017	May 19, 2018

4.4. Test Procedure

The following table is the setting of spectrum analyzer.

Spectrum analyzer	Setting
Attenuation	Auto
Span Frequency	0Hz
RB	100KHz
VB	300KHz
Detector	Peak
Trace	Max hold
Sweep Time	5S

- a. The transmitter output (antenna port) was connected to the spectrum analyzer.
- b. Set RBW of spectrum analyzer to 100KHz and VBW to 300KHz, Set Detector to Peak, Trace to Max Hold.
- c. Set the span to 0Hz and the sweep time to 5s and record the value.

4.5. Test Data

Environmental Conditions

Temperature:	21°C
Relative Humidity:	52%
ATM Pressure:	1032mbar

Test Mode: Transmitting

Frequency (MHz)	Transmitting time (ms)	Limit (S)	Result
433.92	690	5	PASS

Refer to the attached plot

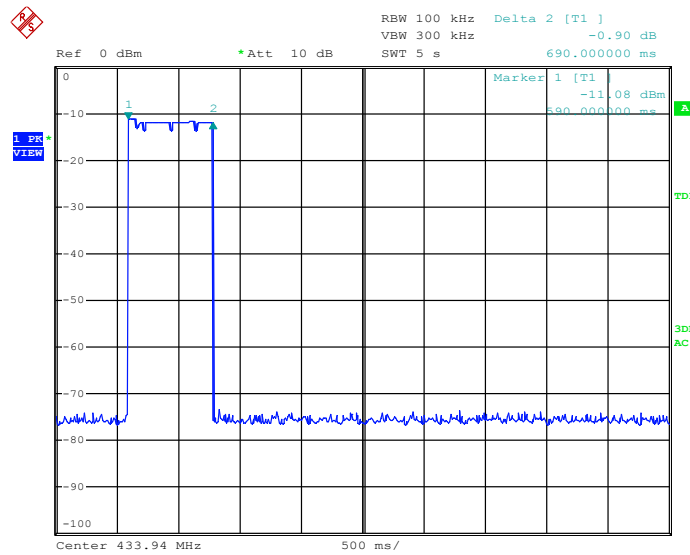

Date: 24.NOV.2017 16:44:15

5. BANDWIDTH TEST

5.1. Measurement Procedure

The useful radiated emission from the EUT was detected by the spectrum analyzer with peak detector. Record the 20 dB bandwidth of the carrier.

5.2. Test SET-UP (Block Diagram of Configuration)

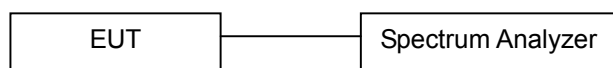

15.231 (c) The bandwidth of the emission shall be no wider than 0.25% of the center frequency for devices operating above 70 MHz and below 900 MHz. For devices operating above 900 MHz, the emission shall be no wider than 0.5% of the center frequency. Bandwidth is determined at the points 20 dB down from the modulated carrier.

5.3. Measurement Equipment Used:

Name of Equipment	Manufacturer	Model	Serial Number	Last Cal.	CAL DUE.
Spectrum Analyzer	Rohde & Schwarz	ESU	1302.6005.26	May 20, 2017	May 20, 2018

5.4. Measurement Results:

Spectrum Detector:	PK	Test Date:	November 24, 2017
Test By:	KK	Temperature:	21°C
Test Result:	PASS	Humidity:	52 %
Modulation:	FSK		

Channel number	Channel frequency (MHz)	20dB Down BW(kHz)	Limit
CH1	433.92	482	≤1.0848MHz

Remark:

The bandwidth limit is $433.92\text{MHz} \times 0.0025 = 1084.8 \text{ kHz}$.

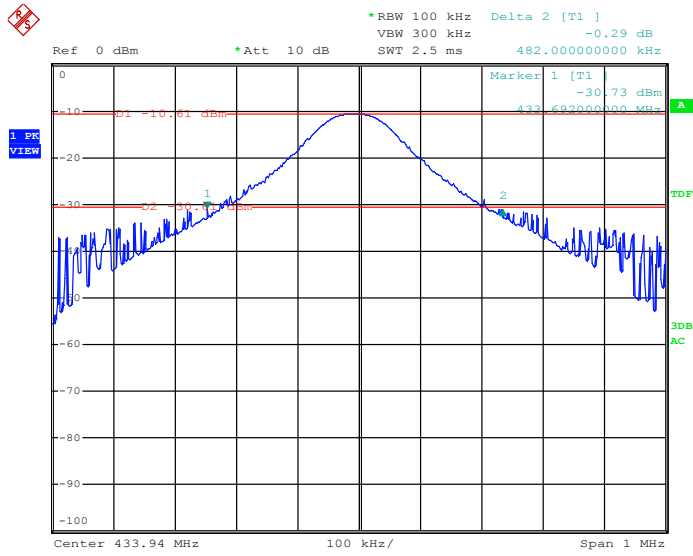

Date: 24.NOV.2017 16:43:18

6. ANTENNA APPLICATION

6.1. Antenna Requirement

For intentional device, according to FCC 47 CFR Section 15.203, an intentional radiator shall be designed to ensure that no antenna other than that furnished by the responsible party shall be used with the device.

6.2. Result

The EUT's antenna is PCB antenna, using a permanently attached antenna which is not replaceable. The antenna's gain is 1dBi and meets the requirement.

---END OF REPORT---