

**ELECTROMAGNETIC EMISSIONS COMPLIANCE REPORT
INTENTIONAL RADIATOR CERTIFICATION TO
FCC PART 15 SUBPART C
REQUIREMENT T**

OF

Emitter

MODEL No.: DC1530,DC1520,DC1520A,DC1530A

Trademark: N/A

FCC ID: VYY-15201530

REPORT NO: ES150709107E

ISSUE DATE: August 11, 2015

Prepared for

NINGBO DOOYA MECHANIC & ELECTRONIC TECHNOLOGY CO., LTD.

Loutou Industrial Area, Zhenhai, Ningbo, Zhejiang, China

Prepared by

SHENZHEN EMTEK CO., LTD

Bldg 69, Majialong Industry Zone, Nanshan District,
Shenzhen, Guangdong, China

TEL: 86-755-26954280

FAX: 86-755-26954282

VERIFICATION OF COMPLIANCE

Applicant:	NINGBO DOOYA MECHANIC & ELECTRONIC TECHNOLOGY CO., LTD. Loutou Industrial Area, Zhenhai, Ningbo, Zhejiang, China
Manufacturer:	NINGBO DOOYA MECHANIC & ELECTRONIC TECHNOLOGY CO., LTD. Loutou Industrial Area, Zhenhai, Ningbo, Zhejiang, China
Product Description:	Emitter
Model Number:	DC1530,DC1520,DC1520A,DC1530A(Note: The models of DC1530,DC1520,DC1520A,DC1530A are identical and have same structures and PCB layout. We prepared model DC1530 for test)
Serial Number:	N/A
File Number:	ES150709108E
Date of Test:	June 22, 2015 to July25, 2015

We hereby certify that:

The above equipment was tested by SHENZHEN EMTEK CO., LTD. The test data, data evaluation, test procedures, and equipment configurations shown in this report were made in accordance with the procedures given in ANSI C63.10 (2013) and the energy emitted by the sample EUT tested as described in this report is in compliance with radiated emission limits of FCC Rules Part 15.231.

The test results of this report relate only to the tested sample identified in this report.

Date of Test : June 22, 2015 to July 25, 2015

Prepared by : 
Jack Li/Editor

Reviewer : 
Joe Xia/Supervisor

Approve & Authorized Signer : 
Lisa Wang/Manager

Table of Contents

1.	GENERAL INFORMATION.....	4
1.1.	PRODUCT DESCRIPTION	4
1.2.	RELATED SUBMITTAL(S) / GRANT (S).....	4
1.3.	TEST METHODOLOGY.....	4
1.4.	SPECIAL ACCESSORIES.....	4
1.5.	EQUIPMENT MODIFICATIONS	4
1.6.	MEASUREMENT UNCERTAINTY	5
1.7.	TEST FACILITY	5
2.	SYSTEM TEST CONFIGURATION.....	6
2.1.	EUT CONFIGURATION.....	6
2.2.	EUT EXERCISE.....	6
2.3.	TEST PROCEDURE.....	6
2.4.	DESCRIPTION OF TEST MODES	6
2.5.	SUMMARY OF TEST RESULTS	6
2.6.	DESCRIPTION OF SUPPORT UNITS	6
3.	RADIATED EMISSION TEST.....	7
3.1.	MEASUREMENT PROCEDURE.....	7
3.2.	TEST SET-UP (BLOCK DIAGRAM OF CONFIGURATION).....	7
3.3.	MEASUREMENT EQUIPMENT USED:	8
3.4.	RADIATED EMISSION LIMIT.....	8
3.5.	CALCULATION OF AVERAGE FACTOR	10
3.6.	MEASUREMENT RESULT	13
4.	TRANSMISSION REQUIREMENT	17
4.1.	REQUIREMENT	17
4.2.	TEST SET-UP	17
4.3.	MEASUREMENT EQUIPMENT USED:	17
4.4.	TEST PROCEDURE.....	17
4.5.	TEST DATA.....	17
5.	BANDWIDTH TEST.....	19
5.1.	MEASUREMENT PROCEDURE.....	19
5.2.	TEST SET-UP (BLOCK DIAGRAM OF CONFIGURATION).....	19
5.3.	MEASUREMENT EQUIPMENT USED:	19
5.4.	MEASUREMENT RESULTS:	19
6.	ANTENNA APPLICATION.....	21
6.1.	ANTENNA REQUIREMENT	21
6.2.	RESULT	21

1. GENERAL INFORMATION

1.1. Product Description

Emitter (referred to as the EUT in this report), it is designed by way of utilizing the ASK modulation achieves the system operating.

A major technical descriptions of EUT is described as following:

- A). Operation Frequency: 433.964MHz
- B). Modulation: OOK
- C). Antenna Type: PCB antenna
- D). Antenna Gain: <3dBi
- E).Power Supply: DC 3V from battery, 2*1.5V AAA battery

1.2. Related Submittal(s) / Grant (s)

This submittal(s) (test report) is intended for FCC ID: VYY-15201530 filing to comply with Section 15.231 of the FCC Part 15, Subpart C Rules.

1.3. Test Methodology

The radiated testing was performed according to the procedures in ANSI C63.10 (2013). Radiated testing was performed at an antenna to EUT distance 3 meters.

1.4. Special Accessories

Not available for this EUT intended for grant.

1.5. Equipment Modifications

Not available for this EUT intended for grant.

1.6. Measurement Uncertainty

Measurement Type	Range	Confidence Level (%)	Calculated Uncertainty
Fundamental Fieldstrength	Not Applicable	95%	±2.94dB
Transmitter 20 dB Bandwidth	Not Applicable	95%	±0.92PPm
Radiated Spurious Emissions	30 MHz to 40 GHz	95%	±3.00dB
Conducted Emission	0.15MHz to 0.50MHz	95%	±2.0dB

1.7. Test Facility

Site Description

EMC Lab.

: Accredited by CNAS, 2013.10.29
 The certificate is valid until 2016.10.28
 The Laboratory has been assessed and proved to be in compliance with CNAS/CL01:2006(identical to ISO/IEC17025: 2005)
 The Certificate Registration Number is L2291

Accredited by TUV Rheinland Shenzhen 2010.5.25
 The Laboratory has been assessed according to the requirements ISO/IEC 17025

Accredited by FCC, April 17, 2014
 The Certificate Registration Number is 406365.

Accredited by Industry Canada, March 5, 2010
 The Certificate Registration Number is 4480A-2.

Name of Firm

: SHENZHEN EMTEK CO., LTD

Site Location

: Bldg 69, Majialong Industry Zone,
 Nanshan District, Shenzhen, Guangdong, China

2. SYSTEM TEST CONFIGURATION

2.1. EUT Configuration

The EUT configuration for testing is installed on RF field strength measurement to meet the Commissions requirement and operating in a manner which intends to maximize its emission characteristics in a continuous normal application.

2.2. EUT Exercise

The Transmitter was operated in the normal operating mode. The TX frequency was fixed which was for the purpose of the measurements.

2.3. Test Procedure

2.3.1 Radiated Emissions

The EUT is placed on a turn table which is 0.8 m above ground plane. The turn table shall rotate 360 degrees to determine the position of maximum emission level. EUT is set 3m away from the receiving antenna which varied from 1m to 4m to find out the highest emission. And also, each emission was to be maximized by changing the polarization of receiving antenna both horizontal and vertical. In order to find out the max. Emission, the relative positions of this hand-held transmitter (EUT) was rotated through three orthogonal axes according to the requirements in Section 6.3 to 6.6 of ANSI C63.10-2013.

2.4. Description of test modes

The EUT (Emitter) has been tested under normal operating condition. Let EUT transmit during test, and the result was reported.

2.5. Summary of Test Results

FCC Part15, Subpart C		
Standard Section	Test Item	Result
FCC		
15.231(a)(1)	Transmission Requirement	Pass
15.231(b)	Radiated Emission	Pass
15.231(c)	20dB Bandwidth	Pass
15.207(a)	Conducted Emission	N/A

Note: (1) "N/A" denotes test is not applicable in this test report.

2.6. Description of Support Units

Equipment	Mfr/Brand	Model/Type No.	FCC ID / IC	Series No.	Note
Emitter	N/A	DC1530	VYY-15201530	N/A	EUT

3. RADIATED EMISSION TEST

3.1. Measurement Procedure

- The EUT was placed on the top of a rotating table 0.8 meters above the ground at a 3 meter Semi-anechoic chamber. The table was rotated 360 degrees to determine the position of the highest radiation.(below 1GHz)
- The EUT was placed on the top of a rotating table 1.5 meters above the ground at a 3 meter Semi-anechoic chamber. The table was rotated 360 degrees to determine the position of the highest radiation.(above 1GHz)
- the height of the test Antenna shall vary between 1 m to 4 m. Both horizontal and vertical polarizations of the antenna are set to make the measurement.
- The initial step in collecting conducted emission data is a spectrum analyzer peak detector Mode pre-scanning the measurement frequency range. Significant peaks are then marked and then AV detector mode re-measured.
- If the Peak Mode measured value compliance with and lower than Quasi Peak Mode Limit, the EUT shall be deemed to meet QP Limits and then no additional QP Mode measurement performed.

3.2. Test SET-UP (Block Diagram of Configuration)

(A) Radiated Emission Test Set-Up, Frequency Below 30MHz

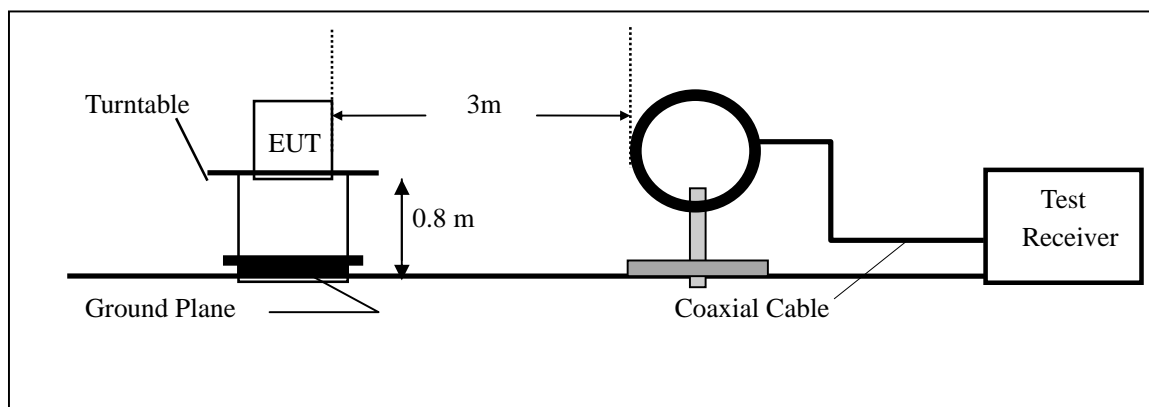

(B) Radiated Emission Test Set-Up, Frequency Below 1000MHz

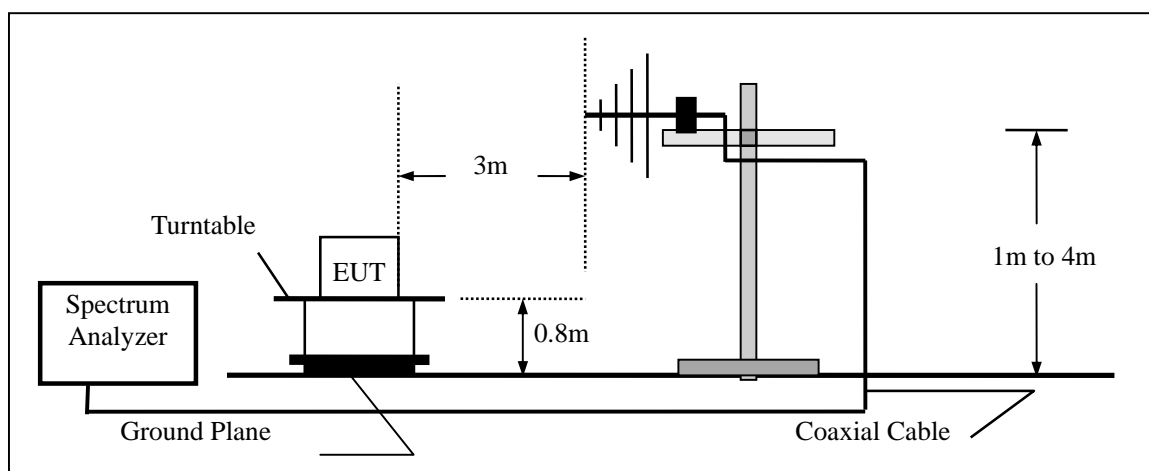

(C) Radiated Emission Test Set-Up, Frequency above 1000MHz

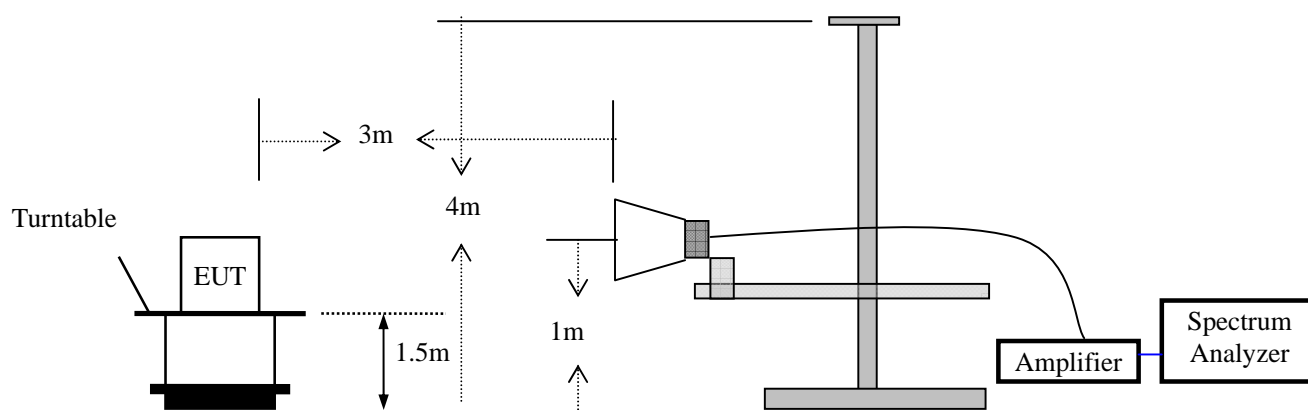

All the x/y/z orientation has been investigated, and only worst case is presented in this report.

3.3. Measurement Equipment Used:

EQUIPMENT TYPE	MFR	MODEL NUMBER	SERIAL NUMBER	LAST CAL.	CAL DUE.
Spectrum Analyzer	Rohde & Schwarz	FSP7	839511/010	05/16/2015	05/15/2016
Spectrum Analyzer	HP	E4407B	839840481	05/16/2015	05/15/2016
EMI Test Receiver	Rohde & Schwarz	ESCS30	828985/018	05/16/2015	05/15/2016
Pre-Amplifier	HP	8447D	2944A07999	05/16/2015	05/15/2016
Bilog Antenna	Schwarzbeck	VULB9163	142	05/16/2015	05/15/2016
Loop Antenna	ARA	PLA-1030/B	1029	05/16/2015	05/15/2016
Horn Antenna	Schwarzbeck	BBHA 9170	BBHA9170399	05/16/2015	05/15/2016
Horn Antenna	Schwarzbeck	BBHA 9120	D143	05/16/2015	05/15/2016

3.4. Radiated Emission Limit

FCC 15.205 Restricted frequency band

MHz	MHz	MHz	GHz
0.090 - 0.110	16.42 - 16.423	399.9 - 410	4.5 - 5.15
¹ 0.495 - 0.505	16.69475 - 16.69525	608 - 614	5.35 - 5.46
2.1735 - 2.1905	16.80425 - 16.80475	960 - 1240	7.25 - 7.75
4.125 - 4.128	25.5 - 25.67	1300 - 1427	8.025 - 8.5
4.17725 - 4.17775	37.5 - 38.25	1435 - 1626.5	9.0 - 9.2
4.20725 - 4.20775	73 - 74.6	1645.5 - 1646.5	9.3 - 9.5
6.215 - 6.218	74.8 - 75.2	1660 - 1710	10.6 - 12.7
6.26775 - 6.26825	108 - 121.94	1718.8 - 1722.2	13.25 - 13.4
6.31175 - 6.31225	123 - 138	2200 - 2300	14.47 - 14.5
8.291 - 8.294	149.9 - 150.05	2310 - 2390	15.35 - 16.2
8.362 - 8.366	156.52475 - 156.52525	2483.5 - 2500	17.7 - 21.4
8.37625 - 8.38675	156.7 - 156.9	2690 - 2900	22.01 - 23.12
8.41425 - 8.41475	162.0125 - 167.17	3260 - 3267	23.6 - 24.0
12.29 - 12.293	167.72 - 173.2	3332 - 3339	31.2 - 31.8
12.51975 - 12.52025	240 - 285	3345.8 - 3358	36.43 - 36.5
12.57675 - 12.57725	322 - 335.4	3600 - 4400	(²)

FCC 15.209 Limited

Frequencies (MHz)	Field Strength (micovolts/meter)	Measurement Distance (meters)
0.009~0.490	2400/F(KHz)	300
0.490~1.705	24000/F(KHz)	30
1.705~30.0	30	30
30~88	100	3
88~216	150	3
216~960	200	3
960~1000	500	3
Above 1GHz	74 dBuV/m (PEAK) 54 dBuV/m (AVERAGE)	

15.231 Limited

Fundamental Frequency (MHz)	Field Strength of Fundamental (microvolts/meter)	Field Strength of Spurious Emissions (microvolts/meter)
40.66 - 40.70	2,250	225
70 - 130	1,250	125
130 - 174	1,250 to 3,750 **	125 to 375 **
174 - 260	3,750	375
260 - 470	3,750 to 12,500 **	375 to 1,250 **
Above 470	12,500	1,250

** linear interpolations

The field intensity in micro-volts per meter can then be determined by the following equation: $FI(V/m) = 10FI(dBV/m) / 20$ The FCC specified emission limits were calculated according the EUT operating frequency and obtained by following linear interpolation equations:

(a) For fundamental frequency:

$$f_{EUT} : \text{EUT Operating Frequency Emission Limit (uV/m)}$$

$$= [f_{EUT}(\text{MHz}) - 260(\text{MHz})] \times \frac{12500(\text{uV/m}) - 3750(\text{uV/m})}{470(\text{MHz}) - 260(\text{MHz})} + 3750(\text{uV/m})$$

(b) For spurious frequencies:

$$f_{EUT} : \text{EUT Operating Frequency Emission Limit (V/m)}$$

$$= [f_{EUT}(\text{MHz}) - 260(\text{MHz})] \times \frac{1250(\text{uV/m}) - 375(\text{uV/m})}{470(\text{MHz}) - 260(\text{MHz})} + 375(\text{uV/m})$$

Other emissions radiated outside of the specified frequency bands, except for harmonics, shall be attenuated by at least 20 dB below the level of the fundamental or comply with the radiated emissions limits specified in section 15.209(a) limit in the table below has to be followed.

Note:

- (1) The tighter limit applies at the band edges.
- (2) Emission level (dBuV/m)=20log Emission level (uV/m).

FCC Part15 (15.231) , Subpart C		
Fundamental Frequency	Field Strength Of Fundamental	Field Strength of Spurious Emissions
433.964MHz	AV:80.83 dBuV/m at 3m distance	AV:60.83 dBuV/m at 3m distance
	PK:100.83dBuV/m at 3m distance	PK:80.83 dBuV/m at 3m distance

3.5. Calculation of Average factor

The output field strengths of specification in accordance with the FCC rules specify measurements with an average detector. During the test, a spectrum analyzer incorporating a peak detector was used. Therefore, a reduction factor can be applied to the resultant peak signal level and compared to the limit for measurement instrumentation incorporating an average detector.

The duty cycle is measured in 58.5ms or the repetition cycle period, whichever is a shorter time frame, the duty cycle is measured by placing the spectrum analyzer to set zero span at 100kHz resolution bandwidth.

Averaging factor in dB=20log(duty cycle)

Where the duty factor is calculated from following formula:

$$20\log(\text{Duty cycle})=20\log(24.96\text{ms}/58.5\text{ms})=-7.40 \text{ dB}$$

(Note: 24.96ms=4.8*1 ms +0.36*24 ms +0.72*16ms*)

Therefore, the averaging factor is -7.40dB.

Please see the diagrams below:

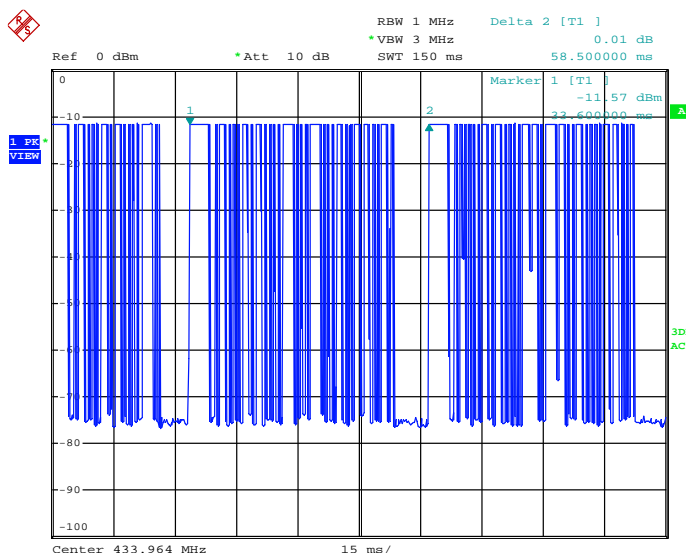

Date: 29.JUN.2015 19:10:49

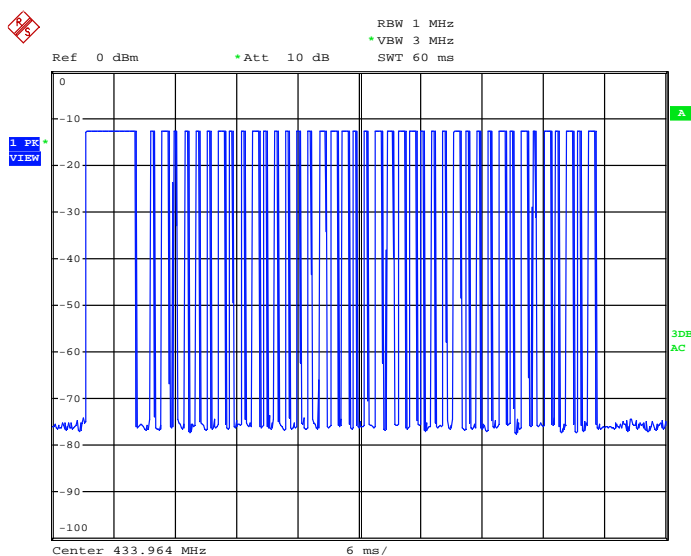

Date: 29.JUN.2015 19:12:49

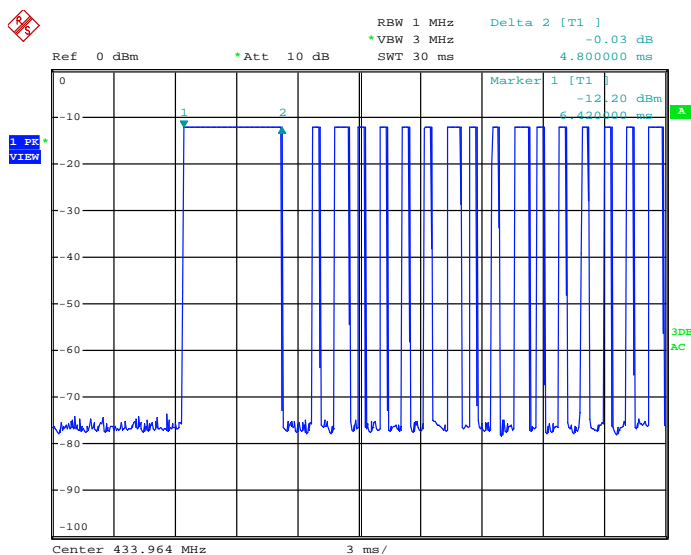

Date: 29.JUN.2015 19:13:20

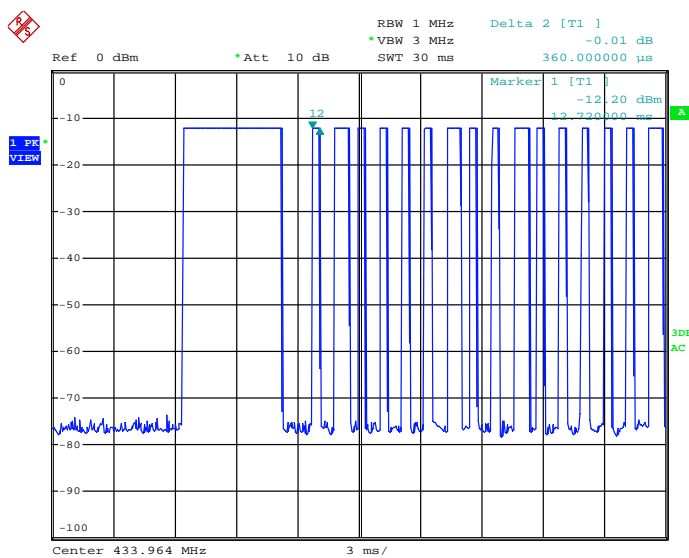

Date: 29.JUN.2015 19:13:33

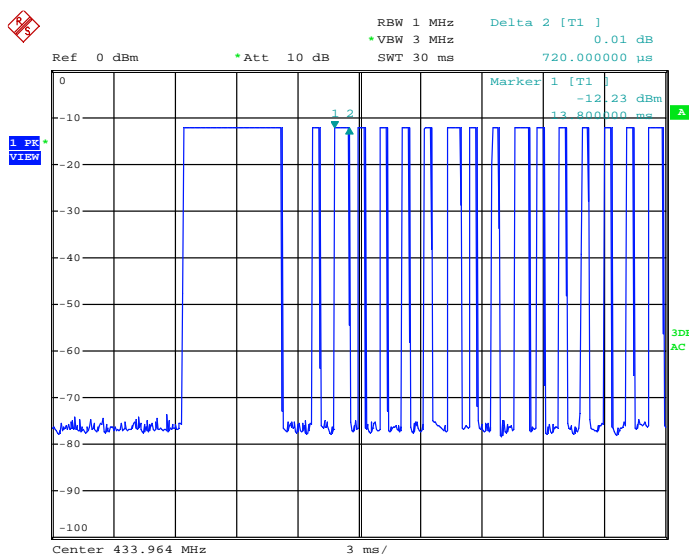

Date: 29.JUN.2015 19:13:44

3.6. Measurement Result

Below 1G

Antenna polarization:Horizontal

Freq. (MHz)	Reading Level(dBuV)	Correct Factor(dB)	Level (dBuV/m)	Limit Line (dBuV/m)	Margin (dB)	Remark
433.964	100.54	-16.78	83.76	100.83	-17.07	Peak
433.964	83.76	-7.40	76.36	80.83	-4.47	Average
867.928	40.62	-7.65	32.97	80.83	-47.86	Peak
867.928	32.97	-7.40	25.57	60.83	-35.26	Average

Antenna polarization:Vertical

Freq. (MHz)	Reading Level(dBuV)	Correct Factor(dB)	Level (dBuV/m)	Limit Line (dBuV/m)	Margin (dB)	Remark
433.964	96.15	-16.78	79.37	100.83	-21.46	Peak
433.964	79.37	-7.40	71.97	80.83	-8.86	Average
867.928	42.94	-7.65	35.29	80.83	-45.54	Peak
867.928	35.29	-7.40	27.89	60.83	-32.94	Average

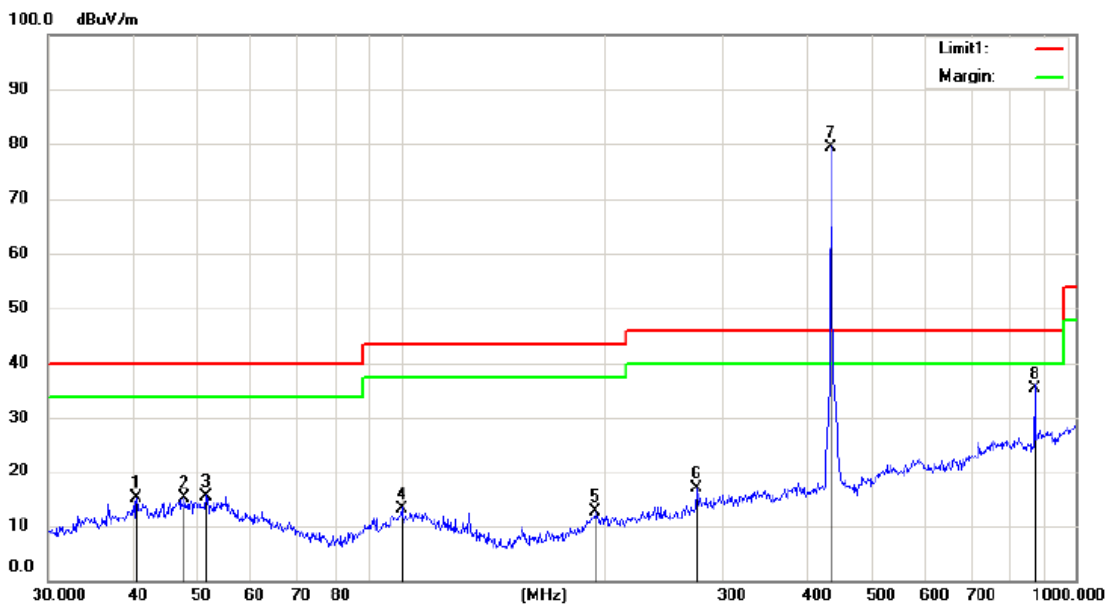

Site site #1 Polarization: **Vertical** Temperature: 20 C
 Limit: FCC Part15 Class B 3M Radiation Power: DC 3V Humidity: 52 %
 Mode: ON
 Note:

No.	Mk.	Freq. MHz	Reading Level dBuV	Correct Factor dB	Measure- ment dBuV/m	Limit dBuV/m	Over dB	Detector	Antenna Height cm	Table Degree	Comment
1		40.5591	35.76	-20.56	15.20	40.00	-24.80	QP			
2		47.8260	34.96	-19.86	15.10	40.00	-24.90	QP			
3		51.4806	34.99	-19.49	15.50	40.00	-24.50	QP			
4		100.2283	34.11	-20.91	13.20	43.50	-30.30	QP			
5		194.4533	34.43	-21.73	12.70	43.50	-30.80	QP			
6		274.1938	36.39	-19.49	16.90	46.00	-29.10	QP			
7	*	433.9640	96.15	-16.78	79.37	46.00	33.37	peak			
8		867.9280	42.94	-7.65	35.29	46.00	-10.71	peak			

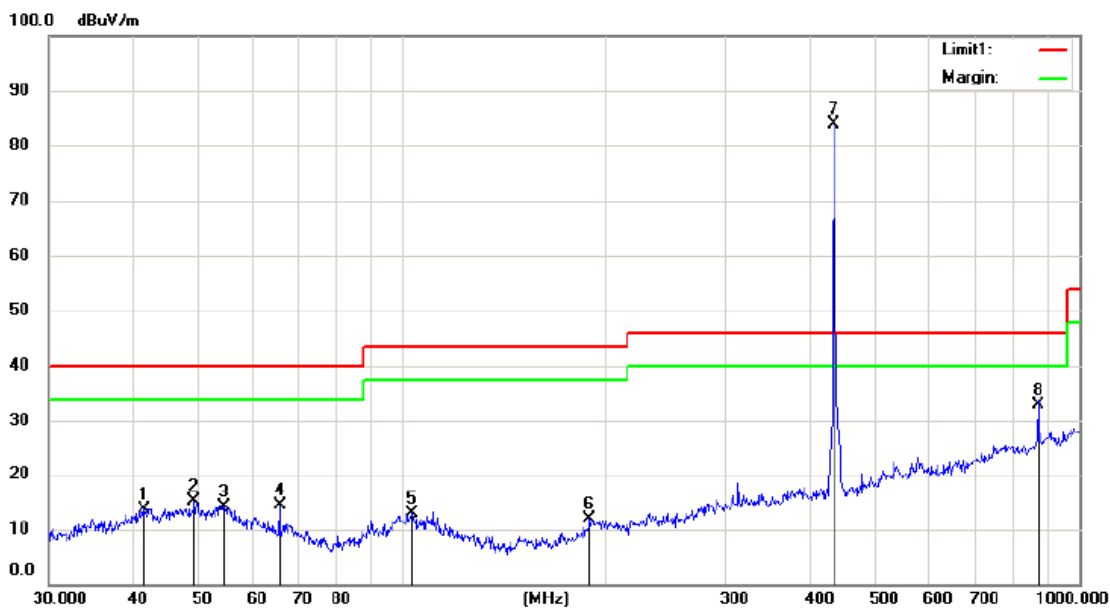

Site site #1 Polarization: *Horizontal* Temperature: 20 C
 Limit: FCC Part15 Class B 3M Radiation Power: DC 3V Humidity: 52 %
 Mode:ON
 Note:

No.	Mk.	Freq.	Reading Level	Correct Factor	Measurement	Limit	Over	Antenna Height	Table Degree	Comment
		MHz	dBuV	dB	dBuV/m	dBuV/m	dB	cm	degree	
1		41.4215	34.08	-20.38	13.70	40.00	-26.30	QP		
2		49.1865	34.73	-19.53	15.20	40.00	-24.80	QP		
3		54.4515	33.76	-19.66	14.10	40.00	-25.90	QP		
4		65.8030	37.40	-23.00	14.40	40.00	-25.60	QP		
5		103.4420	34.15	-21.15	13.00	43.50	-30.50	QP		
6		189.0741	34.50	-22.50	12.00	43.50	-31.50	QP		
7	*	433.9640	100.54	-16.78	83.76	46.00	37.76	peak		
8		867.9280	40.62	-7.65	32.97	46.00	-13.03	peak		

Above1G

Horizontal:

Freq. (MHz)	Reading Level(dBuV)	Correct Factor(dB)	Level (dBuV/m)	Limit Line (dBuV/m)	Margin (dB)	Remark
1301.00	63.77	-12.24	51.53	74.00	-22.47	Peak
1301.00	51.53	-7.40	44.13	54.00	-9.87	Average
1735.00	53.73	-10.60	43.13	80.83	-37.70	Peak
1735.00	43.13	-7.40	35.73	60.83	-25.10	Average
2169.00	49.86	-9.20	40.66	80.83	-40.17	Peak
2169.00	40.66	-7.40	33.26	60.83	-27.57	Average
2603.00	49.78	-7.35	42.43	80.83	-38.40	Peak
2603.00	42.43	-7.40	35.03	60.83	-25.80	Average
3019.50	48.88	-5.51	43.37	80.83	-37.46	Peak
3019.50	43.37	-7.40	35.97	60.83	-24.86	Average
3464.00	48.33	-5.09	43.24	74.00	-30.76	Peak
3464.00	43.24	-7.40	35.84	54.00	-18.16	Average

Vertical:

Freq. (MHz)	Reading Level(dBuV)	Correct Factor(dB)	Level (dBuV/m)	Limit Line (dBuV/m)	Margin (dB)	Remark
1301.00	64.56	-12.24	52.32	74.00	-21.68	Peak
1301.00	52.32	-7.40	44.92	54.00	-9.08	Average
1735.00	55.24	-10.60	44.64	80.83	-36.19	Peak
1735.00	44.64	-7.40	37.24	60.83	-23.59	Average
2169.00	52.65	-9.20	43.45	80.83	-37.38	Peak
2169.00	43.45	-7.40	36.05	60.83	-24.78	Average
2603.00	49.85	-7.35	42.50	80.83	-38.33	Peak
2603.00	42.50	-7.40	35.10	60.83	-25.73	Average
3121.00	47.88	-5.42	42.46	80.83	-38.37	Peak
3121.00	42.46	-7.40	35.06	60.83	-25.77	Average
3604.00	49.91	-4.64	45.27	74.00	-28.73	Peak
3604.00	45.27	-7.40	37.87	54.00	-16.13	Average

- Note:
- (1) All Readings are Peak Value.
 - (2) Correct Factor= Antenna Factor +Cable Loss- Amplifier Gain
 - (3) Emission Level= Reading Level+Probe Factor +Cable Loss
 - (4) True Value = Emission Level + Duty Cycle Correction Factor
 - (5) DF= Duty Cycle Correction Factor
 - (6) Duty Cycle Correction Factor (dB) = 20 × Log 10 Duty Cycle
 - (7) Margin = TrueValue – limit(if margin is minus means under limit)
 - (8) The “*” means restricted bands
 - (9) All the x/y/z orientation has been investigated, and only worst case is presented in this report.

4. TRANSMISSION REQUIREMENT

4.1. Requirement

Per 15.231(a) (1), a manually operated transmitter shall employ a switch that will automatically deactivate the transmitter within not more than 5 seconds of being released.

4.2. Test SET-UP

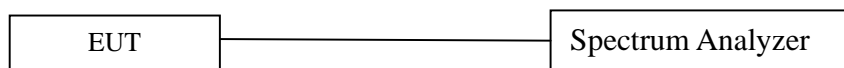

4.3. Measurement Equipment Used:

EQUIPMENT TYPE	MFR	MODEL NUMBER	SERIAL NUMBER	LAST CAL.	CAL DUE.
EMI Test Receiver	Rohde & Schwarz	ESCS30	828985/018	05/16/2015	05/15/2016

4.4. Test Procedure

The following table is the setting of spectrum analyzer.

Spectrum analyzer	Setting
Attenuation	Auto
Span Frequency	0Hz
RB	100KHz
VB	300KHz
Detector	Peak
Trace	Max hold
Sweep Time	5S

- The transmitter output (antenna port) was connected to the spectrum analyzer.
- Set RBW of spectrum analyzer to 100KHz and VBW to 300KHz, Set Detector to Peak, Trace to Max Hold.
- Set the span to 0Hz and the sweep time to 5s and record the value.

4.5. Test Data

Environmental Conditions

Temperature:	24°C
Relative Humidity:	53%
ATM Pressure:	1032mbar

Test Mode: Transmitting

Frequency (MHz)	Transmitting time (ms)	Limit (Second)	Result
433.964	170	5	PASS

Refer to the attached plot

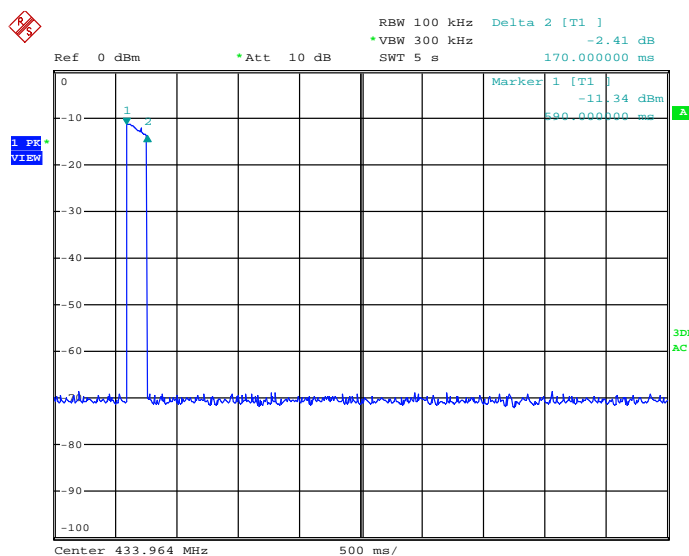

Date: 29.JUN.2015 19:09:30

Pulse Width(PW)= 0.36, $2/PW=2/0.36=5.6\text{KHz}$, $RBW=100\text{KHz}>5.6\text{KHz}$,
 Therefore PDCF is not needed

5. BANDWIDTH TEST

5.1. Measurement Procedure

The EUT was operated in hopping mode or could be controlled its channel. Print out the test result from the spectrum by hard copy function.

5.2. Test SET-UP (Block Diagram of Configuration)

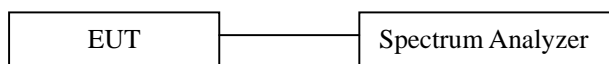

The test setup used to transmitter bandwidth measurement was the same with duty cycle test, except there is no need for digital oscilloscope in the bandwidth test. For detailed description, please reference to section 5.1, 5.2, 5.3 and 5.4 on page 11 and 12 of this report.

The resolution bandwidth of the spectrum analyzer was set to 100KHz, which is greater 5 percent of the maximum permitted bandwidth that required by the ANSI C63.10 section 6.9. Bandwidth is determined at the point 20dB down from the modulator carrier. The maximum permitted bandwidth specified by the rule was 0.25% of the center frequency of the EUT, e.g. $433.964\text{MHz} \times 0.25\% = 1.0849\text{MHz}$. The detector function was set to peak and hold mode to clearly observe the components.

5.3. Measurement Equipment Used:

EQUIPMENT TYPE	MFR	MODEL NUMBER	SERIAL NUMBER	LAST CAL.	CAL DUE.
EMI Test Receiver	Rohde & Schwarz	ESCS30	828985/018	05/16/2015	05/15/2016

5.4. Measurement Results:

Spectrum Detector:	PK	Test Date:	June 29, 2015
Test By:	King Kong	Temperature:	24°C
Test Result:	PASS	Humidity:	53 %
Modulation:	ASK		

Channel number	Channel frequency (MHz)	20dB Down BW(kHz)	Limit
CH1	433.964	448.00	≤1084.9KHz

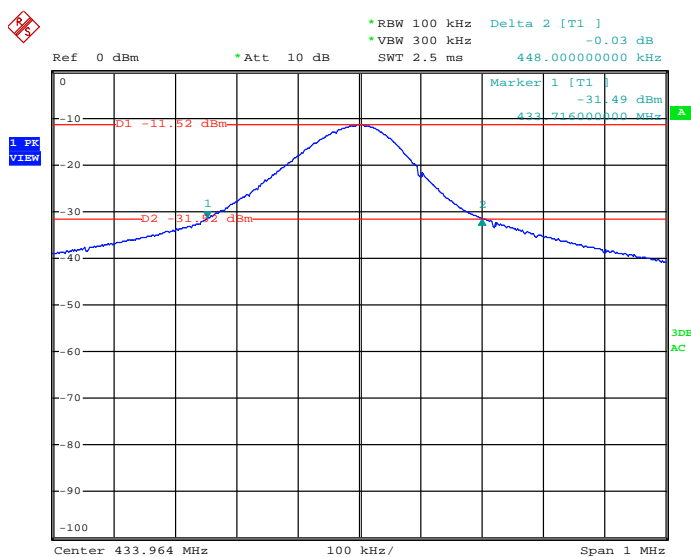

Date: 29.JUN.2015 19:08:45

6. Antenna Application

6.1. Antenna Requirement

For intentional device, according to FCC 47 CFR Section 15.203, an intentional radiator shall be designed to ensure that no antenna other than that furnished by the responsible party shall be used with the device.

6.2. Result

The EUT's antenna is PCB antenna, using a permanently attached antenna which is not replaceable. The antenna's gain is less than 3dBi and meets the requirement.

END OF REPORT