



# FCC TEST REPORT

**REPORT NO.:** RF991115E06

**MODEL NO.:** ARG-1210

**FCC ID:** VYXWIFI-012

**RECEIVED:** Nov. 15, 2010

**TESTED:** Nov. 30, 2010 to Mar. 31, 2011

**ISSUED:** Apr. 21, 2011

**APPLICANT:** Argtek Communication Inc.

**ADDRESS:** 8F-9, No. 4, Lane 609, Sec. 5, Chung Hsin Rd. San  
Chung City, Taipei Hsien

**ISSUED BY:** Bureau Veritas Consumer Products Services (H.K.)  
Ltd., Taoyuan Branch Hsin Chu Laboratory

**LAB ADDRESS :** No. 81-1, Lu Liao Keng, 9th Ling, Wu Lung Tsuen,  
Chiung Lin Hsiang, Hsin Chu Hsien 307, Taiwan

**TEST LOCATION (1):** No. 81-1, Lu Liao Keng, 9th Ling, Wu Lung Tsuen,  
Chiung Lin Hsiang, Hsin Chu Hsien 307, Taiwan

**TEST LOCATION (2):** No. 49, Ln. 206, Wende Rd., Shangshan Tsuen,  
Chiung Lin Hsiang, Hsin Chu Hsien 307, Taiwan

This test report consists of 78 pages in total. It may be duplicated completely for legal use with the approval of the applicant. It should not be reproduced except in full, without the written approval of our laboratory. The client should not use it to claim product certification, approval, or endorsement by TAF or any government agencies. The test results in the report only apply to the tested sample.





A D T

## Table of Contents

RELEASE CONTROL RECORD .....	4
1. CERTIFICATION .....	5
2. SUMMARY OF TEST RESULTS .....	6
2.1 MEASUREMENT UNCERTAINTY .....	7
3. GENERAL INFORMATION .....	8
3.1 GENERAL DESCRIPTION OF EUT .....	8
3.2 DESCRIPTION OF TEST MODES .....	10
3.2.1 TEST MODE APPLICABILITY AND TESTED CHANNEL DETAIL .....	11
3.3 GENERAL DESCRIPTION OF APPLIED STANDARDS .....	13
3.4 DESCRIPTION OF SUPPORT UNITS .....	14
3.5 CONFIGURATION OF SYSTEM UNDER TEST .....	15
4. TEST TYPES AND RESULTS .....	17
4.1 CONDUCTED EMISSION MEASUREMENT .....	17
4.1.1 LIMITS OF CONDUCTED EMISSION MEASUREMENT .....	17
4.1.2 TEST INSTRUMENTS .....	17
4.1.3 TEST PROCEDURES .....	18
4.1.4 DEVIATION FROM TEST STANDARD .....	18
4.1.5 TEST SETUP .....	19
4.1.6 EUT OPERATING CONDITIONS .....	19
4.1.7 TEST RESULTS .....	20
4.2 RADIATED EMISSION MEASUREMENT .....	22
4.2.1 LIMITS OF RADIATED EMISSION MEASUREMENT .....	22
4.2.2 TEST INSTRUMENTS .....	23
4.2.3 TEST PROCEDURES .....	24
4.2.4 DEVIATION FROM TEST STANDARD .....	24
4.2.5 TEST SETUP .....	25
4.2.6 EUT OPERATING CONDITIONS .....	25
4.2.7 TEST RESULTS .....	26
4.3 6DB BANDWIDTH MEASUREMENT .....	55
4.3.1 LIMITS OF 6DB BANDWIDTH MEASUREMENT .....	55
4.3.2 TEST INSTRUMENTS .....	55
4.3.3 TEST PROCEDURE .....	55
4.3.4 DEVIATION FROM TEST STANDARD .....	55
4.3.5 TEST SETUP .....	55
4.3.6 EUT OPERATING CONDITIONS .....	55



A D T

4.3.7	TEST RESULTS.....	56
4.4	MAXIMUM PEAK OUTPUT POWER.....	60
4.4.1	LIMITS OF MAXIMUM PEAK OUTPUT POWER MEASUREMENT .....	60
4.4.2	INSTRUMENTS .....	60
4.4.3	TEST PROCEDURES.....	60
4.4.4	DEVIATION FROM TEST STANDARD.....	60
4.4.5	TEST SETUP .....	60
4.4.6	EUT OPERATING CONDITIONS .....	60
4.4.7	TEST RESULTS.....	61
4.5	POWER SPECTRAL DENSITY MEASUREMENT .....	62
4.5.1	LIMITS OF POWER SPECTRAL DENSITY MEASUREMENT .....	62
4.5.2	TEST INSTRUMENTS .....	62
4.5.3	TEST PROCEDURE .....	62
4.5.4	DEVIATION FROM TEST STANDARD.....	62
4.5.5	TEST SETUP .....	62
4.5.6	EUT OPERATING CONDITION .....	62
4.5.7	TEST RESULTS.....	63
4.6	CONDUCTED OUT-BAND EMISSION MEASUREMENT .....	67
4.6.1	LIMITS OF CONDUCTED OUT-BAND EMISSION MEASUREMENT .....	67
4.6.2	TEST INSTRUMENTS .....	67
4.6.3	TEST PROCEDURE .....	67
4.6.4	DEVIATION FROM TEST STANDARD.....	67
4.6.5	EUT OPERATING CONDITION .....	67
4.6.6	TEST RESULTS.....	68
5.	INFORMATION ON THE TESTING LABORATORIES.....	77
6.	APPENDIX A - MODIFICATIONS RECORDERS FOR ENGINEERING CHANGES TO THE EUT BY THE LAB .....	78



## RELEASE CONTROL RECORD

ISSUE NO.	REASON FOR CHANGE	DATE ISSUED
RF991115E06	Original release	Apr. 21, 2011



A D T

## 1. CERTIFICATION

**PRODUCT:** ARGTEK POWER KING - X 802.11b/g/n AP ROUTER  
**BRAND NAME:** ARGtek  
**MODEL NO.:** ARG-1210  
**TEST SAMPLE:** ENGINEERING SAMPLE  
**APPLICANT:** Argtek Communication Inc.  
**TESTED:** Nov. 30, 2010 to Mar. 31, 2011  
**STANDARDS:** FCC Part 15, Subpart C (Section 15.247)  
ANSI C63.4-2003  
ANSI C63.10-2009

The above equipment (Model: ARG-1210) has been tested by **Bureau Veritas Consumer Products Services (H.K.) Ltd., Taoyuan Branch**, and found compliance with the requirement of the above standards. The test record, data evaluation & Equipment Under Test (EUT) configurations represented herein are true and accurate accounts of the measurements of the sample's EMC characteristics under the conditions specified in this report.

**PREPARED BY** : Carol Liao , **DATE:** Apr. 21, 2011  
( Carol Liao, Specialist )

**APPROVED BY** : May Chen , **DATE:** Apr. 21, 2011  
( May Chen, Deputy Manager )



A D T

## 2. SUMMARY OF TEST RESULTS

The EUT has been tested according to the following specifications:

APPLIED STANDARD: FCC Part 15, Subpart C			
Standard Section	Test Type and Limit	Result	Remark
15.207	AC Power Conducted Emission	PASS	Meet the requirement of limit. Minimum passing margin is -0.58dB at 0.408MHz
15.247(a)(2)	Spectrum Bandwidth of a Direct Sequence Spread Spectrum System Limit: min. 500kHz	PASS	Meet the requirement of limit.
15.247(b)	Maximum Peak Output Power	PASS	Meet the requirement of limit.
15.247(d)	Radiated Emissions Limit: Table 15.209	PASS	Meet the requirement of limit. Minimum passing margin is -0.5dB at 4824.00 MHz & 4874.00MHz
15.247(e)	Power Spectral Density Limit: max. 8dBm	PASS	Meet the requirement of limit.
15.247(d)	Conducted Out-Band Emission Measurement Limit: 20dB less than the peak value of fundamental frequency	PASS	Meet the requirement of limit.
15.203	Antenna Requirement	PASS	Antenna connector is RP-SMA not a standard connector.



A D T

## 2.1 MEASUREMENT UNCERTAINTY

Where relevant, the following measurement uncertainty levels have been estimated for tests performed on the EUT as specified in CISPR 16-4-2:

This uncertainty represents an expanded uncertainty expressed at approximately the 95% confidence level using a coverage factor of  $k=2$ .

Measurement	Value
Conducted emissions	2.45 dB
Radiated emissions (30MHz-1GHz)	3.30 dB
Radiated emissions (1GHz -18GHz)	2.19 dB
Radiated emissions (18GHz -40GHz)	2.55 dB



A D T

### 3. GENERAL INFORMATION

#### 3.1 GENERAL DESCRIPTION OF EUT

<b>PRODUCT</b>	ARGTEK POWER KING - X 802.11b/g/n AP ROUTER
<b>MODEL NO.</b>	ARG-1210
<b>FCC ID</b>	VYXWIFI-012
<b>POWER SUPPLY</b>	DC 12V from power adapter
<b>MODULATION TYPE</b>	CCK, DQPSK, DBPSK for DSSS 64QAM, 16QAM, QPSK, BPSK for OFDM
<b>MODULATION TECHNOLOGY</b>	DSSS, OFDM
<b>TRANSFER RATE</b>	802.11b: 11 / 5.5 / 2 / 1Mbps 802.11g: 54 / 48 / 36 / 24 / 18 / 12 / 9 / 6Mbps 802.11n (20MHz, 800ns GI): 130 / 117 / 104 / 78 / 65 / 58.5 / 52 / 39 / 26 / 19.5 / 13 / 6.5Mbps 802.11n (40MHz, 800ns GI): 270 / 243 / 216 / 162 / 135 / 121.5 / 108 / 81 / 54 / 40.5 / 27 / 13.5Mbps 802.11n (20MHz, 400ns GI): 144.44 / 130 / 115.56 / 86.67 / 72.2 / 65 / 57.8 / 43.3 / 28.9 / 21.7 / 14.4 / 7.2Mbps 802.11n (40MHz, 400ns GI): 300 / 270 / 240 / 180 / 150 / 135 / 120 / 90 / 60 / 45 / 30 / 15Mbps
<b>FREQUENCY RANGE</b>	2412MHz ~ 2462MHz
<b>NUMBER OF CHANNEL</b>	11 for 802.11b, 802.11g, 802.11n (20MHz) 7 for 802.11n (40MHz)
<b>MAXIMUM OUTPUT POWER</b>	802.11b: 45.7mW 802.11g: 912mW 802.11n (20MHz): 227.7mW 802.11n (40MHz): 280.2mW
<b>ANTENNA TYPE</b>	Please see note 1
<b>DATA CABLE</b>	NA
<b>I/O PORTS</b>	LAN port x 4 , WAN port x 1
<b>ASSOCIATED DEVICES</b>	Adapter x 1



**NOTE:**

1. There is one antenna provided to this EUT, please refer to the following table:

Net Gain	Antenna Type	Frequency range (MHz to MHz)	Connector Type
5dBi	Dipole	2400~2483	RP-SMA

2. The EUT must be supplied with a power adapter as below table:

<b>BRAND</b>	JFEC
<b>MODEL</b>	JF015WR-1200150UV
<b>INPUT POWER</b>	AC 100-240V, 50/60Hz, 0.5A
<b>OUTPUT POWER</b>	DC 12V, 1.5A DC Cable: 1.5m unshielded

3. The EUT is 2 \* 2 spatial MIMO (2Tx & 2Rx) without beam forming function. The 11b and 11g legacy mode is limited to single transmitter only.
4. When the EUT operating in 802.11n, the software operation, which is defined by manufacturer, MCS (Modulation and Coding Schemes) from 0 to 15.
5. The above EUT information was declared by manufacturer and for more detailed features description, please refer to the manufacturer's specifications or user's manual.



A D T

### 3.2 DESCRIPTION OF TEST MODES

Eleven channels are provided for 802.11b, 802.11g, 802.11n (20MHz):

CHANNEL	FREQUENCY	CHANNEL	FREQUENCY
1	2412MHz	7	2442MHz
2	2417MHz	8	2447MHz
3	2422MHz	9	2452MHz
4	2427MHz	10	2457MHz
5	2432MHz	11	2462MHz
6	2437MHz		

Seven channels are provided for 802.11n (40MHz):

CHANNEL	FREQUENCY	CHANNEL	FREQUENCY
3	2422MHz	7	2442MHz
4	2427MHz	8	2447MHz
5	2432MHz	9	2452MHz
6	2437MHz		



A D T

### 3.2.1 TEST MODE APPLICABILITY AND TESTED CHANNEL DETAIL

EUT CONFIGURE MODE	APPLICABLE TO				DESCRIPTION
	PLC	RE < 1G	RE ≥ 1G	APCM	
-	√	√	√	√	-

Where **PLC**: Power Line Conducted Emission      **RE < 1G**: Radiated Emission below 1GHz  
**RE ≥ 1G**: Radiated Emission above 1GHz      **APCM**: Antenna Port Conducted Measurement

#### ANTENNA COMBINATION MODE:

COMBINATION MODE	OPERATION MODE	TX CHAIN(0)	TX CHAIN(1)
A	802.11 b	√	
B	802.11 g	√	
C	802.11n(20MHz) for MCS0~7	√	
D	802.11n(40MHz) for MCS0~7	√	
E	802.11n(20MHz) for MCS8~15	√	√
F	802.11n(40MHz) for MCS8~15	√	√

Note:

- The above information was declared by manufacturer and for more detailed features description, please refer to the manufacturer's specifications or user's manual.
- Mode A, B, E & F the worst modes were selected as representative mode for the report.

#### POWER LINE CONDUCTED EMISSION TEST:

- Pre-Scan has been conducted to determine the worst-case mode from all possible combinations between available modulations, data rates and antenna ports (if EUT with antenna diversity architecture).
- Following channel(s) was (were) selected for the final test as listed below.

MODE	AVAILABLE CHANNEL	TESTED CHANNEL	MODULATION TECHNOLOGY	MODULATION TYPE	DATA RATE (Mbps)	TX COMBINATION
802.11g	1 to 11	6	OFDM	BPSK	6	B

#### RADIATED EMISSION TEST (BELOW 1 GHz):

- Pre-Scan has been conducted to determine the worst-case mode from all possible combinations between available modulations, data rates and antenna ports (if EUT with antenna diversity architecture).
- Following channel(s) was (were) selected for the final test as listed below.

MODE	AVAILABLE CHANNEL	TESTED CHANNEL	MODULATION TECHNOLOGY	MODULATION TYPE	DATA RATE (Mbps)	TX COMBINATION
802.11g	1 to 11	6	OFDM	BPSK	6	B

**RADIATED EMISSION TEST (ABOVE 1 GHz):**

- Pre-Scan has been conducted to determine the worst-case mode from all possible combinations between available modulations, data rates and antenna ports (if EUT with antenna diversity architecture).
- Following channel(s) was (were) selected for the final test as listed below.

MODE	AVAILABLE CHANNEL	TESTED CHANNEL	MODULATION TECHNOLOGY	MODULATION TYPE	DATA RATE (Mbps)	TX COMBINATION
802.11b	1 to 11	1, 6, 11	DSSS	DBPSK	1	A
802.11g	1 to 11	1, 6, 11	OFDM	BPSK	6	B
802.11n (20MHz)	1 to 11	1, 6, 11	OFDM	BPSK	13	E
802.11n (40MHz)	3 to 9	3, 6, 9	OFDM	BPSK	27	F

**CONDUCTED OUT-BAND EMISSION MEASUREMENT:**

- Pre-Scan has been conducted to determine the worst-case mode from all possible combinations between available modulations, data rates and antenna ports (if EUT with antenna diversity architecture).
- Following channel(s) was (were) selected for the final test as listed below.

MODE	AVAILABLE CHANNEL	TESTED CHANNEL	MODULATION TECHNOLOGY	MODULATION TYPE	DATA RATE (Mbps)	TX COMBINATION
802.11b	1 to 11	1, 11	DSSS	DBPSK	1	A
802.11g	1 to 11	1, 11	OFDM	BPSK	6	B
802.11n (20MHz)	1 to 11	1, 11	OFDM	BPSK	13	E
802.11n (40MHz)	3 to 9	3, 9	OFDM	BPSK	27	F

- ※ Conducted out band emission as show worst chain in report base on preliminary measurement.

### ANTENNA PORT CONDUCTED MEASUREMENT:

- This item includes all test value of each mode, but only includes spectrum plot of worst value of each mode.
- Pre-Scan has been conducted to determine the worst-case mode from all possible combinations between available modulations, data rates and antenna ports (if EUT with antenna diversity architecture).
- Following channel(s) was (were) selected for the final test as listed below.

MODE	AVAILABLE CHANNEL	TESTED CHANNEL	MODULATION TECHNOLOGY	MODULATION TYPE	DATA RATE (Mbps)	TX COMBINATION
802.11b	1 to 11	1, 6, 11	DSSS	DBPSK	1	A
802.11g	1 to 11	1, 6, 11	OFDM	BPSK	6	B
802.11n (20MHz)	1 to 11	1, 6, 11	OFDM	BPSK	13	E
802.11n (40MHz)	3 to 9	3, 6, 9	OFDM	BPSK	27	F

※ Bandwidth as show worst chain in report base on preliminary measurement.

### TEST CONDITION:

APPLICABLE TO	ENVIRONMENTAL CONDITIONS	INPUT POWER (SYSTEM)	TESTED BY
RE <sup>3</sup> 1G	21deg. C, 64%RH, 1025 hPa	120Vac, 60Hz	Kent Liu
RE<1G	21deg. C, 64%RH, 1025 hPa	120Vac, 60Hz	Kent Liu
PLC	15deg. C, 67%RH, 1025 hPa	120Vac, 60Hz	Frank Liu
APCM	25deg. C, 60%RH, 1025 hPa	120Vac, 60Hz	Kent Liu

### **3.3 GENERAL DESCRIPTION OF APPLIED STANDARDS**

The EUT is a RF product. According to the specifications of the manufacturer, it must comply with the requirements of the following standards:

**FCC Part 15, Subpart C. (15.247)**

**ANSI C63.4-2003**

**ANSI C63.10-2009**

All test items have been performed and recorded as per the above standards.

**NOTE:** The EUT has been verified to comply with the requirements of FCC Part 15, Subpart B, Class B (DoC). The test report has been issued separately.



A D T

### 3.4 DESCRIPTION OF SUPPORT UNITS

The EUT has been tested as an independent unit together with other necessary accessories or support units. The following support units or accessories were used to form a representative test configuration during the tests.

NO.	PRODUCT	BRAND	MODEL NO.	SERIAL NO.	FCC ID
1	NOTEBOOK COMPUTER	DELL	PP32LA	FSLB32S	FCC DoC
2	NOTEBOOK COMPUTER	DELL	PP32LA	GSLB32S	FCC DoC
3	NOTEBOOK COMPUTER (For conducted test)	DELL	PP32LA	DSL32S	FCC DoC
4	HUB	ZyXEL	ES-116P	S060H02000215	FCC DoC

NO.	SIGNAL CABLE DESCRIPTION OF THE ABOVE SUPPORT UNITS
1	UTP Cable , 10m
2	UTP Cable , 10m
3	NA
4	UTP Cable , 10m

**NOTE:** 1. All power cords of the above support units are non shielded (1.8m).

### 3.5 CONFIGURATION OF SYSTEM UNDER TEST

For conducted test:

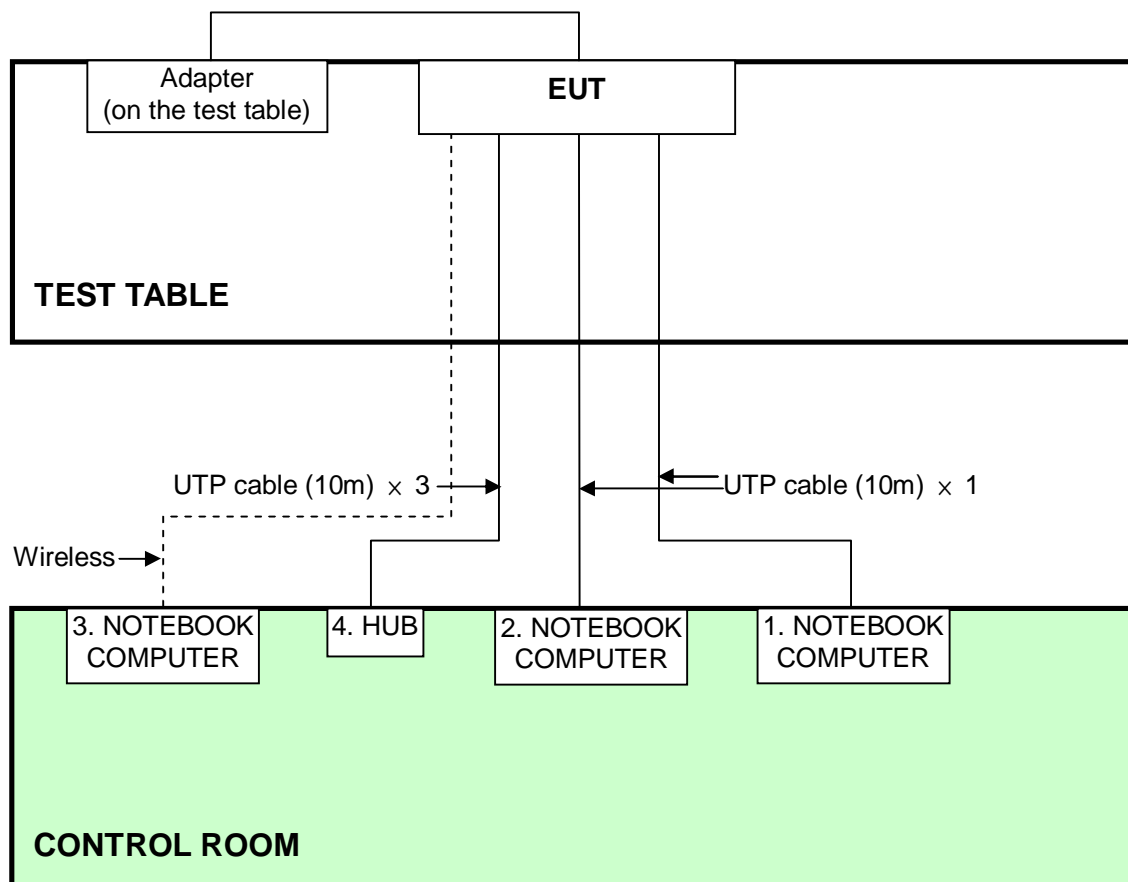

For other test items:

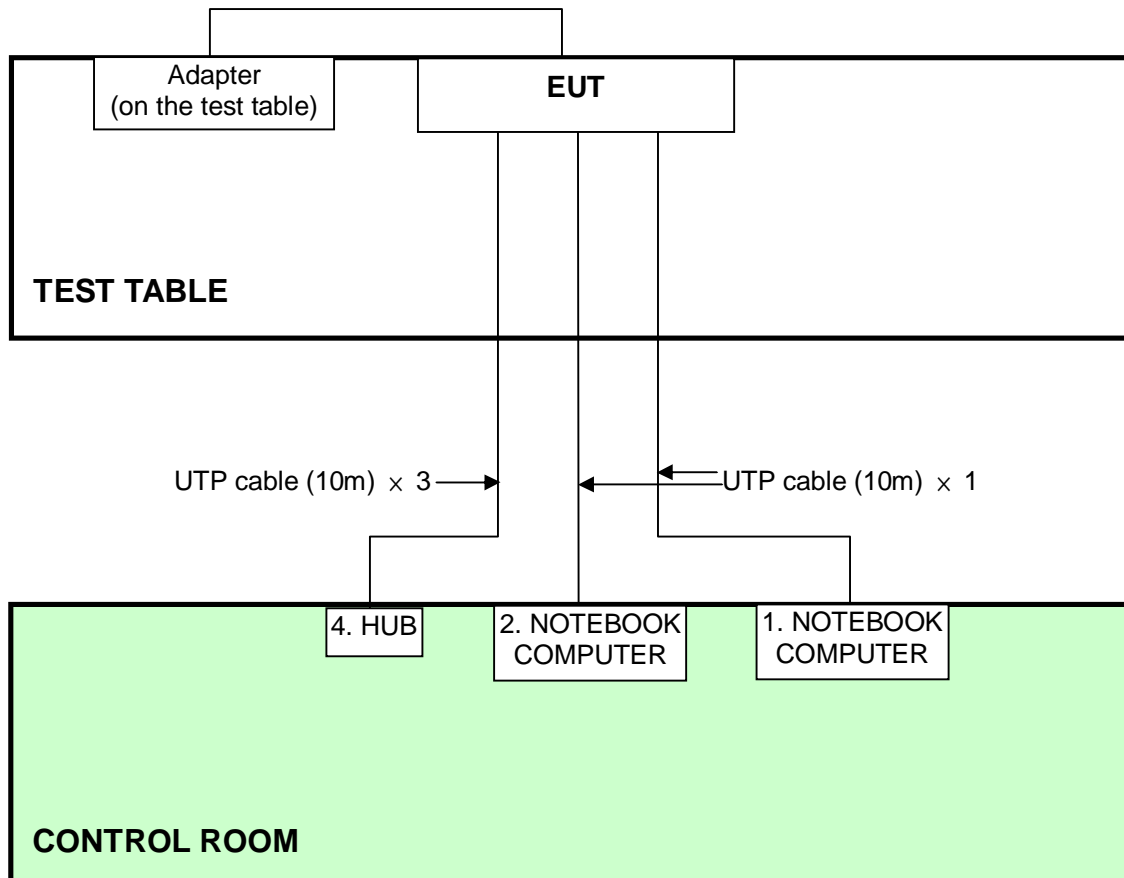



## 4. TEST TYPES AND RESULTS

### 4.1 CONDUCTED EMISSION MEASUREMENT

#### 4.1.1 LIMITS OF CONDUCTED EMISSION MEASUREMENT

FREQUENCY OF EMISSION (MHz)	CONDUCTED LIMIT (dB $\mu$ V)	
	Quasi-peak	Average
0.15-0.5	66 to 56	56 to 46
0.5-5	56	46
5-30	60	50

- NOTE:**
1. The lower limit shall apply at the transition frequencies.
  2. The limit decreases in line with the logarithm of the frequency in the range of 0.15 to 0.50 MHz.
  3. All emanations from a class A/B digital device or system, including any network of conductors and apparatus connected thereto, shall not exceed the level of field strengths specified above.

#### 4.1.2 TEST INSTRUMENTS

Test date: Mar. 31, 2011

DESCRIPTION & MANUFACTURER	MODEL NO.	SERIAL NO.	CALIBRATED DATE	CALIBRATED UNTIL
Test Receiver	ESCS 30	100375	Mar. 09, 2011	Mar. 08, 2012
Line-Impedance Stabilization Network (for EUT)	NSLK 8127	8127-522	Sep. 08, 2010	Sep. 07, 2011
Line-Impedance Stabilization Network (for Peripheral)	ESH3-Z5	848773/004	Nov. 03, 2010	Nov. 02, 2011
RF Cable (JYBAO)	5DFB	COCCAB-002	Aug. 30, 2010	Aug. 29, 2011
50 ohms Terminator	50	3	Nov. 03, 2010	Nov. 02, 2011
Software	BV ADT_Cond_V7.3.7	NA	NA	NA

**Note:**

1. The calibration interval of the above test instruments is 12 months and the calibrations are traceable to NML/ROC and NIST/USA.
2. The test was performed in Shielded Room No. C.
3. The VCCI Con C Registration No. is C-3611.

#### 4.1.3 TEST PROCEDURES

- a. The EUT was placed 0.4 meters from the conducting wall of the shielded room with EUT being connected to the power mains through a line impedance stabilization network (LISN). Other support units were connected to the power mains through another LISN. The two LISNs provide 50 ohm/ 50uH of coupling impedance for the measuring instrument.
- b. Both lines of the power mains connected to the EUT were checked for maximum conducted interference.
- c. The frequency range from 150kHz to 30MHz was searched. Emission levels under (Limit - 20dB) were not recorded.

#### 4.1.4 DEVIATION FROM TEST STANDARD

No deviation

#### 4.1.5 TEST SETUP

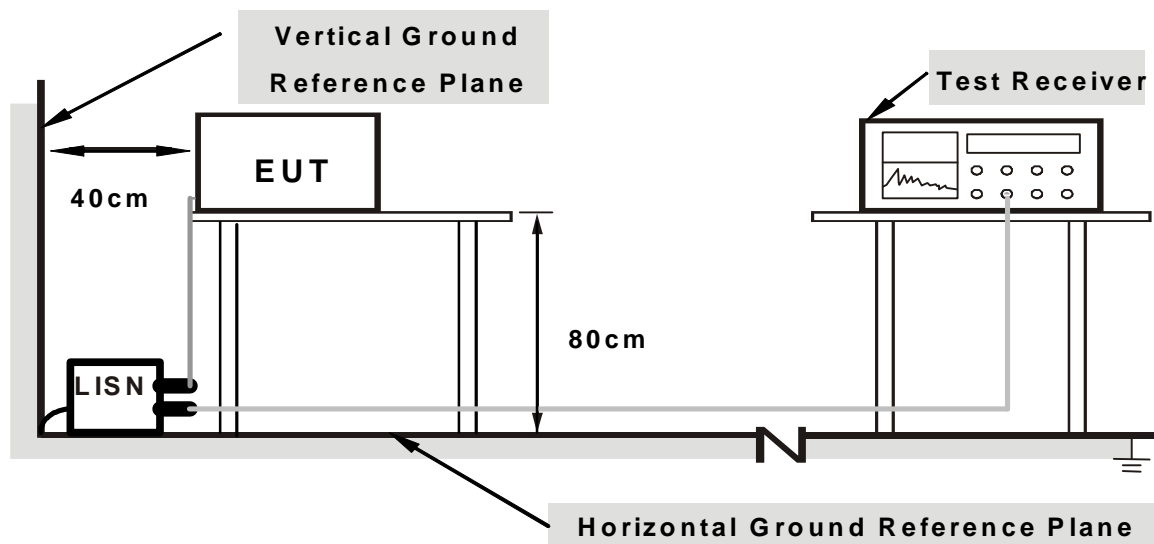

**Note: 1. Support units were connected to second LISN.**

**2. Both of LISNs (AMN) are 80 cm from EUT and at least 80 from other units and other metal planes**

For the actual test configuration, please refer to the related item – Photographs of the Test Configuration.

#### 4.1.6 EUT OPERATING CONDITIONS

1. Turn on the power of all equipment.
2. Support units 1~3 (Notebook Computer) run a test program “Ping.exe” to enable of EUT via UTP cables and wireless continuously.

### 4.1.7 TEST RESULTS

<b>PHASE</b>	Line (L)	<b>6dB BANDWIDTH</b>	9 kHz
--------------	----------	----------------------	-------

No	Freq.	Corr.	Reading Value		Emission Level		Limit		Margin	
	[MHz]	Factor	[dB (uV)]		[dB (uV)]		[dB (uV)]		(dB)	
		(dB)	Q.P.	AV.	Q.P.	AV.	Q.P.	AV.	Q.P.	AV.
1	0.408	0.13	54.12	46.98	54.25	47.11	57.69	47.69	-3.44	-0.58
2	0.455	0.13	51.12	42.28	51.25	42.41	56.79	46.79	-5.54	-4.38
3	0.455	0.13	50.72	42.04	50.85	42.17	56.79	46.79	-5.94	-4.62
4	1.063	0.14	54.16	41.66	54.30	41.80	56.00	46.00	-1.70	-4.20
5	2.813	0.18	49.04	35.40	49.22	35.58	56.00	46.00	-6.78	-10.42
6	2.918	0.18	45.10	-	45.28	-	56.00	46.00	-10.72	-

- REMARKS:**
1. Q.P. and AV. are abbreviations of quasi-peak and average individually.
  2. "-": The Quasi-peak reading value also meets average limit and measurement with the average detector is unnecessary.
  3. The emission levels of other frequencies were very low against the limit.
  4. Margin value = Emission level - Limit value
  5. Correction factor = Insertion loss + Cable loss
  6. Emission Level = Correction Factor + Reading Value.

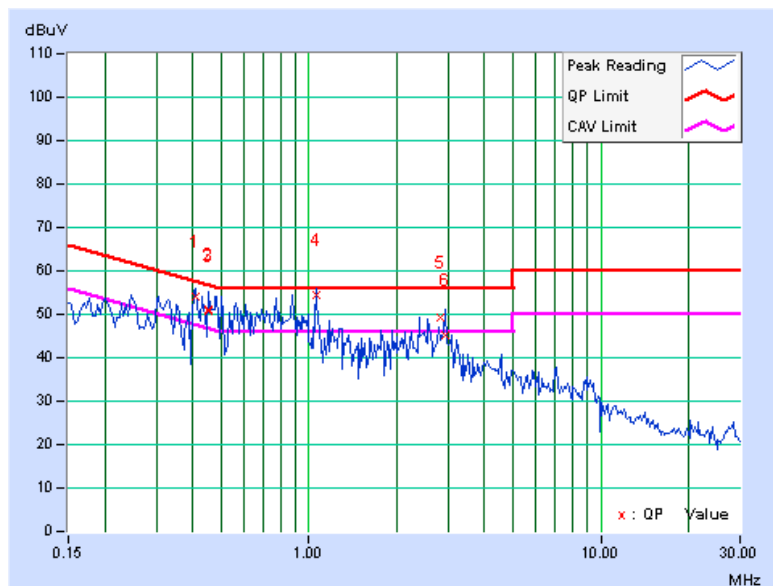

<b>PHASE</b>	Neutral (N)	<b>6dB BANDWIDTH</b>	9 kHz
--------------	-------------	----------------------	-------

No	Freq. [MHz]	Corr. Factor (dB)	Reading Value		Emission Level		Limit		Margin	
			[dB (uV)]		[dB (uV)]		[dB (uV)]		(dB)	
			Q.P.	AV.	Q.P.	AV.	Q.P.	AV.	Q.P.	AV.
1	0.369	0.15	44.92	-	45.07	-	58.53	48.53	-13.46	-
2	0.408	0.15	50.86	43.66	51.01	43.81	57.69	47.69	-6.68	-3.88
3	0.459	0.15	49.00	37.80	49.15	37.95	56.72	46.72	-7.57	-8.77
4	0.873	0.16	41.74	-	41.90	-	56.00	46.00	-14.10	-
5	1.176	0.17	44.84	-	45.01	-	56.00	46.00	-10.99	-
6	2.168	0.20	38.00	-	38.20	-	56.00	46.00	-17.80	-
7	3.293	0.25	37.62	-	37.87	-	56.00	46.00	-18.13	-

- REMARKS:**
1. Q.P. and AV. are abbreviations of quasi-peak and average individually.
  2. "-": The Quasi-peak reading value also meets average limit and measurement with the average detector is unnecessary.
  3. The emission levels of other frequencies were very low against the limit.
  4. Margin value = Emission level - Limit value
  5. Correction factor = Insertion loss + Cable loss
  6. Emission Level = Correction Factor + Reading Value.

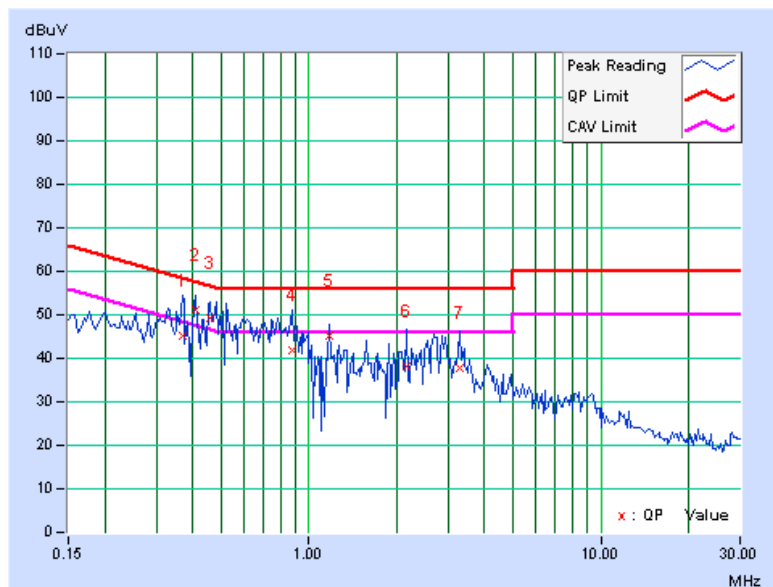

## 4.2 RADIATED EMISSION MEASUREMENT

### 4.2.1 LIMITS OF RADIATED EMISSION MEASUREMENT

Emissions radiated outside of the specified bands, shall be according to the general radiated limits in 15.209 as following:

Frequencies (MHz)	Field strength (microvolts/meter)	Measurement distance (meters)
0.009-0.490	2400/F(kHz)	300
0.490-1.705	24000/F(kHz)	30
1.705-30.0	30	30
30-88	100	3
88-216	150	3
216-960	200	3
Above 960	500	3

**NOTE:**

1. The lower limit shall apply at the transition frequencies.
2. Emission level (dBuV/m) = 20 log Emission level (uV/m).
3. As shown in 15.35(b), for frequencies above 1000MHz, the field strength limits are based on average detector, however, the peak field strength of any emission shall not exceed the maximum permitted average limits, specified above by more than 20dB under any condition of modulation.
4. Section 15.205 restricted bands of operation shall compliance with the limits in Section 15.209.



A D T

## 4.2.2 TEST INSTRUMENTS

Test date: Nov. 30, 2010 to Mar. 28, 2011

DESCRIPTION & MANUFACTURER	MODEL NO.	SERIAL NO.	CALIBRATED DATE	CALIBRATED UNTIL
Agilent Spectrum Analyzer	E4446A	MY48250254	July 14, 2010	July 13, 2011
Agilent Pre-Selector	N9039A	MY46520311	July 14, 2010	July 13, 2011
Agilent Signal Generator	N5181A	MY49060517	July 14, 2010	July 13, 2011
Mini-Circuits Pre-Amplifier	ZFL-1000VH2B	AMP-ZFL-03	Nov. 16, 2010	Nov. 15, 2011
Agilent Pre-Amplifier	8449B	3008A02578	July 05, 2010	July 04, 2011
Miteq Pre-Amplifier	AFS33-1800265 0-30-8P-44	881786	NA	NA
SCHWARZBECK Trilog Broadband Antenna	VULB 9168	9168-360	Apr. 29, 2010	Apr. 28, 2011
AISI Horn_Antenna	AIH.8018	0000320091110	Nov. 12, 2010	Nov. 11, 2011
SCHWARZBECK Horn_Antenna	BBHA 9170	9170-424	Oct. 08, 2010	Oct. 07, 2011
RF CABLE	NA	RF104-201 RF104-203 RF104-204	Dec. 27, 2010	Dec. 26, 2011
RF Cable	NA	CHGCAB_001	NA	NA
Software	ADT_Radiated_V8.7.05	NA	NA	NA
CT Antenna Tower & Turn Table	NA	NA	NA	NA

Note: 1. The calibration interval of the above test instruments is 12 months and the calibrations are traceable to NML/ROC and NIST/USA.

2. The horn antenna, preamplifier (model: 8449B) are used only for the measurement of emission frequency above 1GHz if tested.

3. The test was performed in 966 Chamber No. G.

4. The FCC Site Registration No. is 966073.

5. The VCCI Site Registration No. is G-137.

6. The CANADA Site Registration No. is IC 7450H-2.

#### 4.2.3 TEST PROCEDURES

- a. The EUT was placed on the top of a rotating table 0.8 meters above the ground at 3 meters chamber room. The table was rotated 360 degrees to determine the position of the highest radiation.
- b. The EUT was set 3 meters away from the interference-receiving antenna, which was mounted on the top of a variable-height antenna tower.
- c. The height of antenna is varied from one meter to four meters above the ground to determine the maximum value of the field strength. Both horizontal and vertical polarizations of the antenna are set to make the measurement.
- d. For each suspected emission, the EUT was arranged to its worst case and then the antenna was tuned to heights from 1 meter to 4 meters and the rotatable table was turned from 0 degrees to 360 degrees to find the maximum reading.
- e. The test-receiver system was set to quasi-peak detect function and specified bandwidth with maximum hold mode when the test frequency is below 1 GHz.
- f. The test-receiver system was set to peak and average detect function and specified bandwidth with maximum hold mode when the test frequency is above 1 GHz. If the peak reading value also meets average limit, measurement with the average detector is unnecessary.

**NOTE:**

1. The resolution bandwidth and video bandwidth of test receiver/spectrum analyzer is 120kHz for Peak detection (PK) and Quasi-peak detection (QP) at frequency below 1GHz.
2. The resolution bandwidth of test receiver/spectrum analyzer is 1 MHz and video bandwidth is 3MHz for Peak detection at frequency above 1GHz.
3. The resolution bandwidth of test receiver/spectrum analyzer is 1MHz and the video bandwidth is 10Hz for Average detection (AV) at frequency above 1GHz.

#### 4.2.4 DEVIATION FROM TEST STANDARD

No deviation



#### 4.2.5 TEST SETUP

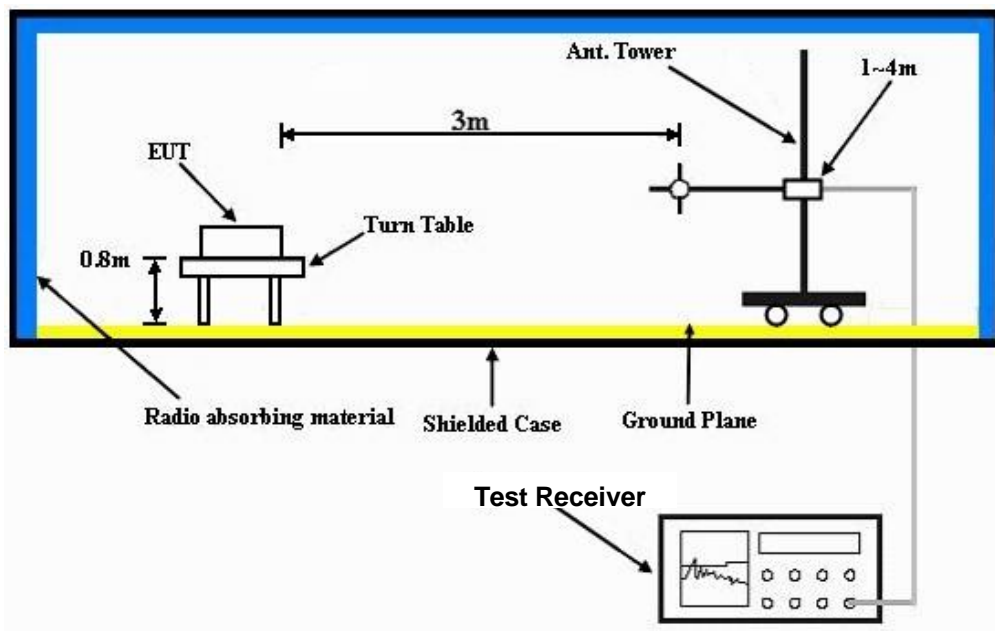

For the actual test configuration, please refer to the related item – Photographs of the Test Configuration.

#### 4.2.6 EUT OPERATING CONDITIONS

1. Turn on the power of all equipment.
2. The support unit 1 (Notebook Computer) runs test program “MP\_Test” to enable EUT under transmission/receiving condition continuously via one UTP cable.



A D T

## 4.2.7 TEST RESULTS

### BELOW 1GHz WORST-CASE DATA : 802.11g OFDM MODULATION

EUT TEST CONDITION		MEASUREMENT DETAIL	
CHANNEL	Channel 6	FREQUENCY RANGE	Below 1000MHz
INPUT POWER	120V / 60Hz	DETECTOR FUNCTION	Quasi-Peak
ENVIRONMENTAL CONDITIONS	21deg. C, 64%RH 1025 hPa	TESTED BY	Kent Liu

ANTENNA POLARITY & TEST DISTANCE: HORIZONTAL AT 3 M								
NO.	FREQ. (MHz)	EMISSION LEVEL (dBuV/m)	LIMIT (dBuV/m)	MARGIN (dB)	ANTENNA HEIGHT (m)	TABLE ANGLE (Degree)	RAW VALUE (dBuV)	CORRECTION FACTOR (dB/m)
1	148.54	31.9 QP	43.5	-11.6	1.50 H	277	18.13	13.78
2	219.95	37.9 QP	46.0	-8.1	1.00 H	286	26.28	11.62
3	297.04	37.5 QP	46.0	-8.5	1.00 H	237	22.43	15.08
4	445.55	35.6 QP	46.0	-10.4	1.75 H	360	17.23	18.40
5	594.05	40.9 QP	46.0	-5.1	1.50 H	137	19.04	21.83
6	742.55	40.4 QP	46.0	-5.6	1.00 H	114	16.70	23.73
7	891.17	32.9 QP	46.0	-13.1	1.50 H	123	6.82	26.09
ANTENNA POLARITY & TEST DISTANCE: VERTICAL AT 3 M								
NO.	FREQ. (MHz)	EMISSION LEVEL (dBuV/m)	LIMIT (dBuV/m)	MARGIN (dB)	ANTENNA HEIGHT (m)	TABLE ANGLE (Degree)	RAW VALUE (dBuV)	CORRECTION FACTOR (dB/m)
1	77.96	33.4 QP	40.0	-6.6	1.75 V	297	23.63	9.75
2	220.07	36.8 QP	46.0	-9.2	1.00 V	225	25.14	11.63
3	240.08	37.3 QP	46.0	-8.7	1.75 V	360	24.59	12.67
4	297.04	41.4 QP	46.0	-4.6	2.00 V	113	26.36	15.08
5	445.55	35.3 QP	46.0	-10.7	1.00 V	91	16.89	18.40
6	500.02	39.0 QP	46.0	-7.0	1.00 V	84	19.28	19.71
7	594.05	38.1 QP	46.0	-7.9	1.75 V	131	16.30	21.83
8	742.55	40.9 QP	46.0	-5.1	1.50 V	102	17.16	23.73

**REMARKS:** 1. Emission level (dBuV/m) = Raw Value (dBuV) + Correction Factor (dB/m).

2. Correction Factor (dB/m) = Antenna Factor (dB/m) + Cable Factor (dB).

3. The other emission levels were very low against the limit.

4. Margin value = Emission level – Limit value.



A D T

## 802.11b DSSS MODULATION

EUT TEST CONDITION		MEASUREMENT DETAIL	
CHANNEL	Channel 1	FREQUENCY RANGE	1 ~ 25GHz
INPUT POWER	120V / 60Hz	DETECTOR FUNCTION	Peak (PK) Average (AV)
ENVIRONMENTAL CONDITIONS	21deg. C, 64%RH 1025 hPa	TESTED BY	Kent Liu

ANTENNA POLARITY & TEST DISTANCE: HORIZONTAL AT 3 M								
NO.	FREQ. (MHz)	EMISSION LEVEL (dBuV/m)	LIMIT (dBuV/m)	MARGIN (dB)	ANTENNA HEIGHT (m)	TABLE ANGLE (Degree)	RAW VALUE (dBuV)	CORRECTION FACTOR (dB/m)
1	2390.00	54.3 PK	74.0	-19.7	1.08 H	209	22.64	31.66
2	2390.00	42.9 AV	54.0	-11.1	1.08 H	209	11.24	31.66
3	*2412.00	88.7 PK			1.08 H	209	56.97	31.73
4	*2412.00	85.3 AV			1.08 H	209	53.57	31.73
5	4824.00	52.9 PK	74.0	-21.1	1.16 H	95	13.93	38.97
6	4824.00	48.9 AV	54.0	-5.1	1.16 H	95	9.93	38.97
ANTENNA POLARITY & TEST DISTANCE: VERTICAL AT 3 M								
NO.	FREQ. (MHz)	EMISSION LEVEL (dBuV/m)	LIMIT (dBuV/m)	MARGIN (dB)	ANTENNA HEIGHT (m)	TABLE ANGLE (Degree)	RAW VALUE (dBuV)	CORRECTION FACTOR (dB/m)
1	2389.00	56.5 PK	74.0	-17.5	1.37 V	109	24.85	31.65
2	2389.00	44.5 AV	54.0	-9.5	1.37 V	109	12.85	31.65
3	*2412.00	103.9 PK			1.37 V	109	72.17	31.73
4	*2412.00	101.9 AV			1.37 V	109	70.17	31.73
5	4824.00	56.0 PK	74.0	-18.0	1.00 V	308	17.03	38.97
6	4824.00	53.0 AV	54.0	-1.0	1.00 V	308	14.03	38.97

- REMARKS:**
1. Emission level (dBuV/m) = Raw Value (dBuV) + Correction Factor (dB/m).
  2. Correction Factor (dB/m) = Antenna Factor (dB/m) + Cable Factor (dB).
  3. The other emission levels were very low against the limit.
  4. Margin value = Emission level – Limit value.
  5. “ \* “: Fundamental frequency.



A D T

EUT TEST CONDITION		MEASUREMENT DETAIL	
CHANNEL	Channel 6	FREQUENCY RANGE	1 ~ 25GHz
INPUT POWER	120V / 60Hz	DETECTOR FUNCTION	Peak (PK) Average (AV)
ENVIRONMENTAL CONDITIONS	21deg. C, 64%RH 1025 hPa	TESTED BY	Kent Liu

ANTENNA POLARITY & TEST DISTANCE: HORIZONTAL AT 3 M								
NO.	FREQ. (MHz)	EMISSION LEVEL (dBuV/m)	LIMIT (dBuV/m)	MARGIN (dB)	ANTENNA HEIGHT (m)	TABLE ANGLE (Degree)	RAW VALUE (dBuV)	CORRECTION FACTOR (dB/m)
1	*2437.00	89.1 PK			1.06 H	210	57.29	31.81
2	*2437.00	85.5 AV			1.06 H	210	53.69	31.81
3	4874.00	54.5 PK	74.0	-19.5	1.00 H	163	15.36	39.14
4	4874.00	47.6 AV	54.0	-6.4	1.00 H	163	8.46	39.14
5	7311.00	54.8 PK	74.0	-19.2	1.48 H	167	8.16	46.63
6	7311.00	41.1 AV	54.0	-12.9	1.48 H	167	-5.53	46.63

ANTENNA POLARITY & TEST DISTANCE: VERTICAL AT 3 M								
NO.	FREQ. (MHz)	EMISSION LEVEL (dBuV/m)	LIMIT (dBuV/m)	MARGIN (dB)	ANTENNA HEIGHT (m)	TABLE ANGLE (Degree)	RAW VALUE (dBuV)	CORRECTION FACTOR (dB/m)
1	*2437.00	104.2 PK			1.38 V	112	72.39	31.81
2	*2437.00	102.1 AV			1.38 V	112	70.29	31.81
3	4874.00	56.4 PK	74.0	-17.6	1.01 V	99	17.26	39.14
4	4874.00	53.2 AV	54.0	-0.8	1.01 V	99	14.06	39.14
5	7311.00	55.5 PK	74.0	-18.5	1.29 V	280	8.87	46.63
6	7311.00	44.1 AV	54.0	-9.9	1.29 V	280	-2.53	46.63

- REMARKS:**
1. Emission level (dBuV/m) = Raw Value (dBuV) + Correction Factor (dB/m).
  2. Correction Factor (dB/m) = Antenna Factor (dB/m) + Cable Factor (dB).
  3. The other emission levels were very low against the limit.
  4. Margin value = Emission level – Limit value.
  5. “ \* “: Fundamental frequency.



A D T

EUT TEST CONDITION		MEASUREMENT DETAIL	
CHANNEL	Channel 11	FREQUENCY RANGE	1 ~ 25GHz
INPUT POWER	120V / 60Hz	DETECTOR FUNCTION	Peak (PK) Average (AV)
ENVIRONMENTAL CONDITIONS	21deg. C, 64%RH 1025 hPa	TESTED BY	Kent Liu

**ANTENNA POLARITY & TEST DISTANCE: HORIZONTAL AT 3 M**

NO.	FREQ. (MHz)	EMISSION LEVEL (dBuV/m)	LIMIT (dBuV/m)	MARGIN (dB)	ANTENNA HEIGHT (m)	TABLE ANGLE (Degree)	RAW VALUE (dBuV)	CORRECTION FACTOR (dB/m)
1	*2462.00	90.3 PK			1.07 H	214	58.41	31.89
2	*2462.00	87.1 AV			1.07 H	214	55.21	31.89
3	2483.50	55.7 PK	74.0	-18.3	1.07 H	214	23.73	31.97
4	2483.50	43.1 AV	54.0	-10.9	1.07 H	214	11.13	31.97
5	4924.00	52.7 PK	74.0	-21.3	1.63 H	23	13.39	39.31
6	4924.00	45.5 AV	54.0	-8.5	1.63 H	23	6.19	39.31
7	7386.00	54.1 PK	74.0	-19.9	1.63 H	44	7.50	46.60
8	7386.00	41.8 AV	54.0	-12.2	1.63 H	44	-4.80	46.60

**ANTENNA POLARITY & TEST DISTANCE: VERTICAL AT 3 M**

NO.	FREQ. (MHz)	EMISSION LEVEL (dBuV/m)	LIMIT (dBuV/m)	MARGIN (dB)	ANTENNA HEIGHT (m)	TABLE ANGLE (Degree)	RAW VALUE (dBuV)	CORRECTION FACTOR (dB/m)
1	*2462.00	104.5 PK			1.33 V	111	72.61	31.89
2	*2462.00	102.4 AV			1.33 V	111	70.51	31.89
3	2500.00	57.3 PK	74.0	-16.7	1.33 V	111	25.28	32.02
4	2500.00	45.4 AV	54.0	-8.6	1.33 V	111	13.38	32.02
5	4924.00	55.7 PK	74.0	-18.3	1.02 V	96	16.39	39.31
6	4924.00	52.8 AV	54.0	-1.2	1.02 V	96	13.49	39.31
7	7386.00	56.8 PK	74.0	-17.2	1.28 V	122	10.20	46.60
8	7386.00	45.9 AV	54.0	-8.1	1.28 V	122	-0.70	46.60

- REMARKS:**
1. Emission level (dBuV/m) = Raw Value (dBuV) + Correction Factor (dB/m).
  2. Correction Factor (dB/m) = Antenna Factor (dB/m) + Cable Factor (dB).
  3. The other emission levels were very low against the limit.
  4. Margin value = Emission level – Limit value.
  5. “ \* “: Fundamental frequency.



A D T

RESTRICTED BANDEDGE (802.11b MODE, CH1, HORIZONTAL)

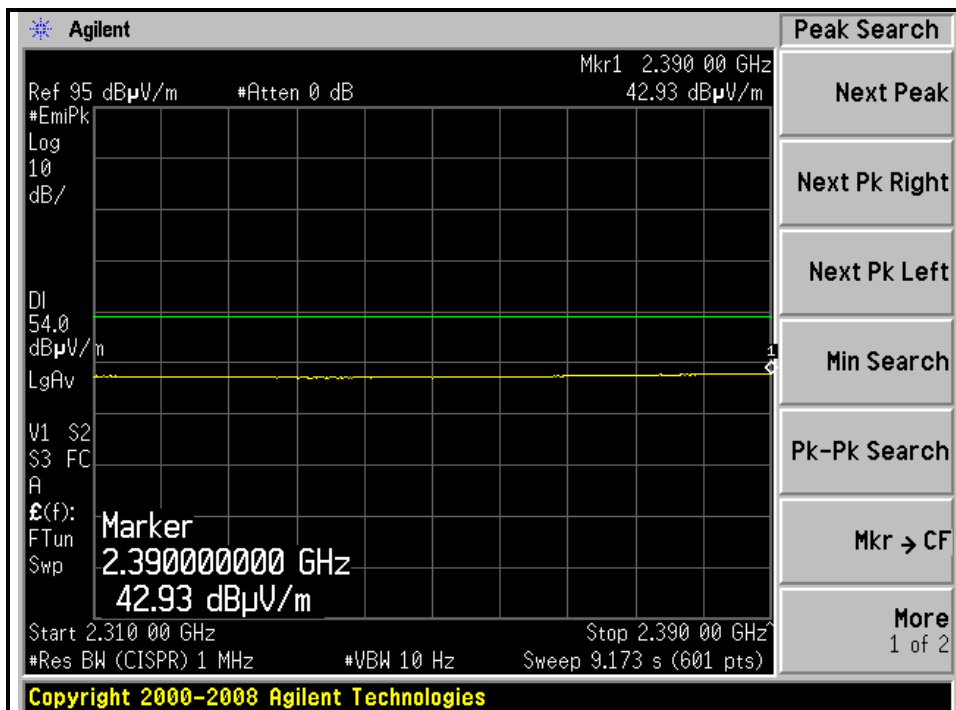
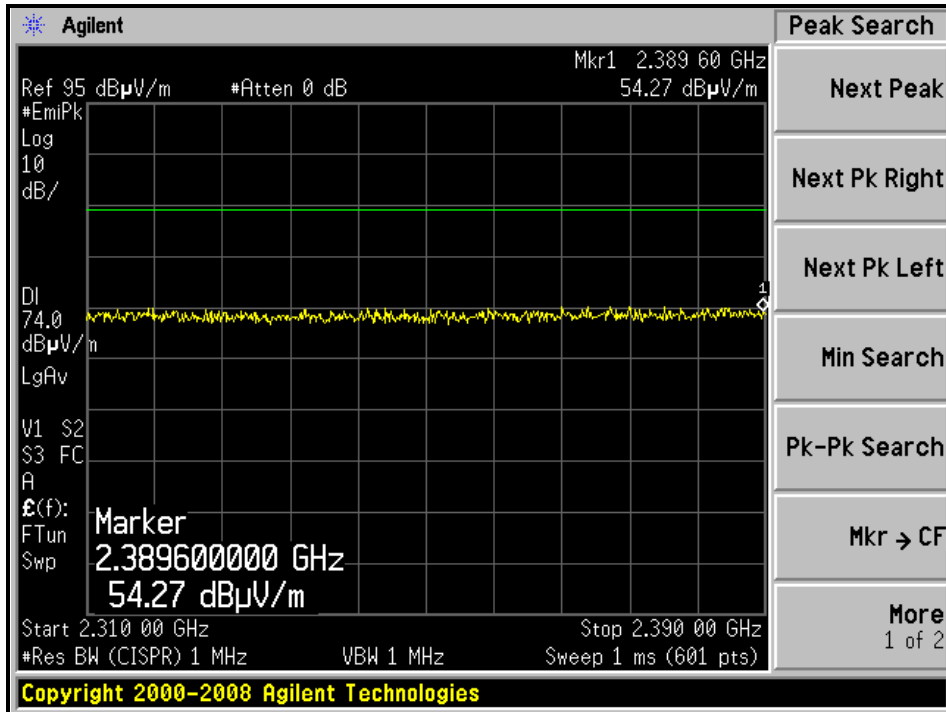

RESTRICTED BANDEDGE (802.11b MODE, CH1, VERTICAL )

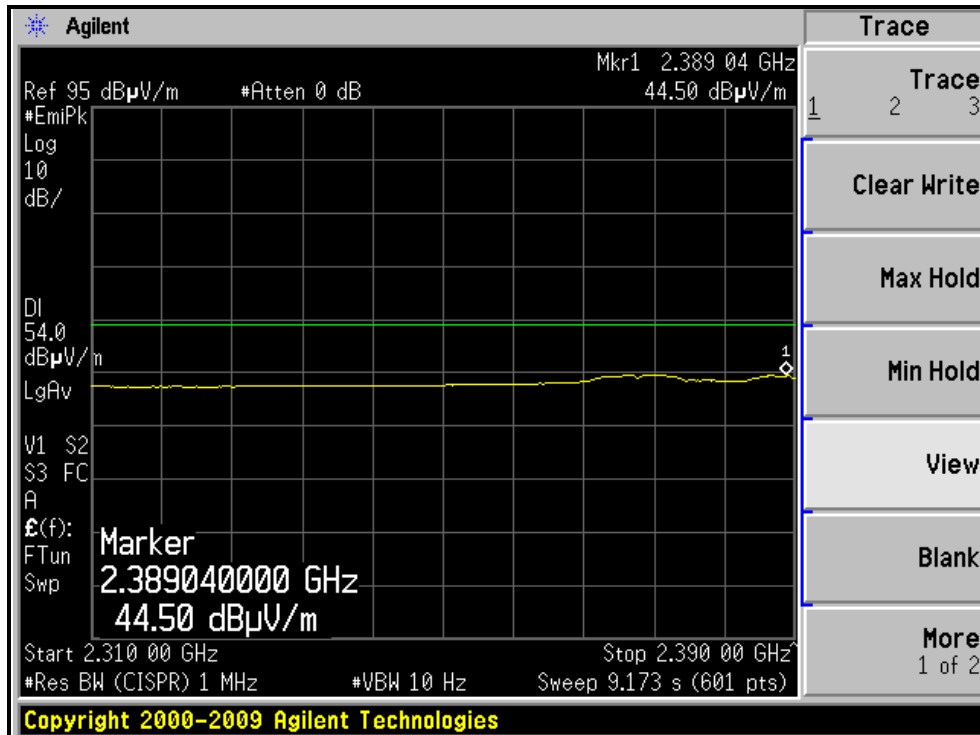
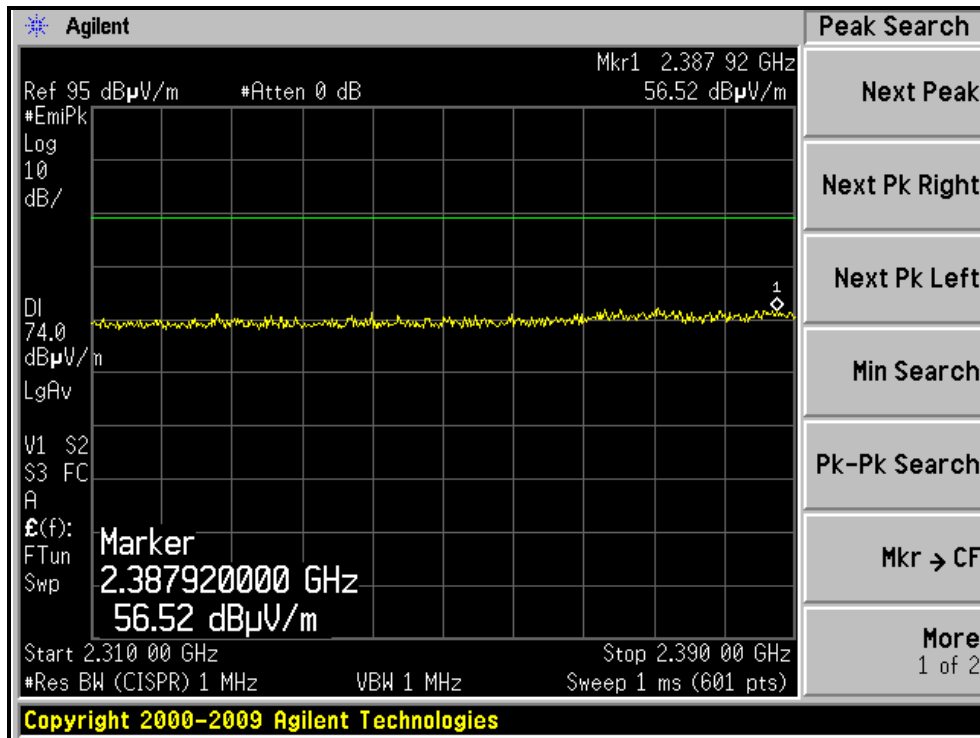



A D T

RESTRICTED BANDEDGE (802.11b MODE, CH11, HORIZONTAL )

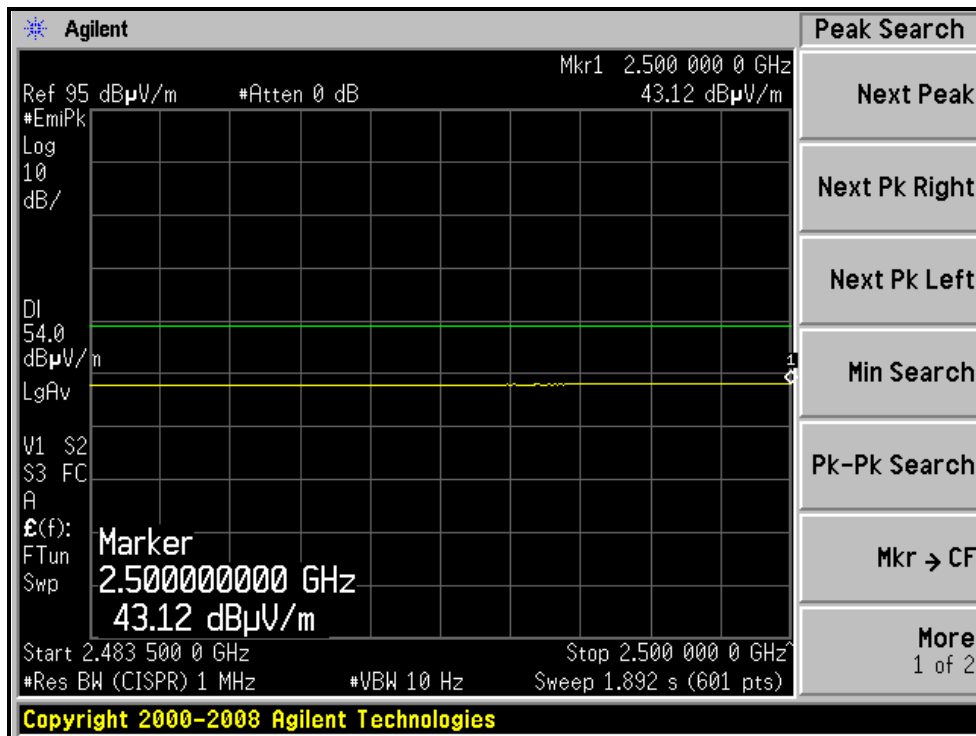
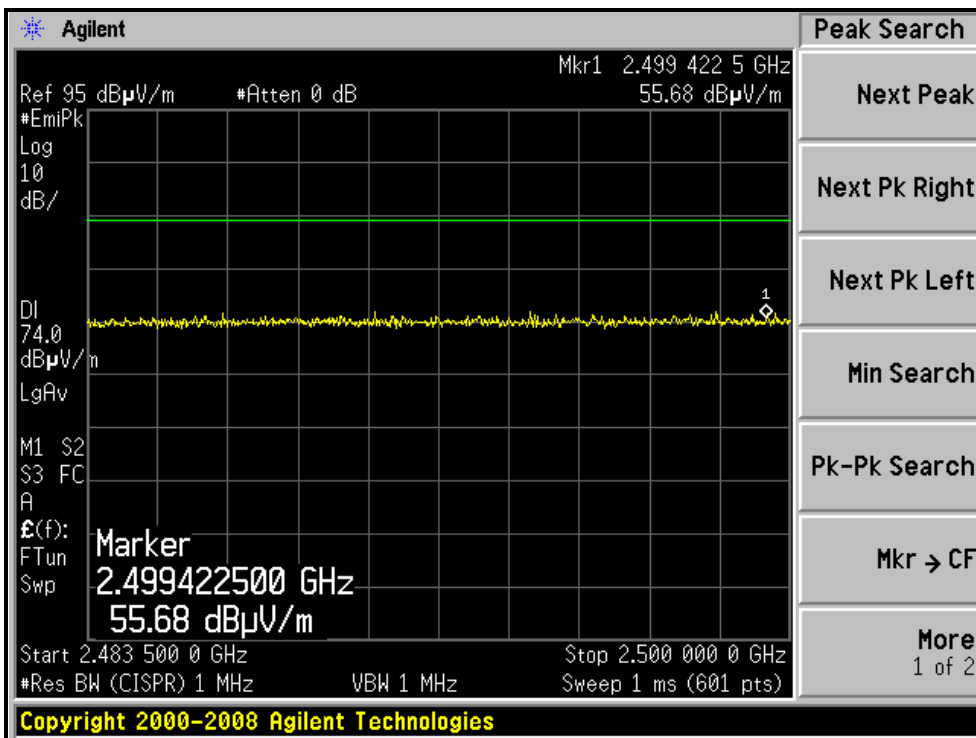



RESTRICTED BANDEDGE (802.11b MODE, CH11, VERTICAL )

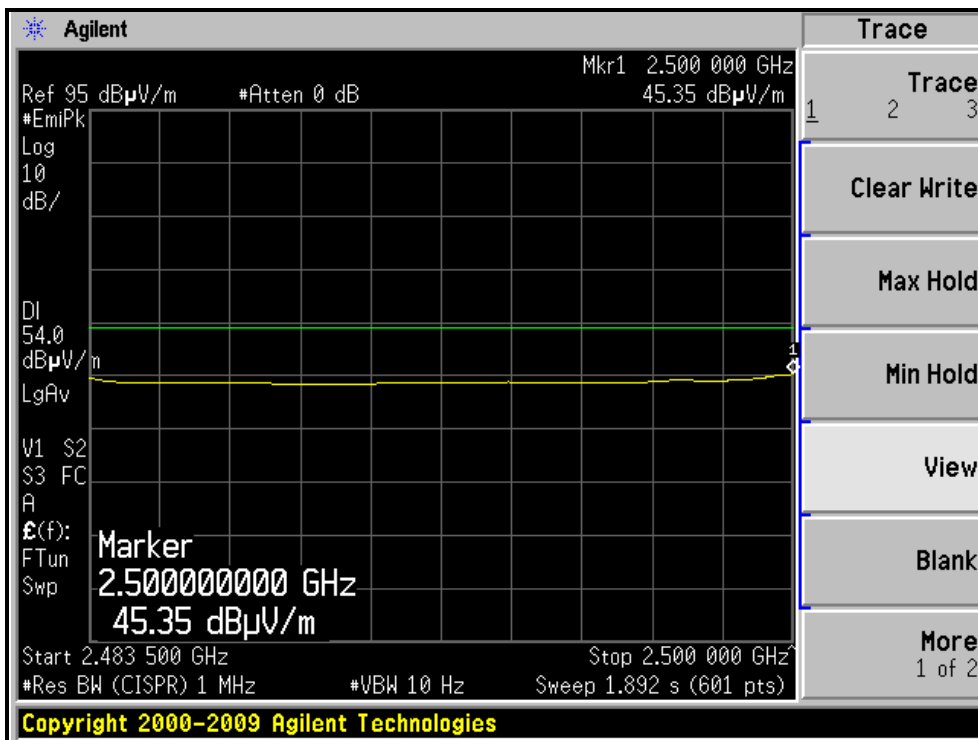
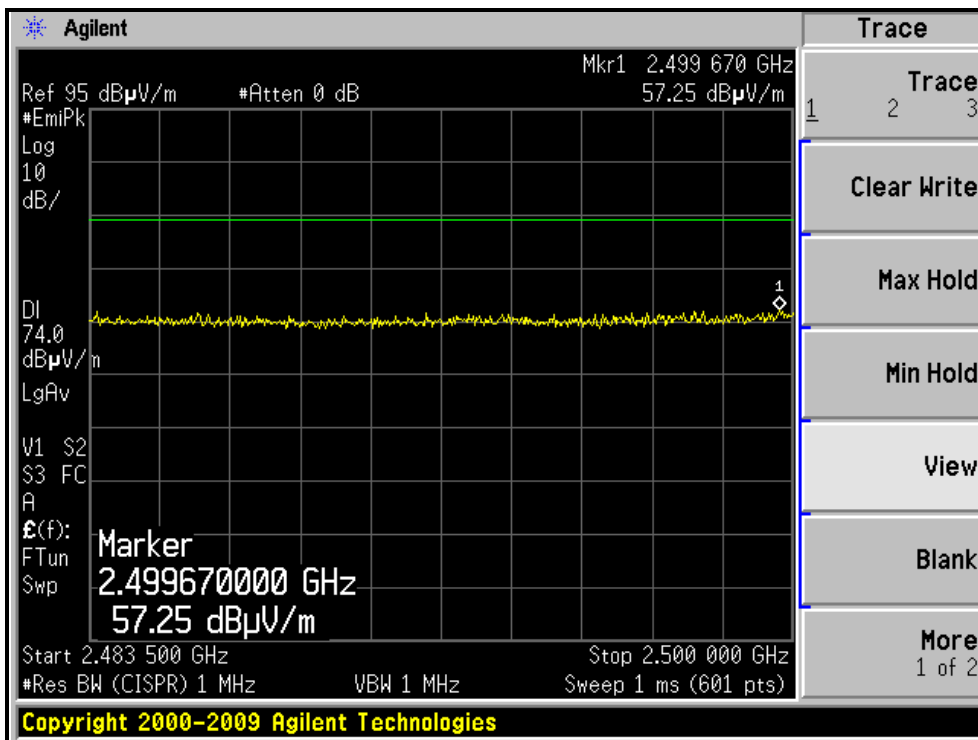



A D T

802.11g OFDM MODULATION

EUT TEST CONDITION		MEASUREMENT DETAIL	
CHANNEL	Channel 1	FREQUENCY RANGE	1 ~ 25GHz
INPUT POWER	120V / 60Hz	DETECTOR FUNCTION	Peak (PK) Average (AV)
ENVIRONMENTAL CONDITIONS	21deg. C, 64%RH 1025 hPa	TESTED BY	Kent Liu

ANTENNA POLARITY & TEST DISTANCE: HORIZONTAL AT 3 M								
NO.	FREQ. (MHz)	EMISSION LEVEL (dBuV/m)	LIMIT (dBuV/m)	MARGIN (dB)	ANTENNA HEIGHT (m)	TABLE ANGLE (Degree)	RAW VALUE (dBuV)	CORRECTION FACTOR (dB/m)
1	2390.00	56.1 PK	74.0	-17.9	1.08 H	209	24.44	31.66
2	2390.00	43.7 AV	54.0	-10.3	1.08 H	209	12.04	31.66
3	*2412.00	94.2 PK			1.08 H	209	62.47	31.73
4	*2412.00	84.3 AV			1.08 H	209	52.57	31.73
5	4824.00	54.1 PK	74.0	-19.9	1.57 H	175	15.13	38.97
6	4824.00	40.5 AV	54.0	-13.5	1.57 H	175	1.53	38.97
ANTENNA POLARITY & TEST DISTANCE: VERTICAL AT 3 M								
NO.	FREQ. (MHz)	EMISSION LEVEL (dBuV/m)	LIMIT (dBuV/m)	MARGIN (dB)	ANTENNA HEIGHT (m)	TABLE ANGLE (Degree)	RAW VALUE (dBuV)	CORRECTION FACTOR (dB/m)
1	2390.00	69.8 PK	74.0	-4.2	1.39 V	109	38.14	31.66
2	2390.00	53.0 AV	54.0	-1.0	1.39 V	109	21.34	31.66
3	*2412.00	109.4 PK			1.39 V	109	77.67	31.73
4	*2412.00	100.0 AV			1.39 V	109	68.27	31.73
5	4824.00	62.1 PK	74.0	-11.9	1.32 V	127	23.13	38.97
6	4824.00	50.4 AV	54.0	-3.6	1.32 V	127	11.43	38.97

- REMARKS:**
1. Emission level (dBuV/m) = Raw Value (dBuV) + Correction Factor (dB/m).
  2. Correction Factor (dB/m) = Antenna Factor (dB/m) + Cable Factor (dB).
  3. The other emission levels were very low against the limit.
  4. Margin value = Emission level – Limit value.
  5. “ \* ”: Fundamental frequency.



A D T

EUT TEST CONDITION		MEASUREMENT DETAIL	
CHANNEL	Channel 6	FREQUENCY RANGE	1 ~ 25GHz
INPUT POWER	120V / 60Hz	DETECTOR FUNCTION	Peak (PK) Average (AV)
ENVIRONMENTAL CONDITIONS	21deg. C, 64%RH 1025 hPa	TESTED BY	Kent Liu

**ANTENNA POLARITY & TEST DISTANCE: HORIZONTAL AT 3 M**

NO.	FREQ. (MHz)	EMISSION LEVEL (dBuV/m)	LIMIT (dBuV/m)	MARGIN (dB)	ANTENNA HEIGHT (m)	TABLE ANGLE (Degree)	RAW VALUE (dBuV)	CORRECTION FACTOR (dB/m)
1	*2437.00	94.9 PK			1.07 H	210	63.09	31.81
2	*2437.00	85.4 AV			1.07 H	210	53.59	31.81
3	4874.00	55.1 PK	74.0	-18.9	1.49 H	196	15.96	39.14
4	4874.00	43.2 AV	54.0	-10.8	1.49 H	196	4.06	39.14
5	7311.00	61.6 PK	74.0	-12.4	1.52 H	27	14.97	46.63
6	7311.00	43.9 AV	54.0	-10.1	1.52 H	27	-2.73	46.63

**ANTENNA POLARITY & TEST DISTANCE: VERTICAL AT 3 M**

NO.	FREQ. (MHz)	EMISSION LEVEL (dBuV/m)	LIMIT (dBuV/m)	MARGIN (dB)	ANTENNA HEIGHT (m)	TABLE ANGLE (Degree)	RAW VALUE (dBuV)	CORRECTION FACTOR (dB/m)
1	*2437.00	111.3 PK			1.34 V	113	79.49	31.81
2	*2437.00	102.1 AV			1.34 V	113	70.29	31.81
3	2483.50	63.3 PK	74.0	-10.7	1.31 V	108	31.33	31.97
4	2483.50	51.2 AV	54.0	-2.8	1.31 V	108	19.23	31.97
5	4874.00	64.8 PK	74.0	-9.2	1.04 V	103	25.66	39.14
6	<b>4874.00</b>	<b>53.5 AV</b>	<b>54.0</b>	<b>-0.5</b>	<b>1.04 V</b>	<b>103</b>	<b>14.36</b>	<b>39.14</b>
7	7311.00	70.6 PK	74.0	-3.4	1.25 V	114	23.97	46.63
8	7311.00	53.0 AV	54.0	-1.0	1.25 V	114	6.37	46.63

- REMARKS:**
1. Emission level (dBuV/m) = Raw Value (dBuV) + Correction Factor (dB/m).
  2. Correction Factor (dB/m) = Antenna Factor (dB/m) + Cable Factor (dB).
  3. The other emission levels were very low against the limit.
  4. Margin value = Emission level – Limit value.
  5. “ \* ”: Fundamental frequency.



A D T

EUT TEST CONDITION		MEASUREMENT DETAIL	
CHANNEL	Channel 11	FREQUENCY RANGE	1 ~ 25GHz
INPUT POWER	120V / 60Hz	DETECTOR FUNCTION	Peak (PK) Average (AV)
ENVIRONMENTAL CONDITIONS	21deg. C, 64%RH 1025 hPa	TESTED BY	Kent Liu

**ANTENNA POLARITY & TEST DISTANCE: HORIZONTAL AT 3 M**

NO.	FREQ. (MHz)	EMISSION LEVEL (dBuV/m)	LIMIT (dBuV/m)	MARGIN (dB)	ANTENNA HEIGHT (m)	TABLE ANGLE (Degree)	RAW VALUE (dBuV)	CORRECTION FACTOR (dB/m)
1	*2462.00	92.8 PK			1.07 H	214	60.91	31.89
2	*2462.00	83.5 AV			1.07 H	214	51.61	31.89
3	2483.50	54.9 PK	74.0	-19.1	1.07 H	214	22.93	31.97
4	2483.50	43.1 AV	54.0	-10.9	1.07 H	214	11.13	31.97
5	4924.00	53.7 PK	74.0	-20.3	1.46 H	108	14.39	39.31
6	4924.00	40.3 AV	54.0	-13.7	1.46 H	108	0.99	39.31
7	7386.00	54.2 PK	74.0	-19.8	1.47 H	210	7.60	46.60
8	7386.00	41.3 AV	54.0	-12.7	1.47 H	210	-5.30	46.60

**ANTENNA POLARITY & TEST DISTANCE: VERTICAL AT 3 M**

NO.	FREQ. (MHz)	EMISSION LEVEL (dBuV/m)	LIMIT (dBuV/m)	MARGIN (dB)	ANTENNA HEIGHT (m)	TABLE ANGLE (Degree)	RAW VALUE (dBuV)	CORRECTION FACTOR (dB/m)
1	*2462.00	107.6 PK			1.31 V	112	75.71	31.89
2	*2462.00	98.3 AV			1.31 V	112	66.41	31.89
3	2483.50	67.6 PK	74.0	-6.4	1.32 V	100	35.63	31.97
4	2483.50	53.3 AV	54.0	-0.7	1.32 V	100	21.33	31.97
5	4924.00	61.8 PK	74.0	-12.2	1.05 V	107	22.49	39.31
6	4924.00	50.2 AV	54.0	-3.8	1.05 V	107	10.89	39.31
7	7386.00	62.6 PK	74.0	-11.4	1.31 V	146	16.00	46.60
8	7386.00	49.3 AV	54.0	-4.7	1.31 V	146	2.70	46.60

- REMARKS:**
1. Emission level (dBuV/m) = Raw Value (dBuV) + Correction Factor (dB/m).
  2. Correction Factor (dB/m) = Antenna Factor (dB/m) + Cable Factor (dB).
  3. The other emission levels were very low against the limit.
  4. Margin value = Emission level – Limit value.
  5. “ \* “: Fundamental frequency.



A D T

RESTRICTED BANDEDGE (802.11g MODE, CH1, HORIZONTAL )

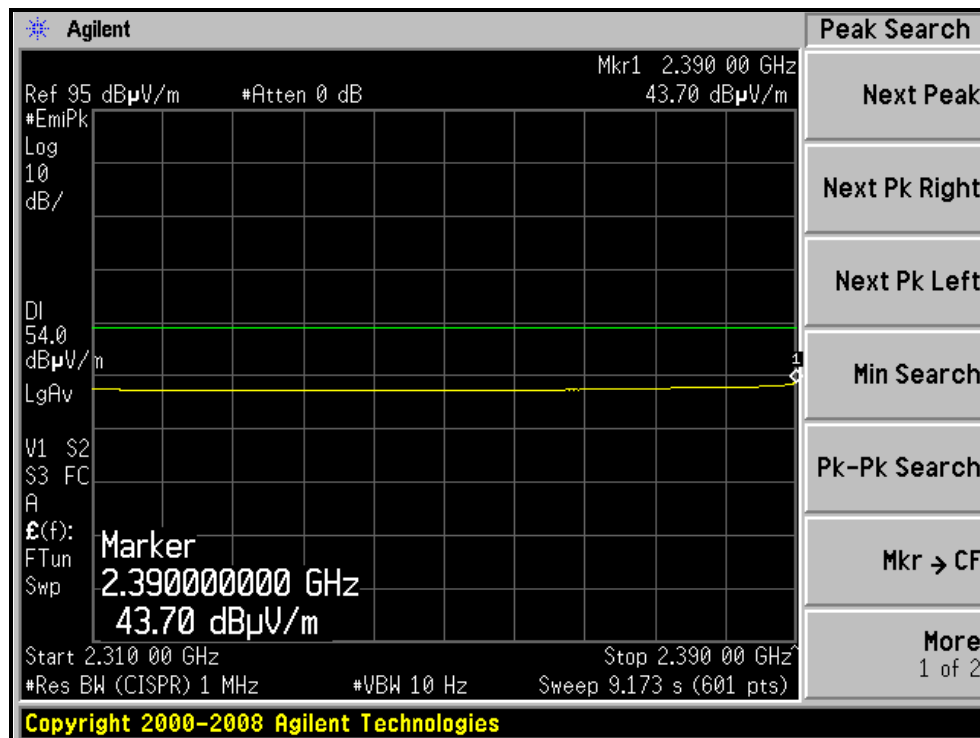
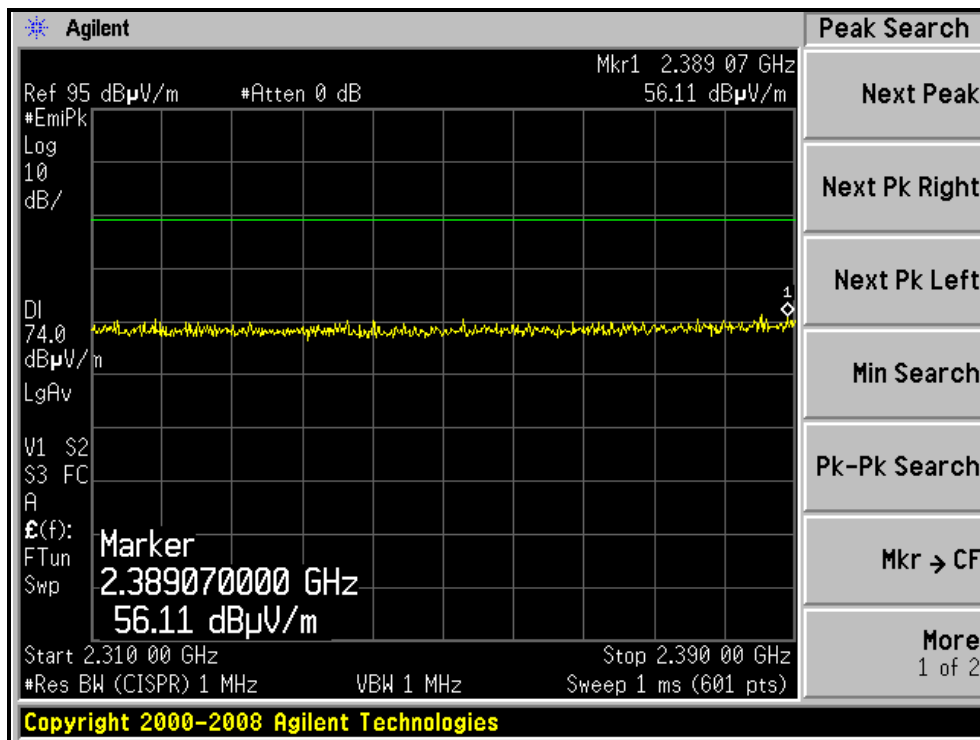



A D T

RESTRICTED BANDEDGE (802.11g MODE,CH1, VERTICAL )

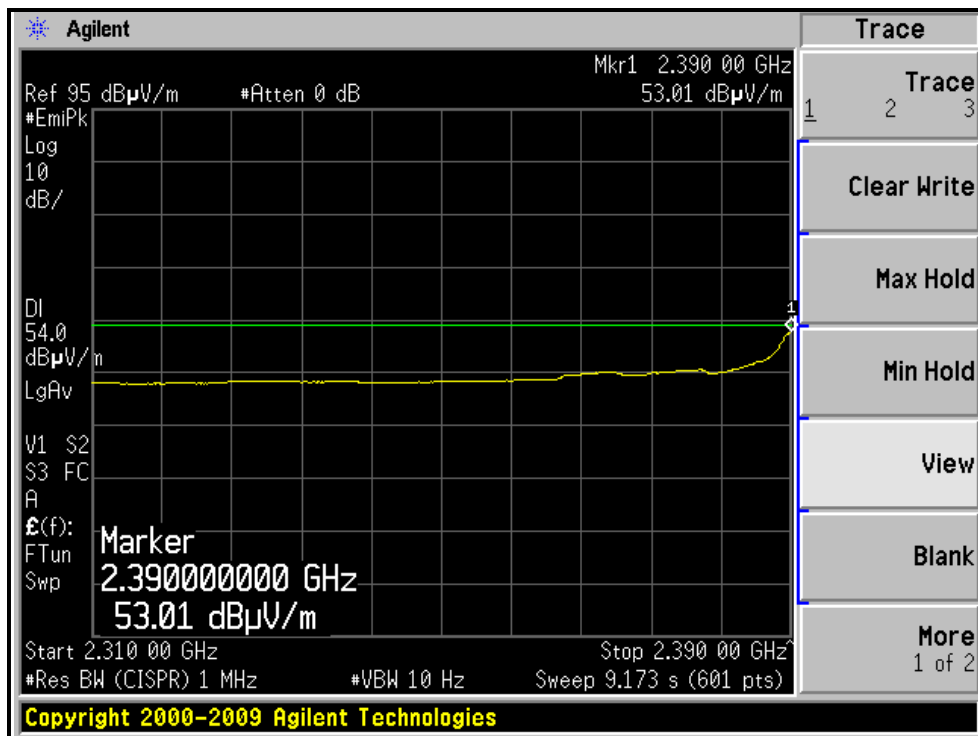
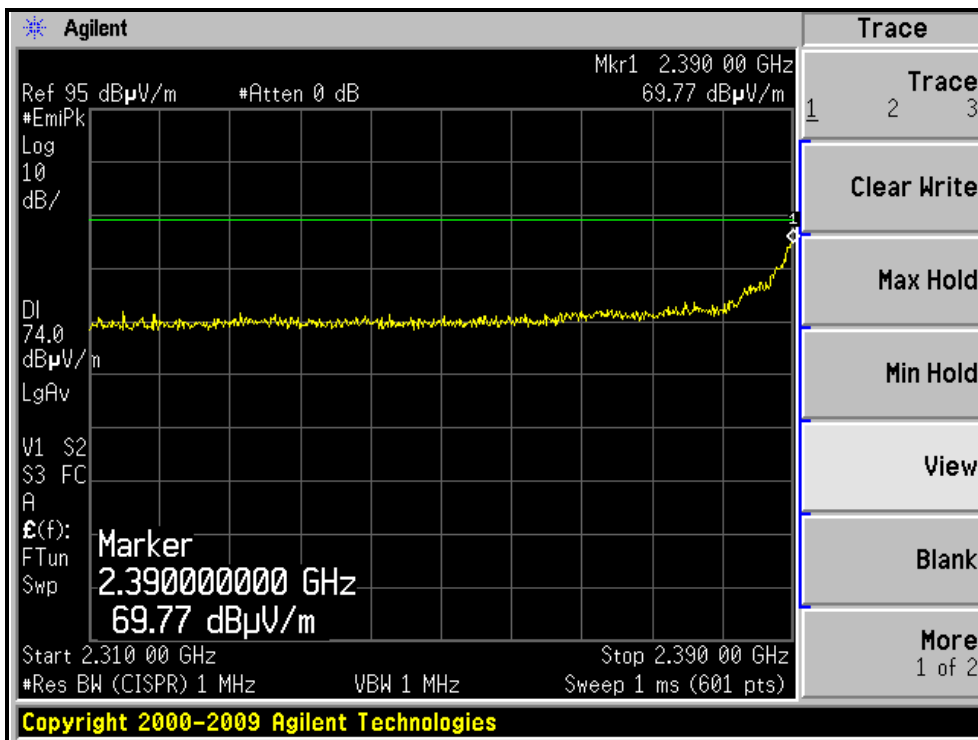

RESTRICTED BANDEDGE (802.11g MODE, CH11, HORIZONTAL )

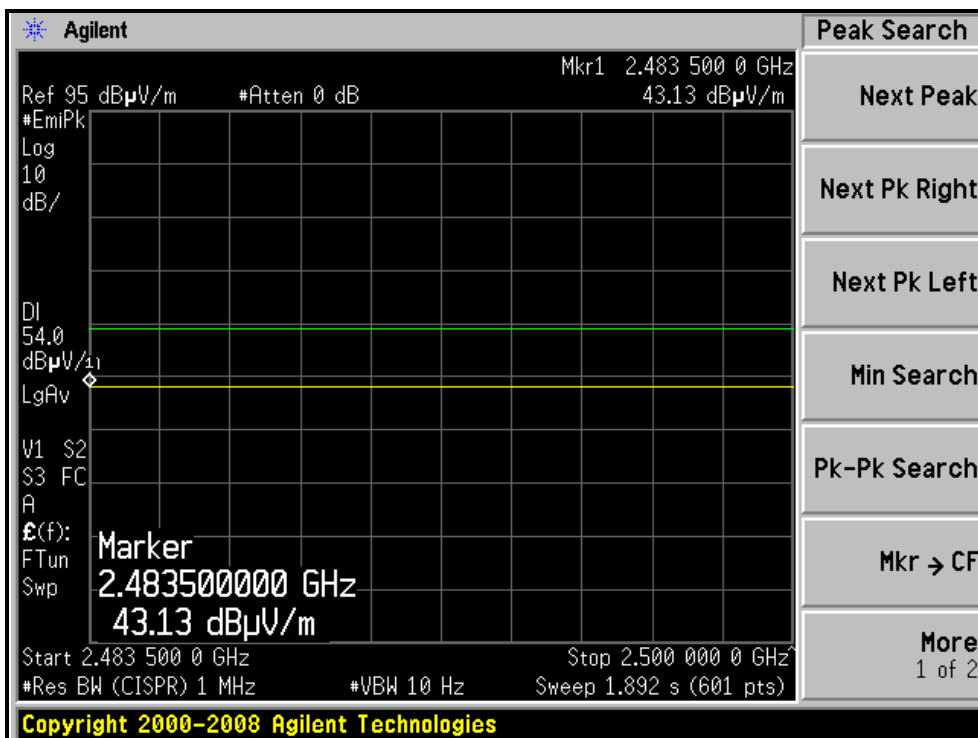
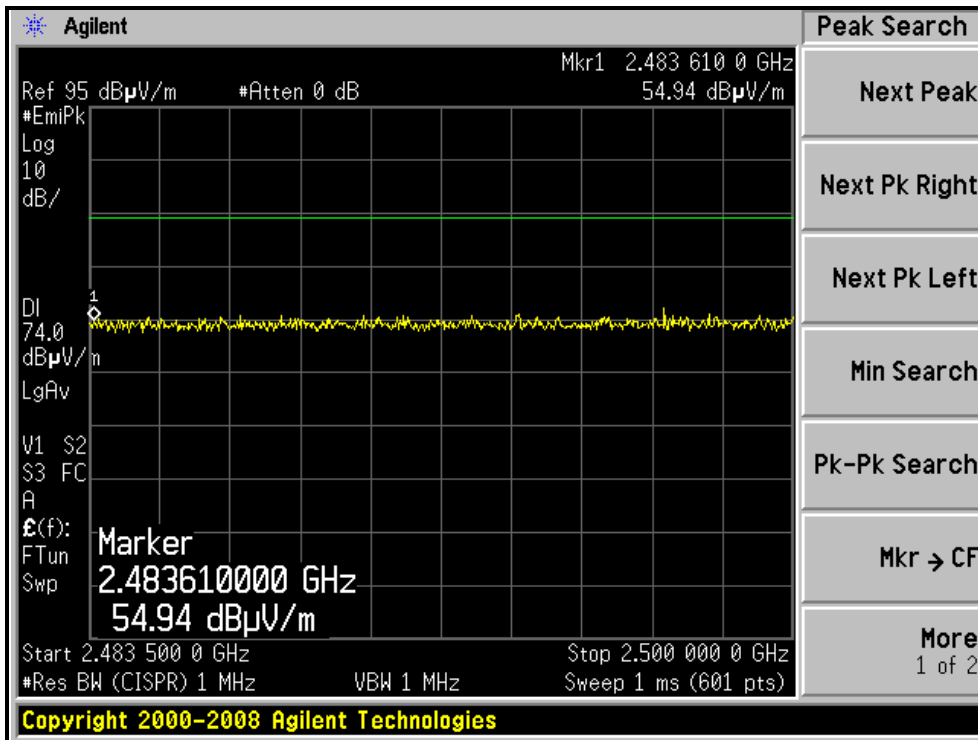

RESTRICTED BANDEDGE (802.11g MODE,CH11, VERTICAL )

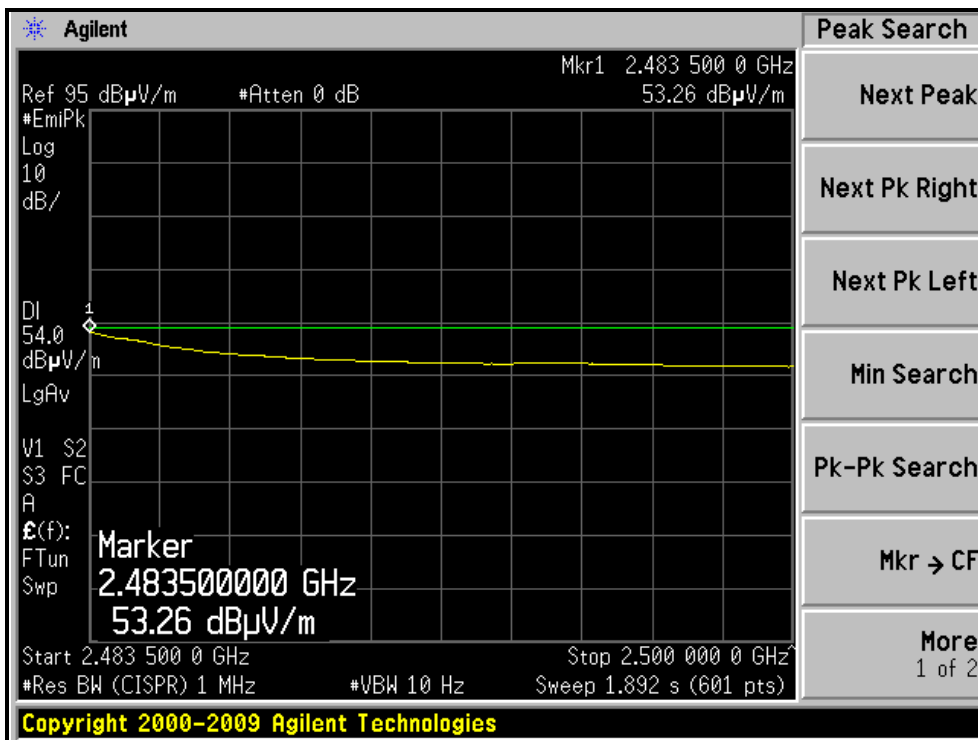
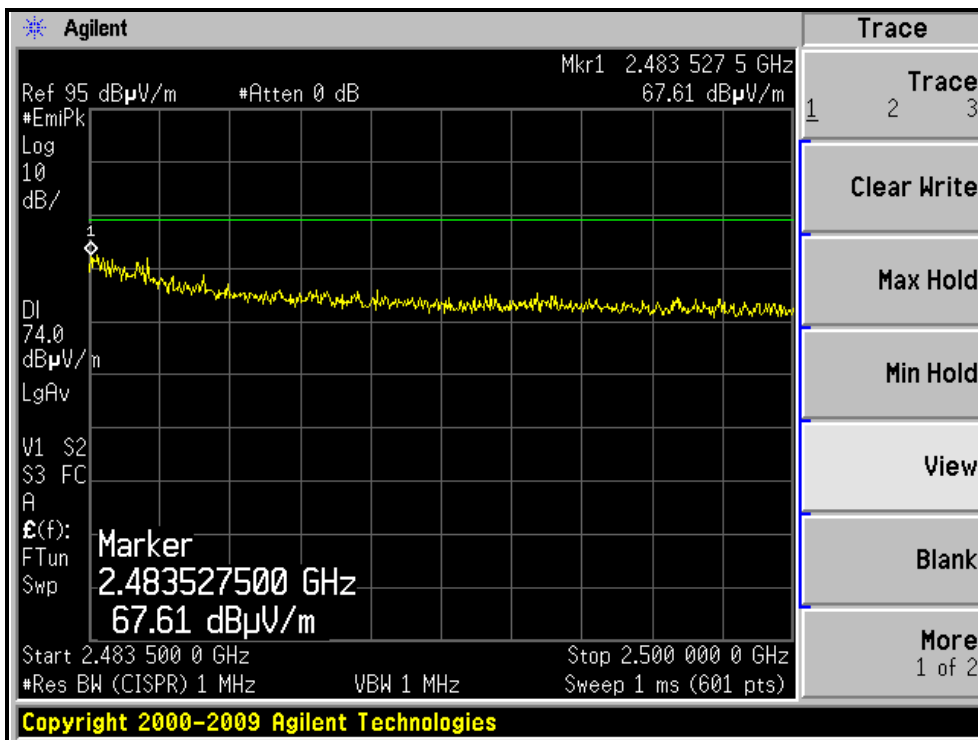





A D T

### 802.11n (20MHz) OFDM MODULATION

EUT TEST CONDITION		MEASUREMENT DETAIL	
CHANNEL	Channel 1	FREQUENCY RANGE	1 ~ 25GHz
INPUT POWER	120V / 60Hz	DETECTOR FUNCTION	Peak (PK) Average (AV)
ENVIRONMENTAL CONDITIONS	21deg. C, 64%RH 1025 hPa	TESTED BY	Kent Liu

ANTENNA POLARITY & TEST DISTANCE: HORIZONTAL AT 3 M								
NO.	FREQ. (MHz)	EMISSION LEVEL (dBuV/m)	LIMIT (dBuV/m)	MARGIN (dB)	ANTENNA HEIGHT (m)	TABLE ANGLE (Degree)	RAW VALUE (dBuV)	CORRECTION FACTOR (dB/m)
1	2390.00	56.9 PK	74.0	-17.1	1.38 H	114	25.24	31.66
2	2390.00	44.4 AV	54.0	-9.6	1.38 H	114	12.74	31.66
3	*2412.00	96.1 PK			1.38 H	114	64.37	31.73
4	*2412.00	85.7 AV			1.38 H	114	53.97	31.73
5	4824.00	58.6 PK	74.0	-15.4	1.45 H	211	19.63	38.97
6	4824.00	45.1 AV	54.0	-8.9	1.45 H	211	6.13	38.97
ANTENNA POLARITY & TEST DISTANCE: VERTICAL AT 3 M								
NO.	FREQ. (MHz)	EMISSION LEVEL (dBuV/m)	LIMIT (dBuV/m)	MARGIN (dB)	ANTENNA HEIGHT (m)	TABLE ANGLE (Degree)	RAW VALUE (dBuV)	CORRECTION FACTOR (dB/m)
1	2390.00	68.0 PK	74.0	-6.0	1.22 V	264	36.34	31.66
2	2390.00	53.3 AV	54.0	-0.7	1.22 V	264	21.64	31.66
3	*2412.00	108.6 PK			1.17 V	278	76.87	31.73
4	*2412.00	98.2 AV			1.17 V	278	66.47	31.73
5	4824.00	68.1 PK	74.0	-5.9	1.06 V	103	29.13	38.97
6	4824.00	53.5 AV	54.0	-0.5	1.06 V	103	14.53	38.97

- REMARKS:**
1. Emission level (dBuV/m) = Raw Value (dBuV) + Correction Factor (dB/m).
  2. Correction Factor (dB/m) = Antenna Factor (dB/m) + Cable Factor (dB).
  3. The other emission levels were very low against the limit.
  4. Margin value = Emission level – Limit value.
  5. “ \* ”: Fundamental frequency.



A D T

EUT TEST CONDITION		MEASUREMENT DETAIL	
CHANNEL	Channel 6	FREQUENCY RANGE	1 ~ 25GHz
INPUT POWER	120V / 60Hz	DETECTOR FUNCTION	Peak (PK) Average (AV)
ENVIRONMENTAL CONDITIONS	21deg. C, 64%RH 1025 hPa	TESTED BY	Kent Liu

**ANTENNA POLARITY & TEST DISTANCE: HORIZONTAL AT 3 M**

NO.	FREQ. (MHz)	EMISSION LEVEL (dBuV/m)	LIMIT (dBuV/m)	MARGIN (dB)	ANTENNA HEIGHT (m)	TABLE ANGLE (Degree)	RAW VALUE (dBuV)	CORRECTION FACTOR (dB/m)
1	*2437.00	97.6 PK			1.36 H	247	65.79	31.81
2	*2437.00	86.2 AV			1.36 H	247	54.39	31.81
3	4874.00	60.2 PK	74.0	-13.8	1.12 H	163	21.06	39.14
4	4874.00	44.4 AV	54.0	-9.6	1.12 H	163	5.26	39.14
5	7311.00	60.9 PK	74.0	-13.1	1.10 H	44	14.27	46.63
6	7311.00	46.6 AV	54.0	-7.4	1.10 H	44	-0.03	46.63

**ANTENNA POLARITY & TEST DISTANCE: VERTICAL AT 3 M**

NO.	FREQ. (MHz)	EMISSION LEVEL (dBuV/m)	LIMIT (dBuV/m)	MARGIN (dB)	ANTENNA HEIGHT (m)	TABLE ANGLE (Degree)	RAW VALUE (dBuV)	CORRECTION FACTOR (dB/m)
1	*2437.00	109.4 PK			1.34 V	248	77.59	31.81
2	*2437.00	98.6 AV			1.34 V	248	66.79	31.81
3	4874.00	67.6 PK	74.0	-6.4	1.08 V	101	28.46	39.14
4	4874.00	53.3 AV	54.0	-0.7	1.08 V	101	14.16	39.14
5	7311.00	63.9 PK	74.0	-10.1	1.27 V	116	17.27	46.63
6	7311.00	51.6 AV	54.0	-2.4	1.27 V	116	4.97	46.63

- REMARKS:**
1. Emission level (dBuV/m) = Raw Value (dBuV) + Correction Factor (dB/m).
  2. Correction Factor (dB/m) = Antenna Factor (dB/m) + Cable Factor (dB).
  3. The other emission levels were very low against the limit.
  4. Margin value = Emission level – Limit value.
  5. “ \* “: Fundamental frequency.



A D T

EUT TEST CONDITION		MEASUREMENT DETAIL	
CHANNEL	Channel 11	FREQUENCY RANGE	1 ~ 25GHz
INPUT POWER	120V / 60Hz	DETECTOR FUNCTION	Peak (PK) Average (AV)
ENVIRONMENTAL CONDITIONS	21deg. C, 64%RH 1025 hPa	TESTED BY	Kent Liu

**ANTENNA POLARITY & TEST DISTANCE: HORIZONTAL AT 3 M**

NO.	FREQ. (MHz)	EMISSION LEVEL (dBuV/m)	LIMIT (dBuV/m)	MARGIN (dB)	ANTENNA HEIGHT (m)	TABLE ANGLE (Degree)	RAW VALUE (dBuV)	CORRECTION FACTOR (dB/m)
1	*2462.00	98.5 PK			1.36 H	249	66.61	31.89
2	*2462.00	86.7 AV			1.36 H	249	54.81	31.89
3	2483.50	60.2 PK	74.0	-13.8	1.36 H	249	28.23	31.97
4	2483.50	45.5 AV	54.0	-8.5	1.36 H	249	13.53	31.97
5	4924.00	59.8 PK	74.0	-14.2	1.71 H	155	20.49	39.31
6	4924.00	45.7 AV	54.0	-8.3	1.71 H	155	6.39	39.31
7	7386.00	61.6 PK	74.0	-12.4	1.44 H	130	15.00	46.60
8	7386.00	47.3 AV	54.0	-6.7	1.44 H	130	0.70	46.60

**ANTENNA POLARITY & TEST DISTANCE: VERTICAL AT 3 M**

NO.	FREQ. (MHz)	EMISSION LEVEL (dBuV/m)	LIMIT (dBuV/m)	MARGIN (dB)	ANTENNA HEIGHT (m)	TABLE ANGLE (Degree)	RAW VALUE (dBuV)	CORRECTION FACTOR (dB/m)
1	*2462.00	109.8 PK			1.34 V	267	77.91	31.89
2	*2462.00	98.5 AV			1.34 V	267	66.61	31.89
3	2483.50	68.3 PK	74.0	-5.7	1.34 V	267	36.33	31.97
4	2483.50	53.4 AV	54.0	-0.6	1.34 V	267	21.43	31.97
5	4924.00	66.4 PK	74.0	-7.6	1.06 V	102	27.09	39.31
6	4924.00	53.1 AV	54.0	-0.9	1.06 V	102	13.79	39.31
7	7386.00	62.2 PK	74.0	-11.8	1.06 V	100	15.60	46.60
8	7386.00	49.0 AV	54.0	-5.0	1.06 V	100	2.40	46.60

- REMARKS:**
1. Emission level (dBuV/m) = Raw Value (dBuV) + Correction Factor (dB/m).
  2. Correction Factor (dB/m) = Antenna Factor (dB/m) + Cable Factor (dB).
  3. The other emission levels were very low against the limit.
  4. Margin value = Emission level – Limit value.
  5. “ \* “: Fundamental frequency.



A D T

RESTRICTED BANDEDGE (802.11n (20MHz) MODE,CH1, HORIZONTAL )

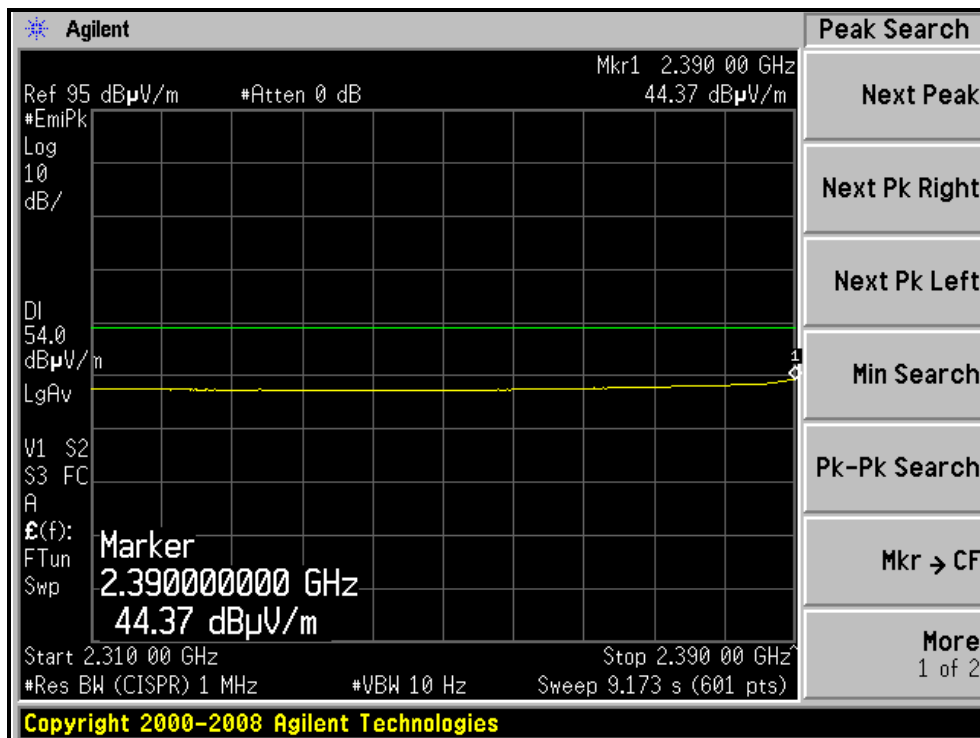
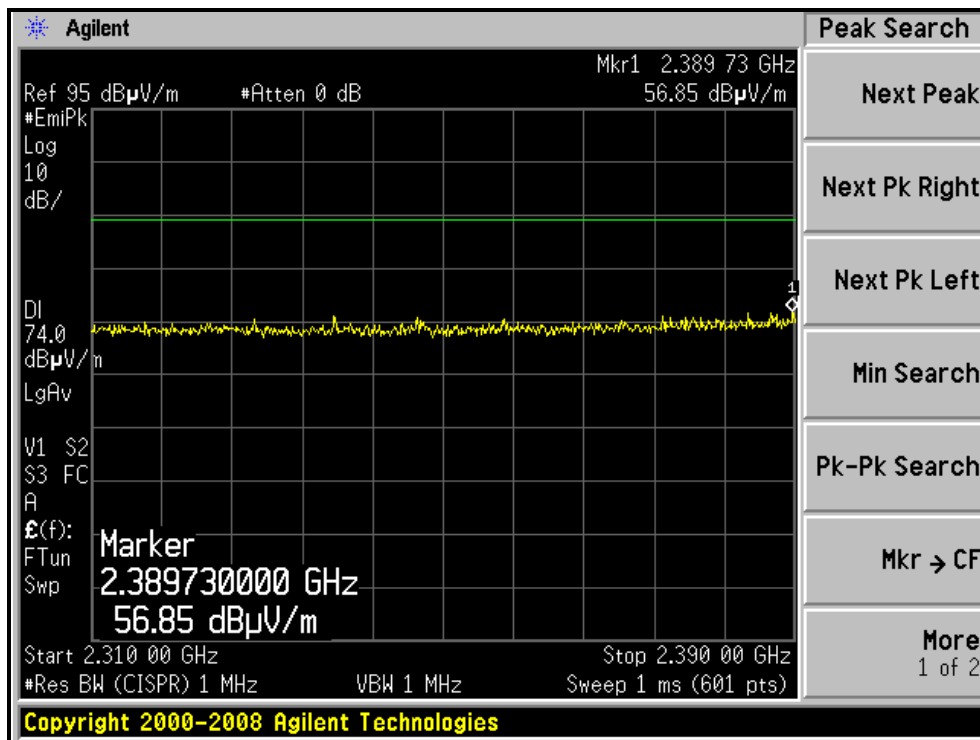



A D T

RESTRICTED BANDEDGE (802.11n (20MHz) MODE,CH1, VERTICAL )

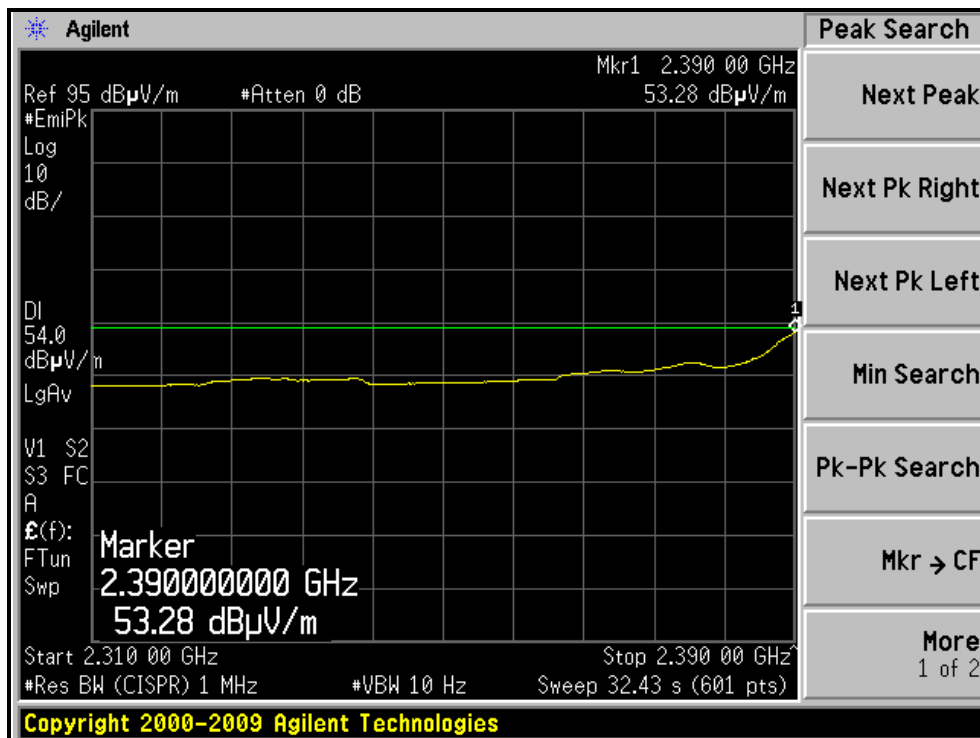
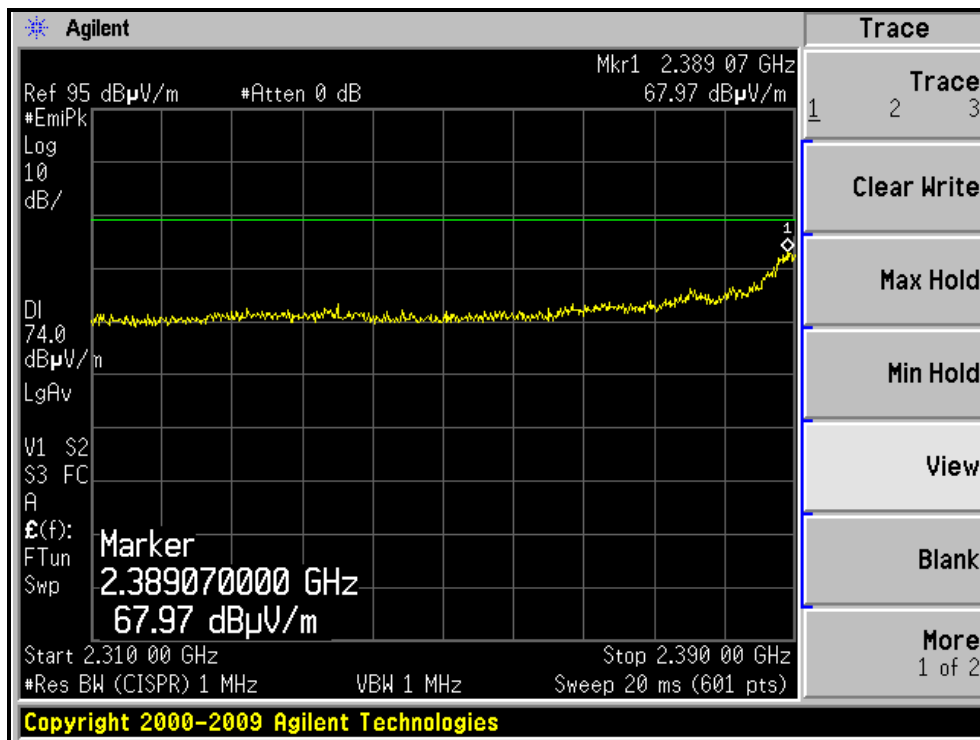



A D T

RESTRICTED BANDEDGE (802.11n (20MHz) MODE,CH11, HORIZONTAL )

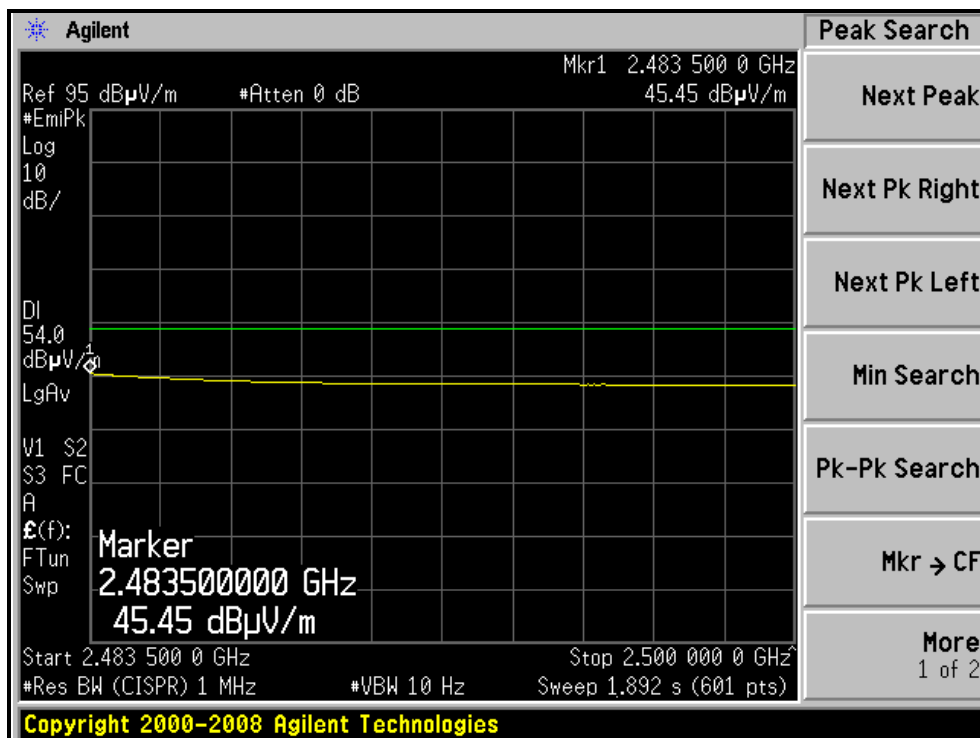
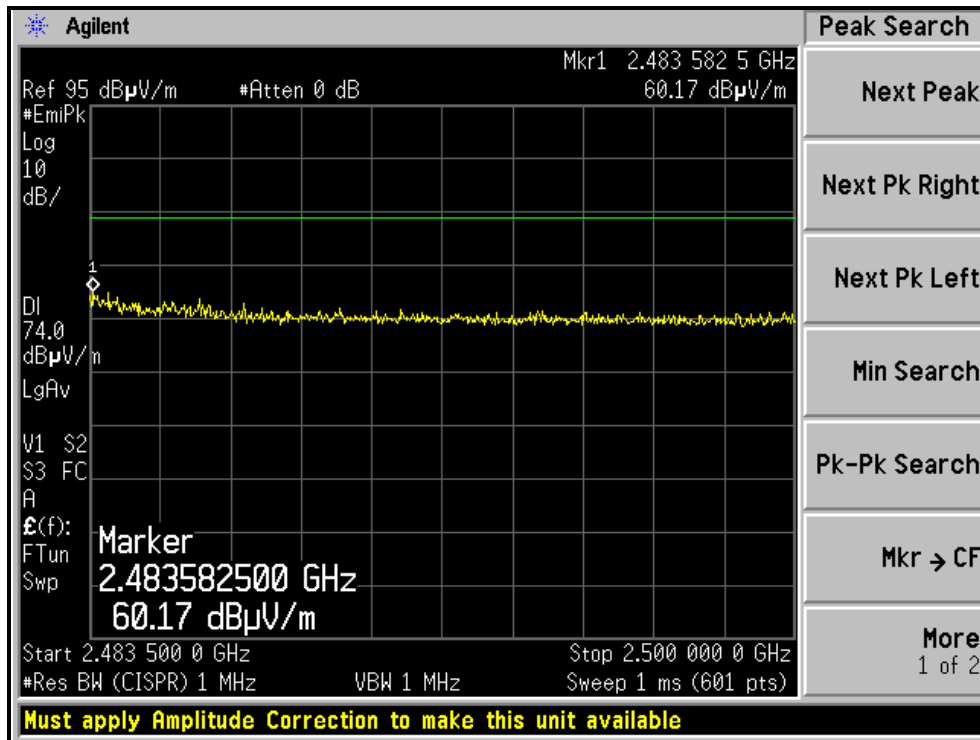



A D T

RESTRICTED BANDEDGE (802.11n (20MHz) MODE,CH11, VERTICAL )

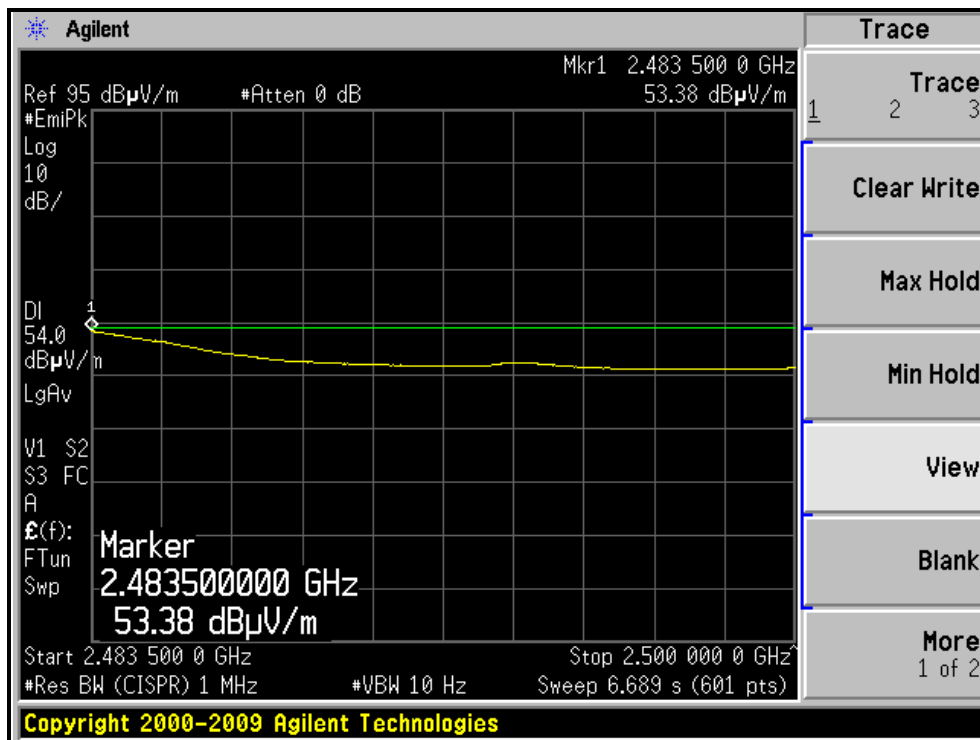
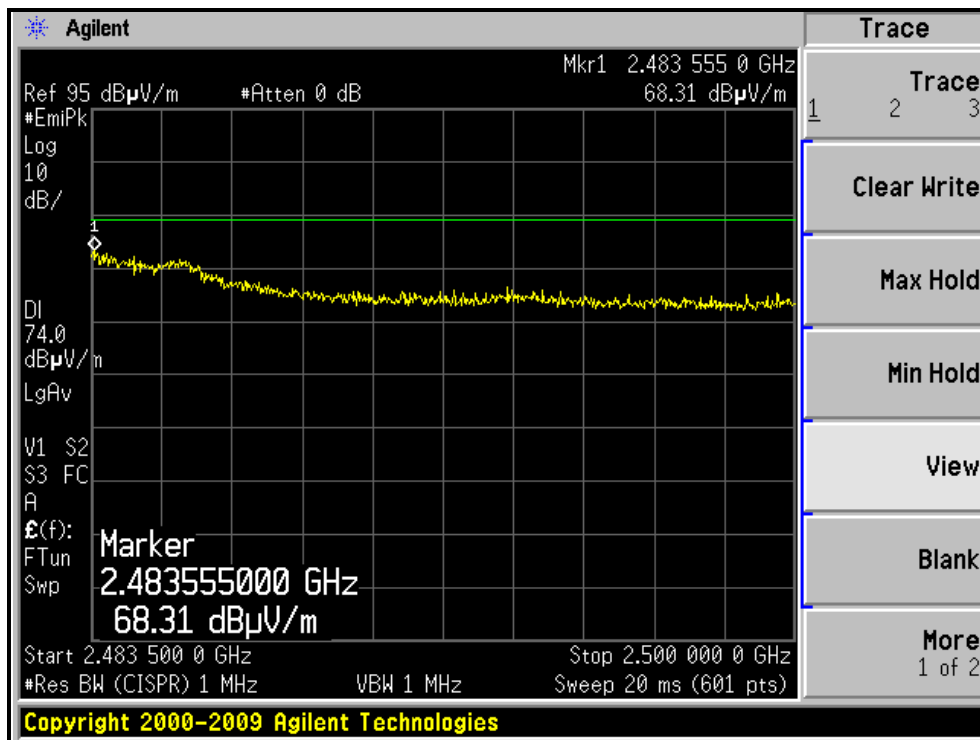



A D T

## 802.11n (40MHz) OFDM MODULATION

EUT TEST CONDITION		MEASUREMENT DETAIL	
CHANNEL	Channel 3	FREQUENCY RANGE	1 ~ 25GHz
INPUT POWER	120V / 60Hz	DETECTOR FUNCTION	Peak (PK) Average (AV)
ENVIRONMENTAL CONDITIONS	21deg. C, 64%RH 1025 hPa	TESTED BY	Kent Liu

ANTENNA POLARITY & TEST DISTANCE: HORIZONTAL AT 3 M								
NO.	FREQ. (MHz)	EMISSION LEVEL (dBuV/m)	LIMIT (dBuV/m)	MARGIN (dB)	ANTENNA HEIGHT (m)	TABLE ANGLE (Degree)	RAW VALUE (dBuV)	CORRECTION FACTOR (dB/m)
1	2390.00	60.8 PK	74.0	-13.2	1.38 H	114	29.14	31.66
2	2390.00	45.5 AV	54.0	-8.5	1.38 H	114	13.84	31.66
3	*2422.00	93.8 PK			1.38 H	114	62.04	31.76
4	*2422.00	82.7 AV			1.38 H	114	50.94	31.76
5	4844.00	58.7 PK	74.0	-15.3	1.15 H	171	19.66	39.04
6	4844.00	44.6 AV	54.0	-9.4	1.15 H	171	5.56	39.04
7	7266.00	58.6 PK	74.0	-15.4	1.12 H	44	11.93	46.67
8	7266.00	45.6 AV	54.0	-8.4	1.12 H	44	-1.07	46.67
ANTENNA POLARITY & TEST DISTANCE: VERTICAL AT 3 M								
NO.	FREQ. (MHz)	EMISSION LEVEL (dBuV/m)	LIMIT (dBuV/m)	MARGIN (dB)	ANTENNA HEIGHT (m)	TABLE ANGLE (Degree)	RAW VALUE (dBuV)	CORRECTION FACTOR (dB/m)
1	2390.00	65.9 PK	74.0	-8.1	1.18 V	214	34.24	31.66
2	2390.00	53.1 AV	54.0	-0.9	1.18 V	214	21.44	31.66
3	*2422.00	104.7 PK			1.18 V	218	72.94	31.76
4	*2422.00	94.8 AV			1.18 V	218	63.04	31.76
5	4844.00	64.7 PK	74.0	-9.3	1.10 V	102	25.66	39.04
6	4844.00	52.2 AV	54.0	-1.8	1.10 V	102	13.16	39.04
7	7266.00	60.8 PK	74.0	-13.2	1.32 V	143	14.13	46.67
8	7266.00	47.6 AV	54.0	-6.4	1.32 V	143	0.93	46.67

- REMARKS:**
1. Emission level (dBuV/m) = Raw Value (dBuV) + Correction Factor (dB/m).
  2. Correction Factor (dB/m) = Antenna Factor (dB/m) + Cable Factor (dB).
  3. The other emission levels were very low against the limit.
  4. Margin value = Emission level – Limit value.
  5. “ \* “: Fundamental frequency.





A D T

EUT TEST CONDITION		MEASUREMENT DETAIL	
CHANNEL	Channel 6	FREQUENCY RANGE	1 ~ 25GHz
INPUT POWER	120V / 60Hz	DETECTOR FUNCTION	Peak (PK) Average (AV)
ENVIRONMENTAL CONDITIONS	21deg. C, 64%RH 1025 hPa	TESTED BY	Kent Liu

ANTENNA POLARITY & TEST DISTANCE: HORIZONTAL AT 3 M								
NO.	FREQ. (MHz)	EMISSION LEVEL (dBuV/m)	LIMIT (dBuV/m)	MARGIN (dB)	ANTENNA HEIGHT (m)	TABLE ANGLE (Degree)	RAW VALUE (dBuV)	CORRECTION FACTOR (dB/m)
1	*2437.00	95.4 PK			1.36 H	246	63.59	31.81
2	*2437.00	84.6 AV			1.36 H	246	52.79	31.81
3	4874.00	57.0 PK	74.0	-17.0	1.13 H	162	17.86	39.14
4	4874.00	41.8 AV	54.0	-12.2	1.13 H	162	2.66	39.14
5	7311.00	59.9 PK	74.0	-14.1	1.09 H	43	13.27	46.63
6	7311.00	46.5 AV	54.0	-7.5	1.09 H	43	-0.13	46.63
ANTENNA POLARITY & TEST DISTANCE: VERTICAL AT 3 M								
NO.	FREQ. (MHz)	EMISSION LEVEL (dBuV/m)	LIMIT (dBuV/m)	MARGIN (dB)	ANTENNA HEIGHT (m)	TABLE ANGLE (Degree)	RAW VALUE (dBuV)	CORRECTION FACTOR (dB/m)
1	*2437.00	108.8 PK			1.19 V	266	76.99	31.81
2	*2437.00	98.3 AV			1.19 V	266	66.49	31.81
3	4874.00	65.7 PK	74.0	-8.3	1.09 V	104	26.56	39.14
4	4874.00	53.1 AV	54.0	-0.9	1.09 V	104	13.96	39.14
5	7311.00	64.2 PK	74.0	-9.8	1.47 V	97	17.57	46.63
6	7311.00	50.4 AV	54.0	-3.6	1.47 V	97	3.77	46.63

- REMARKS:**
1. Emission level (dBuV/m) = Raw Value (dBuV) + Correction Factor (dB/m).
  2. Correction Factor (dB/m) = Antenna Factor (dB/m) + Cable Factor (dB).
  3. The other emission levels were very low against the limit.
  4. Margin value = Emission level – Limit value.
  5. “ \* “: Fundamental frequency.



A D T

EUT TEST CONDITION		MEASUREMENT DETAIL	
CHANNEL	Channel 9	FREQUENCY RANGE	1 ~ 25GHz
INPUT POWER	120V / 60Hz	DETECTOR FUNCTION	Peak (PK) Average (AV)
ENVIRONMENTAL CONDITIONS	21deg. C, 64%RH 1025 hPa	TESTED BY	Kent Liu

**ANTENNA POLARITY & TEST DISTANCE: HORIZONTAL AT 3 M**

NO.	FREQ. (MHz)	EMISSION LEVEL (dBuV/m)	LIMIT (dBuV/m)	MARGIN (dB)	ANTENNA HEIGHT (m)	TABLE ANGLE (Degree)	RAW VALUE (dBuV)	CORRECTION FACTOR (dB/m)
1	*2452.00	92.5 PK			1.38 H	112	60.64	31.86
2	*2452.00	81.2 AV			1.38 H	112	49.34	31.86
3	2483.50	58.8 PK	74.0	-15.2	1.38 H	112	26.83	31.97
4	2483.50	45.5 AV	54.0	-8.5	1.38 H	112	13.53	31.97
5	4904.00	55.1 PK	74.0	-18.9	1.58 H	136	15.86	39.24
6	4904.00	41.6 AV	54.0	-12.4	1.58 H	136	2.36	39.24
7	7356.00	57.4 PK	74.0	-16.6	1.50 H	130	10.79	46.61
8	7356.00	42.9 AV	54.0	-11.1	1.50 H	130	-3.71	46.61

**ANTENNA POLARITY & TEST DISTANCE: VERTICAL AT 3 M**

NO.	FREQ. (MHz)	EMISSION LEVEL (dBuV/m)	LIMIT (dBuV/m)	MARGIN (dB)	ANTENNA HEIGHT (m)	TABLE ANGLE (Degree)	RAW VALUE (dBuV)	CORRECTION FACTOR (dB/m)
1	*2452.00	103.6 PK			1.19 V	262	71.74	31.86
2	*2452.00	94.1 AV			1.19 V	262	62.24	31.86
3	2483.50	67.2 PK	74.0	-6.8	1.19 V	262	35.23	31.97
4	2483.50	53.0 AV	54.0	-1.0	1.19 V	262	21.03	31.97
5	4904.00	60.7 PK	74.0	-13.3	1.07 V	106	21.46	39.24
6	4904.00	48.1 AV	54.0	-5.9	1.07 V	106	8.86	39.24
7	7356.00	61.4 PK	74.0	-12.6	1.04 V	121	14.79	46.61
8	7356.00	48.2 AV	54.0	-5.8	1.04 V	121	1.59	46.61

- REMARKS:**
1. Emission level (dBuV/m) = Raw Value (dBuV) + Correction Factor (dB/m).
  2. Correction Factor (dB/m) = Antenna Factor (dB/m) + Cable Factor (dB).
  3. The other emission levels were very low against the limit.
  4. Margin value = Emission level – Limit value.
  5. “ \* “: Fundamental frequency.



A D T

RESTRICTED BANDEDGE (802.11n (40MHz) MODE,CH3, HORIZONTAL )

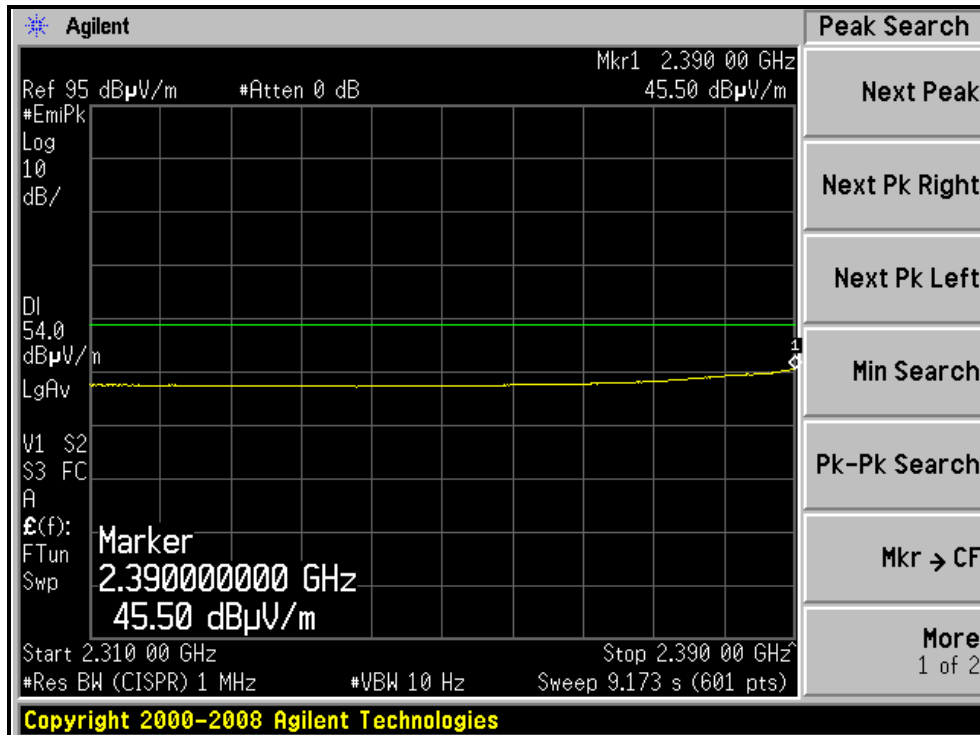
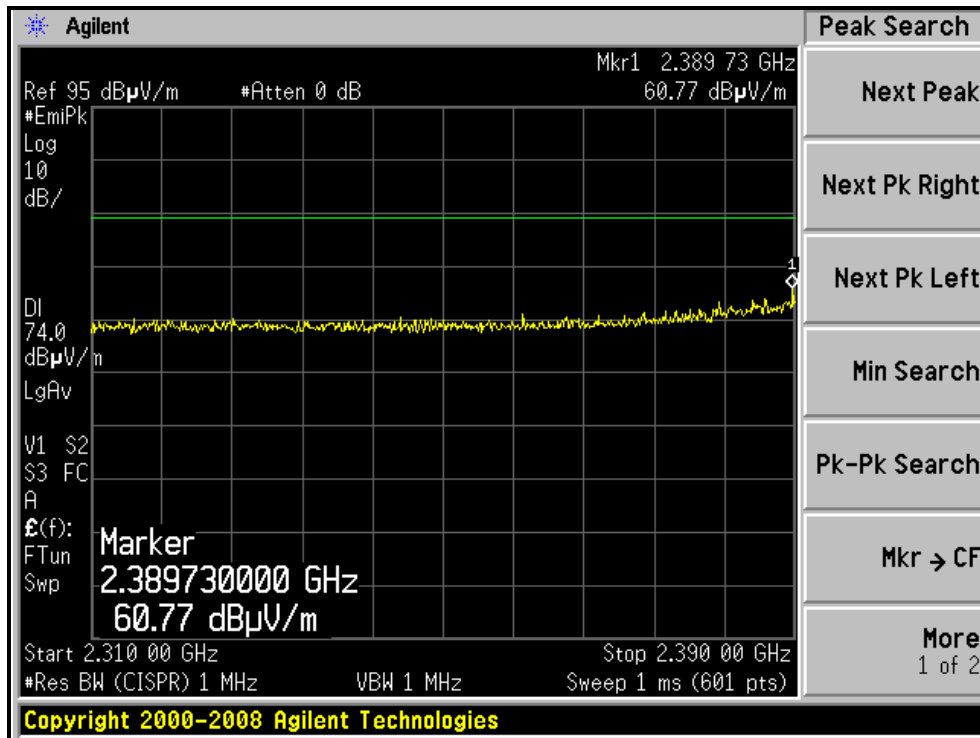



A D T

RESTRICTED BANDEDGE (802.11n (40MHz) MODE,CH3, VERTICAL )

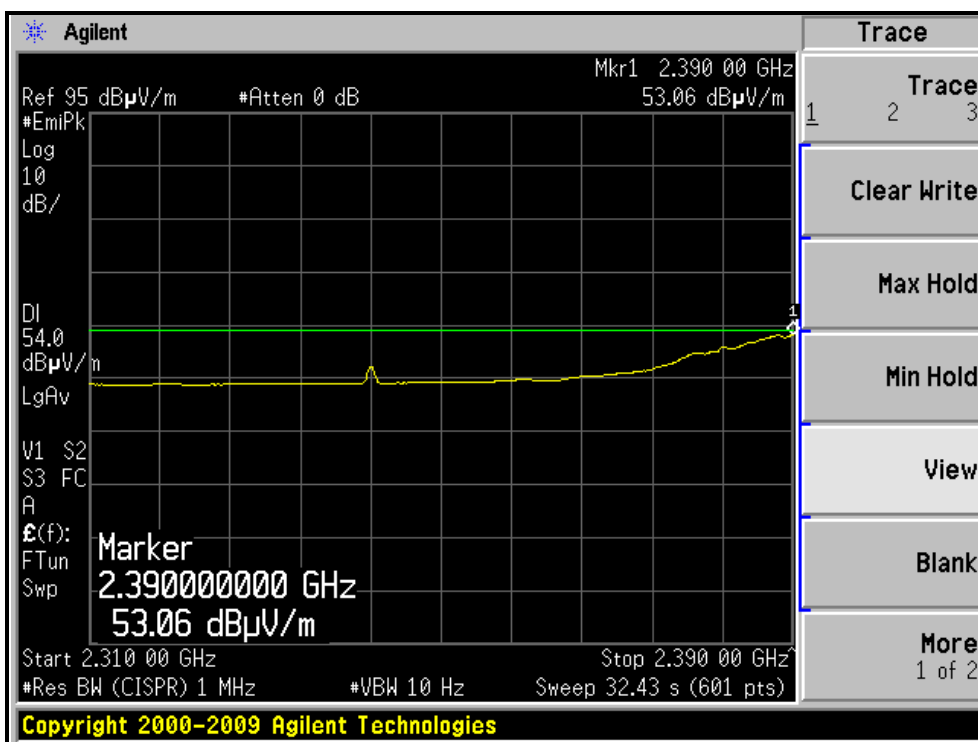
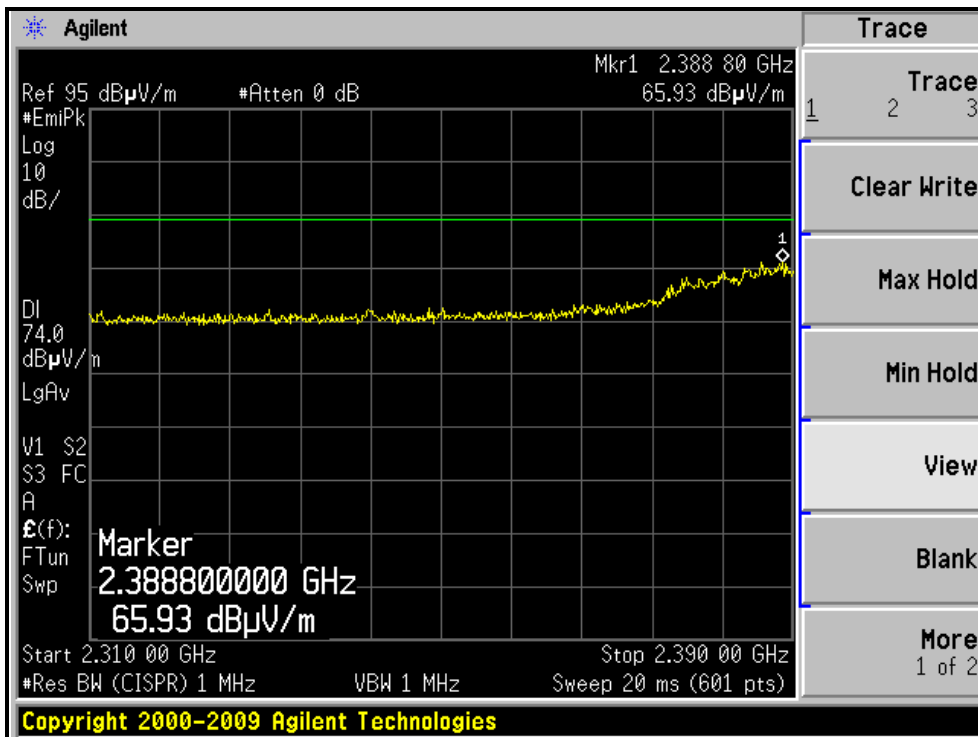



A D T

RESTRICTED BANDEDGE (802.11n (40MHz) MODE,CH9, HORIZONTAL )

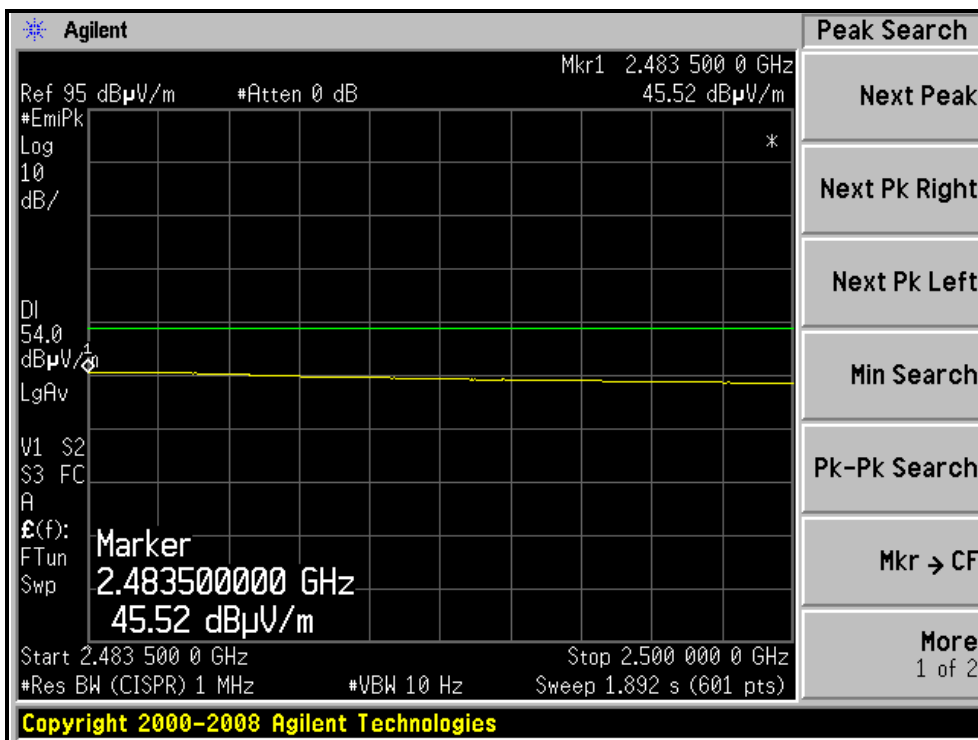
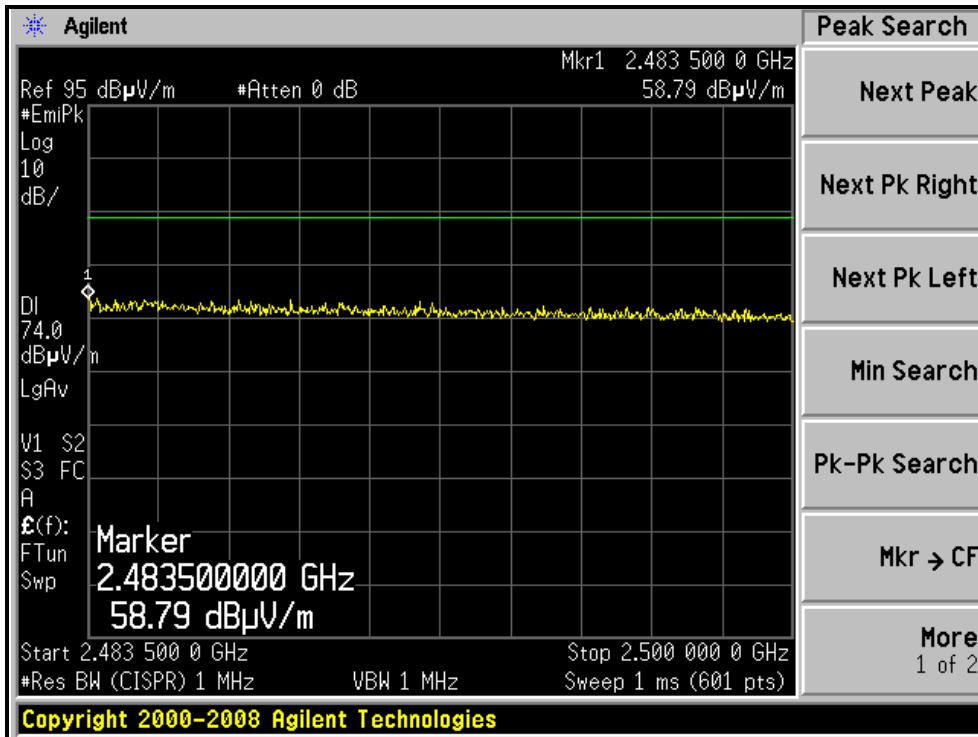



A D T

RESTRICTED BANDEDGE (802.11n (40MHz) MODE,CH9, VERTICAL )

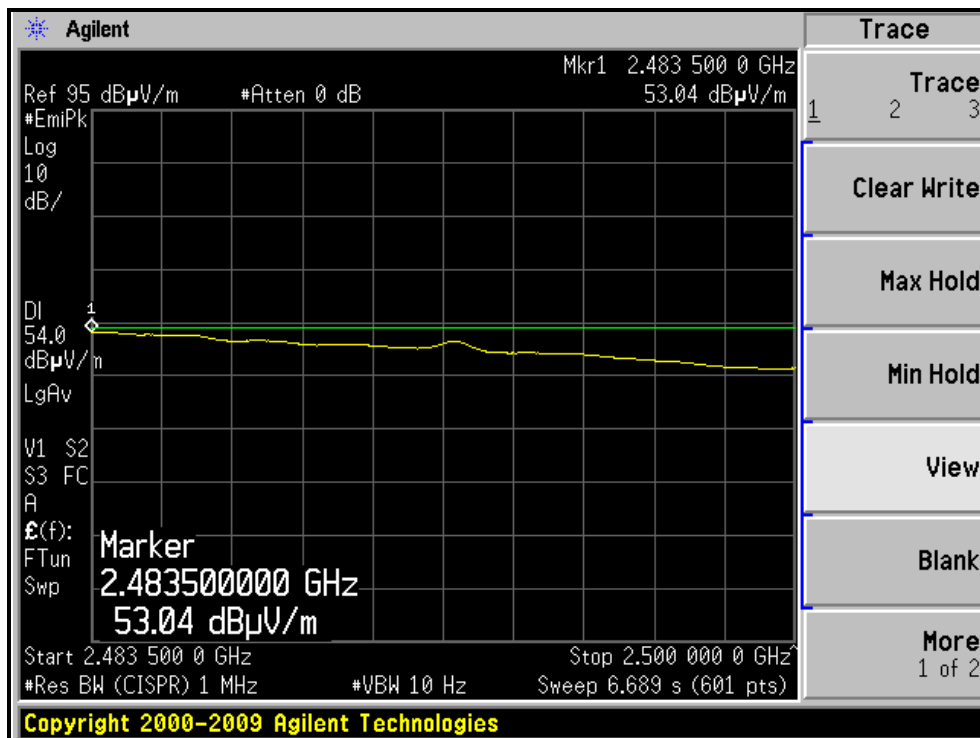
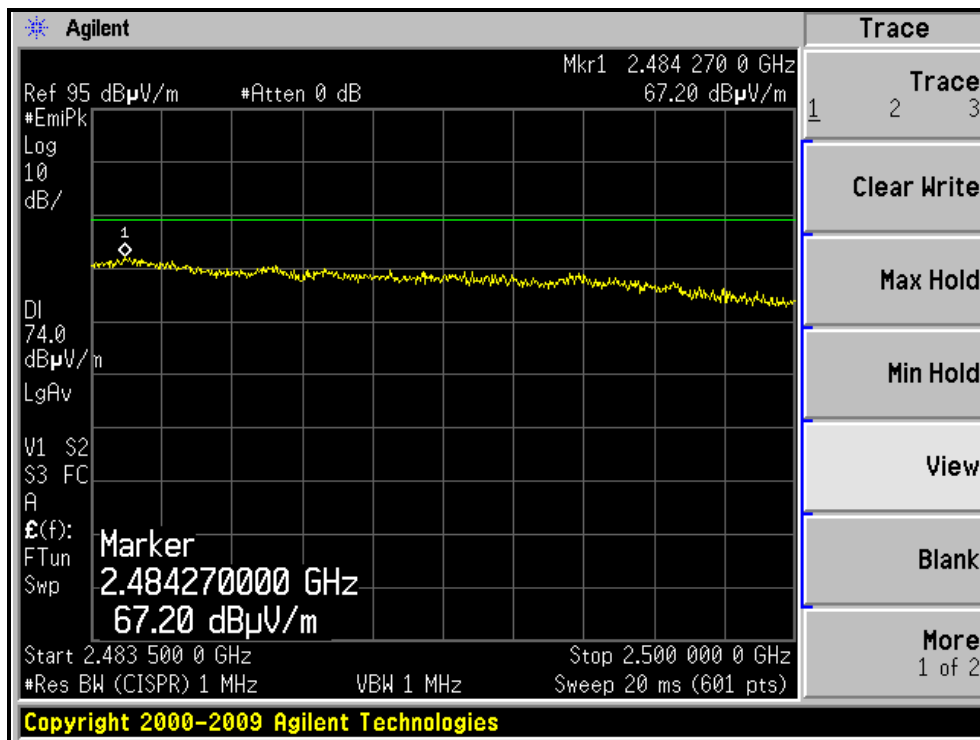

### 4.3 6dB BANDWIDTH MEASUREMENT

#### 4.3.1 LIMITS OF 6dB BANDWIDTH MEASUREMENT

The minimum of 6dB Bandwidth Measurement is 0.5 MHz.

#### 4.3.2 TEST INSTRUMENTS

DESCRIPTION & MANUFACTURER	MODEL NO.	SERIAL NO.	CALIBRATED DATE	CALIBRATED UNTIL
R&S SPECTRUM ANALYZER	FSP 40	100060	May 17, 2010	May 16, 2011

**NOTE:**

1. The calibration interval of the above test instruments is 12 months and the calibrations are traceable to NML/ROC and NIST/USA.

#### 4.3.3 TEST PROCEDURE

The transmitter output was connected to the spectrum analyzer through an attenuator. The bandwidth of the fundamental frequency was measured by spectrum analyzer with 100kHz RBW and 300kHz VBW. The 6dB bandwidth is defined as the total spectrum the power of which is higher than peak power minus 6dB.

#### 4.3.4 DEVIATION FROM TEST STANDARD

No deviation

#### 4.3.5 TEST SETUP



#### 4.3.6 EUT OPERATING CONDITIONS

The software provided by client to enable the EUT under transmission condition continuously at lowest, middle and highest channel frequencies individually.

### 4.3.7 TEST RESULTS

#### 802.11b DSSS MODULATION:

CHANNEL	CHANNEL FREQUENCY (MHz)	6dB BANDWIDTH (MHz)	MINIMUM LIMIT (MHz)	PASS / FAIL
1	2412	10.10	0.5	PASS
6	2437	10.13	0.5	PASS
11	2462	10.11	0.5	PASS

#### CH6

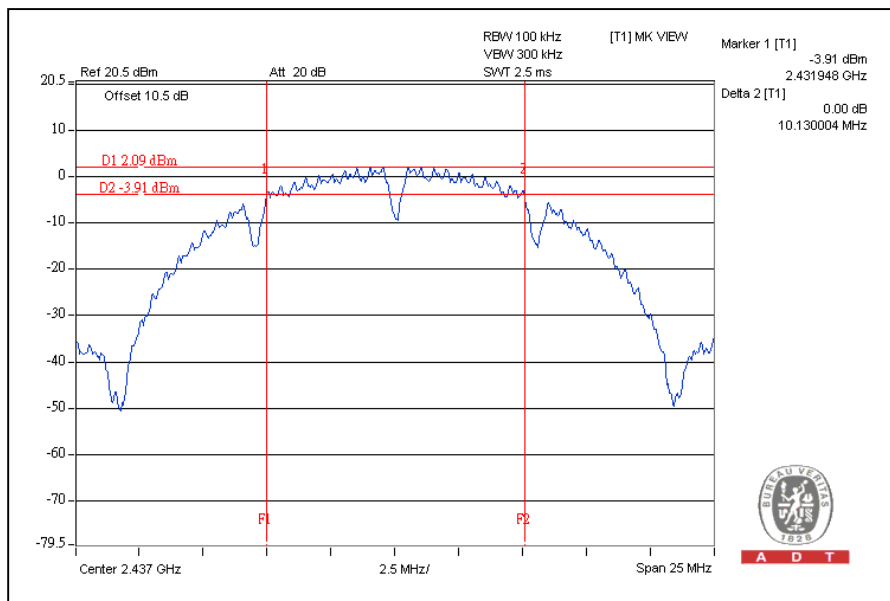





A D T

### 802.11g OFDM MODULATION:

CHANNEL	CHANNEL FREQUENCY (MHz)	6dB BANDWIDTH (MHz)	MINIMUM LIMIT (MHz)	PASS / FAIL
1	2412	16.58	0.5	PASS
6	2437	16.61	0.5	PASS
11	2462	16.56	0.5	PASS

### CH6

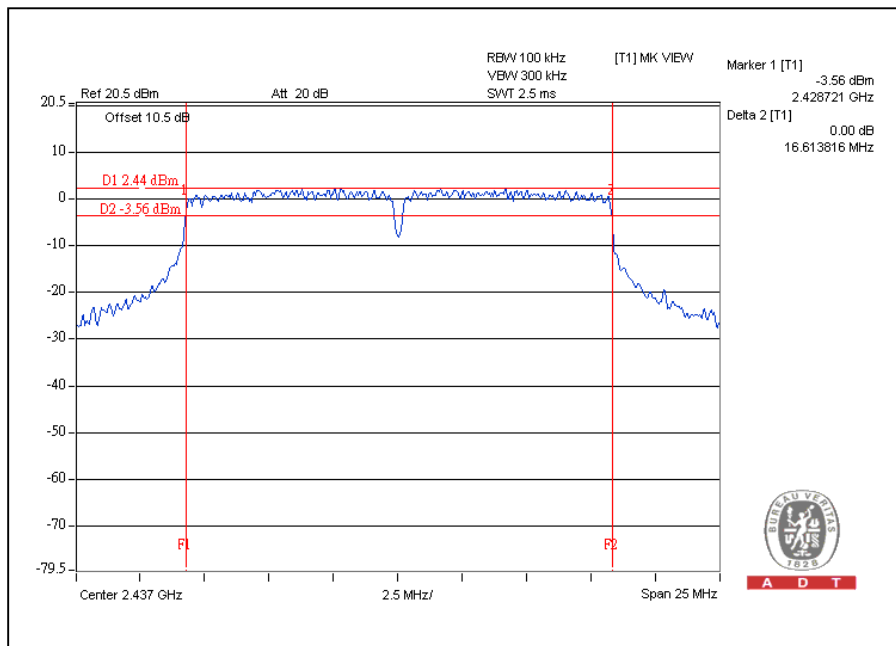



A D T

### 802.11n (20MHz) OFDM MODULATION:

CHANNEL	CHANNEL FREQUENCY (MHz)	6dB BANDWIDTH (MHz)	MINIMUM LIMIT (MHz)	PASS / FAIL
1	2412	17.83	0.5	PASS
6	2437	17.79	0.5	PASS
11	2462	17.73	0.5	PASS

CH1

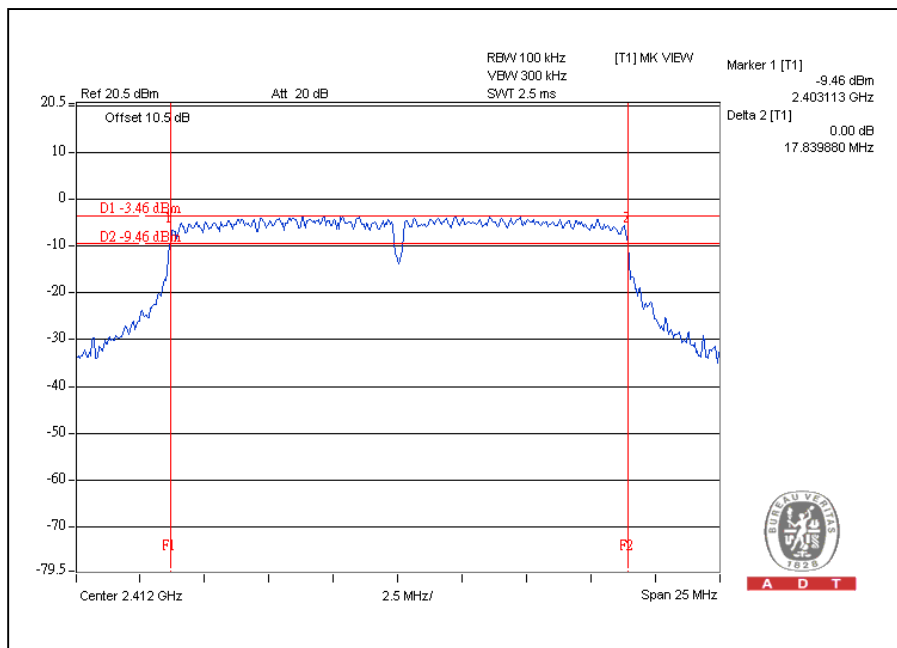



A D T

### 802.11n (40MHz) OFDM MODULATION:

CHANNEL	CHANNEL FREQUENCY (MHz)	6dB BANDWIDTH (MHz)	MINIMUM LIMIT (MHz)	PASS / FAIL
3	2422	36.50	0.5	PASS
6	2437	36.52	0.5	PASS
9	2452	36.55	0.5	PASS

CH9

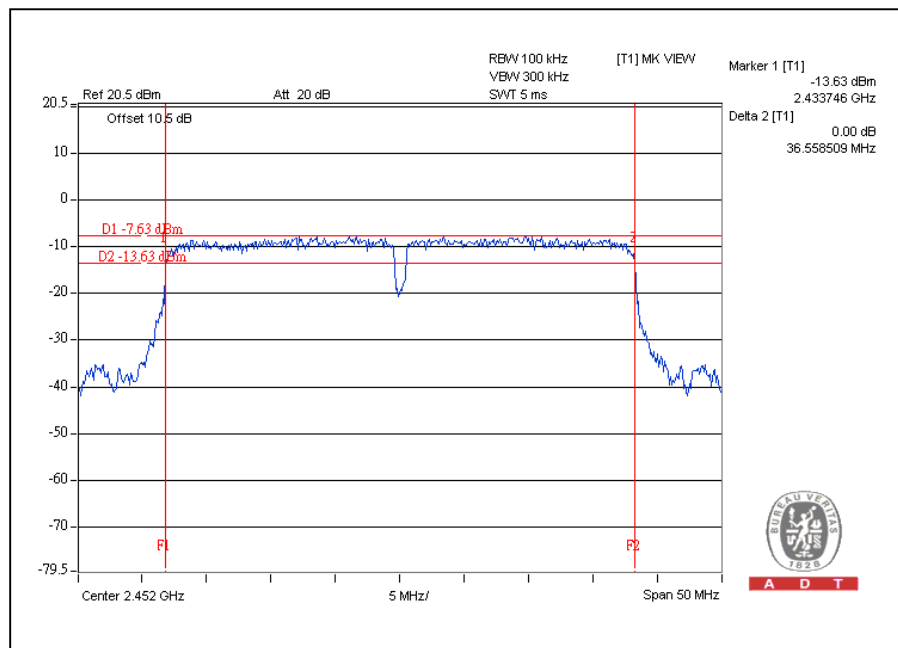



A D T

#### 4.4 MAXIMUM PEAK OUTPUT POWER

##### 4.4.1 LIMITS OF MAXIMUM PEAK OUTPUT POWER MEASUREMENT

The Maximum Peak Output Power Measurement is 30dBm.

##### 4.4.2 INSTRUMENTS

DESCRIPTION & MANUFACTURER	MODEL NO.	SERIAL NO.	CALIBRATED DATE	CALIBRATED UNTIL
Anritsu Power Meter	ML2495A	0824006	May 04, 2010	May 03, 2011
Pulse Power Sensor	MA2411B	0738172	May 04, 2010	May 03, 2011

**NOTE:**

The calibration interval of the above test instruments is 12 months and the calibrations are traceable to NML/ROC and NIST/USA.

##### 4.4.3 TEST PROCEDURES

1. The transmitter output was connected to the power meter through an attenuator; the bandwidth of the fundamental frequency was measured with the power meter.
2. Record the power level.

##### 4.4.4 DEVIATION FROM TEST STANDARD

No deviation

##### 4.4.5 TEST SETUP

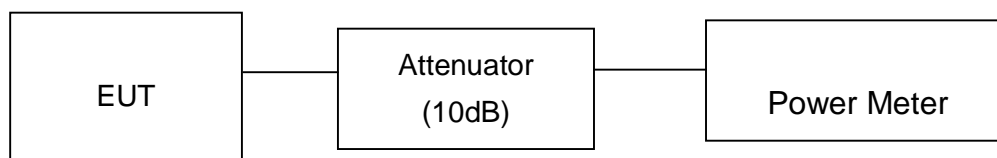

##### 4.4.6 EUT OPERATING CONDITIONS

Same as Item 4.3.6



A D T

#### 4.4.7 TEST RESULTS

##### 802.11b DSSS MODULATION:

CHANNEL	CHANNEL FREQUENCY (MHz)	PEAK POWER OUTPUT (mW)	PEAK POWER OUTPUT (dBm)	PEAK POWER LIMIT (dBm)	PASS / FAIL
1	2412	45.7	16.6	30	PASS
6	2437	41.7	16.2	30	PASS
11	2462	38.0	15.8	30	PASS

##### 802.11g OFDM MODULATION:

CHANNEL	CHANNEL FREQUENCY (MHz)	PEAK POWER OUTPUT (mW)	PEAK POWER OUTPUT (dBm)	PEAK POWER LIMIT (dBm)	PASS / FAIL
1	2412	562.3	27.5	30	PASS
6	2437	912.0	29.6	30	PASS
11	2462	309.0	24.9	30	PASS

##### 802.11n (20MHz) OFDM MODULATION:

CHANNEL	CHANNEL FREQUENCY (MHz)	PEAK POWER OUTPUT (dBm)		TOTAL PEAK POWER (mW)	TOTAL PEAK POWER (dBm)	PEAK POWER LIMIT (dBm)	PASS / FAIL
		CHAIN(0)	CHAIN(1)				
1	2412	19.9	20.1	200.1	23.0	30	PASS
6	2437	20.1	19.3	187.4	22.7	30	PASS
11	2462	21.6	19.2	227.7	23.6	30	PASS

##### 802.11n (40MHz) OFDM MODULATION:

CHANNEL	CHANNEL FREQUENCY (MHz)	PEAK POWER OUTPUT (dBm)		TOTAL PEAK POWER (mW)	TOTAL PEAK POWER (dBm)	PEAK POWER LIMIT (dBm)	PASS / FAIL
		CHAIN(0)	CHAIN(1)				
3	2422	20.3	20.4	216.8	23.4	30	PASS
6	2437	21.8	21.1	280.2	24.5	30	PASS
9	2452	19.1	17.4	136.2	21.3	30	PASS

## 4.5 POWER SPECTRAL DENSITY MEASUREMENT

### 4.5.1 LIMITS OF POWER SPECTRAL DENSITY MEASUREMENT

The Maximum of Power Spectral Density Measurement is 8dBm.

### 4.5.2 TEST INSTRUMENTS

DESCRIPTION & MANUFACTURER	MODEL NO.	SERIAL NO.	CALIBRATED DATE	CALIBRATED UNTIL
R&S SPECTRUM ANALYZER	FSP 40	100060	May 17, 2010	May 16, 2011

**NOTE:**

1. The calibration interval of the above test instruments is 12 months and the calibrations are traceable to NML/ROC and NIST/USA.

### 4.5.3 TEST PROCEDURE

The transmitter output was connected to the spectrum analyzer through an attenuator, the bandwidth of the fundamental frequency was measured with the spectrum analyzer using 3kHz RBW and 30kHz VBW, set sweep time = span/3kHz. The power spectral density was measured and recorded. The sweep time is allowed to be longer than span/3kHz for a full response of the mixer in the spectrum analyzer.

### 4.5.4 DEVIATION FROM TEST STANDARD

No deviation

### 4.5.5 TEST SETUP

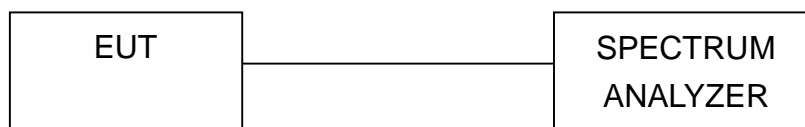

### 4.5.6 EUT OPERATING CONDITION

Same as Item 4.3.6



A D T

### 4.5.7 TEST RESULTS

#### 802.11b DSSS MODULATION:

CHANNEL	CHANNEL FREQUENCY (MHz )	RF POWER LEVEL IN 3kHz BW (dBm)	MAXIMUM LIMIT (dBm)	PASS / FAIL
1	2412	-17.5	8	PASS
6	2437	-17.8	8	PASS
11	2462	-18.3	8	PASS

CH1

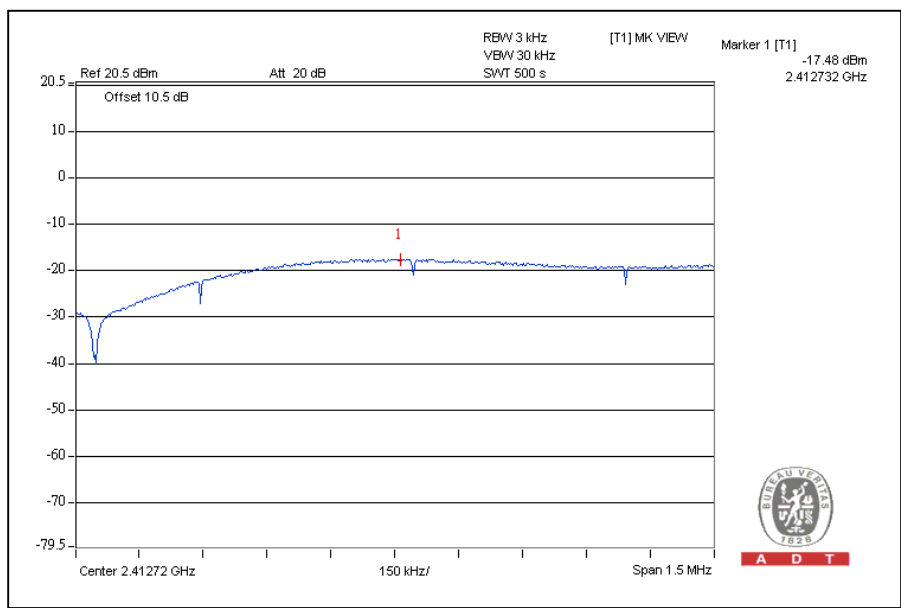



A D T

### 802.11g OFDM MODULATION:

CHANNEL	CHANNEL FREQUENCY (MHz )	RF POWER LEVEL IN 3kHz BW (dBm)	MAXIMUM LIMIT (dBm)	PASS / FAIL
1	2412	-13.2	8	PASS
6	2437	-11.9	8	PASS
11	2462	-16.0	8	PASS

### CH6

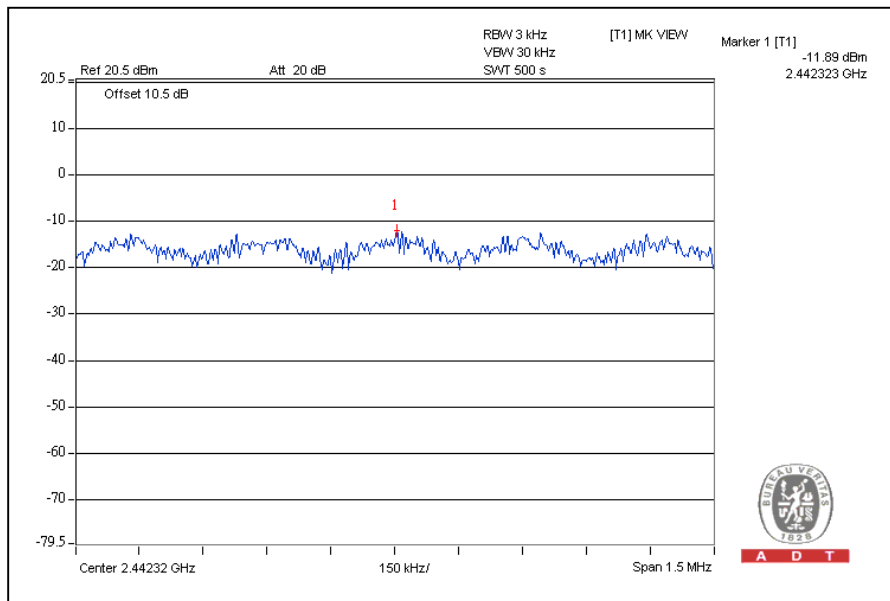



**802.11n (20MHz) OFDM MODULATION:**

CHANNEL	CHANNEL FREQUENCY (MHz)	RF POWER LEVEL IN 3kHz BW (dBm)		TOTAL POWER DENSITY (dBm)	MAXIMUM LIMIT (dBm)	PASS / FAIL
		CHAIN(0)	CHAIN(1)			
1	2412	-17.5	-17.2	-14.3	8	PASS
6	2437	-16.9	-18.1	-14.4	8	PASS
11	2462	-16.8	-19.2	-14.8	8	PASS

For Chain(0): CH11

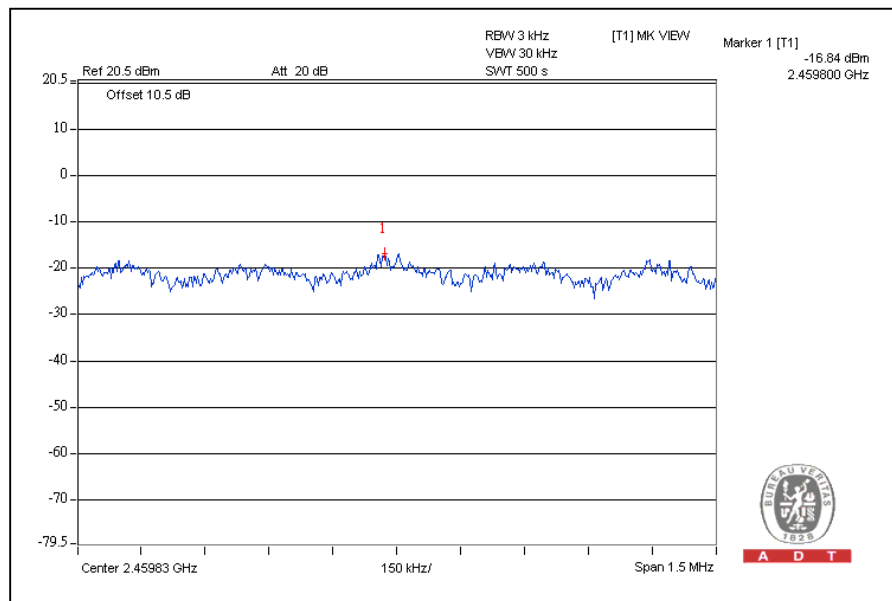



A D T

### 802.11n (40MHz) OFDM MODULATION:

CHANNEL	CHANNEL FREQUENCY (MHz)	RF POWER LEVEL IN 3kHz BW (dBm)		TOTAL POWER DENSITY (dBm)	MAXIMUM LIMIT (dBm)	PASS / FAIL
		CHAIN(0)	CHAIN(1)			
3	2422	-18.6	-20.0	-16.2	8	PASS
6	2437	-19.7	-19.1	-16.4	8	PASS
9	2452	-21.0	-21.2	-18.1	8	PASS

For Chain(0): CH3

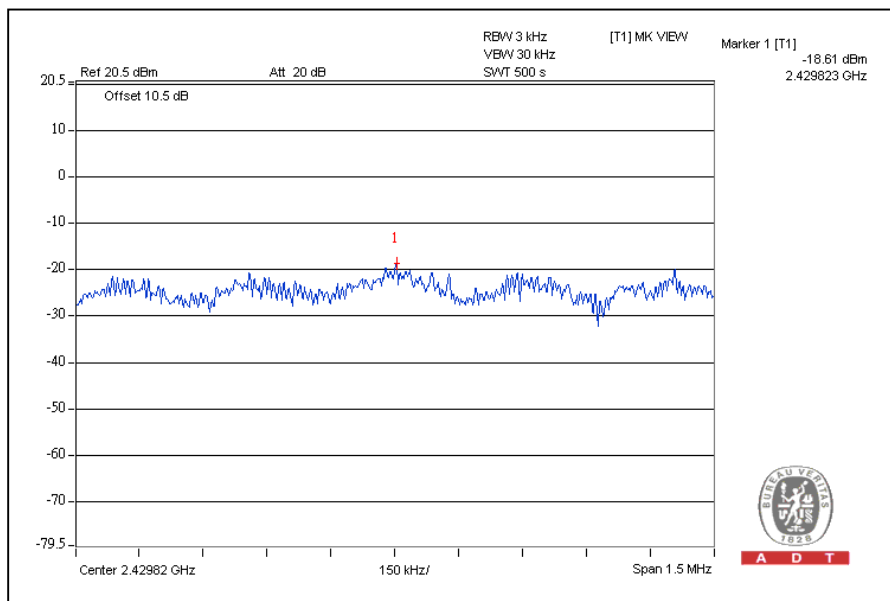

## 4.6 CONDUCTED OUT-BAND EMISSION MEASUREMENT

### 4.6.1 LIMITS OF CONDUCTED OUT-BAND EMISSION MEASUREMENT

Below  $-20\text{dB}$  of the highest emission level of operating band (in 100kHz Resolution Bandwidth).

### 4.6.2 TEST INSTRUMENTS

DESCRIPTION & MANUFACTURER	MODEL NO.	SERIAL NO.	CALIBRATED DATE	CALIBRATED UNTIL
R&S SPECTRUM ANALYZER	FSP 40	100060	May 17, 2010	May 16, 2011

**NOTE:**

1. The calibration interval of the above test instruments is 12 months and the calibrations are traceable to NML/ROC and NIST/USA.

### 4.6.3 TEST PROCEDURE

The transmitter output was connected to the spectrum analyzer via a low loss cable. Set RBW of spectrum analyzer to 100kHz and VBW of spectrum analyzer to 300kHz with suitable frequency span including 100 MHz or 200 MHz bandwidth from band edge. The band edges was measured and recorded.

The spectrum plots (RBW = 100kHz, VBW = 300kHz) are attached on the following pages.

### 4.6.4 DEVIATION FROM TEST STANDARD

No deviation

### 4.6.5 EUT OPERATING CONDITION

Same as Item 4.3.6

#### 4.6.6 TEST RESULTS

The spectrum plots are attached on the following images. D1 line indicates the highest level, and D2 line indicates the 20dB offset below D1. It shows compliance with the requirement in part 15.247(d).

## 802.11b DSSS MODULATION:

### CH1

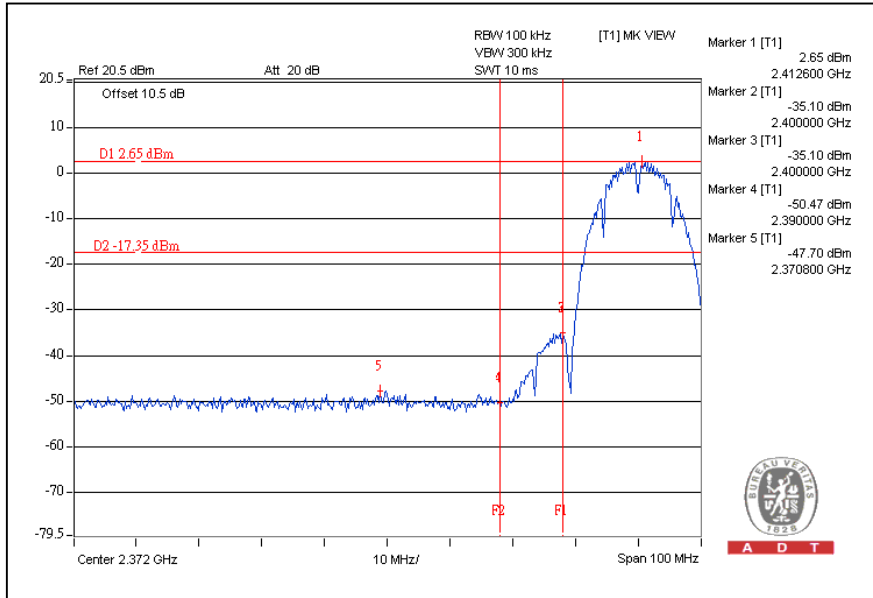

### CH11

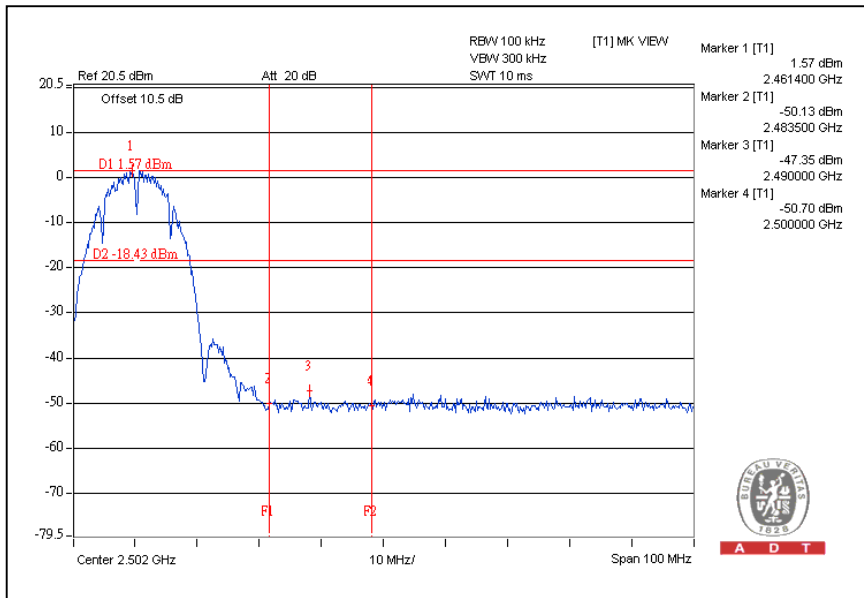



A D T

### CH1

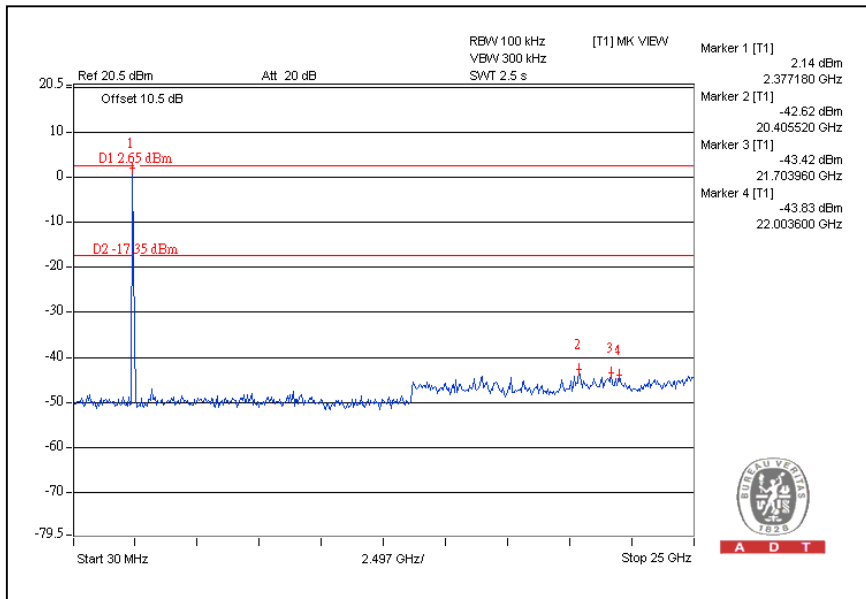

### CH11

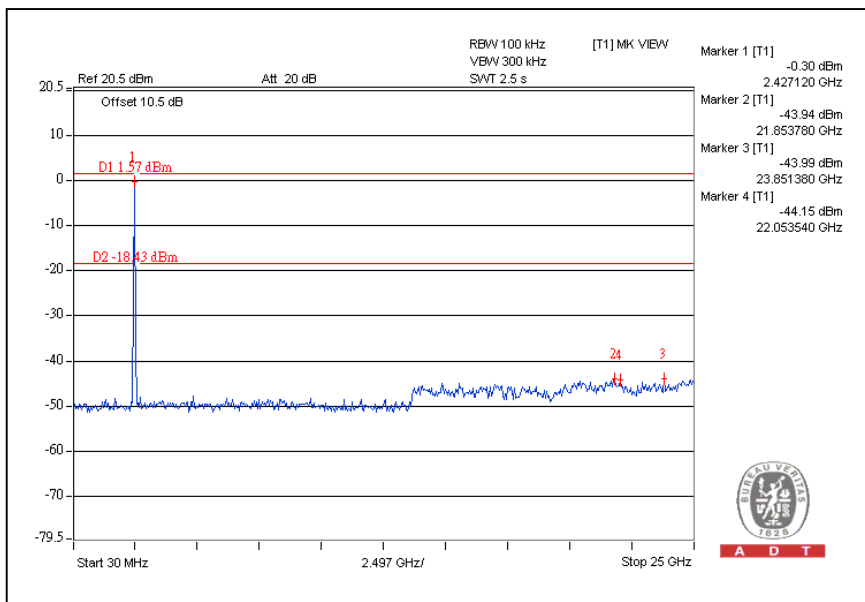

### 802.11g OFDM MODULATION:

#### CH1

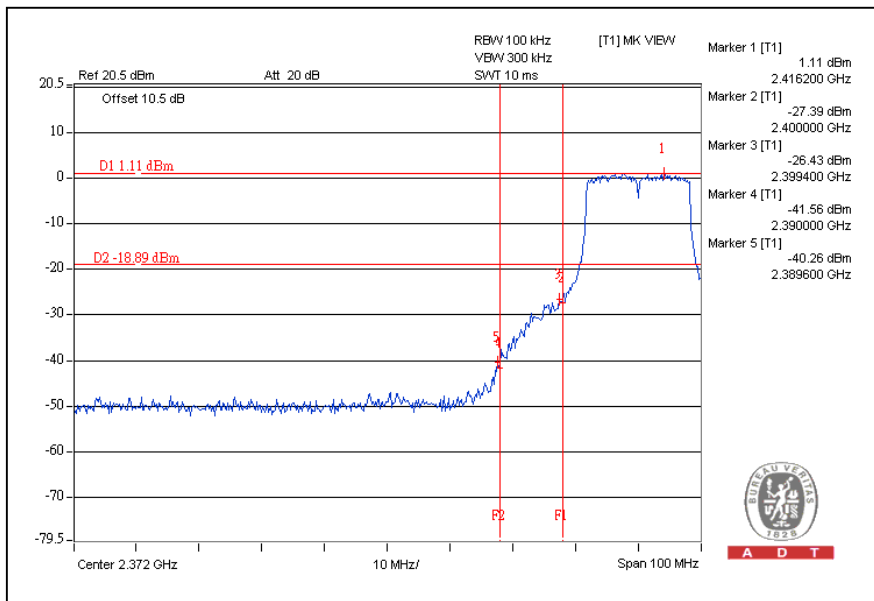

#### CH11

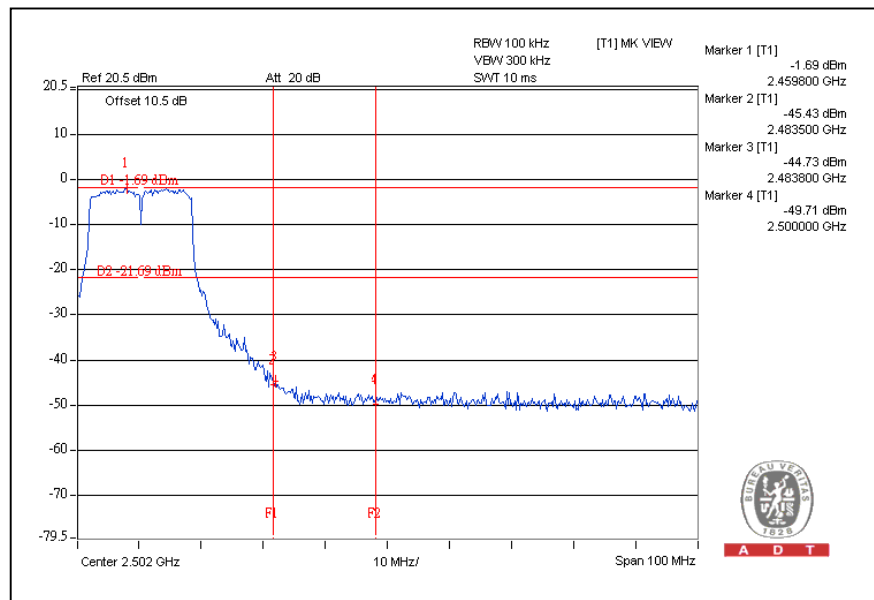



A D T

### CH1

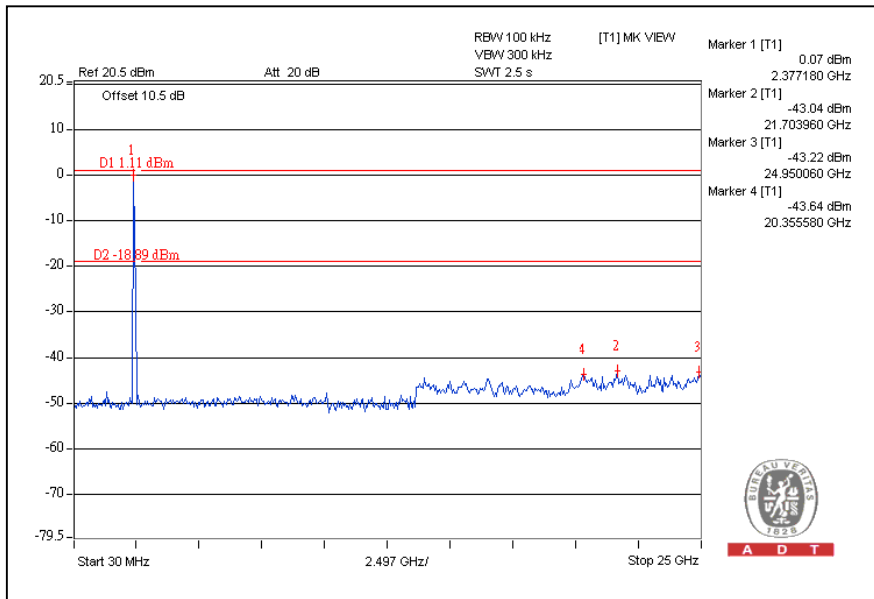

### CH11

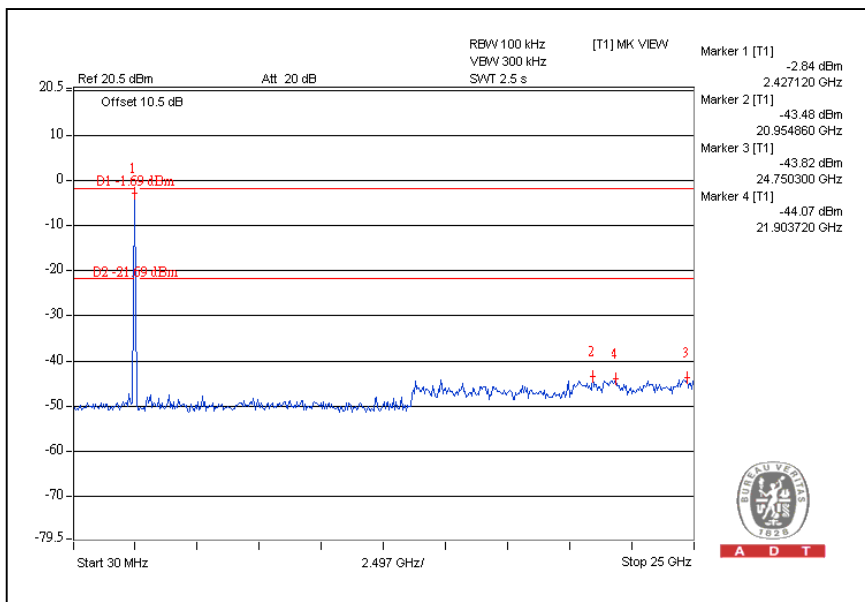



### 802.11n (20MHz) OFDM MODULATION:

CH1

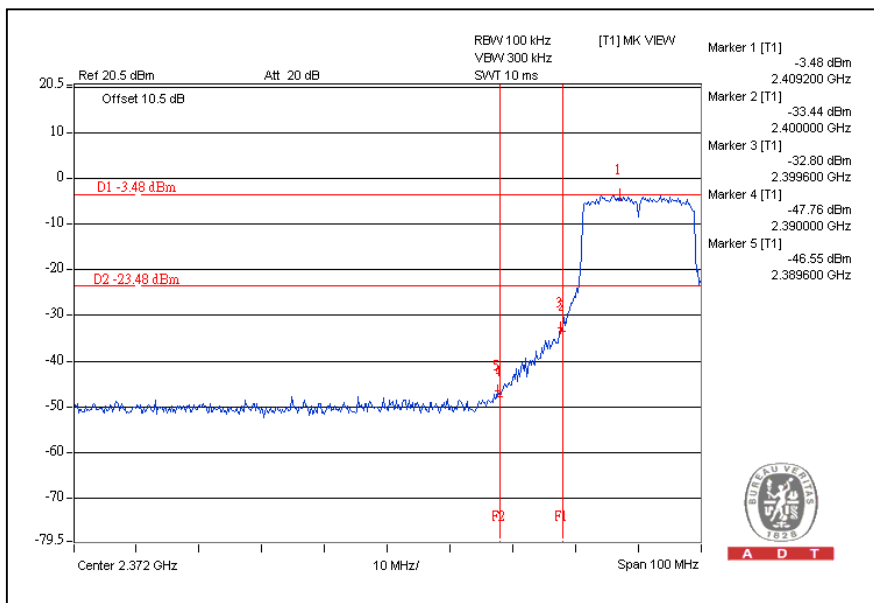

CH11

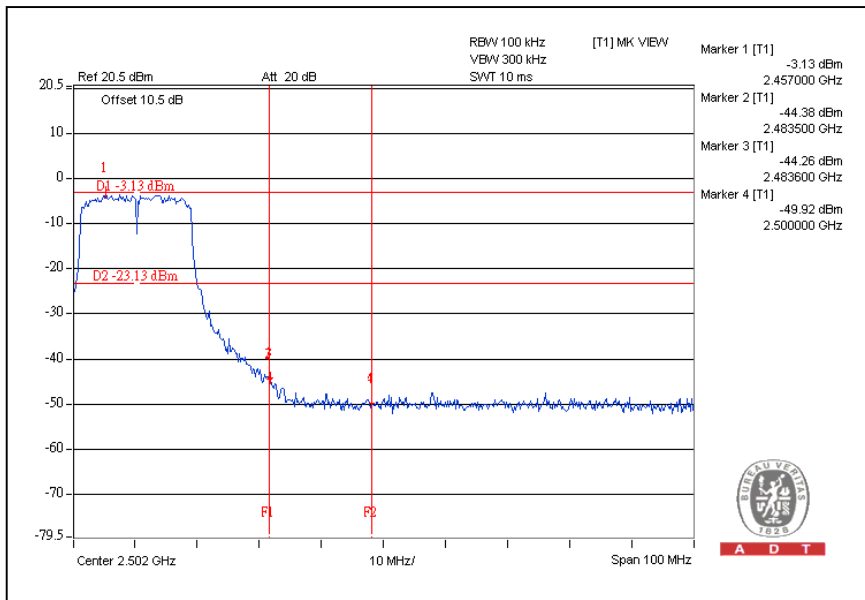



A D T

### CH1

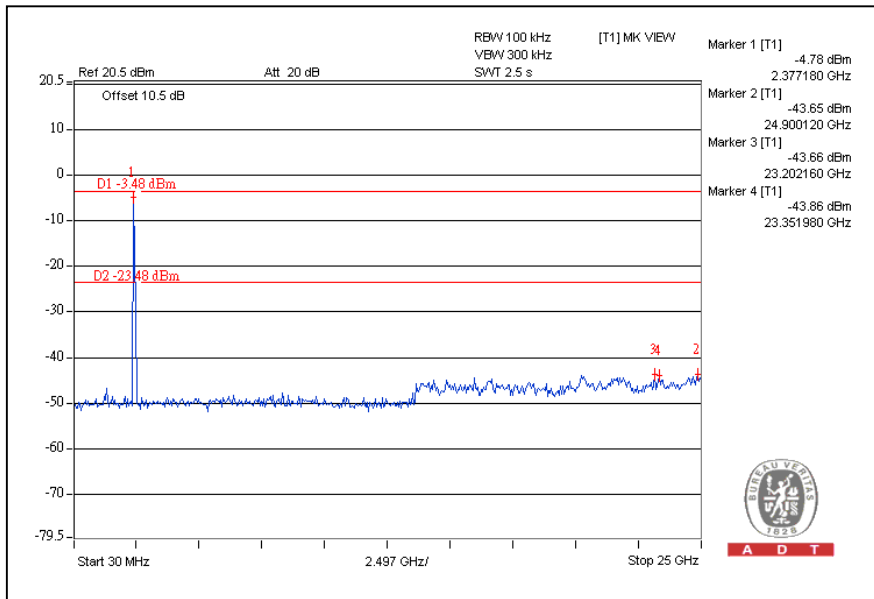

### CH11

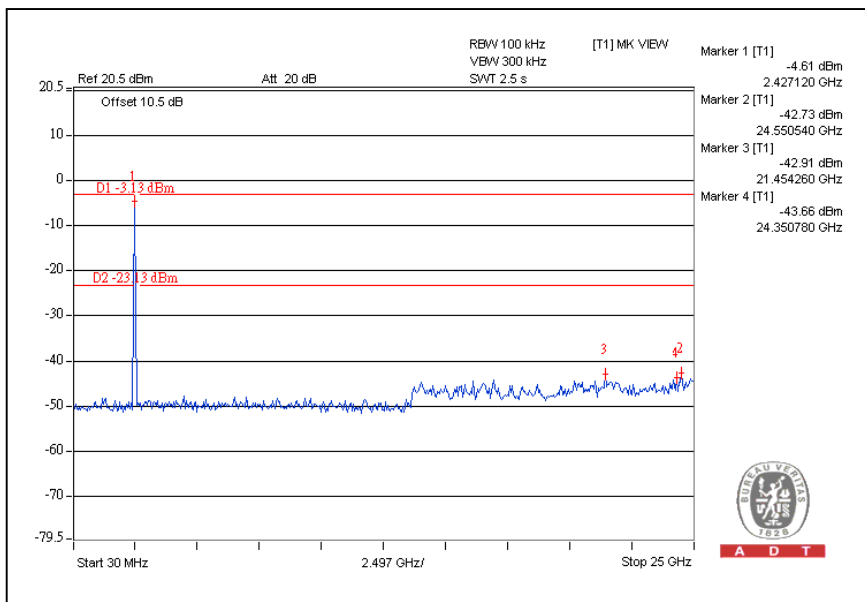

## 802.11n (40MHz) OFDM MODULATION:

### CH3

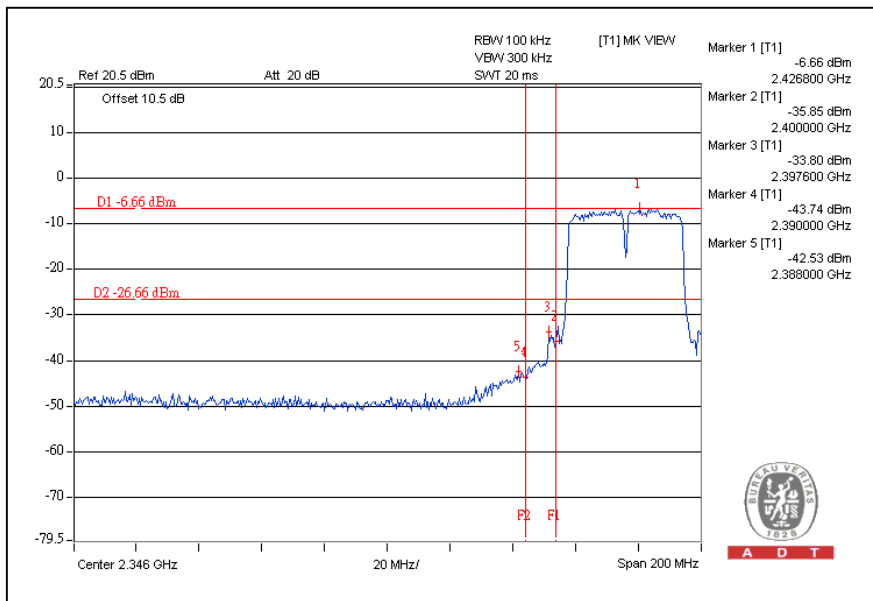

### CH9

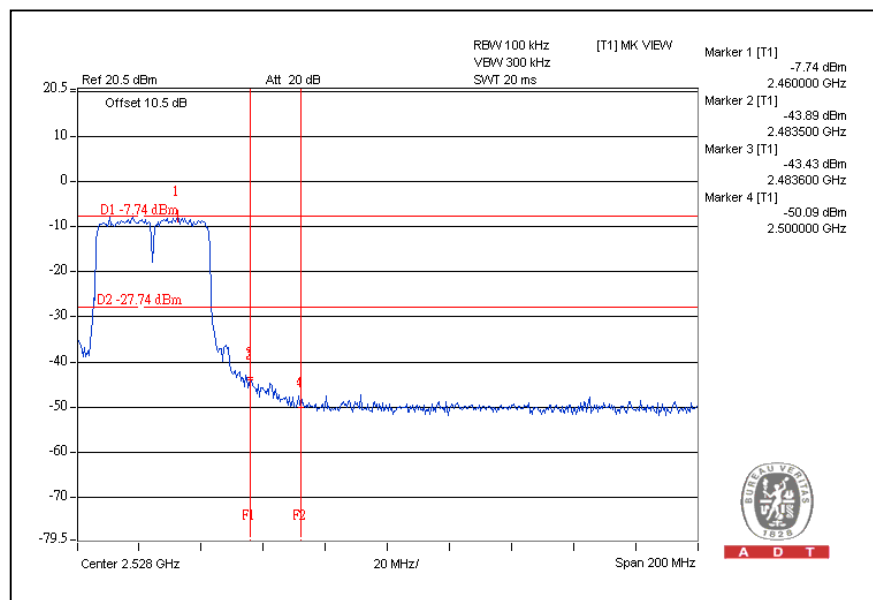



A D T

### CH3

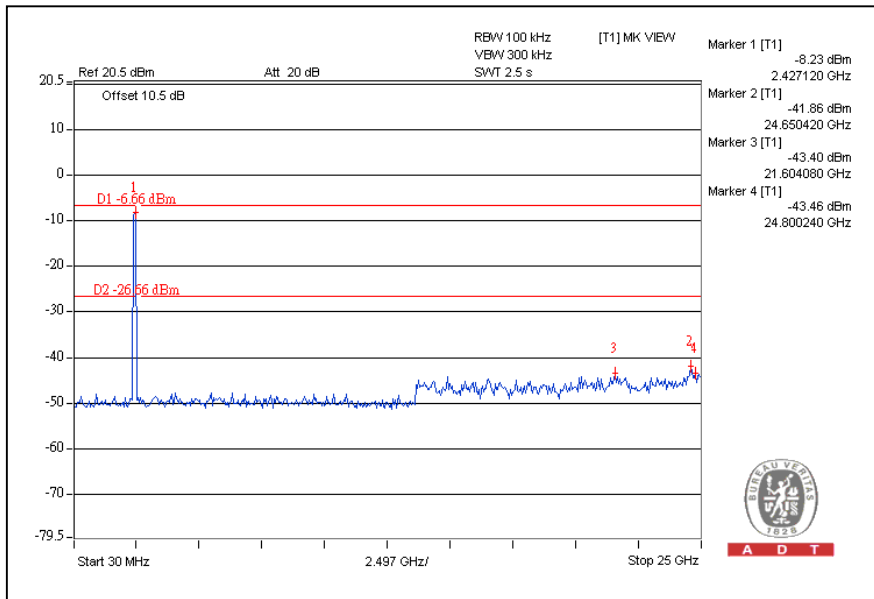

### CH9

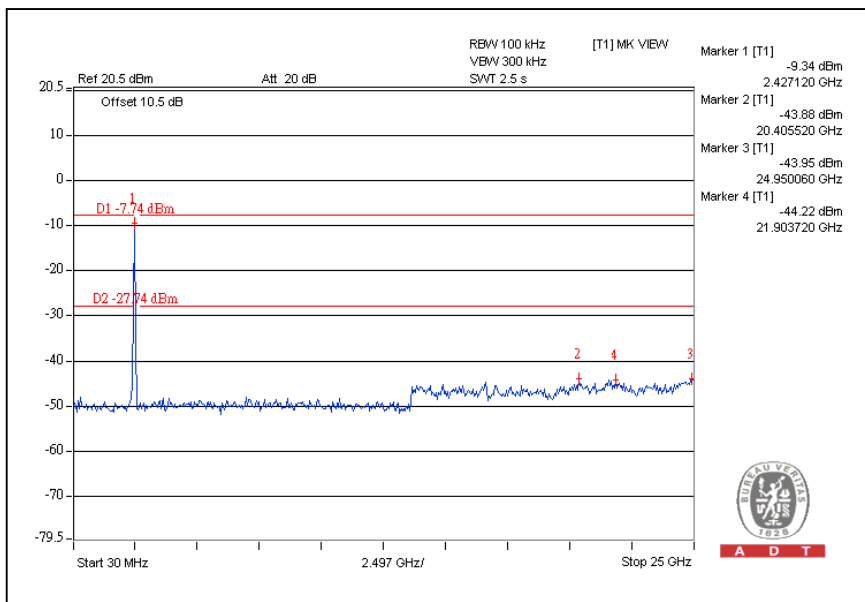



A D T

## 5. INFORMATION ON THE TESTING LABORATORIES

We, Bureau Veritas Consumer Products Services (H.K.) Ltd., Taoyuan Branch, were founded in 1988 to provide our best service in EMC, Radio, Telecom and Safety consultation. Our laboratories are accredited and approved according to ISO/IEC 17025:

Copies of accreditation certificates of our laboratories obtained from approval agencies can be downloaded from our web site: [www.adt.com.tw/index.5.phtml](http://www.adt.com.tw/index.5.phtml).

If you have any comments, please feel free to contact us at the following:

**Linko EMC/RF Lab:**

Tel: 886-2-26052180

Fax: 886-2-26052943

**Hsin Chu EMC/RF Lab:**

Tel: 886-3-5935343

Fax: 886-3-5935342

**Hwa Ya EMC/RF/Safety/Telecom Lab:**

Tel: 886-3-3183232

Fax: 886-3-3185050

**Email:** [service@adt.com.tw](mailto:service@adt.com.tw)

**Web Site:** [www.adt.com.tw](http://www.adt.com.tw)

The address and road map of all our labs can be found in our web site also.



A D T

## **6.APPENDIX A - MODIFICATIONS RECORDERS FOR ENGINEERING CHANGES TO THE EUT BY THE LAB**

No any modifications are made to the EUT by the lab during the test.

**--- END ---**