



A D T

FCC TEST REPORT

REPORT NO.: RF980824H06A

MODEL NO.: DOME BASE

RECEIVED: Nov. 23, 2009

TESTED: Nov. 30 to Dec. 17, 2009

ISSUED: Jan. 07, 2009

APPLICANT: Argtek Communication Inc.

ADDRESS: 8F-9, No. 4, Lane 609, Sec. 5, Chung Hsin Rd. San
Chung City, Taipei Hsien

ISSUED BY: Bureau Veritas Consumer Products Services (H.K.)
Ltd., Taoyuan Branch Hsin Chu Laboratory

ADDRESS: No. 81-1, Lu Liao Keng, 9th Ling, Wu Lung Tsuen,
Chiung Lin Hsiang, Hsin Chu Hsien 307, Taiwan

This test report consists of 35 pages in total. It may be duplicated completely for legal use with the approval of the applicant. It should not be reproduced except in full, without the written approval of our laboratory. The client should not use it to claim product endorsement by TAF or any government agencies. The test results in the report only apply to the tested sample.





TABLE OF CONTENTS

1.	CERTIFICATION	4
2.	SUMMARY OF TEST RESULTS	5
2.1	MEASUREMENT UNCERTAINTY	5
3.	GENERAL INFORMATION	6
3.1	GENERAL DESCRIPTION OF EUT	6
3.2	DESCRIPTION OF TEST MODES	8
3.2.1	TEST MODE APPLICABILITY AND TESTED CHANNEL DETAIL	9
3.3	GENERAL DESCRIPTION OF APPLIED STANDARDS	11
3.4	DESCRIPTION OF SUPPORT UNITS	12
3.5	CONFIGURATION OF SYSTEM UNDER TEST	13
4.	TEST TYPES AND RESULTS	14
4.1	CONDUCTED EMISSION MEASUREMENT	14
4.1.1	LIMITS OF CONDUCTED EMISSION MEASUREMENT	14
4.1.2	TEST INSTRUMENTS	14
4.1.3	TEST PROCEDURES	15
4.1.4	DEVIATION FROM TEST STANDARD	15
4.1.5	TEST SETUP	15
4.1.6	EUT OPERATING CONDITIONS	16
4.1.7	TEST RESULTS	17
4.2	RADIATED EMISSION MEASUREMENT	19
4.2.1	LIMITS OF RADIATED EMISSION MEASUREMENT	19
4.2.2	TEST INSTRUMENTS	20
4.2.3	TEST PROCEDURES	22
4.2.4	DEVIATION FROM TEST STANDARD	22
4.2.5	TEST SETUP	23
4.2.6	EUT OPERATING CONDITIONS	23
	Below 1GHz Test Data	24
4.2.7	TEST RESULTS	24
	Above 1GHz Test Data	25
4.2.8	TEST RESULTS	25
4.3	MAXIMUM PEAK OUTPUT POWER	31
4.3.1	LIMITS OF MAXIMUM PEAK OUTPUT POWER MEASUREMENT	31
4.3.2	INSTRUMENTS	31
4.4.3	TEST PROCEDURES	31
4.4.4	DEVIATION FROM TEST STANDARD	31
4.4.5	TEST SETUP	32
4.4.6	EUT OPERATING CONDITIONS	32



A D T

4.4.7	TEST RESULTS	33
5.	INFORMATION ON THE TESTING LABORATORIES	34
6.	APPENDIX - A MODIFICATIONS RECORDERS FOR ENGINEERING CHANGES TO THE EUT BY THE LAB	35



A D T

1. CERTIFICATION

PRODUCT : 802.11 b/g/n WLAN USB Adapter
BRAND : Gsky
MODEL NO.: DOME BASE
APPLICANT : Argtek Communication Inc.
TESTED : Nov. 30 to Dec. 17, 2009
TEST SAMPLE : ENGINEERING SAMPLE
STANDARDS : FCC Part 15, Subpart C (Section 15.247),
ANSI C63.4-2003

The above equipment (Model: DOME BASE) has been tested by **Bureau Veritas Consumer Products Services (H.K.) Ltd., Taoyuan Branch**, and found compliance with the requirement of the above standards. The test record, data evaluation & Equipment Under Test (EUT) configurations represented herein are true and accurate accounts of the measurements of the sample's EMC characteristics under the conditions specified in this report.

PREPARED BY : Midoli Peng , **DATE:** Jan. 07, 2010
(Midoli Peng, Specialist)

TECHNICAL ACCEPTANCE : Hank Chung , **DATE:** Jan. 07, 2010
(Hank Chung, Deputy Manager)

APPROVED BY : May Chen , **DATE:** Jan. 07, 2010
(May Chen, Deputy Manager)



2. SUMMARY OF TEST RESULTS

The EUT has been tested according to the following specifications:

APPLIED STANDARD: FCC Part 15, Subpart C			
STANDARD SECTION	TEST TYPE AND LIMIT	RESULT	REMARK
15.247(b)	Maximum Peak Output Power Limit: max. 30dBm	PASS	Meet the requirement of limit.
15.247(d)	Transmitter Radiated Emissions Limit: Table 15.209	PASS	Meet the requirement of limit. Minimum passing margin is -3.57dB at 120.0MHz.
15.203	Antenna Requirement	PASS	Antenna connector is RP-SMA not a standard connector.

NOTE: This report is prepared for FCC class II permissive change. Only radiated emission and maximum peak output power were presented in this test report.

2.1 MEASUREMENT UNCERTAINTY

Where relevant, the following measurement uncertainty levels have been estimated for tests performed on the EUT as specified in CISPR 16-4-2:

This uncertainty represents an expanded uncertainty expressed at approximately the 95% confidence level using a coverage factor of k=2.

Measurement	Value
Radiated emissions (30MHz-1GHz)	3.98 dB
Radiated emissions (1GHz -18GHz)	2.49 dB
Radiated emissions (18GHz -40GHz)	2.70 dB



3. GENERAL INFORMATION

3.1 GENERAL DESCRIPTION OF EUT

PRODUCT	802.11 b/g/n WLAN USB Adapter
MODEL NO.	DOME BASE
FCC ID	VYXWIFI-004
POWER SUPPLY	5VDC
MODULATION TYPE	CCK, DQPSK, DBPSK for DSSS 64QAM, 16QAM, QPSK, BPSK for OFDM
MODULATION TECHNOLOGY	DSSS, OFDM
TRANSFER RATE	802.11b: 11 / 5.5 / 2 / 1Mbps 802.11g: 54 / 48 / 36 / 24 / 18 / 12 / 9 / 6Mbps 802.11n (20MHz, 800ns GI): 65 / 58.5 / 52 / 39 / 26 / 19.5 / 13 / 6.5Mbps 802.11n (40MHz, 800ns GI): 135 / 121.5 / 108 / 81 / 54 / 40.5 / 27 / 13.5Mbps 802.11n (20MHz, 400ns GI): 72.2 / 65 / 57.8 / 43.3 / 28.9 / 21.7 / 14.4 / 7.2Mbps 802.11n (40MHz, 400ns GI): 150 / 135 / 120 / 90 / 60 / 45 / 30 / 15Mbps
FREQUENCY RANGE	2412MHz ~ 2462MHz
NUMBER OF CHANNEL	11 for 802.11b, 802.11g, 802.11n (20MHz) 7 for 802.11n (40MHz)
MAXIMUM OUTPUT POWER	802.11b: 42.7mW 802.11g: 724.4mW 802.11n (20MHz): 616.6mW 802.11n (40MHz): 562.3mW
ANTENNA TYPE	Please see note 2
ANTENNA CONNECTOR	RP-SMA connector
DATA CABLE	USB Cable x 1 (Shielded, 1.5m)
I/O PORT	USB Port x 1
ASSOCIATED DEVICES	NA

NOTE:

1. This report is prepared for FCC class II permissive change. The difference compared with the Report No.: RF980824H06 design is as the following:

- ◆ The color of housing and antenna location design are different.
- ◆ Add one new model name : DOME BASE
- ◆ Changed the product name : 802.11 b/g/n WLAN USB Adapter

2. There are two antennas provided to this EUT, please refer to the following table:

Chain	Brand No.	Model No.	Gain (dBi)	Antenna Type	Connector	Frequency range (MHz to MHz)
Chain (0)	Aristotle	RFA-02-5-C7 M3-B70	7	dipole	RP-SMA	2400~2500
Chain (1)	NA	NA	-6	Printed	NA	2400~2500

3. The EUT incorporates a SIMO function with 802.11b, 802.11g, 802.11n. Physically, the EUT provides one completed transmitter and two completed receivers.

4. The EUT is 1 * 2 spatial SIMO (1Tx & 2Rx) without beam forming function. The antenna configurations are one transmitter antenna and two receiver antennas, as there are 1 dipole antenna and 1 Printed antenna. There is one transmitter and two receivers.

5. The EUT complies with 802.11n standards and backwards compatible with 802.11b, 802.11g products.

6. The EUT, operates in the 2.4GHz frequency range, lets you connect IEEE 802.11g or IEEE 802.11b and 802.11n technique devices to the network.

7. The above EUT information was declared by the manufacturer and for more detailed features description, please refers to the manufacturer's specifications or User's Manual.

3.2 DESCRIPTION OF TEST MODES

Eleven channels are provided for 802.11b, 802.11g, 802.11n (20MHz):

CHANNEL	FREQUENCY	CHANNEL	FREQUENCY
1	2412MHz	7	2442MHz
2	2417MHz	8	2447MHz
3	2422MHz	9	2452MHz
4	2427MHz	10	2457MHz
5	2432MHz	11	2462MHz
6	2437MHz		

Seven channels are provided for 802.11n (40MHz):

CHANNEL	FREQUENCY	CHANNEL	FREQUENCY
1	2422MHz	5	2442MHz
2	2427MHz	6	2447MHz
3	2432MHz	7	2452MHz
4	2437MHz		



A D T

3.2.1 TEST MODE APPLICABILITY AND TESTED CHANNEL DETAIL

EUT CONFIGURE MODE	APPLICABLE TO				DESCRIPTION
	PLC	RE < 1G	RE ≥ 1G	APCM	
-	-	√	√	√	-

Where **PLC**: Power Line Conducted Emission

RE < 1G: Radiated Emission below 1GHz

RE ≥ 1G: Radiated Emission above 1GHz

APCM: Antenna Port Conducted Measurement

ANTENNA COMBINATION MODE:

COMBINATION MODE	OPERATION MODE	TX CHAIN(0)	TX CHAIN(1)
A	802.11 b	√	
B	802.11 g	√	
C	802.11n(20MHz), 800ns GI	√	
D	802.11n(40MHz), 800ns GI	√	
E	802.11n(20MHz), 400ns GI	√	
F	802.11n(40MHz), 400ns GI	√	

Note:

1. The above information was declared by manufacturer and for more detailed features description, please refer to the manufacturer's specifications or user's manual.
2. Mode A~D the worst modes, were selected as representative mode for the report.

RADIATED EMISSION TEST (BELOW 1 GHZ):

- Pre-Scan has been conducted to determine the worst-case mode from all possible combinations between available modulations, data rates and antenna ports (if EUT with antenna diversity architecture).
- Following channel(s) was (were) selected for the final test as listed below.

MODE	AVAILABLE CHANNEL	TESTED CHANNEL	MODULATION TECHNOLOGY	MODULATION TYPE	DATA RATE (Mbps)	COMBINATION MODE
802.11g	1 to 11	6	OFDM	BPSK	6	B



RADIATED EMISSION TEST (ABOVE 1 GHZ):

- Pre-Scan has been conducted to determine the worst-case mode from all possible combinations between available modulations, data rates and antenna ports (if EUT with antenna diversity architecture).
- Following channel(s) was (were) selected for the final test as listed below.

MODE	AVAILABLE CHANNEL	TESTED CHANNEL	MODULATION TECHNOLOGY	MODULATION TYPE	DATA RATE (Mbps)	COMBINATION MODE
802.11n (20MHz)	1 to 11	1, 11	OFDM	BPSK	6.5	C

ANTENNA PORT CONDUCTED MEASUREMENT:

- This item includes all test value of each mode, but only includes spectrum plot of worst value of each mode.
- Pre-Scan has been conducted to determine the worst-case mode from all possible combinations between available modulations, data rates and antenna ports (if EUT with antenna diversity architecture).
- Following channel(s) was (were) selected for the final test as listed below.

MODE	AVAILABLE CHANNEL	TESTED CHANNEL	MODULATION TECHNOLOGY	MODULATION TYPE	DATA RATE (Mbps)	COMBINATION MODE
802.11b	1 to 11	1, 6, 11	DSSS	DBPSK	1	A
802.11g	1 to 11	1, 6, 11	OFDM	BPSK	6	B
802.11n (20MHz)	1 to 11	1, 6, 11	OFDM	BPSK	6.5	C
802.11n (40MHz)	1 to 7	1, 4, 7	OFDM	BPSK	13.5	D

TEST CONDITION:

APPLICABLE TO	ENVIRONMENTAL CONDITIONS	INPUT POWER (SYSTEM)	TESTED BY
RE≥1G	22deg. C, 66%RH, 1020 hPa	120Vac, 60Hz	Frank Liu
RE<1G	20deg. C, 78%RH, 1020 hPa	120Vac, 60Hz	Timmy Hu
PLC	22deg. C, 66%RH, 1020 hPa	120Vac, 60Hz	Eric Lee
APCM	23deg. C, 62%RH, 1020 hPa	120Vac, 60Hz	Kent Liu

3.3 GENERAL DESCRIPTION OF APPLIED STANDARDS

The EUT is an RF product. According to the specifications of the manufacturer, it must comply with the requirements of the following standards:

FCC Part 15, Subpart C. (15.247)

ANSI C63.4-2003

All test items have been performed and recorded as per the above standards.

NOTE: The EUT is also considered as a kind of computer peripheral, because the connection to computer is necessary for typical use. It has been verified to comply with the requirements of FCC Part 15, Subpart B, Class B (DoC). The test report has been issued separately.



3.4 DESCRIPTION OF SUPPORT UNITS

The EUT has been tested as an independent unit together with other necessary accessories or support units. The following support units or accessories were used to form a representative test configuration during the tests.

For conducted emission test					
NO.	PRODUCT	BRAND	MODEL NO.	SERIAL NO.	FCC ID
1	NOTEBOOK COMPUTER	DELL	PP17L	CN-ONF743-48643-7AV-0124	FCC DoC
2	MODEM	ACEEX	1414	0206026779	IFAXDM1414
For other test items					
NO.	PRODUCT	BRAND	MODEL NO.	SERIAL NO.	FCC ID
1	NOTEBOOK COMPUTER	DELL	E6400	D814C A00 APCC	NA
2	iPod	Apple	A1137	5K7170JBUPR	FCC DoC

For conducted test	
NO.	SIGNAL CABLE DESCRIPTION OF THE ABOVE SUPPORT UNITS
1	USB cable (1.5 m shielded)
2	1.5 m braid shielded wire, terminated with DB25 and DB9 connector via metallic frame, w/o core.
For other test items	
NO.	SIGNAL CABLE DESCRIPTION OF THE ABOVE SUPPORT UNITS
1	USB cable (1.5 m shielded)
2	1 m shielded cable, terminated with USB connector, w/o core.

NOTE: All power cords of the above support units are non shielded (1.8m).

3.5 CONFIGURATION OF SYSTEM UNDER TEST

For conducted emission test

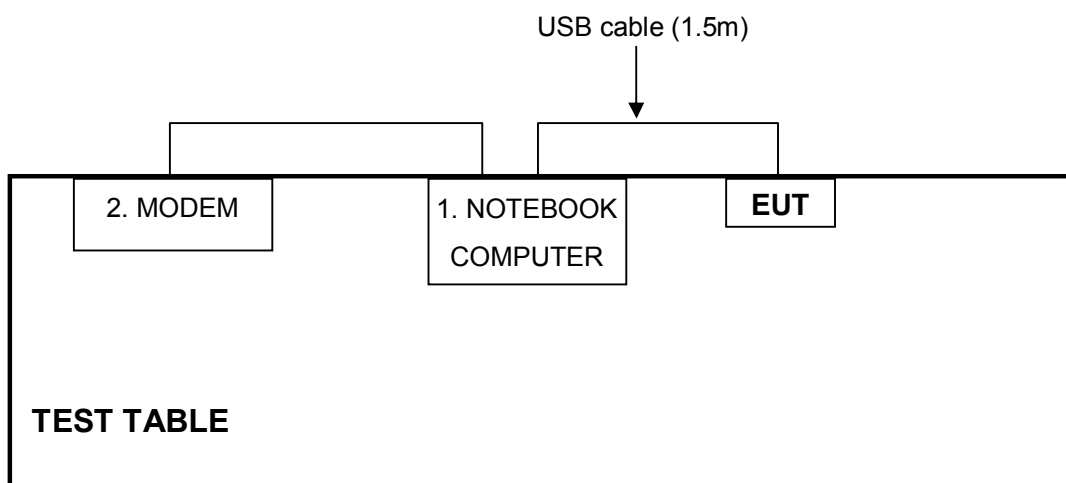

For other test items

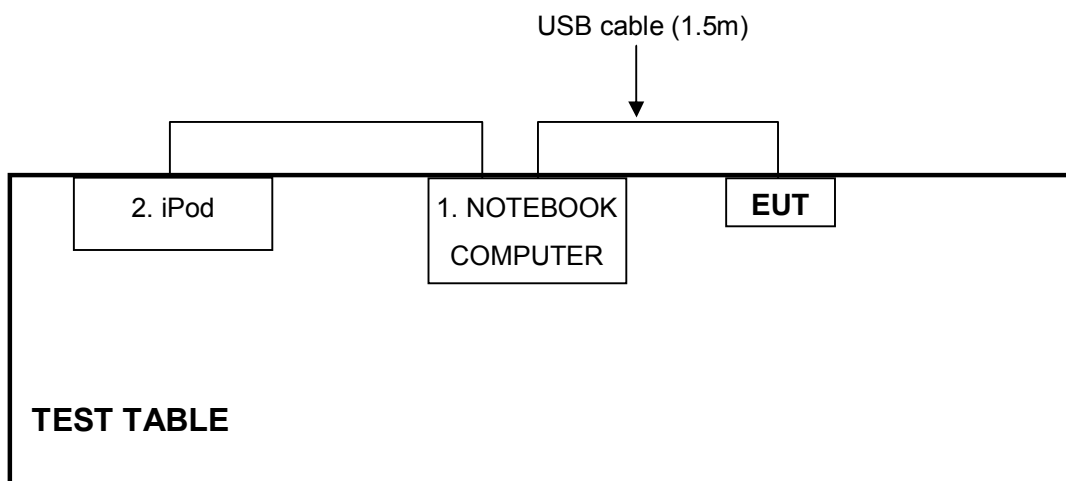



4. TEST TYPES AND RESULTS

4.1 CONDUCTED EMISSION MEASUREMENT

4.1.1 LIMITS OF CONDUCTED EMISSION MEASUREMENT

FREQUENCY OF EMISSION (MHz)	CONDUCTED LIMIT (dB μ V)	
	Quasi-peak	Average
0.15-0.5	66 to 56	56 to 46
0.5-5	56	46
5-30	60	50

- NOTE:**
1. The lower limit shall apply at the transition frequencies.
 2. The limit decreases in line with the logarithm of the frequency in the range of 0.15 to 0.50 MHz.
 3. All emanations from a class A/B digital device or system, including any network of conductors and apparatus connected thereto, shall not exceed the level of field strengths specified above.

4.1.2 TEST INSTRUMENTS

DESCRIPTION & MANUFACTURER	MODEL NO.	SERIAL NO.	CALIBRATED DATE	CALIBRATED UNTIL
Test Receiver	ESCS 30	100375	Mar. 23, 2009	Mar. 22, 2010
Line-Impedance Stabilization Network (for Peripheral)	ENV-216	100071	Nov. 30, 2009	Nov. 29, 2010
Line-Impedance Stabilization Network (for EUT)	ESH3-Z5	848773/004	Nov. 26, 2009	Nov. 25, 2010
RF Cable (JYEBAO)	5DFB	COBCAB-001	Aug. 14, 2009	Aug. 13, 2010
50 ohms Terminator	50	3	Nov. 05, 2009	Nov. 04, 2010
Software	BV ADT_Cond_V7.3.7	NA	NA	NA

Note:

1. The calibration interval of the above test instruments is 12 months and the calibrations are traceable to NML/ROC and NIST/USA.
2. The test was performed in Shielded Room No. B.
3. The VCCI Con B Registration No. is C-2193.

4.1.3 TEST PROCEDURES

- a. The EUT was placed 0.4 meters from the conducting wall of the shielded room with EUT being connected to the power mains through a line impedance stabilization network (LISN). Other support units were connected to the power mains through another LISN. The two LISNs provide 50 ohm/ 50uH of coupling impedance for the measuring instrument.
- b. Both lines of the power mains connected to the EUT were checked for maximum conducted interference.
- c. The frequency range from 150kHz to 30MHz was searched. Emission levels under (Limit - 20dB) was not recorded.

4.1.4 DEVIATION FROM TEST STANDARD

No deviation

4.1.5 TEST SETUP

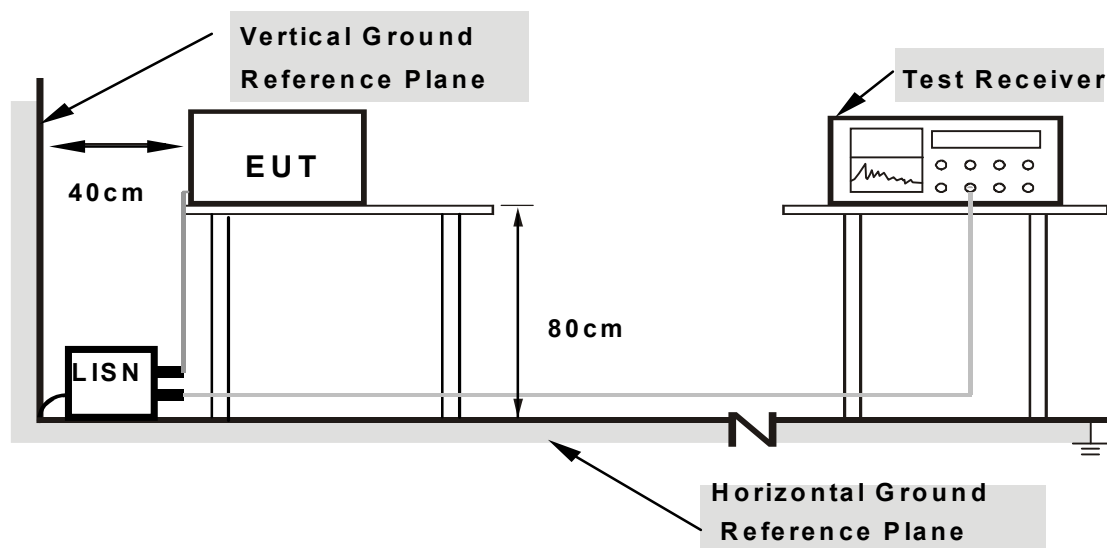

Note: 1. Support units were connected to second LISN.

2. Both of LISNs (AMN) are 80 cm from EUT and at least 80 from other units and other metal planes

For the actual test configuration, please refer to the related item – Photographs of the Test Configuration.

4.1.6 EUT OPERATING CONDITIONS

- a. Connect the EUT with the support unit 1 (Notebook Computer) which placed on a testing table.
- b. The communication partner run test program "RT3x7xQA.exe" to enable EUT under transmission/receiving condition continuously at specific channel frequency via one USB cable.

4.1.7 TEST RESULTS

PHASE	Line (L)	6dB BANDWIDTH	9 kHz
--------------	----------	----------------------	-------

No	Freq.	Corr.	Reading Value		Emission Level		Limit		Margin	
	[MHz]	(dB)	Q.P.	AV.	Q.P.	AV.	Q.P.	AV.	Q.P.	AV.
1	0.177	0.18	47.21	-	47.39	-	64.61	54.61	-17.22	-
2	0.236	0.18	40.18	-	40.36	-	62.24	52.24	-21.88	-
3	0.521	0.24	20.65	-	20.89	-	56.00	46.00	-35.11	-
4	0.580	0.26	24.17	-	24.43	-	56.00	46.00	-31.57	-
5	4.016	0.62	29.24	-	29.86	-	56.00	46.00	-26.14	-
6	16.629	1.30	25.20	-	26.50	-	60.00	50.00	-33.50	-

- REMARKS:**
1. Q.P. and AV. are abbreviations of quasi-peak and average individually.
 2. "-": The Quasi-peak reading value also meets average limit and measurement with the average detector is unnecessary.
 3. The emission levels of other frequencies were very low against the limit.
 4. Margin value = Emission level - Limit value
 5. Correction factor = Insertion loss + Cable loss
 6. Emission Level = Correction Factor + Reading Value.

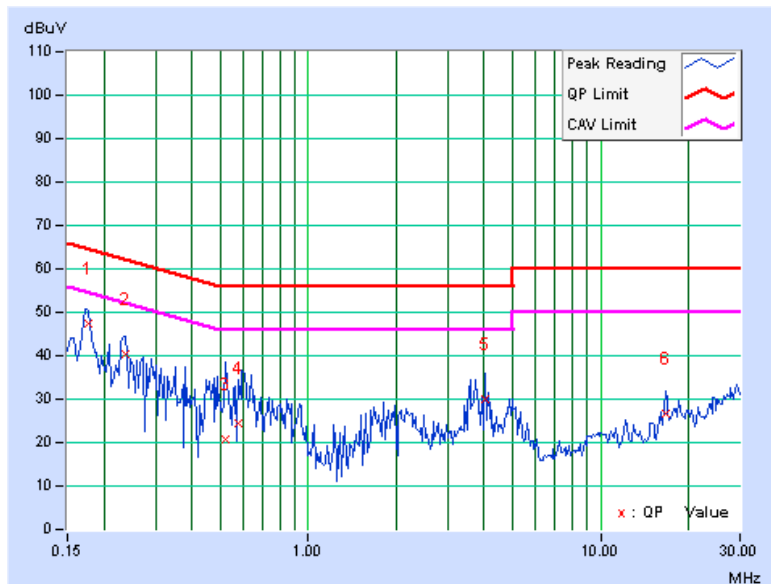



A D T

PHASE	Neutral (N)	6dB BANDWIDTH	9 kHz
-------	-------------	---------------	-------

No	Freq. [MHz]	Corr. Factor (dB)	Reading Value [dB (uV)]		Emission Level [dB (uV)]		Limit [dB (uV)]		Margin (dB)	
			Q.P.	AV.	Q.P.	AV.	Q.P.	AV.	Q.P.	AV.
1	0.173	0.10	48.09	-	48.19	-	64.79	54.79	-16.60	-
2	0.232	0.11	42.44	-	42.55	-	62.38	52.38	-19.82	-
3	0.287	0.12	33.97	-	34.09	-	60.62	50.62	-26.53	-
4	0.405	0.13	27.00	-	27.13	-	57.74	47.74	-30.61	-
5	0.465	0.15	26.07	-	26.22	-	56.60	46.60	-30.38	-
6	4.070	0.55	29.87	-	30.42	-	56.00	46.00	-25.58	-

- REMARKS:**
1. Q.P. and AV. are abbreviations of quasi-peak and average individually.
 2. "-": The Quasi-peak reading value also meets average limit and measurement with the average detector is unnecessary.
 3. The emission levels of other frequencies were very low against the limit.
 4. Margin value = Emission level - Limit value
 5. Correction factor = Insertion loss + Cable loss
 6. Emission Level = Correction Factor + Reading Value.

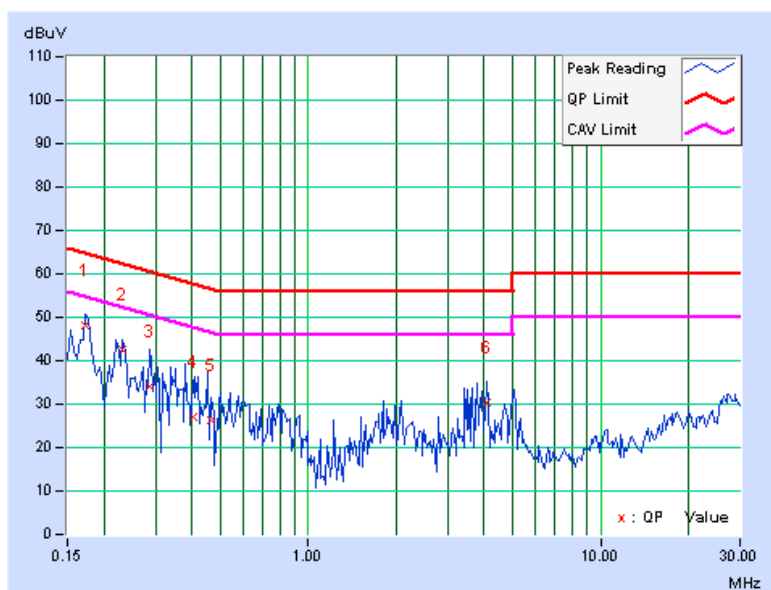

4.2 RADIATED EMISSION MEASUREMENT

4.2.1 LIMITS OF RADIATED EMISSION MEASUREMENT

Emissions radiated outside of the specified bands, shall be according to the general radiated limits in 15.209 as following:

FREQUENCIES (MHz)	FIELD STRENGTH (microvolts/meter)	MEASUREMENT DISTANCE (meters)
0.009 ~ 0.490	2400 / F(kHz)	300
0.490 ~ 1.705	24000 / F(kHz)	30
1.705 ~ 30.0	30	30
30 ~ 88	100	3
88 ~ 216	150	3
216 ~ 960	200	3
Above 960	500	3

NOTE:

1. The lower limit shall apply at the transition frequencies.
2. Emission level (dBuV/m) = 20 log Emission level (uV/m).
3. As shown in 15.35(b), for frequencies above 1000MHz, the field strength limits are based on average detector, however, the peak field strength of any emission shall not exceed the maximum permitted average limits, specified above by more than 20dB under any condition of modulation.



A D T

4.2.2 TEST INSTRUMENTS

Below 1GHz test :

DESCRIPTION & MANUFACTURER	MODEL NO.	SERIAL NO.	CALIBRATED DATE	CALIBRATED UNTIL
ADVANTEST Spectrum Analyzer	U3751	170100022	Nov. 18, 2009	Nov. 17, 2010
ADVANTEST Spectrum Analyzer	U3772	160100280	Sep. 21, 2009	Sep. 20, 2010
HP Pre_Amplifier	8449B	3008A01922	Sep. 25, 2009	Sep. 24, 2010
ROHDE & SCHWARZ Test Receiver	ESCS 30	100027	May 05, 2009	May 04, 2010
SCHWARZBECK Broadband Antenna	VULB-9168	263	April 29, 2009	April 28, 2010
Schwarzbeck Horn_Antenna	BBHA9120	D123	Sep. 21, 2009	Sep. 20, 2010
Schwarzbeck Horn_Antenna	BBHA 9170	BBHA9170153	Jan. 23, 2009	Jan. 22, 2010
RF Switches	EM-H-01-1	1009	Aug. 10, 2009	Aug. 09, 2010
RF Cable	8DFB	STACAB-30M-1GHz-091	Feb. 19, 2009	Feb. 18, 2010
Software	ADT_Radiated_V7.6.15.9.2	NA	NA	NA
CT Antenna Tower & Turn Table	TT100	ADT01	NA	NA
CORCOM AC Filter	MRI2030	107/108	NA	NA

Note: 1. The calibration interval of the above test instruments is 12 months and the calibrations are traceable to NML/ROC and NIST/USA.

2. The horn antenna, HP preamplifier (model: 8449B) and Spectrum Analyzer (model: U3772) are used only for the measurement of emission frequency above 1GHz if tested.

3. The test was performed in Open Site No. A.

4. The VCCI Site Registration No. is R-782.

5. The FCC Site Registration No. is 91097.

6. The CANADA Site Registration No. is IC 7450G-1.



A D T

Above 1GHz test :

DESCRIPTION & MANUFACTURER	MODEL NO.	SERIAL NO.	CALIBRATED DATE	CALIBRATED UNTIL
ROHDE & SCHWARZ Spectrum Analyzer	FSP40	100036	Dec. 9, 2009	Dec. 08, 2010
Agilent PSA Spectrum Analyzer	E4446A	MY46180622	Apr. 24 , 2009	Apr. 23 , 2010
HP Pre_Amplifier	8449B	3008A01923	Nov. 10, 2009	Nov. 09, 2010
ROHDE & SCHWARZ Test Receiver	ESCS30	847124/029	Aug. 28, 2009	Aug. 28, 2010
SCHWARZBECK TRILOG Broadband Antenna	VULB 9168	138	Apr. 29, 2009	Apr. 28, 2010
Schwarzbeck Horn_Antenna	BBHA9120	D124	Dec. 09, 2009	Dec. 08, 2010
Schwarzbeck Horn_Antenna	BBHA 9170	BBHA9170153	Jan. 22, 2009	Jan. 21, 2010
R&S Loop Antenna	HFH2-Z2	100070	Jan. 14, 2008	Jan. 13, 2010
RF Switches	EMH-011	08009	Sep. 26, 2009	Sep. 25, 2010
RF CABLE (Chaintek)	Sucoflex 106	28077	Aug. 14, 2009	Aug. 13, 2010
RF Cable	8D	STCCAB-001	Sep. 26, 2009	Sep. 25, 2010
Software	ADT_Radiated_V7.6.15.9.2	NA	NA	NA
CT Antenna Tower & Turn Table	NA	NA	NA	NA

- Note: 1. The calibration interval of the above test instruments is 12 months and the calibrations are traceable to NML/ROC and NIST/USA.
2. The horn antenna, HP preamplifier (model: 8449B) and Spectrum Analyzer (model: FSP40) are used only for the measurement of emission frequency above 1GHz if tested.
3. The test was performed in Open Site No. C.
4. The FCC Site Registration No. is 656396.
5. The VCCI Site Registration No. is R-1626.
6. The CANADA Site Registration No. is IC 7450G-3.

4.2.3 TEST PROCEDURES

- a. The EUT was placed on the top of a rotating table 0.8 meters above the ground at a 10 meter open area test site. The table was rotated 360 degrees to determine the position of the highest radiation.
- b. The EUT was set 3 meters away from the interference-receiving antenna, which was mounted on the top of a variable-height antenna tower.
- c. The antenna is a broadband antenna, and its height is varied from one meter to four meters above the ground to determine the maximum value of the field strength. Both horizontal and vertical polarizations of the antenna are set to make the measurement.
- d. For each suspected emission, the EUT was arranged to its worst case and then the antenna was tuned to heights from 1 meter to 4 meters and the rotatable table was turned from 0 degrees to 360 degrees to find the maximum reading.
- e. The test-receiver system was set to Peak Detect Function and Specified Bandwidth with Maximum Hold Mode.
- f. If the emission level of the EUT in peak mode was lower than the limit specified, then testing could be stopped and the peak values of the EUT would be reported. Otherwise the emissions would be re-tested one by one using peak, quasi-peak or average method as specified and then reported in a data sheet.

NOTE:

1. The resolution bandwidth and video bandwidth of test receiver/spectrum analyzer is 120kHz for Peak detection (PK) and Quasi-peak detection (QP) at frequency below 1GHz.
2. The resolution bandwidth is 1MHz and video bandwidth of test receiver/spectrum analyzer is 3MHz for Peak detection at frequency above 1GHz.
3. The resolution bandwidth of test receiver/spectrum analyzer is 1MHz and the video bandwidth is 10Hz for Average detection (AV) at frequency above 1GHz.

4.2.4 DEVIATION FROM TEST STANDARD

No deviation

4.2.5 TEST SETUP

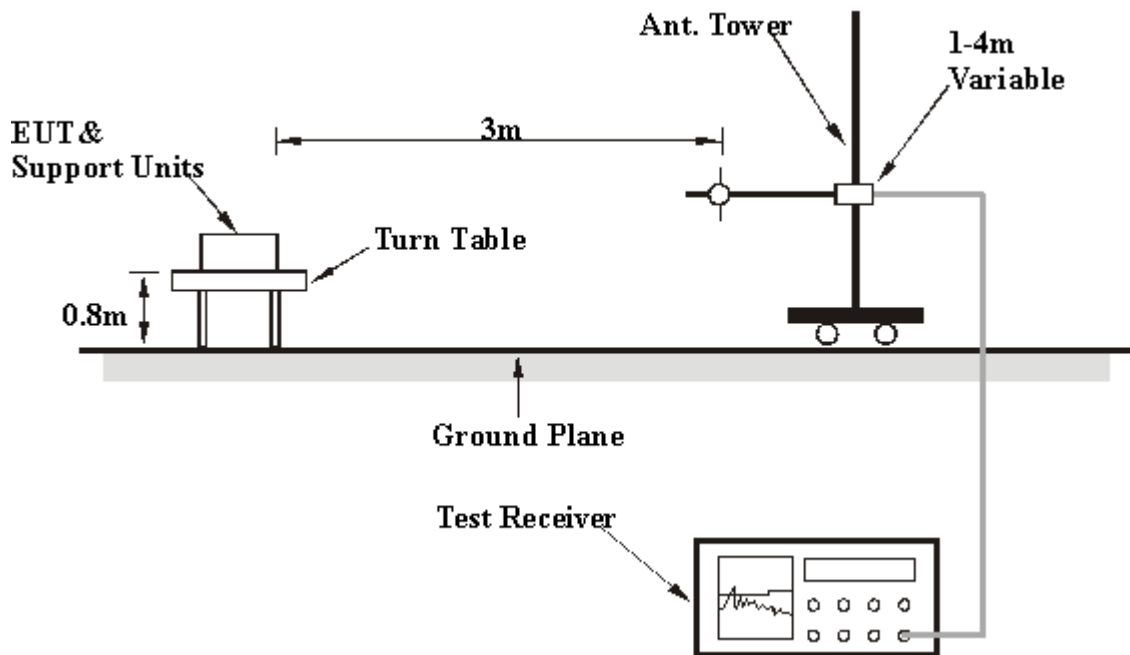

For the actual test configuration, please refer to the related item – Photographs of the Test Configuration.

4.2.6 EUT OPERATING CONDITIONS

Same as the 4.1.6



A D T

Below 1GHz Test Data

4.2.7 TEST RESULTS

BELOW 1GHz WORST-CASE DATA : 802.11g OFDM MODULATION

EUT TEST CONDITION		MEASUREMENT DETAIL	
CHANNEL	Channel 6	FREQUENCY RANGE	Below 1000MHz
INPUT POWER (SYSTEM)	120Vac, 60 Hz	DETECTOR FUNCTION	Quasi-Peak
ENVIRONMENTAL CONDITIONS	20deg. C, 78%RH 1020 hPa	TESTED BY	Timmy Hu

ANTENNA POLARITY & TEST DISTANCE: HORIZONTAL AT 3 M								
No.	Freq. (MHz)	Emission Level (dBuV/m)	Limit (dBuV/m)	Margin (dB)	Antenna Height (m)	Table Angle (Degree)	Raw Value (dBuV)	Correction Factor (dB/m)
1	120.00	39.93 QP	43.50	-3.57	2.72 H	83	27.64	12.29
2	135.48	35.62 QP	43.50	-7.88	2.27 H	75	21.64	13.98
3	360.00	35.88 QP	46.00	-10.12	2.02 H	118	18.39	17.48
4	480.00	34.39 QP	46.00	-11.61	2.13 H	331	13.65	20.74
5	600.00	39.75 QP	46.00	-6.25	1.88 H	48	16.26	23.49
6	719.97	38.87 QP	46.00	-7.13	1.52 H	13	13.54	25.33
7	840.00	40.21 QP	46.00	-5.79	1.08 H	334	12.94	27.26
ANTENNA POLARITY & TEST DISTANCE: VERTICAL AT 3 M								
No.	Freq. (MHz)	Emission Level (dBuV/m)	Limit (dBuV/m)	Margin (dB)	Antenna Height (m)	Table Angle (Degree)	Raw Value (dBuV)	Correction Factor (dB/m)
1	120.00	33.75 QP	43.50	-9.75	1.00 V	39	21.46	12.29
2	135.46	32.83 QP	43.50	-10.67	1.00 V	215	18.85	13.98
3	360.00	34.97 QP	46.00	-11.03	1.00 V	236	17.48	17.48
4	480.00	38.41 QP	46.00	-7.59	1.00 V	180	17.67	20.74
5	600.00	36.81 QP	46.00	-9.19	1.95 V	203	13.32	23.49
6	719.90	33.45 QP	46.00	-12.55	1.88 V	188	8.12	25.33
7	840.00	36.52 QP	46.00	-9.48	1.43 V	28	9.26	27.26

REMARKS: 1. Emission level (dBuV/m) = Raw Value (dBuV) + Correction Factor (dB/m).

2. Correction Factor (dB/m) = Antenna Factor (dB/m) + Cable Factor (dB).

3. The other emission levels were very low against the limit.

4. Margin value = Emission level – Limit value.



Above 1GHz Test Data

4.2.8 TEST RESULTS

802.11n (20MHz) OFDM MODULATION

EUT TEST CONDITION		MEASUREMENT DETAIL	
CHANNEL	Channel 1	FREQUENCY RANGE	1 ~ 25GHz
INPUT POWER (SYSTEM)	120Vac, 60 Hz	DETECTOR FUNCTION	Peak (PK) Average (AV)
ENVIRONMENTAL CONDITIONS	20deg. C, 78%RH 1020 hPa	TESTED BY	Frank Liu

ANTENNA POLARITY & TEST DISTANCE: HORIZONTAL AT 3 M								
NO.	FREQ. (MHz)	EMISSION LEVEL (dBuV/m)	LIMIT (dBuV/m)	MARGIN (dB)	ANTENNA HEIGHT (m)	TABLE ANGLE (Degree)	RAW VALUE (dBuV)	CORRECTION FACTOR (dB/m)
1	2390.00	57.9 PK	74.0	-16.1	1.49 H	61	27.56	30.38
2	2390.00	43.5 AV	54.0	-10.5	1.49 H	61	13.13	30.38
3	*2412.00	99.0 PK			1.46 H	66	68.54	30.46
4	*2412.00	89.0 AV			1.46 H	66	58.54	30.46
5	4824.00	44.9 PK	74.0	-29.1	1.31 H	154	9.01	35.89
6	4824.00	32.4 AV	54.0	-21.6	1.31 H	154	-3.49	35.89
ANTENNA POLARITY & TEST DISTANCE: VERTICAL AT 3 M								
NO.	FREQ. (MHz)	EMISSION LEVEL (dBuV/m)	LIMIT (dBuV/m)	MARGIN (dB)	ANTENNA HEIGHT (m)	TABLE ANGLE (Degree)	RAW VALUE (dBuV)	CORRECTION FACTOR (dB/m)
1	2390.00	64.0 PK	74.0	-10.0	1.67 V	192	33.61	30.38
2	2390.00	48.4 AV	54.0	-5.6	1.67 V	192	18.02	30.38
3	*2412.00	107.3 PK			1.68 V	193	76.84	30.46
4	*2412.00	98.4 AV			1.68 V	193	67.94	30.46
5	4824.00	52.6 PK	74.0	-21.4	1.64 V	182	16.71	35.89
6	4824.00	40.2 AV	54.0	-13.8	1.64 V	182	4.31	35.89

- REMARKS:**
1. Emission level (dBuV/m) = Raw Value (dBuV) + Correction Factor (dB/m).
 2. Correction Factor (dB/m) = Antenna Factor (dB/m) + Cable Factor (dB).
 3. The other emission levels were very low against the limit.
 4. Margin value = Emission level – Limit value.
 5. “ * “: Fundamental frequency.



A D T

EUT TEST CONDITION		MEASUREMENT DETAIL	
CHANNEL	Channel 11	FREQUENCY RANGE	1 ~ 25GHz
INPUT POWER (SYSTEM)	120Vac, 60 Hz	DETECTOR FUNCTION	Peak (PK) Average (AV)
ENVIRONMENTAL CONDITIONS	20deg. C, 78%RH 1020 hPa	TESTED BY	Frank Liu

ANTENNA POLARITY & TEST DISTANCE: HORIZONTAL AT 3 M								
NO.	FREQ. (MHz)	EMISSION LEVEL (dBuV/m)	LIMIT (dBuV/m)	MARGIN (dB)	ANTENNA HEIGHT (m)	TABLE ANGLE (Degree)	RAW VALUE (dBuV)	CORRECTION FACTOR (dB/m)
1	*2462.00	96.4 PK			1.47 H	24	65.75	30.65
2	*2462.00	87.3 AV			1.47 H	24	56.65	30.65
3	2483.50	53.9 PK	74.0	-20.1	1.47 H	32	23.19	30.73
4	2483.50	42.4 AV	54.0	-11.6	1.47 H	32	11.64	30.73
5	4924.00	44.7 PK	74.0	-29.3	1.30 H	159	8.60	36.10
6	4924.00	33.6 AV	54.0	-20.4	1.30 H	159	-2.50	36.10
7	7386.00	47.0 PK	74.0	-27.0	1.37 H	204	4.74	42.26
8	7386.00	36.0 AV	54.0	-18.0	1.37 H	204	-6.26	42.26
ANTENNA POLARITY & TEST DISTANCE: VERTICAL AT 3 M								
NO.	FREQ. (MHz)	EMISSION LEVEL (dBuV/m)	LIMIT (dBuV/m)	MARGIN (dB)	ANTENNA HEIGHT (m)	TABLE ANGLE (Degree)	RAW VALUE (dBuV)	CORRECTION FACTOR (dB/m)
1	*2462.00	105.4 PK			1.65 V	192	74.75	30.65
2	*2462.00	96.2 AV			1.65 V	192	65.55	30.65
3	2483.50	62.5 PK	74.0	-11.5	1.63 V	193	31.73	30.73
4	2483.50	47.3 AV	54.0	-6.7	1.63 V	193	16.53	30.73
5	4924.00	52.1 PK	74.0	-21.9	1.30 V	190	16.00	36.10
6	4924.00	39.0 AV	54.0	-15.0	1.30 V	190	2.90	36.10
7	7386.00	49.0 PK	74.0	-25.0	1.24 V	131	6.74	42.26
8	7386.00	37.0 AV	54.0	-17.0	1.24 V	131	-5.26	42.26

- REMARKS:**
1. Emission level (dBuV/m) = Raw Value (dBuV) + Correction Factor (dB/m).
 2. Correction Factor (dB/m) = Antenna Factor (dB/m) + Cable Factor (dB).
 3. The other emission levels were very low against the limit.
 4. Margin value = Emission level – Limit value.
 5. “ * “: Fundamental frequency.

RESTRICTED BANDEDGE (802.11n (20MHz) MODE,CH1, HORIZONTAL)

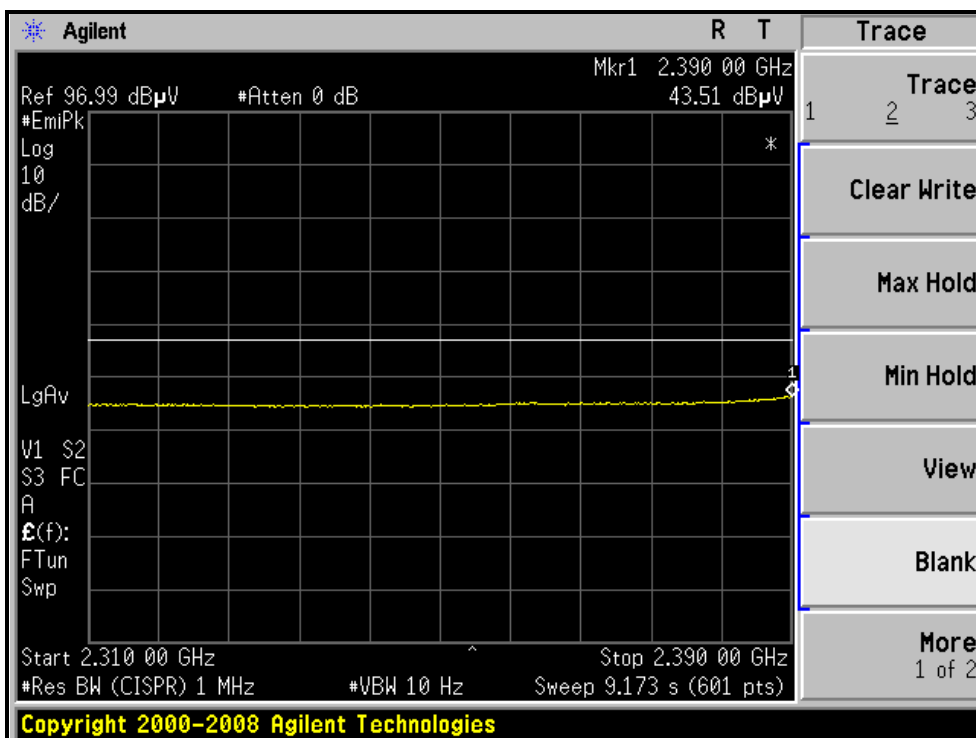
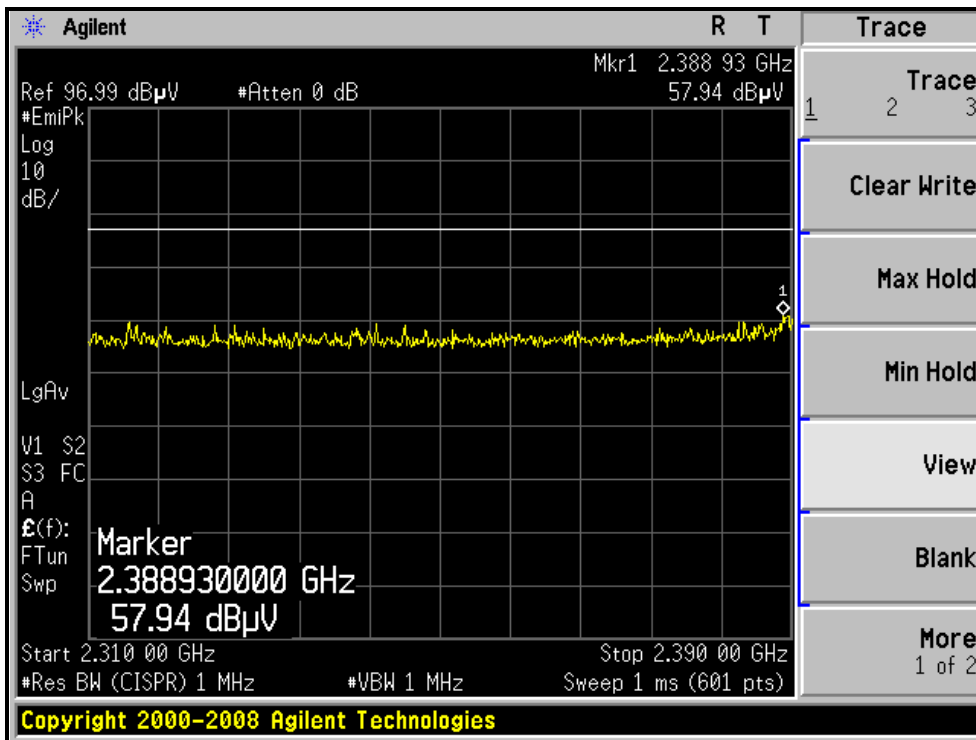

RESTRICTED BANDEDGE (802.11n (20MHz) MODE,CH1, VERTICAL)

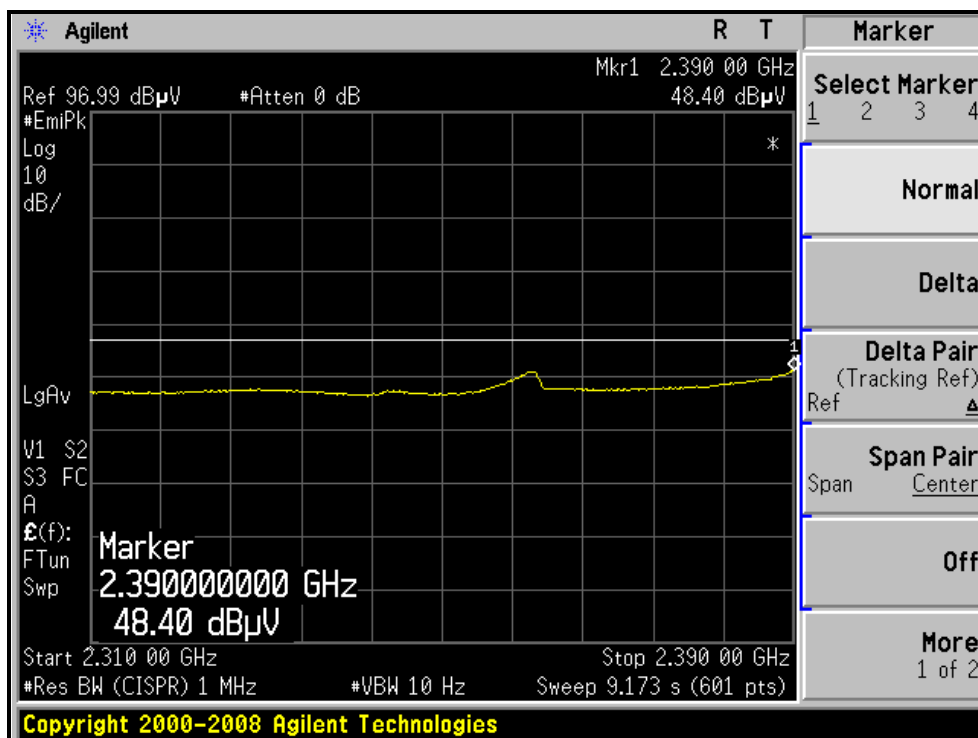
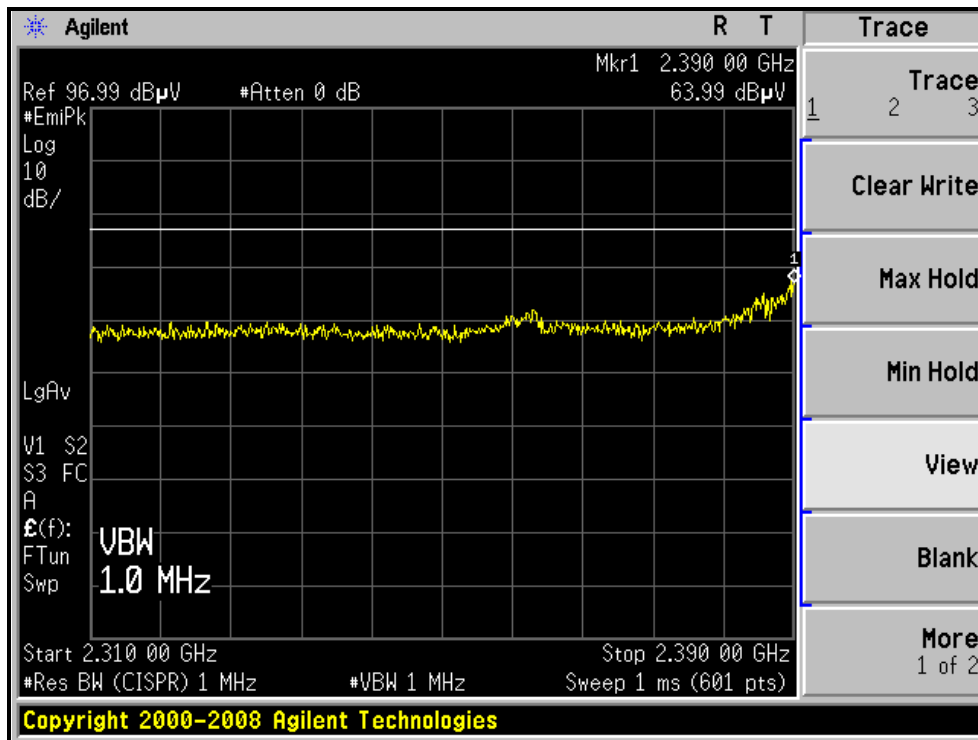

RESTRICTED BANDEDGE (802.11n (20MHz) MODE,CH11, HORIZONTAL)

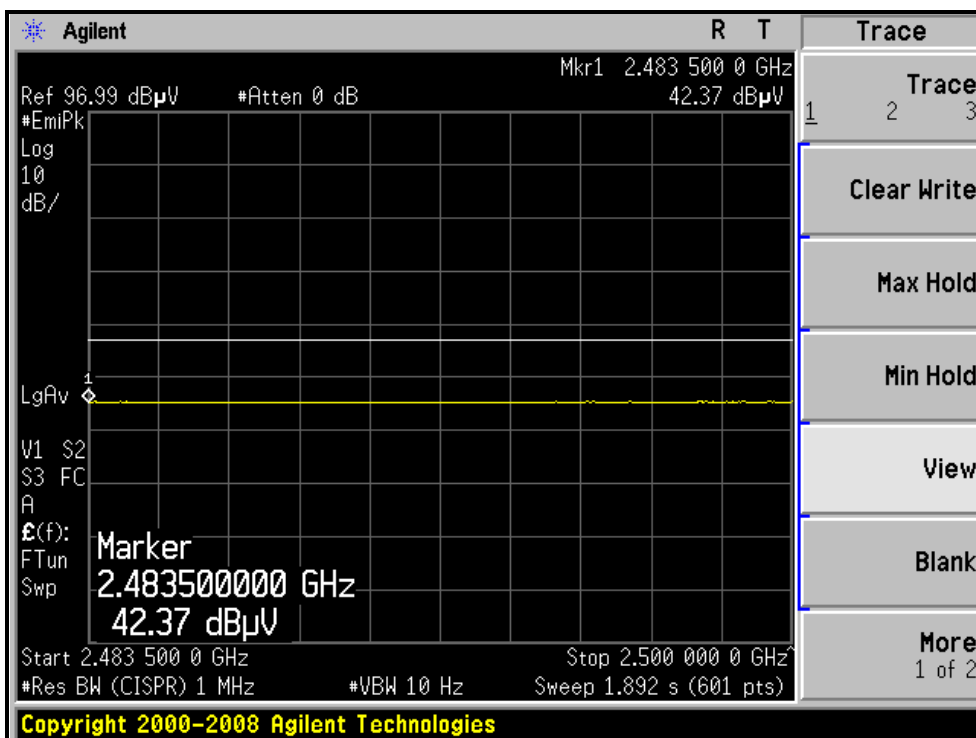
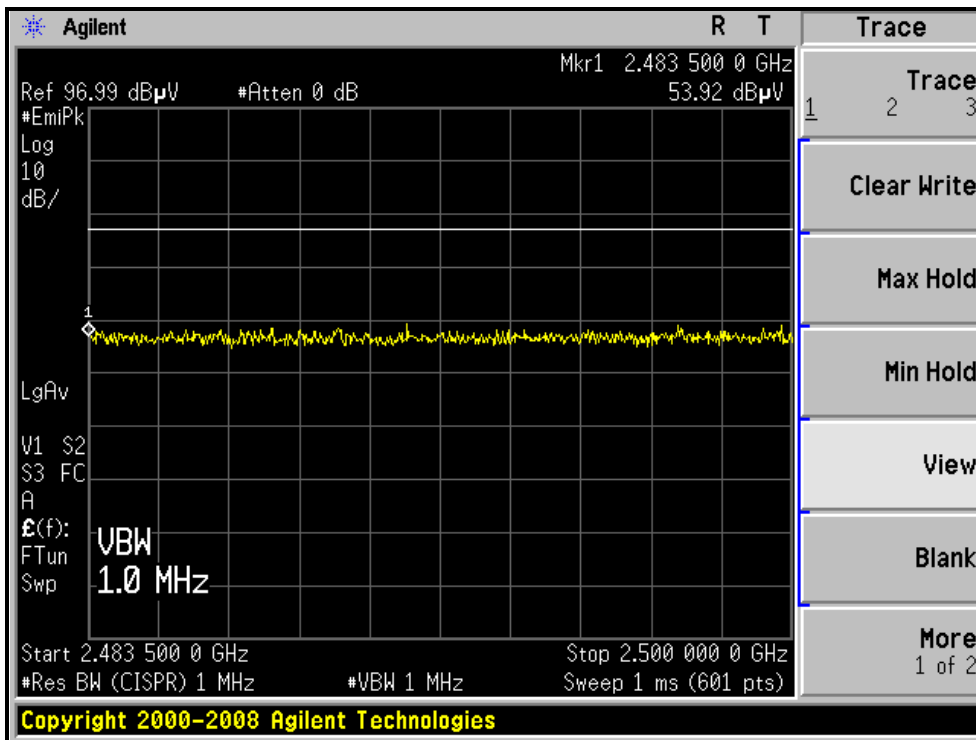

RESTRICTED BANDEDGE (802.11n (20MHz) MODE,CH11, VERTICAL)

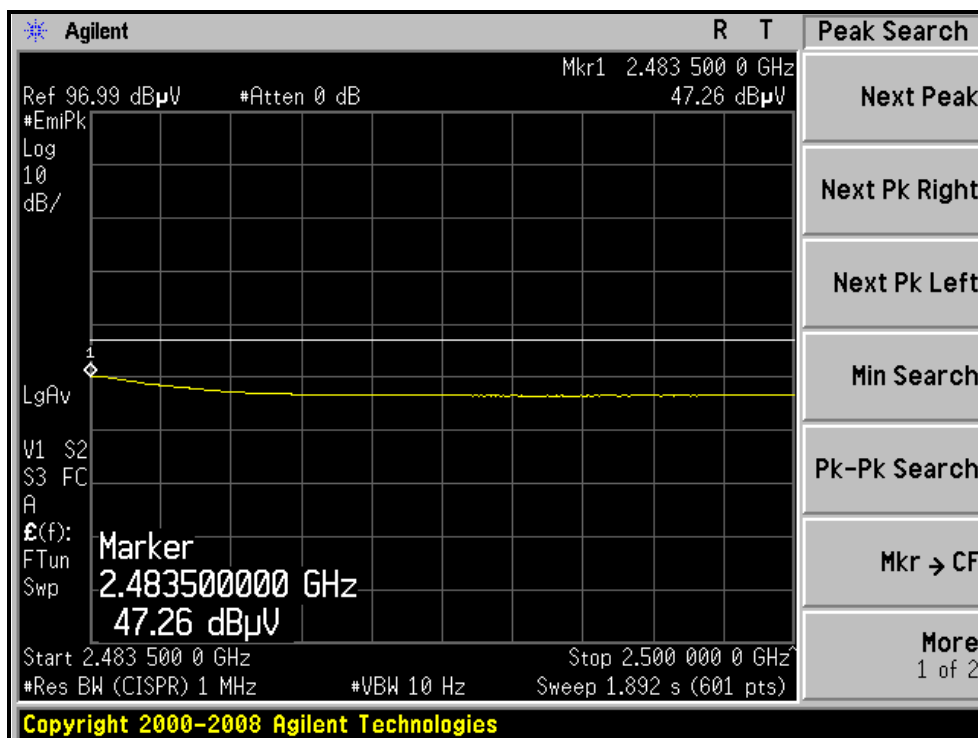
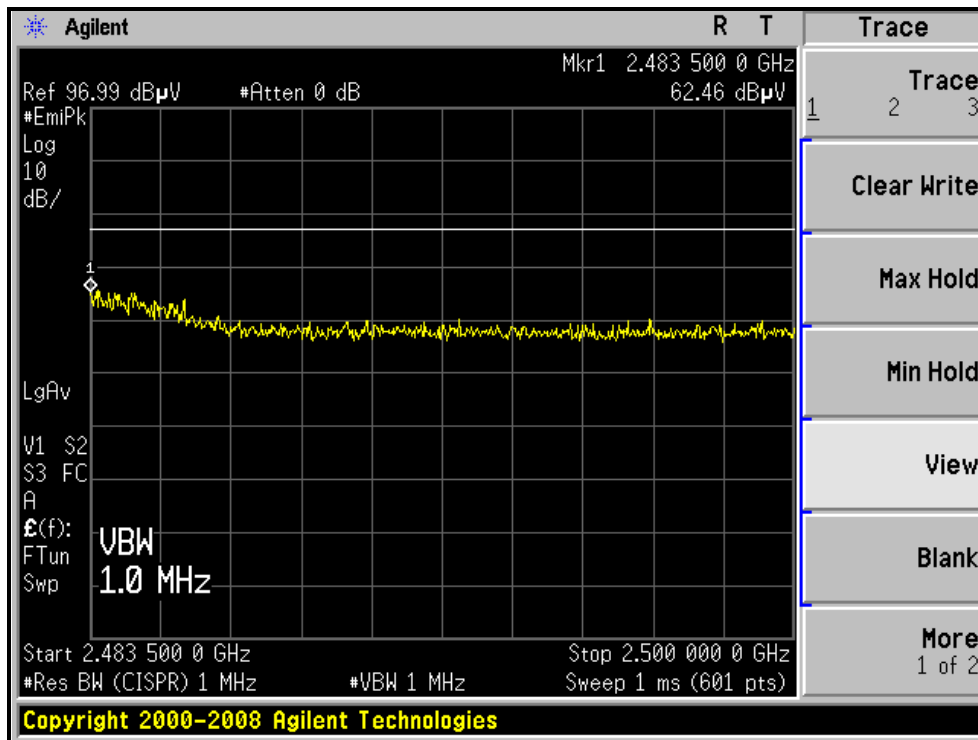

4.3 MAXIMUM PEAK OUTPUT POWER

4.3.1 LIMITS OF MAXIMUM PEAK OUTPUT POWER MEASUREMENT

The Maximum Peak Output Power Measurement is 30dBm.

4.3.2 INSTRUMENTS

Description & Manufacturer	Model no.	Serial No.	Calibrated date	Calibrated Until
Anritsu Power Meter	ML2495A	0824006	April 25, 2009	April 24, 2010
Pulse Power Sensor	MA2411B	0738172	April 25, 2009	April 24, 2010

NOTE:

The calibration interval of the above test instruments is 12 months and the calibrations are traceable to NML/ROC and NIST/USA.

4.4.3 TEST PROCEDURES

1. The transmitter output was connected to the power meter through an attenuator; the bandwidth of the fundamental frequency was measured with the power meter.
2. Record the power level.

4.4.4 DEVIATION FROM TEST STANDARD

No deviation

4.4.5 TEST SETUP

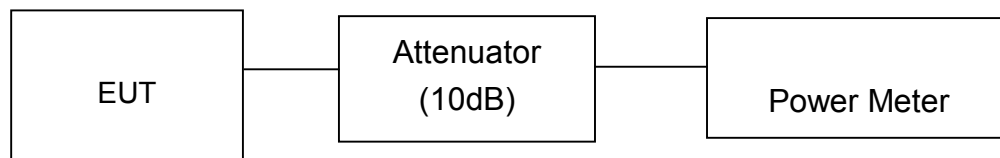

4.4.6 EUT OPERATING CONDITIONS

Same as Item 4.2.6

4.4.7 TEST RESULTS

802.11b DSSS MODULATION:

CHANNEL	CHANNEL FREQUENCY (MHz)	PEAK POWER OUTPUT (dBm)	PEAK POWER OUTPUT (mW)	PEAK POWER LIMIT (dBm)	PASS / FAIL
1	2412	15.2	33.1	29	PASS
6	2437	16.3	42.7	29	PASS
11	2462	16.1	40.7	29	PASS

802.11g OFDM modulation:

CHANNEL	CHANNEL FREQUENCY (MHz)	PEAK POWER OUTPUT (dBm)	PEAK POWER OUTPUT (mW)	PEAK POWER LIMIT (dBm)	PASS / FAIL
1	2412	26.9	489.8	29	PASS
6	2437	28.6	724.4	29	PASS
11	2462	27.0	501.2	29	PASS

802.11n (20MHz) OFDM modulation:

CHANNEL	CHANNEL FREQUENCY (MHz)	PEAK POWER OUTPUT (dBm)	PEAK POWER OUTPUT (mW)	PEAK POWER LIMIT (dBm)	PASS / FAIL
1	2412	26.9	489.8	29	PASS
6	2437	27.9	616.6	29	PASS
11	2462	25.7	371.5	29	PASS

802.11n (40MHz) OFDM modulation:

CHANNEL	CHANNEL FREQUENCY (MHz)	PEAK POWER OUTPUT (dBm)	PEAK POWER OUTPUT (mW)	PEAK POWER LIMIT (dBm)	PASS / FAIL
1	2412	25.9	389.0	29	PASS
4	2437	27.5	562.3	29	PASS
7	2462	22.8	190.5	29	PASS



A D T

5. INFORMATION ON THE TESTING LABORATORIES

We, Bureau Veritas Consumer Products Services (H.K.) Ltd., Taoyuan Branch, were founded in 1988 to provide our best service in EMC, Radio, Telecom and Safety consultation. Our laboratories are accredited and approved by the following approval agencies according to ISO/IEC 17025.

USA	FCC, NVLAP
Germany	TUV Rheinland
Japan	VCCI
Norway	NEMKO
Canada	INDUSTRY CANADA, CSA
R.O.C.	TAF, BSMI, NCC
Netherlands	Telefication
Singapore	GOST-ASIA(MOU)
Russia	CERTIS(MOU)

Copies of accreditation certificates of our laboratories obtained from approval agencies can be downloaded from our web site: www.adt.com.tw/index.5/phtml.

If you have any comments, please feel free to contact us at the following:

Linko EMC/RF Lab:

Tel: 886-2-26052180

Fax: 886-2-26052943

Hsin Chu EMC/RF Lab:

Tel: 886-3-5935343

Fax: 886-3-5935342

Hwa Ya EMC/RF/Safety Telecom Lab:

Tel: 886-3-3183232

Fax: 886-3-3185050

Web Site: www.adt.com.tw

The address and road map of all our labs can be found in our web site also.



A D T

6. APPENDIX - A MODIFICATIONS RECORDERS FOR ENGINEERING CHANGES TO THE EUT BY THE LAB

No any modifications are made to the EUT by the lab during the test.

--- END ---