

FCC 47 CFR PART 15 SUBPART E

CERTIFICATION TEST REPORT

For

WIFI module

MODEL No.: BW2569-32P

FCC ID: VYVBW2569-32P

Trade Mark: N/A

REPORT NO.: ES160321030E4

ISSUE DATE: May 30,2016

Prepared for

Iton Technology Crop.

Room 1302, Block A, Building 4, Tianan Cyber Park, HuanggeRoad, Longgang
District, Shenzhen, China.

Prepared by

EMTEK(SHENZHEN) CO., LTD.

Bldg 69, Majialong Industry Zone, Nanshan District,
Shenzhen, Guangdong, China
TEL: 86-755-26954280
FAX: 86-755-26954282

1 TEST RESULT CERTIFICATION

Applicant:	Iton Technology Crop. Room 201,2nd Floor, Building 20, No 1006 Yitian Road, Futian District, Shenzhen,China
Manufacturer:	Iton Technology Crop. Room 201,2nd Floor, Building 20, No 1006 Yitian Road, Futian District, Shenzhen,China
Product Description:	WIFI module
Model Number:	BW2569-32P
File Number:	ES160321030E4
Date of Test:	March 22, 2016 to May 30, 2016

Measurement Procedure Used:

APPLICABLE STANDARDS	
STANDARD	TEST RESULT
FCC 47 CFR Part 2, Subpart J FCC 47 CFR Part 15, Subpart E	PASS

The above equipment was tested by EMTEK(SHENZHEN) CO., LTD.. The test data, data evaluation, test procedures, and equipment configurations shown in this report were made in accordance with the procedures given in ANSI C63.10 (2013) and the energy emitted by the sample EUT tested as described in this report is in compliance with the requirements of FCC Rules Part 2 and Part 15.407

The test results of this report relate only to the tested sample identified in this report.

Date of Test : March 22, 2016 to May 30, 2016

Prepared by : Joe Xia
Joe Xia/Editor

Reviewer : Jack Li
Jack Li/Supervisor

Approve & Authorized Signer : [Signature]
Lisa Wang/Manager



TABLE OF CONTENTS

1 TEST RESULT CERTIFICATION.....2

2 EUT TECHNICAL DESCRIPTION4

3 SUMMARY OF TEST RESULT6

4 TEST METHODOLOGY7

4.1 GENERAL DESCRIPTION OF APPLIED STANDARDS7

4.2 MEASUREMENT EQUIPMENT USED7

4.3 DESCRIPTION OF TEST MODES.....8

5 FACILITIES AND ACCREDITATIONS13

5.1 FACILITIES13

5.2 LABORATORY ACCREDITATIONS AND LISTINGS13

6 TEST SYSTEM UNCERTAINTY14

7 SETUP OF EQUIPMENT UNDER TEST15

7.1 RADIO FREQUENCY TEST SETUP.....15

7.2 RADIO FREQUENCY TEST SETUP.....15

7.3 CONDUCTED EMISSION TEST SETUP17

7.4 BLOCK DIAGRAM CONFIGURATION OF TEST SYSTEM18

7.5 SUPPORT EQUIPMENT.....18

8 TEST REQUIREMENTS.....19

8.1 BANDWIDTH MEASUREMENT19

8.2 MAXIMUM CONDUCTED OUTPUT POWER.....96

8.3 MAXIMUM PEAK POWER DENSITY104

8.4 FREQUENCY STABILITY168

8.5 UNDESIRABLE RADIATED SPURIOUS EMISSION.....191

8.6 POWER LINE CONDUCTED EMISSIONS234

8.7 ANTENNA APPLICATION237

2 EUT TECHNICAL DESCRIPTION

Characteristics	Description																																												
Device Type	Wifi 5.8G Device																																												
IEEE 802.11 WLAN Mode Supported	<input checked="" type="checkbox"/> 802.11a(20MHz channel bandwidth) <input checked="" type="checkbox"/> 802.11n(20MHz channel bandwidth) <input checked="" type="checkbox"/> 802.11n(40MHz channel bandwidth) <input checked="" type="checkbox"/> 802.11ac(20MHz channel bandwidth) <input checked="" type="checkbox"/> 802.11ac(40MHz channel bandwidth) <input checked="" type="checkbox"/> 802.11ac(80MHz channel bandwidth)																																												
Data Rate	<input checked="" type="checkbox"/> 802.11a:6, 9, 12, 18, 24, 36, 48, 54Mbps; <input checked="" type="checkbox"/> 802.11n(HT20): MCS0-MCS15; <input checked="" type="checkbox"/> 802.11n(HT40): MCS0-MCS15; <input checked="" type="checkbox"/> 802.11ac(HT20): MCS0-MCS15; <input checked="" type="checkbox"/> 802.11ac(HT40):MCS0-MCS19; <input checked="" type="checkbox"/> 802.11ac(VHT80):MCS0-MCS19;																																												
MIMO Mode	2TX2RX																																												
Modulation	<input checked="" type="checkbox"/> OFDM with BPSK/QPSK/16QAM/64QAM for 802.11a/g/n; <input checked="" type="checkbox"/> OFDM with BPSK/QPSK/16QAM/64QAM/256QAM for 802.11ac;																																												
Operating Frequency Range	<table border="1"> <thead> <tr> <th>Band</th> <th>Mode</th> <th>Frequency Range(MHz)</th> <th>Number of channels</th> </tr> </thead> <tbody> <tr> <td rowspan="3">UNII Band I</td> <td>802.11a/n(HT20)/ac(VHT20)</td> <td>5180-5240</td> <td>4</td> </tr> <tr> <td>802.11n(HT40)/ac(VHT40)</td> <td>5190-5230</td> <td>2</td> </tr> <tr> <td>802.11 ac(VHT80)</td> <td>5210MHz</td> <td>1</td> </tr> <tr> <td rowspan="3">UNII Band II-A</td> <td>802.11a/n(HT20)/ac(VHT20)</td> <td>5260-5320</td> <td>4</td> </tr> <tr> <td>802.11n(HT40)/ac(VHT40)</td> <td>5270-5310</td> <td>2</td> </tr> <tr> <td>802.11 ac(VHT80)</td> <td>5290</td> <td>1</td> </tr> <tr> <td rowspan="3">UNII Band II-C</td> <td>802.11a/n(HT20)/ac(VHT20)</td> <td>5500-5700</td> <td>11</td> </tr> <tr> <td>802.11n(HT40)/ac(VHT40)</td> <td>5510-5670</td> <td>5</td> </tr> <tr> <td>802.11 ac(VHT80)</td> <td>5530-5610</td> <td>2</td> </tr> <tr> <td rowspan="3">UNII Band III</td> <td>802.11a/n(HT20)/ac(VHT20)</td> <td>5745-5825</td> <td>5</td> </tr> <tr> <td>802.11n(HT40)/ac(VHT40)</td> <td>5755-5795</td> <td>2</td> </tr> <tr> <td>802.11 ac(VHT80)</td> <td>5775</td> <td>1</td> </tr> </tbody> </table>	Band	Mode	Frequency Range(MHz)	Number of channels	UNII Band I	802.11a/n(HT20)/ac(VHT20)	5180-5240	4	802.11n(HT40)/ac(VHT40)	5190-5230	2	802.11 ac(VHT80)	5210MHz	1	UNII Band II-A	802.11a/n(HT20)/ac(VHT20)	5260-5320	4	802.11n(HT40)/ac(VHT40)	5270-5310	2	802.11 ac(VHT80)	5290	1	UNII Band II-C	802.11a/n(HT20)/ac(VHT20)	5500-5700	11	802.11n(HT40)/ac(VHT40)	5510-5670	5	802.11 ac(VHT80)	5530-5610	2	UNII Band III	802.11a/n(HT20)/ac(VHT20)	5745-5825	5	802.11n(HT40)/ac(VHT40)	5755-5795	2	802.11 ac(VHT80)	5775	1
	Band	Mode	Frequency Range(MHz)	Number of channels																																									
	UNII Band I	802.11a/n(HT20)/ac(VHT20)	5180-5240	4																																									
		802.11n(HT40)/ac(VHT40)	5190-5230	2																																									
		802.11 ac(VHT80)	5210MHz	1																																									
	UNII Band II-A	802.11a/n(HT20)/ac(VHT20)	5260-5320	4																																									
		802.11n(HT40)/ac(VHT40)	5270-5310	2																																									
		802.11 ac(VHT80)	5290	1																																									
	UNII Band II-C	802.11a/n(HT20)/ac(VHT20)	5500-5700	11																																									
		802.11n(HT40)/ac(VHT40)	5510-5670	5																																									
		802.11 ac(VHT80)	5530-5610	2																																									
	UNII Band III	802.11a/n(HT20)/ac(VHT20)	5745-5825	5																																									
802.11n(HT40)/ac(VHT40)		5755-5795	2																																										
802.11 ac(VHT80)		5775	1																																										
Transmit Power Max	UNII Band I for 16.82dBm UNII Band II-A for 17.65dBm UNII Band II-C for 14.71dBm UNII Band III for 11.63dBm																																												
Antenna Type	Monolithic SMD Antenna																																												
Smart system	<input type="checkbox"/> SISO for 802.11a/n <input checked="" type="checkbox"/> MIMO for 802.11n/ac																																												
Antenna Gain	2dBi																																												

Array Gain	5dBi
Power supply	<input checked="" type="checkbox"/> DC supply: DC 3.3V
	<input checked="" type="checkbox"/> Adapter supply: N/A

Note: for more details, please refer to the User's manual of the EUT.

3 SUMMARY OF TEST RESULT

FCC Part Clause	Test Parameter	Verdict	Remark
15.407 (a) 15.407 (e)	99% , 6dB and 26dB Bandwidth	PASS	
15.407 (a)	Maximum Conducted Output Power	PASS	
15.407 (a)	Peak Power Spectral Density	PASS	
15.407 (b)	Radiated Spurious Emission	PASS	
15.407(g)	Frequency Stability	PASS	
15.407 (b)(6) 15.207	Power Line Conducted Emission	PASS	
15.407(a) 15.203	Antenna Application	PASS	
NOTE1: N/A (Not Applicable) NOTE2: According to FCC OET KDB 789003 D2 General UNII Test Procedures New Rules v01r02, In addition, the radiated test is also performed to ensure the emissions emanating from the device cabinet also comply with the applicable limits.			

RELATED SUBMITTAL(S) / GRANT(S):

This submittal(s) (test report) is intended for FCC ID: VYVBW2569-32P filing to comply with Section 15.247 of the FCC Part 15, Subpart E Rules.

4 TEST METHODOLOGY

4.1 GENERAL DESCRIPTION OF APPLIED STANDARDS

According to its specifications, the EUT must comply with the requirements of the following standards:

FCC 47 CFR Part 2, Subpart J

FCC 47 CFR Part 15, Subpart E

FCC KDB 789003 D2 General UNII Test Procedures New Rules v01r02

FCC KDB 662911 D01 Multiple Transmitter Output v02r01

FCC KDB 662911 D02 MIMO With Cross Polarized Antenna V01

4.2 MEASUREMENT EQUIPMENT USED

4.2.1 Conducted Emission Test Equipment

EQUIPMENT TYPE	MFR	MODEL NUMBER	SERIAL NUMBER	LAST CAL.
Test Receiver	Rohde & Schwarz	ESCS30	828985/018	05/16/2015
L.I.S.N.	Schwarzbeck	NNLK8129	8129203	05/16/2015
50Ω Coaxial Switch	Anritsu	MP59B	M20531	N/A
Pulse Limiter	Rohde & Schwarz	ESH3-Z2	100006	05/16/2015
Voltage Probe	Rohde & Schwarz	TK9416	N/A	05/16/2015
I.S.N	Rohde & Schwarz	ENY22	1109.9508.02	05/16/2015

4.2.2 Radiated Emission Test Equipment

EQUIPMENT TYPE	MFR	MODEL NUMBER	SERIAL NUMBER	LAST CAL.
EMI Test Receiver	Rohde & Schwarz	ESU	1302.6005.26	05/16/2015
Pre-Amplifier	HP	8447D	2944A07999	05/16/2015
Bilog Antenna	Schwarzbeck	VULB9163	142	05/16/2015
Loop Antenna	ARA	PLA-1030/B	1029	05/16/2015
Horn Antenna	Schwarzbeck	BBHA 9170	BBHA9170399	05/16/2015
Horn Antenna	Schwarzbeck	BBHA 9120	D143	05/16/2015
Cable	Schwarzbeck	AK9513	ACRX1	05/16/2015
Cable	Rosenberger	N/A	FP2RX2	05/16/2015
Cable	Schwarzbeck	AK9513	CRPX1	05/16/2015
Cable	Schwarzbeck	AK9513	CRRX2	05/16/2015

4.2.3 Radio Frequency Test Equipment

EQUIPMENT TYPE	MFR	MODEL NUMBER	SERIAL NUMBER	LAST CAL.
Spectrum Analyzer	Agilent	E4407B	88156318	05/16/2015
Signal Analyzer	Agilent	N9010A	My53470879	05/16/2015
Power meter	Anritsu	ML2495A	0824006	05/16/2015
Power sensor	Anritsu	MA2411B	0738172	05/16/2015

Remark: Each piece of equipment is scheduled for calibration once a year.

4.3 DESCRIPTION OF TEST MODES

The EUT has been tested under its typical operating condition.

The EUT configuration for testing is installed on RF field strength measurement to meet the Commissions requirement and operating in a manner which intends to maximize its emission characteristics in a continuous normal application.

The Transmitter was operated in the normal operating mode. The TX frequency was fixed which was for the purpose of the measurements.

Test of channel included the lowest and middle and highest frequency to perform the test, then record on this report.

Those data rates (802.11a: 6 Mbps; 802.11n (HT20): MCS0; 802.11n (HT20): MCS15; 802.11n (HT40): MCS0; 802.11n (HT40): MCS15; 802.11ac (HT20): MCS0; 802.11ac (HT20): MCS15; 802.11ac (HT40): MCS0; 802.11ac (HT40): MCS19; 802.11ac (HT80): MCS0; 802.11ac (HT80): MCS19;) were used for all test.

Pre-defined engineering program for regulatory testing used to control the EUT for staying in continuous transmitting and receiving mode is programmed.

Wifi 5G with UNII Band I

Frequency and Channel list for 802.11a/n(HT20)/ac(VHT20):

Channel	Frequency (MHz)	Channel	Frequency (MHz)	Channel	Frequency (MHz)
36	5180	44	5220		
40	5200	48	5240		

Frequency and Channel list for 802.11n(HT40)/ac(VHT40):

Channel	Frequency (MHz)	Channel	Frequency (MHz)	Channel	Frequency (MHz)
38	5190				
46	5230				

Frequency and Channel list for 802.11ac(VHT80):

Channel	Frequency (MHz)	Channel	Frequency (MHz)	Channel	Frequency (MHz)
42	5210				

Test Frequency and Channel for 802.11a/n(HT20)/ac(VHT20):

Lowest Frequency		Middle Frequency		Highest Frequency	
Channel	Frequency (MHz)	Channel	Frequency (MHz)	Channel	Frequency (MHz)
36	5180	40	5200	48	5240

Test Frequency and channel for 802.11n(VHT40)/ac(VHT40):

Lowest Frequency		Middle Frequency		Highest Frequency	
Channel	Frequency (MHz)	Channel	Frequency (MHz)	Channel	Frequency (MHz)
38	5190	N/A	N/A	46	5230

Test Frequency and channel for 802.11ac(HT80):

Lowest Frequency		Middle Frequency		Highest Frequency	
Channel	Frequency (MHz)	Channel	Frequency (MHz)	Channel	Frequency (MHz)
42	5210	N/A	N/A	N/A	N/A

Wifi 5G with UNII Band II-A

Frequency and Channel list for 802.11a/n(HT20)/ac(VHT20):

Channel	Frequency (MHz)	Channel	Frequency (MHz)	Channel	Frequency (MHz)
52	5260	60	5300		
56	5280	64	5320		

Frequency and Channel list for 802.11n(VHT40)/ac(VHT40):

Channel	Frequency (MHz)	Channel	Frequency (MHz)	Channel	Frequency (MHz)
54	5270				
62	5310				

Frequency and Channel list for 802.11ac(VHT80):

Channel	Frequency (MHz)	Channel	Frequency (MHz)	Channel	Frequency (MHz)
58	5290				

Test Frequency and Channel for 802.11a/n(HT20)/ac(VHT20):

Lowest Frequency		Middle Frequency		Highest Frequency	
Channel	Frequency (MHz)	Channel	Frequency (MHz)	Channel	Frequency (MHz)
52	5260	56	5280	64	5320

Test Frequency and channel for 802.11n(HT40)/ac(VHT40):

Lowest Frequency		Middle Frequency		Highest Frequency	
Channel	Frequency (MHz)	Channel	Frequency (MHz)	Channel	Frequency (MHz)
54	5270	N/A	N/A	62	5310

Test Frequency and channel for 802.11ac(VHT80):

Lowest Frequency		Middle Frequency		Highest Frequency	
Channel	Frequency (MHz)	Channel	Frequency (MHz)	Channel	Frequency (MHz)
58	5290	N/A	N/A	N/A	N/A

Wifi 5G with UNII Band II-C

Frequency and Channel list for 802.11a/n(HT20)/ac(VHT20):

Channel	Frequency (MHz)	Channel	Frequency (MHz)	Channel	Frequency (MHz)
100	5500	116	5580	132	5660
104	5520	120	5600	136	5680
108	5540	124	5620	140	5700
112	5560	128	5640		

Frequency and Channel list for 802.11n(VHT40)/ac(VHT40):

Channel	Frequency (MHz)	Channel	Frequency (MHz)	Channel	Frequency (MHz)
102	5510	126	5630		
110	5550	134	5670		
118	5590				

Frequency and Channel list for 802.11ac(VHT80):

Channel	Frequency (MHz)	Channel	Frequency (MHz)	Channel	Frequency (MHz)
106	5530				
122	5610				

Test Frequency and Channel for 802.11a/n(HT20)/ac(VHT20):

Lowest Frequency		Middle Frequency		Highest Frequency	
Channel	Frequency (MHz)	Channel	Frequency (MHz)	Channel	Frequency (MHz)
100	5500	120	5600	140	5700

Test Frequency and channel for 802.11n(VHT40)/ac(VHT40):

Lowest Frequency		Middle Frequency		Highest Frequency	
Channel	Frequency (MHz)	Channel	Frequency (MHz)	Channel	Frequency (MHz)
102	5510	118	5590	134	5670

Test Frequency and channel for 802.11ac(VHT80):

Lowest Frequency		Middle Frequency		Highest Frequency	
Channel	Frequency (MHz)	Channel	Frequency (MHz)	Channel	Frequency (MHz)
106	5530	N/A	N/A	122	5610

Wifi 5G with UNII Band III

Frequency and Channel list for 802.11a/n(HT20)/ac(VHT20):

Channel	Frequency (MHz)	Channel	Frequency (MHz)	Channel	Frequency (MHz)
149	5745	157	5785	165	5825
153	5765	161	5805		

Frequency and Channel list for 802.11n(HT40)/ac(VHT40):

Channel	Frequency (MHz)	Channel	Frequency (MHz)	Channel	Frequency (MHz)
151	5755				
159	5795				

Frequency and Channel list for 802.11ac(VHT80):

Channel	Frequency (MHz)	Channel	Frequency (MHz)	Channel	Frequency (MHz)
155	5775				

Test Frequency and Channel for 802.11a/n(HT20)/ac(VHT20):

Lowest Frequency		Middle Frequency		Highest Frequency	
Channel	Frequency (MHz)	Channel	Frequency (MHz)	Channel	Frequency (MHz)
149	5745	157	5785	165	5825

Test Frequency and channel for 802.11n(HT40)/ac(VHT40):

Lowest Frequency		Middle Frequency		Highest Frequency	
Channel	Frequency (MHz)	Channel	Frequency (MHz)	Channel	Frequency (MHz)
151	5755	N/A	N/A	159	5795

Test Frequency and channel for 802.11ac(VHT80):

Lowest Frequency		Middle Frequency		Highest Frequency	
Channel	Frequency (MHz)	Channel	Frequency (MHz)	Channel	Frequency (MHz)
155	5775				

5 FACILITIES AND ACCREDITATIONS

5.1 FACILITIES

All measurement facilities used to collect the measurement data are located at

Bldg 69, Majialong Industry Zone District, Nanshan District, Shenzhen, China

The sites are constructed in conformance with the requirements of ANSI C63.7, ANSI C63.10 and CISPR Publication 22.

5.2 LABORATORY ACCREDITATIONS AND LISTINGS

Site Description

EMC Lab.

: Accredited by CNAS, 2013.10.29

The certificate is valid until 2016.10.28

The Laboratory has been assessed and proved to be in compliance with CNAS-CL01:2006 (identical to ISO/IEC 17025:2005)

The Certificate Registration Number is L2291.

Accredited by TUV Rheinland Shenzhen 2015.4

The Laboratory has been assessed according to the requirements ISO/IEC 17025.

Accredited by FCC, April 17, 2013

The Certificate Registration Number is 709623.

Accredited by FCC, July 24, 2013

The Certificate Registration Number is 406365.

Accredited by Industry Canada, November 29, 2012

The Certificate Registration Number is 4480A.

Name of Firm

: EMTEK(SHENZHEN) CO., LTD..

Site Location

: Bldg 69, Majialong Industry Zone,
Nanshan District, Shenzhen, Guangdong, China

6 TEST SYSTEM UNCERTAINTY

The following measurement uncertainty levels have been estimated for tests performed on the apparatus:

Parameter	Uncertainty
Radio Frequency	$\pm 1 \times 10^{-5}$
Maximum Peak Output Power Test	$\pm 1.0\text{dB}$
Conducted Emissions Test	$\pm 2.0\text{dB}$
Radiated Emission Test	$\pm 2.0\text{dB}$
Power Density	$\pm 2.0\text{dB}$
Occupied Bandwidth Test	$\pm 1.0\text{dB}$
Band Edge Test	$\pm 3\text{dB}$
All emission, radiated	$\pm 3\text{dB}$
Antenna Port Emission	$\pm 3\text{dB}$
Temperature	$\pm 0.5^\circ\text{C}$
Humidity	$\pm 3\%$

Measurement Uncertainty for a level of Confidence of 95%

7 SETUP OF EQUIPMENT UNDER TEST

7.1 RADIO FREQUENCY TEST SETUP

The WLAN component's antenna ports(s) of the EUT are connected to the measurement instrument per an appropriate attenuator. The EUT is controlled by PC/software to emit the specified signals for the purpose of measurements.

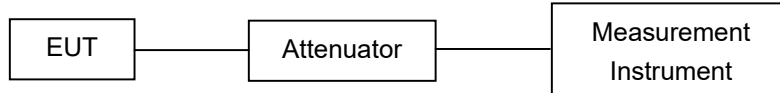

7.2 RADIO FREQUENCY TEST SETUP

The test site semi-anechoic chamber has met the requirement of NSA tolerance 4 dB according to the standards: ANSI C63.10. The test distance is 3m. The setup is according to the requirements in Section 13.1.4.1 of ANSI C63.10-2013 and CAN/CSA-CEI/IEC CISPR 22.

Below 30MHz:

The EUT is placed on a turntable 0.8 meters above the ground in the chamber, 3 meter away from the antenna (loop antenna). The Antenna should be positioned with its plane vertical at the specified distance from the EUT and rotated about its vertical axis for maximum response at each azimuth about the EUT. The center of the loop shall be 1 m above the ground. For certain applications, the loop antenna plane may also need to be positioned horizontally at the specified distance from the EUT.

Above 30MHz:

The EUT is placed on a turntable 0.8 meters above the ground in the chamber, 3 meter away from the antenna. The maximal emission value is acquired by adjusting the antenna height, polarisation and turntable azimuth. Normally, the height range of antenna is 1 m to 4 m, the azimuth range of turntable is 0° to 360°, and the receive antenna has two polarizations Vertical (V) and Horizontal (H).

Above 1GHz:

(Note: the FCC's permission to use 1.5m as an alternative per TCBC Conf call of Dec. 2, 2014.)

The EUT is placed on a turntable 1.5 meters above the ground in the chamber, 3 meter away from the antenna. The maximal emission value is acquired by adjusting the antenna height, polarisation and turntable azimuth. Normally, the height range of antenna is 1 m to 4 m, the azimuth range of turntable is 0° to 360°, and the receive antenna has two polarizations Vertical (V) and Horizontal (H).

(a) Radiated Emission Test Set-Up, Frequency Below 30MHz

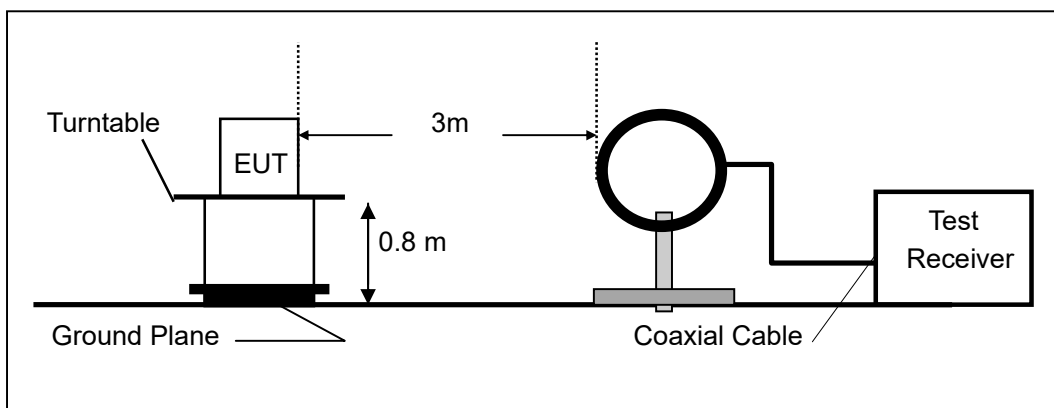

(b) Radiated Emission Test Set-Up, Frequency Below 1000MHz

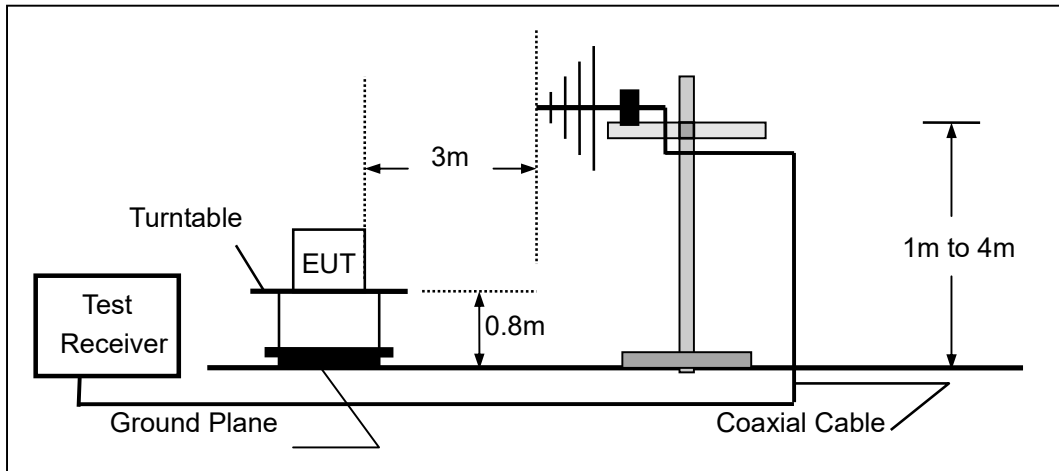

(c) Radiated Emission Test Set-Up, Frequency above 1000MHz

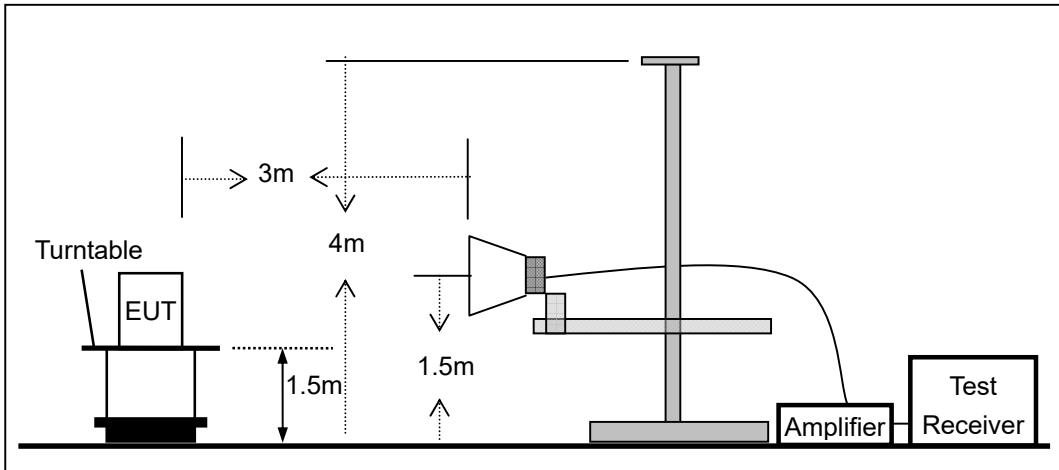

7.3 CONDUCTED EMISSION TEST SETUP

The mains cable of the EUT (maybe per AC/DC Adapter) must be connected to LISN. The LISN shall be placed 0.8 m from the boundary of EUT and bonded to a ground reference plane for LISN mounted on top of the ground reference plane. This distance is between the closest points of the LISN and the EUT. All other units of the EUT and associated equipment shall be at least 0.8m from the LISN.

Ground connections, where required for safety purposes, shall be connected to the reference ground point of the LISN and, where not otherwise provided or specified by the manufacturer, shall be of same length as the mains cable and run parallel to the mains connection at a separation distance of not more than 0.1 m.

According to the requirements in Section 13.1.4.1 of ANSI C63.10-2013 Conducted emissions from the EUT measured in the frequency range between 0.15 MHz and 30 MHz using CISPR Quasi-Peak and average detector mode.

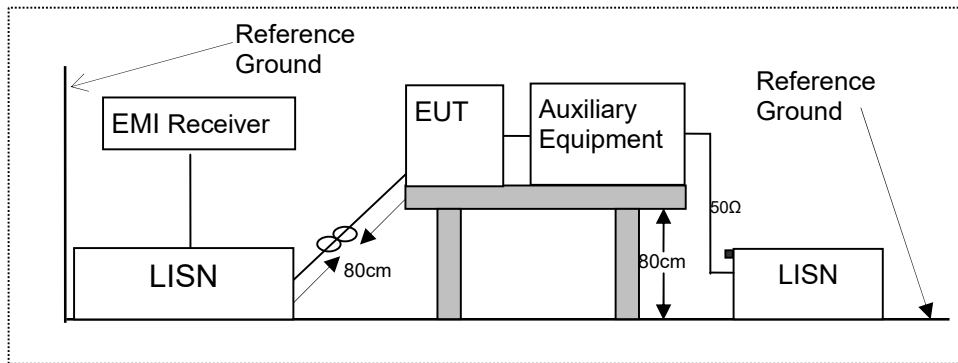

7.4 BLOCK DIAGRAM CONFIGURATION OF TEST SYSTEM

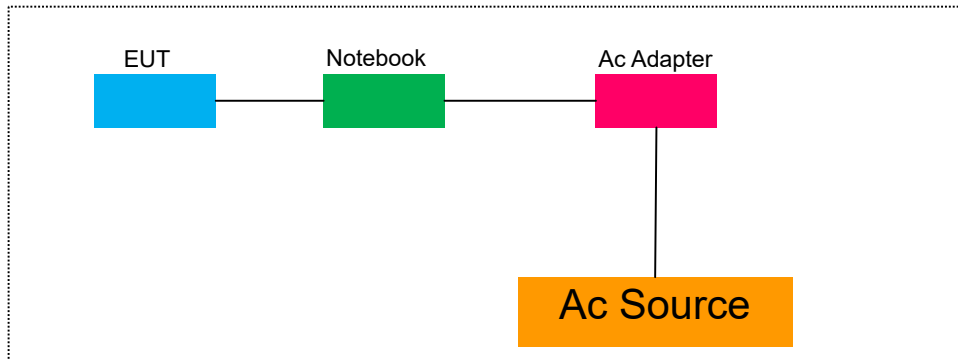

7.5 SUPPORT EQUIPMENT

Item	Equipment	Mfr/Brand	Model/Type No.	FCC ID	Series No.	Note
1.	Notebook	Lenovo	WB0205140E	N/A	N/A	

Notes:

1. All the equipment/cables were placed in the worst-case configuration to maximize the emission during the test.
2. Grounding was established in accordance with the manufacturer's requirements and conditions for the intended use.

8 TEST REQUIREMENTS

8.1 BANDWIDTH MEASUREMENT

8.1.1 Applicable Standard

According to FCC Part 15.407(a)(1) for UNII Band I
According to FCC Part 15.407(a)(2) for UNII Band II-A and UNII Band II-C
According to FCC Part 15.407(a)(3) for UNII Band III
According to FCC Part 15.407(e) for UNII Band III
According to 789033 D02 Section II(C)
According to 789033 D02 Section II(D)

8.1.2 Conformance Limit

No limit requirement.

The minimum 6 dB emission bandwidth of at least 500 KHz for the UNII Band III.

8.1.3 Test Configuration

Test according to clause 6.1 radio frequency test setup

8.1.4 Test Procedure

Connect the antenna port(s) to the spectrum analyzer input. Using the spectrum analyzer Channel Bandwidth mode, configure the spectrum analyzer as shown below

■ The following procedure shall be used for measuring (26 dB) power bandwidth:

Center Frequency: test Frequency

Set RBW = approximately 1% of the emission bandwidth.

Set the VBW > RBW.

Detector = Peak.

Trace mode = max hold.

X dB Bandwidth: 26 dB

Measure the maximum width of the emission that is 26 dB down from the maximum of the emission.

Compare this with the RBW setting of the analyzer. Readjust RBW and repeat measurement as needed until the RBW/EBW ratio is approximately 1%.

■ Minimum Emission Bandwidth for the UNII Band III

Center Frequency: test Frequency

Set RBW = 100 kHz

Set VBW $\geq 3 \cdot$ RBW

Detector = Peak

Trace mode = max hold

Sweep = auto couple

X dB Bandwidth: 6 dB

Note: The automatic bandwidth measurement capability of a spectrum analyzer or EMI receiver may be employed if it implements the functionality described above.

■ The following procedure shall be used for measuring (99 %) power bandwidth:

Set center frequency to the nominal EUT channel center frequency.

Set span = 1.5 times to 5.0 times the OBW.

Set RBW = 1 % to 5 % of the OBW

Set VBW $\geq 3 \cdot$ RBW

Video averaging is not permitted. Where practical, a sample detection and single sweep mode shall be used. Otherwise, peak detection and max hold mode (until the trace stabilizes) shall be used.

Use the 99 % power bandwidth function of the instrument (if available).

If the instrument does not have a 99 % power bandwidth function, the trace data points are recovered and directly summed in power units. The recovered amplitude data points, beginning at the lowest frequency, are placed in a running sum until 0.5 % of the total is reached; that frequency is recorded as the lower frequency. The process is repeated until 99.5 % of the total is reached; that frequency is recorded as the upper frequency. The 99% occupied bandwidth is the difference between these two frequencies.

8.1.5 Test Results

<input checked="" type="checkbox"/> 802.11a mode Temperature : 28°C Test Date : April 20, 2016 Humidity : 65 % Test By: King Kong								
Band	Channel Number	Channel Freq. (MHz)	26dB EBW		99% OBW		Limit (MHz)	Verdict
			Ant0	Ant1	Ant0	Ant1		
UNII Band I	CH36	5180	21.72	21.82	17.169	17.109	N/A	N/A
	CH40	5200	21.74	21.75	17.120	17.121	N/A	N/A
	CH48	5240	21.80	21.69	17.157	17.106	N/A	N/A
UNII Band II-A	CH52	5260	21.75	21.62	17.106	17.123	N/A	N/A
	CH56	5280	21.63	21.82	17.108	17.092	N/A	N/A
	CH64	5320	21.71	21.79	17.167	17.149	N/A	N/A
UNII Band II-C	CH100	5500	21.63	21.82	17.074	17.131	N/A	N/A
	CH120	5600	21.62	21.71	17.107	17.110	N/A	N/A
	CH140	5700	21.80	21.62	17.226	17.109	N/A	N/A
UNII Band III	CH149	5745	21.75	21.64	17.112	17.123	N/A	N/A
	CH157	5785	21.72	21.63	17.139	17.117	N/A	N/A
	CH165	5825	21.70	21.55	17.114	17.101	N/A	N/A
Note: N/A (Not Applicable)								

<input checked="" type="checkbox"/> 802.11n(VHT20) mode Temperature : 28°C Test Date : April 20, 2016 Humidity : 65 % Test By: King Kong								
Band	Channel Number	Channel Freq. (MHz)	26dB EBW		99% OBW		Limit (MHz)	Verdict
			Ant0	Ant1	Ant0	Ant1		
UNII Band I	CH36	5180	22.02	21.84	18.140	18.129	N/A	N/A
	CH40	5200	21.82	21.85	18.141	18.116	N/A	N/A
	CH48	5240	21.96	21.95	18.132	18.115	N/A	N/A
UNII Band II-A	CH52	5260	21.77	21.96	18.152	18.104	N/A	N/A
	CH56	5280	22.07	21.90	18.178	18.181	N/A	N/A
	CH64	5320	21.87	21.89	18.150	18.202	N/A	N/A
UNII Band II-C	CH100	5500	21.98	21.94	18.106	18.125	N/A	N/A
	CH120	5600	21.64	21.95	18.078	18.130	N/A	N/A
	CH140	5700	21.98	21.87	18.110	18.129	N/A	N/A
UNII Band III	CH149	5745	21.85	21.80	18.124	18.135	N/A	N/A
	CH157	5785	21.88	21.94	18.161	18.179	N/A	N/A
	CH165	5825	21.77	21.82	18.159	18.186	N/A	N/A
Note: N/A (Not Applicable)								

<input checked="" type="checkbox"/> 802.11ac(VHT20) mode			
Temperature :	28 °C	Test Date :	April 20, 2016
Humidity :	65 %	Test By:	King Kong

Band	Channel Number	Channel Freq. (MHz)	26dB EBW		99% OBW		Limit (MHz)	Verdict
			Ant0	Ant1	Ant0	Ant1		
UNII Band I	CH36	5180	21.93	21.80	18.102	18.130	N/A	N/A
	CH40	5200	21.84	21.85	18.139	18.121	N/A	N/A
	CH48	5240	21.83	21.80	18.147	18.136	N/A	N/A
UNII Band II-A	CH52	5260	21.84	21.89	18.152	18.186	N/A	N/A
	CH56	5280	21.92	21.81	18.147	18.122	N/A	N/A
	CH64	5320	21.85	21.91	18.132	18.192	N/A	N/A
UNII Band II-C	CH100	5500	21.99	21.93	18.149	18.116	N/A	N/A
	CH120	5600	22.05	21.84	18.142	18.179	N/A	N/A
	CH140	5700	21.75	21.74	18.159	18.146	N/A	N/A
UNII Band III	CH149	5745	21.86	21.94	18.149	18.164	N/A	N/A
	CH157	5785	21.82	21.91	18.144	18.121	N/A	N/A
	CH165	5825	22.03	21.99	18.115	18.137	N/A	N/A

Note:
N/A (Not Applicable)

<input checked="" type="checkbox"/> 802.11n(VHT40) mode			
Temperature :	28 °C	Test Date :	April 20, 2016
Humidity :	65 %	Test By:	King Kong

Band	Channel Number	Channel Freq. (MHz)	26dB EBW		99% OBW		Limit (MHz)	Verdict
			Ant0	Ant1	Ant0	Ant1		
UNII Band I	CH38	5190	40.18	40.60	36.483	36.188	N/A	N/A
	CH46	5230	40.40	40.23	36.480	36.467	N/A	N/A
UNII Band II-A	CH54	5270	40.00	40.06	36.479	36.475	N/A	N/A
	CH62	5310	40.25	40.16	36.479	36.488	N/A	N/A
UNII Band II-C	CH102	5510	40.33	40.20	36.456	36.501	N/A	N/A
	CH118	5590	40.24	40.12	36.443	36.428	N/A	N/A
	CH134	5670	40.43	40.20	36.466	36.453	N/A	N/A
UNII Band III	CH151	5755	40.37	40.18	36.449	36.399	N/A	N/A
	CH159	5795	40.20	40.17	36.466	36.539	N/A	N/A

Note:
N/A (Not Applicable)

<input checked="" type="checkbox"/> 802.11ac(VHT40) mode			
Temperature :	28 °C	Test Date :	April 20, 2016
Humidity :	65 %	Test By:	King Kong

Band	Channel Number	Channel Freq. (MHz)	26dB EBW		99% OBW		Limit (MHz)	Verdict
			Ant0	Ant1	Ant0	Ant1		
UNII Band I	CH38	5190	40.39	39.97	36.451	36.491	N/A	N/A
	CH46	5230	40.09	40.02	36.471	36.417	N/A	N/A
UNII Band II-A	CH54	5270	40.09	40.29	36.385	36.431	N/A	N/A
	CH62	5310	40.37	40.14	36.492	36.478	N/A	N/A
UNII Band II-C	CH102	5510	40.23	40.48	36.467	36.516	N/A	N/A
	CH118	5590	40.36	40.19	36.468	36.419	N/A	N/A
	CH134	5670	40.27	40.30	36.492	36.491	N/A	N/A
UNII Band III	CH151	5755	40.28	40.24	36.478	36.435	N/A	N/A
	CH159	5795	40.27	40.02	36.451	36.521	N/A	N/A

Note:
N/A (Not Applicable)

<input checked="" type="checkbox"/> 802.11ac(VHT80) mode			
Temperature :	28 °C	Test Date :	April 20, 2016
Humidity :	65 %	Test By:	King Kong

Band	Channel Number	Channel Freq. (MHz)	26dB EBW		99% OBW		Limit (MHz)	Verdict
			Ant0	Ant1	Ant0	Ant1		
UNII Band I	CH42	5210	82.11	82.17	75.663	85.747	N/A	N/A
UNII Band II-A	CH58	5290	81.64	82.22	75.630	75.838	N/A	N/A
UNII Band II-C	CH106	5530	82.09	82.10	75.767	75.836	N/A	N/A
	CH122	5610	82.07	81.90	75.715	75.726	N/A	N/A
UNII Band III	CH155	5775	81.76	82.19	75.814	75.830	N/A	N/A
Note: N/A (Not Applicable)								

<input checked="" type="checkbox"/> UNII Band III			
Temperature :	28 °C	Test Date :	April 20, 2016
Humidity :	65 %	Test By:	King Kong

Operation Mode	Channel Number	Channel Freq. (MHz)	6dB EBW		Limit (MHz)	Verdict
			Ant0	Ant1		
802.11a	CH149	5745	16.40	16.39	500	PASS
	CH157	5785	16.39	16.39	500	PASS
	CH165	5825	16.39	16.39	500	PASS
802.11n (VHT20)	CH149	5745	17.61	17.62	500	PASS
	CH157	5785	17.62	17.62	500	PASS
	CH165	5825	17.60	17.63	500	PASS
802.11ac (VHT20)	CH149	5745	17.62	17.63	500	PASS
	CH157	5785	17.63	17.63	500	PASS
	CH165	5825	17.61	17.63	500	PASS
802.11n (VHT40)	CH151	5755	36.36	36.37	500	PASS
	CH159	5795	36.38	36.40	500	PASS
802.11ac (VHT40)	CH151	5755	36.40	36.37	500	PASS
	CH159	5795	36.40	36.39	500	PASS
802.11ac (VHT80)	CH155	5775	75.99	76.12	500	PASS
Note: N/A (Not Applicable)						

Emission Bandwidth&99% Occupied Bandwidth		UNII Band I	
Test Model	802.11a	Frequency(MHz)	5180
Ant0			

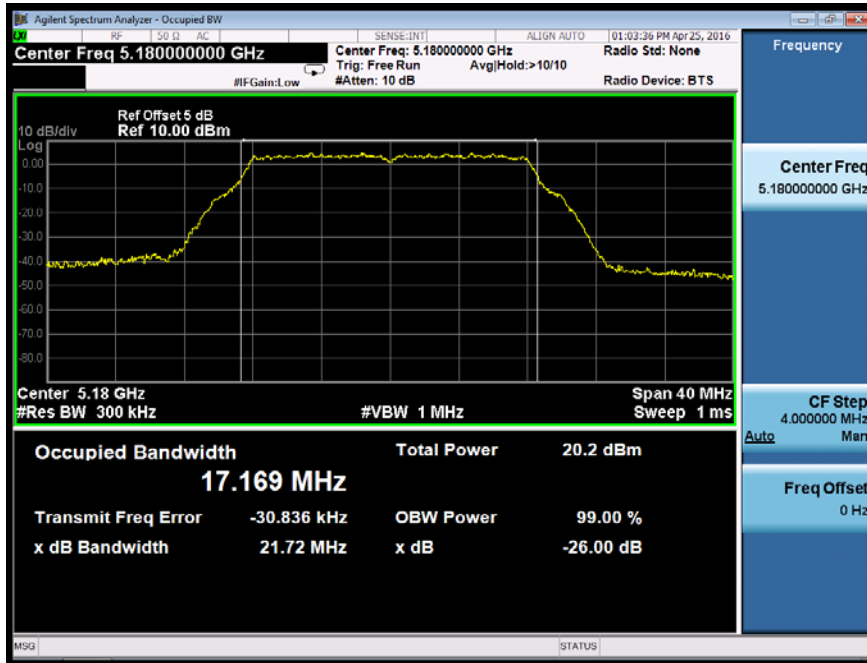

Ant1

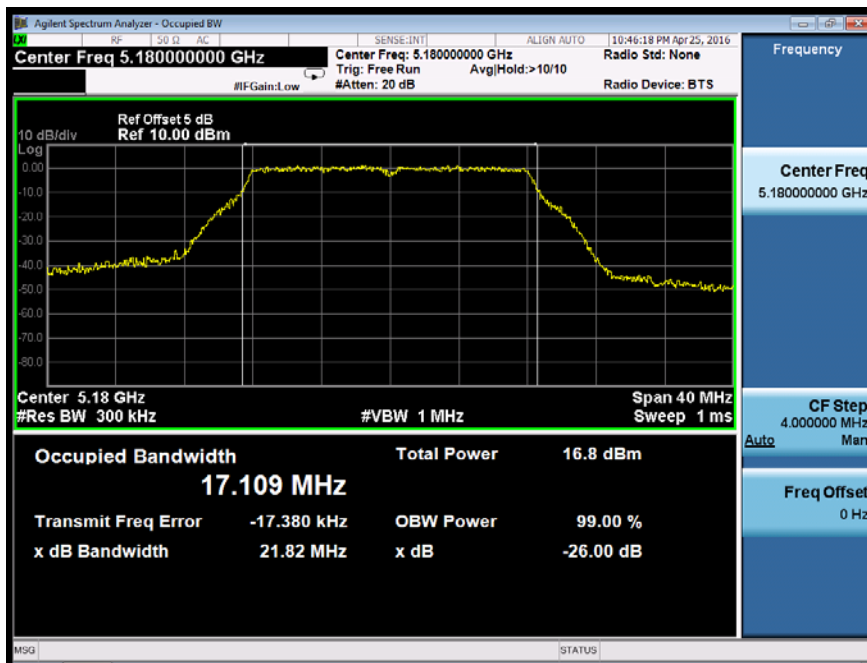

Emission Bandwidth&99% Occupied Bandwidth		UNII Band I	
Test Model	802.11a	Frequency(MHz)	5200
Ant0			

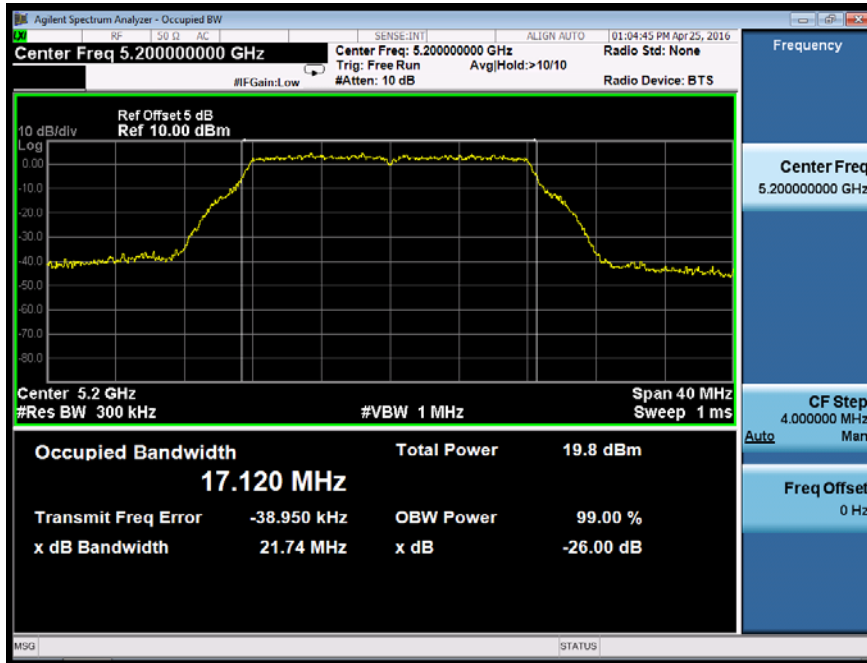

Ant1

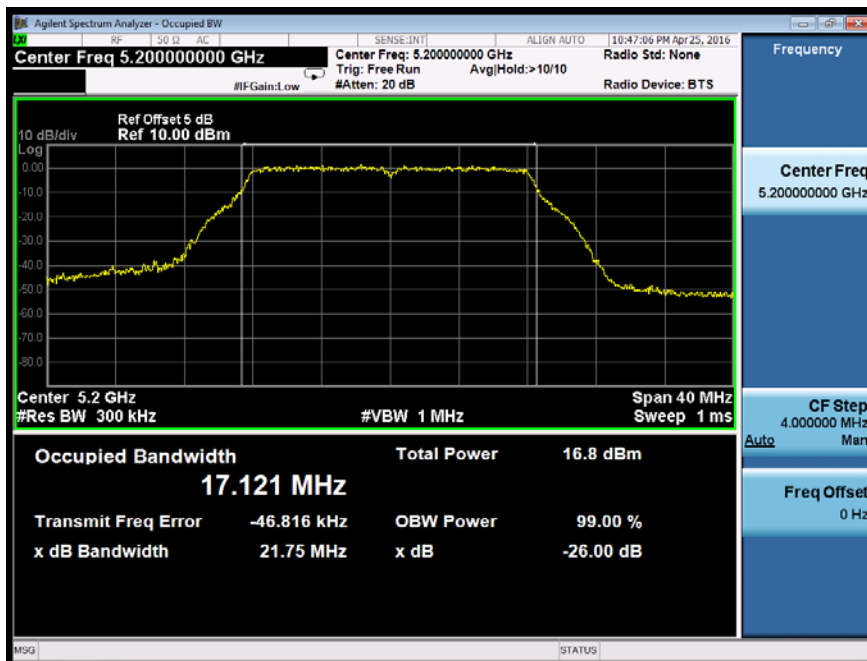

Emission Bandwidth&99% Occupied Bandwidth		UNII Band I	
Test Model	802.11a	Frequency(MHz)	5240
Ant0			

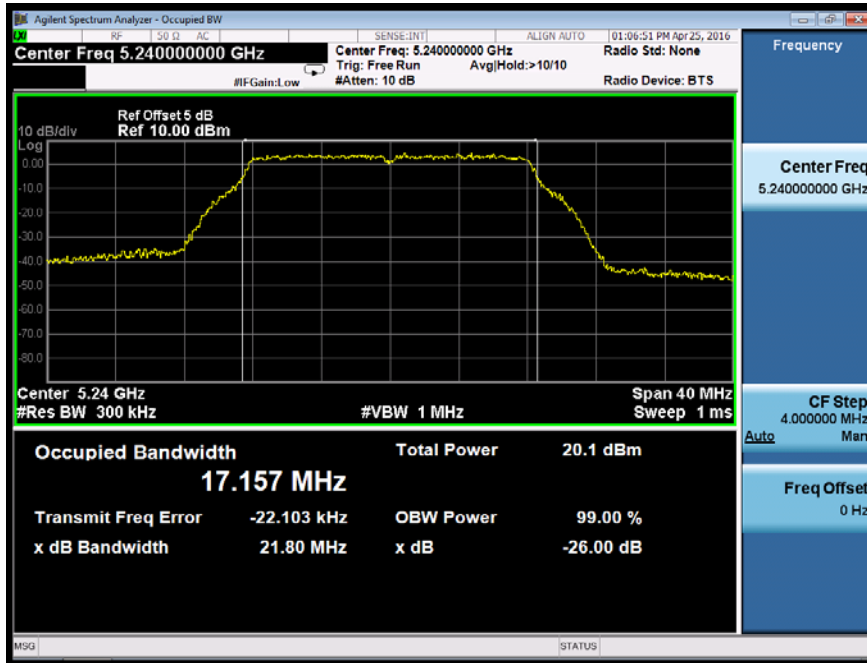

Ant1

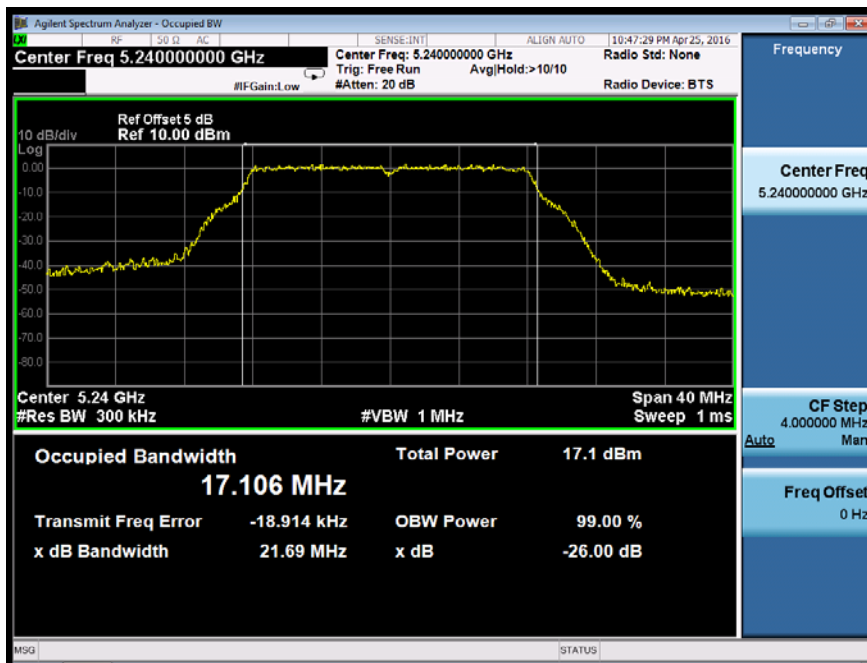

Emission Bandwidth&99% Occupied Bandwidth		UNII Band II-A	
Test Model	802.11a	Frequency(MHz)	5260
Ant0			

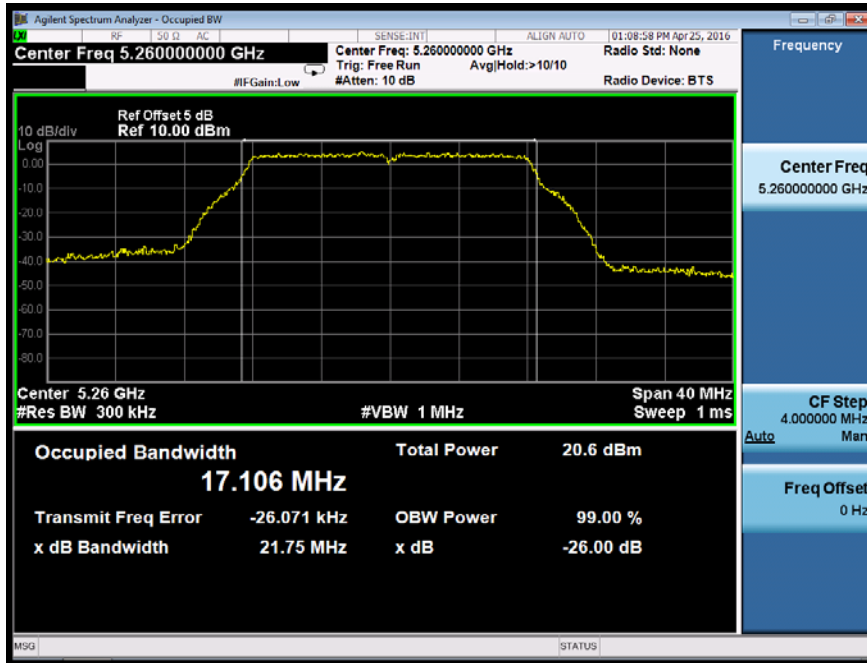

Ant1

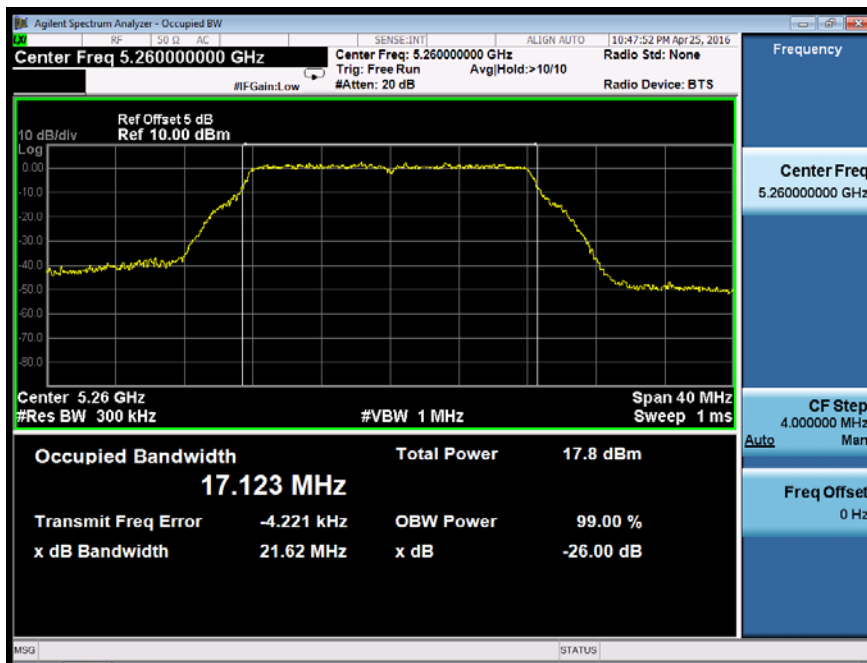

Emission Bandwidth&99% Occupied Bandwidth	UNII Band II-A	
Test Model	802.11a	Frequency(MHz)
Ant0		5280

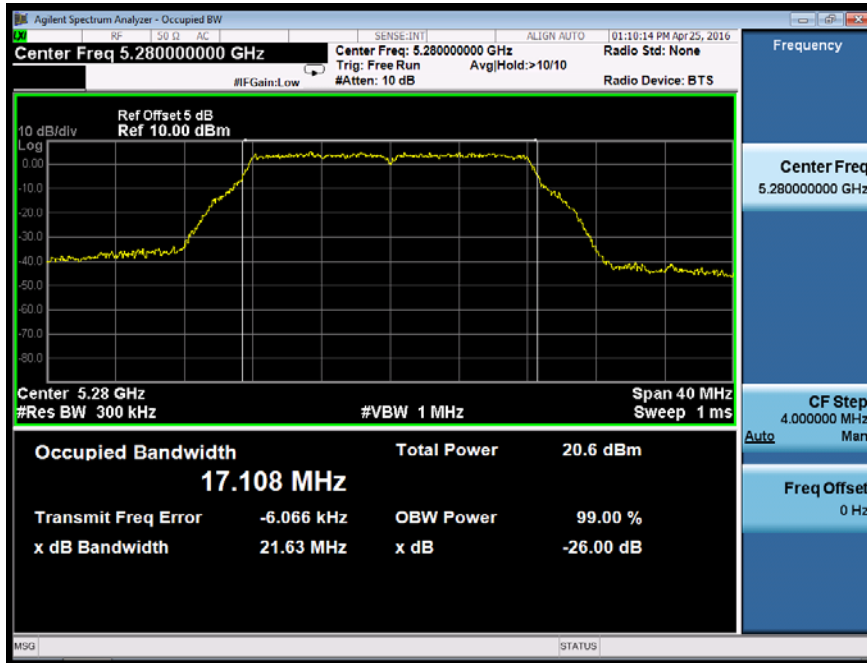

Ant1

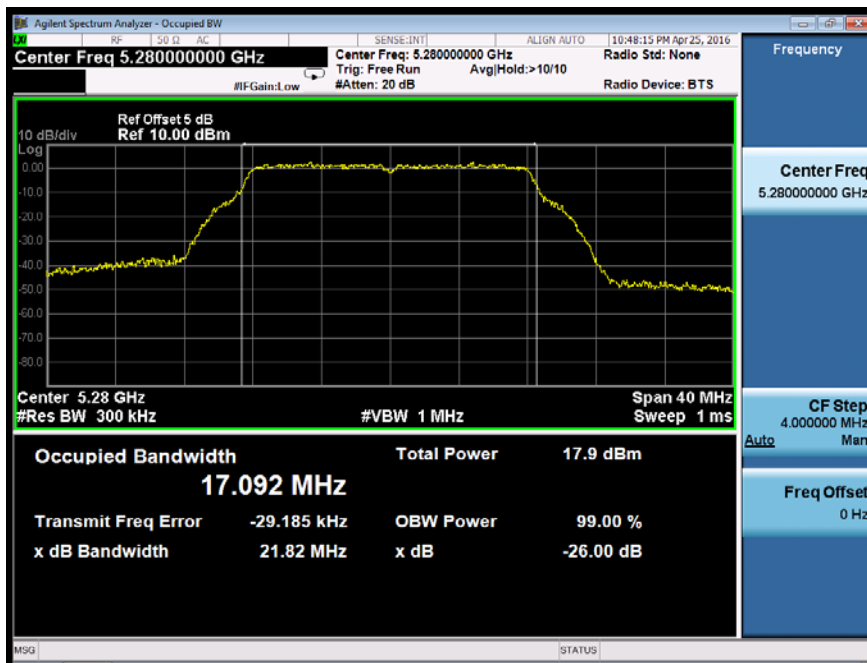

Emission Bandwidth&99% Occupied Bandwidth	UNII Band II-A	
Test Model	802.11a	Frequency(MHz)
Ant0		5320

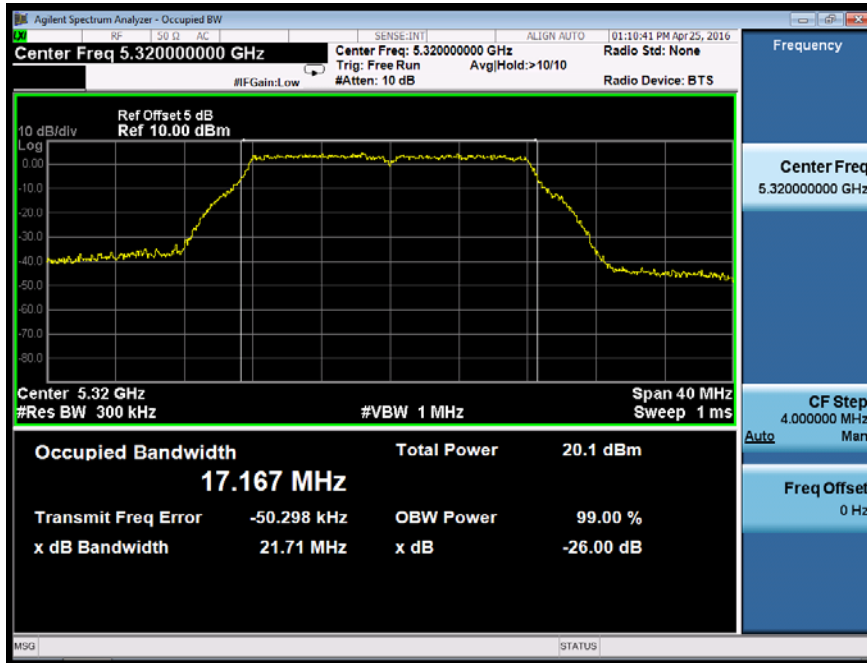

Ant1

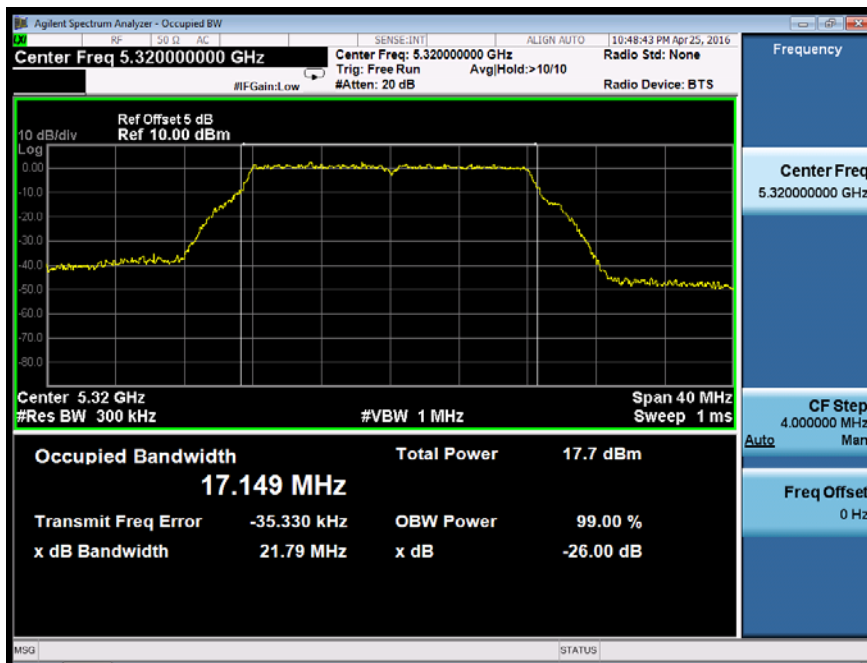

Emission Bandwidth&99% Occupied Bandwidth	UNII Band II-C
Test Model 802.11a	Frequency(MHz) 5600

Ant0

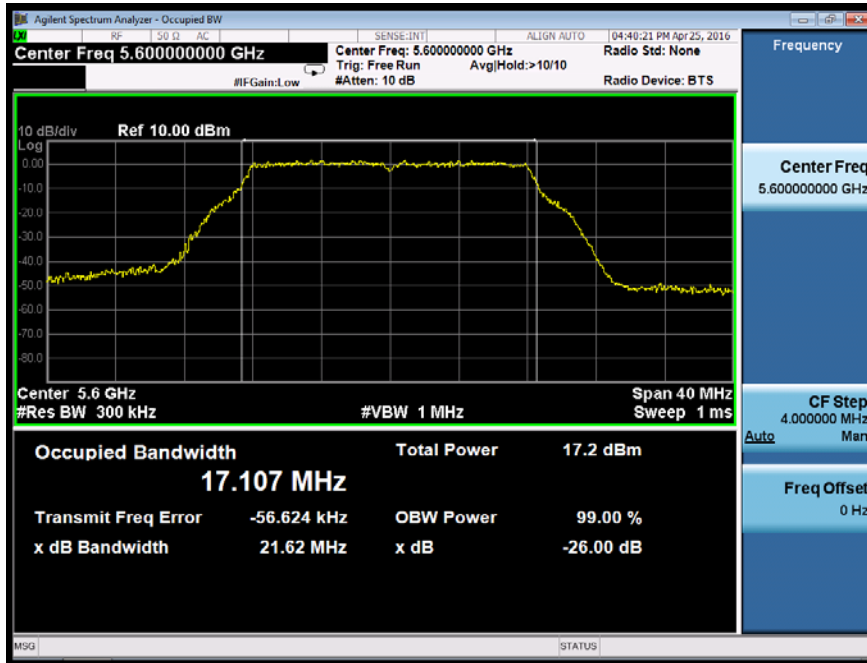

Ant1

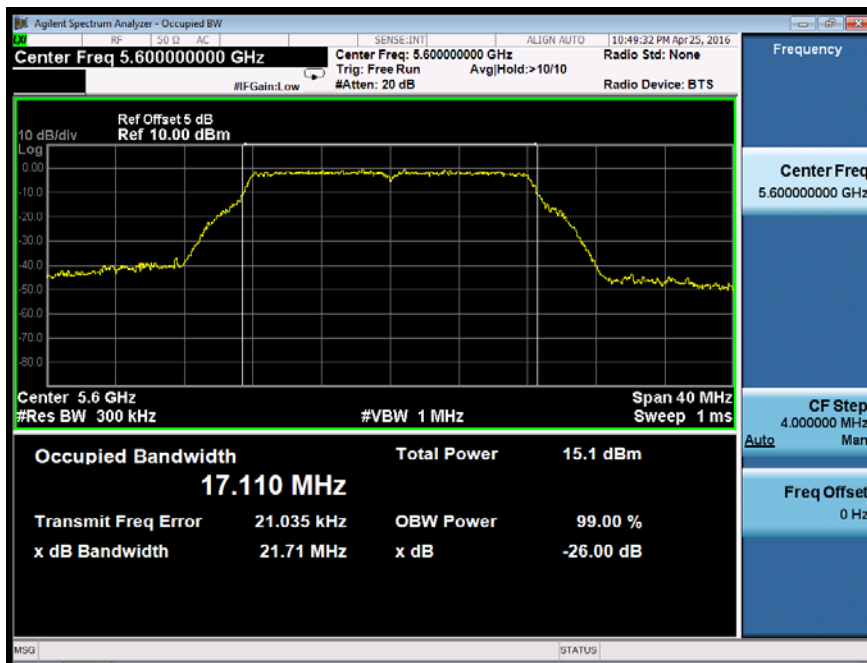

Emission Bandwidth&99% Occupied Bandwidth	UNII Band II-C
Test Model 802.11a	Frequency(MHz) 5700

Ant0



Ant1

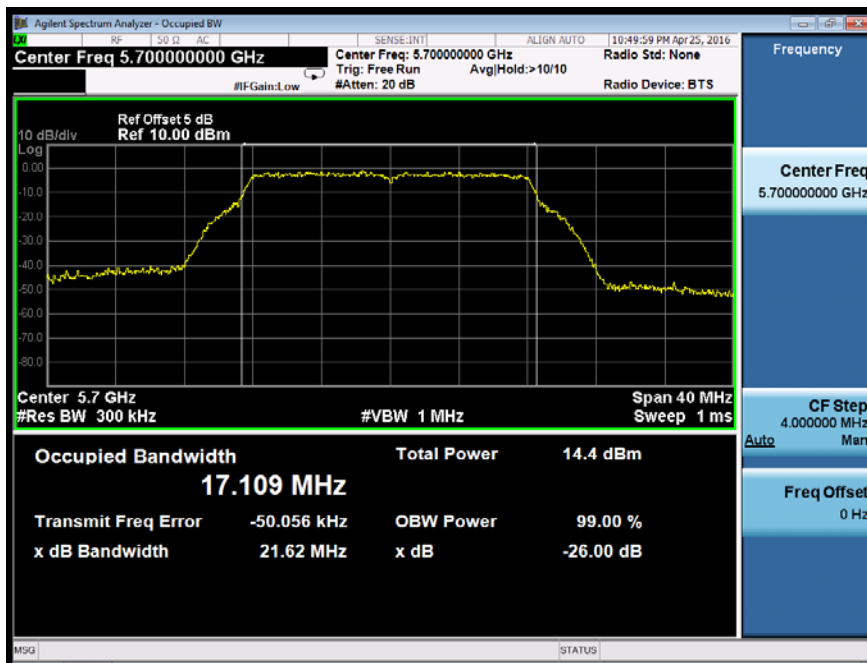

Emission Bandwidth&99% Occupied Bandwidth		UNII Band III	
Test Model	802.11a	Frequency(MHz)	5745
Ant0			

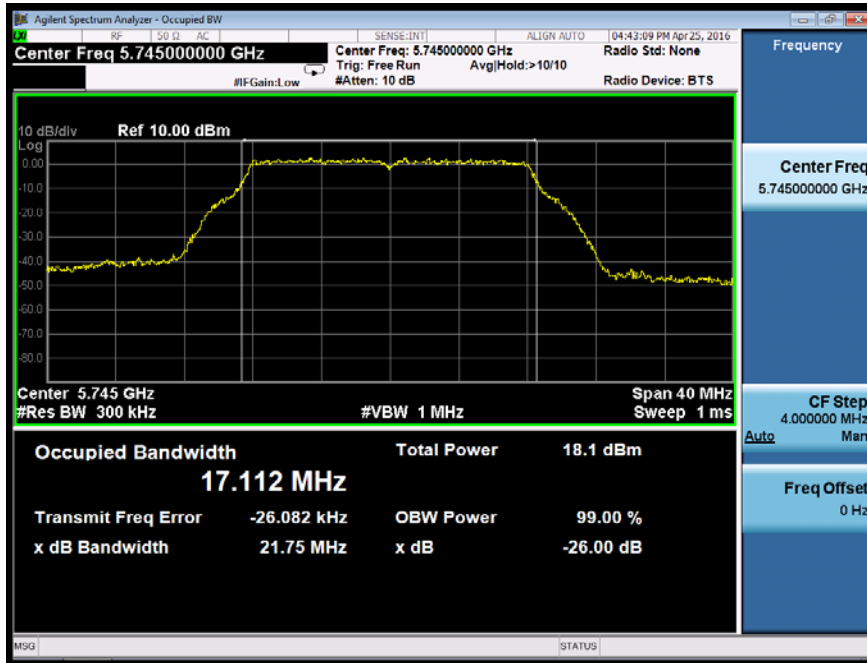

Ant1

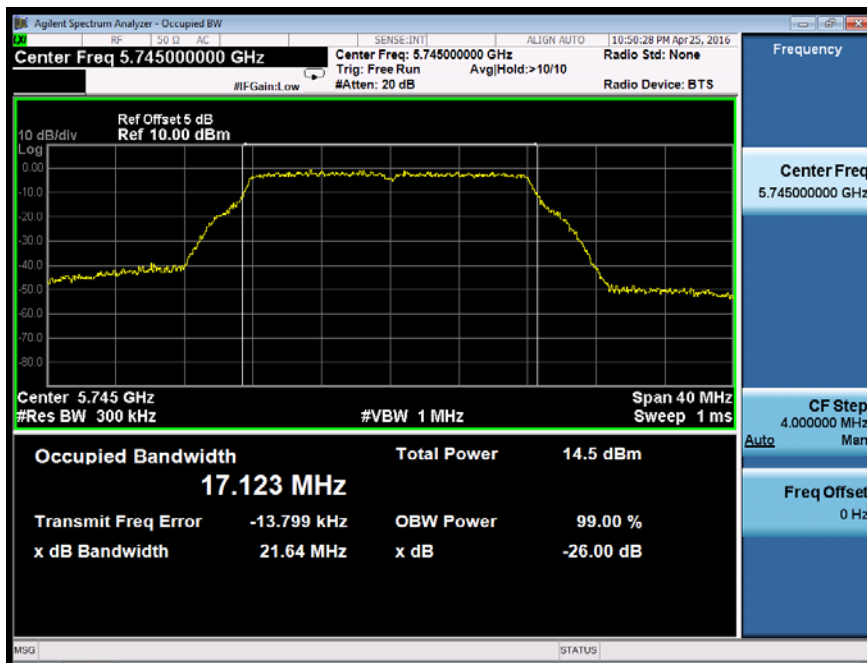

Emission Bandwidth&99% Occupied Bandwidth		UNII Band III	
Test Model	802.11a	Frequency(MHz)	5785
Ant0			

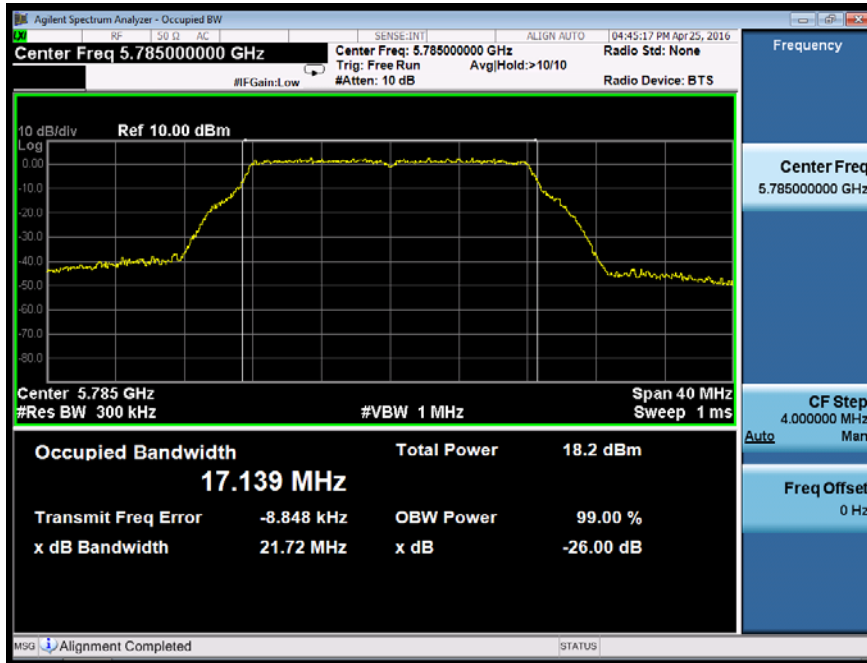

Ant1

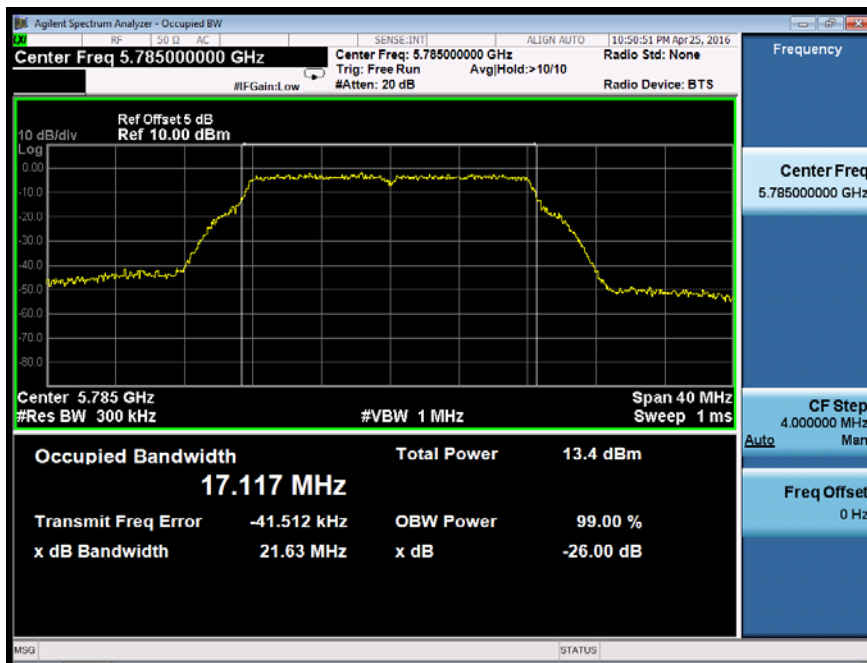

Emission Bandwidth&99% Occupied Bandwidth	UNII Band III	
Test Model	802.11a	Frequency(MHz)
Ant0		5825

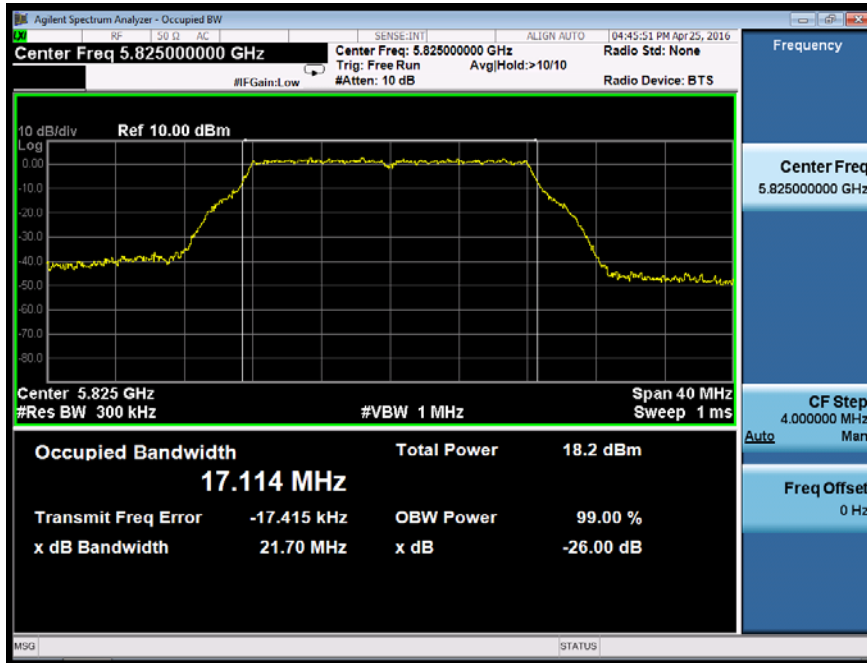

Ant1

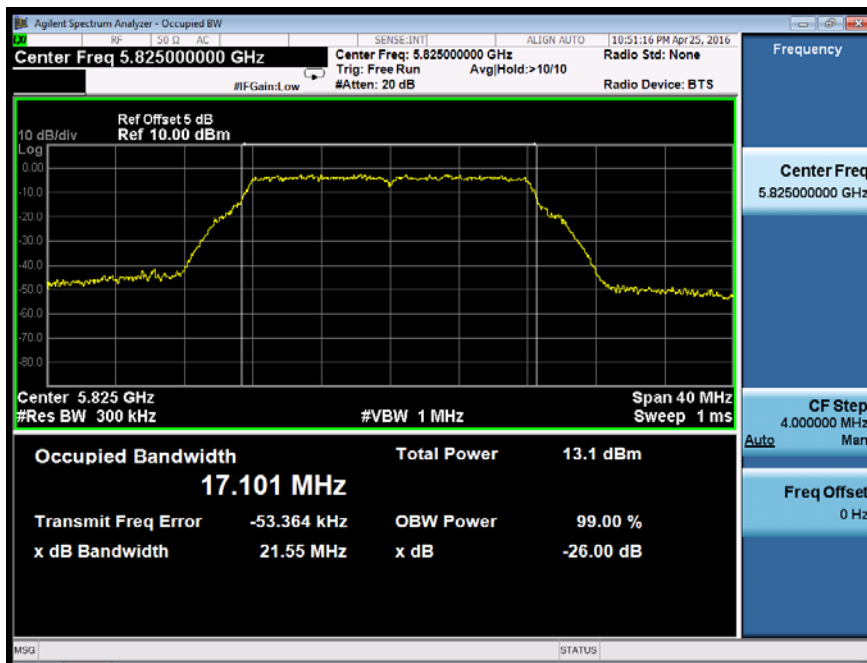

Emission Bandwidth&99% Occupied Bandwidth	UNII Band I	
Test Model	802.11n(VHT20) mode	Frequency(MHz)
Ant0		5180

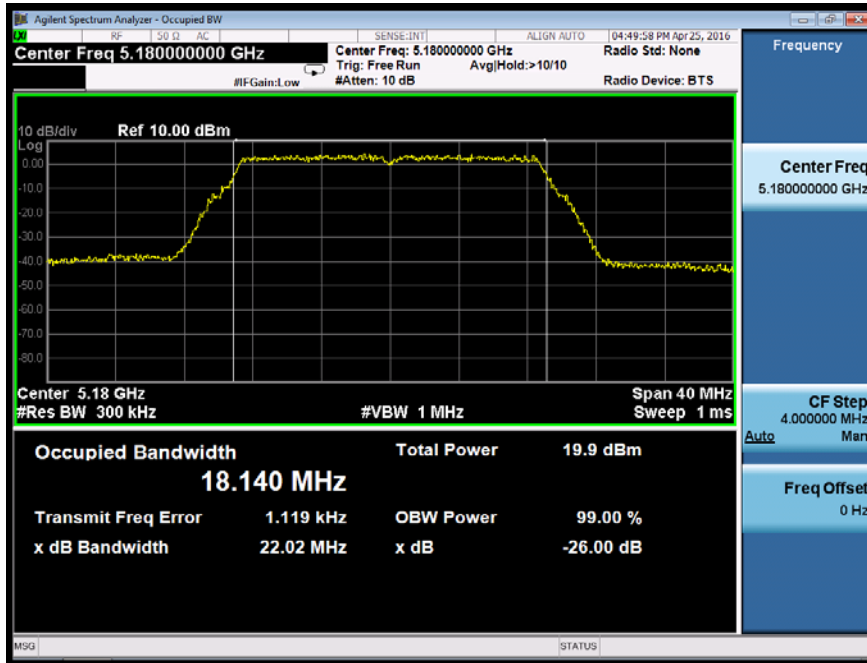

Ant1

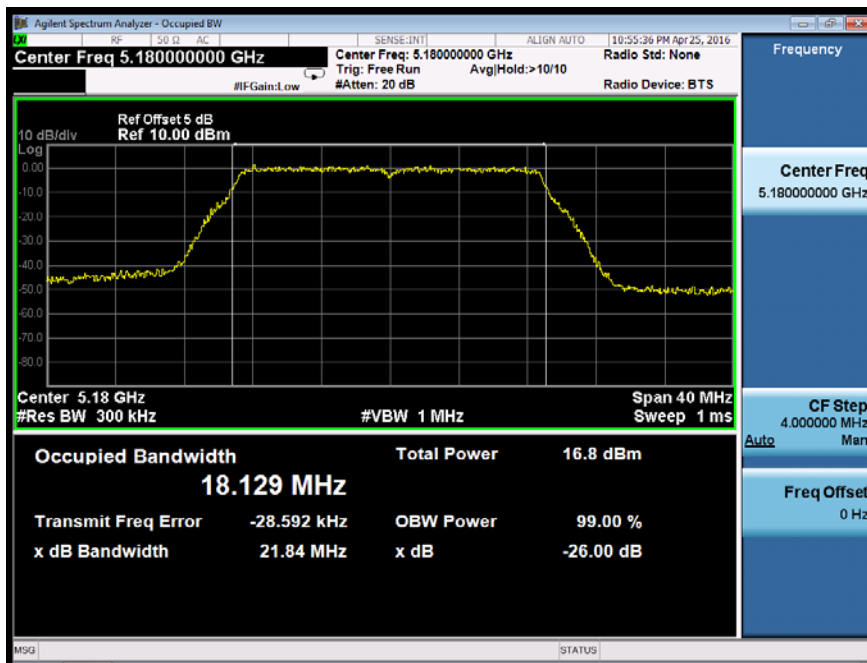

Emission Bandwidth&99% Occupied Bandwidth	UNII Band I	
Test Model	802.11n(VHT20) mode	Frequency(MHz)
Ant0		5200

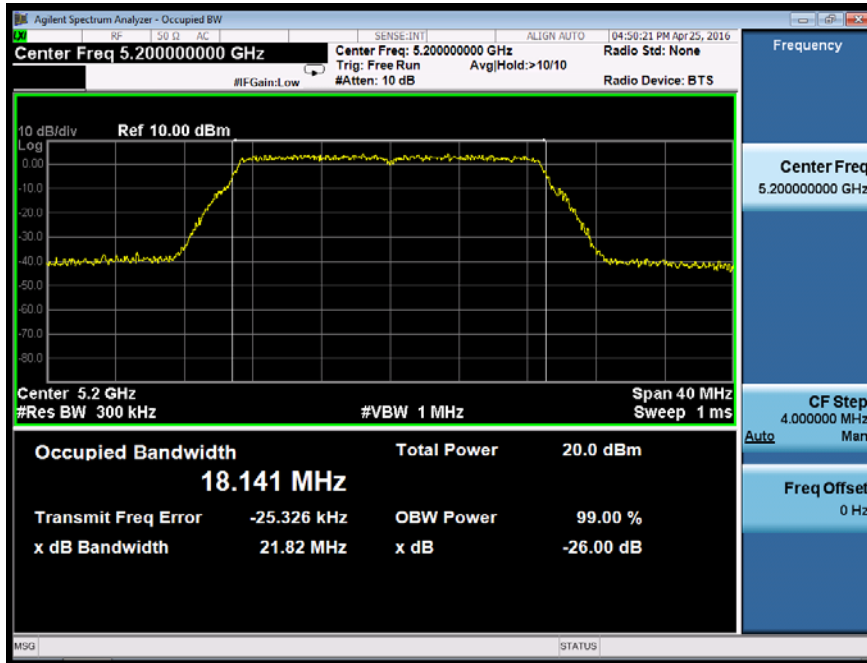

Ant1

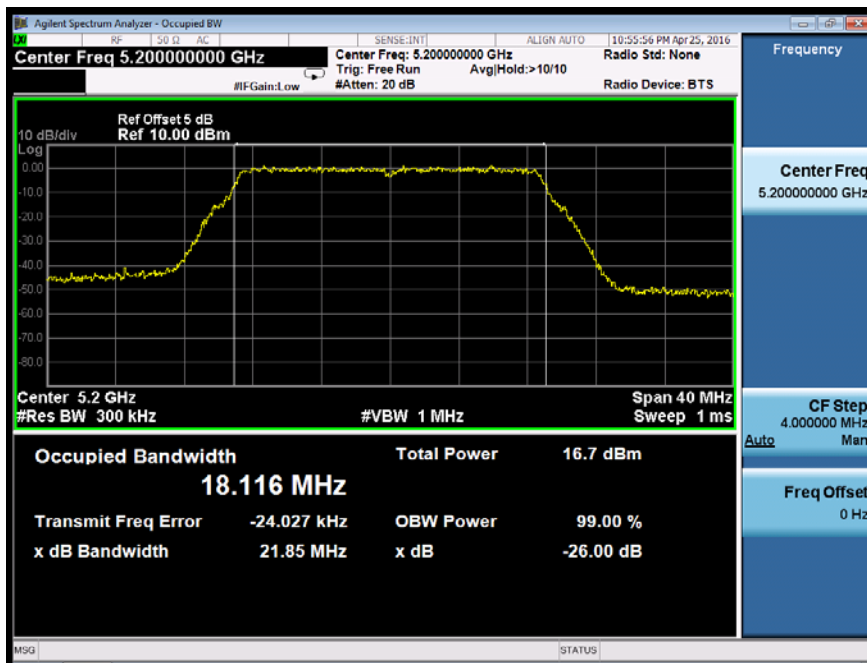

Emission Bandwidth&99% Occupied Bandwidth	UNII Band I
Test Model 802.11n(VHT20) mode	Frequency(MHz) 5240
Ant0	

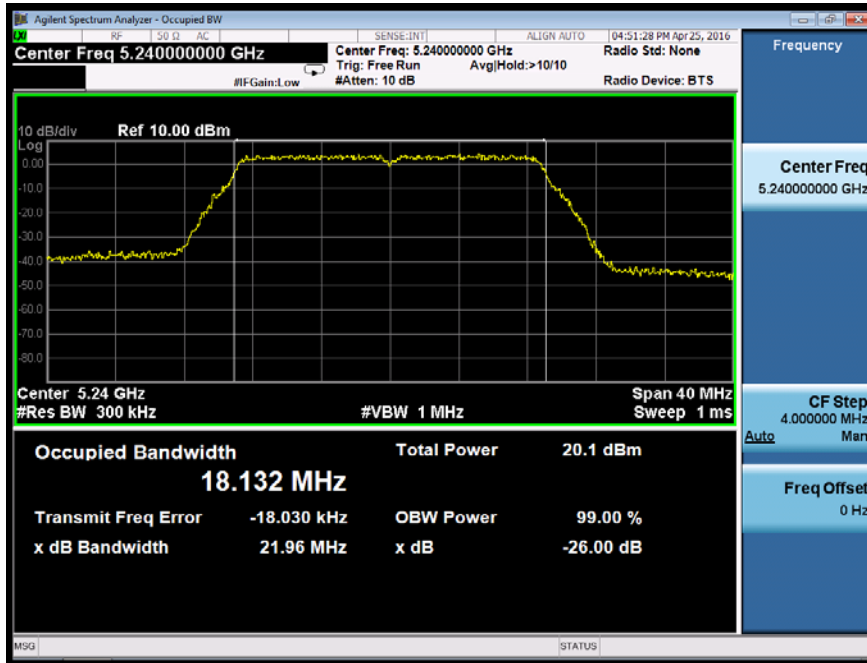

Ant1

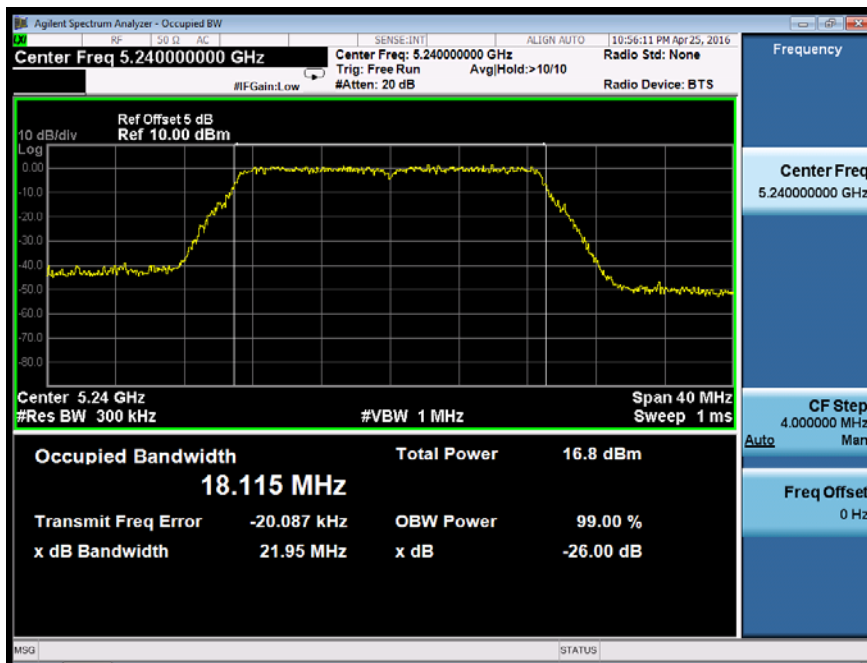

Emission Bandwidth&99% Occupied Bandwidth	UNII Band II-A	
Test Model	802.11n(VHT20) mode	Frequency(MHz)
Ant0		5260

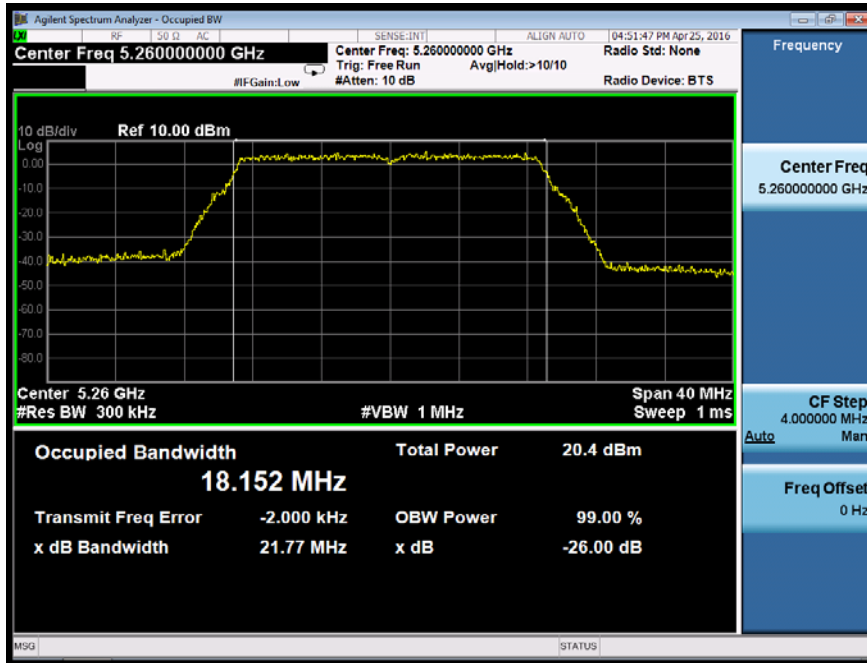

Ant1

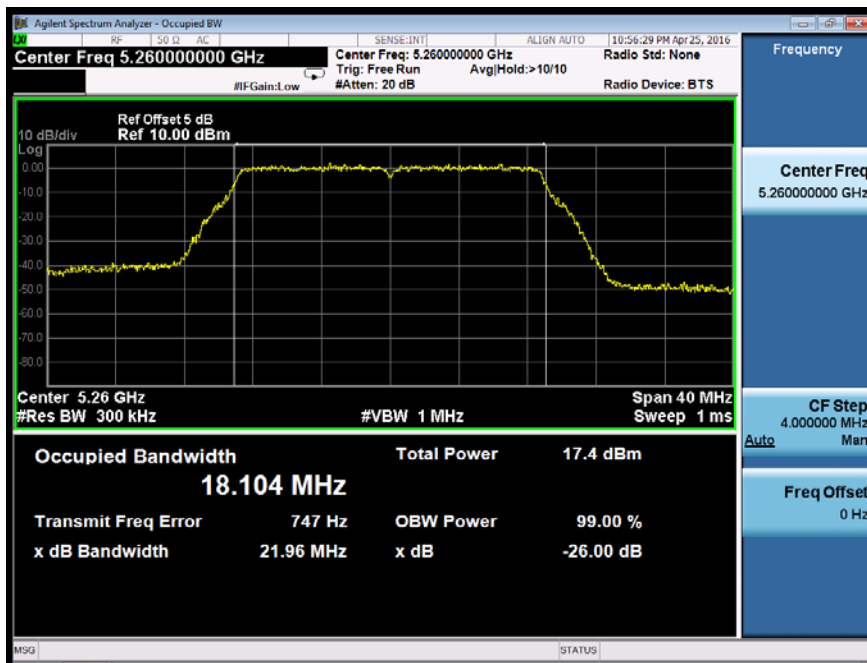

Emission Bandwidth&99% Occupied Bandwidth	UNII Band II-A	
Test Model	802.11n(VHT20) mode	Frequency(MHz)
Ant0		5280



Ant1



Emission Bandwidth&99% Occupied Bandwidth	UNII Band II-A	
Test Model	802.11n(VHT20) mode	Frequency(MHz)
Ant0		5320

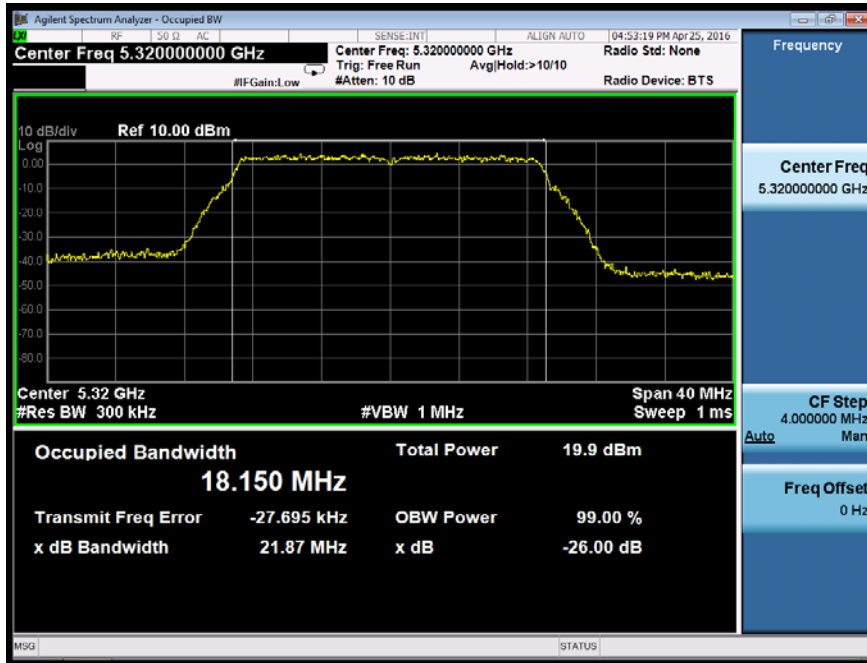

Ant1

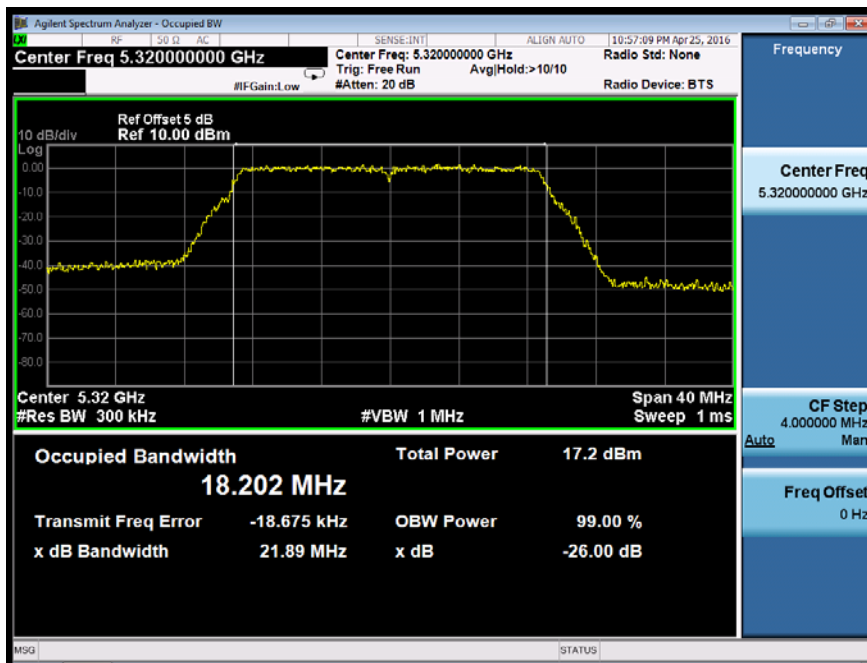

Emission Bandwidth&99% Occupied Bandwidth	UNII Band II-C	
Test Model	802.11n(VHT20) mode	Frequency(MHz)
Ant0		5500

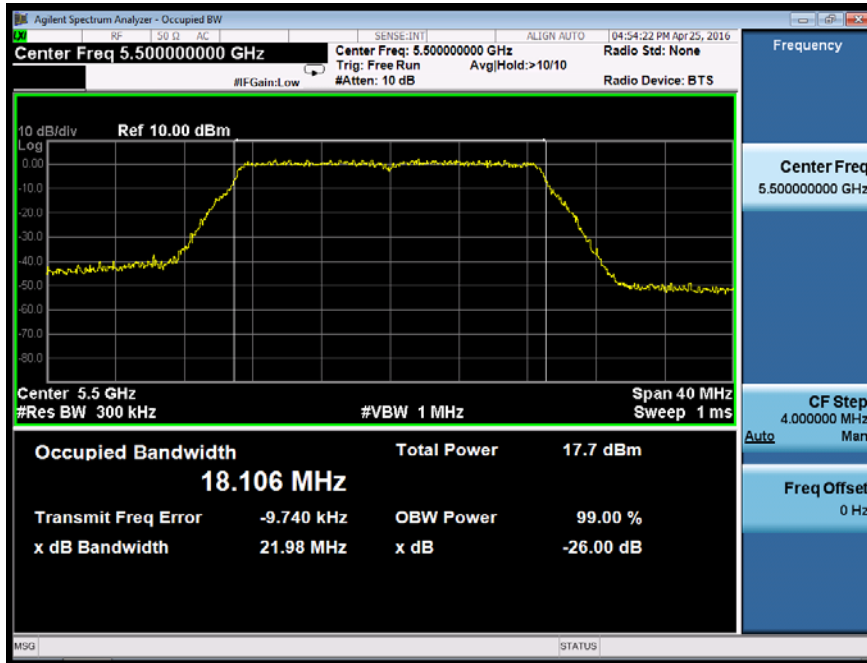

Ant1

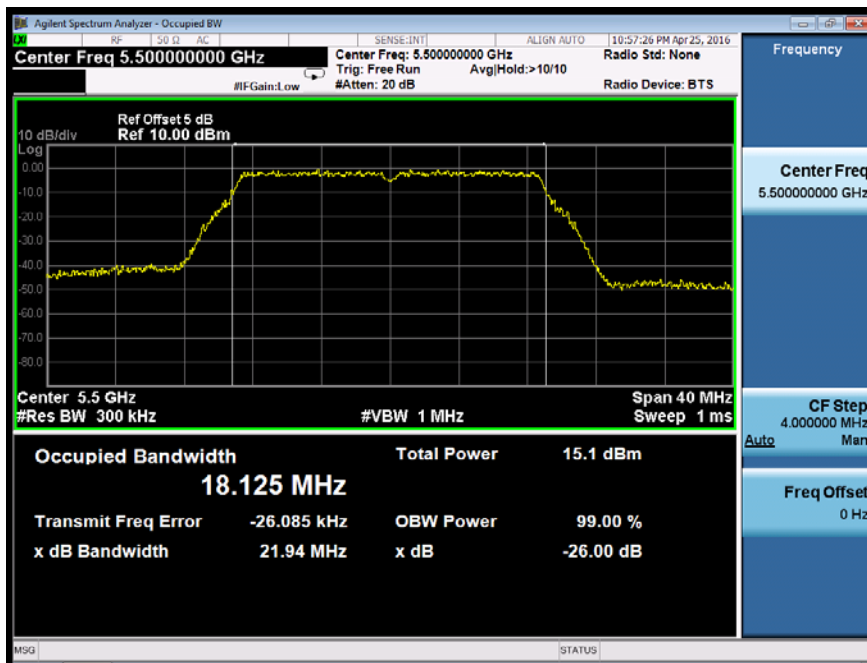

Emission Bandwidth&99% Occupied Bandwidth	UNII Band II-C	
Test Model	802.11n(VHT20) mode	Frequency(MHz)
Ant0		5600

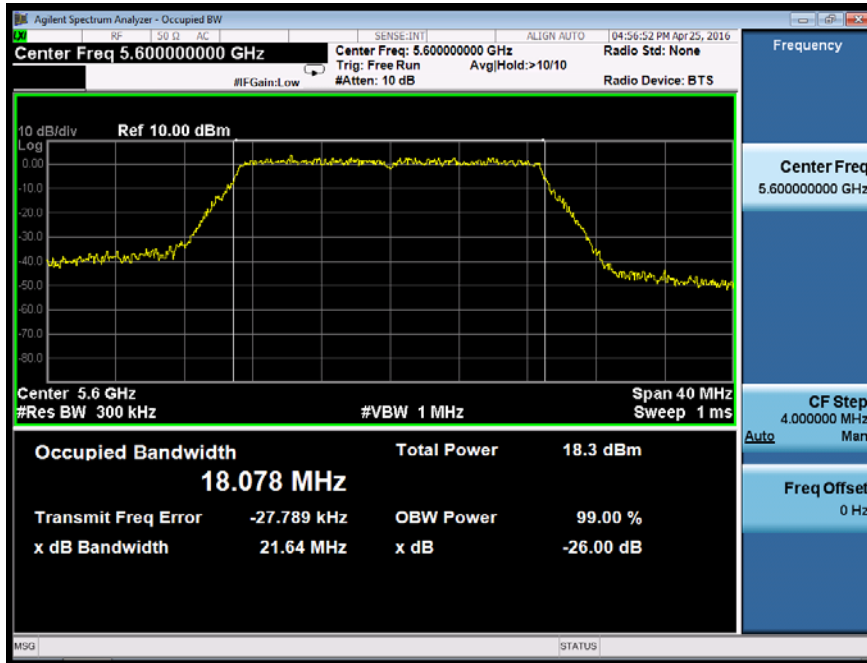

Ant1

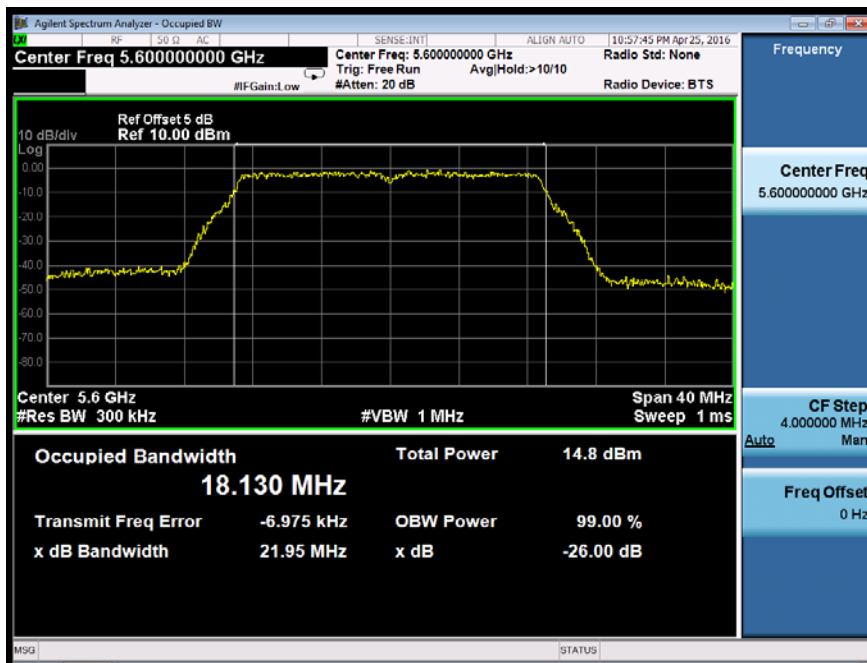

Emission Bandwidth&99% Occupied Bandwidth	UNII Band II-C	
Test Model	802.11n(VHT20) mode	Frequency(MHz)
Ant0		5700

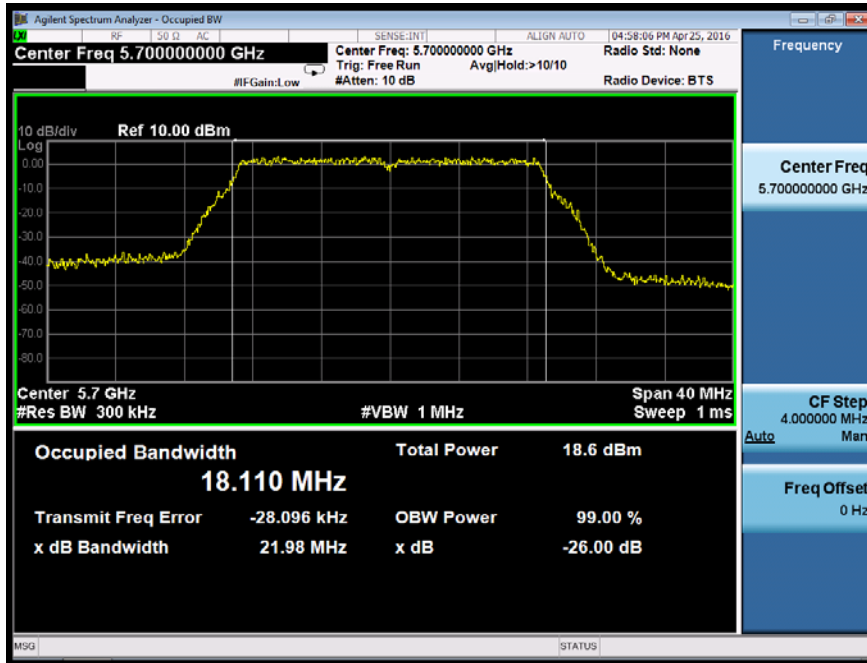

Ant1

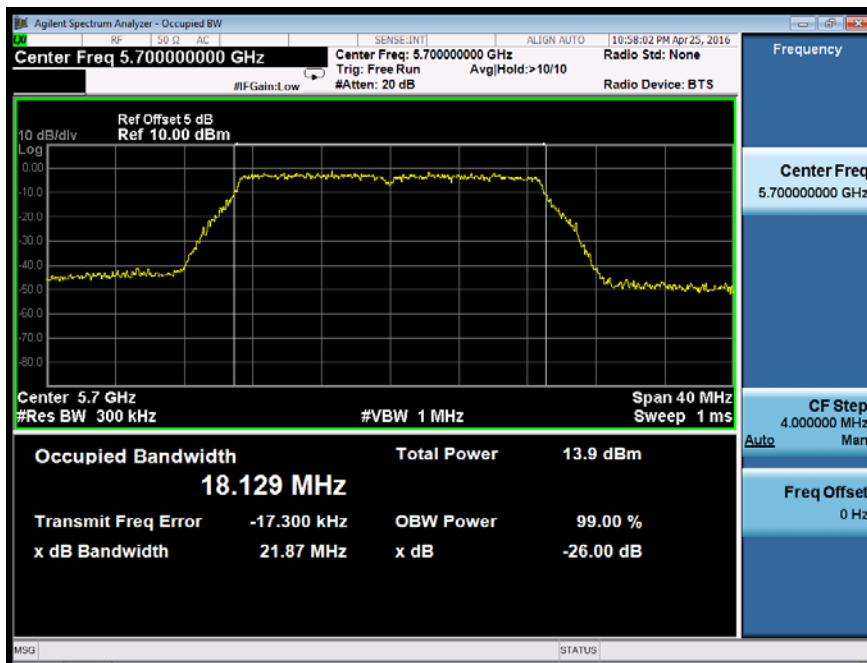

Emission Bandwidth&99% Occupied Bandwidth	UNII Band III	
Test Model	802.11n(VHT20) mode	Frequency(MHz)
Ant0		5745

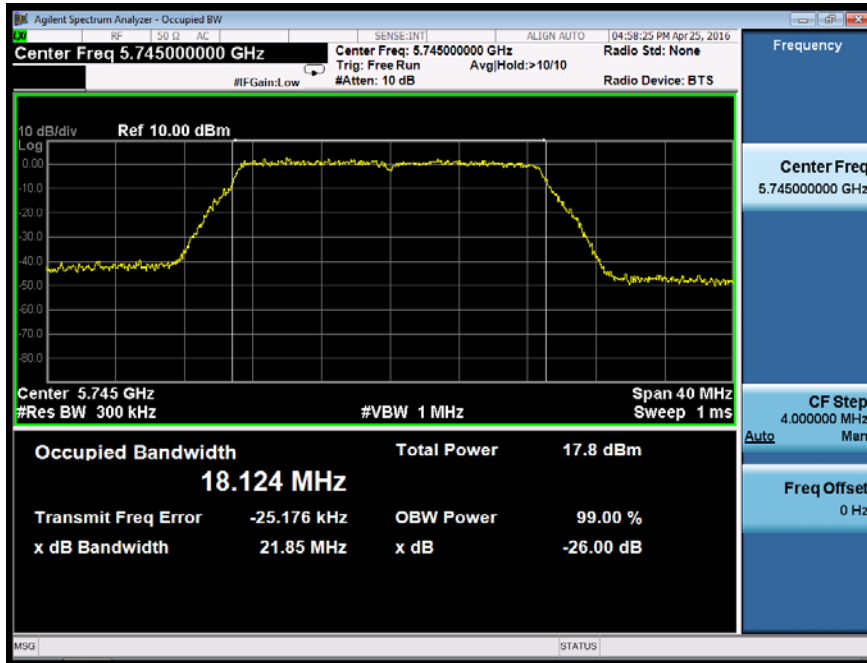

Ant1

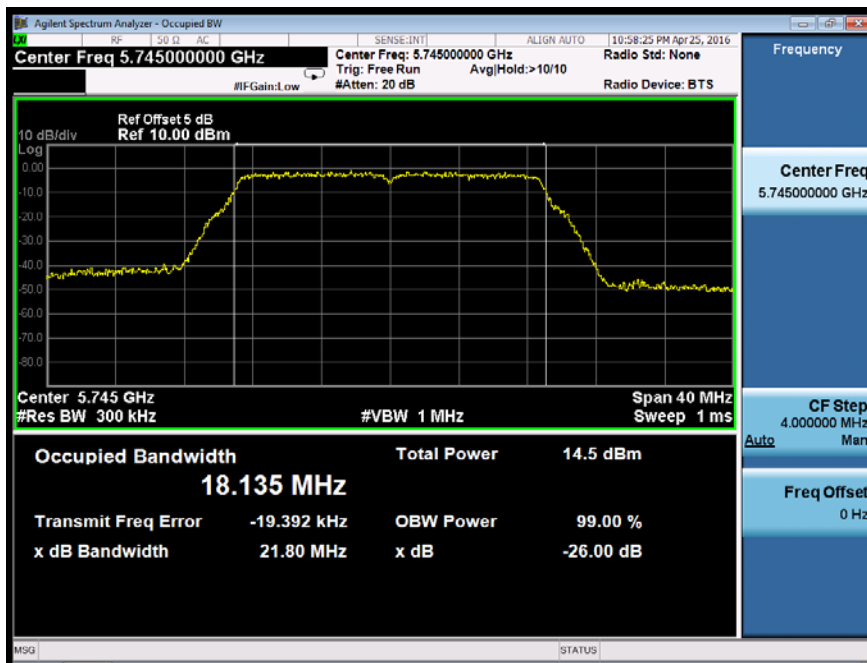

Emission Bandwidth&99% Occupied Bandwidth	UNII Band III	
Test Model	802.11n(VHT20) mode	Frequency(MHz)
Ant0		5785

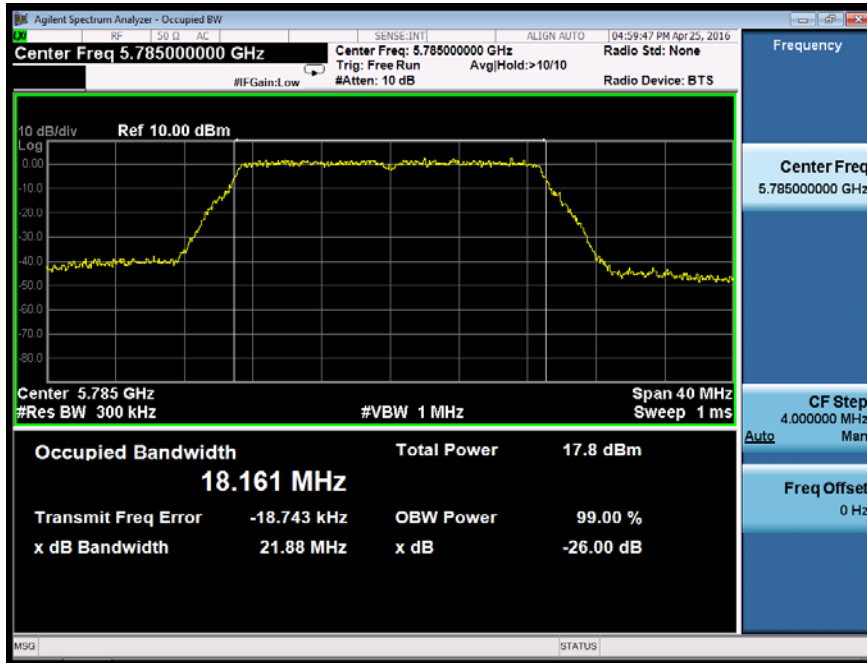

Ant1

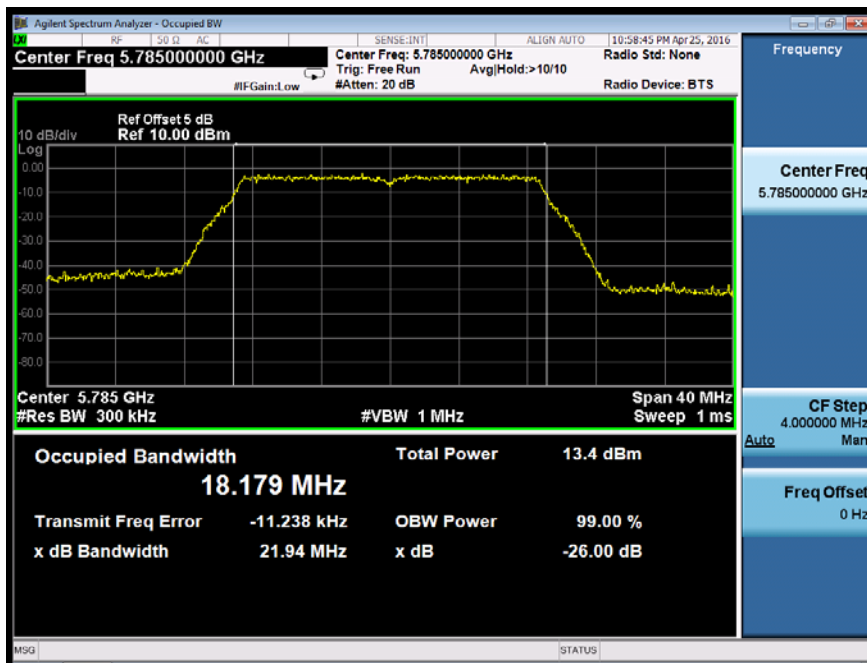

Emission Bandwidth&99% Occupied Bandwidth	UNII Band III
Test Model 802.11n(VHT20) mode	Frequency(MHz) 5825

Ant0

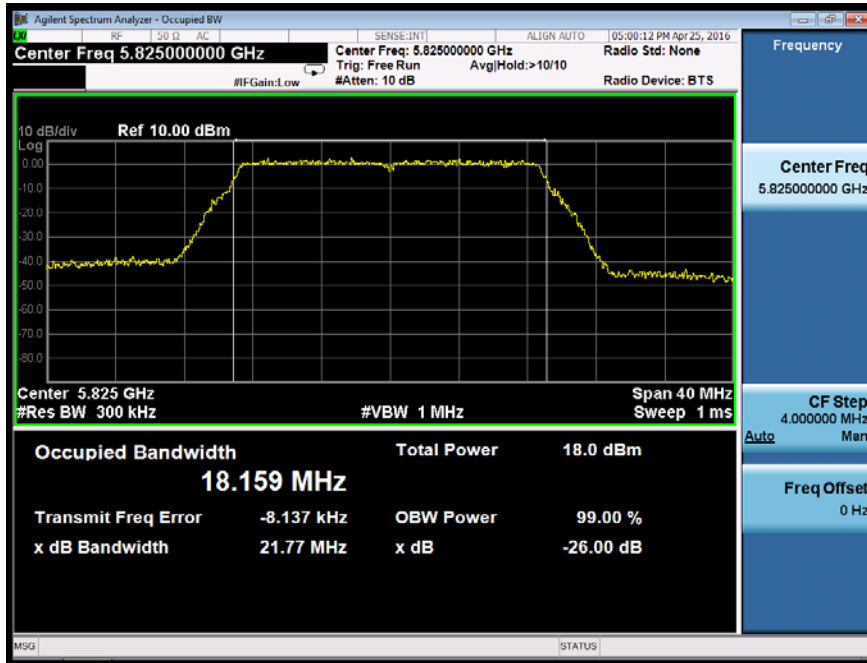

Ant1

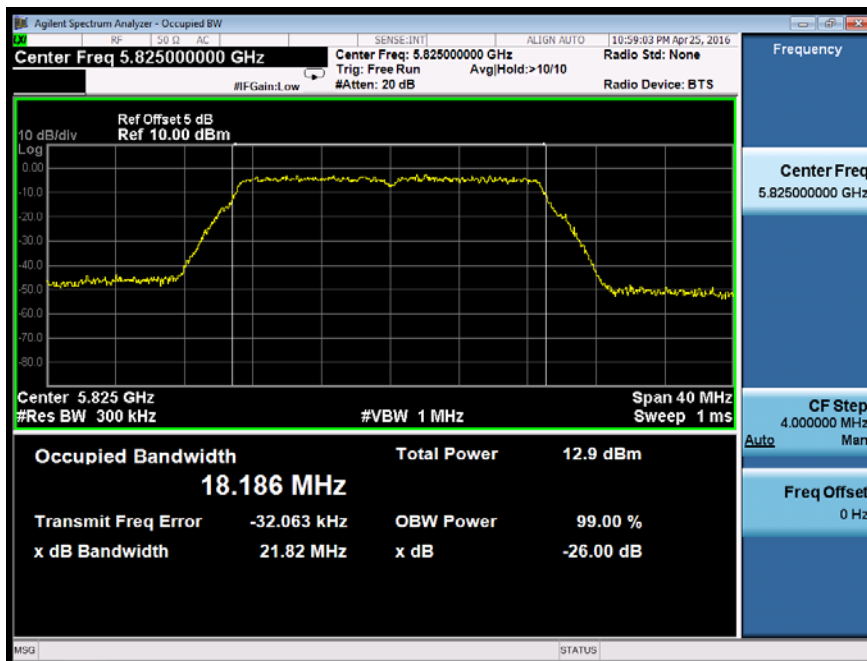

Emission Bandwidth&99% Occupied Bandwidth	UNII Band I
Test Model 802.11ac(VHT20) mode	Frequency(MHz) 5180
Ant0	



Ant1

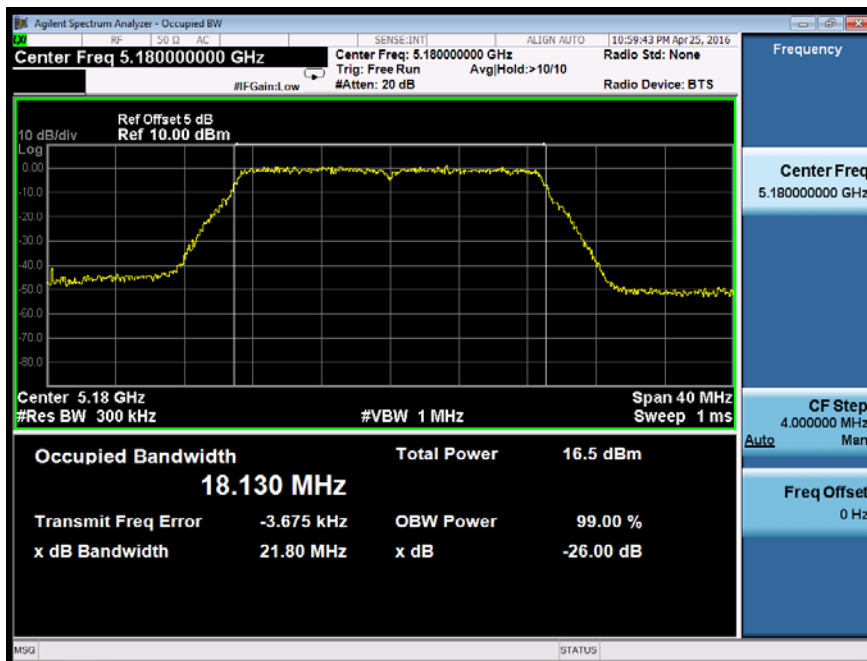

Emission Bandwidth&99% Occupied Bandwidth	UNII Band I
Test Model 802.11ac(VHT20) mode	Frequency(MHz) 5200
Ant0	

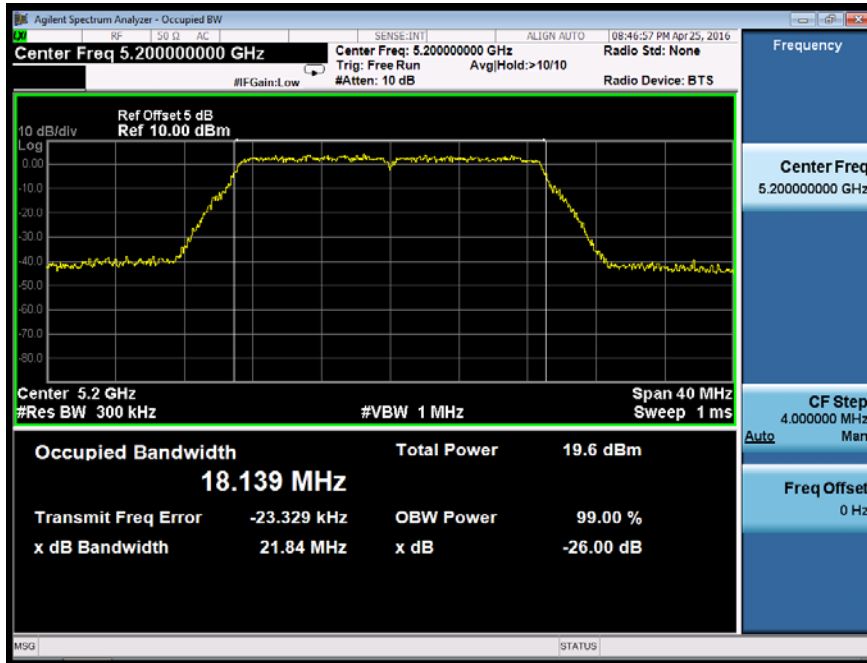

Ant1

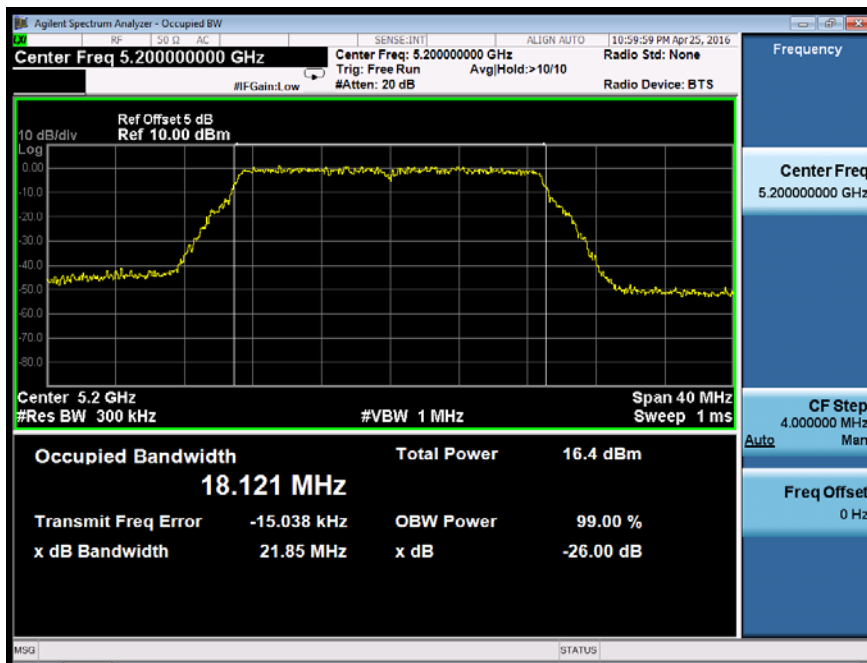

Emission Bandwidth&99% Occupied Bandwidth	UNII Band I
Test Model 802.11ac(VHT20) mode	Frequency(MHz) 5240
Ant0	

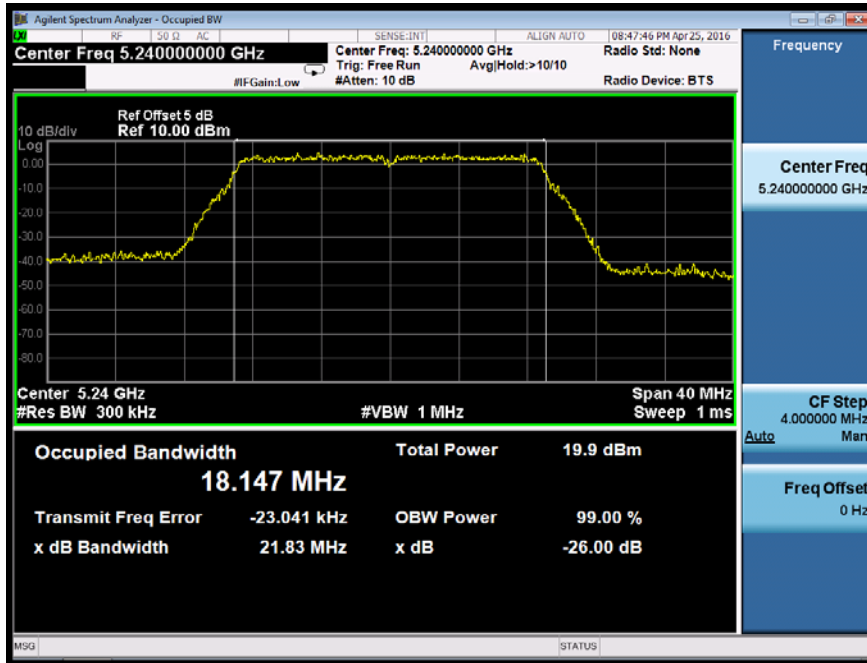

Ant1

