

**FCC 47 CFR PART 15 SUBPART C**  
**CERTIFICATION TEST REPORT**

*For*

WIFI module

MODEL No.: BW2569-32P

FCC ID: VYVBW2569-32P

Trade Mark:N/A

REPORT NO.: ES160321030E3

ISSUE DATE: May 30,2016

*Prepared for*

Iton Technology Crop.

Room 1302, Block A, Building 4, Tianan Cyber Park, HuanggeRoad,  
Longgang District, Shenzhen, China.

*Prepared by*

EMTEK(SHENZHEN) CO., LTD.

Bldg 69, Majialong Industry Zone, Nanshan District,  
Shenzhen, Guangdong, China

TEL: 86-755-26954280

FAX: 86-755-26954282

**TABLE OF CONTENTS**

<b>1</b>	<b>TEST RESULT CERTIFICATION</b> .....	<b>3</b>
<b>2</b>	<b>EUT TECHNICAL DESCRIPTION</b> .....	<b>4</b>
<b>3</b>	<b>SUMMARY OF TEST RESULT</b> .....	<b>5</b>
<b>4</b>	<b>TEST METHODOLOGY</b> .....	<b>6</b>
4.1	GENERAL DESCRIPTION OF APPLIED STANDARDS .....	6
4.2	MEASUREMENT EQUIPMENT USED .....	6
4.3	DESCRIPTION OF TEST MODES .....	7
<b>5</b>	<b>FACILITIES AND ACCREDITATIONS</b> .....	<b>8</b>
5.1	FACILITIES .....	8
5.2	LABORATORY ACCREDITATIONS AND LISTINGS .....	8
<b>6</b>	<b>TEST SYSTEM UNCERTAINTY</b> .....	<b>9</b>
<b>7</b>	<b>SETUP OF EQUIPMENT UNDER TEST</b> .....	<b>10</b>
7.1	RADIO FREQUENCY TEST SETUP 1 .....	10
7.2	RADIO FREQUENCY TEST SETUP 2 .....	10
7.3	CONDUCTED EMISSION TEST SETUP .....	12
7.4	BLOCK DIAGRAM CONFIGURATION OF TEST SYSTEM .....	13
7.5	SUPPORT EQUIPMENT .....	13
<b>8</b>	<b>TEST REQUIREMENTS</b> .....	<b>14</b>
8.1	DTS (6DB) BANDWIDTH .....	14
8.2	MAXIMUM PEAK CONDUCTED OUTPUT POWER .....	32
8.3	MAXIMUM POWER SPECTRAL DENSITY .....	36
8.4	UNWANTED EMISSIONS IN NON-RESTRICTED FREQUENCY BANDS .....	54
8.5	RADIATED SPURIOUS EMISSION .....	65
8.6	CONDUCTED EMISSIONS TEST .....	80
8.7	ANTENNA APPLICATION .....	83

**1 TEST RESULT CERTIFICATION**

Applicant: Iton Technology Crop.  
Room 1302, Block A, Building 4, Tianan Cyber Park, HuanggeRoad, Longgang District, Shenzhen, China

Manufacturer: Iton Technology Crop.  
Room 1302, Block A, Building 4, Tianan Cyber Park, HuanggeRoad, Longgang District, Shenzhen, China

EUT Description: WIFI module

Model Number: BW2569-32P

File Number: ES160321030E3

Date of Test: March 22, 2016 to May 30, 2016

Measurement Procedure Used:

APPLICABLE STANDARDS	
STANDARD	TEST RESULT
FCC 47 CFR Part 2, Subpart J FCC 47 CFR Part 15, Subpart C	PASS

The above equipment was tested by EMTEK(SHENZHEN) CO., LTD.. The test data, data evaluation, test procedures, and equipment configurations shown in this report were made in accordance with the procedures given in ANSI C63.10 (2013) and the energy emitted by the sample EUT tested as described in this report is in compliance with the requirements of FCC Rules Part 2 and Part 15.247

The test results of this report relate only to the tested sample identified in this report.

Date of Test : March 22, 2016 to May 30, 2016

Prepared by : *Joanna Jiao*  
Joanna Jiao/Editor

Reviewer : *Joe Xia*  
Joe Xia /Supervisor



Approve & Authorized Signer : *[Signature]*  
Lisa Wang/Manager

## 2 EUT TECHNICAL DESCRIPTION

Characteristics	Description
Device Type	Wifi 2.4G
IEEE 802.11 WLAN Mode Supported	<input checked="" type="checkbox"/> 802.11b(20MHz bandwidth) <input checked="" type="checkbox"/> 802.11g(20MHz bandwidth) <input checked="" type="checkbox"/> 802.11n(20MHz bandwidth) <input checked="" type="checkbox"/> 802.11n(40MHz bandwidth)
Data Rate	<input checked="" type="checkbox"/> 802.11 b:1,2,5.5,11Mbps <input checked="" type="checkbox"/> 802.11 g:6,9,12,18,24,36,48,54Mbps <input checked="" type="checkbox"/> 802.11n(HT20):MCS0-MCS15 <input checked="" type="checkbox"/> 802.11n(HT40):MCS0-MCS15
MIMO Mode	N/A
Modulation	DSSS with DBPSK/DQPSK/CCK for 802.11b OFDM with BPSK/QPSK/16QAM/64QAM for 802.11g/n
Operating Frequency Range	<input checked="" type="checkbox"/> 2412-2462MHz for 802.11b/g <input checked="" type="checkbox"/> 2412-2462MHz for 802.11n(HT20) <input checked="" type="checkbox"/> 2422-2452MHz for 802.11n(HT40)
Number of Channels	<input checked="" type="checkbox"/> 11 channels for 802.11b/g <input checked="" type="checkbox"/> 11 channels for 802.11n(HT20) <input checked="" type="checkbox"/> 7 channels for 802.11n(HT40)
Transmit Power Max	18.49dBm for 802.11b 18.12dBm for 802.11g 20.83dBm for 802.11n(HT20) 15.94dBm for 802.11n(HT40)
Antenna Type	Monolithic SMD Antenna
Smart system	<input checked="" type="checkbox"/> SISO for 802.11b/g/n <input checked="" type="checkbox"/> MIMO for 802.11n
Antenna Gain	2dBi
Array Gain	5dBi
Power supply	<input checked="" type="checkbox"/> DC supply: DC 3.3V
	<input checked="" type="checkbox"/> Adapter supply: N/A
Temperature Range:	-10°C ~ +50°C

**Note:** for more details, please refer to the User's manual of the EUT.

### 3 SUMMARY OF TEST RESULT

FCC Part Clause	Test Parameter	Verdict	Remark
15.247(a)(2)	DTS (6dB) Bandwidth	PASS	
15.247(b)(3)	Maximum Peak Conducted Output Power	PASS	
15.247(e)	Maximum Power Spectral Density Level	PASS	
15.247(d)	Unwanted Emission Into Non-Restricted Frequency Bands	PASS	
15.247(d) 15.209	Unwanted Emission Into Restricted Frequency Bands (conducted)	PASS	
15.247(d) 15.209	Radiated Spurious Emission	PASS	
15.207	Conducted Emission Test	PASS	
15.247(b)	Antenna Application	PASS	
NOTE1: N/A (Not Applicable)			
NOTE2: According to FCC OET KDB 558074, the report use radiated measurements in the restricted frequency bands. In addition, the radiated test is also performed to ensure the emissions emanating from the device cabinet also comply with the applicable limits.			

RELATED SUBMITTAL(S) / GRANT(S):

This submittal(s) (test report) is intended for FCC ID: VYVBW2569-32P filing to comply with Section 15.247 of the FCC Part 15, Subpart C Rules.

The system is compliance with Subpart B is authorized under a DOC procedure

## 4 TEST METHODOLOGY

### 4.1 GENERAL DESCRIPTION OF APPLIED STANDARDS

According to its specifications, the EUT must comply with the requirements of the following standards:  
 FCC 47 CFR Part 2, Subpart J  
 FCC 47 CFR Part 15, Subpart C  
 FCC KDB 558074 D01 DTS Meas Guidance v03r05  
 FCC KDB 662911 D01 Multiple Transmitter Output v02r01  
 FCC KDB 662911 D02 MIMO With Cross Polarized Antenna V01

### 4.2 MEASUREMENT EQUIPMENT USED

#### 4.2.1 Conducted Emission Test Equipment

EQUIPMENT TYPE	MFR	MODEL NUMBER	SERIAL NUMBER	LAST CAL.
Test Receiver	Rohde & Schwarz	ESCS30	828985/018	05/16/2016
L.I.S.N.	Schwarzbeck	NNLK8129	8129203	05/16/2016
50Ω Coaxial Switch	Anritsu	MP59B	M20531	N/A
Pulse Limiter	Rohde & Schwarz	ESH3-Z2	100006	05/16/2016
Voltage Probe	Rohde & Schwarz	TK9416	N/A	05/16/2016
I.S.N	Rohde & Schwarz	ENY22	1109.9508.02	05/16/2016

#### 4.2.2 Radiated Emission Test Equipment

EQUIPMENT TYPE	MFR	MODEL NUMBER	SERIAL NUMBER	LAST CAL.
EMI Test Receiver	Rohde & Schwarz	ESU	1302.6005.26	05/16/2016
Pre-Amplifier	HP	8447D	2944A07999	05/16/2016
Bilog Antenna	Schwarzbeck	VULB9163	142	05/16/2016
Loop Antenna	ARA	PLA-1030/B	1029	05/16/2016
Horn Antenna	Schwarzbeck	BBHA 9170	BBHA9170399	05/16/2016
Horn Antenna	Schwarzbeck	BBHA 9120	D143	05/16/2016
Cable	Schwarzbeck	AK9513	ACRX1	05/16/2016
Cable	Rosenberger	N/A	FP2RX2	05/16/2016
Cable	Schwarzbeck	AK9513	CRPX1	05/16/2016
Cable	Schwarzbeck	AK9513	CRRX2	05/16/2016

#### 4.2.3 Radio Frequency Test Equipment

EQUIPMENT TYPE	MFR	MODEL NUMBER	SERIAL NUMBER	LAST CAL.
Spectrum Analyzer	Agilent	E4407B	88156318	05/16/2016
Signal Analyzer	Agilent	N9010A	My53470879	05/16/2016
Power meter	Anritsu	ML2495A	0824006	05/16/2016
Power sensor	Anritsu	MA2411B	0738172	05/16/2016

**Remark:** Each piece of equipment is scheduled for calibration once a year.

### 4.3 DESCRIPTION OF TEST MODES

The EUT has been tested under its typical operating condition.

The EUT configuration for testing is installed on RF field strength measurement to meet the Commissions requirement and operating in a manner which intends to maximize its emission characteristics in a continuous normal application.

The Transmitter was operated in the normal operating mode. The TX frequency was fixed which was for the purpose of the measurements.

Test of channel included the lowest and middle and highest frequency to perform the test, then record on this report.

Those data rates (802.11b: 1 Mbps; 802.11g: 6 Mbps; 802.11n (HT20 ): MCS0; 802.11n (HT20 ): MCS15; 802.11n (HT40 ): MCS0) ; 802.11n (HT40 ): MCS15) were used for all test.

Pre-defined engineering program for regulatory testing used to control the EUT for staying in continuous transmitting and receiving mode is programmed.

Frequency and Channel list for 802.11 b/g/n (HT20):

Channel	Frequency (MHz)	Channel	Frequency (MHz)	Channel	Frequency (MHz)
1	2412	5	2432	9	2452
2	2417	6	2437	10	2457
3	2422	7	2442	11	2462
4	2427	8	2447		

Frequency and Channel list for 802.11 n (HT40):

Channel	Frequency (MHz)	Channel	Frequency (MHz)	Channel	Frequency (MHz)
3	2422	5	2432	8	2447
4	2427	6	2437	9	2452
		7	2442		

Test Frequency and Channel for 802.11 b/g/n (HT20):

Lowest Frequency		Middle Frequency		Highest Frequency	
Channel	Frequency (MHz)	Channel	Frequency (MHz)	Channel	Frequency (MHz)
1	2412	6	2437	11	2462

Test Frequency and channel for 802.11 n (HT40):

Lowest Frequency		Middle Frequency		Highest Frequency	
Channel	Frequency (MHz)	Channel	Frequency (MHz)	Channel	Frequency (MHz)
3	2422	6	2437	9	2452

## 5 FACILITIES AND ACCREDITATIONS

### 5.1 FACILITIES

All measurement facilities used to collect the measurement data are located at

Bldg 69, Majialong Industry Zone District, Nanshan District, Shenzhen, China

The sites are constructed in conformance with the requirements of ANSI C63.7, ANSI C63.10 and CISPR Publication 22.

### 5.2 LABORATORY ACCREDITATIONS AND LISTINGS

Site Description

EMC Lab.

: Accredited by CNAS, 2013.10.29

The certificate is valid until 2016.10.28

The Laboratory has been assessed and proved to be in compliance with CNAS-CL01:2006 (identical to ISO/IEC 17025:2005)

The Certificate Registration Number is L2291.

Accredited by TUV Rheinland Shenzhen 2015.4

The Laboratory has been assessed according to the requirements ISO/IEC 17025.

Accredited by FCC, April 17, 2013

The Certificate Registration Number is 709623.

Accredited by FCC, July 24, 2013

The Certificate Registration Number is 406365.

Accredited by Industry Canada, November 24, 2015

The Certificate Registration Number is 4480A.

Name of Firm

: EMTEK (SHENZHEN) CO., LTD..

Site Location

: Bldg 69, Majialong Industry Zone,  
Nanshan District, Shenzhen, Guangdong, China



## 6 TEST SYSTEM UNCERTAINTY

The following measurement uncertainty levels have been estimated for tests performed on the apparatus:

Parameter	Uncertainty
Radio Frequency	$\pm 1 \times 10^{-5}$
Maximum Peak Output Power Test	$\pm 1.0\text{dB}$
Conducted Emissions Test	$\pm 2.0\text{dB}$
Radiated Emission Test	$\pm 2.0\text{dB}$
Power Density	$\pm 2.0\text{dB}$
Occupied Bandwidth Test	$\pm 1.0\text{dB}$
Band Edge Test	$\pm 3\text{dB}$
All emission, radiated	$\pm 3\text{dB}$
Antenna Port Emission	$\pm 3\text{dB}$
Temperature	$\pm 0.5^\circ\text{C}$
Humidity	$\pm 3\%$

Measurement Uncertainty for a level of Confidence of 95%

## 7 SETUP OF EQUIPMENT UNDER TEST

### 7.1 RADIO FREQUENCY TEST SETUP 1

The WLAN component's antenna ports(s) of the EUT are connected to the measurement instrument per an appropriate attenuator. The EUT is controlled by PC/software to emit the specified signals for the purpose of measurements.

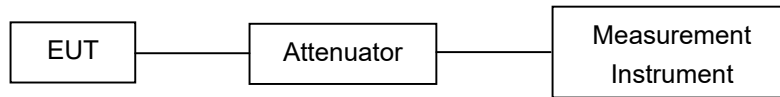

### 7.2 RADIO FREQUENCY TEST SETUP 2

The test site semi-anechoic chamber has met the requirement of NSA tolerance 4 dB according to the standards: ANSI C63.10. The test distance is 3m. The setup is according to the requirements in Section 13.1.4.1 of ANSI C63.10-2013 and CAN/CSA-CEI/IEC CISPR 22.

Below 30MHz:

The EUT is placed on a turntable 0.8 meters above the ground in the chamber, 3 meter away from the antenna (loop antenna). The Antenna should be positioned with its plane vertical at the specified distance from the EUT and rotated about its vertical axis for maximum response at each azimuth about the EUT. The center of the loop shall be 1 m above the ground. For certain applications, the loop antenna plane may also need to be positioned horizontally at the specified distance from the EUT.

Above 30MHz:

The EUT is placed on a turntable 0.8 meters above the ground in the chamber, 3 meter away from the antenna. The maximal emission value is acquired by adjusting the antenna height, polarisation and turntable azimuth. Normally, the height range of antenna is 1 m to 4 m, the azimuth range of turntable is 0° to 360°, and the receive antenna has two polarizations Vertical (V) and Horizontal (H).

Above 1GHz:

(Note: the FCC's permission to use 1.5m as an alternative per TCBC Conf call of Dec. 2, 2014.)

The EUT is placed on a turntable 1.5 meters above the ground in the chamber, 3 meter away from the antenna. The maximal emission value is acquired by adjusting the antenna height, polarisation and turntable azimuth. Normally, the height range of antenna is 1 m to 4 m, the azimuth range of turntable is 0° to 360°, and the receive antenna has two polarizations Vertical (V) and Horizontal (H).

(a) Radiated Emission Test Set-Up, Frequency Below 30MHz

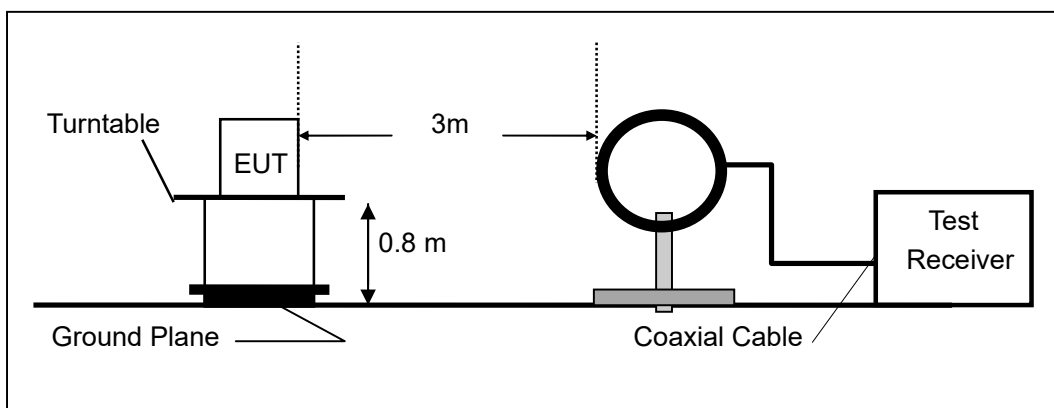

(b) Radiated Emission Test Set-Up, Frequency Below 1000MHz

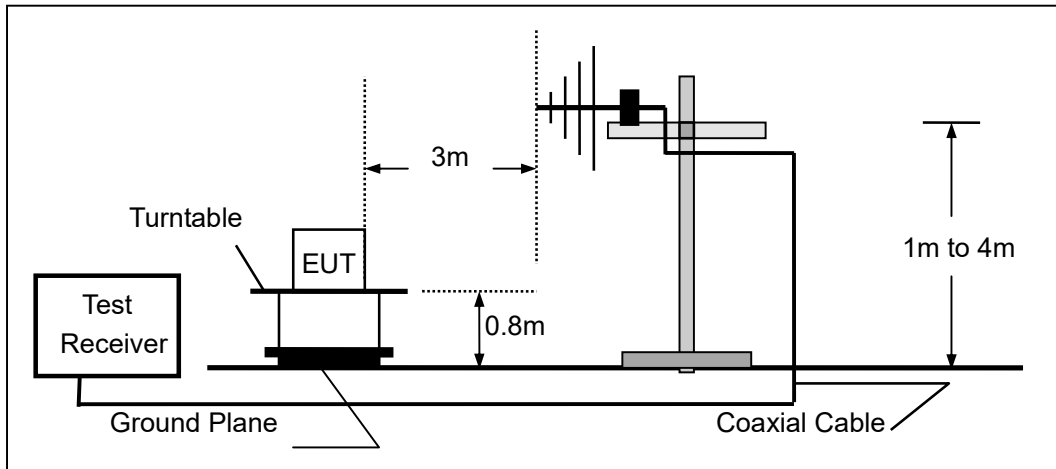

(c) Radiated Emission Test Set-Up, Frequency above 1000MHz

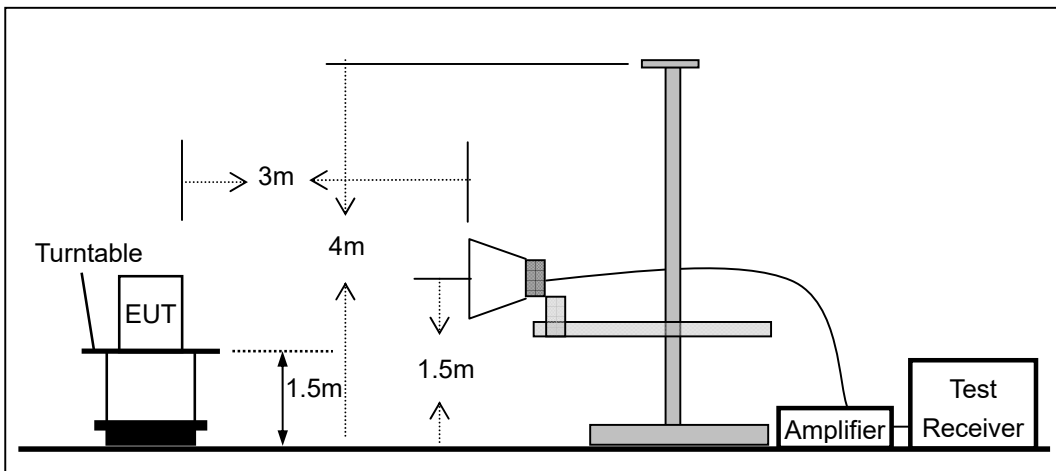

### 7.3 CONDUCTED EMISSION TEST SETUP

The mains cable of the EUT (maybe per AC/DC Adapter) must be connected to LISN. The LISN shall be placed 0.8 m from the boundary of EUT and bonded to a ground reference plane for LISN mounted on top of the ground reference plane. This distance is between the closest points of the LISN and the EUT. All other units of the EUT and associated equipment shall be at least 0.8m from the LISN.

Ground connections, where required for safety purposes, shall be connected to the reference ground point of the LISN and, where not otherwise provided or specified by the manufacturer, shall be of same length as the mains cable and run parallel to the mains connection at a separation distance of not more than 0.1 m.

According to the requirements in Section 13.1.4.1 of ANSI C63.10-2013 Conducted emissions from the EUT measured in the frequency range between 0.15 MHz and 30 MHz using CISPR Quasi-Peak and average detector mode.

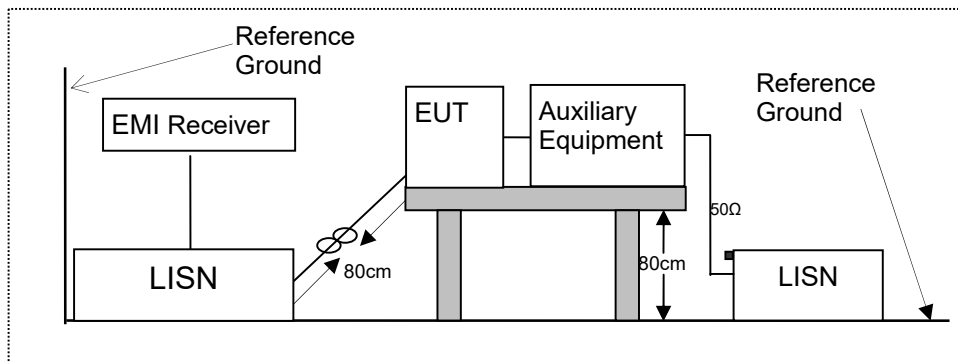

**7.4 BLOCK DIAGRAM CONFIGURATION OF TEST SYSTEM**

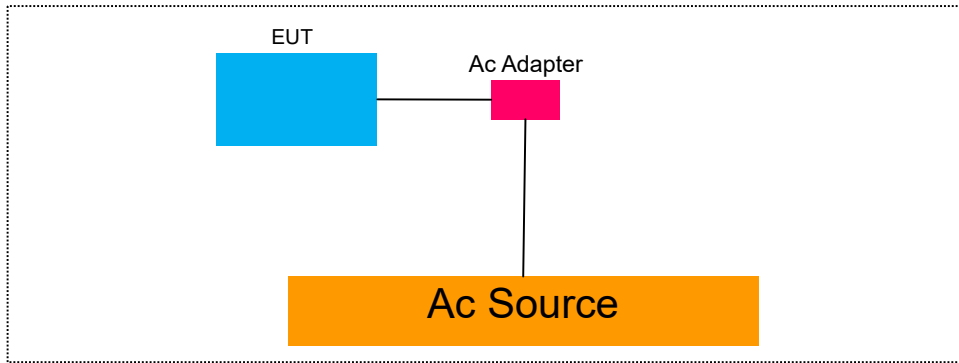

**7.5 SUPPORT EQUIPMENT**

Item	Equipment	Mfr/Brand	Model/Type No.	FCC ID	Series No.	Note
1.	Notebook	Lenovo	WB0205140E	N/A	N/A	Notebook

**Notes:**

1. All the equipment/cables were placed in the worst-case configuration to maximize the emission during the test.
2. Grounding was established in accordance with the manufacturer's requirements and conditions for the intended use.

## 8 TEST REQUIREMENTS

### 8.1 DTS (6DB) BANDWIDTH

#### 8.1.1 Applicable Standard

According to FCC Part 15.247(a)(2) and KDB 558074 DTS 01 Meas. Guidance v03r05

#### 8.1.2 Conformance Limit

The minimum -6 dB bandwidth shall be at least 500 kHz.

#### 8.1.3 Test Configuration

Test according to clause 7.1 radio frequency test setup 1

#### 8.1.4 Test Procedure

The EUT was operating in IEEE 802.11b/g/n mode and controlled its channel. Printed out the test result from the spectrum by hard copy function.

The RF output of EUT was connected to the spectrum analyzer by RF cable and attenuator. The path loss was compensated to the results for each measurement.

Set to the maximum power setting and enable the EUT transmit continuously

Set RBW = 100 kHz.

Set the video bandwidth (VBW) =300 kHz.

Set Span=2 times OBW

Set Detector = Peak.

Set Trace mode = max hold.

Set Sweep = auto couple.

Allow the trace to stabilize.

Measure the maximum width of the emission that is constrained by the frequencies associated with the two outermost amplitude points (upper and lower frequencies) that are attenuated by 6 dB relative to the maximum level measured in the fundamental emission.

Measure and record the results in the test report.

#### 8.1.5 Test Results

Temperature :	28 °C	Test Date :	April 20, 2016
Humidity :	65 %	Test By:	King Kong
Antenna:	A		

Operation Mode	Channel Number	Channel Frequency (MHz)	Measurement Bandwidth (MHz)	Limit (kHz)	Verdict
☒802.11b	1	2412	9.063	500	PASS
	6	2437	9.094	500	PASS
	11	2462	9.092	500	PASS
☒802.11g	1	2412	16.380	500	PASS
	6	2437	16.390	500	PASS
	11	2462	16.400	500	PASS
☒802.11n (HT20)	1	2412	17.640	500	PASS
	6	2437	17.630	500	PASS
	11	2462	17.640	500	PASS
☒802.11n (HT40)	3	2422	36.380	500	PASS
	6	2437	36.380	500	PASS
	9	2452	36.390	500	PASS

Temperature :	28 °C	Test Date :	April 20, 2016
Humidity :	65 %	Test By:	King Kong
Antenna:	B		

Operation Mode	Channel Number	Channel Frequency (MHz)	Measurement Bandwidth (MHz)	Limit (kHz)	Verdict
☒802.11b	1	2412	9.095	500	PASS
	6	2437	9.098	500	PASS
	11	2462	9.081	500	PASS
☒802.11g	1	2412	16.400	500	PASS
	6	2437	16.400	500	PASS
	11	2462	16.400	500	PASS
☒802.11n (HT20)	1	2412	17.650	500	PASS
	6	2437	17.630	500	PASS
	11	2462	17.650	500	PASS
☒802.11n (HT40)	3	2422	36.390	500	PASS
	6	2437	36.400	500	PASS
	9	2452	35.400	500	PASS

For Antenna A

Test Model	DTS (6dB) Bandwidth 802.11b Channel 1: 2412MHz
------------	--

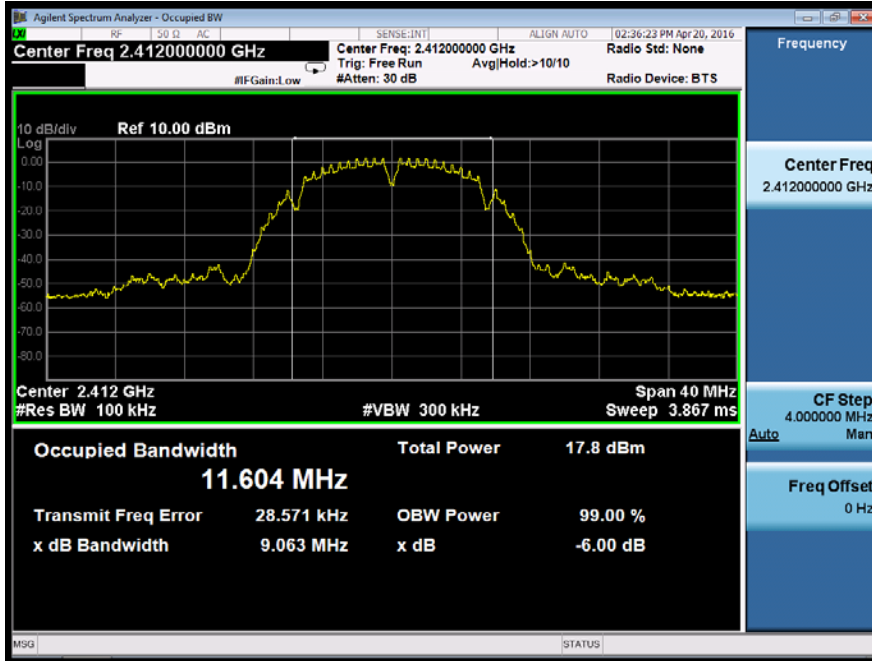

Test Model	DTS (6dB) Bandwidth 802.11b Channel 6: 2437MHz
------------	--

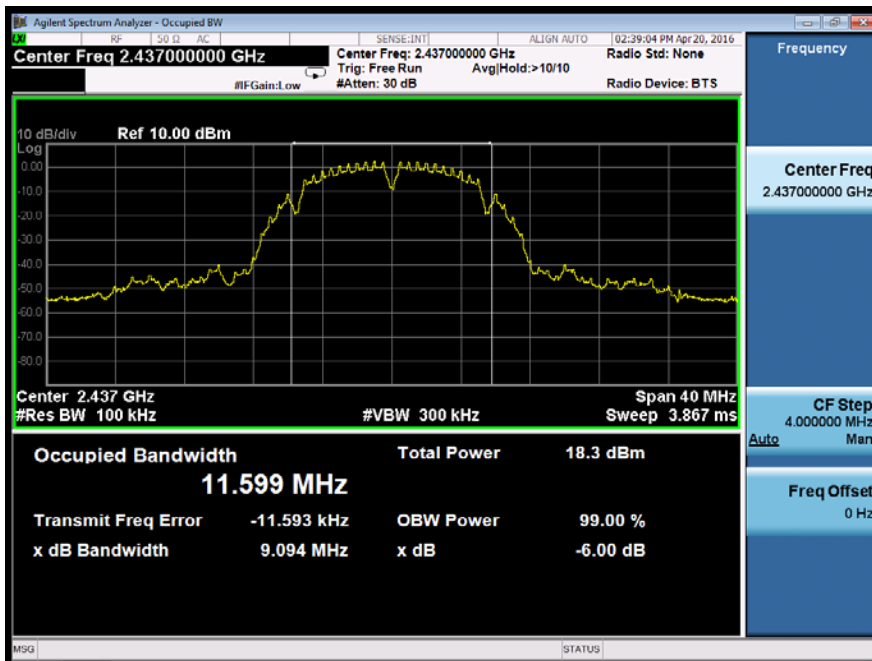



Test Model	DTS (6dB) Bandwidth 802.11b Channel 11: 2462MHz
------------	---

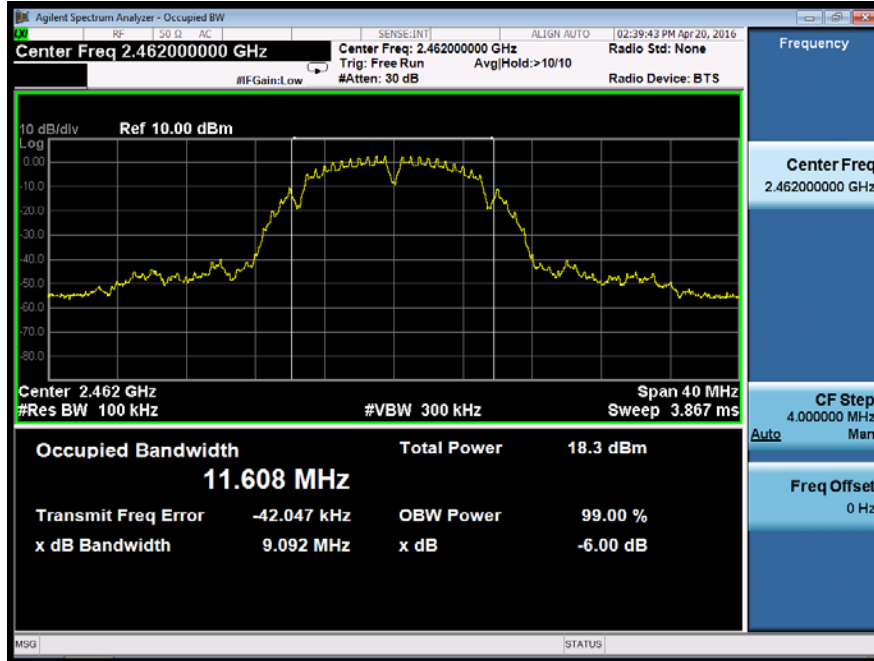

Test Model      DTS (6dB) Bandwidth  
802.11g  
Channel 1: 2412MHz

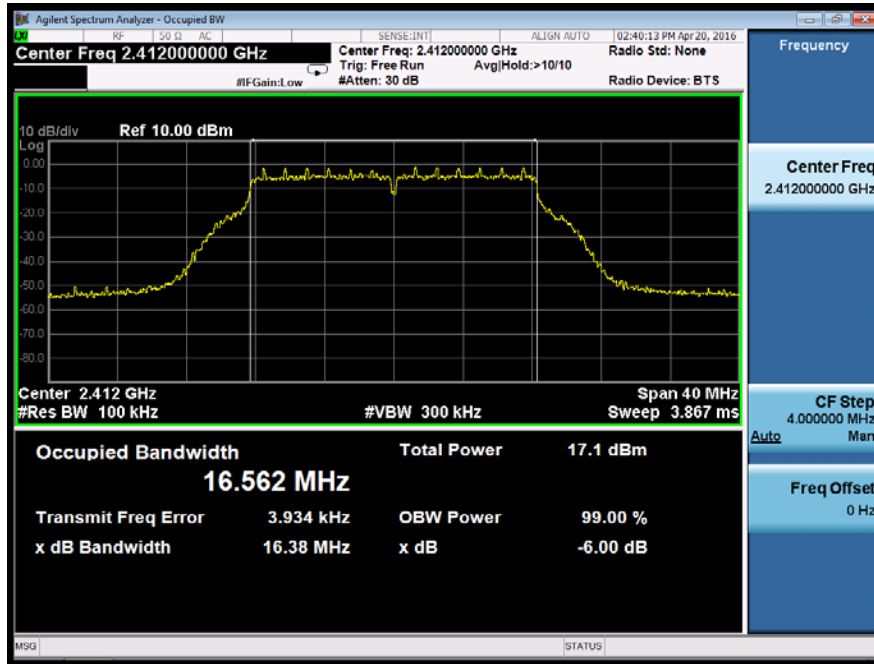

Test Model      DTS (6dB) Bandwidth  
802.11g  
Channel 6: 2437MHz

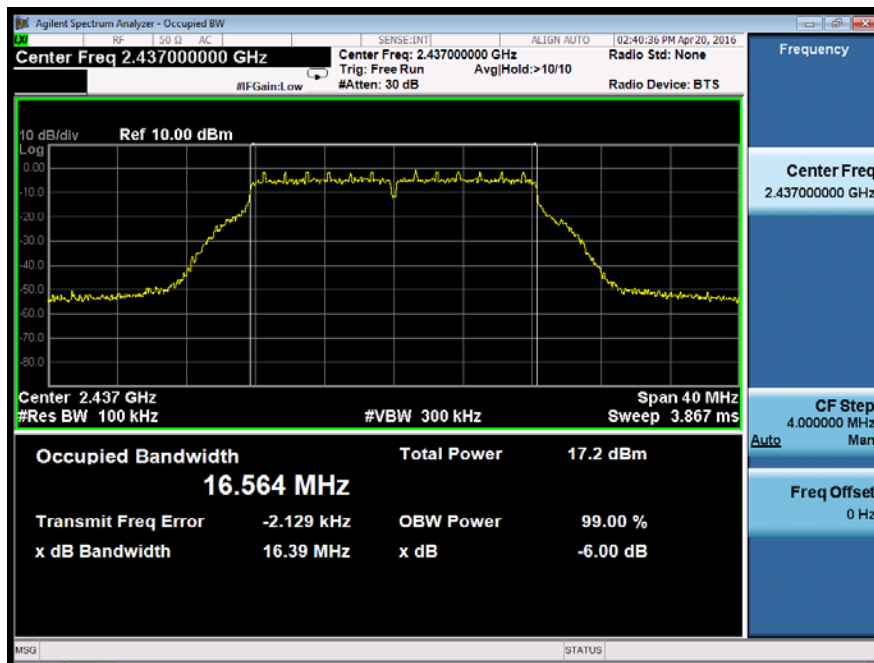

Test Model

DTS (6dB) Bandwidth  
802.11g  
Channel 11: 2462MHz

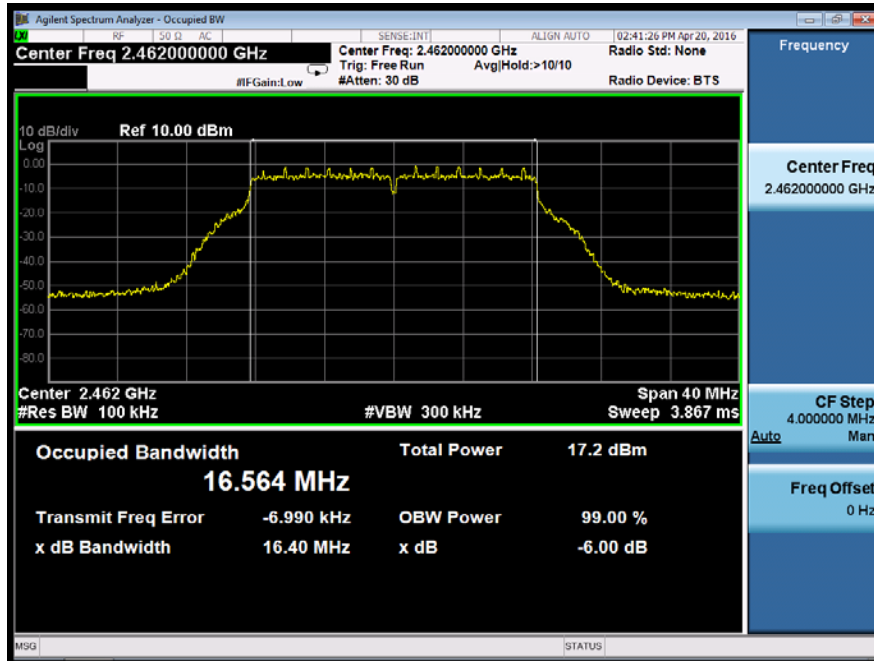

Test Model	DTS (6dB) Bandwidth 802.11n (HT20) Channel 1: 2412MHz
------------	---

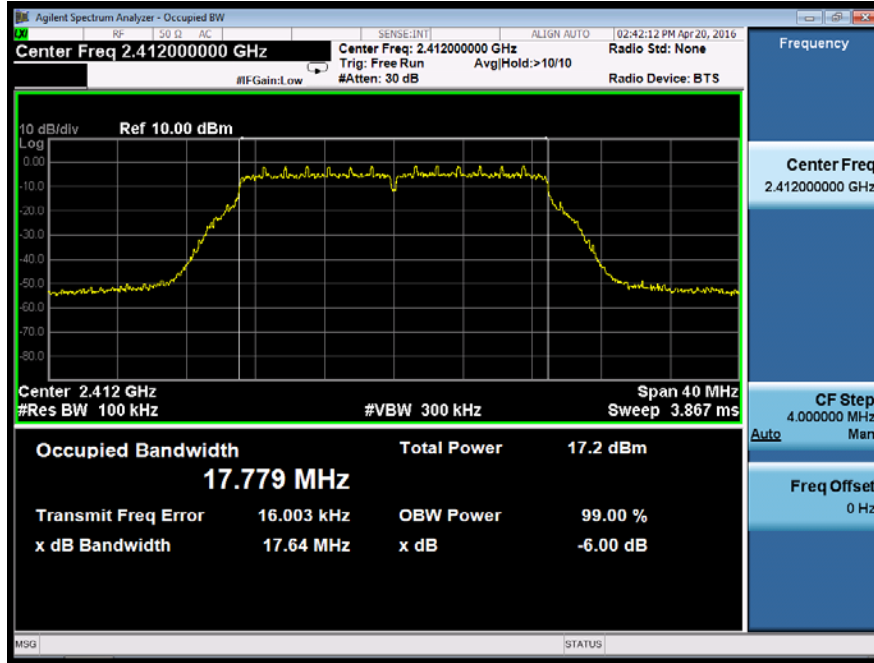

Test Model	DTS (6dB) Bandwidth 802.11n (HT20) Channel 6: 2437MHz
------------	---

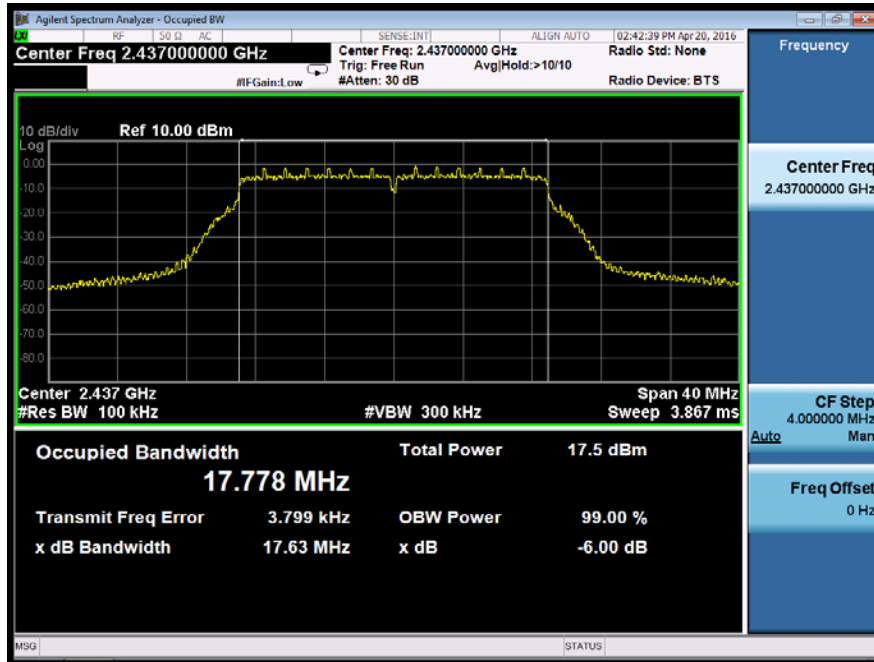

Test Model	DTS (6dB) Bandwidth
	802.11n (HT20)
	Channel 11: 2462MHz

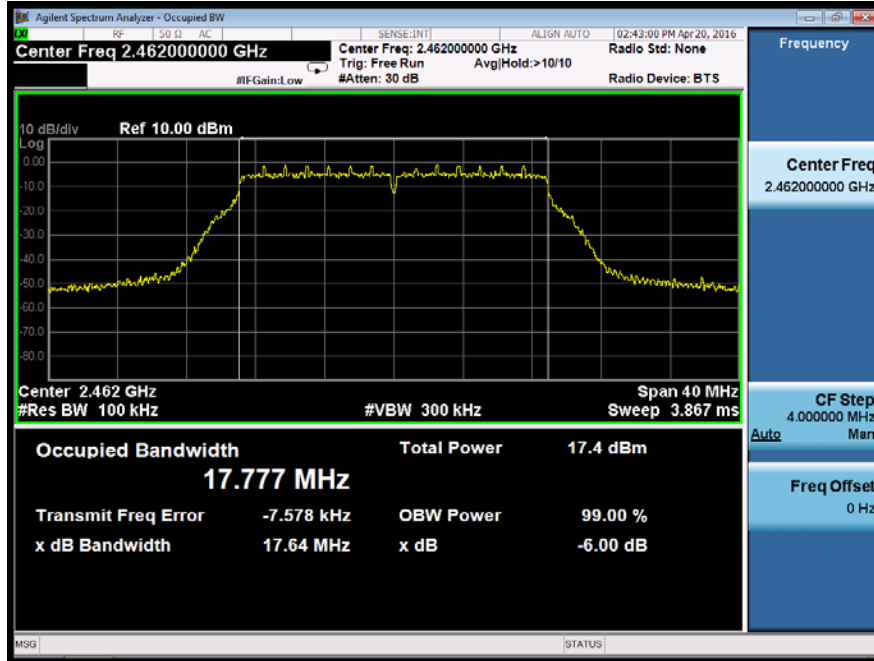

Test Model	DTS (6dB) Bandwidth 802.11n (HT40) Channel 3: 2422MHz
------------	---

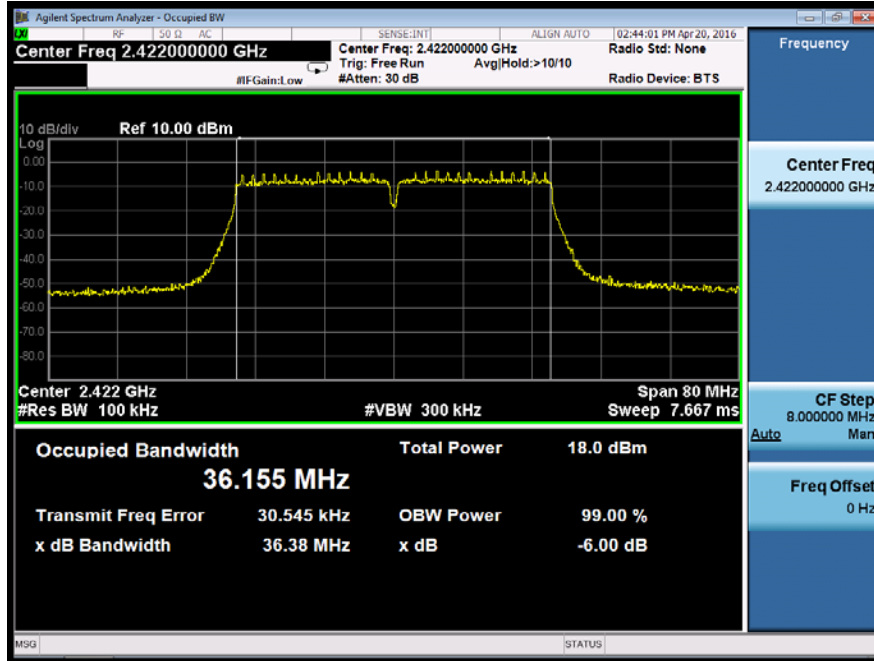

Test Model	DTS (6dB) Bandwidth 802.11n (HT40) Channel 6: 2437MHz
------------	---

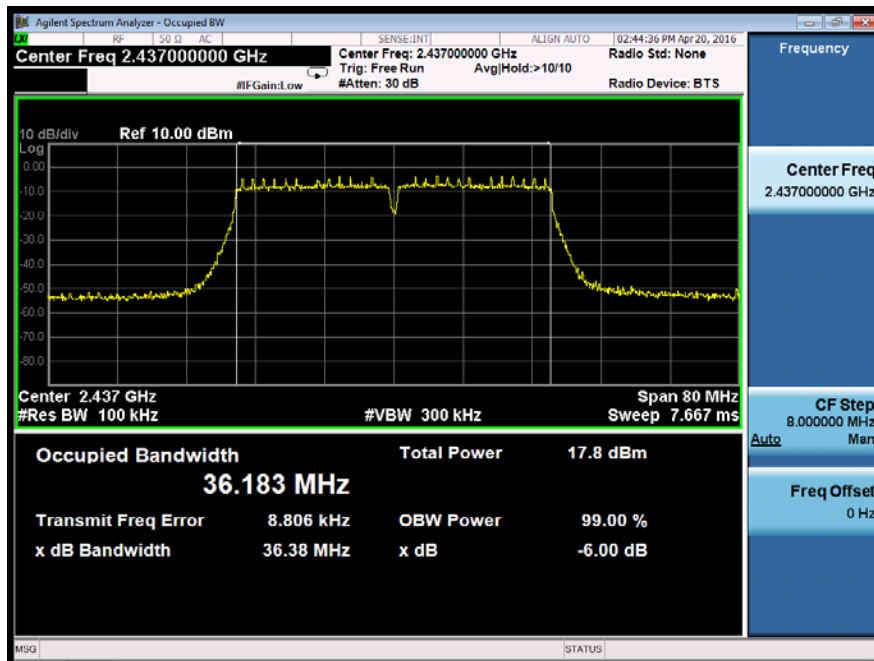

Test Model	DTS (6dB) Bandwidth 802.11n (HT40) Channel 9: 2452MHz
------------	---

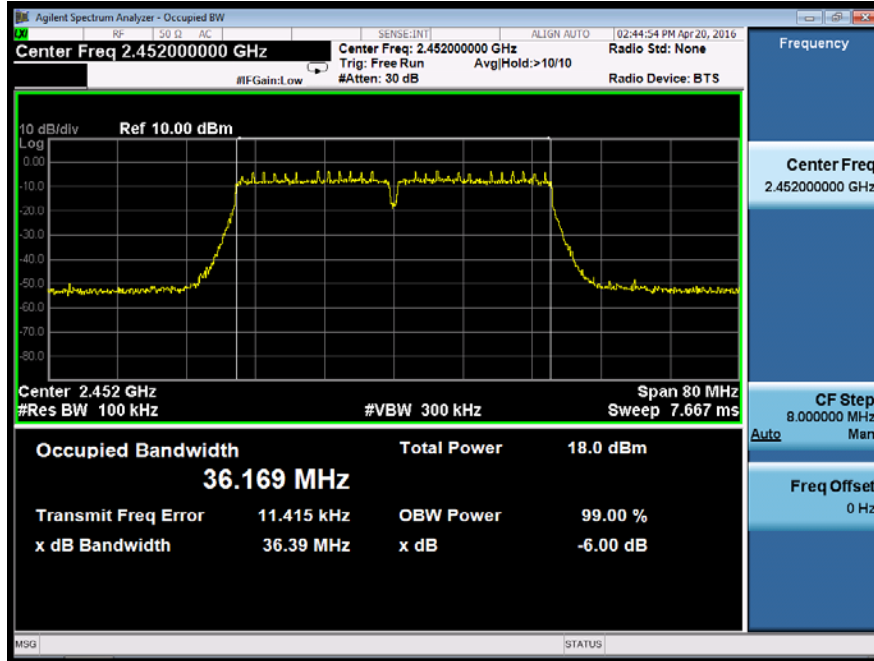

For Antenna B

Test Model	DTS (6dB) Bandwidth 802.11b Channel 1: 2412MHz
------------	--

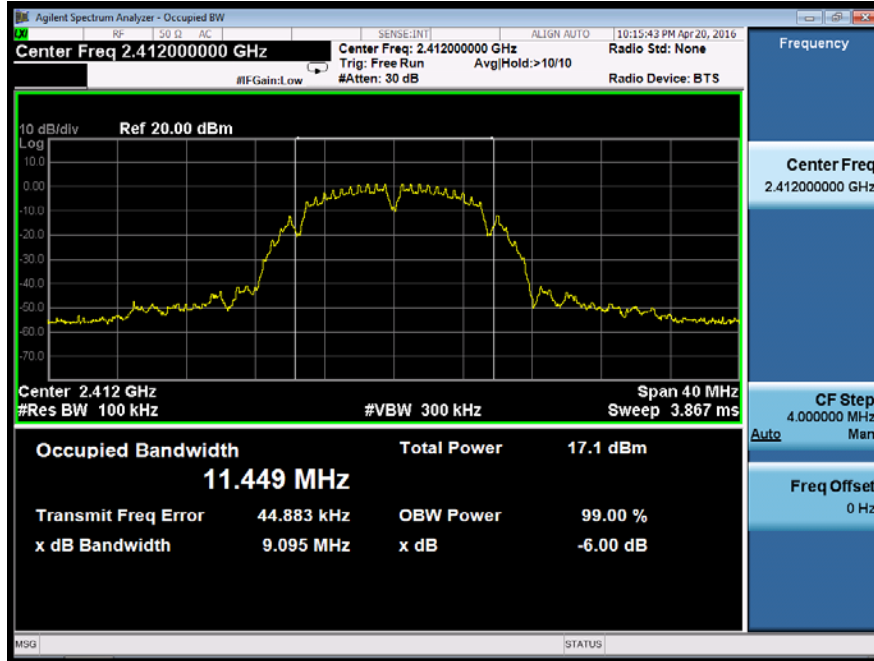

Test Model	DTS (6dB) Bandwidth 802.11b Channel 6: 2437MHz
------------	--

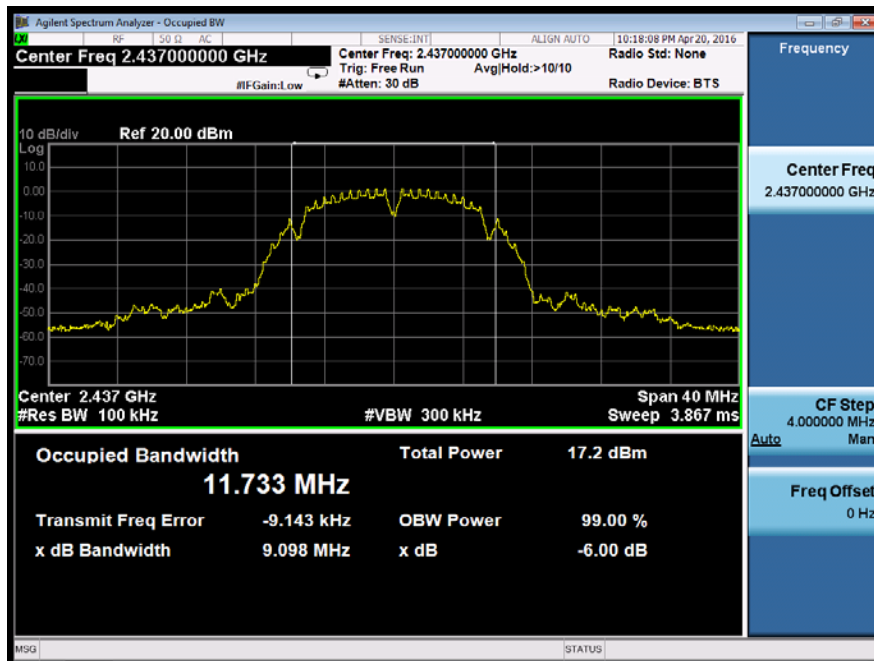



Test Model	DTS (6dB) Bandwidth	
	802.11b	
	Channel 11: 2462MHz	

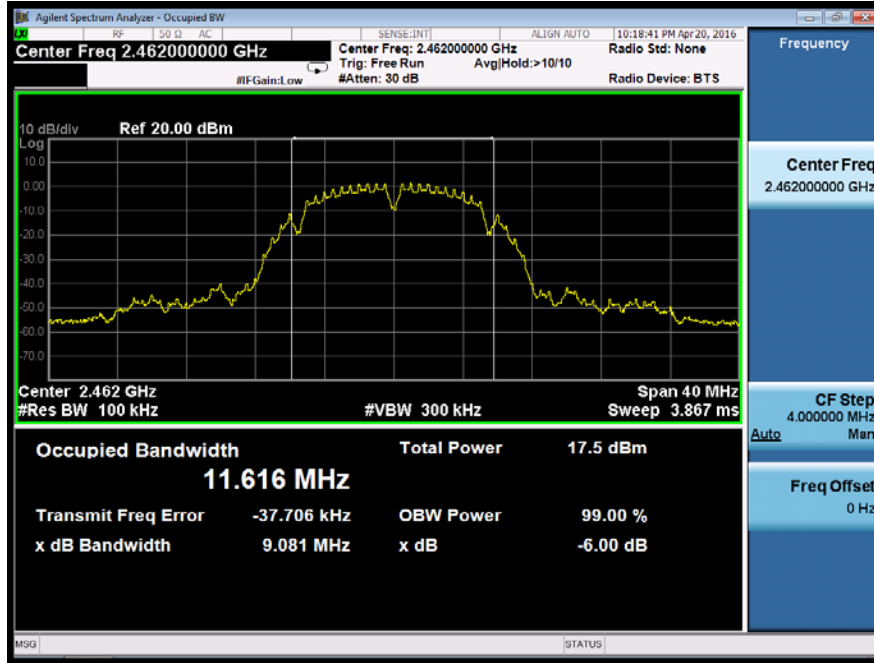

Test Model      DTS (6dB) Bandwidth  
802.11g  
Channel 1: 2412MHz

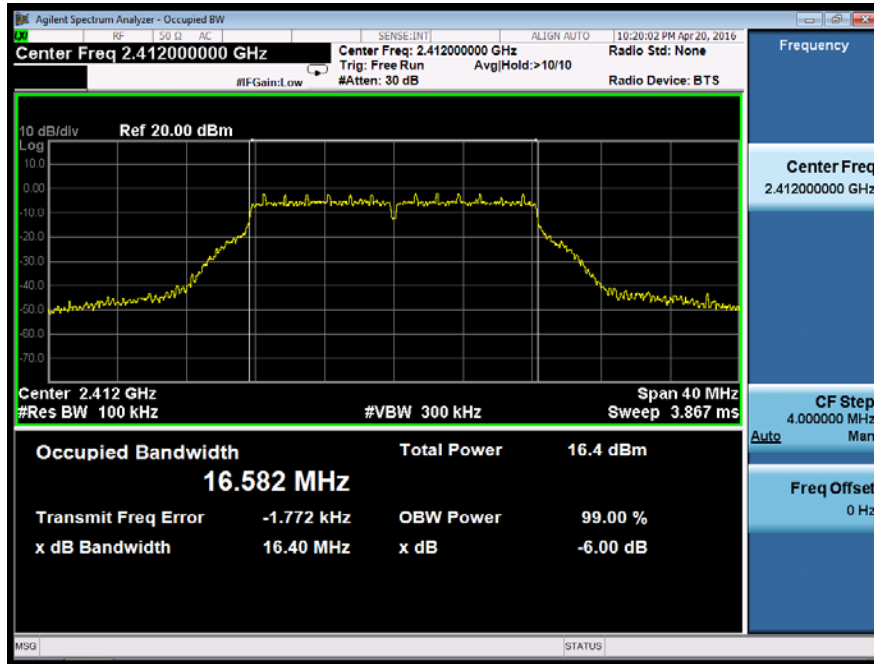

Test Model      DTS (6dB) Bandwidth  
802.11g  
Channel 6: 2437MHz

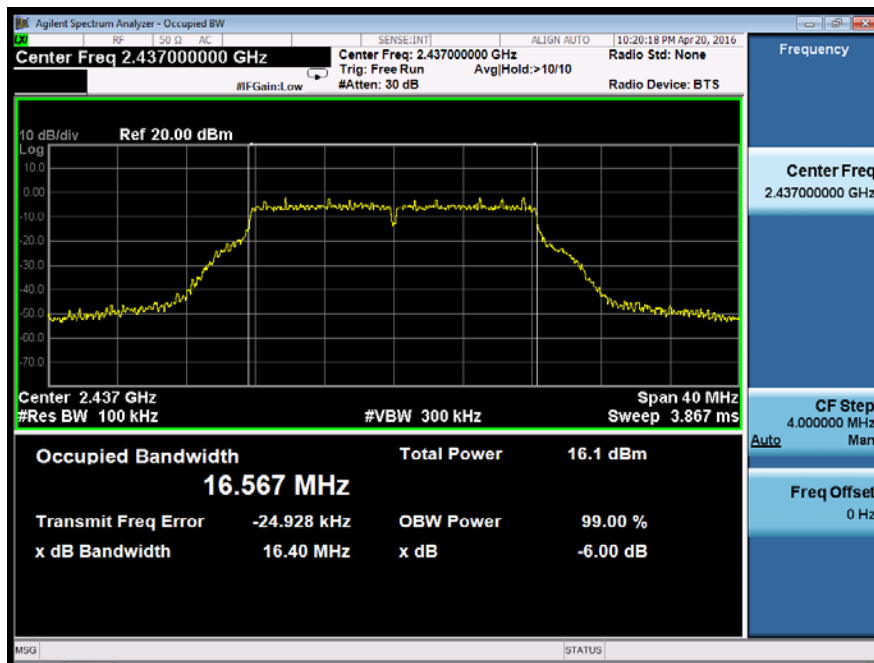

Test Model	DTS (6dB) Bandwidth 802.11g Channel 11: 2462MHz
------------	---



Test Model	DTS (6dB) Bandwidth 802.11n (HT20) Channel 1: 2412MHz
------------	---

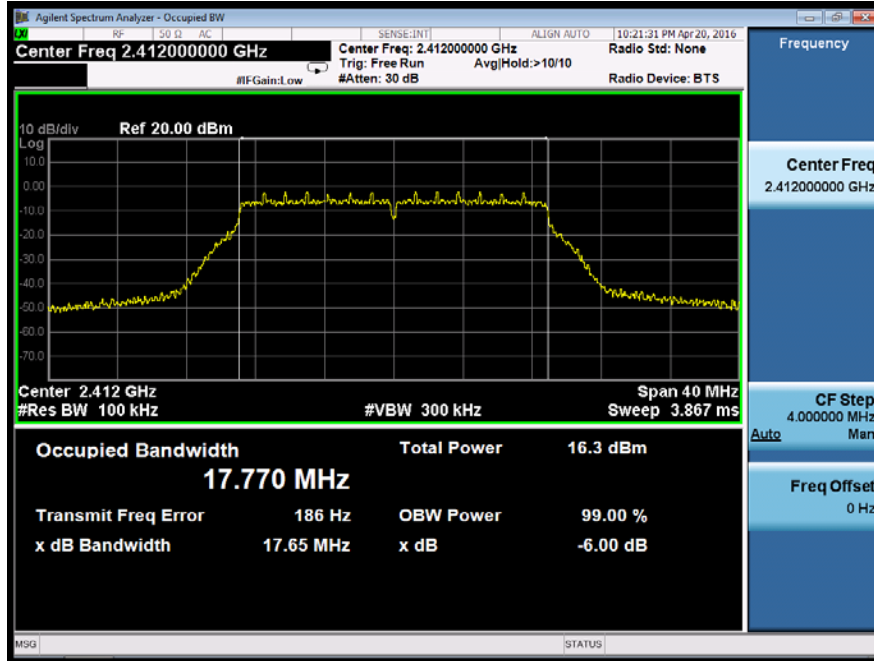

Test Model	DTS (6dB) Bandwidth 802.11n (HT20) Channel 6: 2437MHz
------------	---

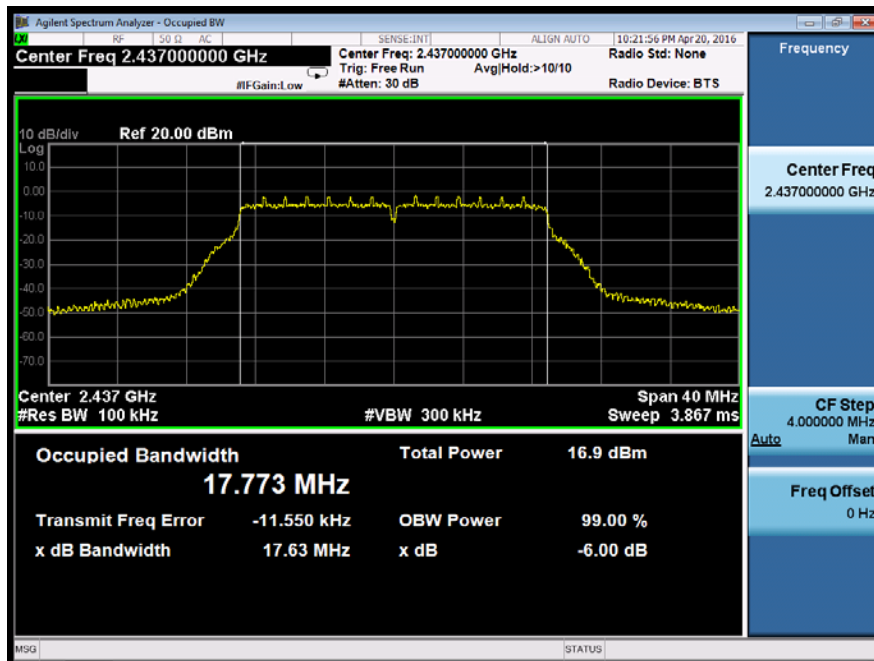

Test Model	DTS (6dB) Bandwidth 802.11n (HT20) Channel 11: 2462MHz
------------	--

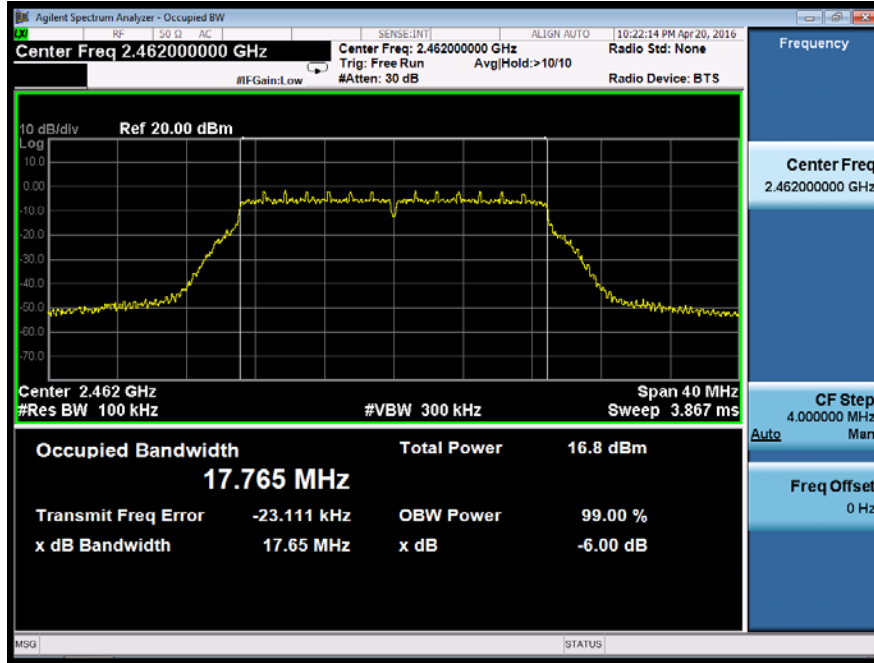

Test Model	DTS (6dB) Bandwidth 802.11n (HT40) Channel 3: 2422MHz
------------	---

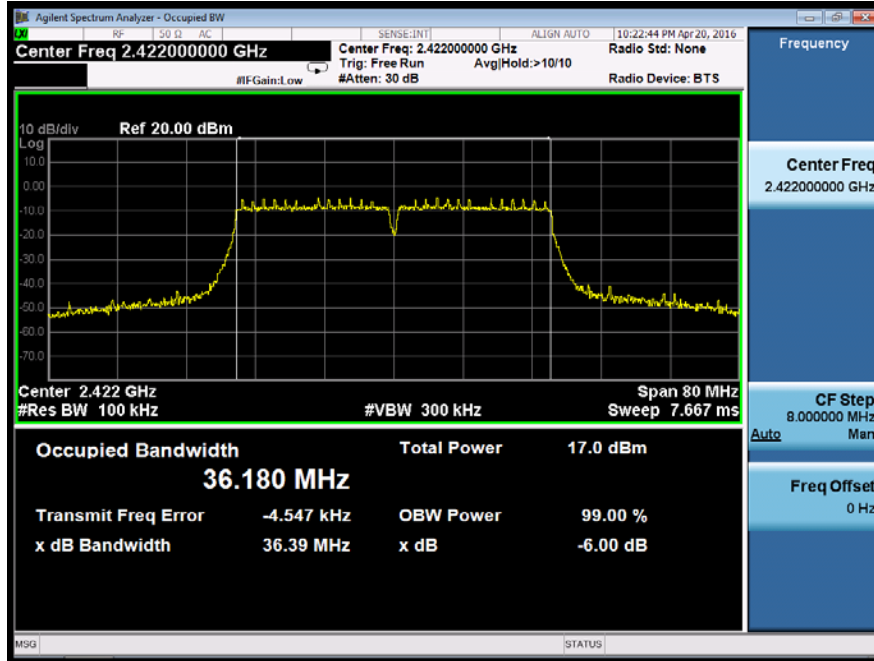

Test Model	DTS (6dB) Bandwidth 802.11n (HT40) Channel 6: 2437MHz
------------	---

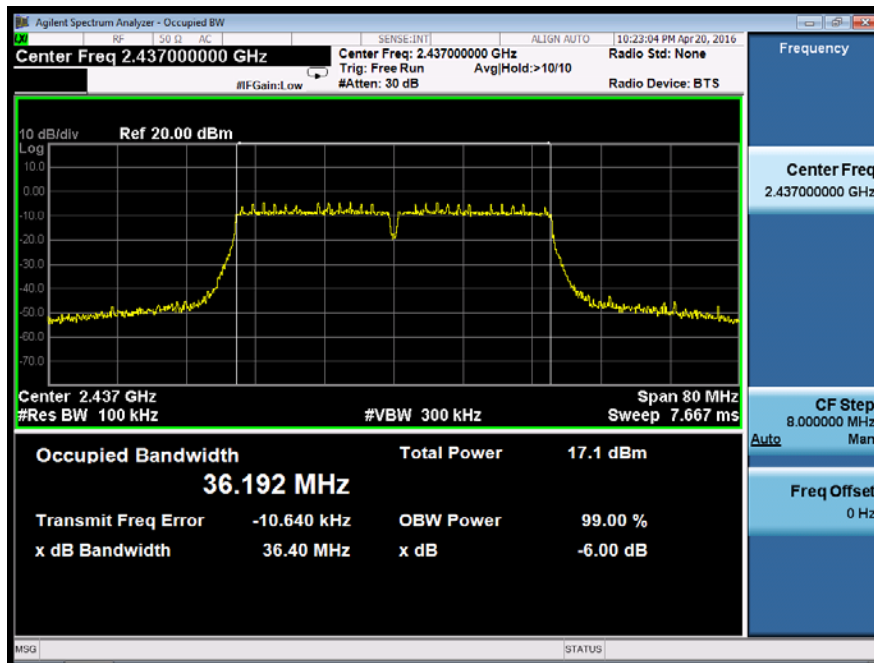

Test Model	DTS (6dB) Bandwidth
	802.11n (HT40)
	Channel 9: 2452MHz

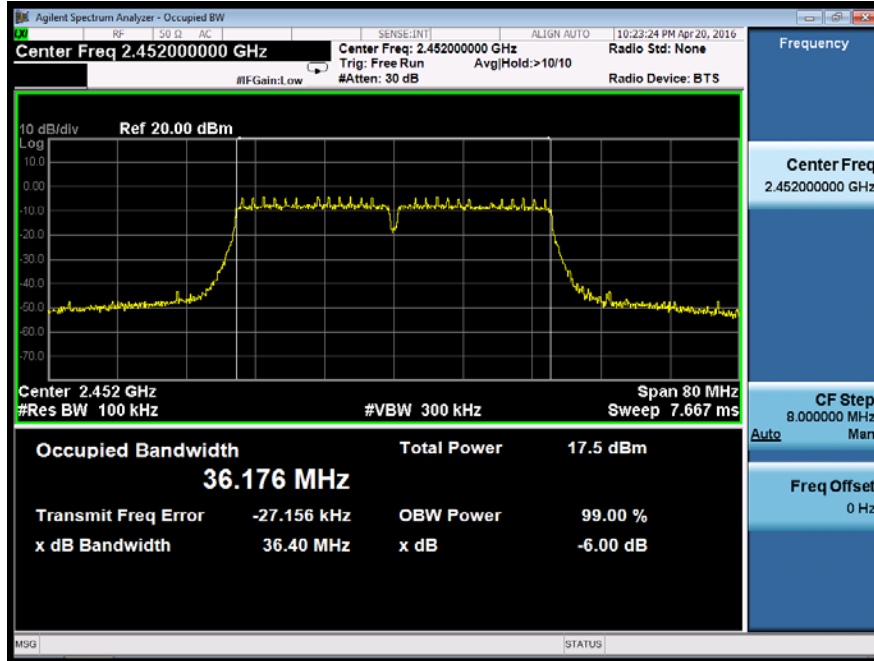

## 8.2 MAXIMUM PEAK CONDUCTED OUTPUT POWER

### 8.2.1 Applicable Standard

According to FCC Part 15.247(b)(3) and KDB 558074 DTS 01 Meas. Guidance v03r05

### 8.2.2 Conformance Limit

The maximum peak conducted output power of the intentional radiator for systems using digital modulation in the 2400 - 2483.5 MHz bands shall not exceed: 1 Watt (30dBm).

### 8.2.3 Test Configuration

Test according to clause 7.1 radio frequency test setup 1

### 8.2.4 Test Procedure

■ According to FCC Part 15.247(b)(3)

The maximum peak conducted output power may be measured using a broadband peak RF power meter. The power meter shall have a video bandwidth that is greater than or equal to the DTS bandwidth and shall utilize a fast-responding diode detector.

The testing follows FCC public Notice DA 00-705 Measurement Guidelines.

The RF output of EUT was connected to the power meter by RF cable and attenuator. The path loss was compensated to the results for each measurement.

Set to the maximum output power setting and enable the EUT transmit continuously.

Measure the conducted output power with cable loss and record the results in the test report.

Measure and record the results in the report.

■ According to FCC Part 15.247(b)(4):

Conducted output power limit specified in paragraph (b) of this section is based on the use of antennas with directional gains that do not exceed 6 dBi. If transmitting antennas of directional gain greater than 6 dBi are used, the conducted output power from the intentional radiator shall be reduced below the stated values in paragraphs (b)(3) of this section, as appropriate, by the amount in dB that the directional gain of the antenna exceeds 6 dBi.

Note: If antenna Gain exceeds 6 dBi, then Output power Limit=30-(Gain - 6)

### 8.2.5 Test Results

Temperature :	28 °C	Test Date :	April 20, 2016
Humidity :	65 %	Test By:	King Kong
Antenna:	A		

Operation Mode	Channel Number	Channel Frequency (MHz)	Measurement Level (dBm)	Limit (dBm)	Verdict
☒802.11b	1	2412	18.23	30	PASS
	6	2437	18.33	30	PASS
	11	2462	18.49	30	PASS
☒802.11g	1	2412	17.69	30	PASS
	6	2437	18.12	30	PASS
	11	2462	18.00	30	PASS
☒802.11n (HT20)	1	2412	17.56	30	PASS
	6	2437	17.84	30	PASS
	11	2462	18.15	30	PASS
☒802.11n (HT40)	3	2422	12.66	30	PASS
	6	2437	12.91	30	PASS
	9	2452	13.32	30	PASS



Temperature :	28°C	Test Date :	April 20, 2016
Humidity :	65 %	Test By:	King Kong
Antenna:	B		

Operation Mode	Channel Number	Channel Frequency (MHz)	Measurement Level (dBm)	Limit (dBm)	Verdict
☒802.11b	1	2412	17.59	30	PASS
	6	2437	17.63	30	PASS
	11	2462	17.88	30	PASS
☒802.11g	1	2412	17.03	30	PASS
	6	2437	17.03	30	PASS
	11	2462	17.40	30	PASS
☒802.11n (HT20)	1	2412	17.01	30	PASS
	6	2437	17.04	30	PASS
	11	2462	17.46	30	PASS
☒802.11n (HT40)	3	2422	12.17	30	PASS
	6	2437	12.41	30	PASS
	9	2452	12.50	30	PASS

Temperature :	28°C	Test Date :	April 20, 2016
Humidity :	65 %	Test By:	King Kong
Antenna:	A+B		

Operation Mode	Channel Number	Channel Frequency (MHz)	Measurement Level (dBm)	Limit (dBm)	Verdict
☒802.11n (HT20)	1	2412	20.30	30	PASS
	6	2437	20.47	30	PASS
	11	2462	20.83	30	PASS
☒802.11n (HT40)	3	2422	15.43	30	PASS
	6	2437	15.68	30	PASS
	9	2452	15.94	30	PASS

Duty Cycle

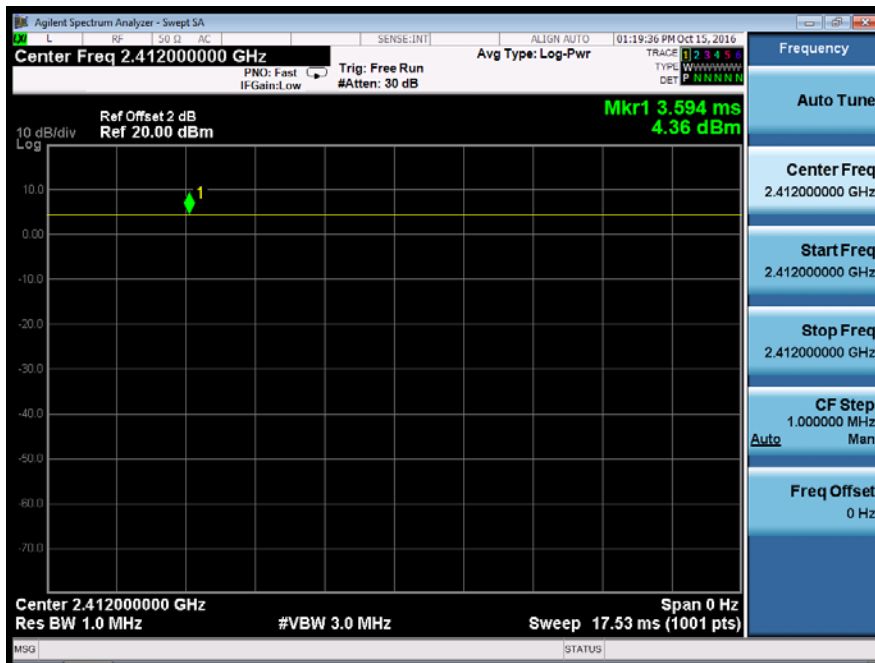
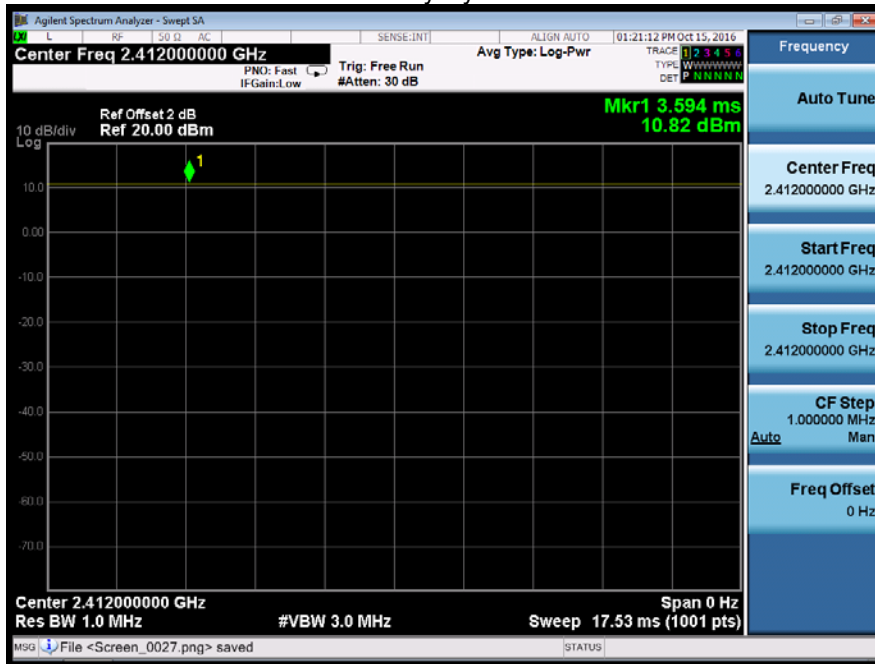

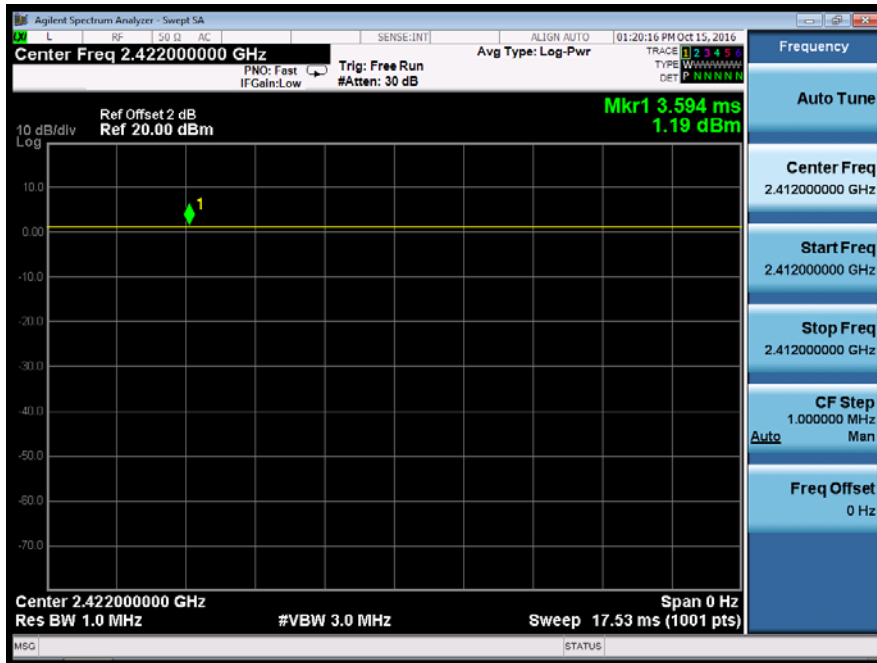
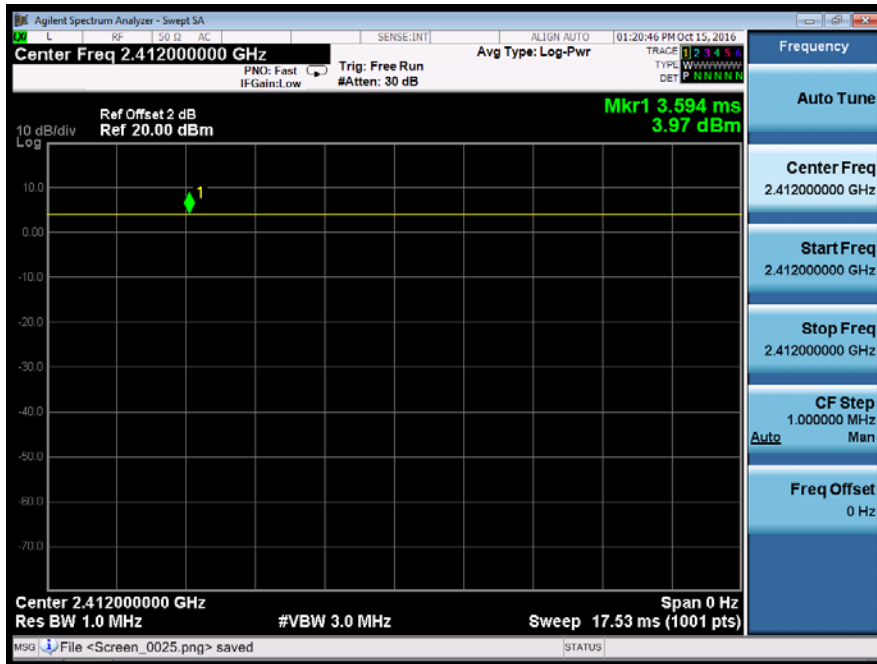

### 8.3 MAXIMUM POWER SPECTRAL DENSITY

#### 8.3.1 Applicable Standard

According to FCC Part 15.247(e) and KDB 558074 DTS 01 Meas. Guidance v03r05

#### 8.3.2 Conformance Limit

The transmitter power spectral density conducted from the transmitter to the antenna shall not be greater than 8 dBm in any 3 kHz band during any time interval of continuous transmission.

#### 8.3.3 Test Configuration

Test according to clause 7.1 radio frequency test setup 1

#### 8.3.4 Test Procedure

This procedure shall be used if maximum peak conducted output power was used to demonstrate compliance

The transmitter output (antenna port) was connected to the spectrum analyzer

Set analyzer center frequency to DTS channel center frequency.

Set the span to 1.5 times the DTS bandwidth.

Set the RBW to: 3 kHz

Set the VBW to: 10 kHz.

Set Detector = peak.

Set Sweep time = auto couple.

Set Trace mode = max hold.

Allow trace to fully stabilize.

Use the peak marker function to determine the maximum amplitude level within the RBW.

Note: If antenna Gain exceeds 6 dBi, then PSD Limit=8-(Gain - 6)

#### 8.3.5 Test Results

Temperature :	28 °C	Test Date :	April 20, 2016
Humidity :	65 %	Test By:	King Kong
Antenna:	A		

Operation Mode	Channel Number	Channel Frequency (MHz)	Measurement Level (dBm/3kHz)	Limit (dBm/3kHz)	Verdict
☒802.11b	1	2412	-12.746	8	PASS
	6	2437	-11.695	8	PASS
	11	2462	-11.528	8	PASS
☒802.11g	1	2412	-15.365	8	PASS
	6	2437	-14.558	8	PASS
	11	2462	-14.194	8	PASS
☒802.11n (HT20)	1	2412	-16.307	8	PASS
	6	2437	-13.962	8	PASS
	11	2462	-15.978	8	PASS
☒802.11n (HT40)	3	2422	-18.746	8	PASS
	6	2437	-17.244	8	PASS
	9	2452	-17.981	8	PASS

Temperature :	28°C	Test Date :	April 23, 2016
Humidity :	65 %	Test By:	King Kong
Antenna:	B		

Operation Mode	Channel Number	Channel Frequency (MHz)	Measurement Level (dBm/3kHz)	Limit (dBm/3kHz)	Verdict
☒802.11b	1	2412	-13.190	8	PASS
	6	2437	-11.564	8	PASS
	11	2462	-13.181	8	PASS
☒802.11g	1	2412	-15.395	8	PASS
	6	2437	-15.361	8	PASS
	11	2462	-15.722	8	PASS
☒802.11n (HT20)	1	2412	-16.262	8	PASS
	6	2437	-14.638	8	PASS
	11	2462	-16.921	8	PASS
☒802.11n (HT40)	3	2422	-18.930	8	PASS
	6	2437	-19.404	8	PASS
	9	2452	-19.399	8	PASS

Temperature :	28°C	Test Date :	April 23, 2016
Humidity :	65 %	Test By:	King Kong
Antenna:	A+B		

Operation Mode	Channel Number	Channel Frequency (MHz)	Measurement Level (dBm/3kHz)	Limit (dBm/3kHz)	Verdict
☒802.11n (HT20)	1	2412	-13.27	8	PASS
	6	2437	-11.28	8	PASS
	11	2462	-13.41	8	PASS
☒802.11n (HT40)	3	2422	-15.83	8	PASS
	6	2437	-15.18	8	PASS
	9	2452	-15.62	8	PASS

For Antenna A

Test Model	Power Spectral Density 802.11b Channel 1: 2412MHz
------------	---

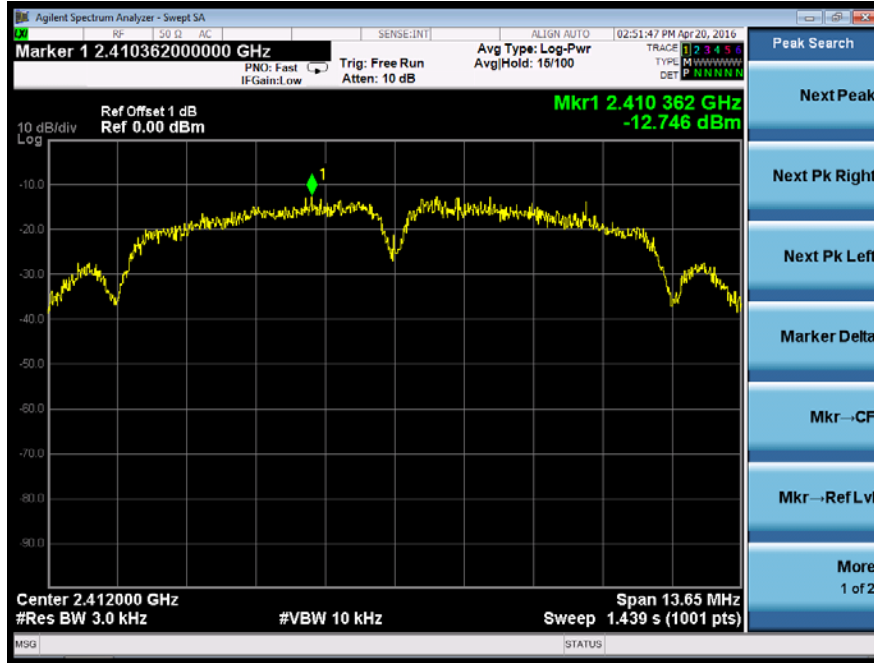

Test Model	Power Spectral Density 802.11b Channel 6: 2437MHz
------------	---

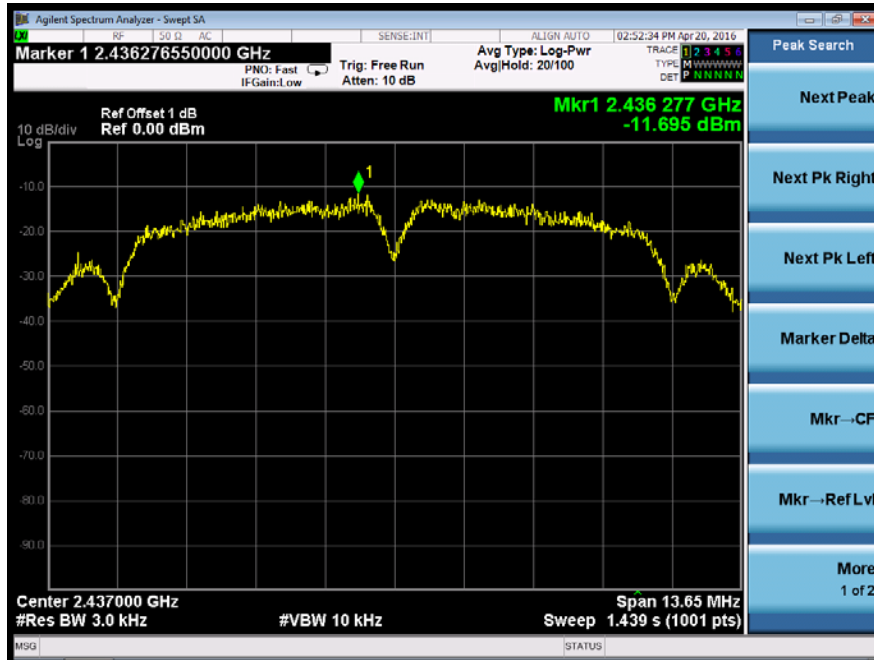

Test Model	Power Spectral Density 802.11b Channel 11: 2462MHz
------------	--

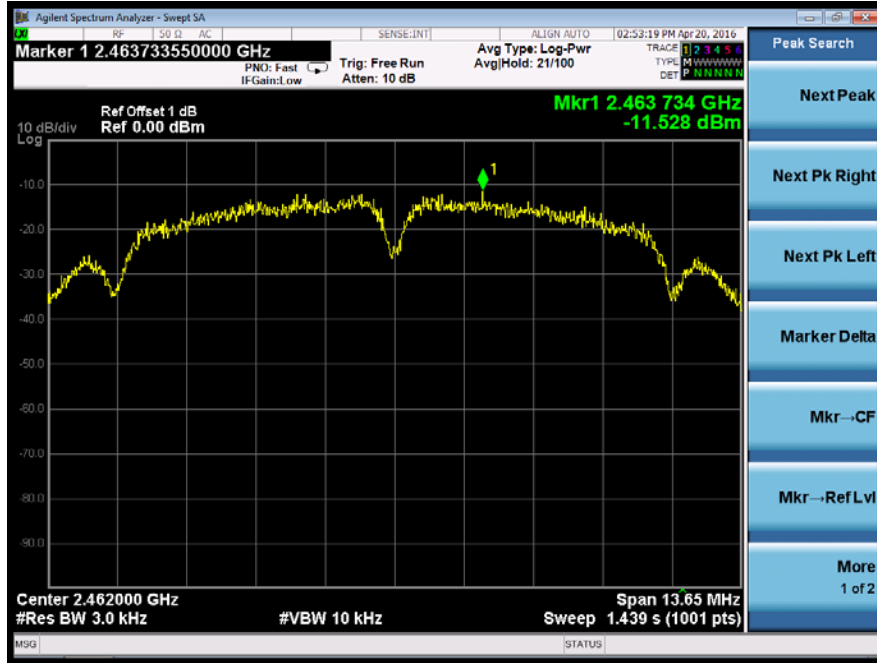

Test Model      Power Spectral Density  
802.11g  
Channel 1: 2412MHz

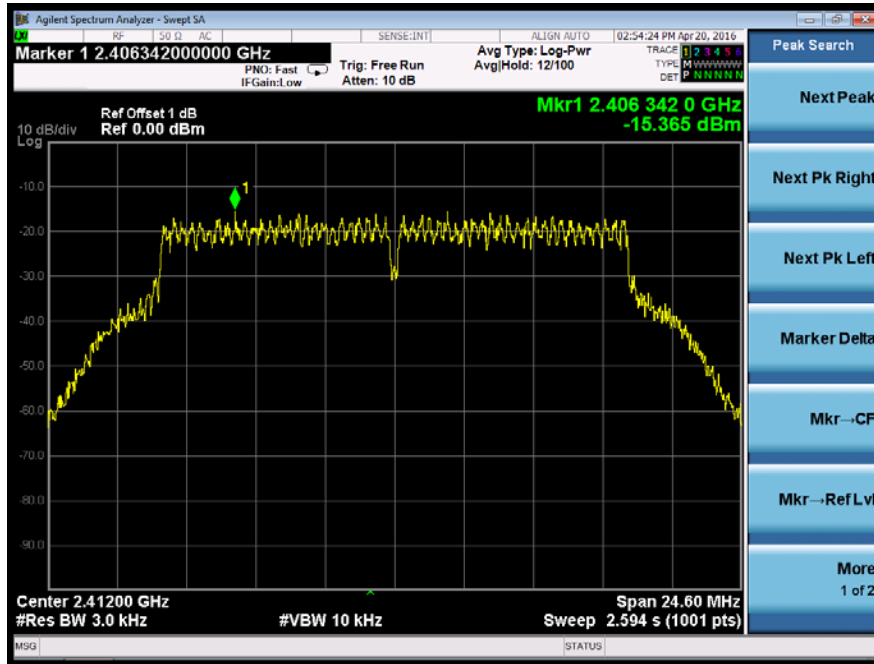

Test Model      Power Spectral Density  
802.11g  
Channel 6: 2437MHz

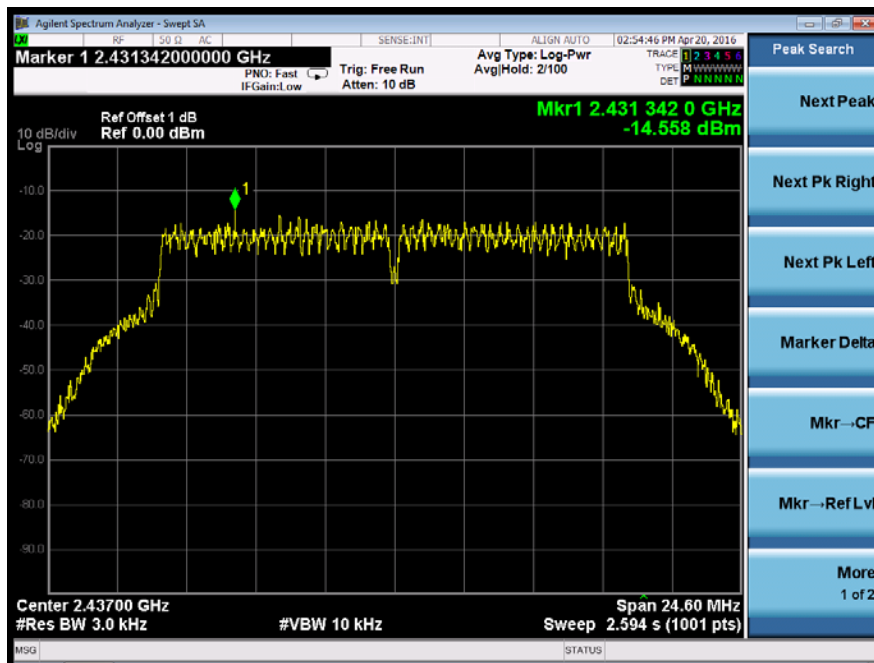



Test Model	Power Spectral Density 802.11g Channel 11: 2462MHz
------------	--

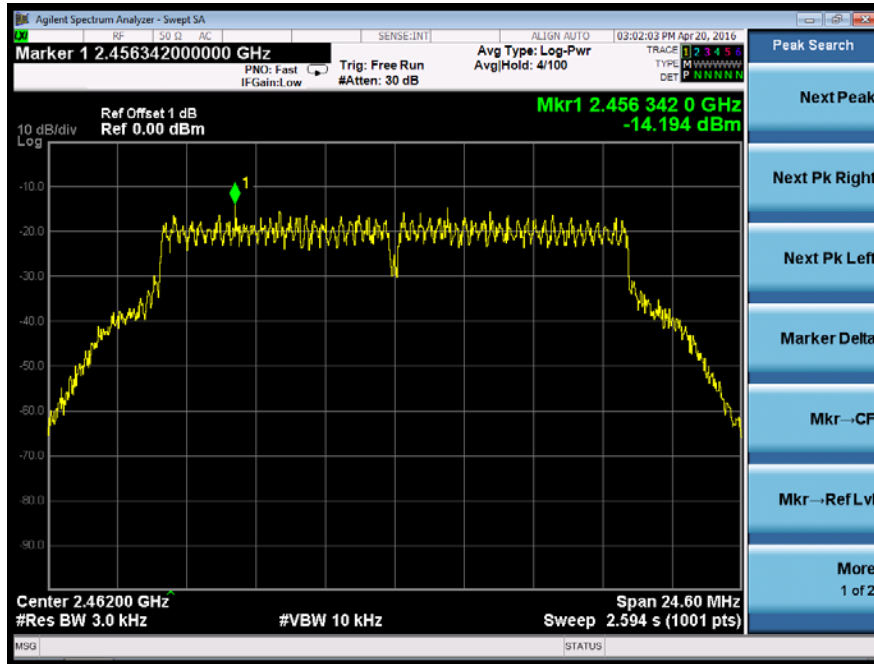

Test Model	Power Spectral Density 802.11n (HT20) Channel 1: 2412MHz
------------	--

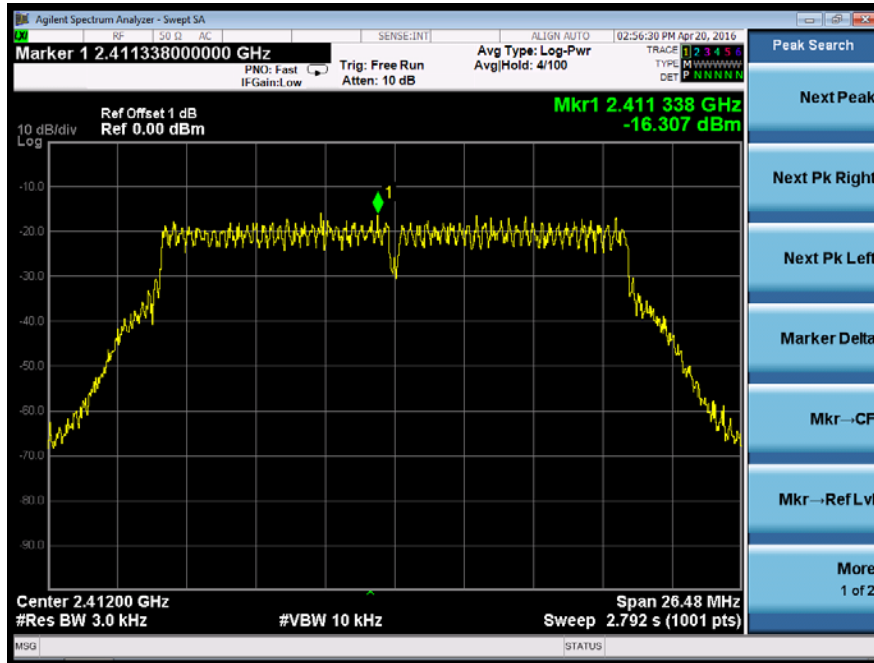

Test Model	Power Spectral Density 802.11n (HT20) Channel 6: 2437MHz
------------	--

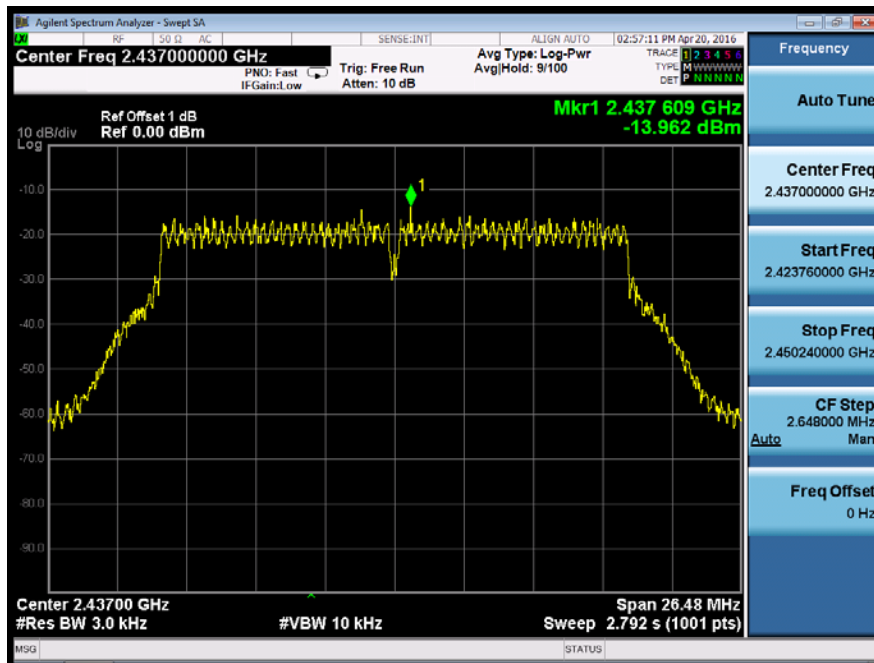

Test Model	Power Spectral Density 802.11n (HT20) Channel 11: 2462MHz
------------	---

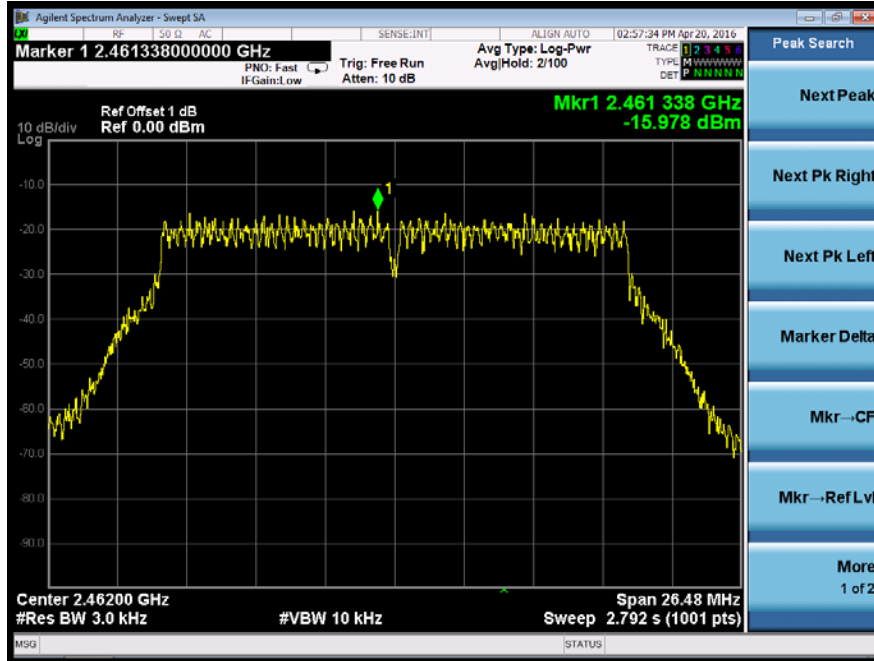

Test Model	Power Spectral Density 802.11n (HT40) Channel 1: 2422MHz
------------	--

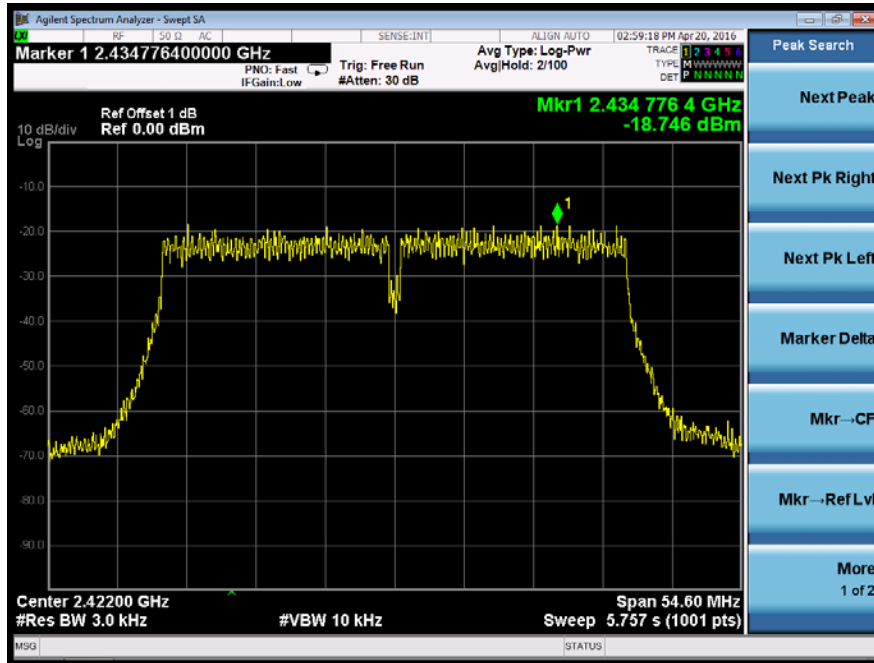

Test Model	Power Spectral Density 802.11n (HT40) Channel 6: 2437MHz
------------	--

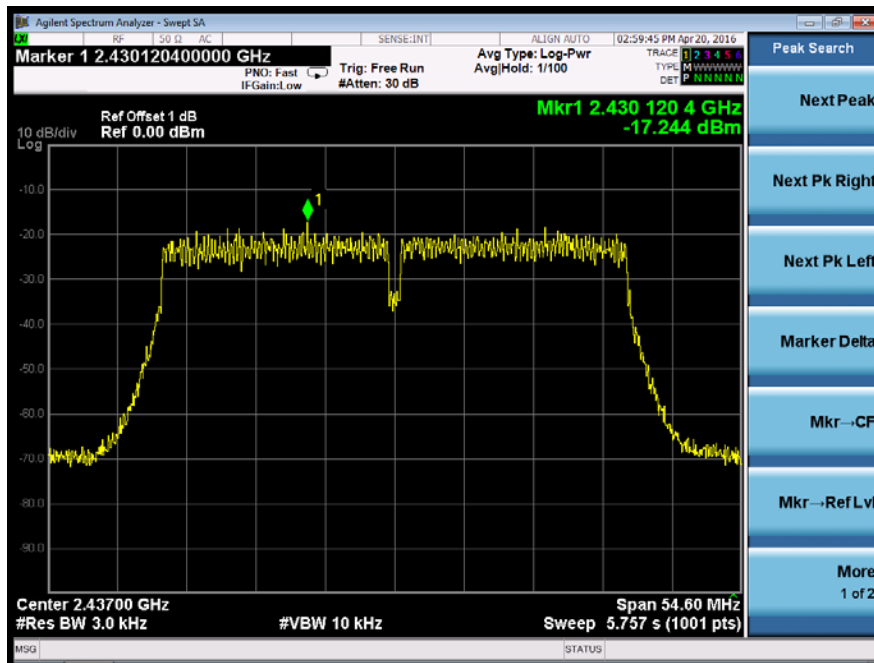

Test Model	Power Spectral Density 802.11n (HT40) Channel 11: 2452MHz
------------	---

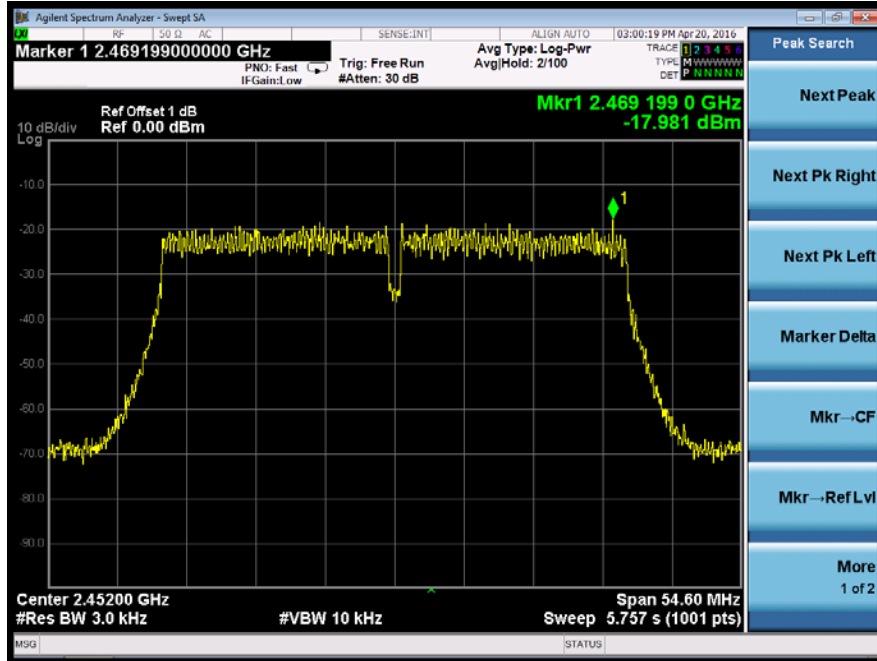

For Antenna B

Test Model	Power Spectral Density 802.11b Channel 1: 2412MHz
------------	---

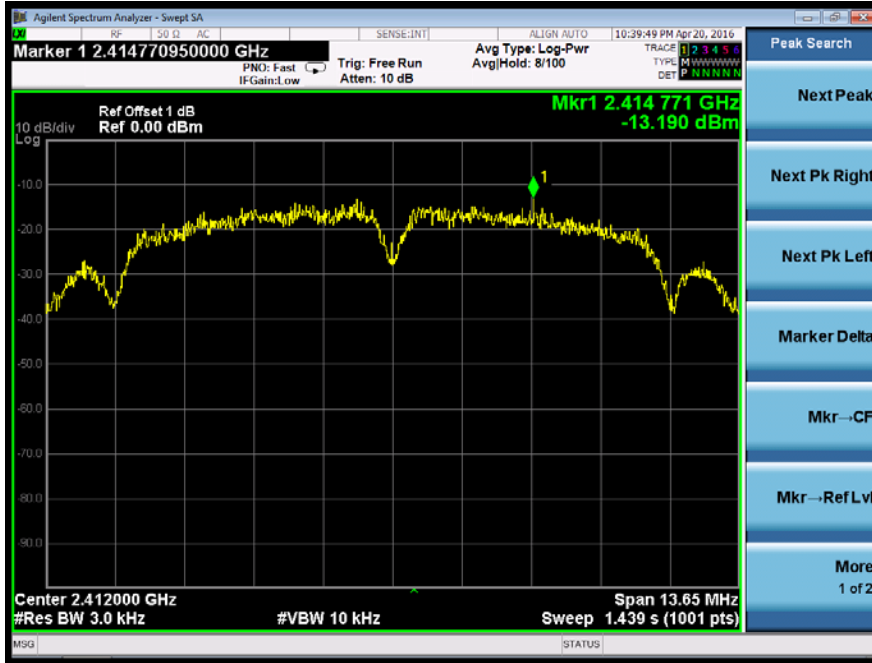

Test Model	Power Spectral Density 802.11b Channel 6: 2437MHz
------------	---



Test Model	Power Spectral Density 802.11b Channel 11: 2462MHz
------------	--



Test Model      Power Spectral Density  
802.11g  
Channel 1: 2412MHz

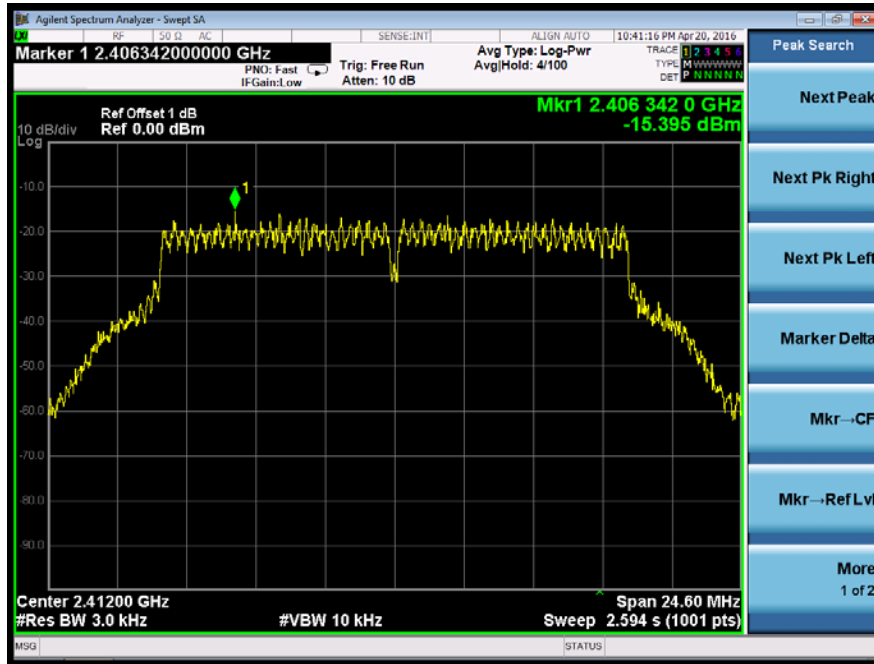

Test Model      Power Spectral Density  
802.11g  
Channel 6: 2437MHz

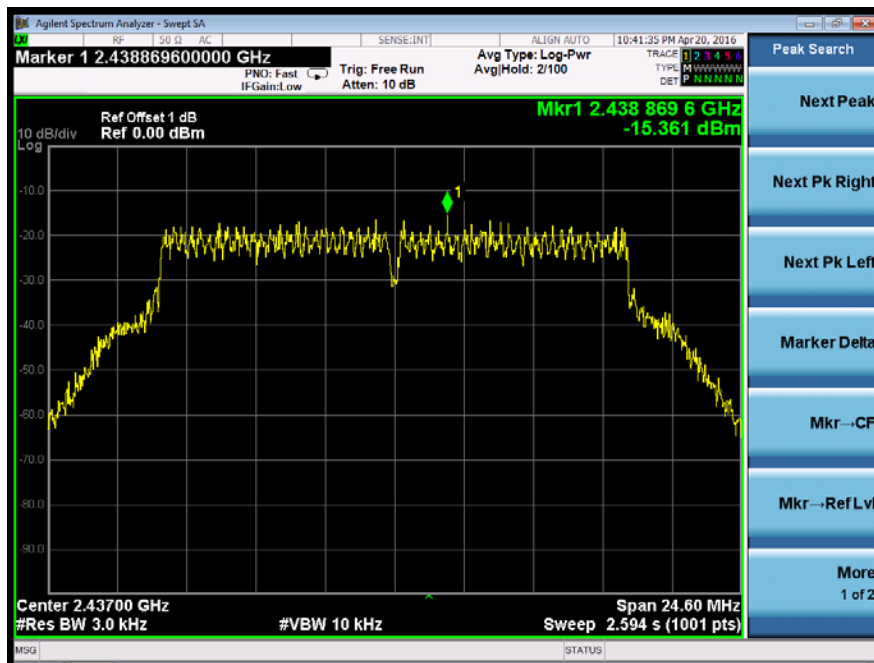



Test Model

Power Spectral Density  
802.11g  
Channel 11: 2462MHz

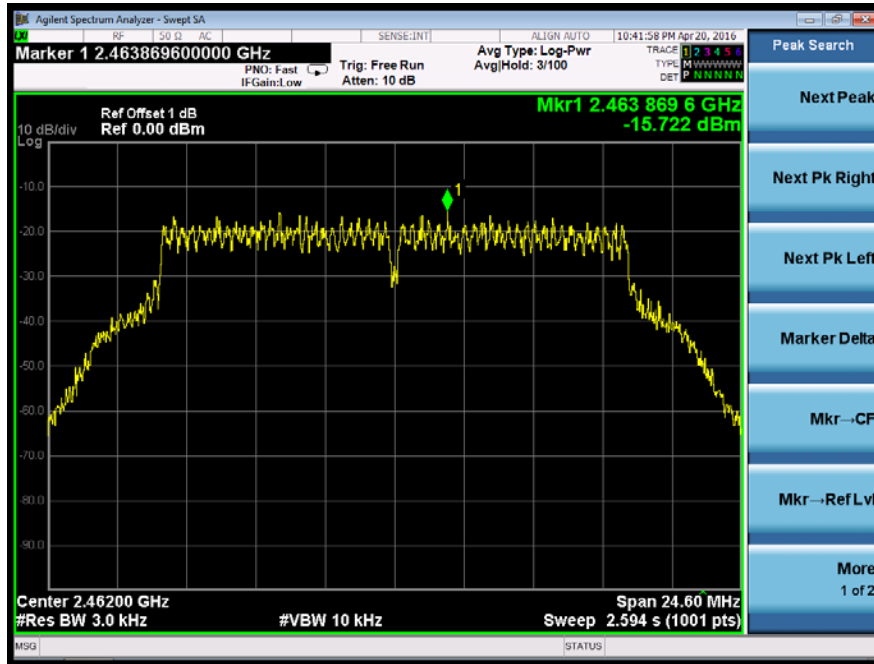

Test Model	Power Spectral Density 802.11n (HT20) Channel 1: 2412MHz
------------	--

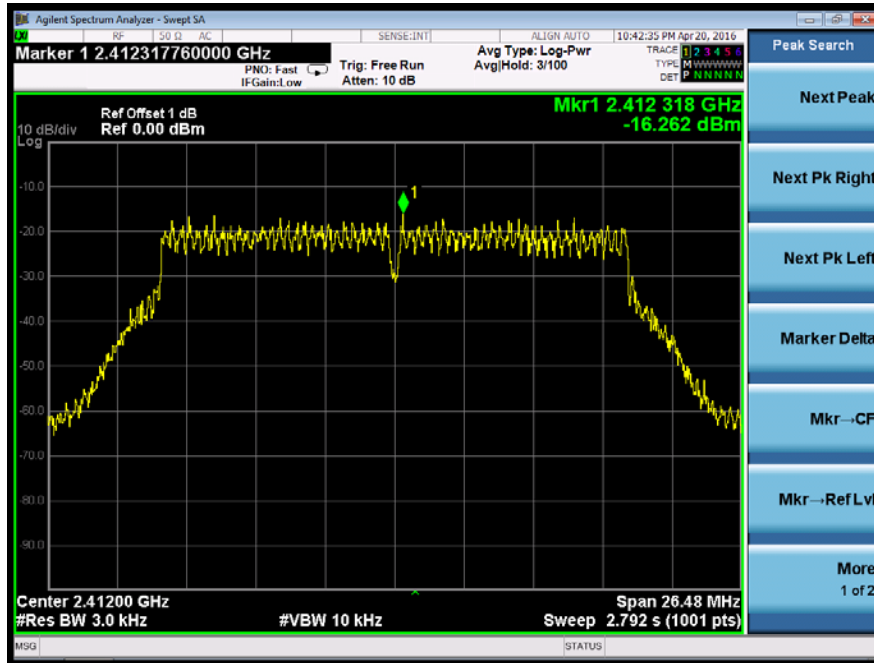

Test Model	Power Spectral Density 802.11n (HT20) Channel 6: 2437MHz
------------	--

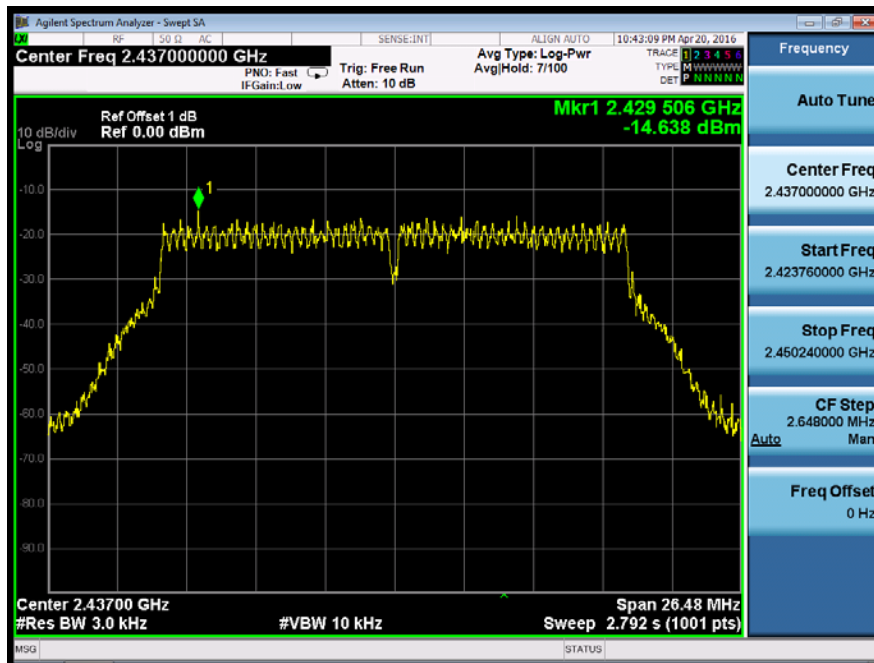

Test Model	Power Spectral Density 802.11n (HT20) Channel 11: 2462MHz
------------	---

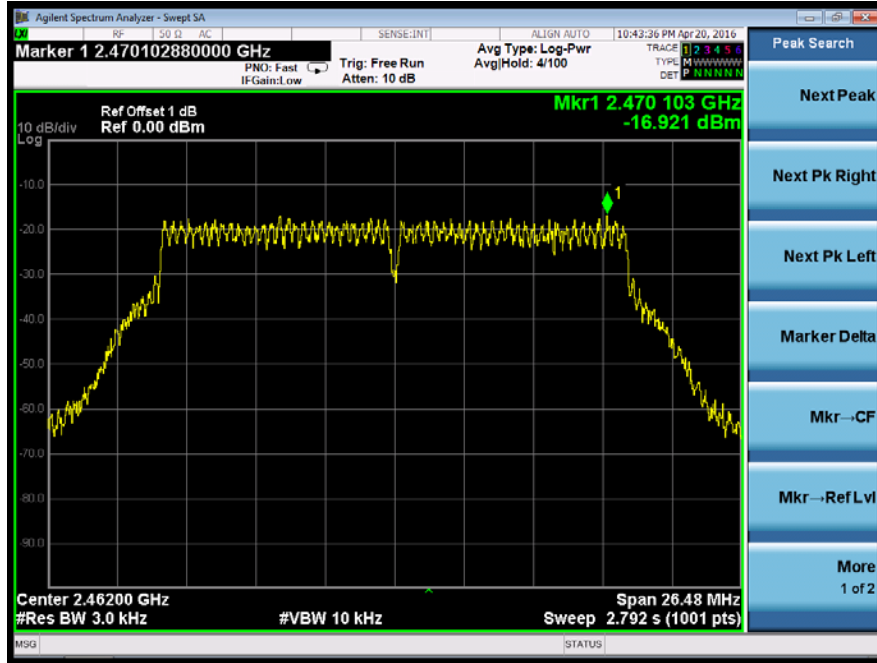

Test Model	Power Spectral Density 802.11n (HT40) Channel 1: 2422MHz
------------	--

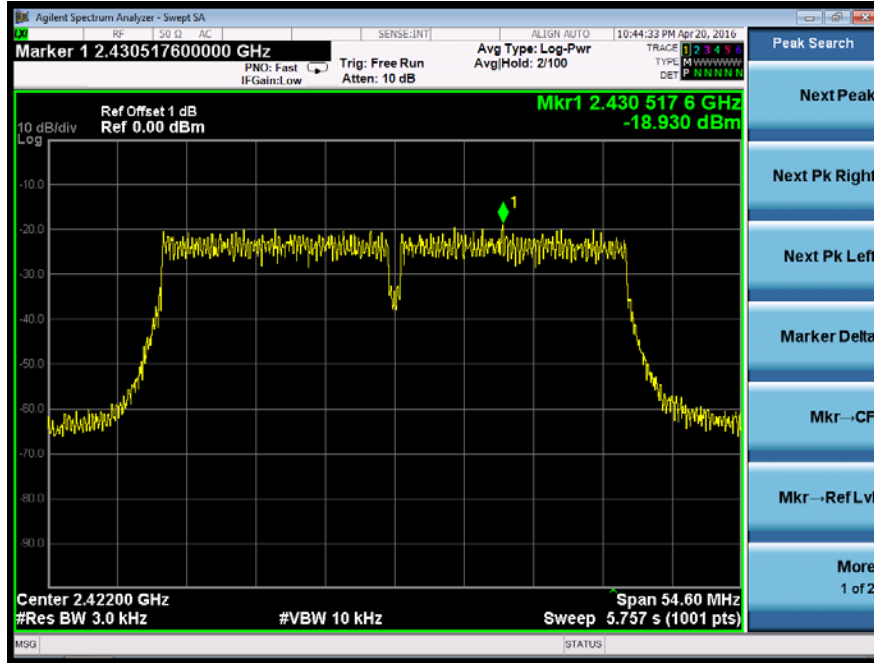

Test Model	Power Spectral Density 802.11n (HT40) Channel 6: 2437MHz
------------	--

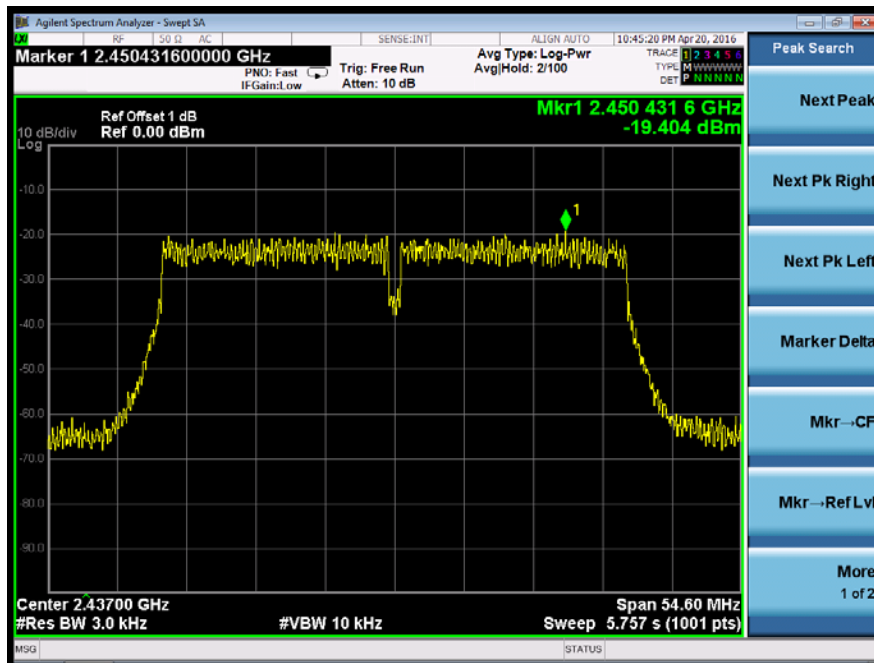

Test Model	Power Spectral Density 802.11n (HT40) Channel 11: 2452MHz
------------	---

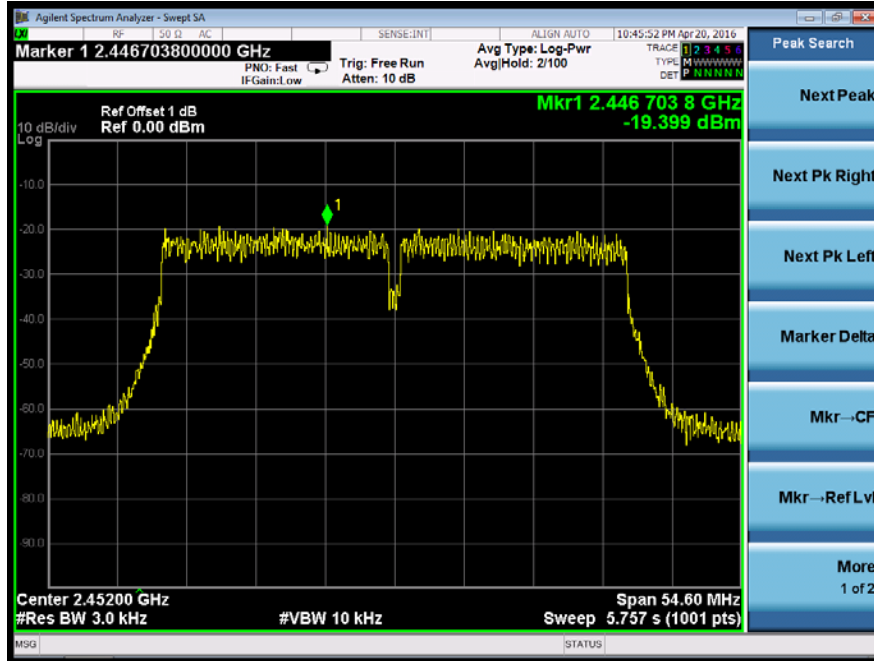

## **8.4 UNWANTED EMISSIONS IN NON-RESTRICTED FREQUENCY BANDS**

### **8.4.1 Applicable Standard**

According to FCC Part 15.247(d) and KDB 558074 DTS 01 Meas. Guidance v03r05

### **8.4.2 Conformance Limit**

According to FCC Part 15.247(d):

In any 100 kHz bandwidth outside the frequency band in which the spread spectrum or digitally modulated intentional radiator is operating, the radio frequency power that is produced by the intentional radiator shall be at least 20 dB below that in the 100 kHz bandwidth within the band that contains the highest level of the desired power, based on either an RF conducted or a radiated measurement, provided the transmitter demonstrates compliance with the peak conducted power limits. If the transmitter complies with the conducted power limits based on the use of RMS averaging over a time interval, as permitted under paragraph (b)(3) of this section, the attenuation required under this paragraph shall be 30 dB instead of 20 dB.

### **8.4.3 Test Configuration**

Test according to clause 7.1 radio frequency test setup 1

### **8.4.4 Test Procedure**

The transmitter output (antenna port) was connected to the spectrum analyzer

#### **■ Reference level measurement**

Establish a reference level by using the following procedure:

Set instrument center frequency to DTS channel center frequency.

Set the span to  $\geq 1.5$  times the DTS bandwidth.

Set the RBW = 100 kHz.

Set the VBW  $\geq 3 \times$  RBW.

Set Detector = peak.

Set Sweep time = auto couple.

Set Trace mode = max hold.

Allow trace to fully stabilize.

Use the peak marker function to determine the maximum PSD level.

Note that the channel found to contain the maximum PSD level can be used to establish the reference level.

#### **■ Emission level measurement**

Set the center frequency and span to encompass frequency range to be measured.

Set the RBW = 100 kHz.

Set the VBW = 300 kHz.

Set Detector = peak

Sweep time = auto couple.

Trace mode = max hold.

Allow trace to fully stabilize.

Use the peak marker function to determine the maximum amplitude level.

Ensure that the amplitude of all unwanted emissions outside of the authorized frequency band (excluding restricted frequency bands) are attenuated by at least the minimum requirements. Report the three highest emissions relative to the limit.

### **8.4.5 Test Results**

All modes 2.4G 802.11b/g/n have been tested, and the worst result 802.11g recorded was report as below: