



Spectrum Research & Testing Lab., Inc.
No. 101-10, Ling 8,
Shan-Tong Li, Chung-Li
City, Taoyuan, Taiwan

TEST REPORT

Reference No.: A10082002
Report No.: FCCA10082002
FCC ID : VYTLP-9181A
Page:1 of 82
Date: Aug. 25, 2010

Product Name: 802.11b/g/n Indoor Signal Booster 1000mW
Model No.: LP-9181A
Applicant: Loopcomm Technology, Ltd.
1F, No. 114, Lian-Chen Rd., Chung-Ho City,
Taipei Hsien, Taiwan R.O.C.
Brand LOOPCOMM
Date of Receipt: Aug. 02, 2010
Finished date of Test: Aug. 23, 2010
Applicable Standards: 47 CFR Part 15, Subpart C
ANSI C63.4: 2003

We, **Spectrum Research & Testing Laboratory Inc.**, hereby certify that one sample of the above was tested in our laboratory with positive results according to the above-mentioned standards. The records in the report are an accurate account of the results. Details of the results are given in the subsequent pages of this report.

Tested By : Shunm Wang , Date: Aug. 25, 2010
(Shunm Wang)

Approved By : J. Ho , Date: Aug. 25, 2010
(Johnson Ho, Director)

NVLAQ[®]

Lab Code: 200099-0
FMNG-059.10 REPORT



Table of Contents

1.	DOCUMENT POLICY AND TEST STATEMENT	4
1.1	DOCUMENT POLICY	4
1.2	TEST STATEMENT	4
1.3	EUT MODIFICATION	4
2.	DESCRIPTION OF EUT AND TEST MODE	5
2.1	GENERAL DESCRIPTION OF EUT	5
2.2	DESCRIPTION OF EUT INTERNAL DEVICE	5
2.3	DESCRIPTION OF TEST MODE	6
2.4	DESCRIPTION OF SUPPORT UNIT	6
2.5	EUT OPERATING CONDITION	7
3.	DESCRIPTION OF APPLIED STANDARDS	7
4.	TECHNICAL CHARACTERISTICS TEST	8
4.1	CONDUCTED EMISSION TEST	8
4.1.1	LIMIT	8
4.1.2	TEST EQUIPMENT	8
4.1.3	TEST SETUP	9
4.1.4	TEST PROCEDURE	9
4.1.5	TEST RESULT	10
4.2	RADIATED EMISSION TEST	15
4.2.1	LIMIT	15
4.2.2	TEST EQUIPMENT	16
4.2.3	TEST SET-UP	17
4.2.4	TEST PROCEDURE	19
4.2.5	TEST RESULT	20
4.3	BANDWIDTH TEST	38
4.3.1	LIMIT	38
4.3.2	TEST EQUIPMENT	38
4.3.3	TEST SET-UP	38
4.3.4	TEST PROCEDURE	38
4.3.5	EUT OPERATING CONDITION	38
4.3.6	TEST RESULT	39
4.4	POWER SPECTRUM TEST	47
4.4.2	TEST EQUIPMENT	47
4.4.3	TEST SET-UP	48
4.4.4	TEST PROCEDURE	48
4.4.5	EUT OPERATING CONDITION	48
4.4.6	TEST RESULT	49
4.5	BAND EDGE TEST	57
4.5.1	LIMIT	57
4.5.2	TEST EQUIPMENT	58
4.5.3	TEST SET-UP	59
4.5.4	TEST PROCEDURE	60
4.5.5	EUT OPERATING CONDITION	60
4.5.6	TEST RESULT	61
4.6	POWER DENSITY TEST	69
4.6.1	LIMIT	69



Spectrum Research & Testing Lab., Inc.
No. 101-10, Ling 8,
Shan-Tong Li, Chung-Li
City, Taoyuan, Taiwan

TEST REPORT

Reference No.: A10082002
Report No.: FCCA10082002
FCC ID : VYTLP-9181A
Page: 3 of 82
Date: Aug. 25, 2010

4.6.2	TEST EQUIPMENT	69
4.6.3	TEST SET-UP	69
4.6.4	TEST PROCEDURE	69
4.6.5	EUT OPERATING CONDITION	69
4.6.6	TEST RESULT	70
5.	ANTENNA APPLICATION	78
5.1	ANTENNA REQUIREMENT	78
5.2	RESULT	78
6.	PHOTOS OF TESTING	79
7.	TERMS OF ABBREVIATION	82



Spectrum Research & Testing Lab., Inc.
No. 101-10, Ling 8,
Shan-Tong Li, Chung-Li
City, Taoyuan, Taiwan

TEST REPORT

Reference No.: A10082002
Report No.: FCCA10082002
FCC ID : VYTLP-9181A
Page: 4 of 82
Date: Aug. 25, 2010

1. DOCUMENT POLICY AND TEST STATEMENT

1.1 DOCUMENT POLICY

- The report shall not be reproduced except in full, without the written approval of SRT Lab, Inc.
- The report must not be used by the client to claim product certification, approval, or endorsement by NVLAP, NIST, or any agency of the Federal Government.

1.2 TEST STATEMENT

- The test results in the report apply only to the unit tested by SRT Lab.
- There was no deviation from the requirements of test standards during the test.
- AC power source, 120 Vac/60 Hz, was used during the test.

1.3 EUT MODIFICATION

- No modification in SRT Lab.



2. DESCRIPTION OF EUT AND TEST MODE

2.1 GENERAL DESCRIPTION OF EUT

PRODUCT	802.11b/g/n Indoor Signal Booster 1000mW
MODEL NO.	LP-9181A
POWER SUPPLY	DC power source from an external adapter Brand Name : DVE Model No.:DSC-6PFA-05 FUS Input:100-240V 0.2A 50-60Hz Output : 5V 1A
CABLE	1.5m unshielded DC power cable. 1.2m shielded data cable.
FREQUENCY BAND	2.4000~2.4835 GHz
CARRIER FREQUENCY	2.412GHz ~ 2.472GHz ; 2.422GHz ~ 2.452GHz
NUMBER OF CHANNEL	b/g/n(20M):11 ; n(40M):7
CHANNEL SPACING	5MHz
DUTY CYCLE	100%
RATED RF OUTPUT POWER	11b : 0.4027W ; 11g : 0.3917W 11n(20M):0.3732W ; 11n(40M):0.2600W
MODULATION TYPE	IEEE802.11b : DSSS ; IEEE802.11g/n : OFDM
BIT RATE OF TRANSMISSION	11b: 1, 2, 5.5, 11Mbps 11g: 6, 9, 12, 18, 24, 36, 48, 54Mbps 11n(20M) : up to 130Mbps 11n(40M) : up to 300Mbps
MODE OF OPERATION	half duplex
ANTENNA TYPE	Reverse SMA Dipole
ANTENNA GAIN	9 dBi
OPERATING TEMPERATURE RANGE	-20-70 °C
CHANNEL BANDWIDTH	20MHZ

NOTE :

1. For more detailed information, please refer to the EUT's specification or user's manual provided by manufacturer.

2.2 DESCRIPTION OF EUT INTERNAL DEVICE

DEVICE	BRAND / MAKER	MODEL #	FCC ID / DOC	REMARK
NA				



2.3 DESCRIPTION OF TEST MODE

11 channels are provided by EUT of wireless. The 3 channels of lower, medium and higher were chosen for test.

There are test modes for each test configuration as below:

Mode		Modulation Type	Channel		Frequency (MHz)	
1	IEEE 802.11b	CCK	CH01		2412	
2		DQPSK	CH06		2437	
3		DBPSK	CH11		2462	
4	IEEE 802.11g	OFDM	CH01		2412	
5			CH06		2437	
6			CH11		2462	
			20MHz	40MHz	20MHz	40MHz
7	IEEE 802.11n	OFDM	CH01	CH01	2412	2422
8			CH06	CH04	2437	2437
9			CH11	CH07	2462	2452
10	Standby	N/A	N/A		N/A	

NOTE :

- Below 1 GHz, the channel 1, 6 and 11 were pre-tested in chamber. The channel 1, worst case one, was chosen for conducted and radiated emission test.
- Above 1 GHz, the channel 1, 6 and 11 were tested individually.

2.4 DESCRIPTION OF SUPPORT UNIT

The EUT was configured by the requirement of ANSI C63.4:2003. All interface ports were connected to the appropriate support units via specific cables. The support units and cables are listed below.

NO	DEVICE	BRAND	MODEL #	FCC ID/DOC	CABLE
1	NOTEBOOK	DELL	PP21L	DOC	1.8m unshielded power cable.
2	Dual Band USB Adapter	D-Link	DWA-160	KA2WA160A1	NA
3	802.11n Wireless AP Router (1T1R)	LOOPCOMM	LP-8616	VYTLP-8616	1.2m unshielded power cord with AC/DC adapter

NOTE : For the actual test configuration, please refer to the photos of testing.



2.5 EUT OPERATING CONDITION

1. Setup the EUT and all peripheral devices.
2. Turn on the power of all equipment and EUT.
3. We will use the following programs under Windows Home server system to test EUT.
 - 3.1 "EMI test" program
PC sent "H" pattern signal and detect following peripherals directly or via EUT:
LCD Monitor, HDD
 - 3.2 "MP_TEST" program
Set the EUT under continuous transmission condition.
4. The support unit of test is 802.11n Wireless AP Router and FCC ID is VYTLP-8616, we proposal the end-user must use this AP router to companion Signal Booster.

3. DESCRIPTION OF APPLIED STANDARDS

The EUT is a wireless product. According to the specifications provided by the applicant, it must comply with the requirements of the following standards:

47 CFR Part 15, Subpart C
ANSI C63.4: 2003

All tests have been performed and recorded as the above standards.



4. TECHNICAL CHARACTERISTICS TEST

4.1 CONDUCTED EMISSION TEST

4.1.1 LIMIT

Frequency (MHz)	Class A (dB μ V)		Class B (dB μ V)	
	Quasi-peak	Average	Quasi-peak	Average
0.15 - 0.5	79	66	66 - 56	56 - 46
0.50 - 5.0	73	60	56	46
5.0 - 30.0	73	60	60	50

NOTE :

1. The lower limit shall apply at the transition frequencies.
2. The limit decreases in line with the logarithm of the frequency in the range of 0.15 to 0.50 MHz.

4.1.2 TEST EQUIPMENT

The following test equipment was used for the test:

EQUIPMENT/ FACILITIES	SPECIFICATIONS	MANUFACTURER	MODEL#/ SERIAL#	DUE DATE OF CAL. & CAL. CENTER
EMI TEST RECEIVER	9kHz TO 2.75 GHz	ROHDE & SCHWARZ	ESHS30 / 826003/008	SEP.2010 ETC
LISN	50 μ H, 50 ohm	FCC	FCC-LISN-50-25-2 / 01017	NOV. 2010 ETC
LISN	50 μ H, 50 ohm	SOLAR	9252-50-R24-BNC / 951315	NOV. 2010 ETC
50 OHM TERMINATOR	50 ohm	HP	11593A / #2	MAY. 2011 ETC
COAXIAL CABLE	5M	TIMES	RG214/U / #5M(L1TCAB013)	MAY. 2011 ETC
Filter	2 LINE, 30A	FIL.COIL	FC-943 / 771	NCR
GROUND PLANE	2M (H) x 3M (W)	SRT	N/A	NCR
GROUND PLANE	2.5M (H) x 3M (W)	SRT	N/A	NCR

NOTE: The calibration interval of the above test equipment is one year and the calibrations are traceable to NML/ROC and NIST/USA.



4.1.3 TEST SETUP

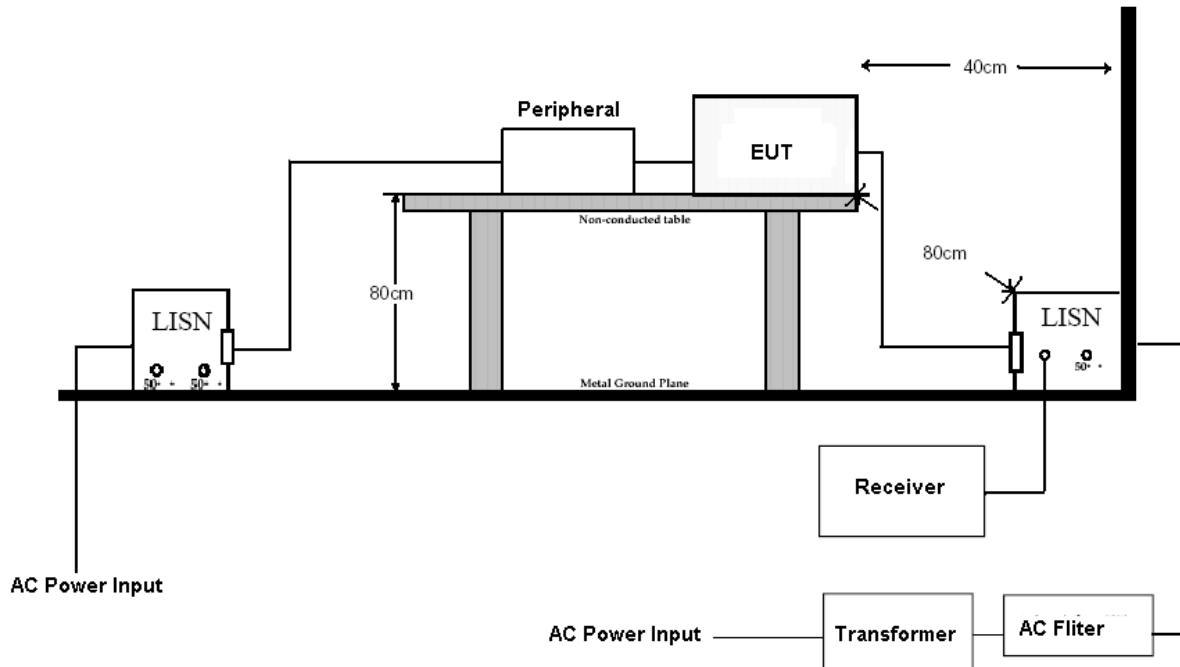

NOTE :

1. The EUT was put on a wooden table with 0.8m heights above ground plane, and 0.4m away from reference ground plane (> 2mx2m).
2. For the actual test configuration, please refer to the photos of testing.

4.1.4 TEST PROCEDURE

The EUT was tested according to the requirement of ANSI C63.4:2003 and CISPR22:2003. The frequency spectrum from 0.15 MHz to 30 MHz was investigated. The LISN used was 50 ohm/50 μ H as specified. All readings were quasi-peak and average values with 10 kHz resolution bandwidth of the test receiver. The EUT system was operated in all typical methods by users. Both lines of the power mains of EUT were measured and the cables connected to EUT and support units were moved to find the maximum emission levels for each frequency. First, find the margin or higher points at least 6 points by software, then use manual to find the maximum data. The procedure is referred on the test procedure of SRT LAB.



4.1.5 TEST RESULT

Temperature:	26 °C	Humidity:	53 %RH
Frequency Range:	0.15 – 30 MHz	Tested Mode:	802.11 b
Receiver Detector:	Q.P. and AV.	Modulation Type:	DSSS
Tested Channel:	CH 01	Tested Date:	Aug. 20, 2010

Power Line Measured : Line

Freq. (MHz)	Correct. Factor (dB)	Reading Value (dB μ V)		Emission Level (dB μ V)		Limit (dB μ V)		Margin (dB)	
		Q.P.	AV.	Q.P.	AV.	Q.P.	AV.	Q.P.	AV.
0.429	0.20	41.59	29.97	41.79	30.17	57.27	47.27	-15.48	-17.10
0.474	0.20	39.04	24.48	39.24	24.68	56.45	46.45	-17.21	-21.77
0.581	0.20	40.16	25.28	40.36	25.48	56.00	46.00	-15.64	-20.52
4.002	0.19	40.01	30.75	40.20	30.94	56.00	46.00	-15.80	-15.06
8.684	0.22	39.28	24.53	39.50	24.75	60.00	50.00	-20.50	-25.25
15.307	0.29	36.35	24.03	36.64	24.32	60.00	50.00	-23.36	-25.68

Power Line Measured : Neutral

Freq. (MHz)	Correct. Factor (dB)	Reading Value (dB μ V)		Emission Level (dB μ V)		Limit (dB μ V)		Margin (dB)	
		Q.P.	AV.	Q.P.	AV.	Q.P.	AV.	Q.P.	AV.
0.480	0.23	32.81	17.24	33.04	17.47	56.34	46.34	-23.30	-28.87
0.581	0.23	34.10	18.52	34.33	18.75	56.00	46.00	-21.68	-27.26
4.130	0.22	34.98	18.99	35.20	19.21	56.00	46.00	-20.80	-26.79
4.358	0.22	35.71	18.81	35.93	19.03	56.00	46.00	-20.07	-26.97
8.542	0.25	36.52	19.78	36.77	20.03	60.00	50.00	-23.23	-29.97
8.776	0.25	34.80	20.27	35.05	20.52	60.00	50.00	-24.95	-29.48

NOTE :

1. Measurement uncertainty is +/- 2dB
2. Emission level = Reading value + Correction factor
3. Correction Factor = Cable loss + Insertion loss of LISN
4. Margin value = Emission level - Limit
5. The emission of other frequencies was very low against the limit.
6. "-": The Quasi-peak reading value also meets average limit and measurement with the average detector is unnecessary.



TEST REPORT

Temperature:	26 °C	Humidity:	53 %RH
Frequency Range:	0.15 – 30 MHz	Tested Mode:	802.11g
Receiver Detector:	Q.P. and AV.	Modulation Type:	OFDM
Tested Channel:	CH 01	Tested Date:	Aug. 20, 2010

Power Line Measured : Line

Freq. (MHz)	Correct. Factor (dB)	Reading Value (dB μ V)		Emission Level (dB μ V)		Limit (dB μ V)		Margin (dB)	
		Q.P.	AV.	Q.P.	AV.	Q.P.	AV.	Q.P.	AV.
0.465	0.20	40.26	29.69	40.46	29.89	56.61	46.61	-16.15	-16.72
0.480	0.20	41.31	25.62	41.51	25.82	56.34	46.34	-14.83	-20.52
0.581	0.20	40.52	29.08	40.72	29.28	56.00	46.00	-15.28	-16.72
8.552	0.22	40.47	25.43	40.69	25.65	60.00	50.00	-19.31	-24.35
13.607	0.27	39.95	25.01	40.22	25.28	60.00	50.00	-19.78	-24.72
18.157	0.37	38.95	23.40	39.32	23.77	60.00	50.00	-20.68	-26.23

Power Line Measured : Neutral

Freq. (MHz)	Correct. Factor (dB)	Reading Value (dB μ V)		Emission Level (dB μ V)		Limit (dB μ V)		Margin (dB)	
		Q.P.	AV.	Q.P.	AV.	Q.P.	AV.	Q.P.	AV.
0.468	0.23	36.69	24.10	36.92	24.33	56.55	46.55	-19.63	-22.22
0.581	0.23	36.91	22.68	37.14	22.91	56.00	46.00	-18.87	-23.10
4.012	0.22	36.42	20.16	36.64	20.38	56.00	46.00	-19.36	-25.62
8.837	0.25	35.98	21.28	36.23	21.53	60.00	50.00	-23.77	-28.47
13.709	0.30	36.59	20.46	36.89	20.76	60.00	50.00	-23.11	-29.24
16.250	0.36	35.35	23.39	35.71	23.75	60.00	50.00	-24.29	-26.25

NOTE :

1. Measurement uncertainty is +/- 2dB
2. Emission level = Reading value + Correction factor
3. Correction Factor = Cable loss + Insertion loss of LISN
4. Margin value = Emission level - Limit
5. The emission of other frequencies was very low against the limit.
6. "-": The Quasi-peak reading value also meets average limit and measurement with the average detector is unnecessary.



TEST REPORT

Temperature:	26 °C	Humidity:	53 %RH
Frequency Range:	0.15 – 30 MHz	Tested Mode:	802.11n (20MHz)
Receiver Detector:	Q.P. and AV.	Modulation Type:	OFDM
Tested Channel:	CH 01	Tested Date:	Aug. 20, 2010

Power Line Measured : Line

Freq. (MHz)	Correct. Factor (dB)	Reading Value (dB μ V)		Emission Level (dB μ V)		Limit (dB μ V)		Margin (dB)	
		Q.P.	AV.	Q.P.	AV.	Q.P.	AV.	Q.P.	AV.
0.411	0.20	42.39	32.80	42.59	33.00	57.63	47.63	-15.04	-14.63
0.471	0.20	40.52	28.47	40.72	28.67	56.50	46.50	-15.78	-17.83
0.586	0.20	41.13	29.30	41.33	29.50	56.00	46.00	-14.67	-16.50
13.627	0.27	41.37	24.16	41.64	24.43	60.00	50.00	-18.36	-25.57
13.688	0.27	40.40	23.97	40.67	24.24	60.00	50.00	-19.33	-25.76
17.757	0.36	40.64	25.72	41.00	26.08	60.00	50.00	-19.00	-23.92

Power Line Measured : Neutral

Freq. (MHz)	Correct. Factor (dB)	Reading Value (dB μ V)		Emission Level (dB μ V)		Limit (dB μ V)		Margin (dB)	
		Q.P.	AV.	Q.P.	AV.	Q.P.	AV.	Q.P.	AV.
0.420	0.23	37.99	19.94	38.22	20.17	57.45	47.45	-19.23	-27.28
0.658	0.22	36.77	21.58	36.99	21.80	56.00	46.00	-19.01	-24.20
1.675	0.20	36.67	19.93	36.87	20.13	56.00	46.00	-19.13	-25.87
4.358	0.22	38.12	26.13	38.34	26.35	56.00	46.00	-17.66	-19.65
8.877	0.25	36.67	22.42	36.92	22.67	60.00	50.00	-23.08	-27.33
8.999	0.25	35.61	22.45	35.86	22.70	60.00	50.00	-24.14	-27.30

NOTE :

1. Measurement uncertainty is +/- 2dB
2. Emission level = Reading value + Correction factor
3. Correction Factor = Cable loss + Insertion loss of LISN
4. Margin value = Emission level - Limit
5. The emission of other frequencies was very low against the limit.
6. "-": The Quasi-peak reading value also meets average limit and measurement with the average detector is unnecessary.



TEST REPORT

Temperature:	26 °C	Humidity:	53 %RH
Frequency Range:	0.15 – 30 MHz	Tested Mode:	802.11n (40MHz)
Receiver Detector:	Q.P. and AV.	Modulation Type:	OFDM
Tested Channel:	CH 01	Tested Date:	Aug. 20, 2010

Power Line Measured : Line

Freq. (MHz)	Correct. Factor (dB)	Reading Value (dB μ V)		Emission Level (dB μ V)		Limit (dB μ V)		Margin (dB)	
		Q.P.	AV.	Q.P.	AV.	Q.P.	AV.	Q.P.	AV.
0.408	0.20	41.77	33.12	41.97	33.32	57.69	47.69	-15.72	-14.37
0.483	0.20	38.49	22.81	38.69	23.01	56.29	46.29	-17.60	-23.28
4.200	0.19	39.92	24.94	40.11	25.13	56.00	46.00	-15.89	-20.87
4.319	0.19	39.63	25.57	39.82	25.76	56.00	46.00	-16.18	-20.24
8.603	0.22	40.98	26.77	41.20	26.99	60.00	50.00	-18.80	-23.01
8.644	0.22	42.24	26.76	42.46	26.98	60.00	50.00	-17.54	-23.02

Power Line Measured : Neutral

Freq. (MHz)	Correct. Factor (dB)	Reading Value (dB μ V)		Emission Level (dB μ V)		Limit (dB μ V)		Margin (dB)	
		Q.P.	AV.	Q.P.	AV.	Q.P.	AV.	Q.P.	AV.
0.414	0.23	37.31	23.55	37.54	23.78	57.57	47.57	-20.03	-23.79
0.468	0.23	36.49	23.63	36.72	23.86	56.55	46.55	-19.83	-22.69
1.675	0.20	37.17	19.46	37.37	19.66	56.00	46.00	-18.63	-26.34
4.299	0.22	35.65	19.06	35.87	19.28	56.00	46.00	-20.13	-26.72
8.745	0.25	36.87	21.52	37.12	21.77	60.00	50.00	-22.88	-28.23
16.497	0.36	36.02	24.64	36.38	25.00	60.00	50.00	-23.62	-25.00

NOTE :

1. Measurement uncertainty is +/- 2dB
2. Emission level = Reading value + Correction factor
3. Correction Factor = Cable loss + Insertion loss of LISN
4. Margin value = Emission level - Limit
5. The emission of other frequencies was very low against the limit.
6. "-": The Quasi-peak reading value also meets average limit and measurement with the average detector is unnecessary.



TEST REPORT

Temperature:	26 °C	Humidity:	53 %RH
Frequency Range:	0.15 – 30 MHz	Tested Mode:	RX
Receiver Detector:	Q.P. and AV.	Modulation Type:	N/A
Tested Date:	Aug. 20, 2010	Tested Channel:	N/A

Power Line Measured : Line

Freq. (MHz)	Correct. Factor (dB)	Reading Value (dB μ V)		Emission Level (dB μ V)		Limit (dB μ V)		Margin (dB)	
		Q.P.	AV.	Q.P.	AV.	Q.P.	AV.	Q.P.	AV.
0.477	0.20	40.10	27.66	40.30	27.86	56.39	46.39	-16.09	-18.53
0.480	0.20	40.36	27.31	40.56	27.51	56.34	46.34	-15.78	-18.83
0.586	0.20	40.70	28.35	40.90	28.55	56.00	46.00	-15.10	-17.45
4.239	0.19	38.07	30.84	38.26	31.03	56.00	46.00	-17.74	-14.97
8.776	0.22	38.89	24.62	39.11	24.84	60.00	50.00	-20.89	-25.16
8.827	0.22	39.40	24.30	39.62	24.52	60.00	50.00	-20.38	-25.48

Power Line Measured : Neutral

Freq. (MHz)	Correct. Factor (dB)	Reading Value (dB μ V)		Emission Level (dB μ V)		Limit (dB μ V)		Margin (dB)	
		Q.P.	AV.	Q.P.	AV.	Q.P.	AV.	Q.P.	AV.
0.390	0.27	42.05	32.36	42.32	32.63	58.07	48.07	-15.75	-15.44
0.414	0.23	37.99	25.39	38.22	25.62	57.57	47.57	-19.35	-21.95
0.615	0.22	38.21	23.80	38.43	24.02	56.00	46.00	-17.57	-21.98
4.487	0.22	38.05	19.69	38.27	19.91	56.00	46.00	-17.73	-26.09
8.512	0.25	38.09	22.44	38.34	22.69	60.00	50.00	-21.66	-27.31
16.476	0.36	44.74	38.06	45.10	38.42	60.00	50.00	-14.90	-11.58

NOTE :

1. Measurement uncertainty is +/- 2dB
2. Emission level = Reading value + Correction factor
3. Correction Factor = Cable loss + Insertion loss of LISN
4. Margin value = Emission level - Limit
5. The emission of other frequencies was very low against the limit.
6. "-": The Quasi-peak reading value also meets average limit and measurement with the average detector is unnecessary.



TEST REPORT

4.2 RADIATED EMISSION TEST

4.2.1 LIMIT

FCC Part 15, Subpart C Section 15.209 limit of radiated emission for frequency below 1000 MHz. The emissions from an intentional radiator shall not exceed the field strength levels specified in the following table:

FREQUENCY (MHz)	DISTANCE (m)	FIELD STRENGTH (dB μ V/m)
0.009 - 0.490	300	2400/F(KHz)
0.490 - 1.705	30	24000/F(KHz)
1.705 - 30	30	30
30 - 88	3	40.0
88 - 216	3	43.5
216 - 960	3	46.0
Above 960	3	54.0

NOTE :

1. In the emission tables above, the tighter limit applies at the band edges.
2. Distance refers to the distance between measuring instrument, antenna, and the closest point of any part of the device or system.

FCC Part 15, Section 15.35(b) limit of radiated emission for frequency above 1000 MHz

FREQUENCY (MHz)	Class A (dB μ V/m) (at 3m)		Class B (dB μ V/m) (at 3m)	
	PEAK	AVERAGE	PEAK	AVERAGE
Above 1000	80.0	60.0	74.0	54.0



Spectrum Research & Testing Lab., Inc.
No. 101-10, Ling 8,
Shan-Tong Li, Chung-Li
City, Taoyuan, Taiwan

TEST REPORT

Reference No.: A10082002
Report No.: FCCA10082002
FCC ID : VYTLP-9181A
Page: 16 of 82
Date: Aug. 25, 2010

4.2.2 TEST EQUIPMENT

The following test equipment was used during the radiated emission test:

EQUIPMENT/ FACILITIES	SPECIFICATIONS	MANUFACTURER	MODEL#/ SERIAL#	DUE DATE OF CAL. & CAL. CENTER
EMI TEST RECEIVER	20 MHz TO 1000 MHz	ROHDE & SCHWARZ	ESVS30 / 841977/003	DEC. 2010 ETC
BI-LOG ANTENNA	30 MHz TO 2 GHz	SCHAFFNER	CBL6141A / 4181	MAY. 2011 ETC
COAXIAL CABLE	30M	TIMES	LMR-400 / #30M	MAY. 2011 ETC
FILTER	2 LINE, 30A	FIL.COIL	FC-943 / 869	NRC
OATS	3 – 10 M MEASUREMENT	SRT	SRT-1	NOV. 2010 SRT
SPECTRUM ANALYZER	9K-40GHz	R&S	FSP40/ 100093	DEC. 2010 ETC
PRE-AMPLIFIER	1 GHz TO 26.5 GHz	HP	8449B/ 3008A01995	JAN. 2011 ETC
HORN ANTENNA	1 GHz TO 18 GHz	EMCO	3115/ 6881	NOV. 2010 ETC
HORN ANTENNA	18 GHz TO 40 GHz	EMCO	3116/ 00032255	FEB. 2011 ETC
K-TYPE CABLE	15M	HUBER SUHNER	SF 102-40/2*11/ 23932/2	MAY 2011 ETC
K-TYPE CABLE	1M	HUBER SUHNER	SF 102-40/2*11/ 23934/2	NOV. 2010 ETC

NOTE:

1. The calibration interval of the above test equipment is one year and the calibrations are traceable to NML/ROC and NIST/USA.



4.2.3 TEST SET-UP (30MHz~1000MHz)

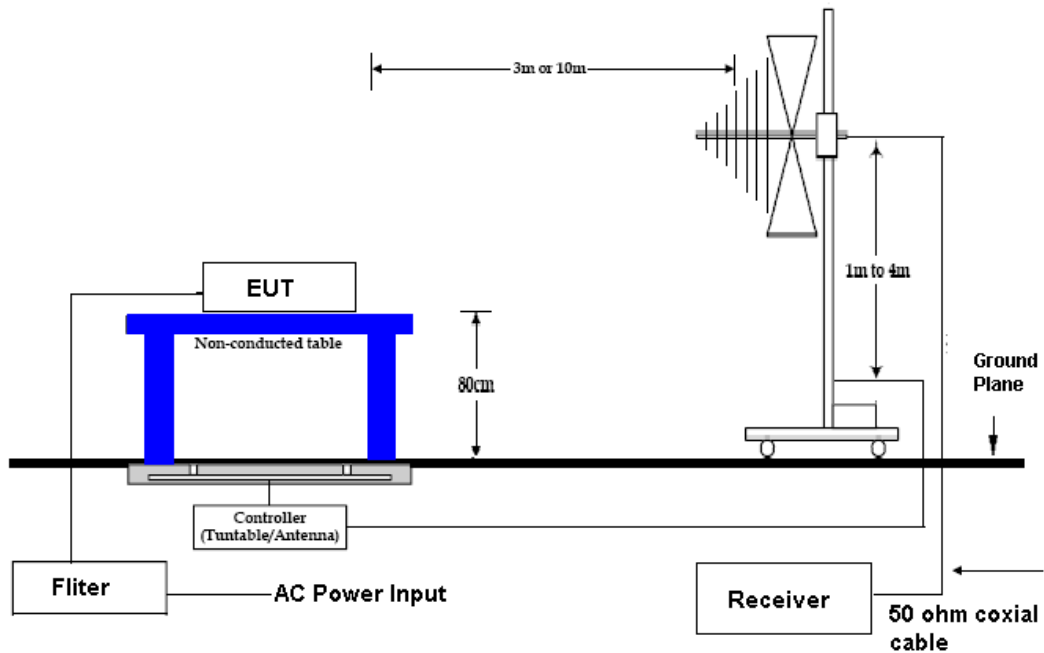

NOTE :

1. The EUT system was put on a wooden table with 0.8m heights above a ground plane.
2. For the actual test configuration, please refer to the photos of testing.



TEST SET- UP (1GHz - 25GHz)

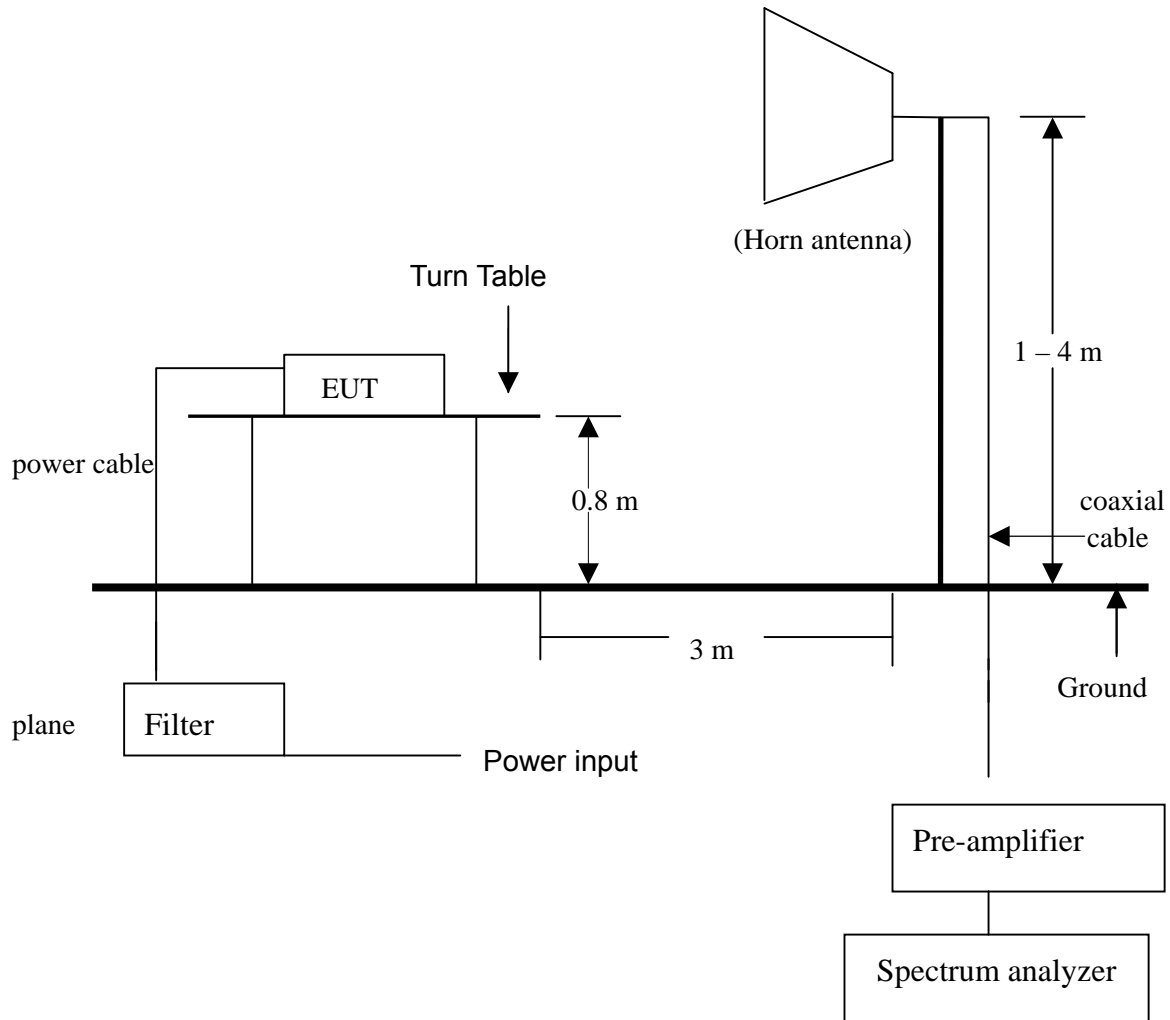

NOTE :

1. The EUT system was put on a wooden table with 0.8m heights above a ground plane.
2. For the actual test configuration, please refer to the photos of testing.



**Spectrum Research &
Testing Lab., Inc.**
No. 101-10, Ling 8,
Shan-Tong Li, Chung-Li
City, Taoyuan, Taiwan

TEST REPORT

Reference No.: A10082002
Report No.: FCCA10082002
FCC ID : VYTLP-9181A
Page: 19 of 82
Date: Aug. 25, 2010

4.2.4 TEST PROCEDURE

The EUT was tested according to the requirement of ANSI C63.4:2003 and CISPR 22:2003. The measurements were made at an open area test site with 3 meter measurement distance under 1 GHz and with 3m distance above 1GHz. The frequency spectrum measured started from 30 MHz. Under 1 GHz, all readings were quasi-peak values with 120 kHz resolution bandwidth of the test receiver. Above 1 GHz, the measurements were made at an open area test site with 3 meter measurement distance and all readings were peak or average values with 1 MHz resolution bandwidth of the test receiver. The EUT system was operated in all typical methods by users. The cables connected to EUT and support units were moved to find the maximum emission levels for each frequency.

First, find the margin or higher points at least 6 points by software, then use manual to find the maximum data. The procedure is referred on the test procedure of SRT LAB.



4.2.5 TEST RESULT

Temperature:	31 °C	Humidity:	56 %RH
Tested By:	Shunm Wang	Tested Mode:	802.11b
Receiver Detector:	Q.P.	Modulation Type:	DSSS
Frequency Range:	30M – 1GHz	Tested Channel:	CH 01
Tested Date:	Aug. 23, 2010		

Antenna Polarization : Horizontal

Frequency (MHz)	Cable Loss (dB)	Antenna Factor (dB/m)	Reading Data (dBμV)	Emission Level (dBμV/m)	Limit (dBμV/m)	Margin (dB)	AZ(°)	EL(m)
54.7870	1.14	12.14	17.0	30.3	40.0	-9.7	350	1.94
195.2142	1.90	11.35	26.5	39.8	43.5	-3.8	186	1.63
297.0562	2.40	13.72	19.8	35.9	46.0	-10.1	175	1.41
416.0220	2.86	16.62	20.2	39.7	46.0	-6.3	181	1.32
430.1266	2.92	16.90	18.7	38.5	46.0	-7.5	180	1.27
593.0661	3.49	19.46	15.5	38.4	46.0	-7.6	162	1.20

Antenna Polarization : Vertical

Frequency (MHz)	Cable Loss (dB)	Antenna Factor (dB/m)	Reading Data (dBμV)	Emission Level (dBμV/m)	Limit (dBμV/m)	Margin (dB)	AZ(°)	EL(m)
54.7810	1.14	12.14	21.9	35.2	40.0	-4.8	10	1.14
184.1055	1.84	10.66	26.2	38.7	43.5	-4.8	159	1.23
416.0219	2.86	16.62	22.9	42.4	46.0	-3.6	170	1.12
432.0233	2.93	16.94	19.2	39.1	46.0	-6.9	186	1.28
445.1060	2.98	17.20	20.1	40.3	46.0	-5.7	189	1.23
593.0656	3.49	19.46	17.9	40.8	46.0	-5.2	192	1.15

NOTE :

1. Measurement uncertainty is +/- 2.3dB.
2. "": Measurement does not apply for this frequency.
3. Emission Level = Reading Value + Ant. Factor + Cable Loss.
4. The field strength of other emission frequencies were very low against the limit.



TEST REPORT

Temperature:	31 °C	Humidity:	56 %RH
Tested By:	Shunm Wang	Tested Mode:	802.11 g
Receiver Detector:	Q.P.	Modulation Type:	OFDM
Frequency Range:	30M – 1GHz	Tested Channel:	CH 01
Tested Date:	Aug. 23, 2010		

Antenna Polarization : Horizontal

Frequency (MHz)	Cable Loss (dB)	Antenna Factor (dB/m)	Reading Data (dBμV)	Emission Level (dBμV/m)	Limit (dBμV/m)	Margin (dB)	AZ(°)	EL(m)
54.7867	1.14	12.14	16.9	30.2	40.0	-9.8	352	1.93
195.2149	1.90	11.35	26.4	39.7	43.5	-3.9	184	1.62
297.0566	2.40	13.72	19.6	35.7	46.0	-10.3	176	1.42
416.0229	2.86	16.62	20.1	39.6	46.0	-6.4	186	1.31
430.1261	2.92	16.90	18.6	38.4	46.0	-7.6	176	1.26
593.0658	3.49	19.46	15.6	38.5	46.0	-7.5	165	1.21

Antenna Polarization : Vertical

Frequency (MHz)	Cable Loss (dB)	Antenna Factor (dB/m)	Reading Data (dBμV)	Emission Level (dBμV/m)	Limit (dBμV/m)	Margin (dB)	AZ(°)	EL(m)
54.7813	1.14	12.14	21.8	35.1	40.0	-4.9	11	1.13
184.1051	1.84	10.66	26.3	38.8	43.5	-4.7	155	1.22
416.0215	2.86	16.62	22.7	42.2	46.0	-3.8	173	1.13
432.0236	2.93	16.94	19.1	39.0	46.0	-7.0	184	1.27
445.1061	2.98	17.20	20.0	40.2	46.0	-5.8	186	1.22
593.0652	3.49	19.46	17.7	40.6	46.0	-5.4	190	1.16

NOTE :

1. Measurement uncertainty is +/- 2.4dB.
2. "": Measurement does not apply for this frequency.
3. Emission Level = Reading Value + Ant. Factor + Cable Loss.
4. The field strength of other emission frequencies were very low against the limit.



TEST REPORT

Temperature:	31 °C	Humidity:	56 %RH
Tested By:	Shunm Wang	Tested Mode:	802.11 n(20M)
Receiver Detector:	Q.P.	Modulation Type:	OFDM
Frequency Range:	30M – 1GHz	Tested Channel:	CH 01
Tested Date:	Aug. 23, 2010		

Antenna Polarization : Horizontal

Frequency (MHz)	Cable Loss (dB)	Antenna Factor (dB/m)	Reading Data (dBμV)	Emission Level (dBμV/m)	Limit (dBμV/m)	Margin (dB)	AZ(°)	EL(m)
54.7861	1.14	12.14	16.8	30.1	40.0	-9.9	351	1.94
195.2142	1.90	11.35	26.3	39.6	43.5	-4.0	185	1.63
297.0560	2.40	13.72	19.5	35.6	46.0	-10.4	172	1.43
416.0223	2.86	16.62	20.2	39.7	46.0	-6.3	185	1.3
430.1265	2.92	16.90	18.5	38.3	46.0	-7.7	173	1.25
593.0654	3.49	19.46	15.4	38.3	46.0	-7.7	167	1.22

Antenna Polarization : Vertical

Frequency (MHz)	Cable Loss (dB)	Antenna Factor (dB/m)	Reading Data (dBμV)	Emission Level (dBμV/m)	Limit (dBμV/m)	Margin (dB)	AZ(°)	EL(m)
54.7816	1.14	12.14	21.9	35.2	40.0	-4.8	14	1.14
184.1050	1.84	10.66	26.2	38.7	43.5	-4.8	153	1.23
416.0211	2.86	16.62	22.6	42.1	46.0	-3.9	170	1.14
432.0239	2.93	16.94	19.0	38.9	46.0	-7.1	181	1.26
445.1062	2.98	17.20	19.9	40.1	46.0	-5.9	183	1.23
593.0650	3.49	19.46	17.8	40.7	46.0	-5.3	192	1.17

NOTE :

1. Measurement uncertainty is +/- 2.4dB.
2. "": Measurement does not apply for this frequency.
3. Emission Level = Reading Value + Ant. Factor + Cable Loss.
4. The field strength of other emission frequencies were very low against the limit.



TEST REPORT

Temperature:	31 °C	Humidity:	56 %RH
Tested By:	Shunm Wang	Tested Mode:	802.11 n(40M)
Receiver Detector:	Q.P.	Modulation Type:	OFDM
Frequency Range:	30M – 1GHz	Tested Channel:	CH 01
Tested Date:	Aug. 23, 2010		

Antenna Polarization : Horizontal

Frequency (MHz)	Cable Loss (dB)	Antenna Factor (dB/m)	Reading Data (dBμV)	Emission Level (dBμV/m)	Limit (dBμV/m)	Margin (dB)	AZ(°)	EL(m)
54.7861	1.14	12.14	16.5	29.8	40.0	-10.2	349	1.92
195.2138	1.90	11.35	26.1	39.4	43.5	-4.2	182	1.62
297.0566	2.40	13.72	19.5	35.6	46.0	-10.4	176	1.42
416.0218	2.86	16.62	20.3	39.8	46.0	-6.2	188	1.31
430.1261	2.92	16.90	18.4	38.2	46.0	-7.8	179	1.24
593.0650	3.49	19.46	15.5	38.4	46.0	-7.6	162	1.23

Antenna Polarization : Vertical

Frequency (MHz)	Cable Loss (dB)	Antenna Factor (dB/m)	Reading Data (dBμV)	Emission Level (dBμV/m)	Limit (dBμV/m)	Margin (dB)	AZ(°)	EL(m)
54.7816	1.14	12.14	21.2	34.5	40.0	-5.5	6	1.16
184.1090	1.84	10.66	26.1	38.6	43.5	-4.9	166	1.24
195.2140	1.90	11.35	26.1	39.4	43.5	-4.2	189	1.15
430.1258	2.92	16.90	18.6	38.4	46.0	-7.6	181	1.25
445.1100	2.98	17.20	18.9	39.1	46.0	-6.9	190	1.24
743.3205	3.89	21.73	15.1	40.7	46.0	-5.3	172	1.16

NOTE :

1. Measurement uncertainty is +/- 2.4dB.
2. "": Measurement does not apply for this frequency.
3. Emission Level = Reading Value + Ant. Factor + Cable Loss.
4. The field strength of other emission frequencies were very low against the limit.



TEST REPORT

Temperature:	31 °C	Humidity:	56 %RH
Tested By:	Shunm Wang	Tested Mode:	RX
Receiver Detector:	Q.P.	Modulation Type:	NA
Frequency Range:	30M – 1GHz	Tested Channel:	NA
Tested Date:	Aug. 23, 2010		

Antenna Polarization : Horizontal

Frequency (MHz)	Cable Loss (dB)	Antenna Factor (dB/m)	Reading Data (dBμV)	Emission Level (dBμV/m)	Limit (dBμV/m)	Margin (dB)	AZ(°)	EL(m)
54.7870	1.14	12.14	16.9	30.2	40.0	-9.8	351	1.95
184.1050	1.84	10.66	25.7	38.2	43.5	-5.3	162	1.84
195.2140	1.90	11.35	26.4	39.7	43.5	-3.9	188	1.62
297.0560	2.40	13.72	19.6	35.7	46.0	-10.3	174	1.42
430.1260	2.92	16.90	18.5	38.3	46.0	-7.7	179	1.28
593.0660	3.49	19.46	15.3	38.2	46.0	-7.8	165	1.19

Antenna Polarization : Vertical

Frequency (MHz)	Cable Loss (dB)	Antenna Factor (dB/m)	Reading Data (dBμV)	Emission Level (dBμV/m)	Limit (dBμV/m)	Margin (dB)	AZ(°)	EL(m)
54.7810	1.14	12.14	21.8	35.1	40.0	-4.9	12	1.13
150.0253	1.70	12.60	20.2	34.5	43.5	-9.0	149	1.25
192.0320	1.90	11.08	22.5	35.5	43.5	-8.0	167	1.11
416.0230	2.86	16.62	18.1	37.6	46.0	-8.4	175	1.34
432.0230	2.93	16.94	19.0	38.9	46.0	-7.1	189	1.29
445.1030	2.98	17.20	19.9	40.1	46.0	-5.9	191	1.22

NOTE :

1. Measurement uncertainty is +/- 2.4dB.
2. "": Measurement does not apply for this frequency.
3. Emission Level = Reading Value + Ant. Factor + Cable Loss.
4. The field strength of other emission frequencies were very low against the limit.



TEST REPORT

Temperature:	31 °C	Humidity:	56 %RH
Tested By:	Shunm Wang	Tested Mode:	802.11 b
Frequency Range:	1 – 25GHz	Modulation Type:	DSSS
Receiver Detector:	PK. and AV.	Tested Channel:	CH 01
Tested Date:	Aug. 23, 2010		

Antenna Polarization : Horizontal

Frequency (MHz)	Correct Factor (dB)	Ant. Factor (dB/m)	Reading Data (dB μ V)		Emission Level (dB μ V/m)		Limit (dB μ V/m)		Margin (dB)		AZ (°)	EL (m)
			PK.	AV.	PK.	AV.	PK.	AV.	PK.	AV.		
2412.00	-22.66	28.12	105.8	103.2	111.3	108.7	74.0	54.0	(F)	(F)	181	1.39
4824.00	-16.65	33.11	41.5	34.1	58.0	50.6	74.0	54.0	-16.0	-3.4	173	1.22
7236.00	-12.72	35.67	32.2	25.1	55.2	48.1	74.0	54.0	-18.8	-5.9	189	1.14
1059.50	-28.37	24.44	39.1	33.6	35.2	29.7	74.0	54.0	-38.8	-24.3	214	1.25
1820.25	-24.62	26.65	42.9	39.4	44.9	41.4	74.0	54.0	-29.1	-12.6	113	1.31
2304.75	-22.99	27.91	33.5	28.8	38.4	33.7	74.0	54.0	-35.6	-20.3	209	1.27

Antenna Polarization : Vertical

Frequency (MHz)	Correct Factor (dB)	Ant. Factor (dB/m)	Reading Data (dB μ V)		Emission Level (dB μ V/m)		Limit (dB μ V/m)		Margin (dB)		AZ (°)	EL (m)
			PK.	AV.	PK.	AV.	PK.	AV.	PK.	AV.		
2412.00	-22.66	28.12	114.4	111.5	119.9	117.0	74.0	54.0	(F)	(F)	183	1.26
4824.00	-16.65	33.11	42.6	35.1	59.1	51.6	74.0	54.0	-14.9	-2.4	175	1.19
7236.00	-12.72	35.67	33.7	26.6	56.7	49.6	74.0	54.0	-17.3	-4.4	179	1.08
1072.25	-28.30	24.47	45.9	38.9	42.1	35.1	74.0	54.0	-31.9	-18.9	239	1.36
1748.00	-24.91	26.39	40.1	34.1	41.6	35.6	74.0	54.0	-32.4	-18.4	222	1.15
2691.50	-21.94	28.99	39.8	32.5	46.8	39.5	74.0	54.0	-27.2	-14.5	109	1.27

NOTE :

1. Measurement uncertainty is +/- 2.3dB.
2. "": The Peak reading value also meets average limit and measurement with the average detector is unnecessary.
3. Emission Level = Reading Value + Ant. Factor + Correct Factor (incl.: Cable Loss and Pre-Amplifier Gain)
4. The field strength of other emission frequencies were very low against the limit.
5. (F): The field strength of fundamental frequency.



TEST REPORT

Temperature:	31 °C	Humidity:	56 %RH
Tested By:	Shunm Wang	Tested Mode:	802.11 b
Frequency Range:	1 – 25GHz	Modulation Type:	DSSS
Receiver Detector:	PK. and AV.	Tested Channel:	CH 06
Tested Date:	Aug. 23, 2010		

Antenna Polarization : Horizontal

Frequency (MHz)	Correct Factor (dB)	Ant. Factor (dB/m)	Reading Data (dB μ V)		Emission Level (dB μ V/m)		Limit (dB μ V/m)		Margin (dB)		AZ (°)	EL (m)
			PK.	AV.	PK.	AV.	PK.	AV.	PK.	AV.		
2437.00	-22.59	28.17	104.5	102.3	110.1	107.9	74.0	54.0	(F)	(F)	182	1.38
4874.00	-16.55	33.22	41.4	34.0	58.1	50.7	74.0	54.0	-15.9	-3.3	174	1.23
7311.00	-12.63	35.82	32.3	25.2	55.5	48.4	74.0	54.0	-18.5	-5.6	188	1.15
1059.50	-28.37	24.44	39.2	33.5	35.3	29.6	74.0	54.0	-38.7	-24.4	216	1.24
1820.25	-24.62	26.65	42.8	39.5	44.8	41.5	74.0	54.0	-29.2	-12.5	110	1.32
2304.75	-22.99	27.91	33.6	28.7	38.5	33.6	74.0	54.0	-35.5	-20.4	213	1.26

Antenna Polarization : Vertical

Frequency (MHz)	Correct Factor (dB)	Ant. Factor (dB/m)	Reading Data (dB μ V)		Emission Level (dB μ V/m)		Limit (dB μ V/m)		Margin (dB)		AZ (°)	EL (m)
			PK.	AV.	PK.	AV.	PK.	AV.	PK.	AV.		
2437.00	-22.59	28.17	116.0	112.9	121.6	118.5	74.0	54.0	(F)	(F)	183	1.25
4874.00	-16.55	33.22	42.5	35.0	59.2	51.7	74.0	54.0	-14.8	-2.3	175	1.2
7311.00	-12.63	35.82	33.6	26.5	56.8	49.7	74.0	54.0	-17.2	-4.3	179	1.09
1072.25	-28.30	24.47	45.8	38.8	42.0	35.0	74.0	54.0	-32.0	-19.0	239	1.35
1748.00	-24.91	26.39	40.2	34.0	41.7	35.5	74.0	54.0	-32.3	-18.5	222	1.14
2691.50	-21.94	28.99	39.7	32.4	46.7	39.4	74.0	54.0	-27.3	-14.6	109	1.26

NOTE :

1. Measurement uncertainty is +/- 2.3dB.
2. "": The Peak reading value also meets average limit and measurement with the average detector is unnecessary.
3. Emission Level = Reading Value + Ant. Factor + Correct Factor (incl.: Cable Loss and Pre-Amplifier Gain)
4. The field strength of other emission frequencies were very low against the limit.
5. (F): The field strength of fundamental frequency.



TEST REPORT

Temperature:	31 °C	Humidity:	56 %RH
Tested By:	Shunm Wang	Tested Mode:	802.11 b
Frequency Range:	1 – 25GHz	Modulation Type:	DSSS
Receiver Detector:	PK. and AV.	Tested Channel:	CH 11
Tested Date:	Aug. 23, 2010		

Antenna Polarization : Horizontal

Frequency (MHz)	Correct Factor (dB)	Ant. Factor (dB/m)	Reading Data (dB μ V)		Emission Level (dB μ V/m)		Limit (dB μ V/m)		Margin (dB)		AZ (°)	EL (m)
			PK.	AV.	PK.	AV.	PK.	AV.	PK.	AV.		
2462.00	-22.51	28.22	103.9	100.2	109.6	105.9	74.0	54.0	(F)	(F)	179	1.37
4924.00	-16.45	33.33	41.5	34.2	58.4	51.1	74.0	54.0	-15.6	-2.9	178	1.24
7386.00	-12.54	35.97	32.1	25.0	55.5	48.4	74.0	54.0	-18.5	-5.6	187	1.16
1059.50	-28.37	24.44	39.3	33.2	35.4	29.3	74.0	54.0	-38.6	-24.7	214	1.25
1820.25	-24.62	26.65	42.7	39.3	44.7	41.3	74.0	54.0	-29.3	-12.7	113	1.31
2304.75	-22.99	27.91	33.5	28.5	38.4	33.4	74.0	54.0	-35.6	-20.6	210	1.27

Antenna Polarization : Vertical

Frequency (MHz)	Correct Factor (dB)	Ant. Factor (dB/m)	Reading Data (dB μ V)		Emission Level (dB μ V/m)		Limit (dB μ V/m)		Margin (dB)		AZ (°)	EL (m)
			PK.	AV.	PK.	AV.	PK.	AV.	PK.	AV.		
2462.00	-22.51	28.22	115.4	112.9	121.1	118.6	74.0	54.0	(F)	(F)	180	1.26
4924.00	-16.45	33.33	42.3	34.5	59.2	51.4	74.0	54.0	-14.8	-2.6	172	1.22
7386.00	-12.54	35.97	33.4	26.3	56.8	49.7	74.0	54.0	-17.2	-4.3	176	1.11
1072.25	-28.30	24.47	45.7	38.5	41.9	34.7	74.0	54.0	-32.1	-19.3	235	1.34
1748.00	-24.91	26.39	40.6	33.9	42.1	35.4	74.0	54.0	-31.9	-18.6	226	1.15
2691.50	-21.94	28.99	39.5	32.5	46.5	39.5	74.0	54.0	-27.5	-14.5	112	1.24

NOTE :

1. Measurement uncertainty is +/- 2.3dB.
2. "": The Peak reading value also meets average limit and measurement with the average detector is unnecessary.
3. Emission Level = Reading Value + Ant. Factor + Correct Factor (incl.: Cable Loss and Pre-Amplifier Gain)
4. The field strength of other emission frequencies were very low against the limit.
5. (F): The field strength of fundamental frequency.



TEST REPORT

Temperature:	31 °C	Humidity:	56 %RH
Tested By:	Shunm Wang	Tested Mode:	802.11 g
Frequency Range:	1 – 25GHz	Modulation Type:	OFDM
Receiver Detector:	PK. and AV.	Tested Channel:	CH 01
Tested Date:	Aug. 23, 2010		

Antenna Polarization : Horizontal

Frequency (MHz)	Correct Factor (dB)	Ant. Factor (dB/m)	Reading Data (dB μ V)		Emission Level (dB μ V/m)		Limit (dB μ V/m)		Margin (dB)		AZ (°)	EL (m)
			PK.	AV.	PK.	AV.	PK.	AV.	PK.	AV.		
2412.00	-22.66	28.12	100.7	102.3	106.1	107.8	74.0	54.0	(F)	(F)	179	1.37
4824.00	-16.65	33.11	40.2	32.1	56.7	48.6	74.0	54.0	-17.3	-5.4	170	1.24
7236.00	-12.72	35.67	31.1	23.9	54.1	46.9	74.0	54.0	-19.9	-7.1	186	1.16
1059.50	-28.37	24.44	38.5	32.1	34.6	28.2	74.0	54.0	-39.4	-25.8	215	1.23
1820.25	-24.62	26.65	41.6	35.2	43.6	37.2	74.0	54.0	-30.4	-16.8	113	1.31
2304.75	-22.99	27.91	32.9	37.5	37.8	42.4	74.0	54.0	-36.2	-11.6	214	1.25

Antenna Polarization : Vertical

Frequency (MHz)	Correct Factor (dB)	Ant. Factor (dB/m)	Reading Data (dB μ V)		Emission Level (dB μ V/m)		Limit (dB μ V/m)		Margin (dB)		AZ (°)	EL (m)
			PK.	AV.	PK.	AV.	PK.	AV.	PK.	AV.		
2412.00	-22.66	28.12	115.0	113.2	120.5	118.7	74.0	54.0	(F)	(F)	183	1.24
4824.00	-16.65	33.11	41.3	34.2	57.8	50.7	74.0	54.0	-16.2	-3.3	175	1.22
7236.00	-12.72	35.67	32.5	25.3	55.5	48.3	74.0	54.0	-18.5	-5.7	179	1.12
1072.25	-28.30	24.47	45.2	38.5	41.4	34.7	74.0	54.0	-32.6	-19.3	239	1.33
1748.00	-24.91	26.39	40.9	34.2	42.4	35.7	74.0	54.0	-31.6	-18.3	222	1.15
2691.50	-21.94	28.99	39.5	32.8	46.5	39.8	74.0	54.0	-27.5	-14.2	109	1.24

NOTE :

1. Measurement uncertainty is +/- 2.3dB.
2. "**": The Peak reading value also meets average limit and measurement with the average detector is unnecessary.
3. Emission Level = Reading Value + Ant. Factor + Correct Factor (incl.: Cable Loss and Pre-Amplifier Gain)
4. The field strength of other emission frequencies were very low against the limit.
5. (F): The field strength of fundamental frequency.



TEST REPORT

Temperature:	31 °C	Humidity:	56 %RH
Tested By:	Shunm Wang	Tested Mode:	802.11 g
Frequency Range:	1 – 25GHz	Modulation Type:	OFDM
Receiver Detector:	PK. and AV.	Tested Channel:	CH 06
Tested Date:	Aug. 23, 2010		

Antenna Polarization : Horizontal

Frequency (MHz)	Correct Factor (dB)	Ant. Factor (dB/m)	Reading Data (dB μ V)		Emission Level (dB μ V/m)		Limit (dB μ V/m)		Margin (dB)		AZ (°)	EL (m)
			PK.	AV.	PK.	AV.	PK.	AV.	PK.	AV.		
2437.00	-22.59	28.17	100.0	100.2	105.6	105.8	74.0	54.0	(F)	(F)	183	1.36
4874.00	-16.55	33.22	38.5	32.5	55.2	49.2	74.0	54.0	-18.8	-4.8	175	1.25
7311.00	-12.63	35.82	30.4	24.1	53.6	47.3	74.0	54.0	-20.4	-6.7	189	1.17
1059.50	-28.37	24.44	38.5	32.1	34.6	28.2	74.0	54.0	-39.4	-25.8	215	1.23
1820.25	-24.62	26.65	41.6	35.2	43.6	37.2	74.0	54.0	-30.4	-16.8	113	1.31
2304.75	-22.99	27.91	32.9	37.5	37.8	42.4	74.0	54.0	-36.2	-11.6	214	1.25

Antenna Polarization : Vertical

Frequency (MHz)	Correct Factor (dB)	Ant. Factor (dB/m)	Reading Data (dB μ V)		Emission Level (dB μ V/m)		Limit (dB μ V/m)		Margin (dB)		AZ (°)	EL (m)
			PK.	AV.	PK.	AV.	PK.	AV.	PK.	AV.		
2437.00	-22.59	28.17	113.1	110.2	118.7	115.8	74.0	54.0	(F)	(F)	180	1.27
4874.00	-16.55	33.22	40.2	32.1	56.9	48.8	74.0	54.0	-17.1	-5.2	172	1.23
7311.00	-12.63	35.82	32.8	25.0	56.0	48.2	74.0	54.0	-18.0	-5.8	176	1.12
1072.25	-28.30	24.47	45.2	38.5	41.4	34.7	74.0	54.0	-32.6	-19.3	239	1.33
1748.00	-24.91	26.39	40.9	34.2	42.4	35.7	74.0	54.0	-31.6	-18.3	222	1.15
2691.50	-21.94	28.99	39.5	32.8	46.5	39.8	74.0	54.0	-27.5	-14.2	109	1.24

NOTE :

1. Measurement uncertainty is +/- 2.3dB.
2. "": The Peak reading value also meets average limit and measurement with the average detector is unnecessary.
3. Emission Level = Reading Value + Ant. Factor + Correct Factor (incl.: Cable Loss and Pre-Amplifier Gain)
4. The field strength of other emission frequencies were very low against the limit.
5. (F): The field strength of fundamental frequency.



TEST REPORT

Temperature:	31 °C	Humidity:	56 %RH
Tested By:	Shunm Wang	Tested Mode:	802.11 g
Frequency Range:	1 – 25GHz	Modulation Type:	OFDM
Receiver Detector:	PK. and AV.	Tested Channel:	CH 11
Tested Date:	Aug. 23, 2010		

Antenna Polarization : Horizontal

Frequency (MHz)	Correct Factor (dB)	Ant. Factor (dB/m)	Reading Data (dB μ V)		Emission Level (dB μ V/m)		Limit (dB μ V/m)		Margin (dB)		AZ (°)	EL (m)
			PK.	AV.	PK.	AV.	PK.	AV.	PK.	AV.		
2462.00	-22.51	28.22	97.5	95.3	103.2	101.0	74.0	54.0	(F)	(F)	181	1.36
4924.00	-16.45	33.33	37.5	32.1	54.4	49.0	74.0	54.0	-19.6	-5.0	176	1.26
7386.00	-12.54	35.97	28.6	22.3	52.0	45.7	74.0	54.0	-22.0	-8.3	191	1.15
1059.50	-28.37	24.44	39.4	33.1	35.5	29.2	74.0	54.0	-38.5	-24.8	215	1.24
1820.25	-24.62	26.65	42.8	39.4	44.8	41.4	74.0	54.0	-29.2	-12.6	115	1.32
2304.75	-22.99	27.91	33.6	28.4	38.5	33.3	74.0	54.0	-35.5	-20.7	213	1.26

Antenna Polarization : Vertical

Frequency (MHz)	Correct Factor (dB)	Ant. Factor (dB/m)	Reading Data (dB μ V)		Emission Level (dB μ V/m)		Limit (dB μ V/m)		Margin (dB)		AZ (°)	EL (m)
			PK.	AV.	PK.	AV.	PK.	AV.	PK.	AV.		
2462.00	-22.51	28.22	110.2	107.6	115.9	113.3	74.0	54.0	(F)	(F)	183	1.28
4924.00	-16.45	33.33	38.6	31.2	55.5	48.1	74.0	54.0	-18.5	-5.9	170	1.24
7386.00	-12.54	35.97	30.2	23.9	53.6	47.3	74.0	54.0	-20.4	-6.7	173	1.13
1072.25	-28.30	24.47	45.6	38.4	41.8	34.6	74.0	54.0	-32.2	-19.4	235	1.33
1748.00	-24.91	26.39	40.5	33.8	42.0	35.3	74.0	54.0	-32.0	-18.7	226	1.24
2691.50	-21.94	28.99	39.4	32.4	46.4	39.4	74.0	54.0	-27.6	-14.6	112	1.25

NOTE :

1. Measurement uncertainty is +/- 2.3dB.
2. "": The Peak reading value also meets average limit and measurement with the average detector is unnecessary.
3. Emission Level = Reading Value + Ant. Factor + Correct Factor (incl.:Cable Loss and Pre-Amplifier Gain)
4. The field strength of other emission frequencies were very low against the limit.
5. (F):The field strength of fundamental frequency.



TEST REPORT

Temperature:	31 °C	Humidity:	56 %RH
Tested By:	Shunm Wang	Tested Mode:	802.11 n(20M)
Frequency Range:	1 – 25GHz	Modulation Type:	OFDM
Receiver Detector:	PK. and AV.	Tested Channel:	CH 01
Tested Date:	Aug. 23, 2010		

Antenna Polarization : Horizontal

Frequency (MHz)	Correct Factor (dB)	Ant. Factor (dB/m)	Reading Data (dB μ V)		Emission Level (dB μ V/m)		Limit (dB μ V/m)		Margin (dB)		AZ (°)	EL (m)
			PK.	AV.	PK.	AV.	PK.	AV.	PK.	AV.		
2412.00	-22.66	28.12	112.8	109.5	118.3	115.0	74.0	54.0	(F)	(F)	180	1.37
4824.00	-16.65	33.11	41.9	34.5	58.4	51.0	74.0	54.0	-15.6	-3.0	173	1.24
7236.00	-12.72	35.67	32.8	25.8	55.8	48.8	74.0	54.0	-18.2	-5.2	186	1.16
1059.50	-28.37	24.44	39.1	33.5	35.2	29.5	74.0	54.0	-38.8	-24.5	213	1.24
1820.25	-24.62	26.65	42.6	39.6	44.6	41.6	74.0	54.0	-29.4	-12.4	101	1.32
2304.75	-22.99	27.91	33.5	28.7	38.4	33.6	74.0	54.0	-35.6	-20.4	213	1.24

Antenna Polarization : Vertical

Frequency (MHz)	Correct Factor (dB)	Ant. Factor (dB/m)	Reading Data (dB μ V)		Emission Level (dB μ V/m)		Limit (dB μ V/m)		Margin (dB)		AZ (°)	EL (m)
			PK.	AV.	PK.	AV.	PK.	AV.	PK.	AV.		
2412.00	-22.66	28.12	114.1	112.3	119.6	117.8	74.0	54.0	(F)	(F)	181	1.23
4824.00	-16.65	33.11	40.6	33.2	57.1	49.7	74.0	54.0	-16.9	-4.3	172	1.22
7236.00	-12.72	35.67	31.7	24.7	54.7	47.7	74.0	54.0	-19.3	-6.3	173	1.08
1072.25	-28.30	24.47	45.8	38.7	42.0	34.9	74.0	54.0	-32.0	-19.1	234	1.33
1748.00	-24.91	26.39	40.2	33.9	41.7	35.4	74.0	54.0	-32.3	-18.6	221	1.14
2691.50	-21.94	28.99	39.6	32.3	46.6	39.3	74.0	54.0	-27.4	-14.7	110	1.26

NOTE :

1. Measurement uncertainty is +/- 2.3dB.
2. "": The Peak reading value also meets average limit and measurement with the average detector is unnecessary.
3. Emission Level = Reading Value + Ant. Factor + Correct Factor (incl.:Cable Loss and Pre-Amplifier Gain)
4. The field strength of other emission frequencies were very low against the limit.
5. (F):The field strength of fundamental frequency.



TEST REPORT

Temperature:	31 °C	Humidity:	56 %RH
Tested By:	Shunm Wang	Tested Mode:	802.11 n(20M)
Frequency Range:	1 – 25GHz	Modulation Type:	OFDM
Receiver Detector:	PK. and AV.	Tested Channel:	CH 06
Tested Date:	Aug. 23, 2010		

Antenna Polarization : Horizontal

Frequency (MHz)	Correct Factor (dB)	Ant. Factor (dB/m)	Reading Data (dBμV)		Emission Level (dBμV/m)		Limit (dBμV/m)		Margin (dB)		AZ (°)	EL (m)
			PK.	AV.	PK.	AV.	PK.	AV.	PK.	AV.		
2437.00	-22.59	28.17	98.8	95.9	104.3	101.5	74.0	54.0	(F)	(F)	181	1.36
4874.00	-16.55	33.22	39.5	32.5	56.2	49.2	74.0	54.0	-17.8	-4.8	172	1.25
7311.00	-12.63	35.82	30.4	22.9	53.6	46.1	74.0	54.0	-20.4	-7.9	193	1.17
1059.50	-28.37	24.44	39.0	33.6	35.1	29.7	74.0	54.0	-38.9	-24.3	210	1.23
1820.25	-24.62	26.65	42.5	39.4	44.5	41.4	74.0	54.0	-29.5	-12.6	105	1.31
2304.75	-22.99	27.91	33.4	28.5	38.3	33.4	74.0	54.0	-35.7	-20.6	209	1.25

Antenna Polarization : Vertical

Frequency (MHz)	Correct Factor (dB)	Ant. Factor (dB/m)	Reading Data (dBμV)		Emission Level (dBμV/m)		Limit (dBμV/m)		Margin (dB)		AZ (°)	EL (m)
			PK.	AV.	PK.	AV.	PK.	AV.	PK.	AV.		
2437.00	-22.59	28.17	111.5	106.9	117.1	112.5	74.0	54.0	(F)	(F)	183	1.25
4874.00	-16.55	33.22	41.2	33.1	57.9	49.8	74.0	54.0	-16.1	-4.2	170	1.23
7311.00	-12.63	35.82	32.2	25.0	55.4	48.2	74.0	54.0	-18.6	-5.8	175	1.12
1072.25	-28.30	24.47	45.7	38.6	41.9	34.8	74.0	54.0	-32.1	-19.2	235	1.34
1748.00	-24.91	26.39	40.3	33.8	41.8	35.3	74.0	54.0	-32.2	-18.7	226	1.13
2691.50	-21.94	28.99	39.5	32.1	46.5	39.1	74.0	54.0	-27.5	-14.9	114	1.25

NOTE :

1. Measurement uncertainty is +/- 2.3dB.
2. "": The Peak reading value also meets average limit and measurement with the average detector is unnecessary.
3. Emission Level = Reading Value + Ant. Factor + Correct Factor (incl.:Cable Loss and Pre-Amplifier Gain)
4. The field strength of other emission frequencies were very low against the limit.
5. (F):The field strength of fundamental frequency.



TEST REPORT

Temperature:	31 °C	Humidity:	56 %RH
Tested By:	Shunm Wang	Tested Mode:	802.11 n(20M)
Frequency Range:	1 – 25GHz	Modulation Type:	OFDM
Receiver Detector:	PK. and AV.	Tested Channel:	CH 11
Tested Date:	Aug. 23, 2010		

Antenna Polarization : Horizontal

Frequency (MHz)	Correct Factor (dB)	Ant. Factor (dB/m)	Reading Data (dBμV)		Emission Level (dBμV/m)		Limit (dBμV/m)		Margin (dB)		AZ (°)	EL (m)
			PK.	AV.	PK.	AV.	PK.	AV.	PK.	AV.		
2462.00	-22.51	28.22	98.4	96.1	104.2	101.8	74.0	54.0	(F)	(F)	179	1.34
4924.00	-16.45	33.33	40.2	33.1	57.1	50.0	74.0	54.0	-16.9	-4.0	172	1.26
7386.00	-12.54	35.97	30.9	23.5	54.3	46.9	74.0	54.0	-19.7	-7.1	193	1.15
1059.50	-28.37	24.44	39.4	32.3	35.5	28.4	74.0	54.0	-38.5	-25.6	216	1.24
1820.25	-24.62	26.65	42.6	39.4	44.6	41.4	74.0	54.0	-29.4	-12.6	119	1.32
2304.75	-22.99	27.91	33.6	28.6	38.5	33.5	74.0	54.0	-35.5	-20.5	217	1.26

Antenna Polarization : Vertical

Frequency (MHz)	Correct Factor (dB)	Ant. Factor (dB/m)	Reading Data (dBμV)		Emission Level (dBμV/m)		Limit (dBμV/m)		Margin (dB)		AZ (°)	EL (m)
			PK.	AV.	PK.	AV.	PK.	AV.	PK.	AV.		
2462.00	-22.51	28.22	109.6	105.2	115.4	110.9	74.0	54.0	(F)	(F)	180	1.26
4924.00	-16.45	33.33	41.1	33.1	58.0	50.0	74.0	54.0	-16.0	-4.0	172	1.22
7386.00	-12.54	35.97	32.2	25.3	55.6	48.7	74.0	54.0	-18.4	-5.3	176	1.13
1072.25	-28.30	24.47	45.5	38.2	41.7	34.4	74.0	54.0	-32.3	-19.6	233	1.32
1748.00	-24.91	26.39	40.3	33.6	41.8	35.1	74.0	54.0	-32.2	-18.9	221	1.14
2691.50	-21.94	28.99	39.4	31.1	46.4	38.1	74.0	54.0	-27.6	-15.9	116	1.23

NOTE :

1. Measurement uncertainty is +/- 2.3dB.
2. "": The Peak reading value also meets average limit and measurement with the average detector is unnecessary.
3. Emission Level = Reading Value + Ant. Factor + Correct Factor (incl.:Cable Loss and Pre-Amplifier Gain)
4. The field strength of other emission frequencies were very low against the limit.
5. (F):The field strength of fundamental frequency.



TEST REPORT

Temperature:	31 °C	Humidity:	56 %RH
Tested By:	Shunm Wang	Tested Mode:	802.11 n(40M)
Frequency Range:	1 – 25GHz	Modulation Type:	OFDM
Receiver Detector:	PK. and AV.	Tested Channel:	CH 01
Tested Date:	Aug. 23, 2010		

Antenna Polarization : Horizontal

Frequency (MHz)	Correct Factor (dB)	Ant. Factor (dB/m)	Reading Data (dB μ V)		Emission Level (dB μ V/m)		Limit (dB μ V/m)		Margin (dB)		AZ (°)	EL (m)
			PK.	AV.	PK.	AV.	PK.	AV.	PK.	AV.		
2422.00	-22.63	28.14	113.8	110.5	119.3	116.0	74.0	54.0	(F)	(F)	180	1.37
4844.00	-16.61	33.16	43.1	34.9	59.6	51.4	74.0	54.0	-14.4	-2.6	173	1.24
7266.00	-12.68	35.73	33.7	26.1	56.8	49.2	74.0	54.0	-17.2	-4.8	186	1.16
1059.50	-28.37	24.44	39.2	33.4	35.3	29.5	74.0	54.0	-38.7	-24.5	219	1.23
1820.25	-24.62	26.65	42.5	39.5	44.5	41.5	74.0	54.0	-29.5	-12.5	106	1.31
2304.75	-22.99	27.91	33.4	28.6	38.3	33.5	74.0	54.0	-35.7	-20.5	214	1.23

Antenna Polarization : Vertical

Frequency (MHz)	Correct Factor (dB)	Ant. Factor (dB/m)	Reading Data (dB μ V)		Emission Level (dB μ V/m)		Limit (dB μ V/m)		Margin (dB)		AZ (°)	EL (m)
			PK.	AV.	PK.	AV.	PK.	AV.	PK.	AV.		
2422.00	-22.63	28.14	108.7	105.8	114.2	111.3	74.0	54.0	(F)	(F)	183	1.24
4844.00	-16.61	33.16	39.4	32.1	55.9	48.6	74.0	54.0	-18.1	-5.4	169	1.23
7266.00	-12.68	35.73	30.5	23.4	53.6	46.5	74.0	54.0	-20.4	-7.5	174	1.09
1072.25	-28.30	24.47	45.7	38.6	41.9	34.8	74.0	54.0	-32.1	-19.2	230	1.32
1748.00	-24.91	26.39	40.1	33.8	41.6	35.3	74.0	54.0	-32.4	-18.7	219	1.15
2691.50	-21.94	28.99	39.5	32.1	46.5	39.1	74.0	54.0	-27.5	-14.9	104	1.24

NOTE :

1. Measurement uncertainty is +/- 2.3dB.
2. "": The Peak reading value also meets average limit and measurement with the average detector is unnecessary.
3. Emission Level = Reading Value + Ant. Factor + Correct Factor (incl.:Cable Loss and Pre-Amplifier Gain)
4. The field strength of other emission frequencies were very low against the limit.
5. (F):The field strength of fundamental frequency.



TEST REPORT

Temperature:	31 °C	Humidity:	56 %RH
Tested By:	Shunm Wang	Tested Mode:	802.11 n(40M)
Frequency Range:	1 – 25GHz	Modulation Type:	OFDM
Receiver Detector:	PK. and AV.	Tested Channel:	CH 04
Tested Date:	Aug. 23, 2010		

Antenna Polarization : Horizontal

Frequency (MHz)	Correct Factor (dB)	Ant. Factor (dB/m)	Reading Data (dBμV)		Emission Level (dBμV/m)		Limit (dBμV/m)		Margin (dB)		AZ (°)	EL (m)
			PK.	AV.	PK.	AV.	PK.	AV.	PK.	AV.		
2437.00	-22.59	28.17	104.3	101.4	109.9	106.9	74.0	54.0	(F)	(F)	173	1.35
4874.00	-16.55	33.22	40.5	33.1	57.2	49.8	74.0	54.0	-16.8	-4.2	182	1.24
7311.00	-12.63	35.82	32.9	24.8	56.1	48.0	74.0	54.0	-17.9	-6.0	190	1.18
1059.50	-28.37	24.44	39.1	33.5	35.2	29.6	74.0	54.0	-38.8	-24.4	206	1.24
1820.25	-24.62	26.65	42.4	39.2	44.4	41.2	74.0	54.0	-29.6	-12.8	116	1.32
2304.75	-22.99	27.91	33.2	28.3	38.1	33.2	74.0	54.0	-35.9	-20.8	201	1.24

Antenna Polarization : Vertical

Frequency (MHz)	Correct Factor (dB)	Ant. Factor (dB/m)	Reading Data (dBμV)		Emission Level (dBμV/m)		Limit (dBμV/m)		Margin (dB)		AZ (°)	EL (m)
			PK.	AV.	PK.	AV.	PK.	AV.	PK.	AV.		
2437.00	-22.59	28.17	115.4	112.9	121.0	118.5	74.0	54.0	(F)	(F)	186	1.24
4874.00	-16.55	33.22	42.5	34.2	59.2	50.9	74.0	54.0	-14.8	-3.1	171	1.22
7311.00	-12.63	35.82	33.9	26.1	57.1	49.3	74.0	54.0	-16.9	-4.7	169	1.13
1072.25	-28.30	24.47	45.8	38.5	42.0	34.7	74.0	54.0	-32.0	-19.3	229	1.32
1748.00	-24.91	26.39	40.2	33.1	41.7	34.6	74.0	54.0	-32.3	-19.4	231	1.12
2691.50	-21.94	28.99	39.4	32.0	46.4	39.0	74.0	54.0	-27.6	-15.0	103	1.24

NOTE :

1. Measurement uncertainty is +/- 2.3dB.
2. "": The Peak reading value also meets average limit and measurement with the average detector is unnecessary.
3. Emission Level = Reading Value + Ant. Factor + Correct Factor (incl.:Cable Loss and Pre-Amplifier Gain)
4. The field strength of other emission frequencies were very low against the limit.
5. (F):The field strength of fundamental frequency.



TEST REPORT

Temperature:	31 °C	Humidity:	56 %RH
Tested By:	Shunm Wang	Tested Mode:	802.11 n(40M)
Frequency Range:	1 – 25GHz	Modulation Type:	OFDM
Receiver Detector:	PK. and AV.	Tested Channel:	CH 07
Tested Date:	Aug. 23, 2010		

Antenna Polarization : Horizontal

Frequency (MHz)	Correct Factor (dB)	Ant. Factor (dB/m)	Reading Data (dBμV)		Emission Level (dBμV/m)		Limit (dBμV/m)		Margin (dB)		AZ (°)	EL (m)
			PK.	AV.	PK.	AV.	PK.	AV.	PK.	AV.		
2452.00	-22.54	28.20	116.0	114.1	121.7	119.8	74.0	54.0	(F)	(F)	180	1.35
4904.00	-16.49	33.29	42.5	34.9	59.3	51.7	74.0	54.0	-14.7	-2.3	171	1.24
7356.00	-12.57	35.91	32.2	24.9	55.5	48.2	74.0	54.0	-18.5	-5.8	192	1.16
1059.50	-28.37	24.44	39.5	32.4	35.6	28.5	74.0	54.0	-38.4	-25.5	219	1.22
1820.25	-24.62	26.65	42.7	39.5	44.7	41.5	74.0	54.0	-29.3	-12.5	121	1.33
2304.75	-22.99	27.91	33.7	28.9	38.6	33.8	74.0	54.0	-35.4	-20.2	212	1.24

Antenna Polarization : Vertical

Frequency (MHz)	Correct Factor (dB)	Ant. Factor (dB/m)	Reading Data (dBμV)		Emission Level (dBμV/m)		Limit (dBμV/m)		Margin (dB)		AZ (°)	EL (m)
			PK.	AV.	PK.	AV.	PK.	AV.	PK.	AV.		
2452.00	-22.54	28.20	113.5	110.2	119.2	115.9	74.0	54.0	(F)	(F)	183	1.25
4904.00	-16.49	33.29	42.2	33.8	59.0	50.6	74.0	54.0	-15.0	-3.4	175	1.23
7356.00	-12.57	35.91	33.5	26.4	56.8	49.7	74.0	54.0	-17.2	-4.3	179	1.14
1072.25	-28.30	24.47	45.4	38.1	41.6	34.3	74.0	54.0	-32.4	-19.7	228	1.31
1748.00	-24.91	26.39	40.6	33.9	42.1	35.4	74.0	54.0	-31.9	-18.6	223	1.15
2691.50	-21.94	28.99	39.5	32.1	46.5	39.1	74.0	54.0	-27.5	-14.9	112	1.22

NOTE :

1. Measurement uncertainty is +/- 2.3dB.
2. "": The Peak reading value also meets average limit and measurement with the average detector is unnecessary.
3. Emission Level = Reading Value + Ant. Factor + Correct Factor (incl.:Cable Loss and Pre-Amplifier Gain)
4. The field strength of other emission frequencies were very low against the limit.
5. (F):The field strength of fundamental frequency.



TEST REPORT

Temperature:	31 °C	Humidity:	56 %RH
Tested By:	Shunm Wang	Tested Mode:	RX
Frequency Range:	1 – 25GHz	Modulation Type:	NA
Receiver Detector:	PK. and AV.	Tested Channel:	NA
Tested Date:	Aug. 23, 2010		

Antenna Polarization : Horizontal

Frequency (MHz)	Correct Factor (dB)	Ant. Factor (dB/m)	Reading Data (dBμV)		Emission Level (dBμV/m)		Limit (dBμV/m)		Margin (dB)		AZ (°)	EL (m)
			PK.	AV.	PK.	AV.	PK.	AV.	PK.	AV.		
1093.50	-28.18	24.52	*	*	*	*	74.0	54.0	*	*	*	*
1119.00	-28.03	24.59	*	*	*	*	74.0	54.0	*	*	*	*
1820.25	-24.62	26.65	*	*	*	*	74.0	54.0	*	*	*	*
1909.50	-24.26	26.97	*	*	*	*	74.0	54.0	*	*	*	*
2632.02	-22.08	28.78	*	*	*	*	74.0	54.0	*	*	*	*
3059.15	-21.01	30.22	*	*	*	*	74.0	54.0	*	*	*	*

Antenna Polarization : Vertical

Frequency (MHz)	Correct Factor (dB)	Ant. Factor (dB/m)	Reading Data (dBμV)		Emission Level (dBμV/m)		Limit (dBμV/m)		Margin (dB)		AZ (°)	EL (m)
			PK.	AV.	PK.	AV.	PK.	AV.	PK.	AV.		
1042.50	-28.46	24.40	*	*	*	*	74.0	54.0	*	*	*	*
1191.25	-27.63	24.76	*	*	*	*	74.0	54.0	*	*	*	*
1789.25	-24.74	26.54	*	*	*	*	74.0	54.0	*	*	*	*
1820.25	-24.62	26.65	*	*	*	*	74.0	54.0	*	*	*	*
2653.25	-22.03	28.85	*	*	*	*	74.0	54.0	*	*	*	*
3115.20	-20.83	30.33	*	*	*	*	74.0	54.0	*	*	*	*

NOTE :

1. Measurement uncertainty is +/- 2.3dB.
2. "****": The Peak reading value also meets average limit and measurement with the average detector is unnecessary.
3. Emission Level = Reading Value + Ant. Factor + Correct Factor (incl.: Cable Loss and Pre-Amplifier Gain)
4. The field strength of other emission frequencies were very low against the limit.
5. (F): The field strength of fundamental frequency.



4.3 BANDWIDTH TEST

4.3.1 LIMIT

FCC Part15, Subpart C Section 15.247(2). The minimum 6dBm bandwidth shall be at least 500 kHz.

4.3.2 TEST EQUIPMENT

The following test equipment was used during the test:

EQUIPMENT/ FACILITIES	SPECIFICATIONS	MANUFACTURER	MODEL#/ SERIAL#	DUE DATE OF CAL. & CAL. CENTER
SPECTRUM	9K-40GHz	R&S	FSP40/ 100093	DEC. 2010 ETC

NOTE: The calibration interval of the above test equipment is one year and the calibrations are traceable to NML/ROC and NIST/USA.

4.3.3 TEST SET-UP

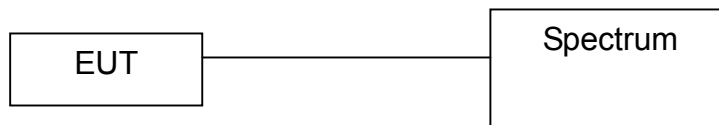

The EUT was connected to a spectrum through a 50Ω RF cable.

4.3.4 TEST PROCEDURE

The EUT was operated in continuous transmission mode on any specific channel. Printed out the test result from the spectrum by hard copy function.

4.3.5 EUT OPERATING CONDITION

1. Set the EUT under continuous transmission condition.
2. The EUT was set to the highest available power level.



4.3.6 TEST RESULT

Temperature:	24°C	Humidity:	55%RH
Spectrum Detector:	PK.	Tested Mode:	802.11 b
Tested By:	Shunm Wang	Modulation Type:	DSSS
Tested Date:	Aug. 20, 2010		

CHANNEL NUMBER	CHANNEL FREQUENCY (MHz)	6dB DOWN BW (MHz)
1	2412	10.05
6	2437	10.10
11	2462	10.10

CH1:

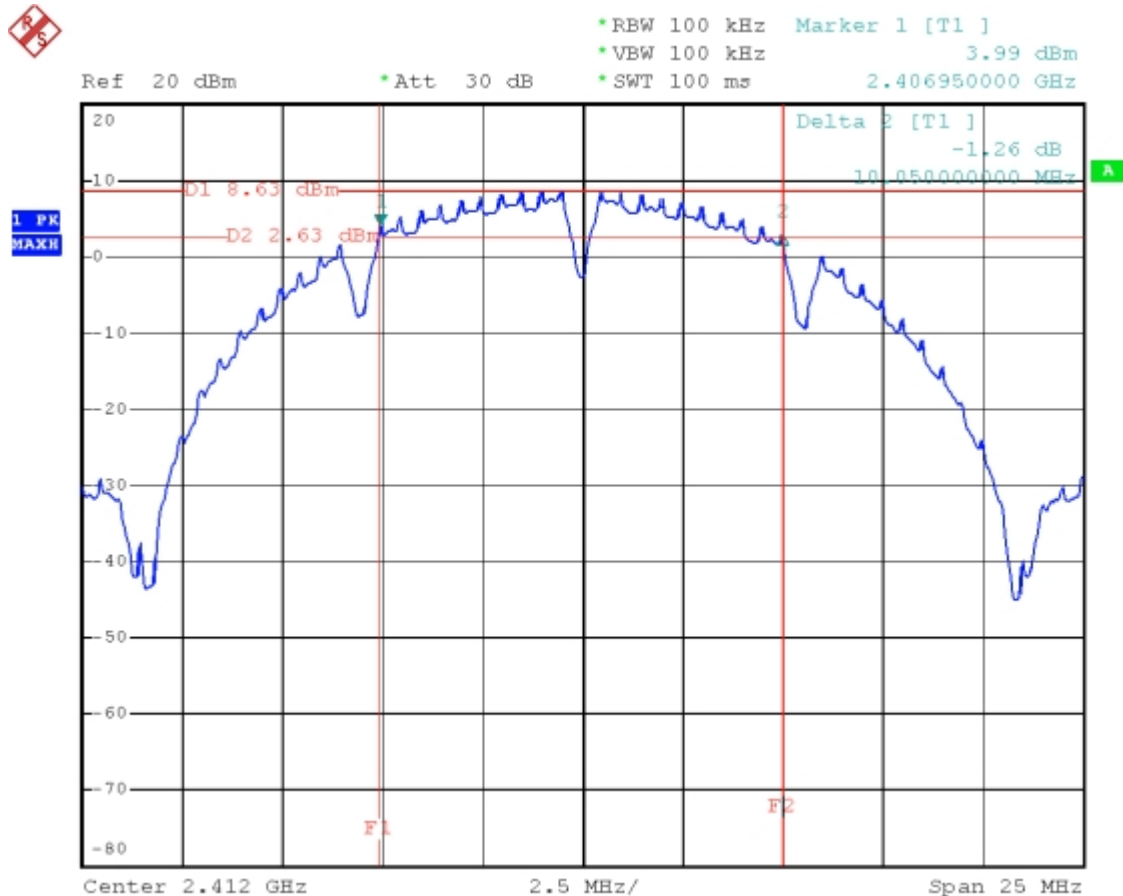



CH 6:

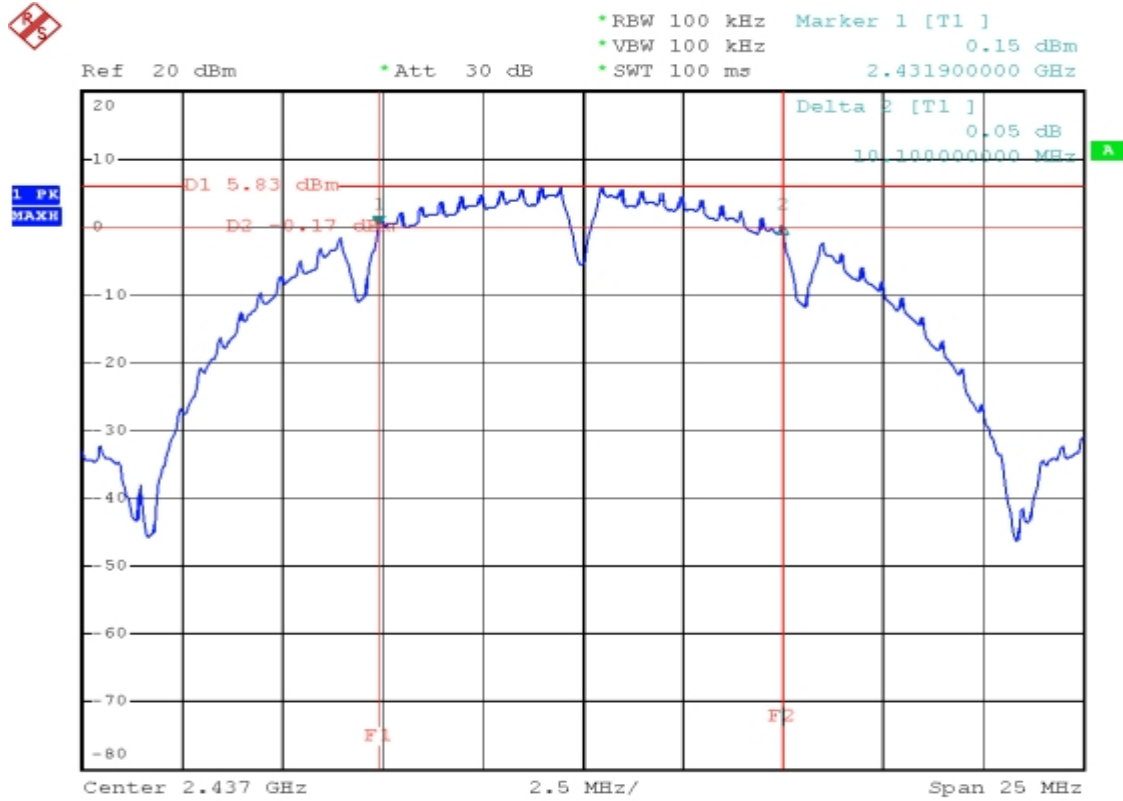

CH 11:

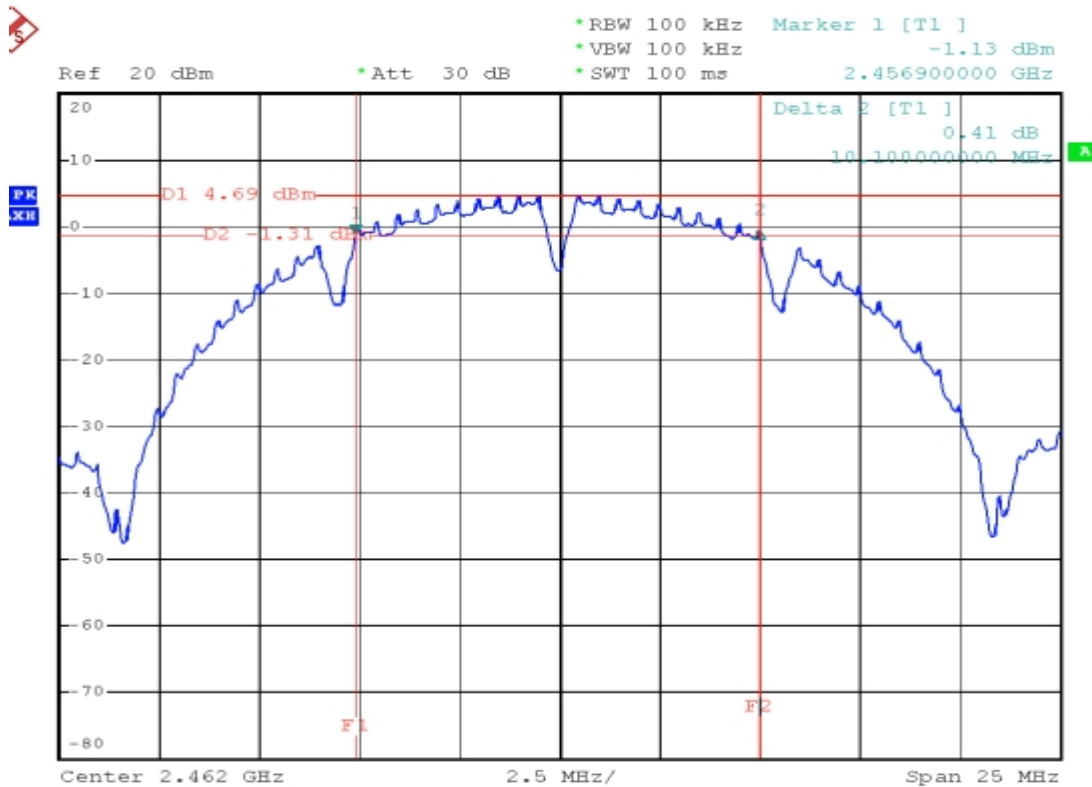



Spectrum Research & Testing Lab., Inc.
 No. 101-10, Ling 8,
 Shan-Tong Li, Chung-Li
 City, Taoyuan, Taiwan

TEST REPORT

Reference No.: A10082002
 Report No.: FCCA10082002
 FCC ID : VYTLP-9181A
 Page: 41 of 82
 Date: Aug. 25, 2010

Temperature:	<u>24°C</u>	Humidity:	<u>55%RH</u>
Spectrum Detector:	<u>PK.</u>	Tested Mode:	<u>802.11 g</u>
Tested By:	<u>Shunm Wang</u>	Modulation Type:	<u>OFDM</u>
Tested Date:	<u>Aug. 20, 2010</u>		

CHANNEL NUMBER	CHANNEL FREQUENCY (MHz)	6dB DOWN BW (MHz)
1	2412	16.45
6	2437	18.15
11	2462	15.50

CH1:

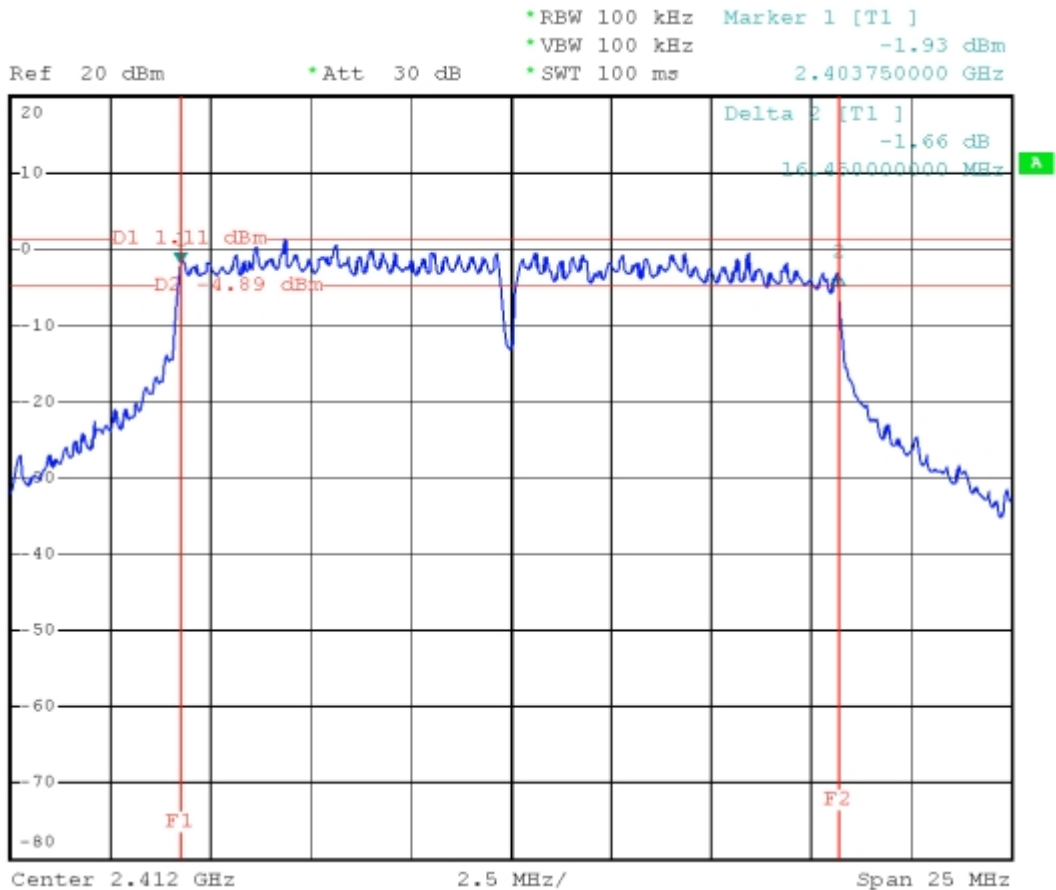



CH 6:

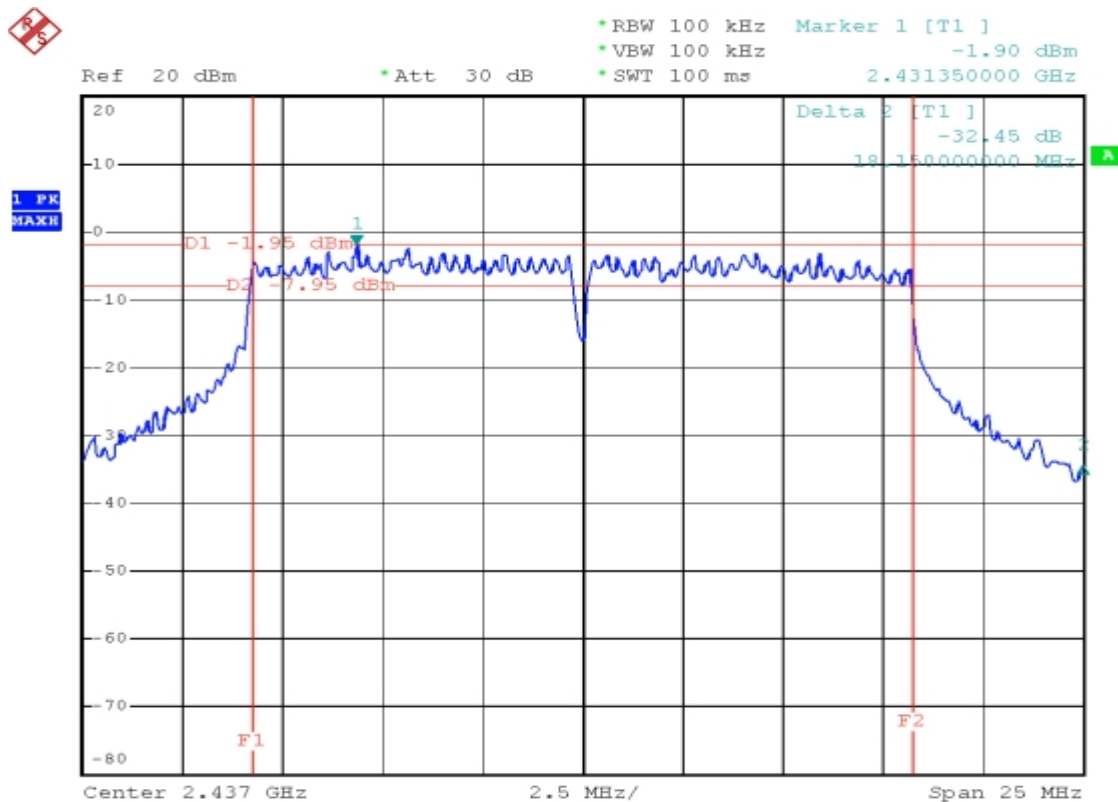

CH 11:

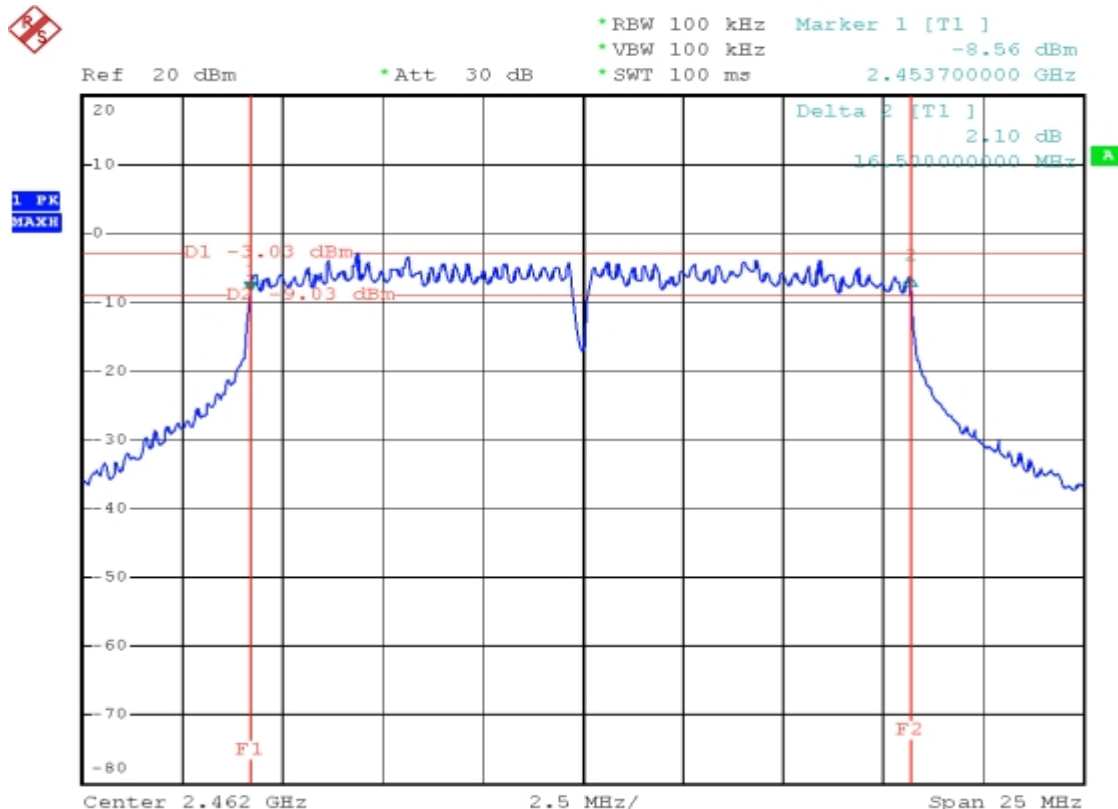



Spectrum Research & Testing Lab., Inc.
 No. 101-10, Ling 8,
 Shan-Tong Li, Chung-Li
 City, Taoyuan, Taiwan

TEST REPORT

Reference No.: A10082002
 Report No.: FCCA10082002
 FCC ID : VYTLP-9181A
 Page: 43 of 82
 Date: Aug. 25, 2010

Temperature:	<u>24°C</u>	Humidity:	<u>55%RH</u>
Spectrum Detector:	<u>PK.</u>	Tested Mode:	<u>802.11 n(20M)</u>
Tested By:	<u>Shunm Wang</u>	Modulation Type:	<u>OFDM</u>
Tested Date:	<u>Aug. 20, 2010</u>		

CHANNEL NUMBER	CHANNEL FREQUENCY (MHz)	6dB DOWN BW (MHz)
1	2412	17.75
6	2437	17.80
11	2462	17.75

CH1:

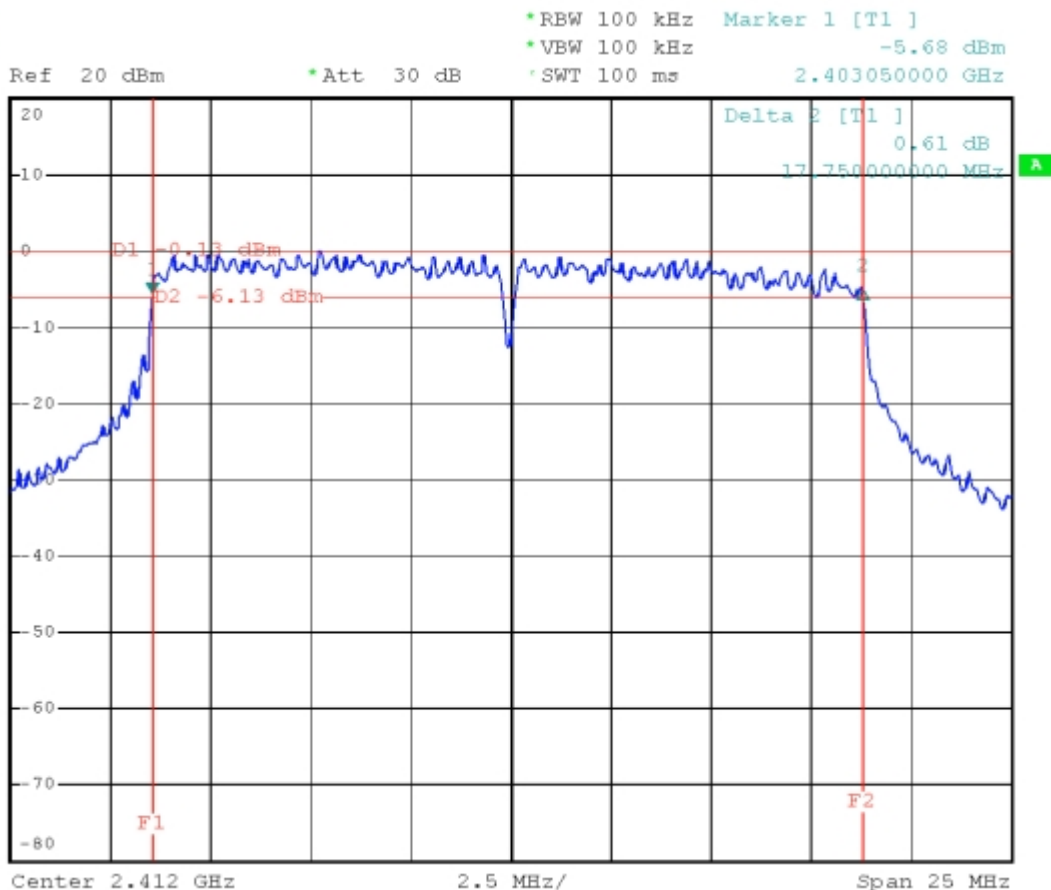



CH 6:

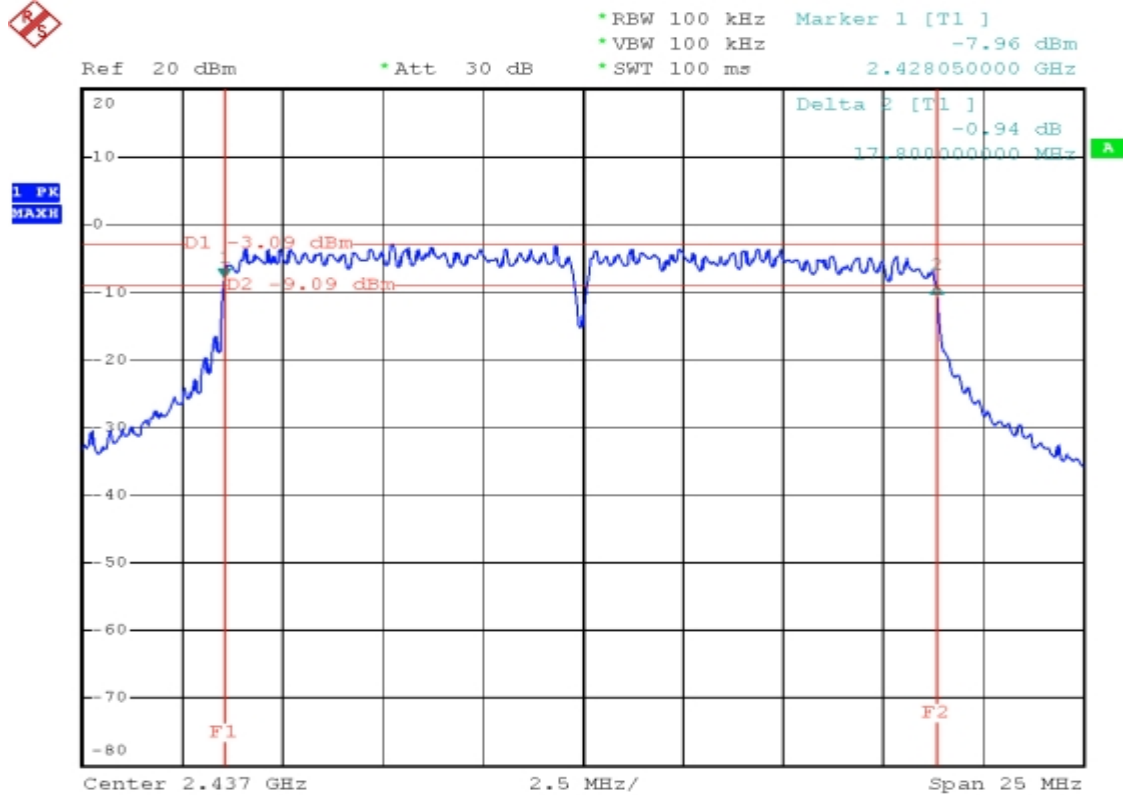

CH 11:

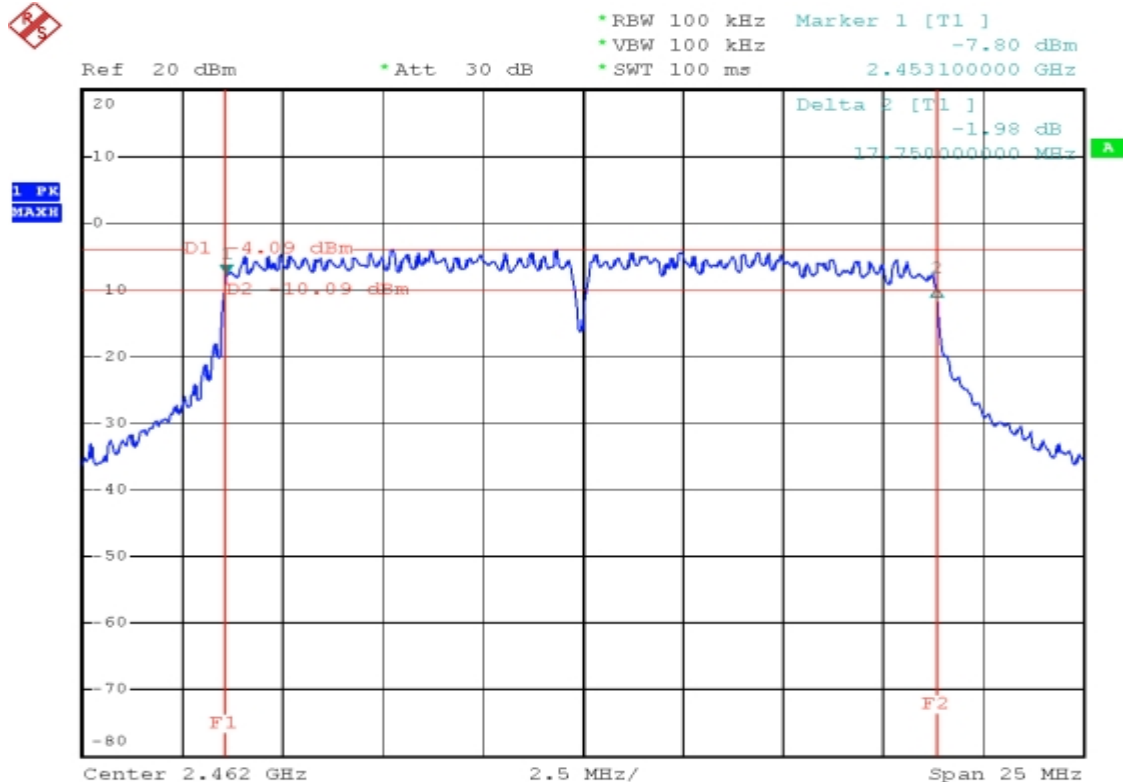



Spectrum Research & Testing Lab., Inc.
 No. 101-10, Ling 8,
 Shan-Tong Li, Chung-Li
 City, Taoyuan, Taiwan

TEST REPORT

Reference No.: A10082002
 Report No.: FCCA10082002
 FCC ID : VYTLP-9181A
 Page: 45 of 82
 Date: Aug. 25, 2010

Temperature:	<u>24°C</u>	Humidity:	<u>55%RH</u>
Spectrum Detector:	<u>PK.</u>	Tested Mode:	<u>802.11 n(40M)</u>
Tested By:	<u>Shunm Wang</u>	Modulation Type:	<u>OFDM</u>
Tested Date:	<u>Aug. 20, 2010</u>		

CHANNEL NUMBER	CHANNEL FREQUENCY (MHz)	6dB DOWN BW (MHz)
1	2422	36.50
4	2437	36.50
7	2452	36.40

CH1:

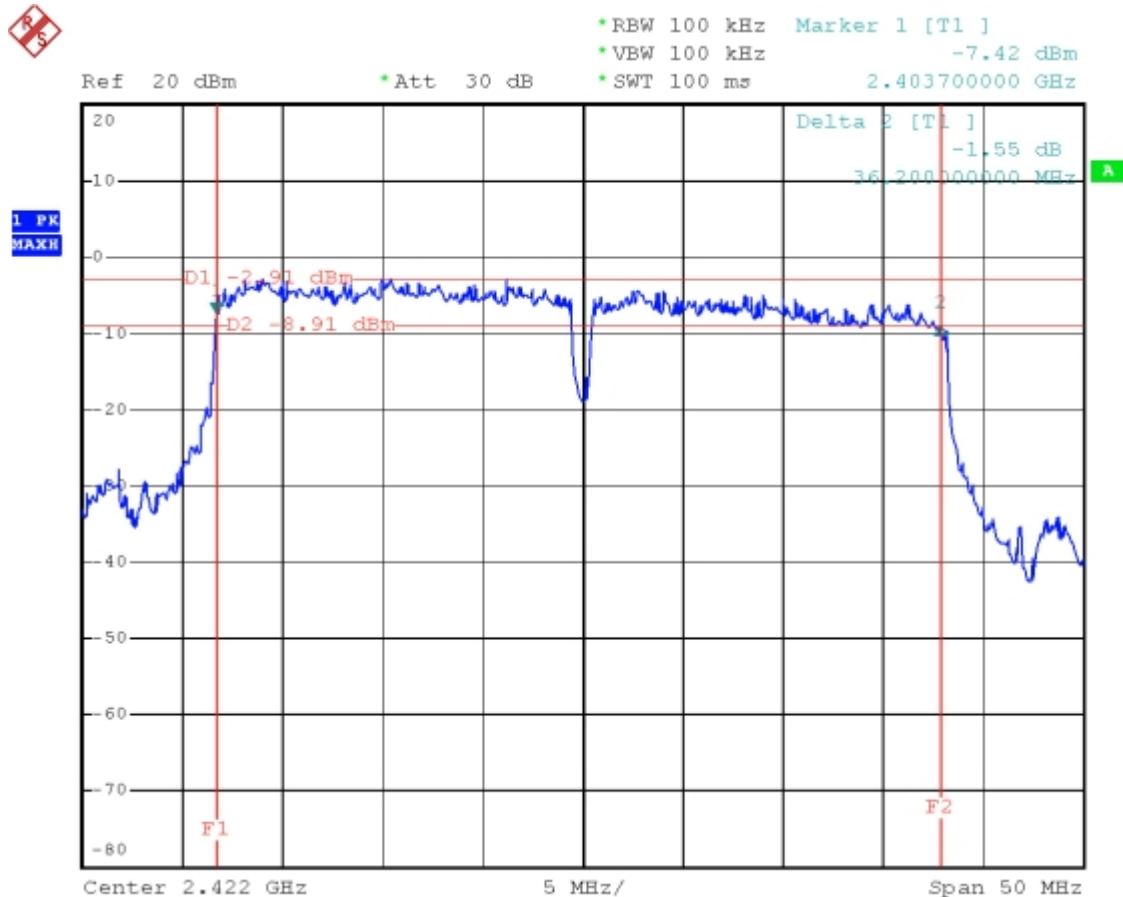



CH 4:

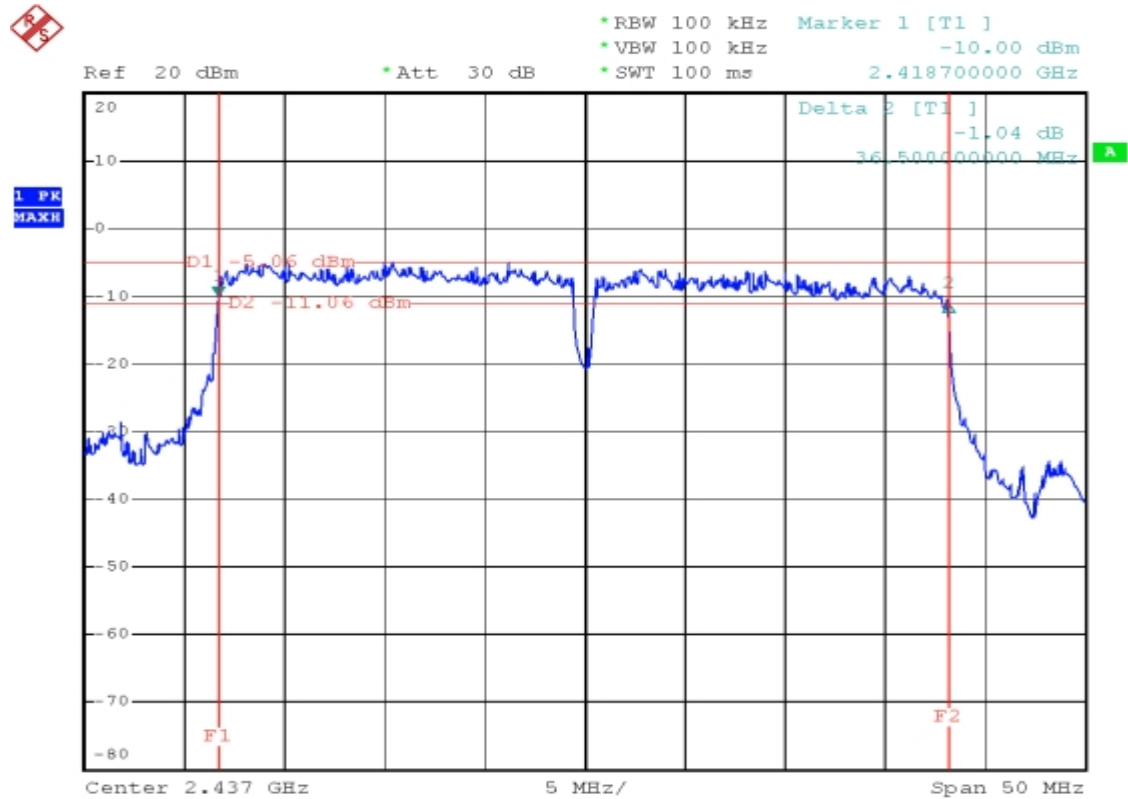

CH 7:

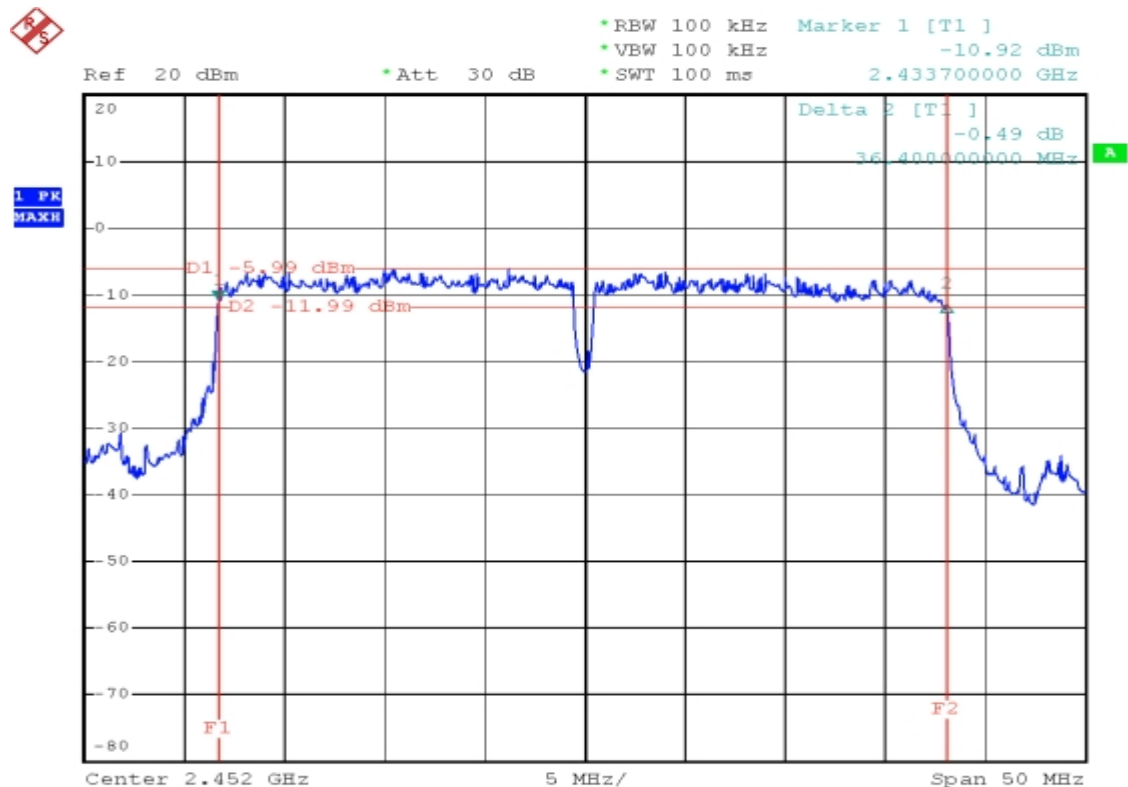



Spectrum Research & Testing Lab., Inc.
 No. 101-10, Ling 8,
 Shan-Tong Li, Chung-Li
 City, Taoyuan, Taiwan

TEST REPORT

Reference No.: A10082002
 Report No.: FCCA10082002
 FCC ID : VYTLP-9181A
 Page: 47 of 82
 Date: Aug. 25, 2010

4.4 PEAK POWER TEST

4.4.1 LIMIT FCC Part15, Subpart C Section 15.247.

Frequency Range (MHz)	Limit(w)				
	Quantity of Hopping Channel	50	25	15	75
902-928		1(30dBm)	0.125(21dBm)	NA	NA
2400-2483.5		NA	NA	0.125(21dBm)	1(30dBm)
5725-5850		NA	NA	NA	1(30dBm)

4.4.2 TEST EQUIPMENT

The following test equipment was used during the test:

EQUIPMENT/FACILITIES	SPECIFICATIONS	MANUFACTURER	MODEL#/SERIAL#	DUE DATE OF CAL. & CAL. CENTER
SPECTRUM	9K-40GHz	R&S	FSP40/ 100093	DEC. 2010 ETC
POWER METER	N/A	BOOTON	4532 77601	NOV. 2010 ETC
POWER SENSOR	DC-18GHz 0.3 μW-100mW 50 Ω	BOOTON	51011-EMC 31184	NOV. 2010 ETC

NOTE: The calibration interval of the above test equipment is one year and the calibrations are traceable to NML/ROC and NIST/USA.



4.4.3 TEST SET-UP

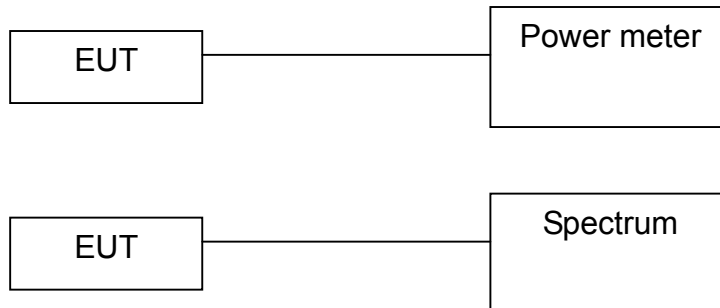

The EUT was connected to a spectrum through a 50Ω RF cable.

4.4.4 TEST PROCEDURE

The EUT was operating in continuous transmission mode or could control its channel. Printed out the test result from the spectrum by hard copy function. Recorded the read value of the power meter.

4.4.5 EUT OPERATING CONDITION

1. Set the EUT under continuous transmission condition.
2. The EUT was set to the highest available power level.



Spectrum Research & Testing Lab., Inc.
 No. 101-10, Ling 8,
 Shan-Tong Li, Chung-Li
 City, Taoyuan, Taiwan

TEST REPORT

Reference No.: A10082002
 Report No.: FCCA10082002
 FCC ID : VYTLP-9181A
 Page: 49 of 82
 Date: Aug. 25, 2010

4.4.6 TEST RESULT

Temperature:	<u>24°C</u>	Humidity:	<u>55%RH</u>
Spectrum Detector:	<u>PK.</u>	Tested Mode:	<u>802.11 b</u>
Tested By:	<u>Shunm Wang</u>	Modulation Type:	<u>DSSS</u>
Tested Date:	<u>Aug. 20, 2010</u>		

Channel Number	Channel Frequency (MHz)	Peak Output Power (dBm)	Peak Power Limit (dBm)
1	2412	26.05	30
6	2437	23.90	30
11	2462	21.17	30

CH1 :





CH6 :



CH11 :

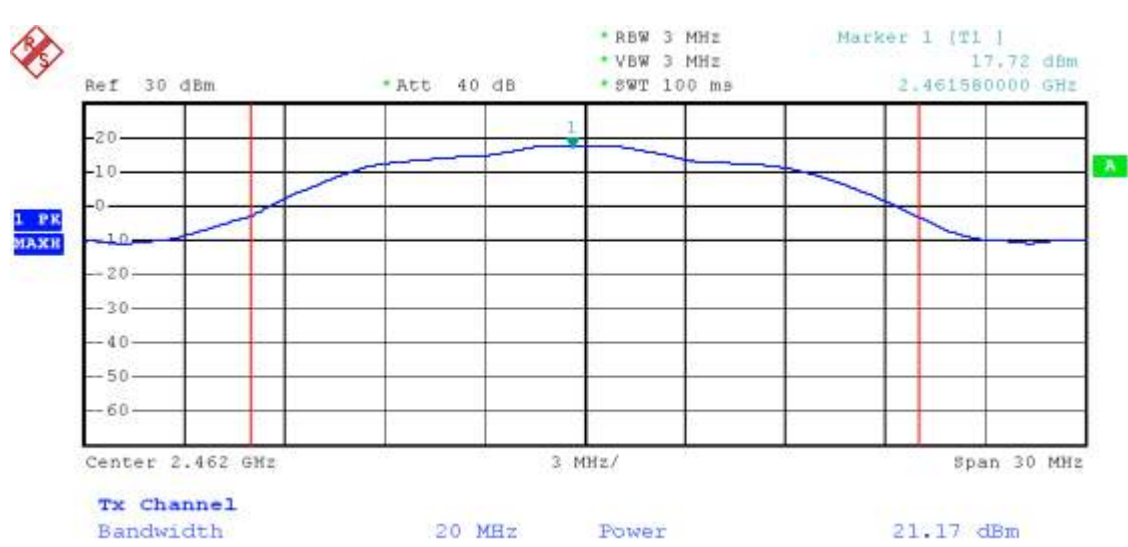



Spectrum Research & Testing Lab., Inc.
 No. 101-10, Ling 8,
 Shan-Tong Li, Chung-Li
 City, Taoyuan, Taiwan

TEST REPORT

Reference No.: A10082002
 Report No.: FCCA10082002
 FCC ID : VYTLP-9181A
 Page: 51 of 82
 Date: Aug. 25, 2010

Temperature:	<u>24°C</u>	Humidity:	<u>55%RH</u>
Spectrum Detector:	<u>PK.</u>	Tested Mode:	<u>802.11 g</u>
Tested By:	<u>Shunm Wang</u>	Modulation Type:	<u>OFDM</u>
Tested Date:	<u>Aug. 20, 2010</u>		

Channel Number	Channel Frequency (MHz)	Peak Output Power (dBm)	Peak Power Limit (dBm)
1	2412	25.93	30
6	2437	23.23	30
11	2462	21.46	30

CH1 :

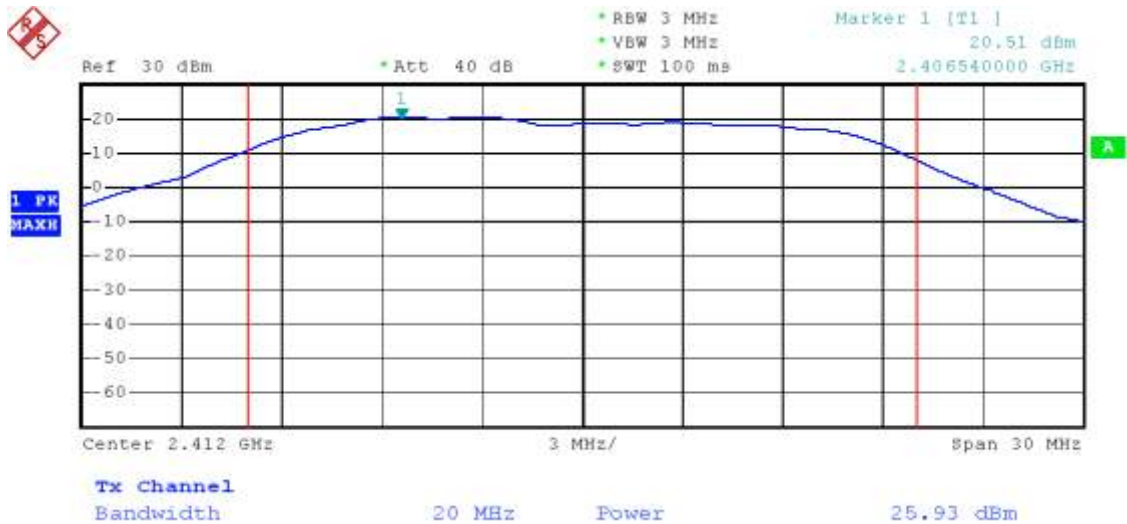



CH6 :

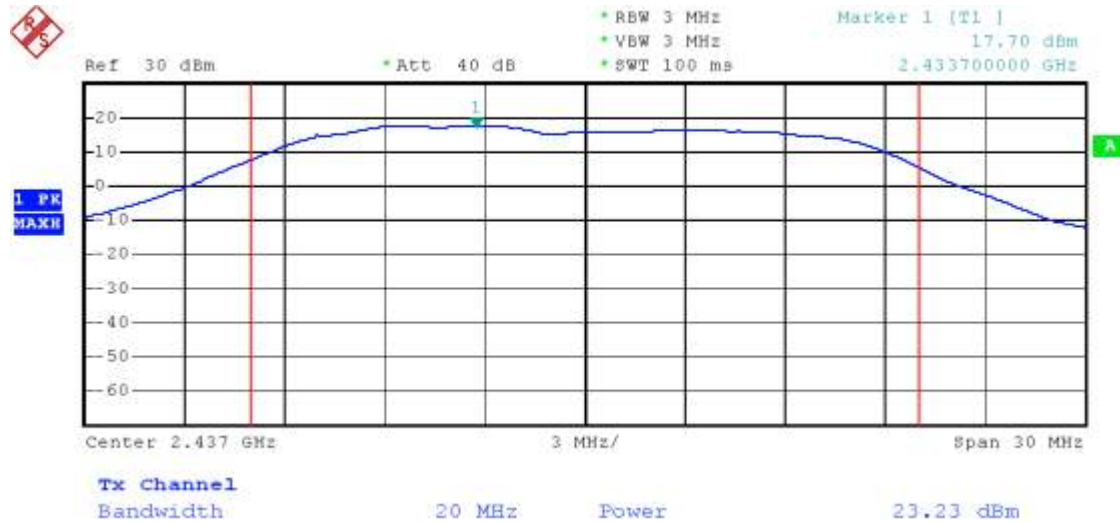

CH11 :

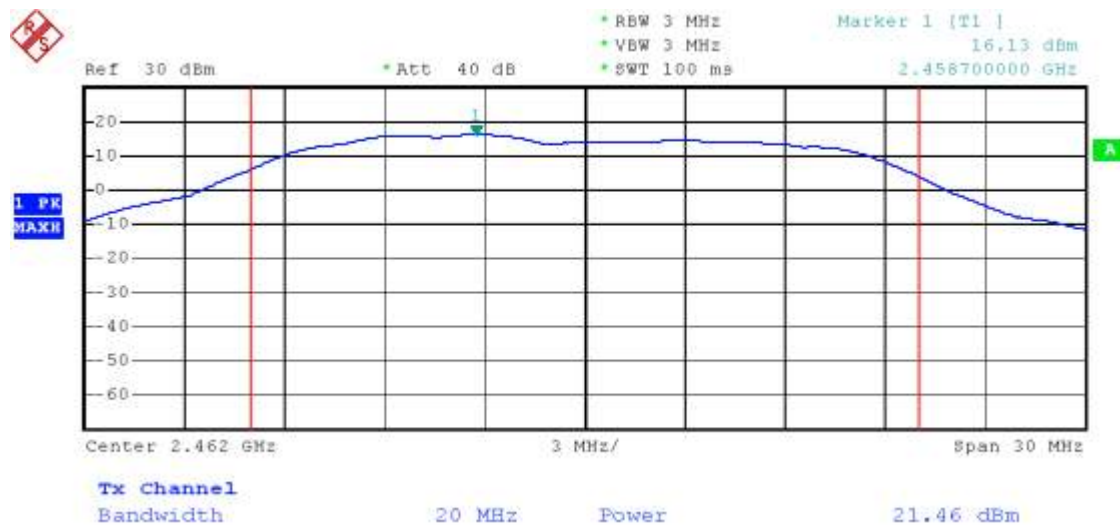



Spectrum Research & Testing Lab., Inc.
 No. 101-10, Ling 8,
 Shan-Tong Li, Chung-Li
 City, Taoyuan, Taiwan

TEST REPORT

Reference No.: A10082002
 Report No.: FCCA10082002
 FCC ID : VYTLP-9181A
 Page: 53 of 82
 Date: Aug. 25, 2010

Temperature:	<u>24°C</u>	Humidity:	<u>55%RH</u>
Spectrum Detector:	<u>PK.</u>	Tested Mode:	<u>802.11 n (20M)</u>
Tested By:	<u>Shunm Wang</u>	Modulation Type:	<u>OFDM</u>
Tested Date:	<u>Aug. 20, 2010</u>		

Channel Number	Channel Frequency (MHz)	Peak Output Power (dBm)	Peak Power Limit (dBm)
1	2412	25.72	30
6	2437	22.84	30
11	2462	20.85	30

CH1 :

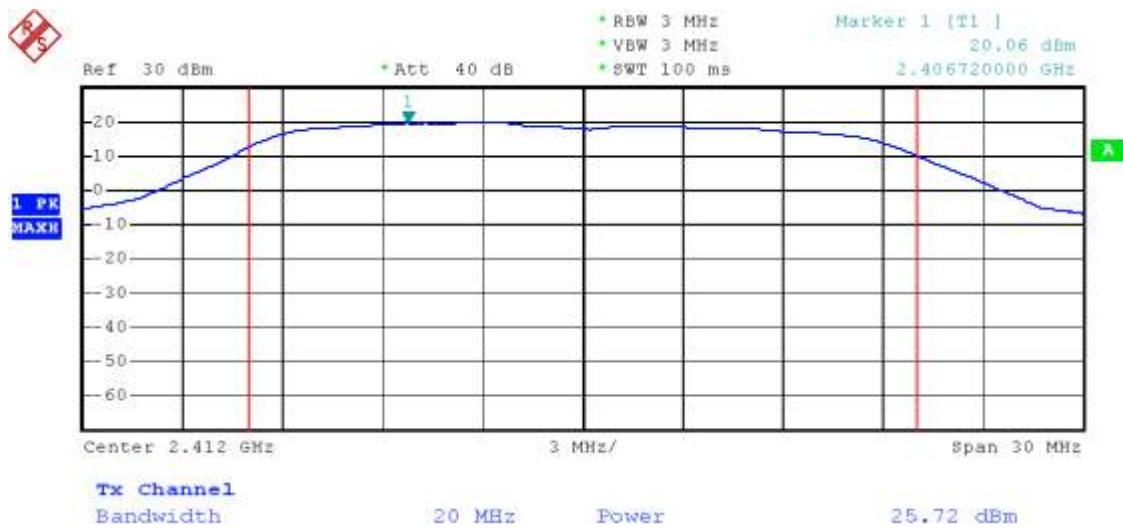



CH6 :

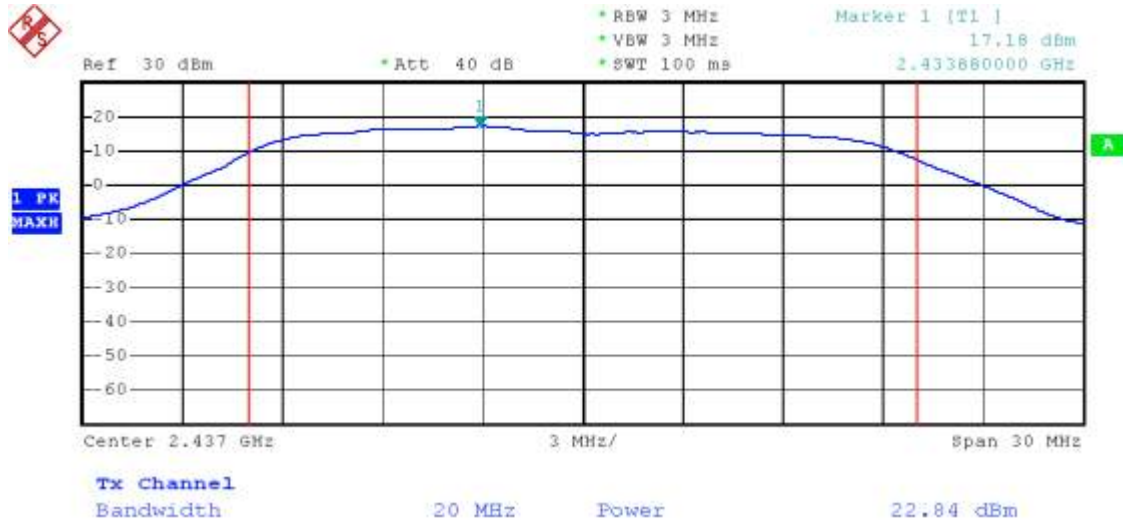

CH11 :

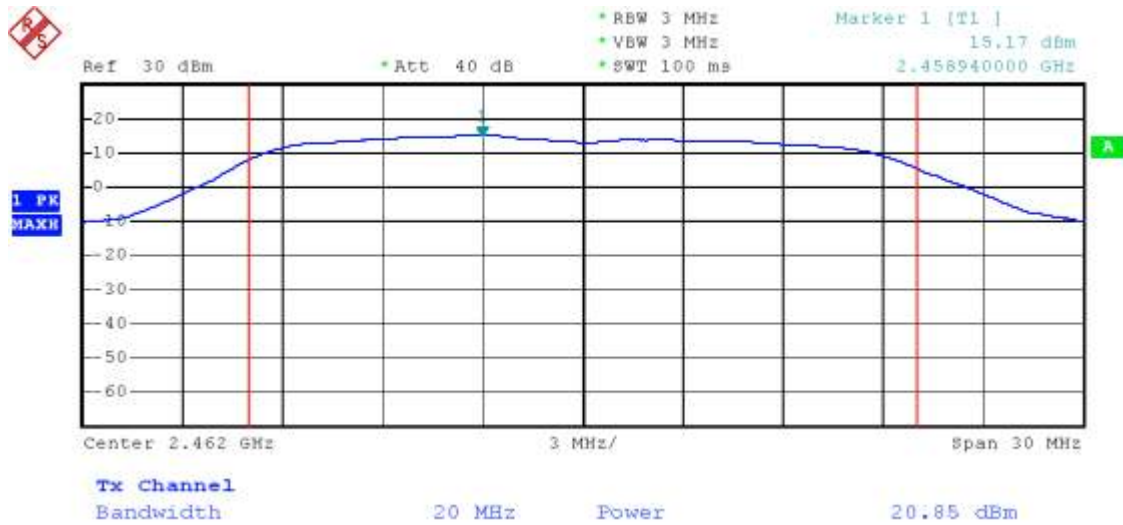



Spectrum Research & Testing Lab., Inc.
 No. 101-10, Ling 8,
 Shan-Tong Li, Chung-Li
 City, Taoyuan, Taiwan

TEST REPORT

Reference No.: A10082002
 Report No.: FCCA10082002
 FCC ID : VYTLP-9181A
 Page:55 of 82
 Date: Aug. 25, 2010

Temperature:	<u>24°C</u>	Humidity:	<u>55%RH</u>
Spectrum Detector:	<u>PK.</u>	Tested Mode:	<u>802.11 n (40M)</u>
Tested By:	<u>Shunm Wang</u>	Modulation Type:	<u>OFDM</u>
Tested Date:	<u>Aug. 20, 2010</u>		

Channel Number	Channel Frequency (MHz)	Peak Output Power (dBm)	Peak Power Limit (dBm)
1	2412	24.15	30
4	2437	22.41	30
7	2462	21.27	30

CH1 :

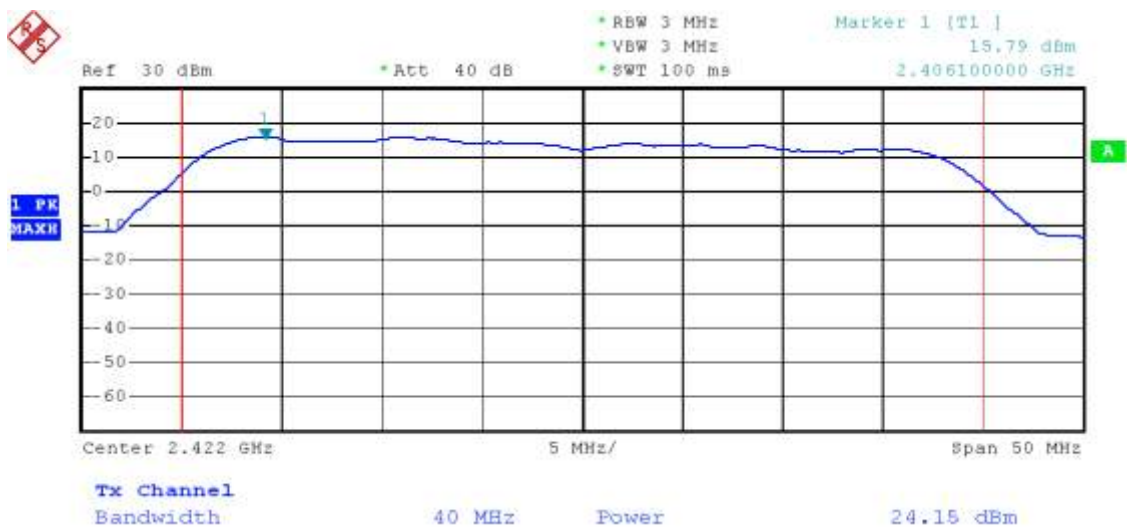



CH4 :

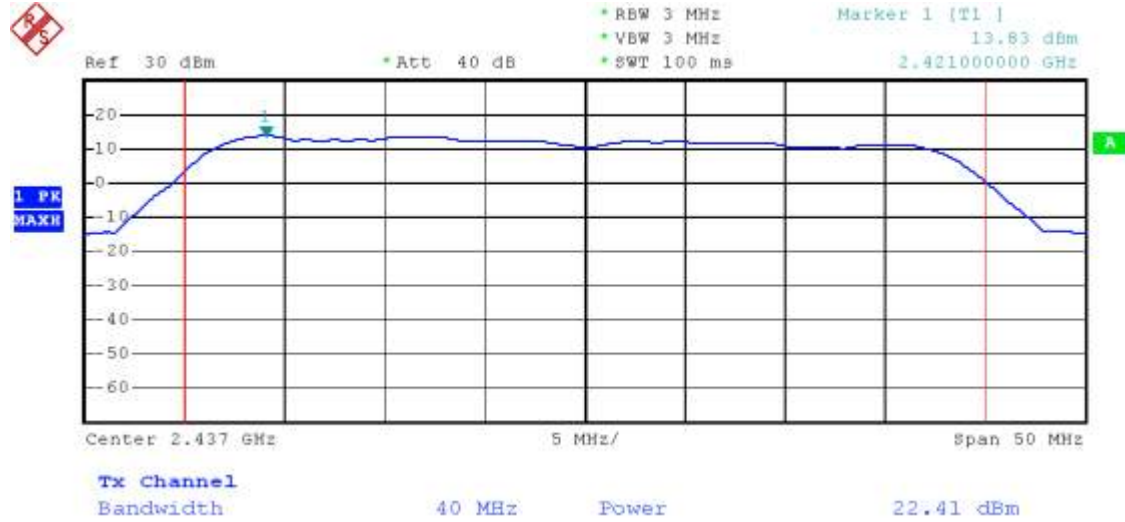

CH7 :

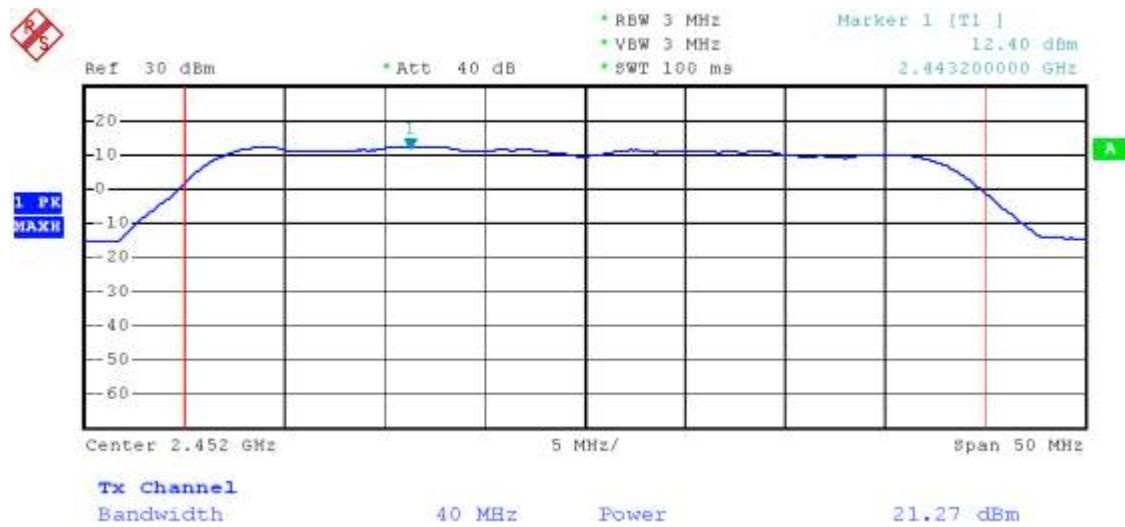



4.5 BAND EDGE TEST

4.5.1 LIMIT

FCC Part15, Subpart C Section 15.247. In any 100 kHz bandwidth outside the frequency band in which the spread spectrum intentional radiator is operating, the radio frequency power that is produced by the intentional radiator shall be at least 20 dB below that in the 100 kHz bandwidth within the band that contains the highest level of the desired power, based on either an RF conducted or a radiated measurement.

Attenuation below the general limits specified in Section 15.209(a) is not required. In addition, radiated emissions which fall in the restricted bands, as defined in Section 15.205(a), must also comply with the radiated emission limits specified in Section 15.209(a) (see Section 15.205(c)).

OPERATING FREQUENCY RANGE (MHz)	SPURIOUS EMISSION FREQUENCY (MHz)	LIMIT	
		Peak power ration to emission(dBc)	Emission level(dBuV/m)
902 - 928	<902	>20	NA
	>928	>20	NA
	960-1240	NA	54
2400 - 2483.5	<2400	>20	NA
	>2483.5-2500	NA	54
5725 - 5850	<5350-5460	NA	54
	<5725	>20	NA
	>5850	>20	NA



Spectrum Research & Testing Lab., Inc.
No. 101-10, Ling 8,
Shan-Tong Li, Chung-Li
City, Taoyuan, Taiwan

TEST REPORT

Reference No.: A10082002
Report No.: FCCA10082002
FCC ID : VYTLP-9181A
Page: 58 of 82
Date: Aug. 25, 2010

4.5.2 TEST EQUIPMENT

The following test equipment was used during the test:

EQUIPMENT/ FACILITIES	SPECIFICATIONS	MANUFACTURER	MODEL#/ SERIAL#	DUE DATE OF CAL. & CAL. CENTER
SPECTRUM	9K-40GHz	R&S	FSP40/ 100093	DEC. 2010 ETC
PRE-AMPLIFIER	1 GHz TO 26.5 GHz	HP	8449B/ 3008A01995	JAN. 2011 ETC
HORN ANTENNA	1 GHz TO 18 GHz	EMCO	3115/ 6881	NOV. 2010 ETC
K-TYPE CABLE	15M	HUBER SUHNER	SF 102-40/2*11/ 23932/2	MAY. 2011 ETC
K-TYPE CABLE	1M	HUBER SUHNER	SF 102-40/2*11/ 23934/2	NOV. 2010 ETC

NOTE: The calibration interval of the above test equipment is one year and the calibrations are traceable to NML/ROC and NIST/USA.



4.5.3 TEST SET-UP

FOR RF CONDUCTED TEST (dBc)

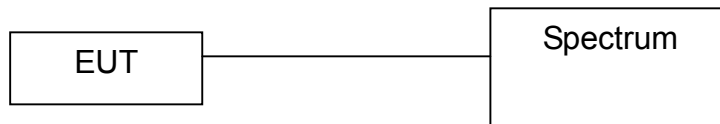

The EUT was connected to a spectrum through a 50Ω RF cable.

FOR RADIATED EMISSION TEST

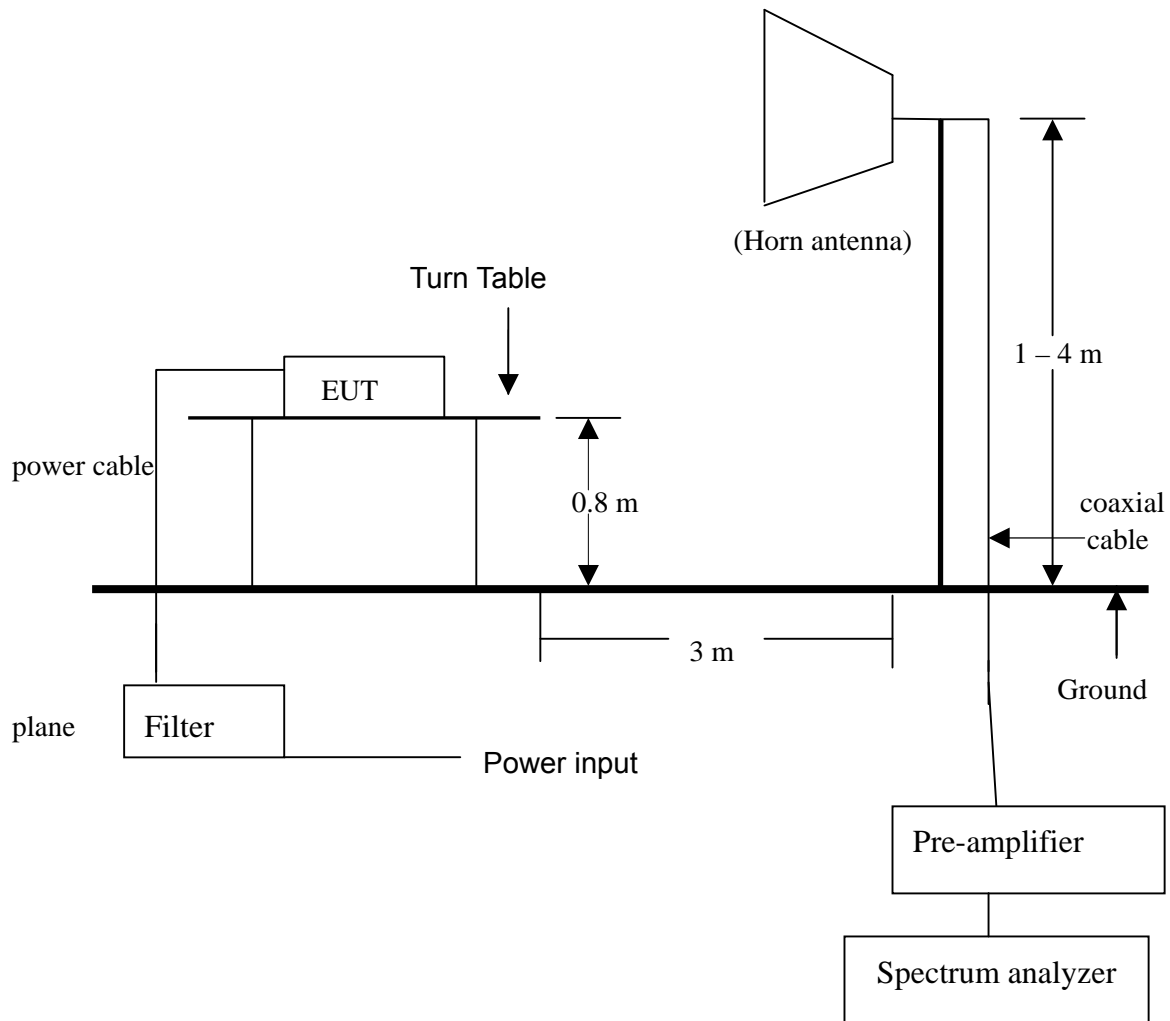

NOTE :

1. The EUT system was put on a wooden table with 0.8m heights above a ground plane.
2. For the actual test configuration, please refer to the photos of testing.



4.5.4 TEST PROCEDURE

1. The EUT was operating in continuous transmission mode or could be controlled its channel. Printed out the test result from the spectrum by hard copy function.
2. The EUT was tested according to the requirement of ANSI C63.4 and CISPR 22. The measurements were made at an open area test site with 3 meter measurement distance under 1 GHz and with 3m distance above 1GHz. The frequency spectrum measured started from 30 MHz. Under 1 GHz. All readings were quasi-peak values with 120 kHz resolution bandwidth of the test receiver. Above 1 GHz, the measurements were made at an open area test site with 3 meter measurement distance and all readings were peak and average values with 1 MHz resolution bandwidth of the test receiver. The EUT system was operated in all typical methods by users. The cables connected to EUT and support units were moved to find the maximum emission levels for each frequency.

4.5.5 EUT OPERATING CONDITION

1. Set the EUT under continuous transmission condition.
2. The EUT was set to the highest available power level.



4.5.6 TEST RESULT

Temperature:	<u>24°C</u>	Humidity:	<u>55%RH</u>
Spectrum Detector:	<u>PK. and AV.</u>	Tested Mode:	<u>802.11 b</u>
Tested By:	<u>Shunm Wang</u>	Modulation Type:	<u>DSSS</u>
Tested Date:	<u>Aug. 20, 2010</u>		

1. Conducted test

Frequency (MHz)	PEAK POWER OUTPUT (dBm)	Emission read Value(dBm)	Result of Band edge (dBc)	Band edge LIMIT (dBc)
<2.3999	8.62	-29.36	37.98	>20dBc
>2.4835	4.70	-48.78	53.48	>20dBc

2. Radiated emission test

Frequency (MHz)	Correct Factor (dB)	Ant. Fac. (dB)	Ant. Pol. (H/V)	Reading (dBuV)		Emission (dBuV/m)		Limit Line (dBuV/m)		Over Limit (dBuV/m)	
				PK	AV	PK	AV	PK	AV	PK	AV
2390.00	-22.73	28.08	H	48.6	37.5	54.0	42.9	74.0	54.0	-20.1	-11.2
2386.80	-22.74	28.07	H	52.3	41.5	57.6	46.8	74.0	54.0	-16.4	-7.2
2483.50	-22.45	28.27	H	49.1	38.3	54.9	44.1	74.0	54.0	-19.1	-9.9
2500.00	-22.40	28.30	H	53.5	42.8	59.4	48.7	74.0	54.0	-14.6	-5.3
2390.00	-22.73	28.08	V	49.1	37.9	54.5	43.3	74.0	54.0	-19.6	-10.8
2386.80	-22.74	28.07	V	52.9	42.1	58.2	47.4	74.0	54.0	-15.8	-6.6
2483.50	-22.45	28.27	V	49.8	38.7	55.6	44.5	74.0	54.0	-18.4	-9.5
2500.00	-22.40	28.30	V	55.1	43.2	61.0	49.1	74.0	54.0	-13.0	-4.9



CH1 :

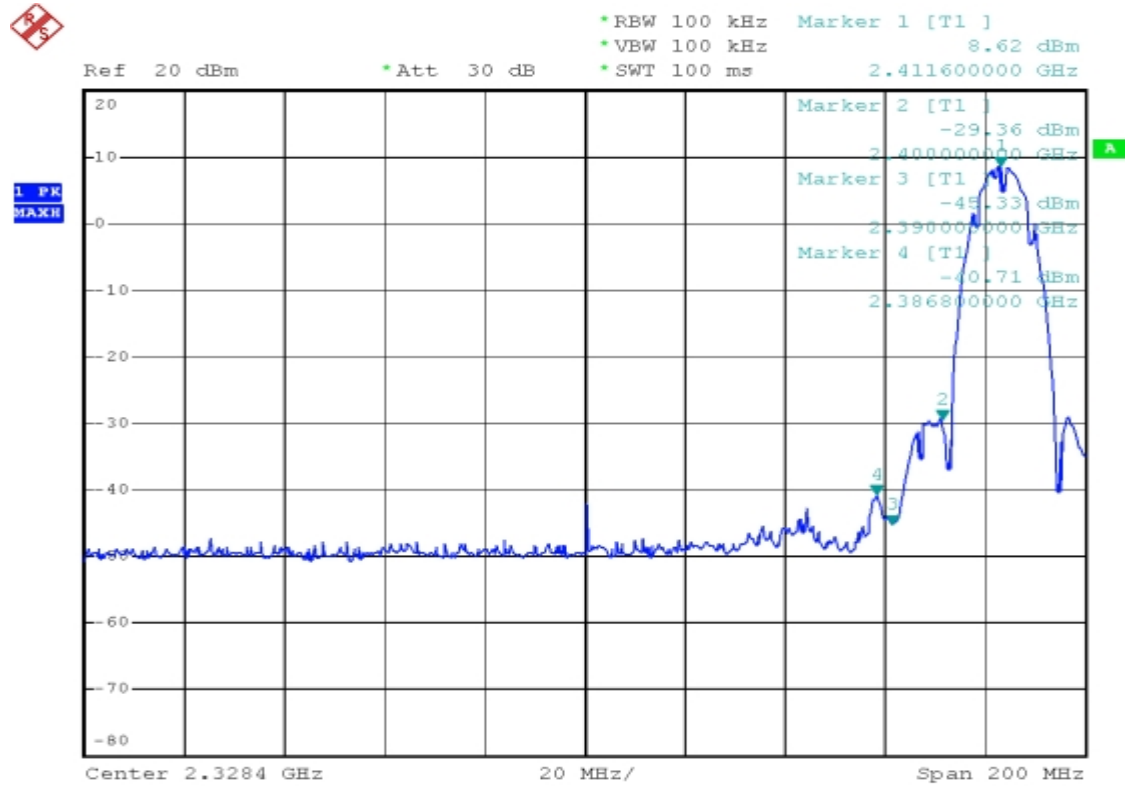

CH11:

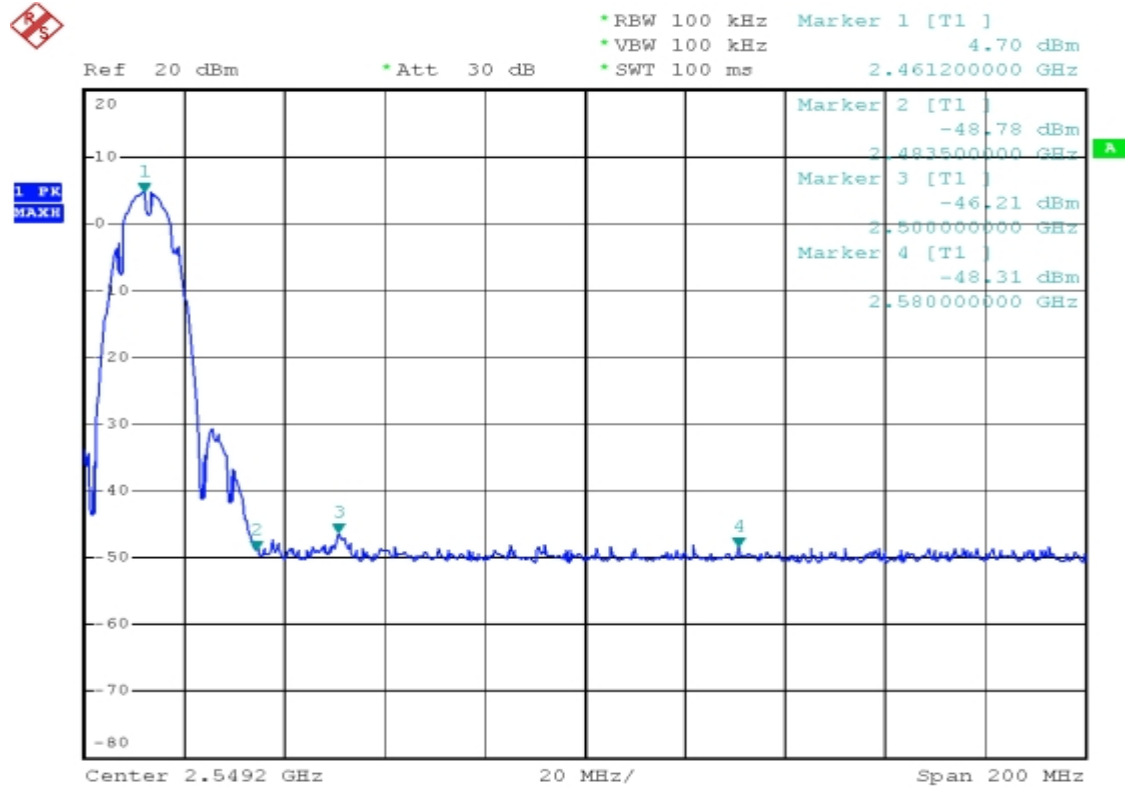



Spectrum Research & Testing Lab., Inc.
No. 101-10, Ling 8,
Shan-Tong Li, Chung-Li
City, Taoyuan, Taiwan

TEST REPORT

Reference No.: A10082002
Report No.: FCCA10082002
FCC ID : VYTLP-9181A
Page:63 of 82
Date: Aug. 25, 2010

Temperature:	<u>24°C</u>	Humidity:	<u>55%RH</u>
Spectrum Detector:	<u>PK. and AV.</u>	Tested Mode:	<u>802.11 g</u>
Tested By:	<u>Shunm Wang</u>	Modulation Type:	<u>OFDM</u>
Tested Date:	<u>Aug. 20, 2010</u>		

1. Conducted test

Frequency (MHz)	PEAK POWER OUTPUT (dBm)	Emission read Value(dBm)	Result of Band edge (dBc)	Band edge LIMIT (dBc)
<2.3999	0.91	-27.27	28.18	>20dBc
>2.4835	-3.10	-45.90	42.80	>20dBc

2. Radiated emission test

Frequency (MHz)	Correct Factor (dB)	Ant. Fac. (dB)	Ant. Pol. (H/V)	Reading (dBuV)		Emission (dBuV/m)		Limit Line (dBuV/m)		Over Limit (dBuV/m)	
				PK	AV	PK	AV	PK	AV	PK	AV
2390.00	-22.73	28.08	H	53.9	43.4	59.3	48.8	74.0	54.0	-14.8	-5.3
2358.40	-22.83	28.02	H	45.6	35.2	50.8	40.4	74.0	54.0	-23.2	-13.6
2483.50	-22.45	28.27	H	52.6	41.1	58.4	46.9	74.0	54.0	-15.6	-7.1
2492.80	-22.42	28.28	H	52.2	40.9	58.1	46.8	74.0	54.0	-15.9	-7.2
2390.00	-22.73	28.08	V	54.3	43.8	59.7	49.2	74.0	54.0	-14.4	-4.9
2386.80	-22.74	28.07	V	45.9	35.7	51.2	41.0	74.0	54.0	-22.8	-13.0
2483.50	-22.45	28.27	V	53.1	41.6	58.9	47.4	74.0	54.0	-15.1	-6.6
2500.00	-22.40	28.30	V	52.6	41.4	58.5	47.3	74.0	54.0	-15.5	-6.7



CH1 :

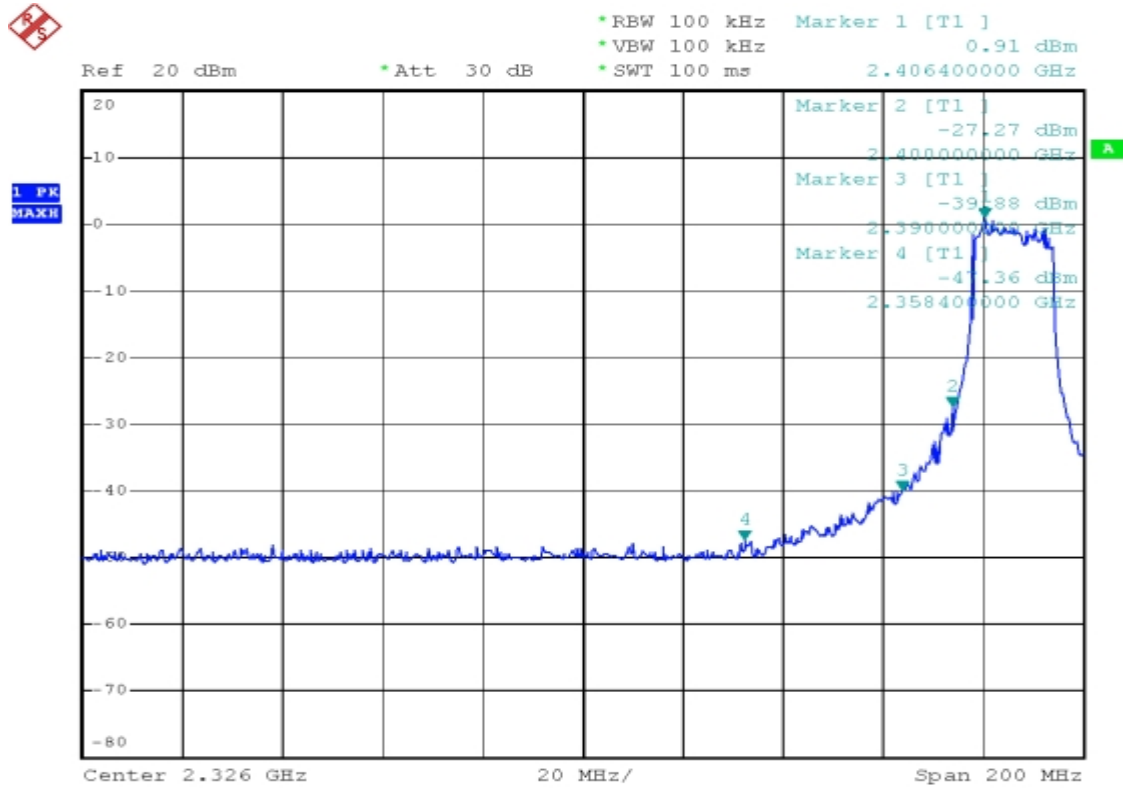

CH11:

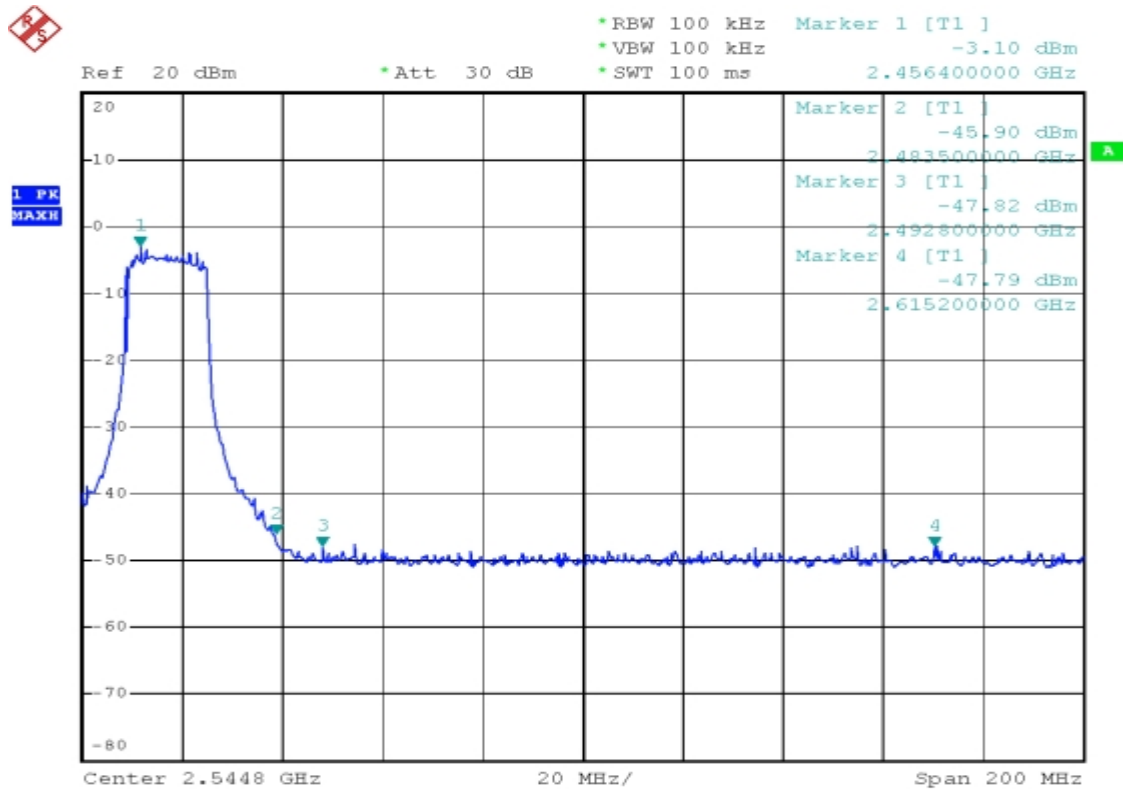



TEST REPORT

Temperature:	<u>24°C</u>	Humidity:	<u>55%RH</u>
Spectrum Detector:	<u>PK. andAV.</u>	Tested Mode:	<u>802.11 n (20M)</u>
Tested By:	<u>Shunm Wang</u>	Modulation Type:	<u>OFDM</u>
Tested Date:	<u>Aug. 20, 2010</u>		

1. Conducted test

Frequency (MHz)	PEAK POWER OUTPUT (dBm)	Emission read Value(dBm)	Result of Band edge (dBc)	Band edge LIMIT (dBc)
<2.3999	-0.40	-29.65	29.25	>20dBc
>2.4835	-3.87	-46.44	42.57	>20dBc

2. Radiated emission test

Frequency (MHz)	Correct Factor (dB)	Ant. Fac. (dB)	Ant. Pol. (H/V)	Reading (dBuV)		Emission (dBuV/m)		Limit Line (dBuV/m)		Over Limit (dBuV/m)	
				PK	AV	PK	AV	PK	AV	PK	AV
2390.00	-22.73	28.08	H	53.8	43.3	59.2	48.7	74.0	54.0	-14.9	-5.4
2483.50	-22.45	28.27	H	52.3	40.9	58.1	46.7	74.0	54.0	-15.9	-7.3
2518.40	-22.36	28.36	H	52.1	40.8	58.1	46.8	74.0	54.0	-15.9	-7.2
2390.00	-22.73	28.08	V	54.1	43.6	59.5	49.0	74.0	54.0	-14.6	-5.1
2483.50	-22.45	28.27	V	52.9	41.4	58.7	47.2	74.0	54.0	-15.3	-6.8
2518.40	-22.36	28.36	V	52.4	41.2	58.4	47.2	74.0	54.0	-15.6	-6.8



CH1 :

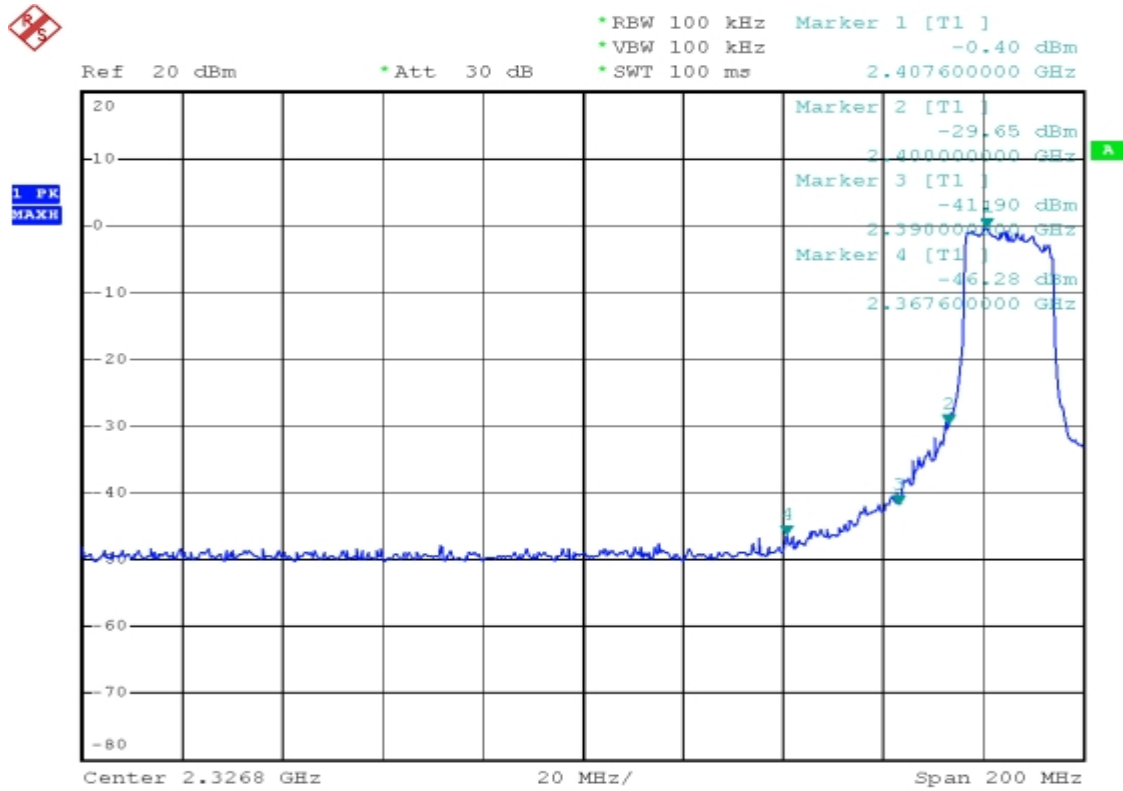

CH11:

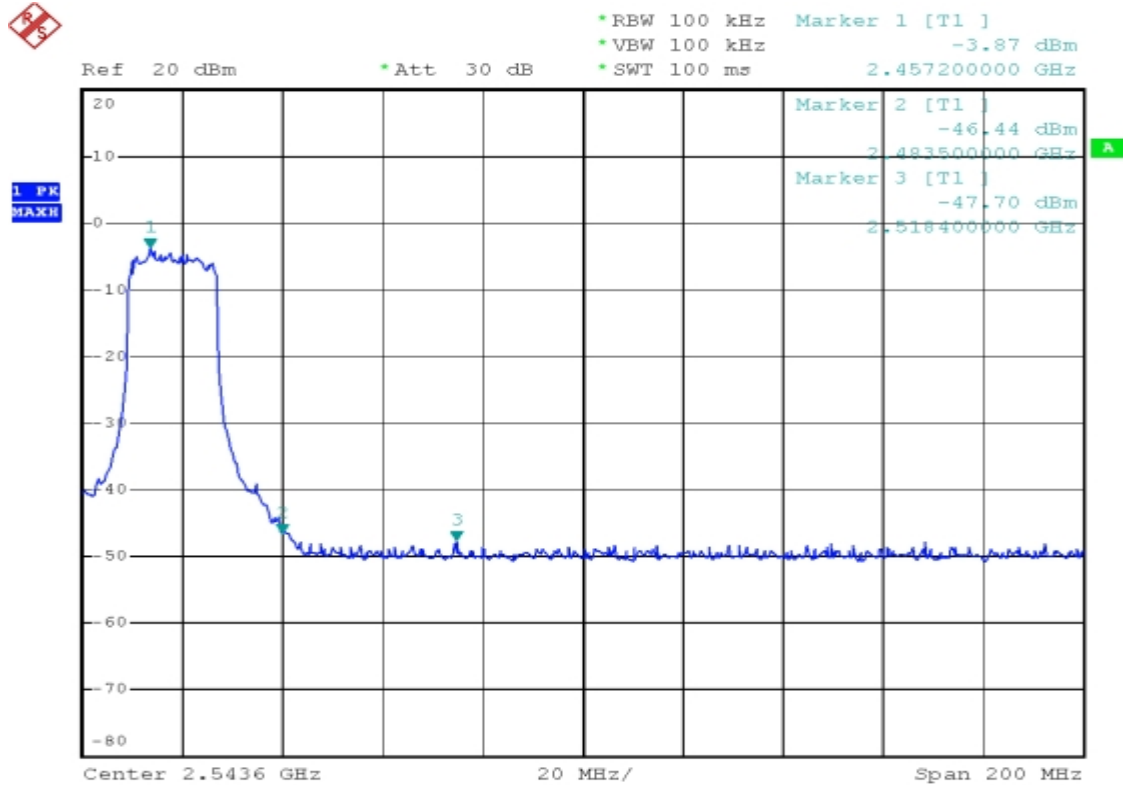



Spectrum Research & Testing Lab., Inc.
No. 101-10, Ling 8,
Shan-Tong Li, Chung-Li
City, Taoyuan, Taiwan

TEST REPORT

Reference No.: A10082002
Report No.: FCCA10082002
FCC ID : VYTLP-9181A
Page: 67 of 82
Date: Aug. 25, 2010

Temperature:	<u>24°C</u>	Humidity:	<u>55%RH</u>
Spectrum Detector:	<u>PK. or AV.</u>	Tested Mode:	<u>802.11 n (40M)</u>
Tested By:	<u>Shunm Wang</u>	Modulation Type:	<u>OFDM</u>
Tested Date:	<u>Aug. 20, 2010</u>		

1. Conducted test

Frequency (MHz)	PEAK POWER OUTPUT (dBm)	Emission read Value (dBm)	Result of Band edge (dBc)	Band edge LIMIT (dBc)
<2.3999	-3.72	-30.42	26.70	>20dBc
>2.4835	-6.53	-44.16	37.63	>20dBc

2. Radiated emission test

Frequency (MHz)	Correct Factor (dB)	Ant. Fac. (dB)	Ant. Pol. (H/V)	Reading (dBuV)		Emission (dBuV/m)		Limit Line (dBuV/m)		Over Limit (dBuV/m)	
				PK	AV	PK	AV	PK	AV	PK	AV
2390.00	-22.73	28.08	H	54.9	44.6	60.3	50.0	74.0	54.0	-13.8	-4.1
2483.50	-22.45	28.27	H	53.1	41.8	58.9	47.6	74.0	54.0	-15.1	-6.4
2469.50	-22.49	28.24	H	52.8	41.5	58.5	47.2	74.0	54.0	-15.5	-6.8
2390.00	-22.73	28.08	V	55.2	44.9	60.6	50.3	74.0	54.0	-13.5	-3.8
2483.50	-22.45	28.27	V	53.5	42.1	59.3	47.9	74.0	54.0	-14.7	-6.1
2469.50	-22.49	28.24	V	53.0	41.9	58.7	47.6	74.0	54.0	-15.3	-6.4



CH1 :

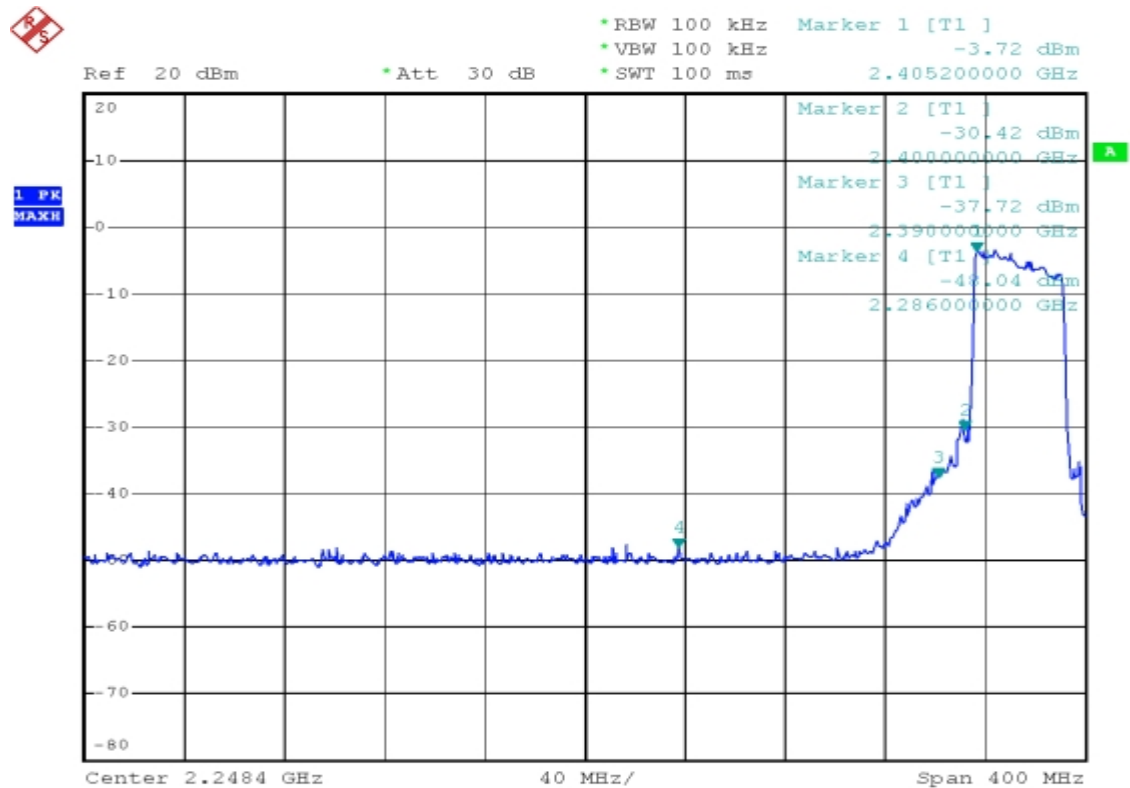

CH7:

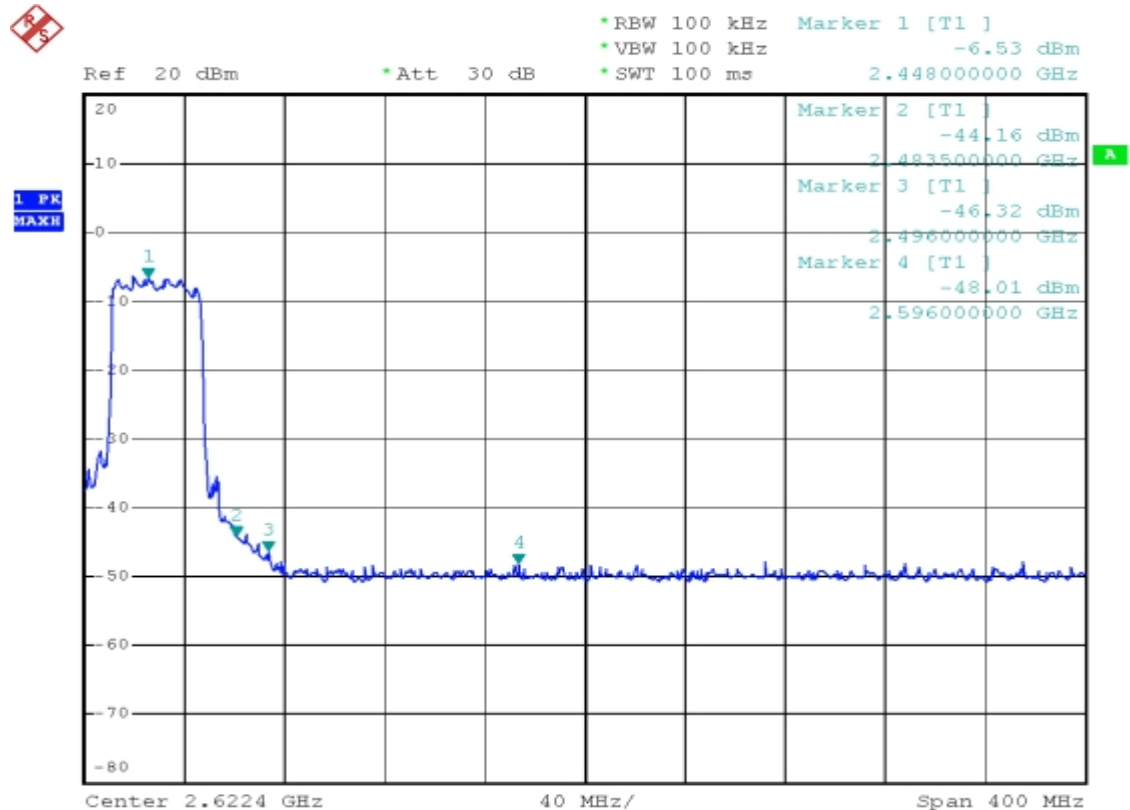



4.6 POWER DENSITY TEST

4.6.1 LIMIT

FCC Part15, Subpart C Section 15.247

FREQUENCY RANGE (MHz)	Limit(dBm/kHz)
902-928	8dBm/3kHz
2400-2483.5	
5725-5850	

4.6.2 TEST EQUIPMENT

The following test equipment was used during the radiated emission test:

EQUIPMENT/FACILITIES	SPECIFICATIONS	MANUFACTURER	MODEL#/SERIAL#	DUE DATE OF CAL. & CAL. CENTER
SPECTRUM	9K-40GHz	R&S	FSP40/ 100093	DEC. 2010 ETC

NOTE: The calibration interval of the above test equipment is one year and the calibrations are traceable to NML/ROC and NIST/USA.

4.6.3 TEST SET-UP

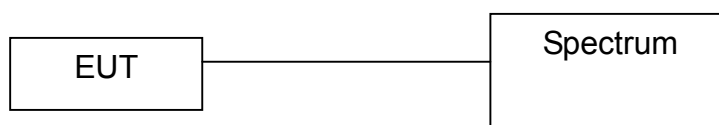

The EUT was connected to a spectrum through a 50Ω RF cable.

4.6.4 TEST PROCEDURE

The EUT was operating in transmitter mode and could be controlled its channel. Printed out the test result from the spectrum by hard copy function.

4.6.5 EUT OPERATING CONDITION

1. Set the EUT under continuous transmission condition.
2. The EUT was set to the highest available power level.



Spectrum Research & Testing Lab., Inc.
 No. 101-10, Ling 8,
 Shan-Tong Li, Chung-Li
 City, Taoyuan, Taiwan

TEST REPORT

Reference No.: A10082002
 Report No.: FCCA10082002
 FCC ID : VYTLP-9181A
 Page: 70 of 82
 Date: Aug. 25, 2010

4.6.6 TEST RESULT

Temperature:	24°C	Humidity:	55%RH
Spectrum Detector:	PK.	Tested Mode:	802.11 b
Tested By:	Shunm Wang	Modulation Type:	DSSS
Tested Date:	Aug. 20, 2010		

CHANNEL NUMBER	CHANNEL FREQUENCY (MHz)	RF POWER LEVEL IN 3kHz BW (dBm/3kHz)	MAXIMUM LIMIT (dBm/3kHz)
1	2412	-17.13	8
6	2437	-19.73	8
11	2462	-20.56	8

CH 1:

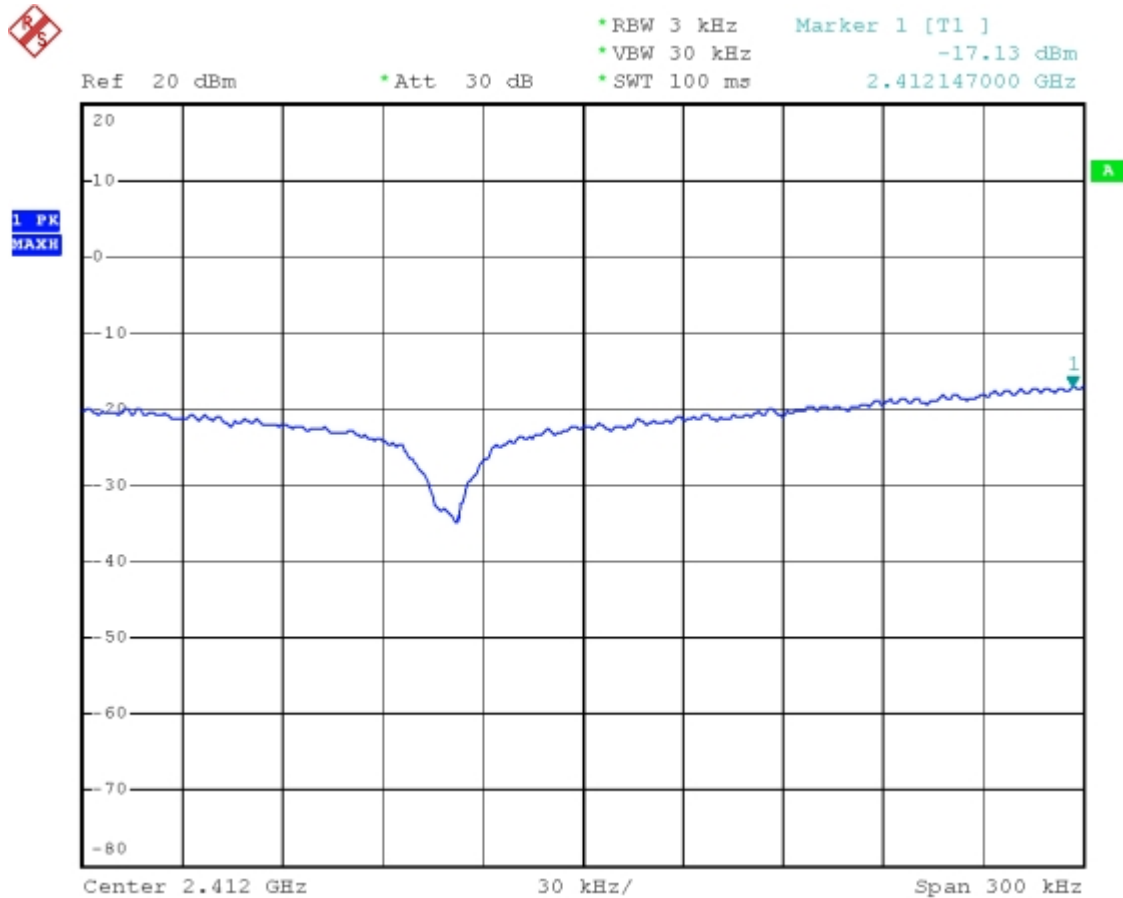



CH 6:

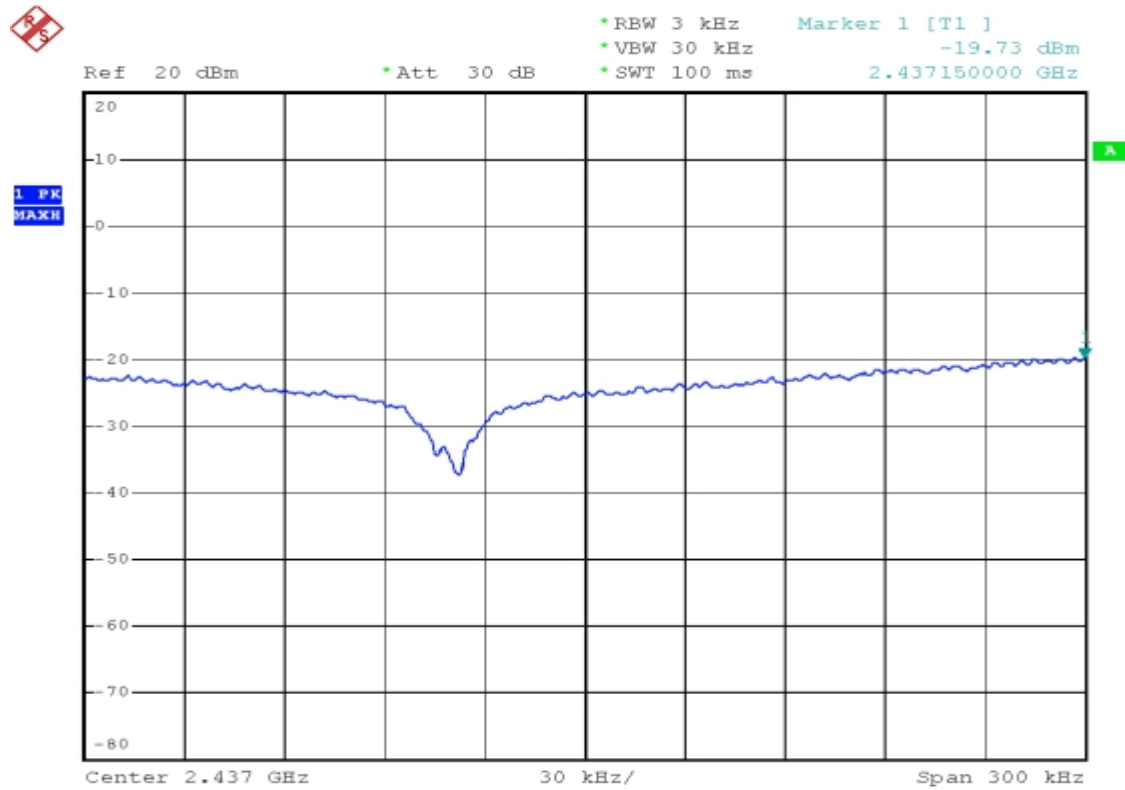

CH 11:

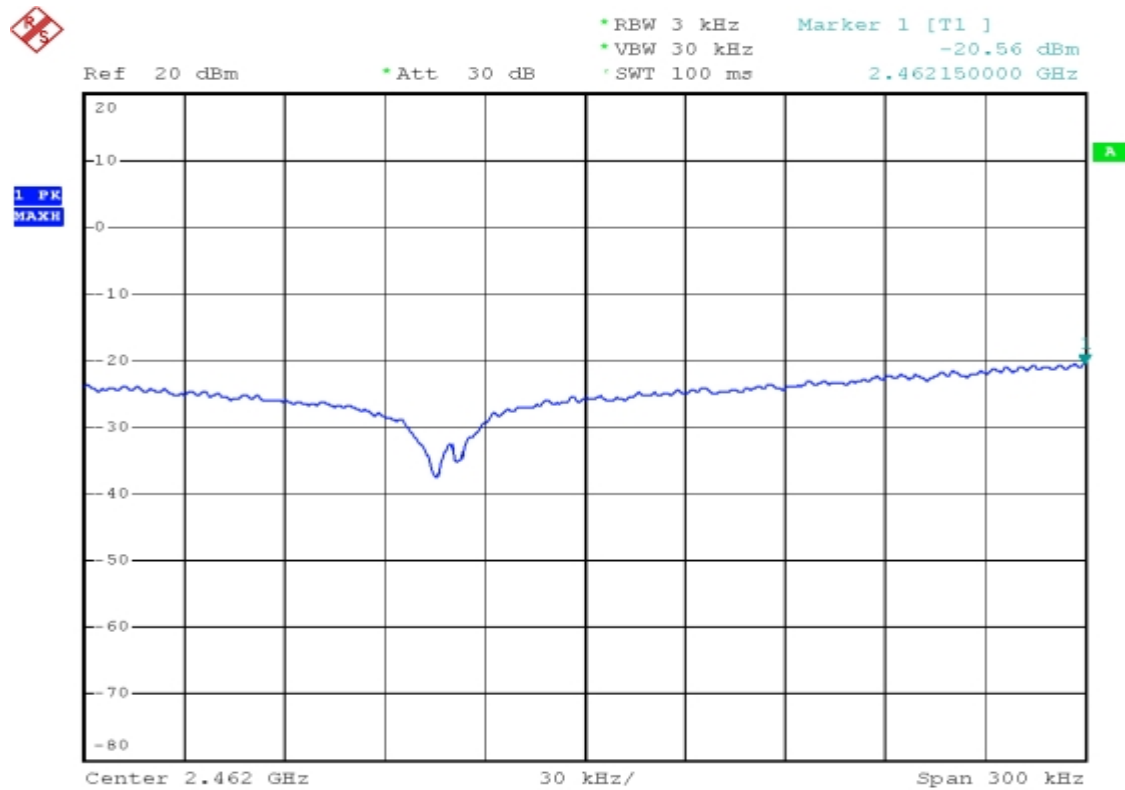



Spectrum Research & Testing Lab., Inc.
 No. 101-10, Ling 8,
 Shan-Tong Li, Chung-Li
 City, Taoyuan, Taiwan

TEST REPORT

Reference No.: A10082002
 Report No.: FCCA10082002
 FCC ID : VYTLP-9181A
 Page: 72 of 82
 Date: Aug. 25, 2010

Temperature:	<u>24°C</u>	Humidity:	<u>55%RH</u>
Spectrum Detector:	<u>PK.</u>	Tested Mode:	<u>802.11 g</u>
Tested By:	<u>Shunm Wang</u>	Modulation Type:	<u>OFDM</u>
Tested Date:	<u>Aug. 20, 2010</u>		

CHANNEL NUMBER	CHANNEL FREQUENCY (MHz)	RF POWER LEVEL IN 3kHz BW (dBm/3kHz)	MAXIMUM LIMIT (dBm/3kHz)
1	2412	-21.31	8
6	2437	-24.08	8
11	2462	-24.93	8

CH 1:

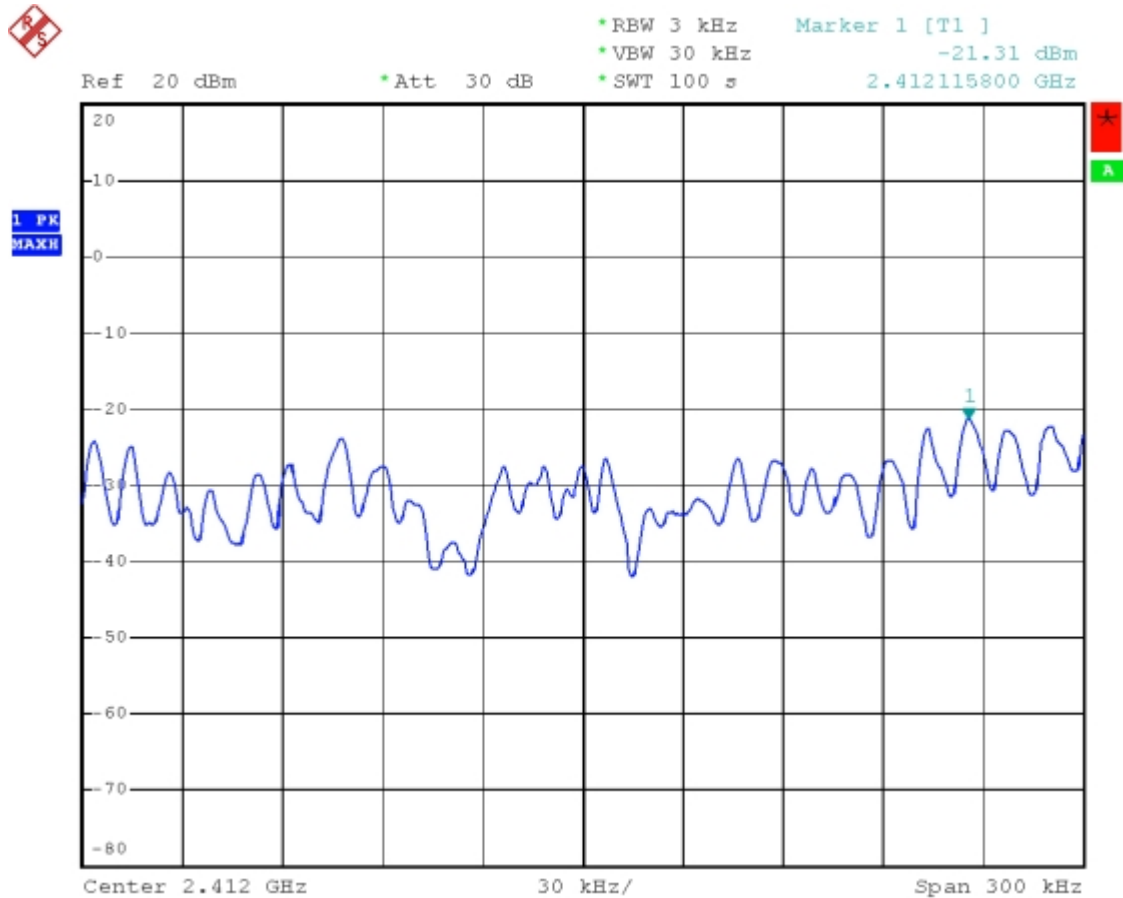



CH 6:

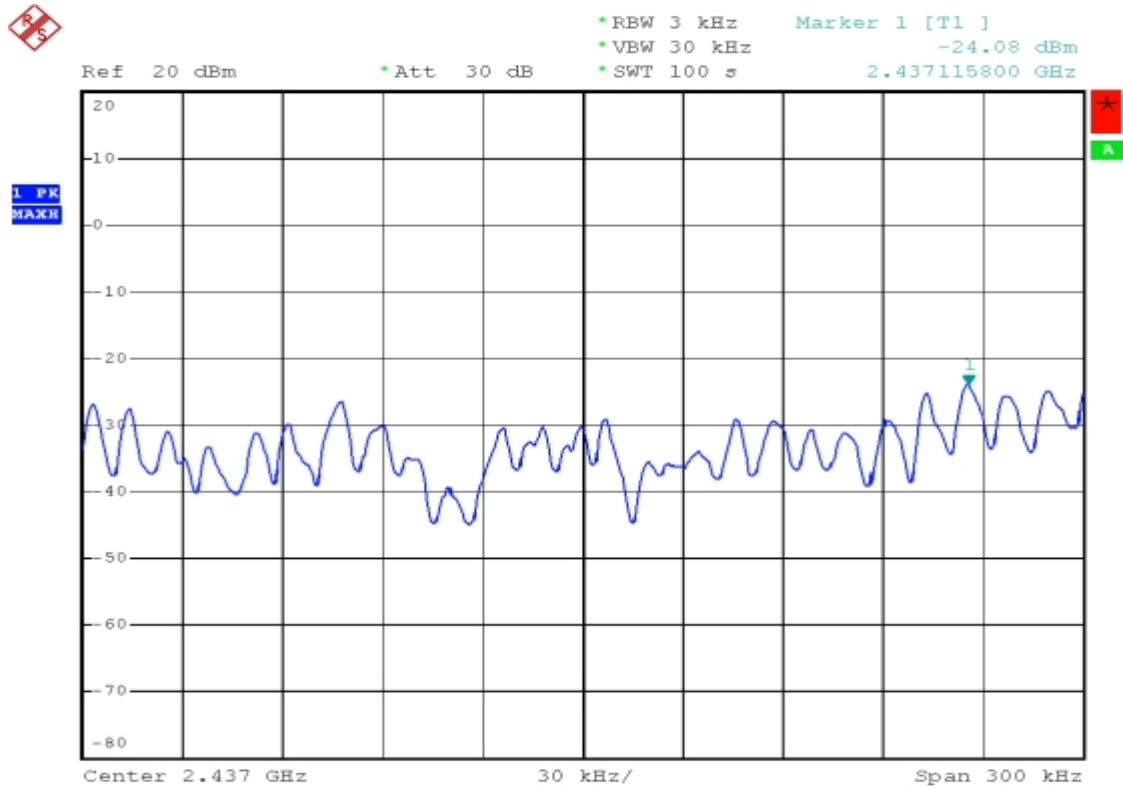

CH 11:

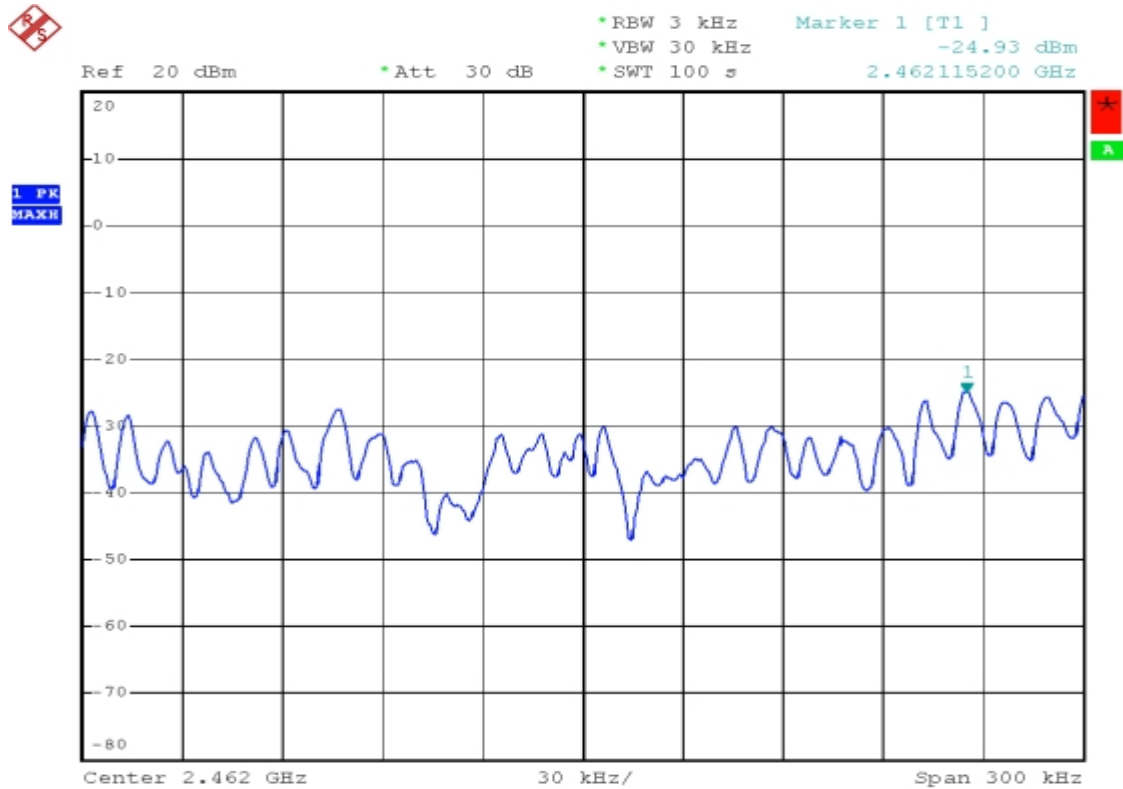



Spectrum Research & Testing Lab., Inc.
 No. 101-10, Ling 8,
 Shan-Tong Li, Chung-Li
 City, Taoyuan, Taiwan

TEST REPORT

Reference No.: A10082002
 Report No.: FCCA10082002
 FCC ID : VYTLP-9181A
 Page: 74 of 82
 Date: Aug. 25, 2010

Temperature:	<u>24°C</u>	Humidity:	<u>55%RH</u>
Spectrum Detector:	<u>PK.</u>	Tested Mode:	<u>802.11 n (20M)</u>
Tested By:	<u>Shunm Wang</u>	Modulation Type:	<u>OFDM</u>
Tested Date:	<u>Aug. 20, 2010</u>		

CHANNEL NUMBER	CHANNEL FREQUENCY (MHz)	RF POWER LEVEL IN 3kHz BW (dBm/3kHz)	MAXIMUM LIMIT (dBm/3kHz)
1	2412	-20.70	8
6	2437	-23.53	8
11	2462	-24.40	8

CH 1:

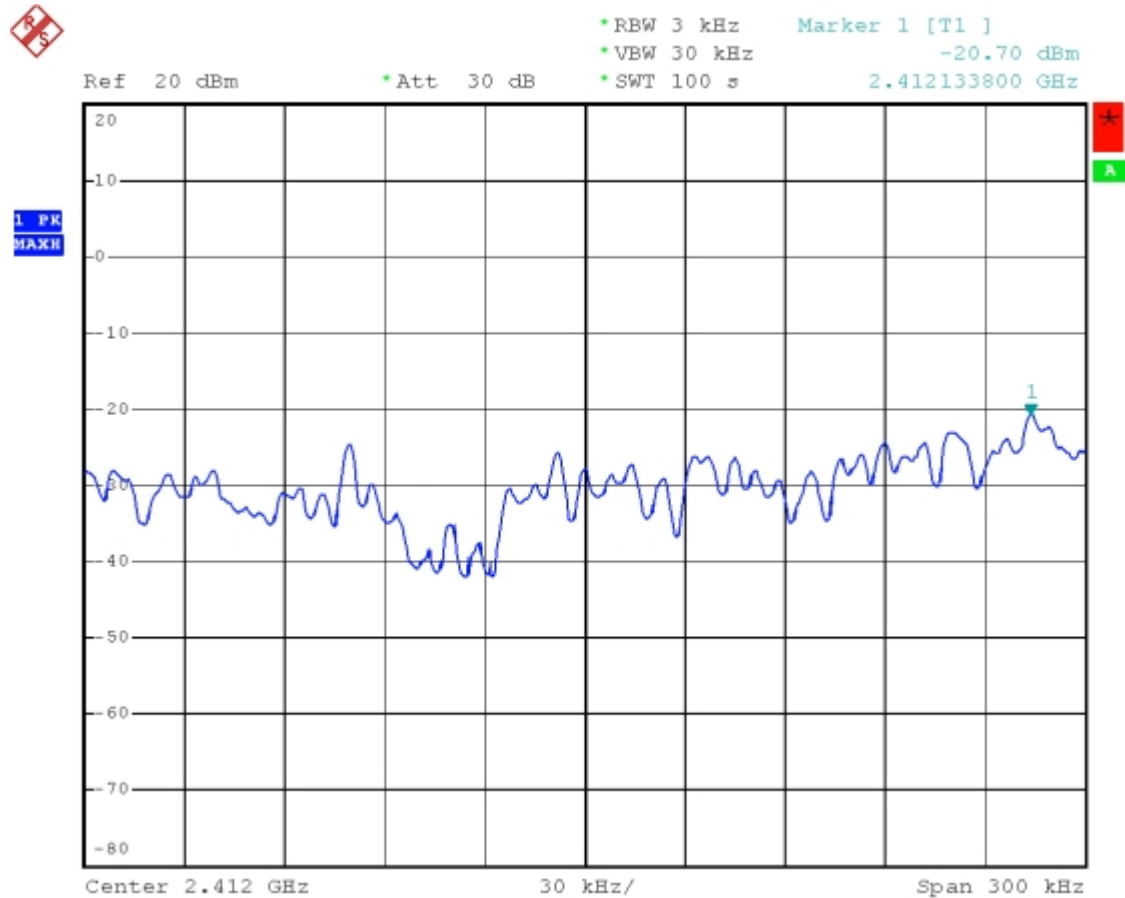



CH 6:

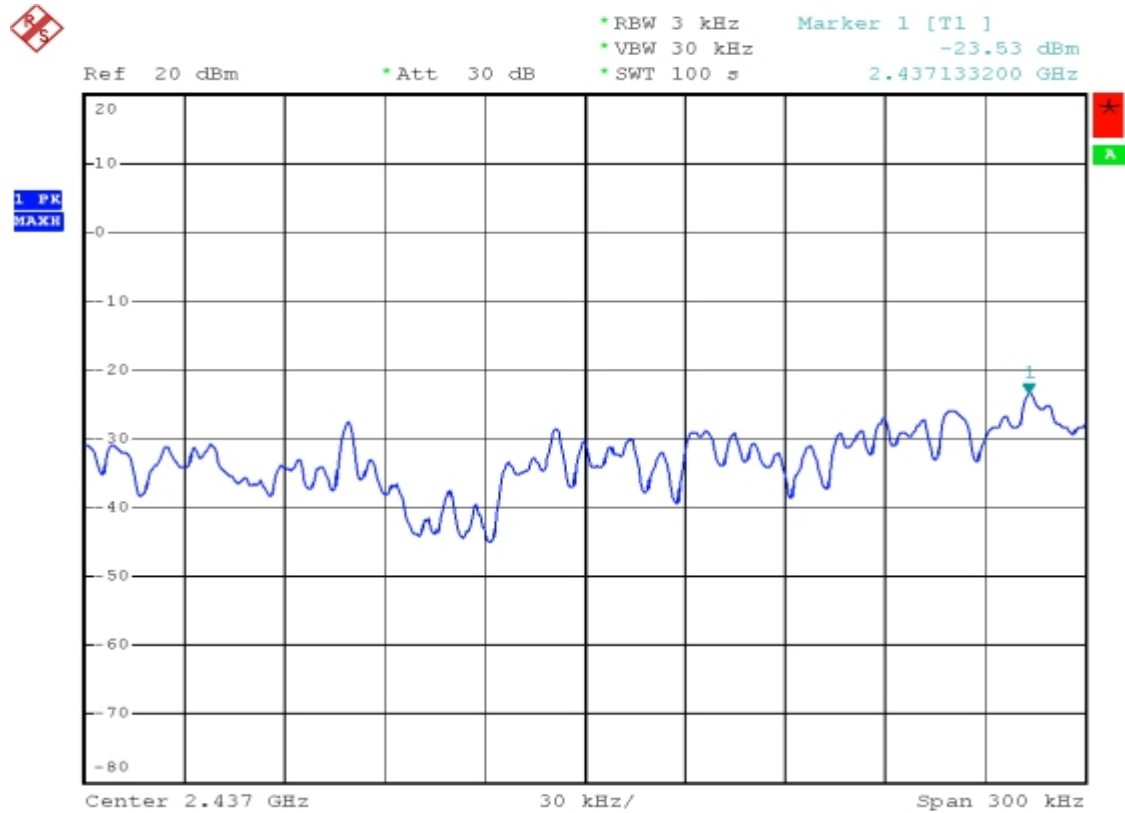

CH 11:

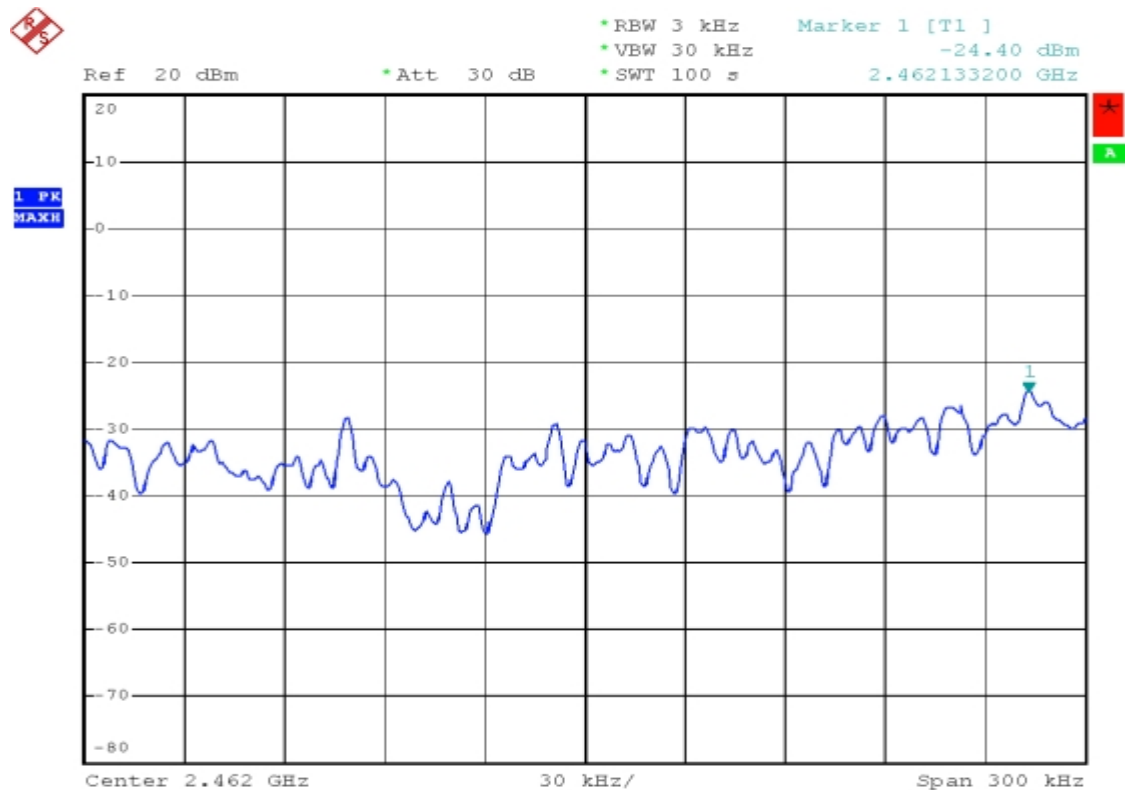



Spectrum Research & Testing Lab., Inc.
 No. 101-10, Ling 8,
 Shan-Tong Li, Chung-Li
 City, Taoyuan, Taiwan

TEST REPORT

Reference No.: A10082002
 Report No.: FCCA10082002
 FCC ID : VYTLP-9181A
 Page: 76 of 82
 Date: Aug. 25, 2010

Temperature:	<u>24°C</u>	Humidity:	<u>55%RH</u>
Spectrum Detector:	<u>PK. or AV.</u>	Tested Mode:	<u>802.11 n (40M)</u>
Tested By:	<u>Shunm Wang</u>	Modulation Type:	<u>OFDM</u>
Tested Date:	<u>Aug. 20, 2010</u>		

CHANNEL NUMBER	CHANNEL FREQUENCY (MHz)	RF POWER LEVEL IN 3kHz BW (dBm/3kHz)	MAXIMUM LIMIT (dBm/3kHz)
1	2422	-32.43	8
4	2437	-33.77	8
7	2452	-34.33	8

CH 1:

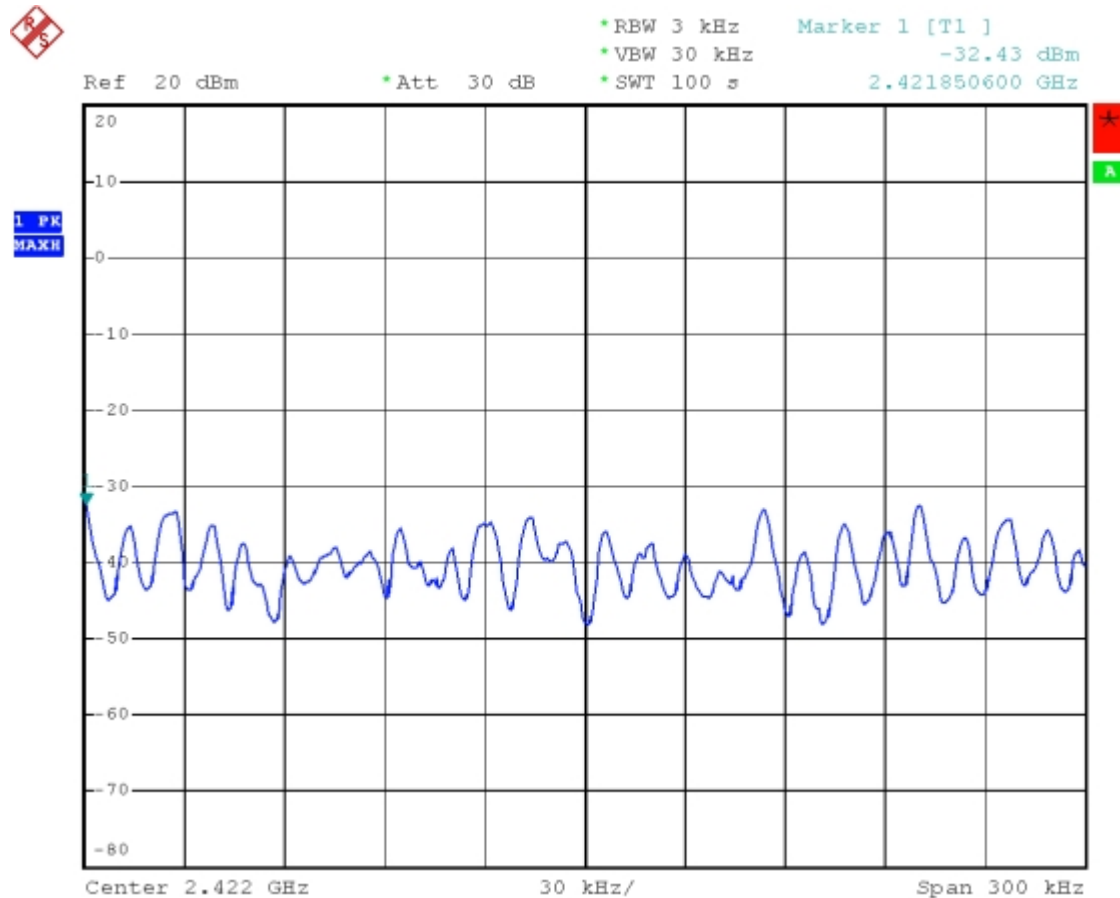



CH 4:

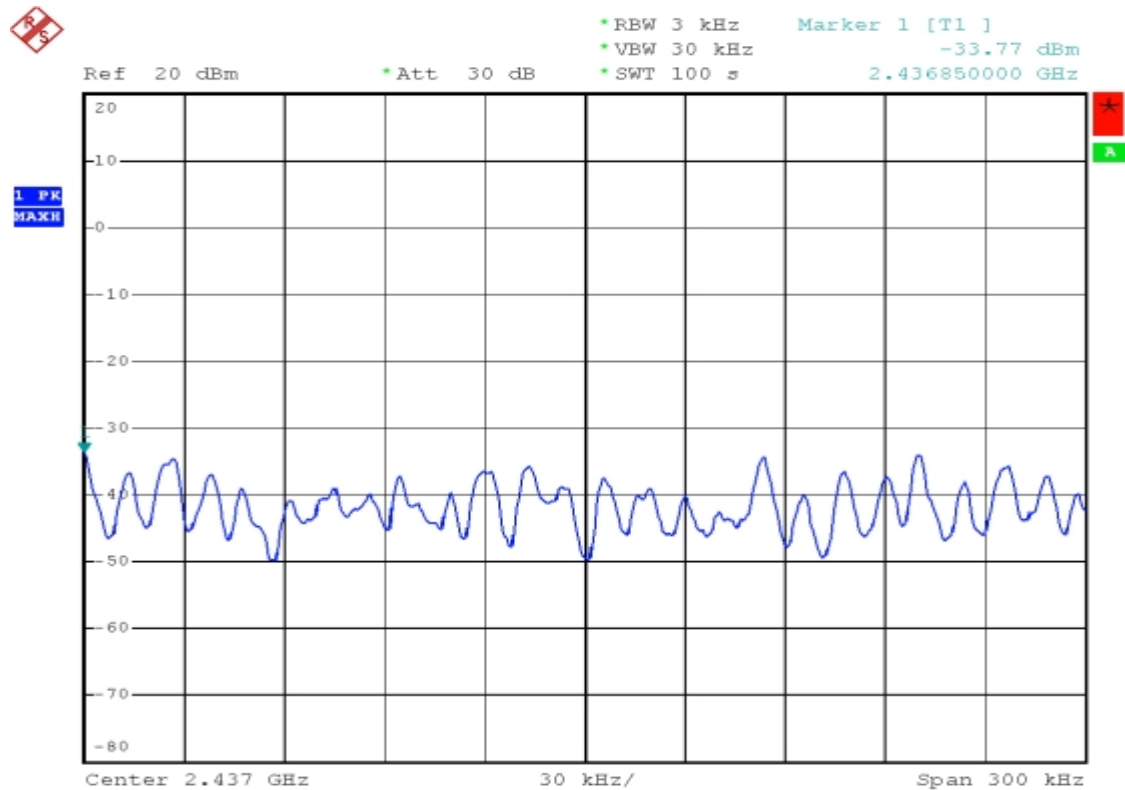

CH 7:

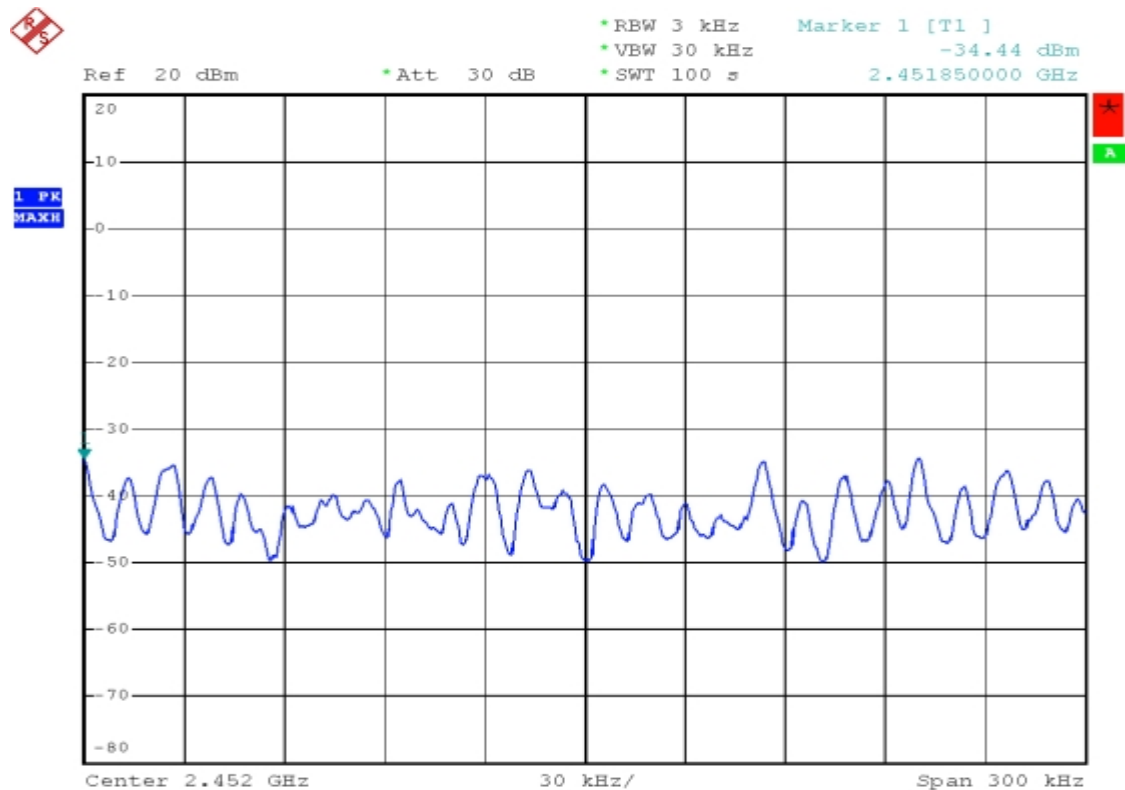



**Spectrum Research &
Testing Lab., Inc.**
No. 101-10, Ling 8,
Shan-Tong Li, Chung-Li
City, Taoyuan, Taiwan

TEST REPORT

Reference No.: A10082002
Report No.: FCCA10082002
FCC ID : VYTLP-9181A
Page: 78 of 82
Date: Aug. 25, 2010

5. Antenna application

5.1 Antenna requirement

The EUT's antenna is met the requirement of FCC part15C section15.203 and 15.204.

FCC part15C section15.247 requirement:

Systems operating in the 2400-2483.5 MHz band that are used exclusively for fixed, point-to-point operations may employ transmitting antennas with directional gain greater than 6 dBi provided the maximum peak output power of the intentional radiator is reduced by 1 dB for every 3 dB that the directional gain of the antenna exceeds 6 dBi.

5.2 Result

The EUT's antenna used a Reversed SMA Dipole. Gain of antenna is 9 dBi, we use the test program to reduced by 1dB of maximum peak output power.



Spectrum Research & Testing Lab., Inc.
No. 101-10, Ling 8,
Shan-Tong Li, Chung-Li
City, Taoyuan, Taiwan

TEST REPORT

Reference No.: A10082002
Report No.: FCCA10082002
FCC ID : VYTLP-9181A
Page: 82 of 82
Date: Aug. 25, 2010

7. TERMS OF ABBREVIATION

AV.	Average detection
AZ(°)	Turn table azimuth
Correct.	Correction
EL(m)	Antenna height (meter)
EUT	Equipment Under Test
Horiz.	Horizontal direction
LISN	Line Impedance Stabilization Network
NSA	Normalized Site Attenuation
Q.P.	Quasi-peak detection
SRT Lab	Spectrum Research & Testing Laboratory, Inc.
Vert.	Vertical direction