



**AUTO - SCANNING WITH DIGITAL CONTROL  
LCD COLOR MEDICAL MONITOR**

---

**AMVX2408**

---

Operation Manual

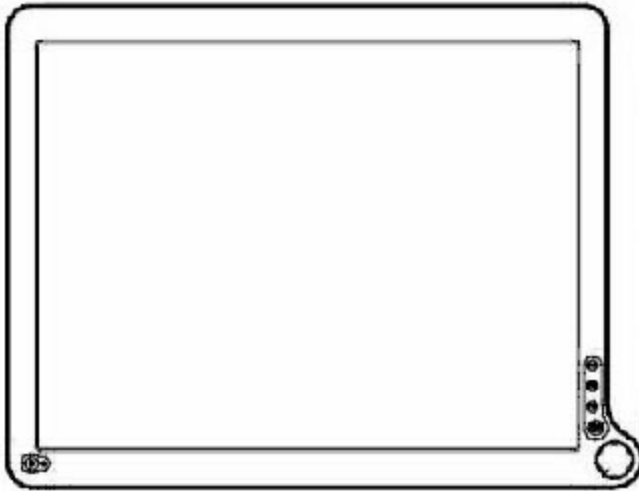

For future reference, record the serial number of your display monitor in the space below :

Serial Number

The serial number is located on the back of the monitor



---

**back of the monitor****WARNING**

The title "WARNING" is used to inform the users of possible causes that could inflict the injury, death, or property damage to the patients.

**CAUTION**

The title "CAUTION" is used to inform the users of possible causes that could inflict the patients although it might not severe enough to cause deaths.

**NOTE**

The title "NOTE" is used to inform the users of items that are of importance in terms of installation, operation, or maintenance of the Equipment although the failure does not inflict the bodily harm to the patients.

**Ampronix 2007**

All other trademarks are the property of their reference owners.

This document is subject to change without notice.

Ampronix provides this information as reference only. Reference to other vendor's products does not imply any recommendation or endorsement.

**Revision Control**

Date	Description
REV.02 121707	Document number

## **TABLE OF CONTENTS**

Product Description and Intended Use.....	3
Warnings and Cautions.....	4
Symbol Explanations.....	7
EU Declaration of Conformity for Medical Applications.....	8
Safety Precaution.....	9
Cleaning Your Monitor.....	9
Power Management Function.....	10
Preset Modes.....	11
Video Signals.....	12
PIP / POP / PBP function.....	13
DDC.....	14
Installation.....	14
Connecting the Power Cord.....	15
User Function / Messages.....	16
OSD Section.....	17
Troubleshooting.....	24
Specification of (AMVX2408).....	25
Classification.....	26
Electromagnetic Compatibility.....	27
Dimension Drawing (mm).....	30
Connectors.....	31

## Product Description and Intended Use

Please check the following items are present when you unpack the box, and save the packing materials in case you will need to ship or transport the monitor in future.

- AMVX2408 LCD Monitor and two video cables (1) HD15 VGA cable\* (1) DVI-D cable\*



- AC Power cord\*\*



- AC-Adapter



CAUTION  
 Manufacturer : JEC Korea  
 Model No :  
 JMW1150KA2400F04

- Composite Video BNC Jack Cable and Super Video Cable

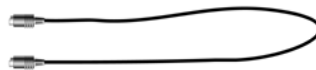

- User Manual and 4pcs VESA screws







\*Might be optional item. check with local representative

\*\*Might vary pending on region standard

## Warnings and Cautions

Please read this manual and follow its instructions carefully. The words warning, caution, and note carry special meanings and should be carefully reviewed:

	<b>Warning</b> <b>The personal safety of the patient or physician may be involved. Disregarding this information could result in injury to the patient or physician.</b>
	<b>Caution</b> <b>Special service procedures or precautions must be followed to avoid damaging the instrument.</b>
	<b>Note</b> Special information to make maintenance easier or important information more clear.
	An exclamation mark within a triangle is intended to alert the user to the presence of important operating and maintenance instructions in the literature accompanying the product.
	A lightning bolt within a triangle is intended to warn of the presence of hazardous voltage. Refer all service to authorized personnel.
	<b>Warning</b> <b>TO AVOID POTENTIAL SERIOUS INJURY TO THE USER AND THE PATIENT AND/OR DAMAGE TO THIS DEVICE, THE USER MUST :</b>

**Warranty is void if any of these warnings are disregarded.**

Ampronix accepts full responsibility for the effects on safety, reliability, and performance of the equipment only if:

- Re-adjustments, modifications, and/or repairs are carried out exclusively by Ampronix.
- The electrical installation of the relevant operating room complies with the applicable IEC and CE requirements.

**Warning**    **Federal law (United States of America) restricts this device to use by, or on order of a physician.**

The Ampronix AMVX2408 monitor has been tested under UL 60601-1 standard and UL listed for Medical application.

Ampronix reserves the right to make improvements in the product(s) described herein. Product(s), therefore, may not agree in detail to the published design or specifications. All specifications are subject to change without notice. Please contact Ampronix directly or phone your local Ampronix sales representative or agent for information on changes and new products.

---

## Warnings

1. Read the operating manual thoroughly and be familiar with its contents prior to using this equipment.
2. Carefully unpack the unit and check if any damage occurred during shipment.
3. Should any solid object or liquid fall into the panel, unplug the unit and have it checked by qualified personnel before operating it any further.
4. Unplug the unit if it is not to be used for an extended period of time. To disconnect the cord, pull it out by the plug. Never pull the cord itself.
5. Be a qualified physician, having complete knowledge of the use of this equipment.
6. Test this equipment prior to a medical procedure. This monitor was fully tested at the factory before shipment.
7. Avoid removing covers on control unit to avoid electric shock.
8. Attempt no internal repairs or adjustments not specifically detailed in this operating manual.
9. Pay close attention to the care, cleaning instructions in this manual. A deviation may cause damage (refer to the Cleaning section).
10. DO NOT STERILIZE MONITOR.
11. Read the entire instruction manual before assembling or connecting the camera.
12. Do not place the monitor or any other heavy object on the power cord. Damage to the cable can cause fire or electric shock.
13. Monitor with power supply is suitable for use in patient environment.
14. DO NOT stack more than 8 boxes high

This equipment has been tested and found to comply with the limits for medical devices in IEC 601-1-2:2003. These limits are designed to provide reasonable protection against harmful interference in a typical medical installation.

This equipment generates, uses and can radiate radio frequency energy and, if not installed and used in accordance with the instructions, may cause harmful interference to other devices in the vicinity. However, there is no guarantee that interference will not occur in a particular installation. If this equipment does cause harmful interference to other devices, which can be determined by turning the equipment off and on, the user is encouraged to try to correct the interference by one or more of the following measures:

- Reorient or relocate the receiving device.
- Increase the separation between the equipment.
- Connect the equipment into an outlet on a circuit different from that to which the other device(s) are connected.
- Consult the manufacturer or field service technician for help.

### NOTICES TO USER

This device complies with Part 15 of the FCC Rules. Operation is subject to the following two conditions:

- (1) this device may not cause harmful interference, and (2) this device must accept any interference received, including interference that may cause undesired operation.

### FCC WARNING

This equipment generates or uses radio frequency energy. Changes or modifications not expressly approved by the party responsible for compliance could void the user's authority to operate the equipment. The user could lose the authority to operate this equipment if an unauthorized change or modification is made.

## Cautions

1. The AC Adapter must be plugged into a Grounded power outlet.
2. Use only the proprietary AMVX2408 power supply for the AMVX2408 monitor.  
Make a proper connection by ensuring that the shrink tubing completely secures the connection between the DC power cord and the extension cord.
3. Turn power off when unit is not in use.
4. Never operate the unit right after having transported from a cold location directly to a warm location.
5. Do not expose the monitor to moisture or directly apply liquid cleaners directly to the screen. Spray the cleaning solution into a soft cloth and clean gently.
6. Handle the monitor with care. Do not strike or scratch the screen.
7. Do not block the monitor cooling vents. The monitor is cooled by natural convection and has no fan.
8. Do not force the monitor past 28 degrees of vertical when adjusting the screen position. (For monitors equipped with stands only.)
9. Remove the power module and connection when transporting the unit.
10. Save the original carton and associated packing material. They will be useful should you have to transport or ship the unit.
11. Allow adequate air circulation to prevent internal heat buildup.
12. Do not place the unit on surfaces (rugs, blankets, etc.) or near materials (curtains, draperies) that may block the ventilation slots.
13. Do not install the unit near sunlight, excessive dust, mechanical vibration or shock.
14. The unit is designed for operation in a horizontal position. Never operate the unit in a vertical position.
15. Keep the unit away from equipment with strong magnets (i.e. a large loudspeaker.)
16. Do not expose the monitor to moisture or excessive dust.
17. Equipment with SIP/SOP connectors should either comply with IEC 60601-1 and/or IEC 60601-1-1 harmonized national standard or the combination should be evaluated.  
Do not touch the patient with signal input or output connectors.
18. Use only a hospital grade power supply cord.
19. This equipment has been tested and found to comply with the limit for a Class B digital device, pursuant to Part 15 of the FCC Rules. These limits are designed to provide reasonable protection against interference with radio communications. However, there is no guarantee that interference will not occur in a particular installation, which can be determined by turning the equipment off and on, the user is encouraged to try to correct the interference by one or more of the following measures:
  - Reorient or relocate the receiving device.
  - Increase the separation distance between the equipment.
  - Connect the equipment to an outlet on a circuit different from that to which the other device(s) are connected.
  - Consult the manufacturer or field service technician for help.
20. Grounding reliability can only be achieved when the equipment is connected to an equipment receptacle labeled "Hospital Only" or "Hospital Grade."

**Note** To connect to an international power supply, use an attachment plug appropriate for the power outlet.

**Note** Refer to the "Electromagnetic Compatibility" (EMC) section of this manual to ensure EMC. The AMVX2408 must be installed and operated according to the EMC information provided in this manual.



## Symbol Definitions



Dangerous: High Voltage



Direct Current

**SN**

Serial Number



Top - Bottom



Fragile



Do not get wet



Consult accompanying documents.



Indicates proof of conformity to applicable European Economic Community Council directives and to harmonized standards published in the official journal of the European Communities.



Indicates protective earth ground.



For indoor use only.



51LJ  
Medical Equipment  
E215822

Medical Equipment is in accordance with UL 60601-1 and CAN/CSA C22.2 No. 601.1 in regards to electric shock, fire hazards, and mechanical hazards.



Tested to comply with FCC Class B standards.



DC power control switch

## ***EU Declaration of Conformity for Medical Applications***

A Declaration of Conformity has been filed for this product. A sample of this document may be found in the addendum which accompanied this manual. For a copy of the Declaration of Conformity document, please contact Ampronix and request for AMVX2408 DOC.

### ***Prepare for Unpack***

Before you unpack your monitor, prepare a suitable workspace. You need a stable and level surface near a grounded wall outlet in an area which is relatively free of glare from sunlight or other sources of bright light. The monitor is cooled by natural convection (it has no fan). For optimum performance, do not block the cooling vents.

While unpacking the monitor, inspect it and other package contents for shipping damage that could cause a fire or shock hazard. Immediately report any shipping damage to the carrier or transportation company and contact customer service for monitor in the future or in case of return.

After you unpack the monitor, make sure the following items are included

- Monitor with video cable
- AC adapter with cable
- ⚠ CAUTION: AC Adapter must be plugged into Grounded a power outlet
- ⚠ CAUTION : AC adapter  
Manufacturer: JEC korea  
Model No: JMW1150KA2400F04
- This operations manual

---

⚠ Note: Your system provider may offer alternative cords or cables depending on the installation requirement and local geography issues.

---

---

## ***SAFETY PRECAUTION***

- Avoid placing the monitor, or any other heavy object, on the power cord to prevent fire or electrical shock from damage to the power cord.
- Do not expose the monitor to rain, excessive moisture, or dust to avoid fire or shock hazard.
- Do not cover the slots or openings of the monitor for proper heat dissipation. Always put the monitor in a place where there is adequate ventilation.
- Avoid placing the monitor against a bright background or where sunlight or other light sources may reflect on the area of the monitor. Place the monitor just below eye level.
- Handle with care when transporting the monitor.
- Refrain from giving the shock or scratch to the screen, as screen is fragile.

## ***CLEANING YOUR MONITOR***

No specific liquid or chemical necessary when cleaning this LCD monitor. However, we suggest to clean the monitor with non-abrasive cloths and cleaning solutions used in hospitals to clean similar equipment. We recommend using 70% Isopropyl alcohol for the screen surface and warm water and a mild detergent for all other surfaces. Other acceptable cleaning agents are listed below:

- 70% isopropyl alcohol
- Cidex (2.4% glutaraldehyde solution)
- 0.5% Chlorhexidine in 70% isopropyl alcohol

To clean the screen, do not spray liquid cleaners directly on to the unit. Stand away from the monitor and spray cleaning solution onto a cloth. Without applying excessive pressure, clean the screen with the slightly dampened rag.

**POWER MANAGEMENT FUNCTION**

The monitor is equipped with the power management function which automatically reduce the power consumption when not in use in three power level modes.

- **Stand-by Mode**

The monitor goes into stand-by mode when the horizontal sync signal is off for about 10 seconds. In this mode, the screen goes off and the power LED blinks for 1 seconds On and 1 second Off. The screen is displayed after the horizontal sync signal is restored.

- **Suspend Mode**

The monitor goes into suspend mode when the vertical sync signal is off for about 10 seconds. The power consumption during this is less than 8 W. In this mode, the screen goes off and the power LED blinks for 1 seconds On and 1 second Off. The screen is displayed after the vertical sync signal is restored.

- **Off Mode**

The monitor goes into power-off mode when the vertical and horizontal sync signals are off for about 10 seconds. In this mode, the screen goes off and the power LED blinks for 1 seconds On and 1 second Off. The screen is displayed after the vertical and horizontal sync signals are restored.

**Power Management System**

The AMVX2408 Medical Monitor power management proposal. Provides four phases of power-saving modes by detecting the horizontal sync signal as shown in the table below.

State	Normal Operation	DPMS Standby	DPMS suspend	DPMS Off
Horizontal Sync	Active	Inactive	Active	Inactive
Vertical Sync	Active	Active	Inactive	Inactive
Video	Active	Blanked	Blanked	Blanked
Power Indicator	Green	Red Flashing (1 sec. Interval)	Red Flashing (1 sec. Interval)	Red Flashing (1 sec. Interval)
Power Consumption	97W	27W	27W	27W

When the monitor is power saving mode or detects an incorrect timing, the screen will be blank and power LED indicator will blink.

**PRESET MODES**

<b>Resolution</b>	<b>Horizontal frequency ( KHz )</b>	<b>Vertical frequency ( Hz )</b>	<b>Pixel clock ( MHz )</b>
640 x 350 @60Hz	31.469	59.941	25.175
640 x 350 @70Hz	31.469	70.087	25.175
640 x 350 @85Hz	37.86	85.080	31.500
640 x 400 @60Hz	31.469	59.941	25.175
640 x 400 @70Hz	31.469	70.087	25.175
640 x 400 @85Hz	37.86	85.080	31.500
640 x 480 @60Hz	31.469	59.940	25.175
640 x 480 @72Hz	37.861	72.809	31.500
640 x 480 @75Hz	37.500	75.000	31.500
640 x 480 @85Hz	43.269	85.008	36.000
720 x 400 @85Hz	37.927	85.038	35.500
800 x 600 @56Hz	35.156	56.250	36.000
800 x 600 @60Hz	37.879	60.317	40.000
800 x 600 @72Hz	48.077	72.188	50.000
800 x 600 @75Hz	46.875	75.000	49.500
800 x 600 @85Hz	53.674	85.061	56.250
1024 x 768 @43Hz	35.522	86.958	44.900
1024 x 768 @60Hz	48.363	60.004	65.000
1024 x 768 @70Hz	56.476	70.069	75.000
1024 x 768 @75Hz	60.023	75.029	78.750
1024 x 768 @85Hz	68.677	84.997	94.500
1152 x 864 @60Hz	54.348	60.053	80.000
1152 x 864 @70Hz	63.955	70.016	94.200
1152 x 864 @75Hz	67.500	75.000	108.000
1280 x 960 @60Hz	60.000	60.000	108.000
1280 x 960 @85Hz	85.938	85.002	148.500
1280 x 1024 @60Hz	63.974	60.013	108.500
1280 x 1024 @75Hz	79.976	75.025	135.000
1280 x 1024 @85Hz	91.146	85.024	157.500
1600 x 1200 @60Hz	75.000	60.000	162.000
1920 x 1200 @60Hz	74.099	59.999	154.125

**Video Signals**

Format	C-Video	S-Video	SD11	SD12	Component / RGB	
					Y/Pb/Pr	RGB
NTSC	○	○				
PAL	○	○				
480/59.94i			○	○	○	○
480/59.94p					○	○
576/50i			○	○	○	○
576/50p					○	○
720/50p			○	○	○	
720/59.94p			○	○	○	○
720/60p			○	○	○	○
1035/59.94i			○	○	○	○
1035/60i			○	○	○	○
1080/23.98psf			○	○	○	
1080/24psf			○	○	○	
1080/23.98p			○	○	○	
1080/24p			○	○	○	
1080/25p			○	○	○	
1080/29.97p			○	○	○	
1080/30p			○	○	○	
1080/50i			○	○	○	○
1080/50p					○	
1080/59.94i			○	○	○	○
1080/59.94p					○	
1080/60i			○	○	○	○
1080/60p					○	



## DDC

To make your installation easier, the monitor is able to Plug and Play with your system if your system also supports DDC protocol. The DDC (Display Data Channel) is a communication protocol through which the monitor automatically informs the host system about its capabilities, for example, supported resolutions and corresponding timing. The monitor supports DDC1 and DDC2B standard.

## INSTALLATION

To install the monitor to your host system, please follow the steps as given below:

### Steps

1. Use the supplied video cable (DVI, VGA, S-Video, C-Video) then connect to the host system accordingly.
2. Connect the DC power to the DC power connector on the monitor.
3. Connect one end of AC power cord into the AC Adapter and the other end to AC power outlet.
4. Then turn the host system on and then the monitor.
5. If the monitor still does not function properly, please refer to the troubleshooting section to diagnose the problem.

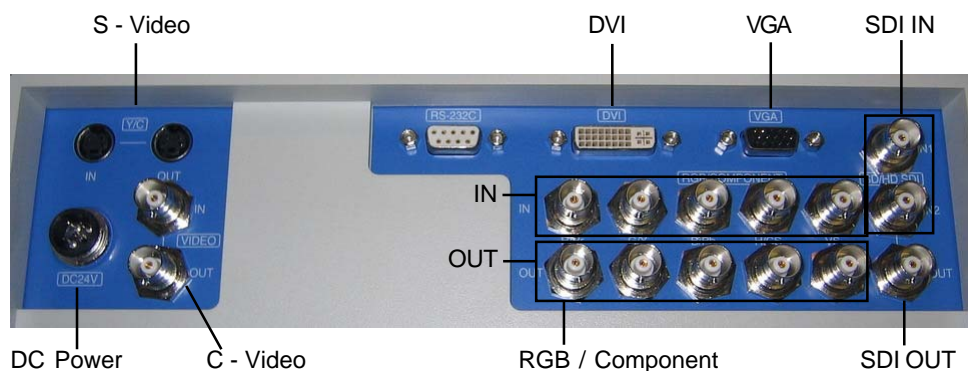



---

**CONNECTING the POWER CORD**

- \* Check first to make sure that the power cord you use is the correct type required for your area.
- \* This monitor has an universal AC adapter that allows operation in either AC 100 - 240 V ac voltage area. No user-adjustment is required.
- \* Plug one end of the power cord to the AC adapter, plug another end to a proper AC outlet.

The cord set should have the appropriate safety approvals for the country in which the equipment will be installed and marked HAR.

For 120 volt Applications, use only UL Listed detachable power cord with NEMA configuration 5-15P type (parallel blades) plug cap. For 240 volt applications use only UL Listed Detachable power supply cord with NEMA configuration 6-15P type (tandem blades) plug cap.

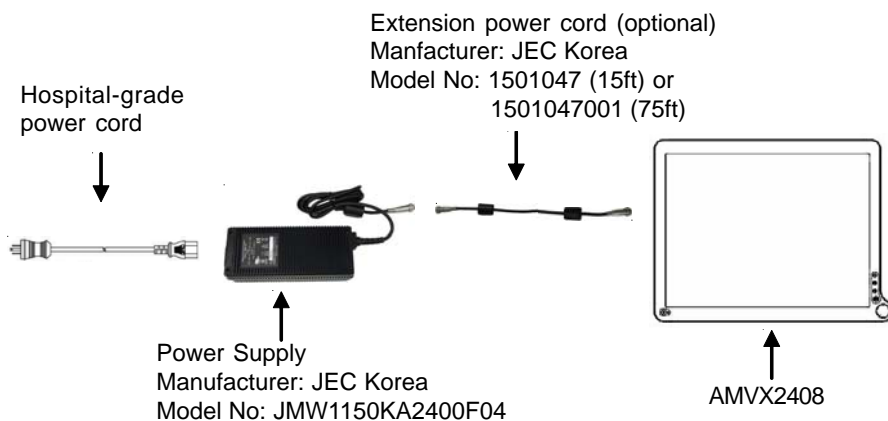

## User Functions / Messages

### Key Name and Function

Power LED : Lights up to indicate the power is turned ON.

Power Switch : To power ON or OFF the monitor.

Rotary switch : With the OSD menu activated, increases the value of the selected (Ture Right) parameter or moves rightward in OSD menu.

Rotary switch : With the OSD menu activated, increases the value of the selected (Ture Left) parameter or moves leftward in OSD menu.

PIP Switch : To enable or disable Picture In Picture function.

PBP Switch : To enable or disable Picture By Picture function.

POP Switch : To enable or disable Picture On Picture function.

Adjust Switch : To activate or deactivate image adjustment in sub screen of PIP, PBP, POP mode.

Locker Switch : To turn ON or OFF the system.

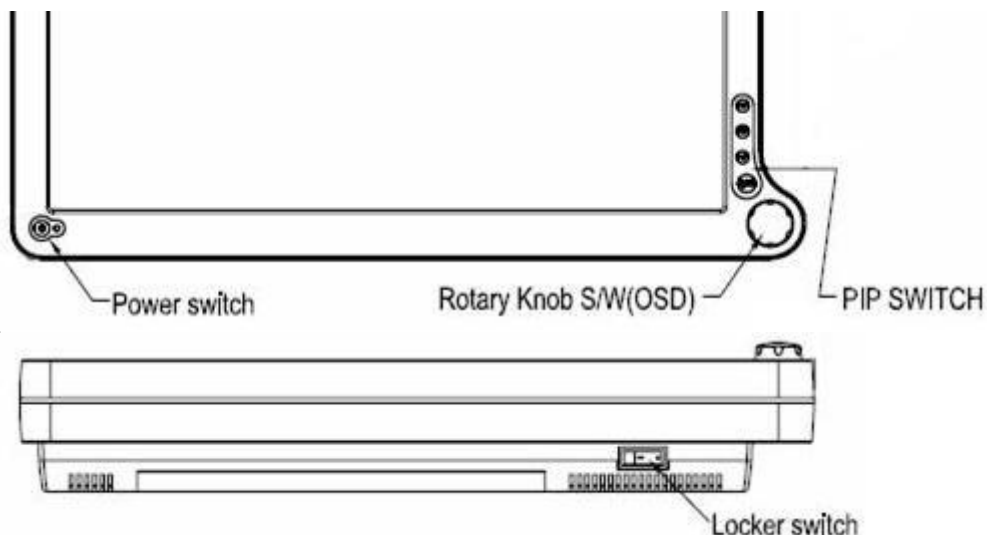

### How to access the menu

1. Push the “Knob” button to activate the OSD menu.
2. Able to turn left or right the button to select those icons. The icon will be highlighted when is selected.
3. Push the “knob” button to go into the another OSD menu.
4. Turn left or right “Knob” button to increase or decrease the number of selected function.
5. In order to exit from the OSD menu in a different layer, then choose the “Exit option”. In case of long pushing and holding the button around two or three seconds, then it will completely out from the menu regardless wherever you are.
6. Turn the “Knob” button in a fast way to the left or right, while the menu is not activated, then input signal menu will turns up with “V” mark which is chosen current available input signal. You can switch to another input signal source by turning the knob slowly then select the target source by pushing the knob.

---

**OSD Section**

**Main Menu**

**Chromatic**

Adjust Color Temp, Gamma

**Visual**

Adjust Brightness, Contrast, Phase, Chroma, Sharpness-H, Sharpness-V

**Setting**

Adjust Scale Mode, Mirror, Freeze Frame, Zoom / Pan, PIP / POP, PBP

**Advanced**

Adjust OSD Position Control, Screen Control, DPMS, Auto Source Select, Smart Select, Restore Factory, Key Lock

**Information**

Adjust Custom Entry, SN, Run Time, Input Format

**OSD Section**

---



**Chromatic**



Color Temp      Change the color temperature - D65, D93, S1, S2, S3, S4



Gamma      Change the gamma value - 1.8, 1.9, 2.0, 2.1, 2.1S, 2.2, 2.3, 2.4, 2.4S, S0, Radio graph



Exit      Exit the menu



**Visual**



Brightness      Adjust the brightness of panel (Range 0 - 100)



Contrast      Adjust the contrast of video (Range 0 - 100)



Phase      Adjust the phase of video (Range 0 - 100)  
**\*available for C and S - video**



Chroma      Adjust the chroma of video (Range 0 - 100)  
**\*available for C and S - video**



Sharpness-H      Set the sharpness of horizontal image (Range 0 - 100)



Sharpness-V      Set the sharpness of vertical image (Range 0 - 100)



Exit      Exit the menu

---

**OSD Section****Setting**

Scale Mode      Change the scale mode - Fill all, Vertical - fill, Horizontal - fill, One to One, Center - fill, Fill aspect ratio



Mirror            Off / On mirror image



Freeze Frame    Off / On freeze frame



Zoom / Pan       Enable zoom - in and pan function



PIP                Enable PIP (Picture In Picture) function



PBP                Enable PBP (Picture By Picture) function









Exit                Exit the menu





**OSD Section**

---

**Sub menu of PIP**

	Mode	PIP Mode ON / Off
	Source	PIP sub screen source - SDI1,2, C-Video, S-Video, Component, VGA, DVI
	Position	PIP sub screen position - Top L, Top R, Bottom L, Bottom R
	Size	PIP sub screen size - Small, Medium, Large
	Blending	PIP sub screen blending (Range 0 - 100)
	Swap	PIP sub screen swap
	Exit	Exit the menu

**Sub menu of PBP**

	Mode	PBP Mode ON / Off
	Source	PBP sub screen source - SDI1,2, C-Video, S-Video, Component, VGA, DVI
	Swap	PBP sub screen swap
	Exit	Exit the menu

## OSD Section



### Advanced



OSD Position Control Change the OSD menu - Position, Background, OSD time out, Language



Screen Control Control and adjust H and V position, Frequency, Phase Noise Reduction, Motion Offset



DPMS Change the DPMS



Auto Source Select Adjust Auto Source Select between on and off



Smart Select Enable / Disable smart select sub menu



Restore Factory Changes the all OSD value to factory outgoing status



Key Lock Set to key lock mode









Exit Exit the menu









**OSD Section**

---

**Sub menu of OSD Control**

	H-position	Adjust OSD H - position (Range 0 - 100)
	V-position	Adjust OSD V - position (Range 0 - 100)
	Back ground	Adjust transparency of OSD back ground (Range 0 - 100)
	OSD Time out	Adjust OSD time out - 5s, 10s, 15s, 20s, 1m, 2m
	Language	OSD language - English, Japanese, Chinese, Korean, French, German
	Exit	Exit the menu

**Sub menu of Screen Control**

	H-position	Adjust screen H - position (Range 0 - 100)
	V-position	Adjust Screen V - position (Range 0 - 100)
	Frequency	Adjust frequency (Range 0 - 100) <b>*available for VGA</b>
	Phase	Adjust phase (Range 0 - 100) <b>*available for VGA</b>
	Noise Reduction	Noise Reduction (Range 0 - 100) <b>*available for Component, C-Video and S-Video</b>
	Motion Offset	Motion Offset (Range 0 - 15) <b>*available for Component, C-Video and S-Video</b>
	Exit	Exit the menu



---

**OSD Section****Information**

Custom Entry    Change the user or monitor's name



SN    Display the serial number



Run Time    Display the total run time



Input Format    Display the current input resolution and vertical frequency



Exit    Exit the menu

**TROUBLESHOOTING**



Before sending your LCD monitor for servicing, please check the troubleshooting list below to see if you can self-diagnose the problem.

Problems	Current Status	Remedy
No Picture	LED ON	<ul style="list-style-type: none"> <li>Using OSD, adjust brightness and contrast to maximum or reset to their default settings.</li> </ul>
	LED OFF	<ul style="list-style-type: none"> <li>Check the Locker switch and Power switch.</li> </ul>
		<ul style="list-style-type: none"> <li>Check if AC power cord is properly connected to the AC adapter.</li> </ul>
LED Blinking		<ul style="list-style-type: none"> <li>Check if video signal cable is properly connected at the back of monitor.</li> </ul>
		<ul style="list-style-type: none"> <li>Check if the power to computer system is ON.</li> </ul>
Abnormal Picture	Unstable Picture	<ul style="list-style-type: none"> <li>Check if the specification of graphics adapter and monitor is in compliance which may be causing the input signal frequency mismatch.</li> </ul>
	Display is missing, center shift, or too small or too large in display size	<ul style="list-style-type: none"> <li>Using Auto Setup button, if still display abnormal picture then adjust CLOCK, CLOCK-PHASE, H-POSITION and V-POSITION with non-standard signals.</li> </ul>
		<ul style="list-style-type: none"> <li>Using OSD, in case of missing full-screen image, please select other resolution in your Operating System (Windows 95/98, NT) or other vertical refresh timing.</li> </ul>
		<ul style="list-style-type: none"> <li>Must wait for a few seconds after adjusting the size of the image before changing or disconnecting the signal or powering OFF the monitor.</li> </ul>

**SPECIFICATION**

<b>AMVX2408</b>	
LCD Panel	24.0" TFT LCD Panel
Type	Active Matrix
Resolution	1920 x 1200 @ 75Hz
Pixel Pitch	0.27mm
Display Color	16.7M colors
Color Tone	Up to 256 color tone
Response Time	<25ms Typ.
Face Finishing	Protective Filter with Anti-Reflected Hard Coated
Viewing Angle	+/- 85°(Horizontal), +/- 85° (vertical)
<b>Input Signal (Analog &amp; Digital)</b>	
Sync (Analog)	2.5~5.0Vp-p separated sync
Composite Sync (Analog)	Composite Video (NTSC/PAL)
Y/C Sync (Analog)	S-Video (NTSC/PAL)
Input Impedance (Analog)	Video - 75 Ohm Sync - 1k Ohm
Digital	3 channel TMDS receiver, single pixel 24-bit MSB-aligned RGB TFT
<b>Scanning Frequency</b>	
Horizontal	31.47~79.98kHz
Vertical	50~75.3Hz
<b>Display Size</b>	
H x V	20.4" x 12.8" (518.4mm x 324mm)
<b>Brightness, Contrast Ratio, Gray Scales</b>	
Brightness	700 cd/m2 (Typ.)
Contrast Ratio	900:1 (Typ.)
<b>Signal Input Connector</b>	
Video	DVI, HD15, SD/HD-SDI 1 and 2 , Component Y/G, Pb/B, Pr/R, H/CS, VS, C-Video and S-Video
Communication	DB9 (RS232)
<b>Signal Output Connector (Loop Through)</b>	
Video	SD/HD-SDI, Component Y/G, Pb/B, Pr/R, H/CS, VS, C-Video and S-Video
<b>Operating/Storage Environment</b>	
Operating Temperature	32° ~ 90°F (0° - 32°C)
Storage Temperature	-4° ~ 140°F (-20° - 60°C)
Humidity	10 ~ 90%RH (without condensation)
<b>VESA Mounting</b>	
	100mm x 100mm
<b>Power Source</b>	
Display Monitor	DC 24V
AC-Adapter	AC100~240V 120W Max +/-10%
<b>Regulations</b>	
Safety, EMI & Environmental	UL 60601-1, EN60601-1, EN60601-1-2, FCC, CE, CCC, VCCI, ROHS, IP:X1 Compliance
<b>Dimension</b>	
Free Mount	23.54" (W) x 15.07" (H) x 4.39" (D) 598mm (W) x 382.9mm (H) x 111.5mm (D)
<b>Weight</b>	
Free Mount	16.9 lbs (7.66Kg)
<b>Optional Module</b>	
Base Stand	Adjustable high, swivel and tilt base stand

\*\* All contents are subject to change without notice.

	: Direct Current
 <p> <b>MEDICAL EQUIPMENT              WITH RESPECT TO ELECTRIC SHOCK,              FIRE AND MECHANICAL HAZARDS ONLY              IN ACCORDANCE WITH UL 2601-1, AND              CAN/CSA C22.2 NO. 601.1</b> </p>	: UL approval mark according to the safety standard for Medical equipment

This monitor is intended for use in Health Care Facilities model AMVX2408

Equipment is not suitable for use in the presence of flammable anesthetic mixture with air or with oxygen or nitrous oxide.

No user serviceable parts inside, ask qualified personnel when accessing inside.

For disposal of waste product, follow the requirement of local code.

Electrical input rating: 24V DC 6.25A

### Classification

Type of protection against electric shock: Class I Equipment.

Degree of protection against the ingress of water: IPX1 compliance.

Mode of operation: Continuous

This monitor has been tested to comply with IEC/EN 60601-1, IEC/EN60601-1-2 and is certified by UL to medical standard UL60601-1(UL/cUL Mark).

Because many medical offices are located in residential areas, this monitor, in addition to the medical requirements, has also been tested and found to comply with the limits for FCC Class B computing devices in a typically configured system. It is the system integrator or configurer's responsibility to test and ensure that the entire system complies with applicable EMC laws.

Environmental conditions for transport and storage:

- Temperature range within -4° to 140° F (-20° to 60° C)
- Relative humidity range within 10% to 90%
- Atmospheric pressure range within 500 to 1060 hPa.

## Electromagnetic Compatibility

Like other electrical medical equipment, the AMVX2408 requires special precautions to ensure electromagnetic compatibility with other electrical medical devices. To ensure electromagnetic compatibility (EMC), the AMVX2408 must be installed and operated according to the EMC information provided in this manual.

**Note** The AMVX2408 has been designed and tested to comply with IEC 60601-1-2:2001 requirements for EMC with other devices.



**Caution** Portable and mobile RF communications equipment may affect the normal function of the AMVX2408.



**Warning** *Do not use cables or accessories other than those provided with the AMVX2408, as this may result in increased electromagnetic emissions or decreased immunity to such emissions.*



**Warning** *If the AMVX2408 is used adjacent to or stacked with other equipment, observe and verify normal operation of the AMVX2408 in the configuration in which it will be used prior to using it in a surgical procedure. Consult the tables below for guidance in placing the AMVX2408.*

### Manufacturer's declaration - electromagnetic emission

The Model AMVX2408 is intended for use in the electromagnetic environment specified below. The customer or the user of AMVX2408 should assure that it is used in such an environment.		
Emission test	Compliance	Electromagnetic environment - guidance
RF emissions CISPR 11	Group 1	The Model AMVX2408 uses RF energy only for its internal function. Therefore, its RF emissions are very low and are not likely to cause any interference in nearby electronic equipment
RF emissions CISPR 11	Class B	AMVX2408 is suitable for use in all establishments, including domestic establishments and those directly connected to the public low-voltage power supply network that supplies buildings used for domestic purposes
Harmonic emissions IEC61000-3-2	Class D	
Voltage Fluctuations IEC61000-3-3	Complies	

### Manufacturer's declaration - electromagnetic immunity

The Model AMVX2408 is intended for use in the electromagnetic environment specified below. The customer or the user of AMVX2408 should assure that it is used in such an environment.			
Immunity Test	IEC 60601 Test Level	Compliance Level	Electromagnetic environment - guidance
Electrostatic discharge (ESD) IEC61000-4-2	6 kV contact 8 kV air	6 kV contact 8 kV air	Floors should be wood, concrete or ceramic tile. If floors are covered with synthetic material, the relative humidity should be at least 30%.
Electrical fast transient /burst IEC61000-4-4	2 kV for power supply lines 1 kV for input / output lines	2 kV for power supply lines 1 kV for input / output lines	Mains power quality should be that of a typical commercial or hospital environment.
Surge IEC61000-4-5	1 kV differential mode 2 kV common mode	1 kV differential mode 2 kV common mode	Mains power quality should be that of a typical commercial or hospital environment.

Power frequency (50/60Hz) magnetic field IEC 61000-4-8	3.0 A/m	3.0 A/m	Power frequency magnetic fields should be at levels characteristic of a typical location in a typical commercial or hospital environment.
Voltage dips, short interruptions and voltage variations on power supply input lines IEC61000-4-11	<5% Ut (>95% dip in Ut) for 0.5 cycle 40% Ut (60% dip in Ut) for 5 cycles 70% Ut (30% dip in Ut) for 25 cycles <5% Ut (>95% dip in Ut) for 5 sec.	<5% Ut (>95% dip in Ut) for 0.5 cycle 40% Ut (60% dip in Ut) for 5 cycles 70% Ut (30% dip in Ut) for 25 cycles <5% Ut (>95% dip in Ut) for 5 sec.	Mains power quality should be that of a typical commercial or hospital environment. If the user of the AMVX2408 image intensifier requires continued operation during power mains interruptions, it is recommended that the AMVX2408 image intensifier be powered from an uninterruptible power supply or a battery.
<b>Note:</b> Ut is the A.C. mains voltage prior to application of the test level.			

### Manufacturer's declaration - electromagnetic immunity

<p>The Model AMVX2408 is intended for use in the electromagnetic environment specified below. The customer or the user of AMVX2408 should ensure that it is used in such an environment.</p>			
Immunity Test	IEC 60601 Test Level	Compliance Level	Electromagnetic environment - guidance
<p>Conducted RF IEC61000-4-6</p> <p>Radiated RF IEC 61000-4-3</p>	<p>3 Vrms 150 KHz to 80 MHz</p> <p>3 V/m 80MHz to 2.5 GHz</p>	<p>3 Vrms 150 KHz to 80 MHz</p> <p>3 V/m 80MHz to 2.5 GHz</p>	<p>Portable and mobile RF communications equipment should be used no closer to any part of the <b>AMVX2408</b>, including cables, than the recommended separation distance calculated from the equation applicable to the frequency of the transmitter.</p> <p><b>Recommended Separation Distance</b> 0.15 MHz to 80 MHz</p> $d = \left[ \frac{3.5}{V_1} \right] \sqrt{P}$ <p>80 MHz to 300 MHz</p> $d = \left[ \frac{3.5}{E_1} \right] \sqrt{P}$ <p>300 MHz to 2.5 GHz</p> $d = \left[ \frac{7}{E_1} \right] \sqrt{P}$ <p>where <b>P</b> is the maximum output power rating of the transmitter in watts (<b>W</b>) according to the transmitter manufacturer and <b>d</b> is the recommended separation distance in meters (<b>m</b>).</p> <p>Field strengths from fixed RF transmitters, as determined by an electromagnetic site survey (<b>a</b>), should be less than the compliance level in each frequency range (<b>b</b>). Interference may occur in the vicinity of equipment marked with the following symbol:</p> 
NOTE 1: At 80MHz and 800MHz, the higher frequency range applies.			
NOTE 2: These guidelines may not apply in all situations. Electromagnetic propagation is affected by absorption and reflection from structures, objects, and people.			
<p>(a) Field strengths from fixed transmitters, such as base stations for radio (cellular/cordless) telephones and land mobile radios, amateur radio, AM and FM radio broadcast and TV broadcast, cannot be predicted theoretically with accuracy. To assess the electromagnetic environment due to fixed RF transmitters, an electromagnetic site survey should be considered. If the measured field strength in the location in which the AMVX2408 is used exceeds the applicable RF compliance level above, the AMVX2408 should be observed to verify normal operation. If abnormal performance is observed, additional measures may be necessary, such as reorienting or relocating the AMVX2408.</p> <p>(b) Over the frequency range 150kHz to 80MHz, field strengths should be less than [V1] V/m.</p>			

<b>Recommended Separation Distances Between Portable and Mobile RF Communications Equipment and the AMVX2408 System</b>			
<b>The AMVX2408 system is intended for use in an electromagnetic environment in which radiated RF disturbances are controlled. The user of the AMVX2408 system can help prevent electromagnetic interference by maintaining a minimum distance between portable and mobile RF communications equipment (transmitters) and the AMVX2408 system as recommended below, according to the maximum output power of the communications equipment.</b>			
<b>Rated maximum output power (W) of transmitter</b>	<b>Separation distance (m) according to frequency of transmitter</b>		
	150kHz to 80MHz $d=1.17\sqrt{P}$	80MHz to 800MHz $d=1.17\sqrt{P}$	800MHz to 2.5GHz $d=2.33\sqrt{P}$
0.01	0.12	0.12	0.23
0.1	0.37	0.37	0.74
1	1.17	1.17	2.33
10	3.70	3.70	7.37
100	11.70	11.70	23.30
For transmitters rated at a maximum output power not listed above, the recommended separation distance (d) in meters (m) can be estimated using the equation applicable to the frequency of the transmitter, where P is the maximum output power rating of the transmitter in watts (W) according to the transmitter manufacturer.			
NOTE 1: At 80 MHz and 800 MHz, the separation distance for the higher frequency range applies.			
NOTE 2: These guidelines may not apply in all situations. Electromagnetic propagation is affected by absorption and reflection from structures, objects, and people.			

**Dimension Drawing (mm)**

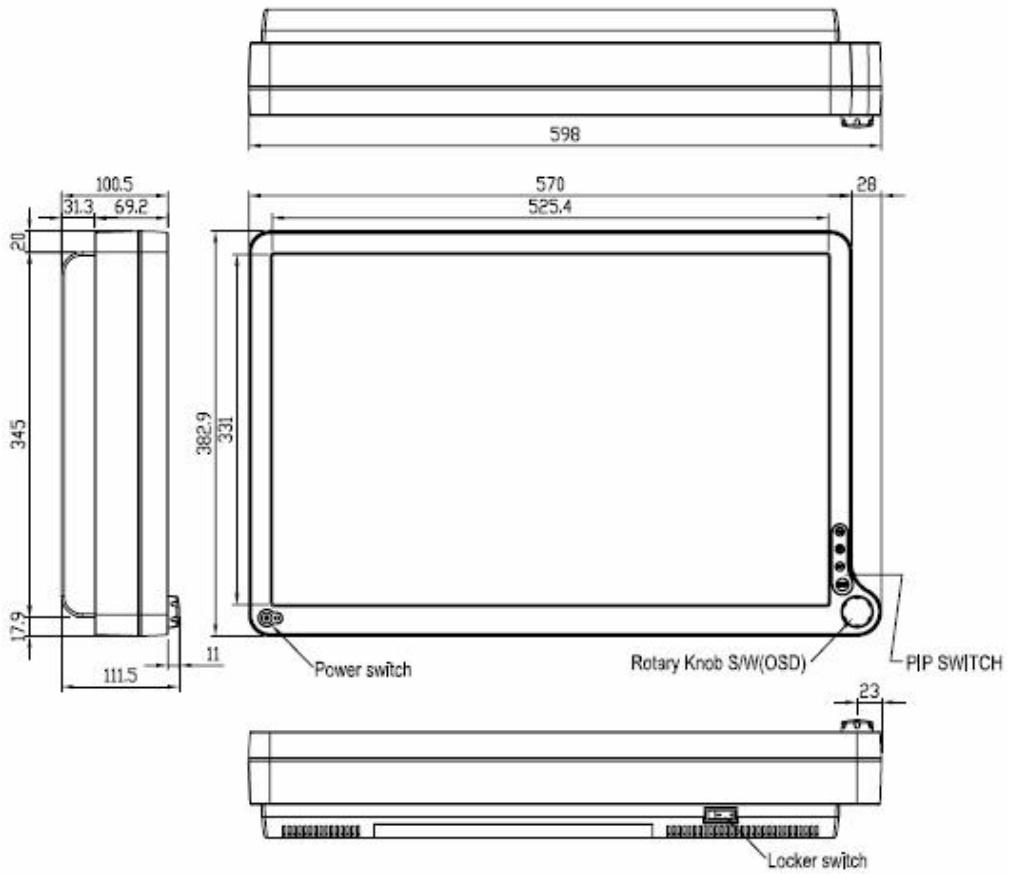



## Connectors

### DC Input

Connector Jack Power Input

Pin	Description	Pin	Description
1	GND	4	NC
2	GND	5	VCC_24V
3	VCC_24V		

### Video Input

24 pin DVI-I connector.

DDWG or equivalent connector.

Pin	Description	Pin	Description	Pin	Description
1	T.M.D.S. Data2-	11	T.M.D.S. Data1 Shield	21	NC
2	T.M.D.S. Data2+	12	NC	22	T.M.D.S. Clock Shield
3	T.M.D.S. Data2 Shield	13	NC	23	T.M.D.S. Clock+
4	NC	14	+5V Power	24	T.M.D.S. Clock-
5	NC	15	Ground (for +5V)	25	Analog Red
6	DDC Clock	16	Hot Plug Detect	26	Analog Green
7	DDC Data	17	T.M.D.S. Data0-	27	Analog Blue
8	Analog V - Sync	18	T.M.D.S. Data0+	28	Analog H - Sync
9	T.M.D.S. Data1-	19	T.M.D.S. Data0 Shield	29	GND(for analog signal)
10	T.M.D.S. Data1+	20	NC		

15 pin VGA connector.

Pin	Description	Pin	Description	Pin	Description
1	GRD	6	GND	11	NC
2	GGREEN	7	GND	12	GSDA
3	GBLUE	8	GND	13	IHS
4	GND	9	GSV	14	IVS
5	GND	10	GND	15	GSCL

S - Video connector.

Pin	Description	Pin	Description
1	GND	3	CHROMA
2	GND	4	LUMA

C - Video connector.

Pin	Description
1	DATA IN / OUT

---



*The trusted name in medical imaging solutions since 1982.*

**Toll Free: 800.400.7972 Tel: 949.273.8000 Fax: 949.273.8023**

**15 Whatney, Irvine California 92618 USA**